WAVETEK

OPERATION MANUAL

MODEL 3SR V9

SYSTEM SWEEP RECEIVER

This document contains information proprietary to Wavetek. The information in this document is not to be used or duplicated in any manner without the prior approval, in writing, of Wavetek.

Wavetek

CATV Division

5808 Churchman Bypass

Indianapolis, IN 46203-6109

(800)851-1198

(317)788-5960

Fax: (317)782-4607

E-Mail: catvsupport@wavetek.com

Internet: <http://www.wavetek.com>

10/97 Rev. A

Manual Part No.

6510-00-0310

Contents

SECTION 1 - GENERAL INFORMATION

1.1 INTRODUCTION	1-1
1.2 SPECIFICATIONS	1-2
1.2.1 Frequency	1-2
1.2.2 Level Measurement	1-2
1.2.3 Hum Measurement	1-3
1.2.4 Carrier to Noise Measurement	1-3
1.2.5 Frequency Response	1-3
1.2.6 Transmitter	1-4
1.2.7 Telemetry	1-4
1.2.8 Spectrum Mode	1-4
1.2.9 Intermodulation Distortion	1-5
1.2.10 Depth of Modulation	1-6
1.2.11 Serial Interface	1-6
1.2.12 General	1-6
1.2.13 Powering	1-6
1.2.14 Standard Accessories	1-7
1.2.15 Options	1-7
1.2.16 Optional Accessories	1-7

SECTION 2 - INSTALLATION

2.1 INTRODUCTION	2-1
2.2 UNPACKING AND INSPECTION	2-1
2.3 WARRANTY INFORMATION	2-1
2.4 POWER REQUIREMENTS	2-1
2.5 CABLE SPECIFICATIONS	2-2
2.6 TECHNICAL SUPPORT	2-4



2.7 Worldwide Sales Offices	2-4
-----------------------------------	-----

SECTION 3 - USER INTERFACE

3.1 INTRODUCTION.....	3-1
3.2 FRONT-PANEL DESCRIPTION	3-1
3.2.1 Soft Keys	3-1
3.2.2 Measurement Mode Selection Keys	3-2
3.2.3 Support Mode Selection Keys	3-3
3.2.4 Arrow Keys	3-4
3.2.5 Alpha-Numeric Entry Keys	3-4
3.2.6 Printing	3-5

SECTION 4 - OPERATION - HOW TO USE THE 3SR RECEIVER

4.1 INTRODUCTION.....	4-1
4.2 STEALTH START-UP PROCEDURE	4-1
4.3 SETUP.....	4-4
4.3.1 General Setup.....	4-4
4.3.2 Measurement Setup.....	4-9
4.3.3 How To Setup Your Channel Plan	4-11
4.3.4 How To Edit Channel Parameters	4-14
4.3.5 Sweep Receiver.....	4-20
4.4 HOW TO PERFORM LEVEL MEASUREMENTS	4-23
4.5 HOW TO MEASURE TILT BALANCING AN AMPLIFIER	4-26
4.6 SCAN MODE	4-27
4.7 HOW TO MEASURE C/N	4-31
4.8 HOW TO MEASURE HUM.....	4-33
4.9 MODULATION	4-35

4.10 SPECTRUM ANALYZER MODE	4-36
4.11 HOW TO PERFORM SWEEP MEASUREMENTS.....	4-41
4.11.1 Introduction	4-41
4.11.2 Operation.....	4-42
4.12 FILE.....	4-45
4.12.1 How to Store/View/Print/Delete Measurement Files	4-45
4.12.2 How to Store/Delete Sweep References.....	4-47
4.12.3 Sweep File Overlay	4-48
4.13 AUTO	4-49
4.13.1 How to Create/Edit/Delete Test Locations	4-50
4.13.2 How to Perform an Auto Test	4-53
4.13.3 Viewing/Printing Auto Test Files	4-62
4.14 STATUS.....	4-69

SECTION 5 - REVERSE SWEEP OPTION

5.1 INTRODUCTION	5-1
5.1.1 Waverack Stealth Reverse Sweep Concept	5-1
5.1.2 Basic Reverse Sweep Procedure	5-2
5.1.3 Interfacing With Different Network Architectures.....	5-3
5.2 REVERSE SWEEP SETUP.....	5-6
5.2.1 Reverse Sweep Insertion Level.....	5-8
5.2.2 Generating a CW Test Signal.....	5-9
5.2.1 Forward Telemetry Frequency (3ST).....	5-11
5.2.2 Forward Telemetry Frequency (3HRV)	5-11
5.2.3 Reverse Sweep Operation (3SRV)	5-11
5.2.4 Select Sweep Direction	5-12
5.2.5 Adjust the Reverse Telemetry Level.....	5-12
5.2.6 Adjust the Reverse Sweep Insertion Level.....	5-12

5.3 INSTALLATION OF REVERSE SWEEP TRANSMITTER 5-13

5.4 FIELD TEST POINT CONSIDERATION 5-15

5.5 INSTALLATION OF 3HRV -- MULTI-USER REVERSE SWEEP TESTING 5-15

5.6 REVERSE INGRESS FEATURE 5-17

5.7 REVERSE SWEEP OPERATION 5-18

- 5.7.1 Sweep Direction Indicator 5-18
- 5.7.2 Changing the Sweep Direction 5-19
- 5.7.3 Reverse Noise Feature 5-19
- 5.7.4 Telemetry Level Indicator 5-19
- 5.7.5 Forward and Reverse Sweep References 5-20
- 5.7.6 Storing and Viewing Sweep Files 5-20
- 5.7.7 Recognizing 3SR in Reverse Sweep Option 5-21

5.8 COMMON PATH DISTORTION (CPD) ANALYSIS 5-22

APPENDIX A: STATUS INDICATORS A-1

APPENDIX B: USER MESSAGES B-1

MODEL 3SR

SECTION 1 GENERAL INFORMATION

1.1 INTRODUCTION

The Wavetek hand-held System Sweep Receiver performs essential cable TV system preventive maintenance tests with accuracy and ease. Signal levels, hum, C/N, and frequency response can be quickly tested without subscriber interference.

The Sweep System is made up of two components: the 3SR Receiver, and 3ST Transmitter. The contents of this manual will describe the care and operation of the 3SR Receiver, including Reverse Sweep option using the 3HRV Headend Reverse Sweep Receiver.

Frequency response is tested by injecting a low level signal in vacant spectrum areas, and monitoring cable system carrier levels in occupied spectrum areas. In addition to generating the sweep test signal, the 3ST Transmitter continuously monitors the system carriers. The 3ST sends headend level readings to the 3SR Receiver with every sweep update. In this way, any headend level changes are compensated by the receiver to maintain the utmost measurement accuracy.

With the Reverse Sweep option, a transmitter is built into the hand-held sweep receiver. The headend sweep transmitter (3ST) is set up to receive the reverse sweep sent from the field. When a reverse sweep is activated from a field test point, the headend transmitter receives the telemetry signal that indicates which receiver is sending the sweep. The headend transmitter measures the sweep, and sends the results, along with the serial number of the sending receiver via its telemetry signal to the field. The field receiver with the tagged serial number then displays the sweep response as measured in the headend on its LCD.

The addition of the 3HRV to the Wavetek Sweep System takes the responsibility of the reverse sweep away from the 3ST. This serves to speed up the reverse sweep rate. In addition, the 3HRV sends out reverse ingress/noise information with every update of its forward telemetry, so reverse telemetry need not be received in order to check the reverse ingress condition. In addition, the 3HRV allows up to 10 users to sweep the reverse path simultaneously.

The 3SR Receiver, in addition to performing its sweep reception duties, conducts a battery of signal level measurements, including a full scan of the cable spectrum to 1 GHz. A proprietary digital signal processing (DSP) technique is used to measure hum and carrier to noise on modulated carriers.

The 3SR Receiver is a full-featured signal analysis meter, with a complete spectrum display and an analog representation of single channel measurement data. When tuned to a specific channel, a comprehensive set of information is provided: tuned channel, video frequency and level, audio frequency and level, the difference between video and audio carrier levels.

The 3SR Receiver is a streamlined, hand-held instrument, that weighs less than five pounds. Its 320 X 240 dot matrix LCD shows measurement data in both graphical and numerical form.

1.2 SPECIFICATIONS

1.2.1 Frequency

Range:	5 to 1,000 MHz
Accuracy:	± 10 ppm at 25°C; ± 10 ppm drift over temp.; ± 3 ppm/year aging
Resolution Bandwidths:	30, 280 kHz (30 kHz for CSO/CTB only)
Tuning Resolution:	10 kHz
Sweep Resolution:	250 kHz maximum

1.2.2 Level Measurement

Range:	-40 to +60 dBmV
Resolution:	0.1 dB
Accuracy:	± 1.0 dB from -20 to +50°C (typical), (relative to 25°C)

1.2.3 Hum Measurement

(carrier ≥ 0 dBmV) Non-scrambled channels only

Range:	0 to 10%
Resolution:	<0.2%
Accuracy:	$\pm 0.7\%$

1.2.4 Carrier to Noise Measurement

Non-scrambled channels only. No preselection required for 78 channels at +10 dBmV input level.

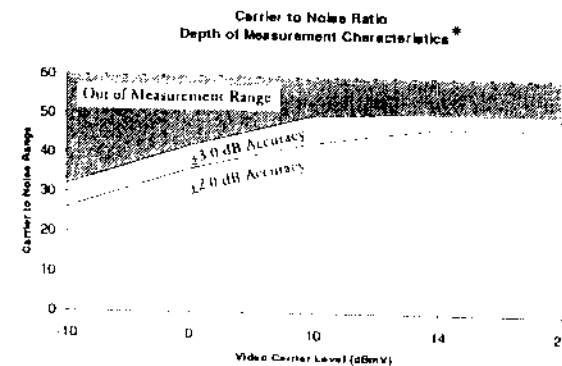

*Typical C/N specifications for a noise measurement offset range of 2 to 3 MHz above video carrier

Range:	50 dB maximum
Resolution:	0.5 dB

1.2.5 Frequency Response

Frequency Range:	5 to 1,000 MHz (Forward or Reverse)
------------------	-------------------------------------

Sweep Rate: \approx 1 second for 600 MHz sweep, no scrambled channels

Accuracy: \pm 0.5 dB, normalized (dependent on stability of referenced carriers)

Display Scaling and Range: 1, 2, 5, and 10 dB/division; 6 vertical divisions

Sweep Scan: User definable from 5 to 1,000 MHz

Reference Storage: At least 16, including Forward, Reverse, or Sweepless

Sweep Trace Storage: At least 50, including Forward, Reverse, or Sweepless

Reverse Option Transmitter Output: +10 to +40 dBmV, settable in 2 dB increments

1.2.6 Transmitter

Frequency Range: 5 to 1,000 MHz

Level Range: +20 to +50^{dB} dBmV; settable in 2 dB increments

Spectral Purity: Hars -30 dBc; Spurs -35 dBc

1.2.7 Telemetry

Frequency: User defined, 5 to 1,000 MHz

Modulation: FSK, 100 kHz deviation

Spectrum Required: \approx 1 MHz recommended

1.2.8 Spectrum Mode

Spans: 3, 5, 10, 20, and 50 MHz (0.3, 0.5, 1, 2, and 5 MHz/div)

Sweep Rates: 1 second (5 MHz)
2 seconds (10, 20 & 50 MHz)

Display Scaling and Range: 0.5, 1, 2, 5, and 10 dB/division; 6 vertical divisions

Spurious Free Dynamic Range: 60 dB (typical specifications)

1.2.8 Intermodulation Distortion

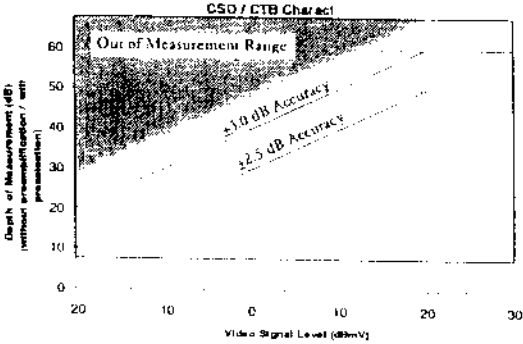

***Typical Specifications**

Range: 60 dB maximum

Resolution: 1 dB

1.2.10 Depth of Modulation

Assumes presence of white reference on any VITS line. Non-scrambled channels only.

Range:	80 to 100%
Resolution:	<0.5% at 85%

1.2.11 Serial Interface

Serial, RS232; Epson, IBM Printers

1.2.12 General

Log Linearity:	± 0.5 dB (typical)
Flatness:	± 0.5 dB @ 25 °C, @ 20 dBmV
Dimensions:	15.2 cm (W) x 25.4 cm (H) x 5.1 cm (D), 6" (W) x 10" (H) x 2" (D)
Weight:	1.95 kg (4.3 lbs.), w/Reverse Sweep Option 2.2 kg (4.9 lbs.)
Operating Temperature Range:	-20 to +50°C; 0 to 122°F, w/Reverse Sweep Option -20 to +47°; -4 to +117°F

1.2.13 Powering

Battery Life:	2.5 hours continuous (absolute worst case), replaceable battery cartridge; w/Reverse Sweep Option 1.75 hours continuous (absolute worst case)
Charge Time:	4 hours fast charge; 30 hours slow charge (with unit operating)

1.2.14 Standard Accessories

Soft Carrying Case
Field replaceable Battery Cartridge
Battery Charger/AC Adapter
(2) "F" type input connectors
Operations Manual

1.2.15 Options

3SRV Reverse Sweep Option (for Model 3SR) - Enables sweep in both forward and reverse directions. Includes DDC-20 summing network interface for separate forward/reverse test points.

16/64 QAM Digital Carrier Power Measurement - Enables Stealth to perform accurate level measurements on digital carriers.

1.2.16 Optional Accessories

1010-00-0342	Citizen PN60 (thermal fusion) Printer
1019-00-0457	Optional Battery for PN60 Printer
3010-59-0009	Citizen PN60 Printer Ribbons (2) (included with printer)
1217-50-0159	Citizen PN60 Printer Cable (included with printer)
1019-00-0437	Charger/Adapter 220VAC to 18 VDC
SBC-1	Charger for one spare Stealth Battery Cartridge
SBC-6	Charger for up to six spare Stealth Battery Cartridges
CBC-1	Cigarette lighter adapter that charges battery in unit - can be used along with SBC-1
1217-50-0151	Stealth Serial Printer Cable
1217-50-0149	Channel Plan Transfer Cable (included with 3ST)
DDC-20	Summing network interface for bidirectional test points (included with 3SRV Option)
PP-75	Precision Preslector for Carrier-To-Noise and Intermodulation Distortion Testing (55 to 440 MHz)
PP-55-110	Tunable Precision Preslector (55 to 110 MHz)
PP-110-220	Tunable Precision Preslector (110 to 220 MHz)

PP-220-440	Tunable Precision Preselector (220 to 440 MHz)
PP-440-880	Tunable Precision Preselector (440 to 880 MHz)
7201	Tunable Precision Preselector (31 to 62 MHz)
7202	Tunable Precision Preselector (62 to 125 MHz)
7203	Tunable Precision Preselector (125 to 250 MHz)
7204	Tunable Precision Preselector (250 to 500 MHz)

¹⁾Specification Change - The transmitter output is being changed from +10 to +40 dBmV to +20 to +50 dBmV. To determine which transmitter output range is available on your unit, access the Status screen by pressing the FCN key followed by the **status** second function key. If "Enhanced Output" is displayed in the options box, the transmitter output range is +20 to +50 dBmV.

SECTION 2 INSTALLATION

2.1 INTRODUCTION

The Wavetek Model 3SR Receiver is a rugged piece of precision test equipment designed for portability. It is well suited for field use.

2.2 UNPACKING AND INSPECTION

The instrument was inspected, and given final operational and quality control tests prior to being carefully packaged for shipment. The unit should operate in accordance with the specifications listed in this manual.

When unpacking the instrument, inspect the shipping container and instrument for shipping damage. If the container is damaged, phone Wavetek immediately. Save the shipping carton and packing materials for possible future use.

FOR CUSTOMER SERVICE call: WAVETEK: (800) 851-1198, International Customers, contact your local Wavetek Representative.

2.3 WARRANTY INFORMATION

The 3SR Receiver is covered by a one year parts and labor warranty (for details, see "Warranty", opposite Table of Contents).

2.4 POWER REQUIREMENTS

The 3SR Receiver operates on a 12 VDC battery. An 18 VDC battery charger (supplied with the unit) fully recharges the batteries in 4 hours (fast charge), 30 hour slow charge (with unit operating). The instrument can operate on batteries or when connected to the desktop charger.

NOTE: The unit is shipped with only a light charge, and will need to be fully charged prior to use.

2.5 CABLE SPECIFICATIONS

There are two cables associated with the operation of the 3SR Receiver; Stealth to Stealth (sent with 3ST Transmitter), and a Serial Printer cable. The following information describes each of the associated cables.

Stealth to Stealth

The Stealth to Stealth cable, (1217-50-0149) provided with each 3ST Transmitter is used for communications between Stealth units and for downloading sweep files to a PC.

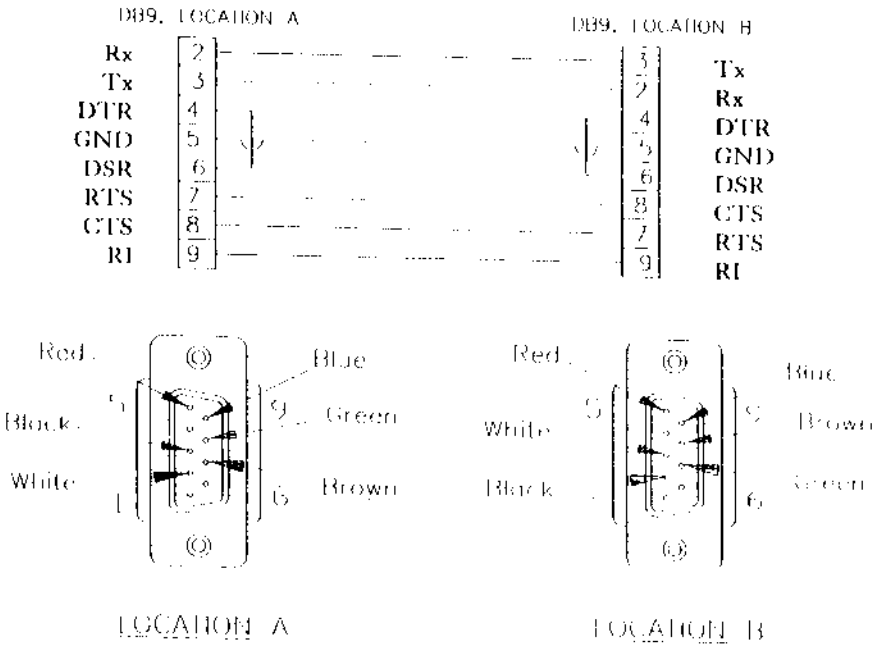

Serial Printer Cable

The Serial Printer Cable, (1217-50-0151) can be used to print data directly from the 3SR Receiver.

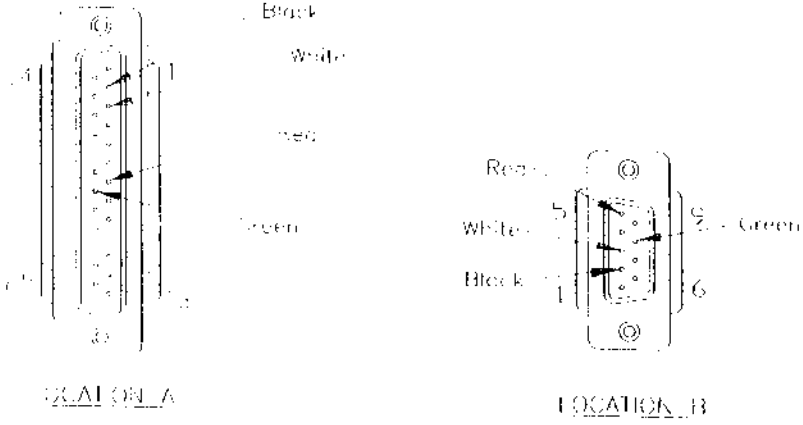
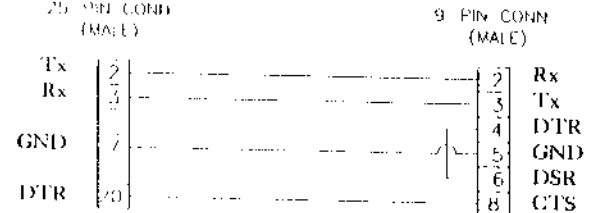

2.6 TECHNICAL SUPPORT

We've worked hard to make the 3SR as easy to-use as possible. If you have a problem using your unit you can contact Wavetek's Technical Support for help. You can reach Wavetek's Technical Support, Monday through Friday between 8 am and 5 pm at (317) 788-5960. Wavetek also maintains a support forum on the Internet. You can leave messages and a Support Specialist will get back to you at Internet address: CATVSUPPORT@wavetek.com, or you can visit our Web Site at <http://www.wavetek.com>.

If you received your Stealth unit and found it to be damaged or incomplete in any way, phone Wavetek immediately. Save the shipping carton and packing material in the event that you have to return it.

FOR CUSTOMER SERVICE call: WAVETEK (800) 851-1198, International Customers, contact your local Wavetek Representative.

The above numbers can also be accessed on your unit by pressing the FCN key followed by the **help** key.

2.7 Worldwide Sales Offices

Austria (Vienna)
Tel: (43) 1-214-5110
Fax: (43) 1-214-5109

China (Beijing)
Tel: (86) 10-592-8044
Fax: (86) 10-500-8199

France (Paris)
Tel: (33) 1-4746-6800
Fax: (33) 1-4746-5656

Germany (Munich)
Tel: (49) 89-996-410
Fax: (49) 89-996-41160

Hong Kong
Tel: (852) 2788 6221
Fax: (852) 2788 6220

Japan (Tokyo)
Tel: (81) 427-57-3444
Fax: (81) 427-57-5722

Singapore
Tel: (65) 356-2522
Fax: (65) 356-2553

United Kingdom (Norwich)
Tel: (44) 1603-404-824
Fax: (44) 1603-483-670

SECTION 3 USER INTERFACE

3.1 INTRODUCTION

This section will help you become familiar with the front-panel controls of the Model 3SR Receiver. Included are descriptions of the front-panel and notes on the use of features.

3.2 FRONT-PANEL DESCRIPTION

The hardware portion of the user interface consists of a 320x240 dot matrix LCD and a 40-key keypad. The keypad includes:

- eight Soft keys
- eight Measurement Mode selection keys
- three Support Mode selection keys
- four Arrow keys
- sixteen Numeric Entry keys
- Power key

3.2.1 Soft Keys

There are a total of eight vertically oriented soft keys, four on either side of the display. The function of each soft key changes depending on the particular operation being performed. The function is indicated on the display next to the associated soft key. Soft keys are not always active. When a soft key is inactive, its indicator is either dimmed (grayed) or does not appear at all.



3.2.2 Measurement Mode Selection Keys

Measurement modes are chosen by pressing the appropriate Measurement Mode Selection key. There is a key for each of the eight major measurement functions. These keys are located directly below the display.

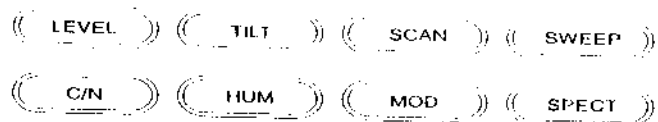

LEVEL: Signal level measurements on individual channels are made by entering a specific channel number and pressing the channel key. Measurements can also be made by selecting the carrier with a marker in the Scan mode and pressing the Level key.

TILT: The Tilt mode simplifies the balancing of pilot levels by displaying a bar graph with a representation of up to nine different user selected video carrier levels.

- SCAN:** Use the Scan mode to get a good look at absolute carrier levels. In this mode a bar graph showing all carrier levels is displayed.
- SWEEP:** Tests frequency response of the cable system by measuring low level signals injected by the 3ST Transmitter in vacant spectrum areas, and monitoring cable system carrier levels in occupied spectrum areas.
- C/N:** Measures the C/N ratio of the tuned channel or frequency.
- HUM:** Measures the hum modulation of the tuned channel in either % or dB as selected by the operator.
- MOD:** Allows the user to listen to the modulation of the tuned channel or frequency and measure Depth of Modulation of a video carrier.
- SPECT:** Provides a Spectrum Analyzer display, and CSO/CTB measurements.

3.2.3 Support Mode Selection Keys

Support modes are accessed using the Support Mode Selection keys. There is a key for each of the three support functions. These keys are located below the Measurement Mode Selection keys and to the left of the Arrow keys.

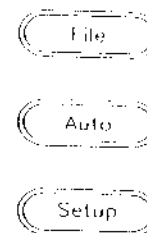

- File:** Allows the user to access measurement and reference files.
- Auto:** This function provides automated FCC 24 hour testing capabilities.

Setup: The setup functions are used to set or adjust the operating parameters of the unit.

3.2.4 Arrow Keys

The four Arrow keys are used for various purposes. Their functions are described in the individual sections for each operating mode. These keys are located below the Measurement Mode Selection keys and to the right of the Support Mode Selection keys.

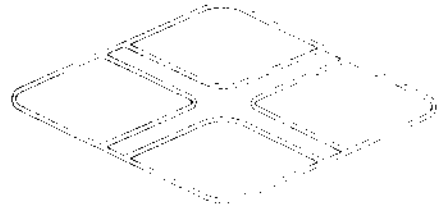

3.2.5 Alpha-Numeric Entry Keys

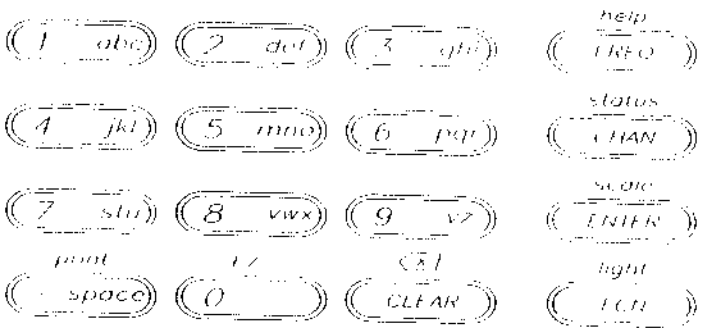

The Alpha-Numeric keys are used to enter data as needed during the operation of the unit. There are three indicators associated with keypad entry. These indicators appear in the title bar to the left of the time. The three are as follows:

Λ - alpha entry mode

- 123 - numeric entry mode
- ⚡ - multiple choice mode

Alpha Entry Mode

Most numeric keys have alphabetic characters printed on them. These characters can be accessed when the alpha entry indicator appears in the title bar. In the alpha entry mode, a cursor appears below the active position. Repeated pressing of an alphanumeric key sequences through the values printed on the key. Once the desired character is selected, the cursor is moved to the next position using the LEFT or RIGHT arrow keys. Special characters are available using the UP and DOWN arrow keys.

Alpha entry must be terminated by pressing the ENTER key.

Numeric Entry Mode

In the numeric entry mode, only the numerals 0 through 9 and the decimal point can be entered. When negative values are allowed, the FCN, +/- key sequence toggles between positive and negative entry. The numeric value may also be incremented and decremented using the UP and DOWN arrow keys.

Numeric entry must be terminated by pressing the ENTER key.

Multiple Choice Mode

This mode allows you to sequence through a series of choices which appear in the edit box.

3.2.6 Printing

Any measurement mode screen can be printed directly. Press the FCN key followed by the second function Print key to print the current measurement screen. To print a measurement file, simply view the file and print it as you would a current measurement screen.

SECTION 4 OPERATION - HOW TO USE THE 3SR RECEIVER

4.1 INTRODUCTION

This section provides detailed operation of the Model 3SR Receiver. Included are detailed descriptions of the various displays of the selected modes of operation.

4.2 STEALTH START-UP PROCEDURE

After the receiver is properly connected, the next step is to build a channel plan to designate which channels are active in the system, which channels are scrambled, and which channels are inactive. The channel plan can be edited to indicate which channels are to be tested in the Tilt mode, and to label the channels with the programming content or call letters of the broadcaster.

The following describes the steps to prepare the receiver for use.

Building A Channel Plan

Password

To prevent unintentional editing, a password may be implemented. The password feature is enabled in the General Setup mode under the menu item *Edit Channel Password*. The instrument defaults to "Password Disabled" mode. The factory default password is ---- (Blank or Null). This is the password that will be active if the operator chooses the mode but not edit the password. The default password will be applied after the unit firmware is upgraded.

The operator may enter a new alpha-numeric password consisting of not more than nine characters. In case the password is forgotten or lost, proceed as follows to generate an "Emergency Password": The serial number of the unit consists of seven digits. Switch digits 5, 6, 7 with digits 1, 2, 3. Keep the position of the 4th digit unchanged. Example: Suppose, your unit serial number is 1234567. The password becomes 5674123. If you still have problems, please call the Wavetek Technical Support at (317) 788-5960.

1. To build a channel plan, first enter the setup mode by pressing the **SETUP** key.
2. Press the Channel Plan soft key, and cursor down the menu to **Build Channel Plan**.
3. Press the **ENTER** key, and you will be prompted at the first step to name the channel plan to be built. The name should be a logical one that will be easy to remember. The location of the headend is usually a good name for the channel plan. When the name is typed in, press the **OK** soft key.
4. The next step is to choose a channel plan from the built-in list that most closely resembles the plan of your system. Typically your system channel plan will be a subset of the built-in plan. Cursor down to the appropriate channel plan and press the **ENTER** key or the **OK** soft key.
5. You will then be prompted to enter the highest frequency that you would like to scan. Type in the frequency and press the **ENTER** key followed by the **OK** soft key. The unit will then commence a scan for the presence of channels. After the scan is done, this phase of the channel plan building process is complete. Press the **OK** soft key to return to the Channel Plan menu.
6. **Enable Tilt Channels.** You can enable the Tilt channels for the first and last active channels. The Tilt channel is used to determine the maximum tilt level in setting the input attenuation.

Note: If you are using the Stealth Sweep System to sweep a "system" that has **NO** active channels, there are a few things you need to be aware of.

1. When you "build a channel plan" the Stealth unit will always make one channel active, even if there is no channels on the system. This may create some confusion. If you use a channel plan that has a non active channel enabled, it will cause your sweep display to have erratic readings. But, only at the channel that is "enabled". This will in turn cause your MAX/MIN to fluctuate. You can solve this problem two ways. Either disable the enabled channel, in "edit channel parameters". Or, make an active channel "outside" of the bandwidth you are wanting to test. Both of these are acceptable solutions.

2. Keep in mind, if you choose to "disable" the "enabled" channel, and do not enable another channel outside of the "test bandwidth", you will not be able to "copy" this plan to another unit. The unit you are trying to copy to will give you an "error message": "This plan is corrupted and cannot be used!". This message occurs because the unit needs to see an enabled channel in the channel plan to copy it.

Editing A Channel Plan

The next step is to edit the channel plan to characterize it for your particular system. Cursor down to **Edit Channel Parameters** and press **ENTER**. A listing of all the channels within the frequency range designated in the Build Channel Plan phase will appear on the screen. Notice that there are columns for enabled, channel type, channel number, label, frequency (video carrier), sweep, scrambled, tilt, and scrambled.

The parameters for each channel may be edited by cursoring to the channel to be edited and pressing the **Edit** soft key.

Check the listed channels to ensure that channels that you know are not video are not listed as video channels. If during the Build Channel Plan phase the receiver detects a signal at a video carrier frequency it assumes it is a video channel. Some FM carriers may happen to fall at video carrier frequencies for channels 95-97. Be sure these channels are properly designated as video or single carriers. FM signals may be entered as channels, but must be designated as Single Carriers.

At this time be sure to edit each scrambled channel to ensure that it is designated appropriately. A special algorithm is used to ensure that the peak of these signals is measured.

At this time you may also wish to designate tilt channels, and label the channels with call letters, but this is not essential to begin using the 3SR Receiver.

4.3 SETUP

There are four setup modes for the 3SR Receiver; General, Measurements, Channel Plan, and Sweep Receiver. General setup allows the operator to configure general aspects of the unit (not specifically related to measurements) for personal taste. Measurements setup permits the operator to setup certain parameters that apply to specific measurements. Channel Plan setup allows the operator to configure channel tuning to match the specific characteristics of an individual cable system. Sweep Receiver setup lets the operator setup sweep measurement parameters.

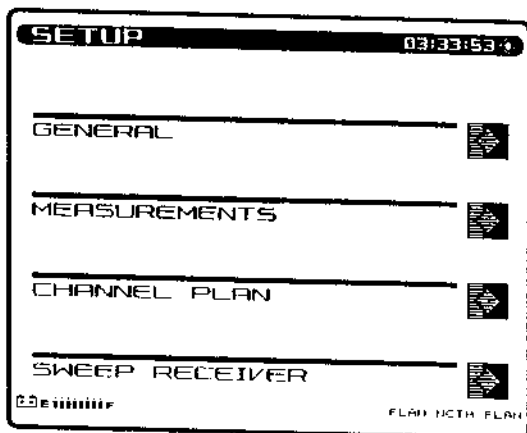

4.3.1 General Setup

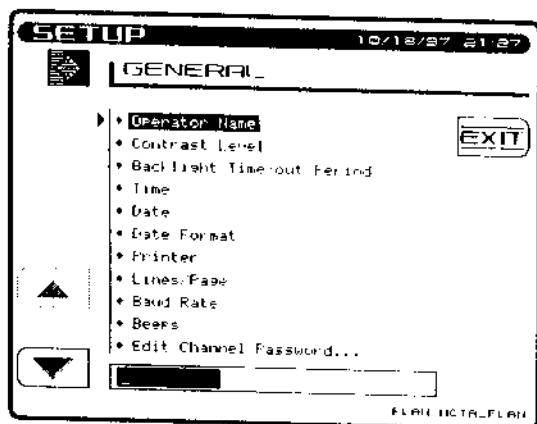

Use the **Up** and **Down** soft keys to scroll to additional setup items. When lists are being displayed, the up arrow soft key dims when the first item in the list is reached and the down arrow soft key dims upon reaching the last item.

Operator Name

Allows the user to enter the operators name. The name will appear in the header section of the Auto Test report.

Contrast Level

Adjusts the contrast level of the LCD for optimum viewing by the operator. The level is varied on a scale from 1-15. Use the **UP** and **DOWN** arrow keys to adjust the contrast.

Shut-off Time-out Period

In order to conserve battery life, an automatic shut-off feature turns off the unit when it has remained inactive for a period of time. The time out period is programmable to; 1 min, 3 min, 5 min, or always on. The unit can be manually turned off at any time by pressing the **Power** key. Use the **UP** and **DOWN** arrow keys to set the time-out period.

Backlight Time-out Period

An additional means of conserving battery life is an automatic Backlight Time-out. The time out period is programmable to; always off, 5 sec, 10 sec, or always on. Use the **UP** and **DOWN** arrow keys to set the time-out period. The Backlight can be manually turned on/off at any time by pressing the **Function** key followed by the **Light** second function key.

Time

Use the numeric entry keys to enter the time in the HH:MM:SS format (24 hour).

Date

Use the numeric entry keys to enter the date. The date will be displayed in the format chosen in the Date Format setup menu.

Date Format

Use the **UP** and **DOWN** arrow keys to select the desired date format. When the date format is changed, the new format will appear everywhere the date is displayed or printed. The following date formats are available:

- MM/DD/YY
- DD.MM.YY
- YY.MM.DD

Printer

Sets the printer interface to the specific type of printer used. Use the **UP** and **DOWN** arrow keys to select the desired printer. The required serial printer configuration is as follows:

- baud rate consistent with 3SR Receiver (recommend 9600 or 19.2K)
- 8 data bits
- 1 stop bit
- no parity
- flow control - hardware handshaking

A serial to parallel converter (such as the one manufactured by Black Box Corp. (Phone: 412-746-5500) is required for printing to a parallel printer. The setup is the same as the serial printer configuration.

Lines/Page

The number of Lines/Page (min 30, max 255) can be specified for text printouts. This determines the number of lines that are printed before a form feed command is sent. If no form feeds are desired, enter zero for the Lines/Page.

Baud Rate

The Baud rate is used when establishing communications between the 3SR Receiver and another device. The Baud rates available are; 1200, 2400, 4800, 9600, and 19.2k. The **UP** and **DOWN** arrow keys are used to set the Baud rate.

Beeps

The 3SR Receiver produces beeps to alert you of certain operating conditions.

The arrow keys are used to turn Beeps on or off as desired.

Edit Channel Password

Used for entering the alpha-numerical Password. See Building a Channel Plan, page 4-1, for information..

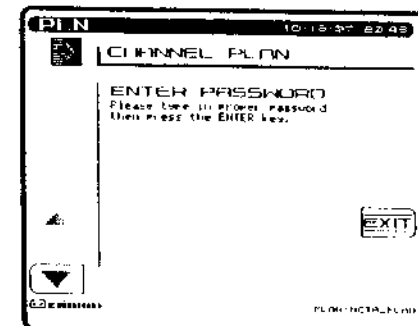
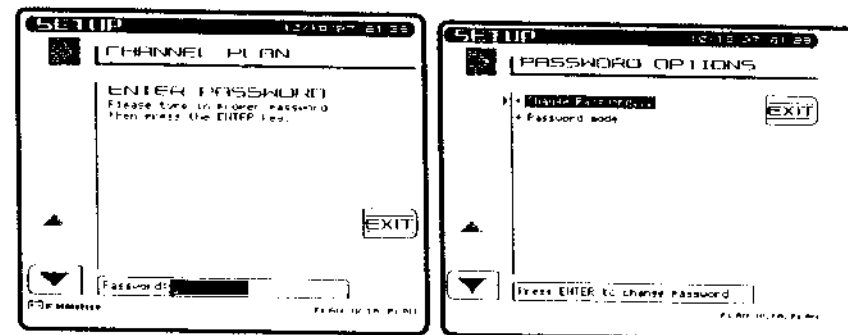

Diagnostics

Note: If the Diagnostics selection does not appear on the screen, keep pressing the Down arrow soft key until it scrolls onto the list.

Press the **ENTER** key to enter the diagnostic mode. The diagnostic mode allows the user to perform the following functions:

Default to Factory Settings

When this item is selected and the **ENTER** key is pressed, the unit will automatically set all parameters to the factory default values.

Warning: All files and references will be lost when resetting the unit to factory default settings.

Display Test

Allows the user to test the operation of the display. Press the **ENTER** key to begin the display test. Follow the instructions displayed while performing the test.

Transmitter Diagnostics

Press the **ENTER** key to access the following Transmitter Diagnostic features:

- Transmitter On/Off - When turned on, provides a CW RF signal that can be used as a troubleshooting, or installation aid. The signal is only present when the diagnostic screen is displayed.
- Transmitter Attenuator - Use the **UP** and **DOWN** arrow keys to enter the amount of attenuation for the CW transmitted signal.
- Transmitter Frequency - Enter the frequency for the transmitted signal.

Warning: Subscriber interference could result, if the frequency is set to a local carrier frequency.

- Sweep Telemetry On/Off - When turned on, will modulate the CW signal similar to the telemetry signal.

4.3.2 Measurements Setup

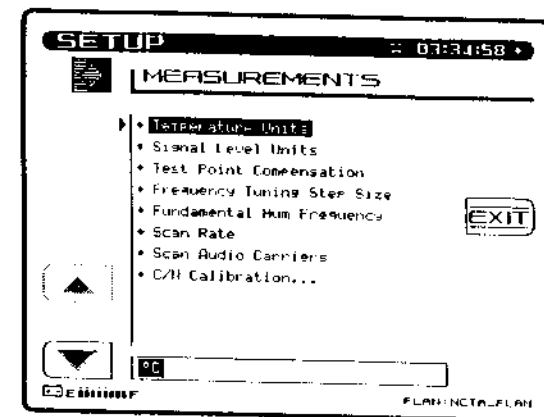

Temperature Unit

Use the **UP** and **DOWN** arrow keys to select the desired temperature units (°C, °F).

Signal Level Units

Use the **UP** and **DOWN** arrow keys to select the desired level units

(dBmV, dB μ V, dBm).

Test Point Compensation

Test Point Compensation is used to account for losses associated with certain amplifiers. Use the **UP** and **DOWN** arrow keys or the numeric entry keys to enter the Test Point Compensation. (-100.0 to +100.0 dB in 0.1 dB steps).

Note: Pressing the FCN and 7th keys will take the user to the Test Point Compensation screen. Pressing the FCN and 1st keys takes the user to the measurement mode.

Frequency Tuning Step Size

The Tuning Step Size can be adjusted using the **UP** and **DOWN** arrow keys or the numeric entry keys (0.01 to 100.00 MHz in 10 kHz steps).

Fundamental Hum Frequency

The fundamental hum frequency to be measured can be selected using the **UP** and **DOWN** arrow keys (60 Hz, 50 Hz, Auto). When Auto is selected the unit will automatically switch to 50 Hz on PAL type plans and 60 Hz for NTSC plans.

Scan Rate

Two scan rates are available in the Scan mode, normal and fast. The scan rate is selected using the **UP** and **DOWN** arrow keys. The Fast scan feature allows for rapid scan displays, while sacrificing accuracy. Normal scan rate is slower, but more accurate.

Scan Audio Carriers

If desired, the audio carriers can be omitted resulting in a faster scan. This feature is selected using the **UP** and **DOWN** arrow keys (yes, no).

C/N Calibration

To increase the accuracy of the C/N measurements, a noise floor calibration is performed. This allows the user to characterize the noise floor of the unit. To perform the calibration, highlight the selection and press the **ENTER** key. The unit will provide a prompt to ensure that no cable is connected to the RF input. Once verified, press the **OK** soft key to perform the calibration. The unit will display the system noise level when the calibration is complete.

4.3.3 How To Setup Your Channel Plan

The procedure explained in Section 4.2 should be performed when first using the Model 3SR Receiver.

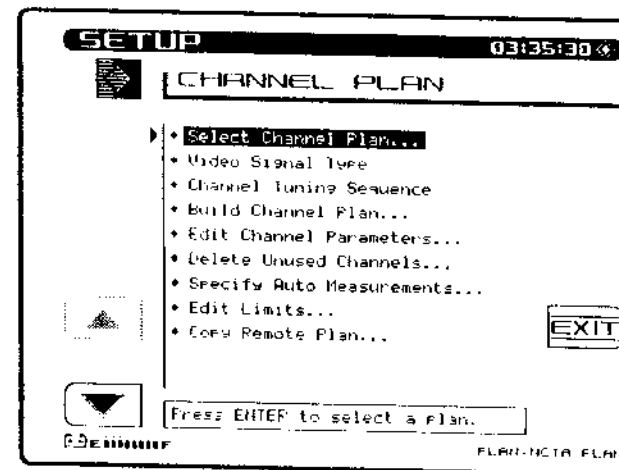

Select Channel Plan

Press the **ENTER** key to call up a list of existing channel plans. If the unit is being used for the first time, the only Channel Plan available will be the standard NCTA plan. Refer to the "Build Channel Plan" section to create a channel plan that matches your system. Use the **Up** and **Down** arrow soft keys to scroll through the list. When the desired channel plan is highlighted, press the **Exit** soft key to activate the selected channel plan. Channel plans can also be deleted from the list using the **Delete** soft key. An **OK** and **Stop** soft key is then displayed to confirm or stop the deletion of the channel plan.

The currently active channel plan (as indicated in the lower right hand corner of the screen) cannot be deleted. To delete this plan, first select a different plan by using the arrow keys to highlight another plan and then press the **Load** soft key. The previously active channel plan can now be deleted.

Press the **Info** soft key to view the following channel plan information:

- Plan name
- The Channel Plan that the plan was based on
- The number of enabled channels
- Date the plan was last modified
- Limits
- Video Signal Type

Video Signal Type

The type of video signal to be measured can be selected using the **UP** and **DOWN** arrow keys (NTSC, PAL.)

Channel Tuning Sequence

Use the **UP** and **DOWN** arrow keys to select either numeric order or frequency order, for the channel tuning sequence.

Build Channel Plan

Password

To prevent unintentional editing, a password may be implemented. The password feature is enabled in the General Setup mode under the menu item *Edit Channel Password*. The instrument defaults to "Password Disabled" mode. The factory default password is ---- (Blank or Null). This is the password that will be active if the operator chooses the mode but not edit the password. The default password will be applied after the unit firmware is upgraded.

The operator may enter a new alpha-numeric password consisting of not more than nine characters. In case the password is forgotten or lost, proceed as follows to generate an "Emergency Password": The serial number of the unit consists of seven digits. Switch digits 5, 6, 7 with digits 1, 2, 3. Keep the position of the 4th digit unchanged. Example: Suppose, your unit serial number is 1234567. The password becomes 5674123. If you still have problems, please call the Wavetek Technical Support at (317) 788-5960.

Press the **ENTER** key to begin the Build Channel Plan sequence. This sequence allows the user to create a channel plan by "learning" the channels on a cable system.

NOTE: Ensure that the Stealth 3SR is connected to the cable system.

Step 1: Enter a name for the new channel plan that will be built.

Use the alphanumeric keypad to enter a channel plan name. Press the **OK** soft key when completed.

Step 2: Select a fixed channel plan to use for building the new plan.

Use the **UP** and **DOWN** arrow keys to select a fixed channel plan to build the new plan from. Press the **OK** soft key when completed.

Step 3: Enter the frequency at which to stop searching for channels. Press the **ENTER** key followed by the **OK** soft key to set the stop frequency.

The 3SR Receiver will sequence through all channels in the selected fixed plan until the stop frequency is reached. This operation can be terminated by pressing the **STOP** soft key. When completed, individual channels contained in the newly built plan can be edited.

NOTE: Some channel plans have interlaced channels. To prevent interference, delete interlaced channels prior to building sweep points.

4.3.4 How To Edit Channel Parameters

This setup feature allows the user to edit existing channel parameters. Press the **ENTER** key to initiate channel parameter editing.

A list of all channels contained within the active plan is presented.

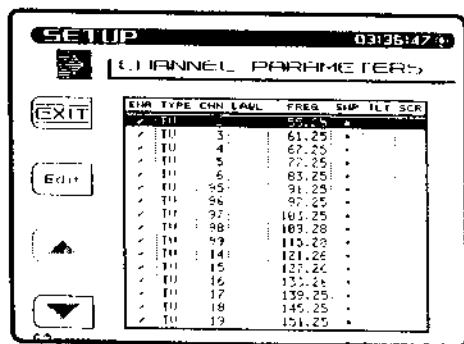

Use the **Up** or **Down** arrow soft keys to select the channel that you wish to edit.

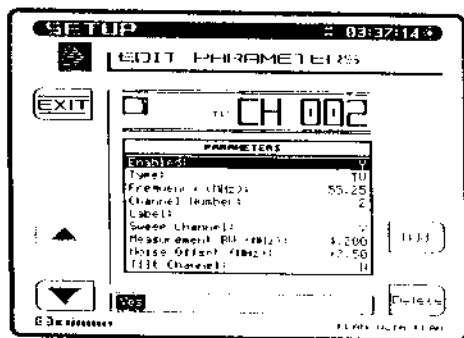

Press the **Edit** soft key to view and edit the following parameters:

Note: If the parameter that you wish to edit does not appear on the screen, keep pressing the arrow soft key to scroll through the list.

Enabled

Y/N - If the channel is not enabled it will not be included in any measurement mode. At least one channel must be enabled.

Channel Type

TV - Includes standard video carrier with audio carrier offset.

DUAL - European system which incorporates video plus two independent audio carriers.

Single Carrier - Can be used for an FM or data carrier.

Digital Carrier - (Optional) Can be used for 16/64 QAM digital carrier power measurement. Only supported in the Level, Sweep, and Spectrum measurement modes. An RMS detection mode is used when measuring the level of a digital channel.

Frequency

The frequency of the carrier (for TV and DUAL types, this is the frequency of the video carrier) Enter frequency by using the numeric entry keys or the arrow keys.

Channel Number

The channel number of the carrier. Enter channel number by using the numeric entry keys or the arrow keys.

Label

The label is provided to associate a channel's number with it's programming. Using the alpha keys, label the channel with a desired name (up to four characters). "Special" characters can be selected using the up/down arrow keys. The label will appear to the left of the channel number on most screens.

Sweep Channel

Y/N - Designates that the channel will be used for Sweep measurements.

Measurement Bandwidth Adjustments

To edit the bandwidth, cursor to the **Measurement BW** selection. The bandwidth can be adjusted by using the **UP** and **DOWN** arrow keys or by entering a value using the numeric keypad and then pressing the **ENTER** key. The FCC specification for C/N measurements is a bandwidth of 4.00 MHz. CATV organizations outside of the United States may have different requirements.

Noise Offset Frequency Adjustments

The frequency at which the noise level is measured is the Carrier frequency plus the noise offset. To adjust the noise offset, cursor to the **Noise Offset** selection. The offset can be adjusted by using the **UP** and **DOWN** arrow keys or by entering a value using the numeric keypad and then pressing the **ENTER** key.

Tilt Channel

Y/N - Designates which channels are used for the Tilt mode. Up to nine channels can be designated as Tilt channels.

Scrambled

Y/N - Select Yes if the channel is scrambled. When a channel is designated as scrambled, the sweep will only look at the video carrier as a sweep reference, instead of both the video and audio carrier. Note: a diamond will appear to the left of the channel type indicator on most screens.

Audio Offset

Specifies the audio offset of the channel.

Audio Offset 2

Specifies the offset for the second audio carrier of a Dual type channel.

An **ADD** and **DELETE** soft key allows for adding new channels to the plan or deleting existing channels from the plan.

Press the **Exit** soft key to return to the Channel Parameters display.

Delete Unused Channels

Once the channel plan has been built, unused channels can be deleted if desired. Doing this frees memory for other uses and "unclutters" the channel plan. Select the Delete Unused Channels in the Channel Plan menu and press **ENTER**.

Specify Auto Measurements

Press the **ENTER** key to specify the measurements to be taken during the performance of an Auto Test. This feature allows the user to specify which channels, C/N, Hum, and Modulation measurements are made on.

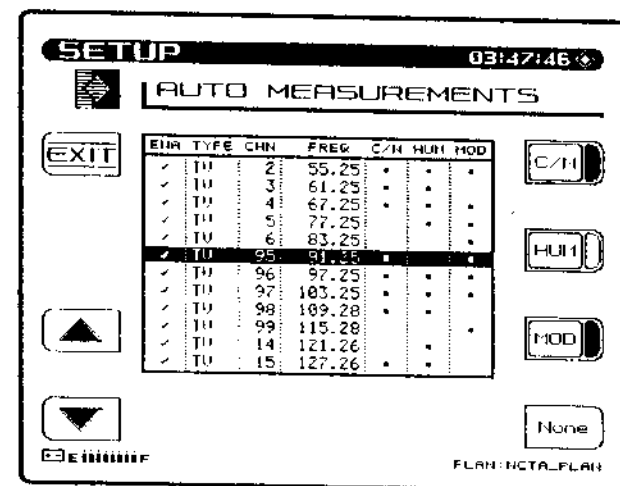

Use the **Up** and **Down** arrow soft keys to cursor to a channel. Use the **C/N**, **HUM**, and **MOD** soft keys to select the desired Auto Test measurements.

Note: **C/N**, **Hum**, and **Modulation** cannot be measured on a scrambled channel or a sweep point. **Hum** and **Modulation** cannot be measured on a Digital type carrier also.

Use the **All/None** soft key to quickly select or deselect Auto Test measurements. If a test is selected, the **None** soft key is displayed. If no tests are selected for a particular channel, then the **All** soft key is displayed.

Note: **Hum** measurements include all components < 1 kHz.

Note: **Hum** will be measured in either % or dB depending on what was selected in **Hum** mode prior to performing the Auto Test. The units cannot be changed once the Auto Test has been performed.

Edit Limits

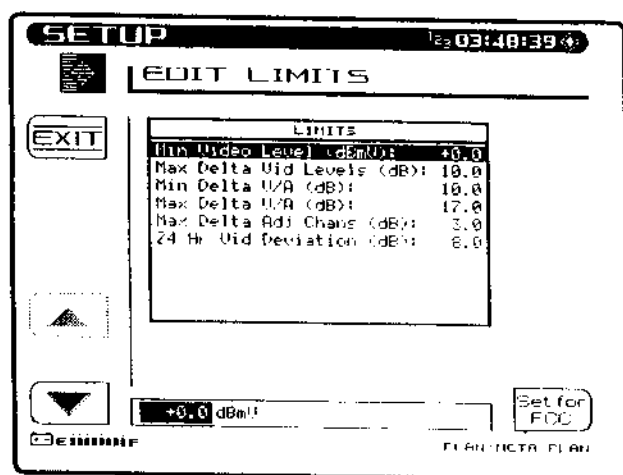

The Edit Limits function works in conjunction with the performance of an Auto Test. As the Auto Test measurements are made, the values are compared to the above limits. Use the **Up** and **Down** arrow soft keys to select the limit to be edited. Use the numeric entry keys or the **UP** and **DOWN** arrow keys to enter a value. Once the value has been entered, press the **ENTER** key to update the display. The Set for FCC soft key can be used to automatically set the limits for FCC specified values.

Copy Remote Plan

This selection allows you to copy a channel plan from one unit to another.

Connect a cable between the serial ports of two units. Ensure that the baud rate is set the same for each unit (General Setup screen). A baud rate of 19.2K is recommended for copying plans.

Select **Copy Remote Plan** from the menu and press the **ENTER** key. A list of plans located in the remote units memory will appear. Select the plan that you want to copy and press the **Copy** soft key. The selected plan will be transferred from the remote unit and stored in the unit that you are operating. It will also become the active plan.

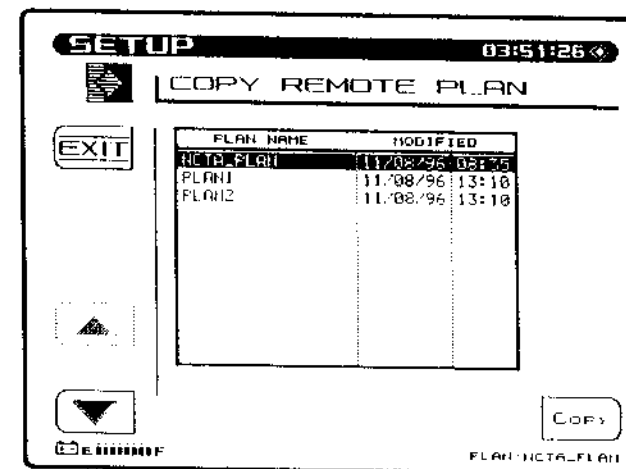

4.3.5 Sweep Receiver

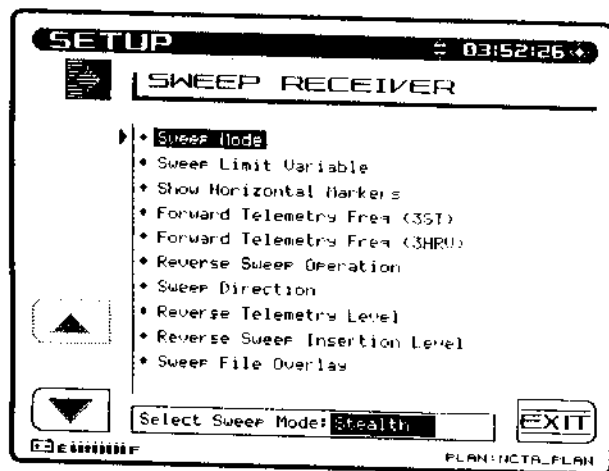

Sweep Mode

Use the **UP** and **DOWN** arrow keys to select the desired sweep mode.

Sweep Limit Variable

The sweep limit variable is used during sweep measurements to show the operator how the response relates to the $(n/10 + x)$ flatness formula. The "x" in the equation is the sweep limit variable. This value is adjustable from 0.0 to 5.0 (default 1.0). Use the **UP** and **DOWN** arrow keys or the numeric entry keys to enter a value.

Show Horizontal Markers

Use the **UP** and **DOWN** arrow keys to display the horizontal markers. The horizontal markers continuously track the maximum and minimum values in the area of the graph between the vertical markers.

Forward Telemetry Frequency (3ST)

Use the **UP** and **DOWN** arrow keys or the numeric keypad to enter the forward telemetry frequency corresponding to the 3ST.

NOTE: For successful Stealth mode operation, the Rx telemetry frequency must match the Tx telemetry frequency setting of the Model 3ST Transmitter.

Caution: Do not place the telemetry signal too close to the duplex filter cut-off frequency in that roll-off may attenuate the telemetry signal to the degree that communication fails. This same caution applies to placing the signal in the high end roll-off region.

Forward Telemetry Frequency (3HRV)

Use the **UP** and **DOWN** arrow keys or the numeric keypad to enter the forward telemetry frequency corresponding to the 3HRV.

NOTE: For successful operation, the 3SRV telemetry frequency must match the forward telemetry frequency setting of the Model 3HRV.

Important: To prevent the 3HRV reverse sweep from contending with the 3ST, disable the 3ST's reverse sweep. This will speed up the 3ST's forward sweep. Multi-user contention can also be eliminated by offsetting reverse channel plans, and by using different telemetry frequencies.

Reverse Sweep Operation (3SRV Models in Stealth mode only)

Select "Single User" for reverse operations associated with a 3ST.
Select "Multiple Users" for reverse operations associated with a 3HRV. In Multi user reverse mode the remote Stealth will display the reverse noise (or ingress at the headSweep Direction (3SRV Models in Stealth mode only)

Sweep Direction (3SRV Models in Stealth mode only)

There are two possible sweep directions on units with the Reverse Sweep Option; Forward and Reverse. Use the edit box to select the desired direction, and press the ENTER key.

Note: When sweeping the direction may be changed by simply pressing the left arrow key for reverse, or the right arrow key for forward sweeping.

Reverse Telemetry Level (3SRV Models in Stealth mode only)

This is the level of the carrier that the 3SR uses to transmit telemetry data. Use the edit box to set the Reverse Telemetry Level to an appropriate value. When adjusting the Reverse Telemetry Level, take into consideration the following losses; system, summing network, test point, and amplifier desired input.

NOTE: The frequency of the reverse telemetry carrier is set on the 3ST/3HRV. There is no adjustment for the Reverse Telemetry Frequency on the 3SR.

Reverse Sweep Insertion Level (3SRV Models in Stealth mode only)

This is the level at which the 3SR inserts (transmits) sweep points. All sweep points are inserted at the same level. Use the edit box to set the Reverse Sweep Insertion Level to an appropriate value. (This will typically be at maximum (+50 dBmV) to overcome test point loss.)

NOTE: The frequencies at which the sweep points are inserted are defined in the Reverse Sweep Plan which is set on the 3ST/3HRV. The frequency of the sweep points cannot be adjusted on the 3SR.

Sweep File Overlay

Sweep file overlay allows a stored sweep response to be viewed simultaneously with the "live" sweep response for direct comparison. The Sweep File Overlay option must be enabled to view both traces simultaneously. With this option disabled, stored files will be displayed for normal viewing without the live response superimposed. If the Sweep File Overlay option is enabled, the live response will overlay the stored response when viewing the sweep file. Use the UP and DOWN arrow keys to enable the option.

Include Audio Carriers (Sweepless Mode Only)

This selection allows the audio carriers to be excluded resulting in a faster sweep. Use the UP and DOWN arrow keys to include (Yes) or exclude (No) audio carriers.

4.4 HOW TO PERFORM LEVEL MEASUREMENTS

Signal levels are measured in the Level and Scan Modes. The Level mode display provides both a numeric indication of signal level and an analog meter. The audio and video carrier levels of a channel are displayed simultaneously. Alternately, an individual carrier can be measured (as in the case for a data or pilot carrier) or the unit can be tuned to a specific frequency.

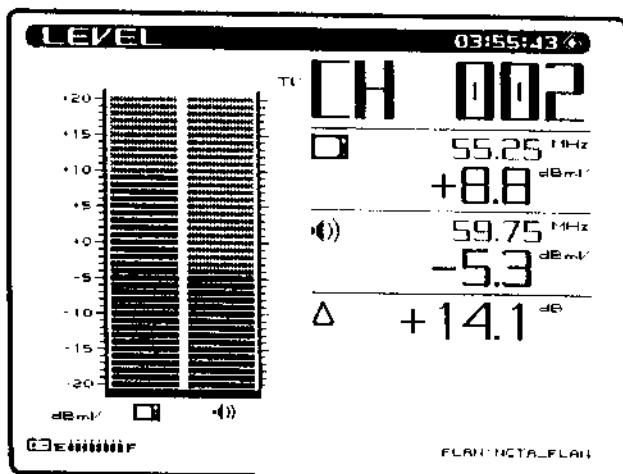

Information displayed in the Level mode is as follows:

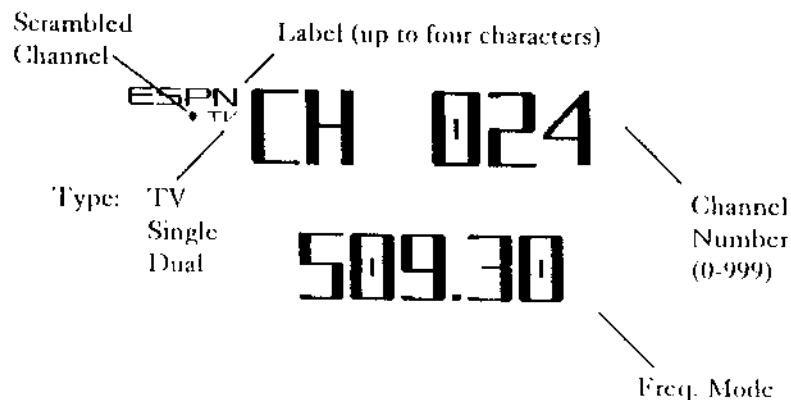

- Channel number or frequency
- Channel label
- Video carrier frequency and level (numerical)
- Audio carrier frequency and level (numerical)
- Analog meter of carrier levels
- Delta between audio and video levels
- Selected channel plan
- Battery status

- Test point compensation (appears only if a nonzero value is programmed during setup) - used to eliminate the test point loss or probe loss from the measurement result to show the signal level "on the system".

Tuning by Channel or Frequency

When the level mode is selected the unit can be tuned by channel or frequency. When in the channel mode, the channel and channel label will appear at the top of the display. The left and right arrow keys can be used to decrement and increment the channels. Channels can also be entered using the numeric keys followed by the **CHAN** key.

To tune by frequency, use the numeric keys to enter a frequency followed by the **FREQ** key. The frequency can then be decremented by using the left key or incremented using the right arrow keys. The step size when tuning by frequency is programmed during setup.

Scale Adjustment

The **UP** and **DOWN** arrow keys can be used to adjust the reference level on the analog meter. This is helpful when the audio and video levels differ by large amounts.

To automatically scale the analog meter, press the **Function** key followed by the **Scale** second function key.

When in the TV channel mode, the level is represented using dual analog meters; one for the video carrier and one for the audio carrier (two in the video + dual audio channels mode).

When in the frequency mode or single channel mode, the level is indicated by a single meter.

4.5 HOW TO MEASURE TILT - BALANCING AN AMPLIFIER

A cable system is designed for unity gain, and the output of each like type of amplifier (trunk, bridge/line extender) output should be as close to identical as physically possible. The amplifiers are set up with specified levels for signals at the high and low end of the spectrum that are used for Automatic Gain Control (AGC) or Automatic Slope Control (ASC). In the amplifier balancing process, these signals are measured and adjusted to specification. Before making an adjustment, ensure that there are no problems in the system that should not be compensated with an adjustment but repaired instead.

To balance the amplifier, ensure that the AGC and ASC is switched off. Tilt mode simplifies the actual balancing by displaying a bar graph with a representation of up to nine different user selected video carrier levels. Adjust the high pilot level to the specified level using the gain control. The gain control tends to affect the overall amplitude throughout the spectrum equally. Adjust the low pilot level to the specified level using the slope control. The slope control affects the low end of the spectrum more than the high end. Due to the interaction between the two controls, repeat this process until the pilots are "balanced". Then switch on the AGC and ASC, wait a moment to measure the signal levels with the AGC and ASC activated.

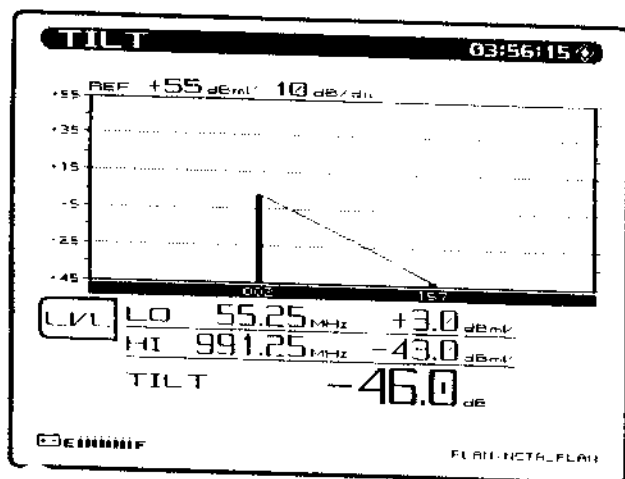

Information displayed in the Tilt mode is as follows :

- High and low carrier frequencies
- High and low carrier levels
- Tilt measurement
- Reference level and scale
- Selected channel plan
- Battery status
- Test point compensation (appears only if a nonzero value is programmed during setup)

When the **TILT** key is pressed the screen will automatically display up to nine video carrier levels that were defined in the Edit Channel Parameters portion of the Channel Plan Setup menu.

The **UP** and **DOWN** arrow keys can be used to adjust the reference level of the graph.

Level Adjustments

Press the **LVL** soft key to edit the scale and reference level of the Tilt display. To adjust the Scale, use the **UP** and **DOWN** arrow keys to select a scale that will provide the best viewing of the Tilt levels. To adjust the Ref Level, press the Ref Level soft key. Now the Ref Level can be changed by using the **UP** and **DOWN** arrow keys or by entering a numeric value followed by the **ENTER** key. The reference level is at the top of the graph.

NOTE: The reference value is limited by unit and the scale setting.

Pressing the **Auto Scale** soft key will automatically set the reference level for an optimum Tilt display. The **FCN + Scale** key can also be used to automatically set the reference level.

4.6 SCAN MODE

Use the Scan mode to get a good look at the whole spectrum of absolute carrier levels. In this mode a bar graph showing all carrier levels is displayed. A marker selects which channels carrier levels are displayed on the bottom of the screen.

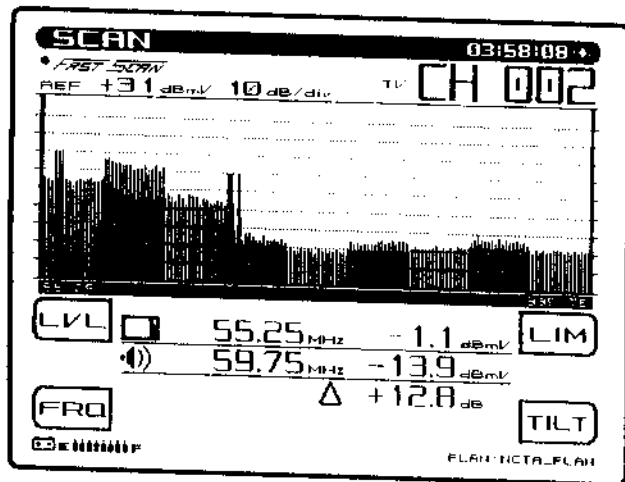

Information displayed in the Scan mode is as follows:

- Channel number
- Channel label
- Video carrier frequency and level (numerical)
- Audio carrier frequency and level (numerical)
- Histogram graph of carrier levels
- Delta between audio and video levels
- Selected channel plan
- Battery status
- Test point compensation (appears only if a nonzero value is programmed during setup)

When the **SCAN** key is pressed a graph showing all carrier levels is displayed. Use the **RIGHT** and **LEFT** arrow keys to position the marker to on the desired channel. The channel numbers can also be entered directly using the numeric entry keys.

The **UP** and **DOWN** arrow keys can be used to adjust the reference level of the graph.

Level Adjustments

Press the **LVL** soft key to edit the scale and reference level of the Scan display. To adjust the Scale, use the **UP** and **DOWN** arrow keys to select a scale that will provide the best viewing of the carrier levels. To adjust the Ref Level, press the Ref Level soft key. Now the Ref Level can be changed by using the **UP** and **DOWN** arrow keys or by entering a numeric value followed by the **ENTER** key. The reference level is at the top of the graph.

NOTE: The reference value is limited by unit and the scale setting.

Pressing the **Auto Scale** soft key will automatically set the reference level for an optimum Scan display. The **FCN + Scale** key can also be used to automatically set the reference level.

Frequency Adjustments

Press the **FRQ** soft key to edit frequency range parameters of the Scan display. Use the **UP** and **DOWN** arrow keys or the numeric entry keypad to set the start frequency. Press the **Stop** soft key to adjust the stop frequency. The **Full Span** soft key can be used to set the start and stop frequency to the full range of the unit.

Press the **TILT** soft key to turn tilt compensation on or off. Tilt channels must be programmed in the Channel Plan Edit mode, before this function can be implemented. The tilt is based on the levels of the highest and lowest frequency channels configured for tilt.

When turned on, the compensation value can be adjusted using the **UP** and **DOWN** arrow keys or by entering a numeric value followed by the **ENTER** key. When tilt compensation is in effect, a "TILT ON" indicator appears in the upper left portion of the scan screen.

Tilt Compensation

The tilt compensation feature allows the user to enter the cable loss for a particular section of line and then using the scan display adjust the gain of the amplifier to compensate for this loss.

Scan Rate

Two scan rates are available in the Scan mode, normal and fast. The scan rate is selected in the Measurement Setup menu. The Fast scan feature allows for rapid scan displays, while sacrificing accuracy. Normal scan rate is slower, but much more accurate. An indicator appears in the upper left hand corner of the Scan screen when the Fast Scan mode is selected.

Audio Carriers

If desired, the audio carriers can be omitted resulting in a faster scan. This feature is selected in the Measurement Setup menu. An indicator appears in the upper left hand corner of the Scan screen when audio carriers are omitted.

Limits

The Limits feature allows for comparison of the current scan measurement with the "FCC" limits that are defined in Setup. There are two parts to this feature.

When an out of tolerance condition exists a set of annunciators will appear below the scan graph. The annunciators indicate the following out of tolerance conditions:

- Adjacent Channel Error
- Video Level Too High/Low
- ΔVA Too High/Low

The limit annunciators are updated with each scan update.

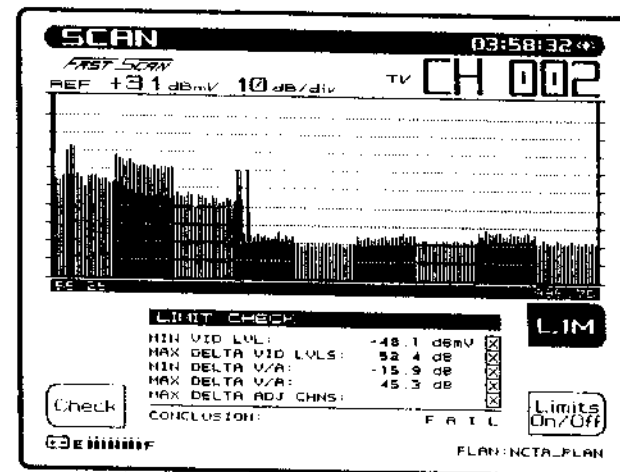

An "aggregate" result summary can be accessed by pressing the LIM soft key. This performs a limit check of all channels contained within the scan and reports an overall pass/fail conclusion. The aggregate limit check is not performed with each scan update, however, a Check soft key is provided to repeat the limit check whenever desired.

The Limits On/Off soft key toggles the limit check feature on & off. When turned off, the limit annunciators do not appear.

4.7 HOW TO MEASURE C/N

It is a good engineering practice to use a bandpass filter on the input of the receiver when making C/N measurements. This is to ensure accuracy and extend measurement range. If a preamplifier is used to boost test point levels prior to measurement, it should be placed between the bandpass filter and the receiver. This measurement is simply a comparison in amplitude between the video carrier reference signal and the noise (FCC limit: > 43 dB). The noise measurement must be made at least 2 to 2.5 MHz from any other carrier on the system.

In the C/N mode the carrier to noise ratio of the tuned channel or frequency is displayed. The C/N measurement bandwidth and the frequency offset for the noise measurement may be controlled from the screen. A proprietary DSP technique allows C/N measurements on modulated carriers (non-scrambled channels). The measurement is made by measuring the video carrier level and then tuning to the offset frequency, searches for a quiet line. Once a quiet line is found, the unit will then measure four consecutive frames and average the values together. The value is then corrected for the selected bandwidth, and the C/N ratio is computed.

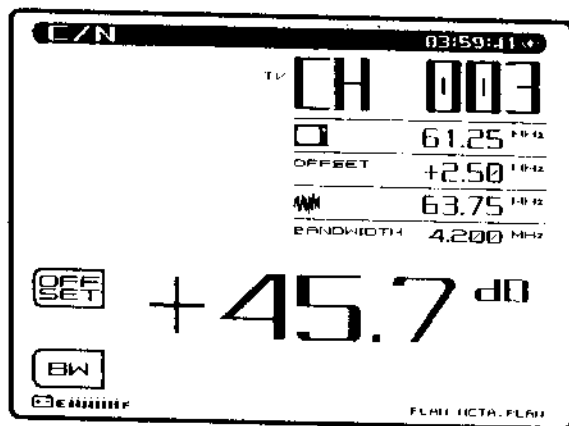

Information displayed in the C/N mode is as follows:

- Channel number
- Channel label
- Carrier frequency
- Noise offset frequency
- Noise frequency
- Bandwidth
- C/N ratio
- Channel plan
- Battery status

To make a carrier to noise measurement, press the C/N key. The C/N ratio of the tuned channel or frequency will be displayed.

NOTE: If the C/N measurement value is outside the specified range, the numerical result will change from black to gray.

To edit the bandwidth, press the **BW** soft key. The bandwidth can be adjusted by using the **UP** and **DOWN** arrow keys or by entering a value using the numeric keypad and then pressing the **ENTER** key. The FCC specification for C/N measurements is a bandwidth of 4.00 MHz. CATV organizations outside of the United States may have different requirements. Measurement BW can also be defined individually for each channel in the Channel Plan setup menu.

Noise Offset Frequency Adjustments

The frequency at which the noise level is measured is the Carrier frequency plus the noise offset. To adjust the noise offset, press the **OFFSET** soft key. The offset can be adjusted by using the **UP** and **DOWN** arrow keys or by entering a value using the numeric keypad and then pressing the **ENTER** key. Noise Offset values can also be defined individually for each channel in the Channel Plan setup menu.

Press the **STORE** soft key to save offset to the selected channel. Press the **ALL** soft key to save offset to all active channels in the channel plan.

Note: BW and Noise Offset values can be defined individually for each channel (see section 4.3.4 "How To Edit Channel Parameters"). When tuning by channel number, the BW and Noise Offset values are obtained from the channel plan. After tuning to a channel, the values can be adjusted using the Offset and BW soft keys. However, these adjustments will affect the C/N screen only and will not change the setup values in the channel plan.

4.8 HOW TO MEASURE HUM

Hum is undesirable modulation of the television video carrier by power line frequencies and harmonics (e.g., 60 or 120 Hz), or other low frequency disturbances (FCC limit: < 3%). To measure Hum, simply press the **Hum** key when tuned to any non-scrambled channel. In the Hum mode the hum modulation of the tuned channel or frequency will be displayed in either % or dB as selected by the operator. The units setting selected in the Hum screen (% or dB) will determine which units will be used to measure Hum during subsequent Auto Tests. Be sure to set the desired units in the Hum screen

before performing an Auto test. Once the Auto Test is performed, the units cannot be changed for that particular test. Soft keys allow the operator to select 60, 120 (50, 100 Hz), or <1,000 Hz filters for this measurement to help in troubleshooting. A 60 Hz modulation component suggests a possible corroded connector, a 120 Hz component tends to indicate a possible failure related to the DC supply in the amplifier - possibly a capacitor going bad and aggravating the ripple. A proprietary DSP technique enables Hum measurements on modulated carriers (non-scrambled channels).

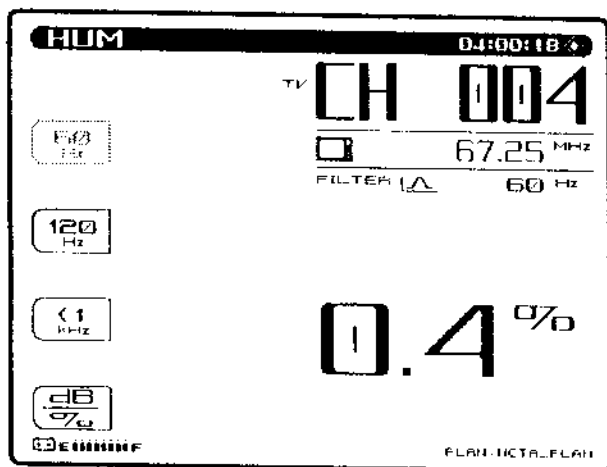

Information displayed in the Hum mode is as follows:

- Channel number
- Channel label, e.g. ESPN
- Video carrier frequency
- Hum value
- Hum filter frequency
- Channel plan
- Battery status

Stealth has been given the capability of measuring the 1Hz Hum component. To activate this feature, set the Fundamental Hum Frequency in the MEASUREMENTS setup screen to 1Hz. The filter options on the Hum screen will then become; 1Hz, <50Hz, and, <1kHz.

Note: The <1kHz setting does not include the 1Hz component, it only includes 50 to 1000Hz. Information displayed in the Hum mode is as follows:

NOTE: HUM measurements taken while the desktop charger is in use will affect the HUM reading. For the most accurate reading disconnect the charger prior to taking HUM measurements.

4.9 MODULATION

This function allows you to monitor the video depth of modulation in graphical and precise numerical format. A marker is placed at the optimal modulation level (NTSC 87.5%, PAL 90%) to assist technicians while making adjustments.

An **Audio** and **Depth** soft key is used to select the type of modulation to be displayed.

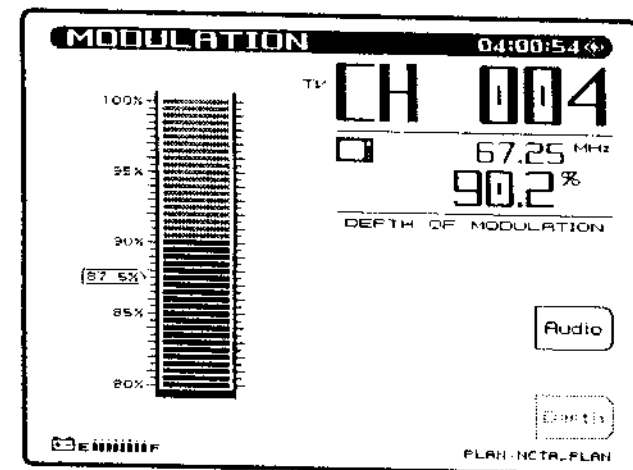

An additional feature is the ability to listen to the audio modulation of the tuned channel or frequency. Use the **Audio** soft key to listen to the audio modulation.

Use the **UP** and **DOWN** arrow soft keys to adjust the **time**.

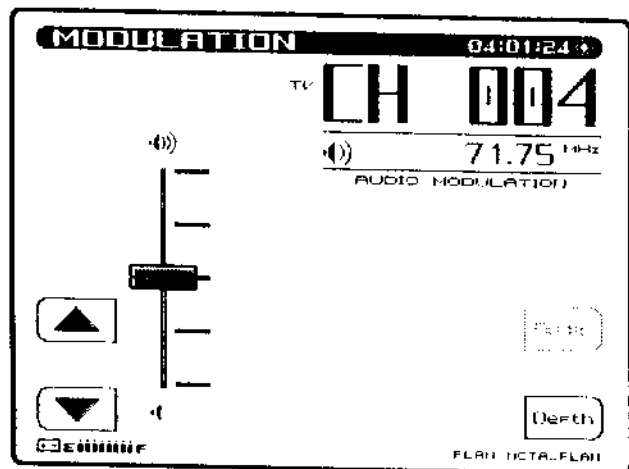

4.10 SPECTRUM ANALYZER MODE

The spectrum analyzer display provides a view of the system spectrum with variable spans from 50 MHz to 3 MHz and a dynamic range of better than 60 dB. When the **Spectrum** key is pressed, the following screen is displayed.

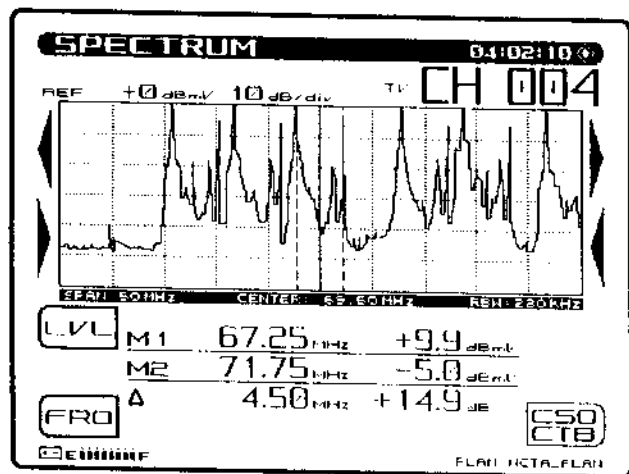

Level Adjustments

A **LVL** (level) soft key is used to adjust the vertical parameters of the graph. These parameters include Max Hold, Ref Level and Scale.

The Max Hold function ensures that the highest signal over multiple sweeps is displayed. When the Max Hold soft key is pressed, as indicated in the left hand corner of the display, the highest signal level is displayed. The M1/M2 readings correspond to the max hold levels. As multiple sweeps are performed, the maximum level trace will only change if new sweep levels exceed the existing levels.

The reference level is located at the top line of the graph. The Ref Level can be adjusted using the cursor keys or by entering a numeric value followed by the enter key.

The scale parameter (1,2,5, & 10 dB/Div) can only be adjusted with the cursor keys. For example, if the reference level was set at 0 dB and the scale was set at 10 dB/div the first horizontal grid line above the center would be equal to -30 dB. Press the **LVL** soft key to return to the main spectrum analyzer display.

Frequency Adjustments

Press the **FRQ** soft key to edit frequency range parameters of the Spectrum Analyzer display. Use the **UP** and **DOWN** arrow keys or the numeric entry keypad to set the center frequency. Press the **Span** soft key to adjust the span frequency. The **Full Span** soft key can be used to set the start and stop frequency to the full range of the unit. Press the **FRQ** soft key to return to the main spectrum analyzer display.

How To Make FCC In-Channel Response Measurements

(FCC limit: $< \pm 2$ dB)

The frequency response of any channel can be measured using the spectrum analyzer mode. A flat signal source must be inserted at the input of the modulator or processor. In testing a modulator this source may be a full field multiburst signal, or a sweeping function generator. For a processor, a bench sweep generator or a broadband noise source may be used. The response is monitored with the Stealth receiver in the spectrum analyzer mode. A 5 or 10 MHz span may be used. The "Max Hold" function is used to ensure that the peak levels are measured at all frequencies. The scale may be set to as low as 0.5 dB/div, but the operator will use the appropriate scale setting to enable display of the full response on screen. The operator then positions the markers at the maximum and minimum points of the display and reads the "delta" indicated at the bottom of the screen. The FCC requirement is a window of ± 2.0 dB, which means the delta should be < 4 dB.

How To Make CSO/CTB Measurements

CSO (Composite Second Order) is a clustering of second order beats at any frequency in the spectrum, which causes interference to picture quality when they fall within the video bandwidth. CTB (Composite Triple Beat) is a clustering of third order distortion products usually around the video carrier frequency.

The ability to make these measurements allows the technician to troubleshoot and correct the cause of this unwanted distortion.

NOTE: It is recommended that a ≤ 12 MHz band pass filter be used to limit the amount of intermodulation distortion caused by overload of the RF input of the receiver. If a pre-amplifier is used, it should be placed between the bandpass filter and the receiver.

Press the CSO/CTB soft key to initiate CSO/CTB measurements. The unit will first switch to a 30 kHz resolution bandwidth, measure the carrier and then prompt you to turn the carrier off. The signal must be unmodulated.

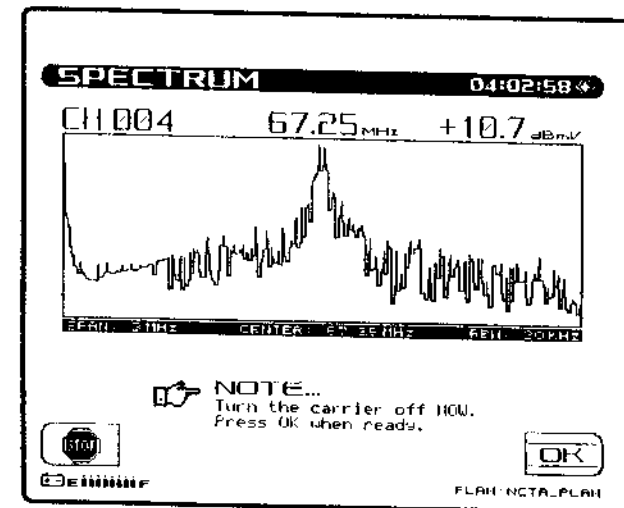

Press the **OK** soft key once the carrier has been turned off. The CSO/CTB measurement is now displayed.

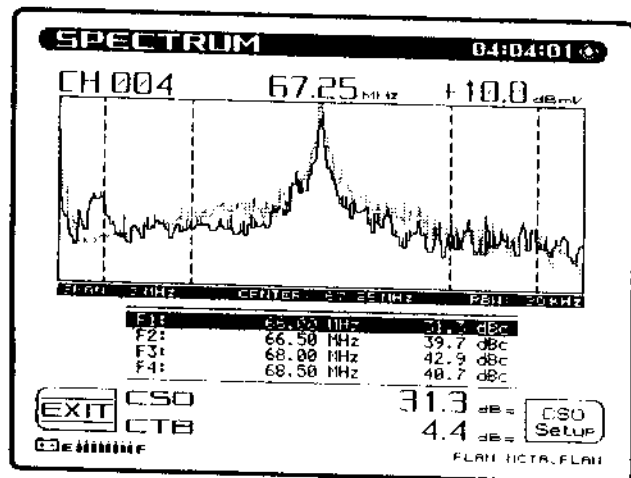

The light trace represents the carrier prior to it being turned off. The dark trace represents the distortion products. The measurement value is computed by a ratio of the peak level of the video carrier to the peak of the distortion products of the second and third order beats. The "worst case" CSO value is highlighted and is the overall CSO value. Press the **CSO Setup** soft key to adjust the offset values for the CSO measurement.

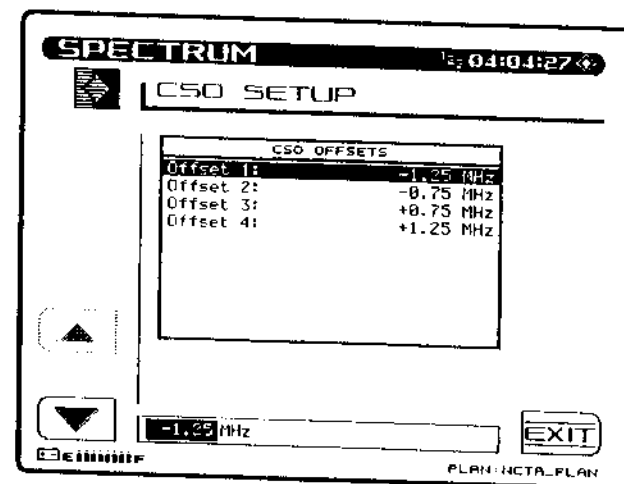

Using the **Up** and **Down** arrow soft keys, select the CSO Offset number to change. Use the numeric entry keys or the **UP** and **DOWN** arrow keys to enter a new CSO Offset value.

When exiting out of the CSO/CTB measurement, the unit will prompt you to turn the carrier back on.

4.11 HOW TO PERFORM SWEEP MEASUREMENTS

4.11.1 Introduction

The Sweep function has two operating modes, Stealth or Sweepless. The current sweep mode is indicated in the upper right hand corner of the screen. The Stealth mode allows sweep insertion points to be injected in vacant spectrum areas. The Sweepless mode only measures actual system carriers. Any system carrier can be used as a data point, even scrambled or digital carriers. In either mode, a previously stored response can be used as a reference to the current measurement. Sweep references are selected in the File setup menu.

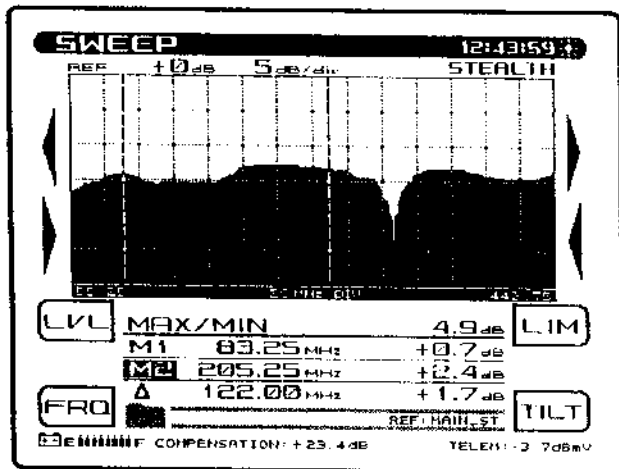

4.11.2 Operation

Frequency Adjustments

The **FRQ** (frequency) soft key is used to set the start and stop frequency. A start and stop soft key is displayed to select the parameter to be changed. The frequency is varied by using the cursor keys or a specific value can be entered using the numeric keys followed by the **ENTER** key.

A sub-function under the **Frequency** soft key is **Marker Zoom**. This will change the start and stop frequency to coincide with the M1/M2 values. The soft key will change to **Undo** to return to original start and stop values. Press the **FRQ** soft key to return to main sweep display.

Level Adjustments

A **LVL** (level) soft key is used to adjust the vertical parameters of the

graph. These parameters include Ref Level and Scale. The reference level is the midpoint level displayed on the graph. The Ref Level can be adjusted using the cursor keys or by entering a numeric value followed by the **ENTER** key.

The scale parameter (1,2,5, & 10 dB/Div) can only be adjusted with the cursor keys. For example, if the reference level was set at 2 dB and the scale was set at 5 dB/div the first horizontal grid line above the center would be equal to 7 dB. An **Auto Scale** soft key will automatically set the reference level for an optimum sweep display. The **FCN + Scale** key will also automatically scale the sweep display. Press the **LVL** soft key to return to main sweep display.

Marker Adjustments

The sweep display includes horizontal and vertical markers. The vertical markers appear on the graph at all times. The vertical markers are labeled M1 & M2. M1 is always to the left of M2. The markers cannot be adjusted to crossover each other. The vertical markers are adjusted using the top two sets of soft keys corresponding to the displayed arrows. The horizontal markers are turned on and off in the Sweep setup screen. The horizontal markers are not adjustable, they automatically track the max and min values in the area of the graph between the vertical markers. The numeric value for Max/Min appears below the sweep graph. This is the maximum level minus the minimum level for the area of the graph between (and including) the vertical markers.

Note the "M1" and "M2" indicators to the left of the marker frequencies below the graph. The inverse highlighting of the "M2" indicator means that marker #2 is currently active. There can be only one active marker at a time. This is the marker that was last adjusted using the left/right arrow soft keys. The frequency of the active marker can be entered directly using numeric keys. The numerals appear on the screen as they are entered. The location of the entry field corresponds to the marker being set (M1 or M2). When the edit box is being displayed, neither marker is active.

Limit Adjustments

A **LIM** (limits) soft key is used to turn the limits function on/off,

adjust limits, and specify the amp number. If the limits function is off, the adjust limits and amp number soft keys are disabled and dimmed. The limits on/off soft key toggles to enable or disable the limits function. When the limits function is turned on, and the adjust limits soft key is pressed, the limits can be adjusted using the **UP** and **DOWN** arrow keys. The limits can also be set by entering an Amp # using the numeric entry keys or the **UP** and **DOWN** arrow keys. The amp number is used in the flatness formula, $(n/10 + x)$. The x in the equation is configured in the sweep setup screen as the sweep limit variable. If any portion of the sweep that is currently being displayed exceeds the limits an X is placed in the pass/fail box. Press the **LIM** soft key to return to main sweep display.

NOTE: The limit function checks only the area of the sweep between the current start and stop frequencies.

Sweep References

The Stealth sweep system works using the reference comparison method, commonly called "normalization". With this method, the response at the test point is compared to a reference that was stored at the first amplifier or fiber node, or at a headend or hub site. The sweep trace shows the difference between the sweep levels at the reference point and the sweep levels at the current test point. This works because cable systems are designed according to a "unity gain" principle, which means that the output of each amplifier in the cascade is ideally identical to that of the first amplifier.

Tilt Compensation

Press the **TILT** soft key to turn tilt compensation on or off. Tilt channels must be programmed in the Channel Plan Edit mode, before this function can be implemented. The **TILT** soft key will be inactive if there are no tilt channels defined in the Receiver's channel plan. The tilt is based on the levels of the highest and lowest frequency channels configured for tilt.

When turned on, the compensation value can be adjusted using the **UP** and **DOWN** arrow keys or by entering a numeric value followed by the **ENTER** key. When tilt compensation is in effect, a "TILT"

indicator appears in the upper portion of the sweep screen.

The tilt compensation feature allows the user to enter the cable loss for a particular section of line and then using the sweep display adjust the gain of the amplifier to compensate for this loss.

4.12 FILE

The File menu consists of three File submenus; Store Measurement, Measurement Files, and Sweep References.

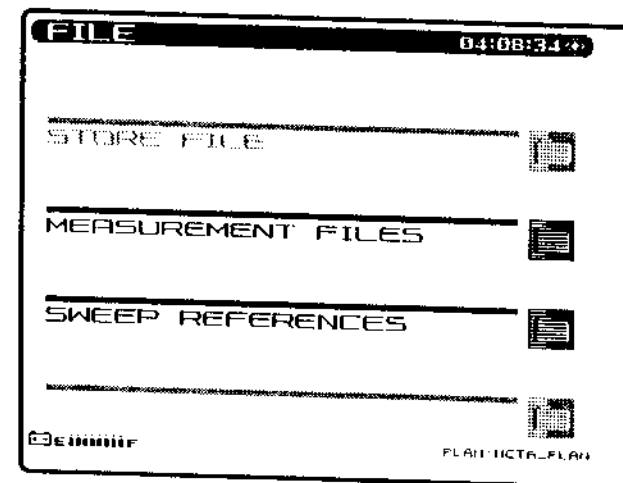

4.12.1 How to Store/View/Print/Delete Measurement Files

The Store Measurement feature allows the user to store sweep, spectrum and scan measurements. To store a measurement, press the **File** key while taking the measurement. Press the **Store Measurement** soft key to access the measurement files. To store the measurement, press the **Store** soft key. The unit will then prompt for a file name. Once a name is entered, press the **OK** soft key to execute the operation.

To view measurement files, press the **Measurement Files** soft key. A listing of all currently stored measurement files is displayed. Use the **UP** and **DOWN** arrow keys to select the file to be viewed. Once

selected, press the **View** soft key. Scan measurements can be stored, but can only be viewed/printed using the Stealthware Data Analysis software. Once a file is selected it can be printed using the **Print** soft key. All measurement files, with the exception of scan files, can be printed using the **Print All** soft key. Use the **Delete** soft key to delete all unwanted files.

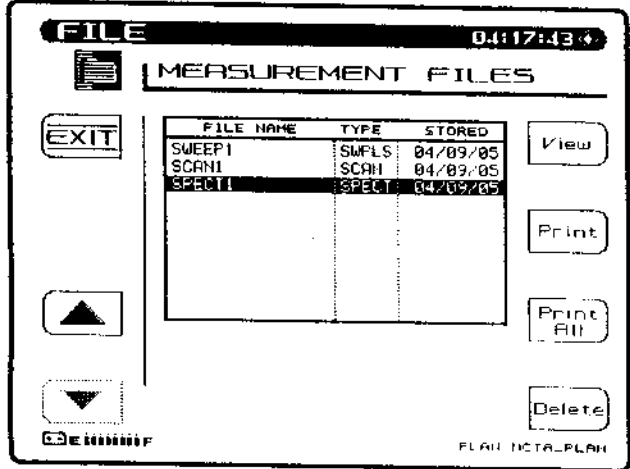

There are several different types of Sweep Files and Sweep References: The following mnemonics are used for the different types:

- FDSWP - Forward Sweep
- RVSWP - Reverse Sweep
- SWPLS - Sweepless Sweep

4.12.2 How to Store/Delete Sweep References

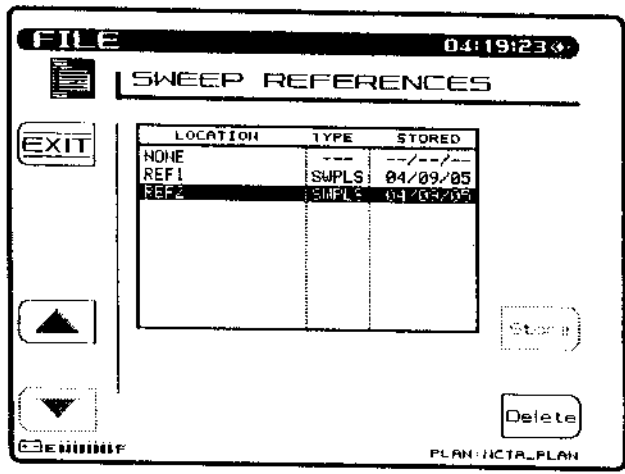

The Sweep References soft key allows the user to select, store or delete sweep references. After a sweep measurement is made, a sweep reference can be stored. The unit must remain in the Sweep screen for a minimum amount of time before a reference can be stored. When first entering the Sweep screen, a wait indicator appears above the sweep graph. A reference cannot be stored until the wait indicator goes away. To store a Sweep Reference, press the **File** key followed by the **Sweep References** soft key. Next, press the **Store** soft key to name and store the sweep measurement as a reference.

NOTE: The Store soft key is only active if Sweep was the most recent mode selected prior to pressing the File key.

Sweep references can be deleted, by pressing the **Delete** soft key. To select a reference, use the **UP** and **DOWN** arrow keys to highlight the desired reference and then press the **ENTER** or **SWEEP** key to return to the Sweep screen.

If the channel plan has changed since a reference has been stored, the reference is obsolete and can no longer be used. If an obsolete reference is selected, a warning message will appear when entering

Sweep mode, and the default reference will be used. It is recommended that obsolete references be deleted in order to free memory for additional references and files.

4.12.3 Sweep File Overlay

If you enabled the Sweep File Overlay feature in the Sweep Receiver Setup menu, you can select a sweep measurement file to be viewed simultaneously with the "live" sweep.

The sweep file is selected from the Measurement Files screen the same as if it were to be viewed.

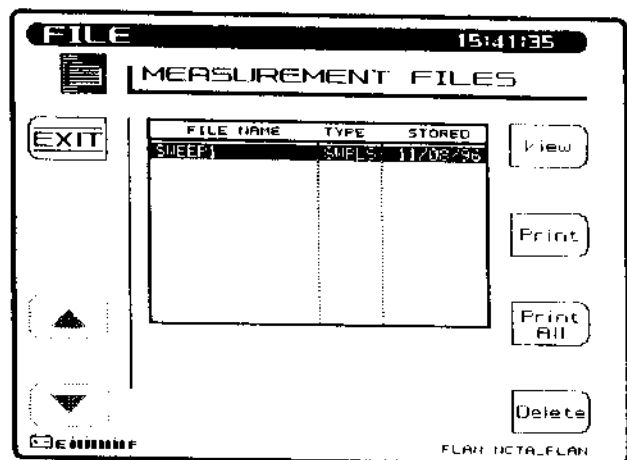

The Sweep screens appears upon pressing the View soft key. When the Sweep File Overlay option has been enabled, the live response will overlay the stored response **IF** the following conditions are met:

1. The current sweep mode (Sweepless, Stealth Fwd, Stealth Rev) matches the mode under which the sweep file was stored.
2. The channel plans for the stored and live sweep match.

If sweep overlay is not possible, a user message will appear explaining the situation.

The stored sweep response is displayed as a gray-filled area. The live response appears as a solid line superimposed or overlaid on top of the stored sweep response and is updated continuously.

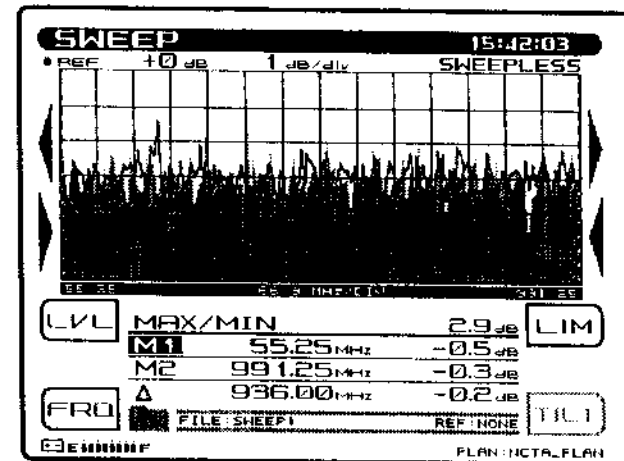

The names of the file being viewed and the currently selected reference are shown beneath the marker information.

The level and frequency adjustments affect both the stored and live sweeps. The reference, limits checking and tilt compensation are applied to the live sweep only. The marker values indicate the levels of the live sweep. Auto scale is performed on the live sweep data.

4.13 AUTO

The Auto menu consists of three File submenus; Test Locations, Perform Auto Test, and Auto Test Results.

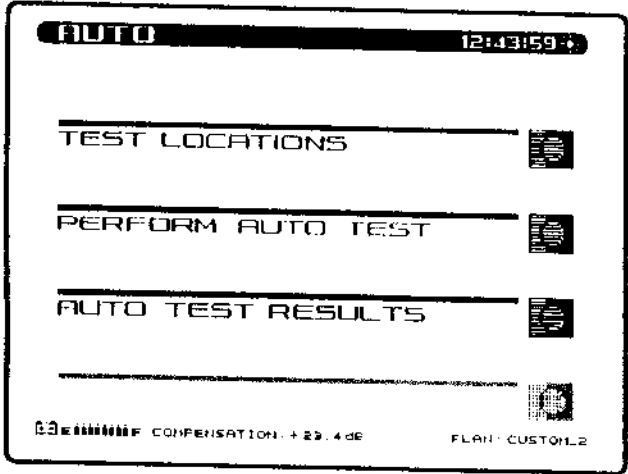

4.13.1 How To Create/Edit/Delete Test Locations

Test Locations allow the user to create specific test point location parameters used in the Auto Test report. The Test Locations can be created directly on the Stealth unit, or using the StealthWare Data Analysis software and downloaded to the Stealth unit. The Test Location is used to identify where the data is collected. The user then simply selects the corresponding location, and the location data is automatically included in the Auto Test report.

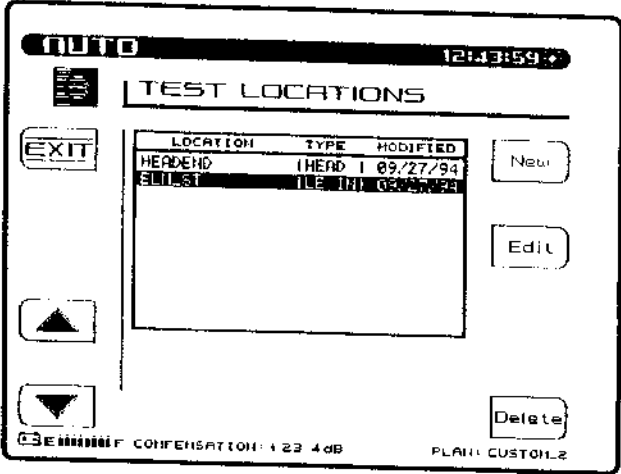

Press the New soft key to create a new Test Location file.

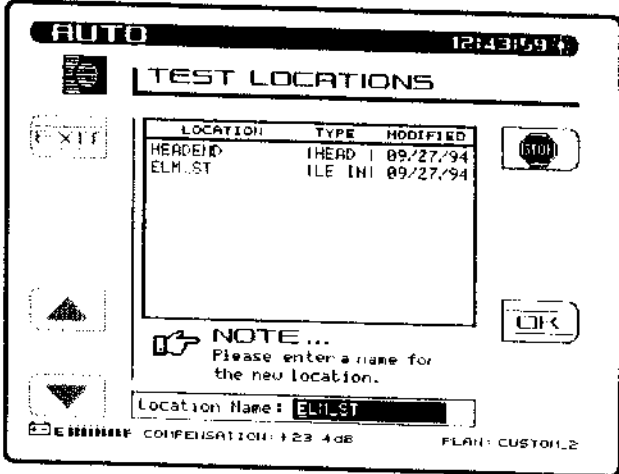

The unit will then prompt for a file name. Once a name is entered, press the OK soft key to execute the operation.

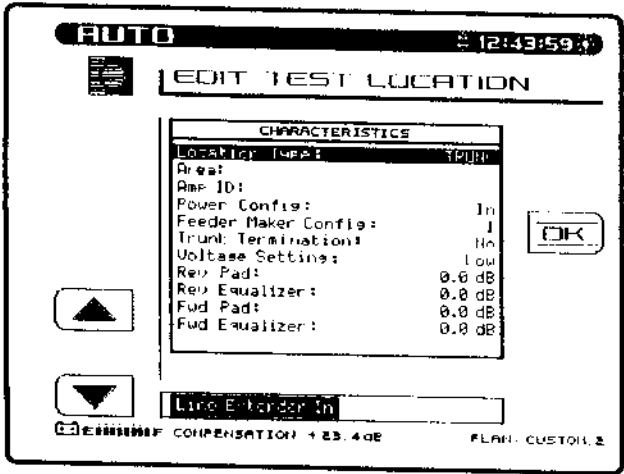

Each location in the list has an associated type and values for the descriptive parameters. The parameters are shown in the following table.

Parameter	Min	Max	Default	Units
1 Area	15 column alpha numeric field			
2 Amp Id	15 column alpha numeric field			
3 Power Configuration	IN / OUT / THROUGH			
4 Feeder Maker Config	1	9	1	
5 Trunk Termination	NO	YES	NO	
6 Voltage Setting	LOW / MID / HIGH			
7 Rev Pad	-100.0	+100.0	0.0	dB
8 Rev Equalizer	-100.0	+100.0	0.0	dB
9 Fwd Pad	-100.0	+100.0	0.0	dB
10 Fwd Equalizer	-100.0	+100.0	0.0	dB

There are five types of locations associated with a cable system: Trunk Amp, Headend, Line Extender, Fiber Node, and Field Test. Some of the parameters do not apply to certain types of locations. The following table shows which of the parameters in the table above apply to each of the location types.

Characteristic	Trunk	Head	Extender	Fiber	Field
1 Area	yes		yes	yes	yes
2 Amp Id	yes		yes	yes	
3 Power Configuration	yes		yes	yes	
4 Feeder Maker Config	yes		yes	yes	
5 Trunk Termination	yes		yes	yes	
6 Voltage Setting	yes		yes	yes	
7 Rev Pad	yes		yes	yes	
8 Rev Equalizer	yes		yes	yes	
9 Fwd Pad	yes		yes		
10 Fwd Equalizer	yes		yes		

Editing of location files is done by pressing the **Edit** soft key. The optional fields will be enabled or disabled according to the location type selected (see table above).

Use the **Up** and **Down** arrow soft keys to scroll to the desired parameter. Use the **UP** and **DOWN** arrow keys or the numeric entry keypad to enter the desired value. Once all the desired parameters have been edited, press the **OK** soft key.

The **Delete** soft key is used to delete a specific location file.

4.13.2 How To Perform An Auto Test

The Auto Test mode provides automated FCC 24 hour testing capabilities. Video & audio carrier levels will be measured for each enabled channel. Additionally, the following can be selectively measured for each channel: C/N, Hum, and Modulation. See Section 4.3.3 How To Setup Your Channel Plan for instructions on how to enable these individual measurements. Tests can be made immediately or at timed intervals, with the instrument sleeping between tests to conserve battery life. Upon test completion, the test results can be viewed on the LCD display before printing or downloading to a PC.

Press the **Perform Auto Test** soft key to enter the Auto test mode. The instrument provides a step-by-step procedure on how to perform an Auto Test.

Auto Test Location

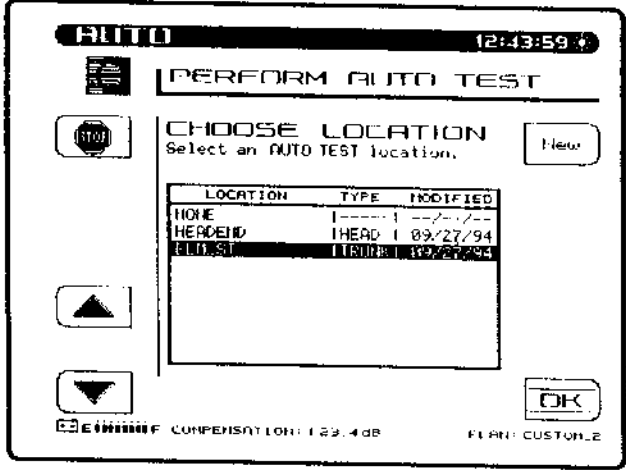

Using the **Up** and **Down** arrow keys, select an Auto Test location. Select **NONE** if location information is not desired. Press the **OK** soft key when completed. To create a new Auto Test location, press the **New** soft key.

Auto Test Characteristics

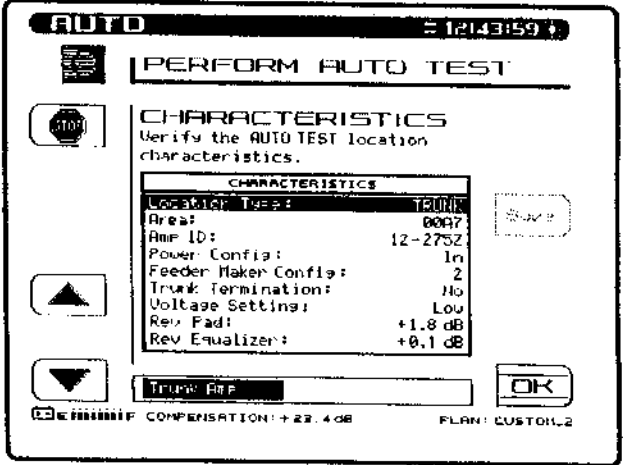

Use **Up** and **Down** arrow keys to scroll through the location characteristics for the test being performed. Press the **ENTER** key after each parameter is entered to update the display. If changes are made and you want them updated in the location file, press the **Save** soft key. If changes are made and the **Save** soft key is not pressed, the changes will only affect the Auto Test that is about to be performed. Press the **OK** soft key when completed.

Test Point Type

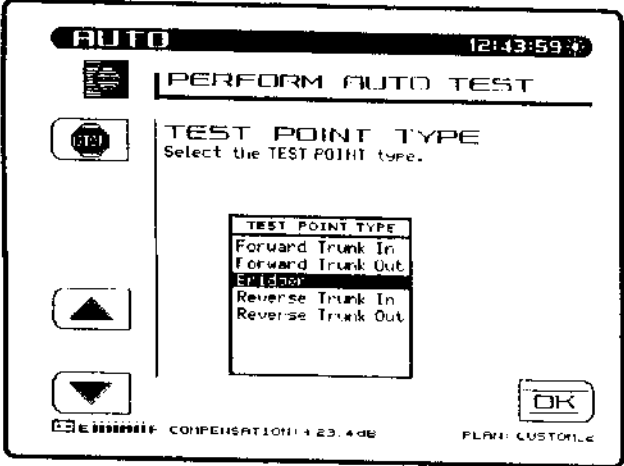

Use the **Up** and **Down** arrow keys to select the Test Point type. When the desired Test Point type is selected, press the **OK** soft key. The following is a list of Test Point types available:

- Trunk Amp: Forward Trunk In
- Forward Trunk Out
- Bridge
- Reverse Trunk In
- Reverse Trunk Out

- Line Extender: Line Extender In
- Line Extender Out

Voltage Measurements

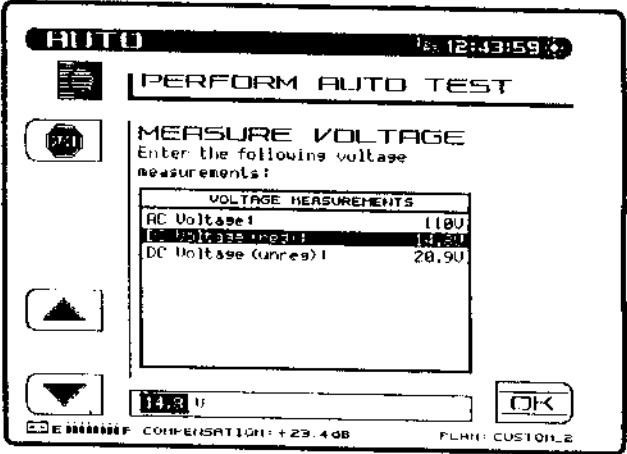

Use the numeric entry keys to enter the following system voltage measurements:

- AC Voltage
- DC Voltage (regulated)
- DC Voltage (unregulated)

The voltage measurement are printed in the Auto Test report. Press the **OK** soft key when completed.

Test Point Compensation

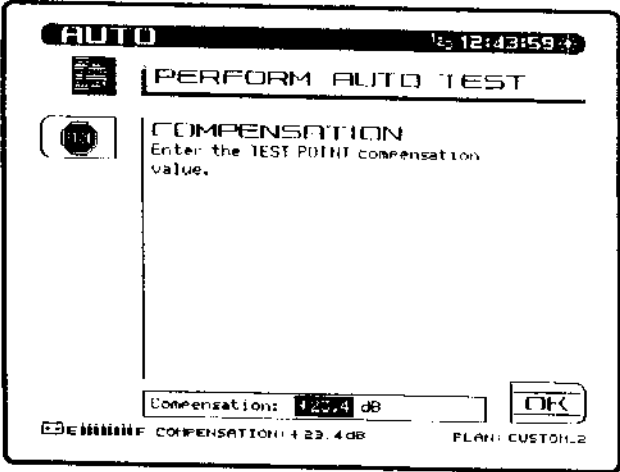

Test Point Compensation is used to account for losses associated with certain amplifiers. Use the UP and DOWN arrow keys or the numeric entry keys to enter the Test Point Compensation. (-100.0 to +100.0 dB in 0.1 dB steps). Press the OK soft key when the desired value has been entered.

Results File

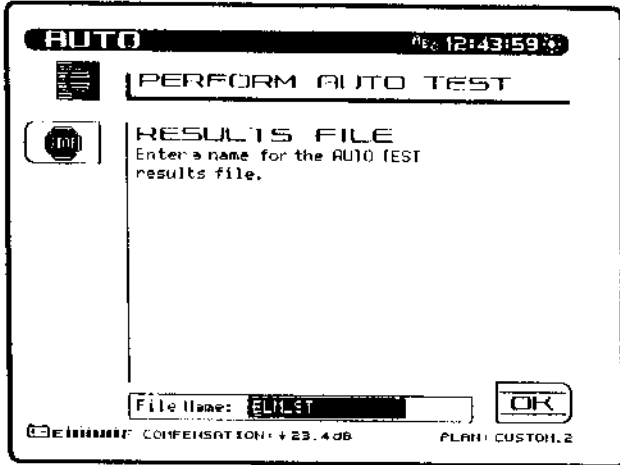

Enter a file name for the Auto Test results to be stored. If an existing file name is used, a warning message will appear prompting the user to overwrite the existing file or create a new one. When the desired file name has been entered, press the OK soft key to proceed with the Auto Test.

Type Of Test

Press the Immediate soft key to commence the Auto Test. Press the Scheduled soft key to perform the Auto Test repeatedly at scheduled intervals.

Immediate

If the Immediate mode is selected the unit will commence the Auto Test sequence. Prior to starting the test, the unit will prompt you to enter the ambient temperature. This allows you to manually read ambient temperature from an external source. The temperature displayed is the temperature sensed by the unit. Use the numeric entry keys to enter the ambient temperature. Press the OK soft key when the desired temperature has been entered.

While the Auto Test is in progress, the following screen is displayed:

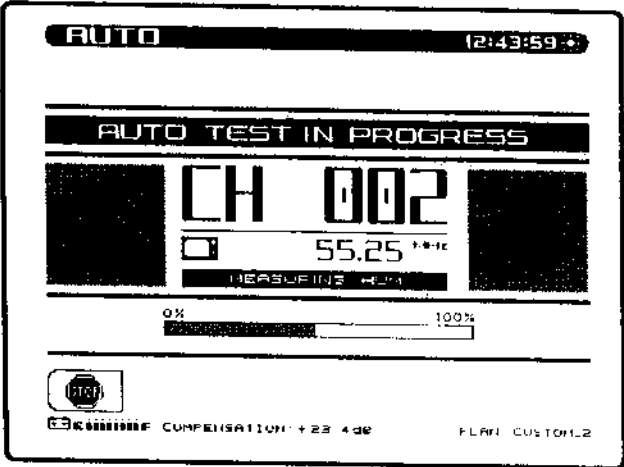

While the Auto Test is in progress, the measurement currently being performed (i.e. Level, C/N, Hum, or Modulation) is indicated on the screen. A bar graph showing the percentage of completion is displayed.

Scheduled

If the Scheduled mode is selected, the start, stop, and interval information must be entered prior to commencing the Auto Test.

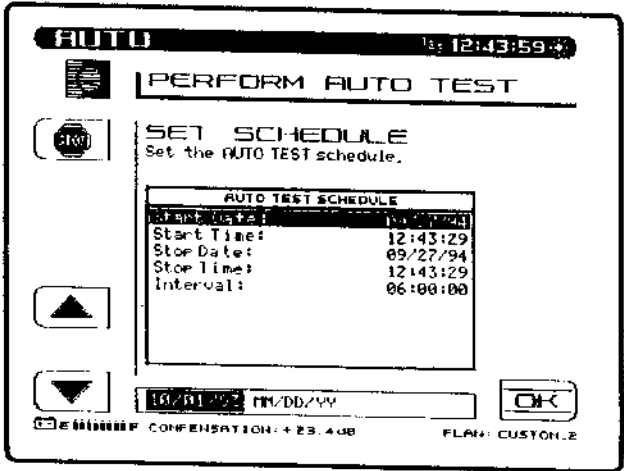

Using the numeric entry keys, enter the start and stop information for the date and time as well as the interval amount. Press the **ENTER** key after each parameter is entered to update the display. Use the **Up** and **Down** arrow soft keys to select the parameter to be entered. Press the **OK** soft key to commence the Schedule Auto Test. If the first interval is to commence immediately, the unit will prompt you to enter the ambient temperature. The temperature displayed is the temperature sensed by the unit. Use the numeric entry keys to enter the ambient temperature. Press the **OK** soft key when the desired temperature has been entered. If the first interval is to commence immediately, the "Auto Test In Progress" screen is displayed. When the unit is between testing intervals, the following screen is displayed:

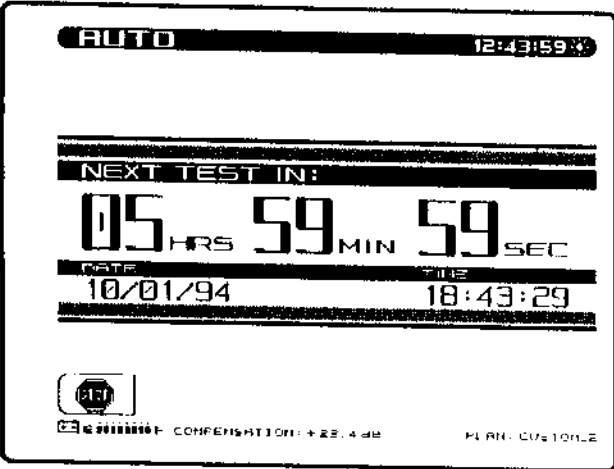

When the unit is between testing intervals it will enter a sleep mode in order to conserve battery life. All other unit functions are disabled during the performance of the Auto Test.

4.13.3 Viewing/Printing Auto Test Files

Upon completion of the Auto Test, the unit will enter the Auto Test Results Mode to display the Auto Test files. This allows the user to view or print the Auto Test results. Use the **Up** and **Down** arrow soft keys to select a file, then press the **View** soft key. A **Print All** soft key is available to print all intervals from all files in the directory to the printer. The **Info** soft key displays the Test Location Characteristics for the selected file.

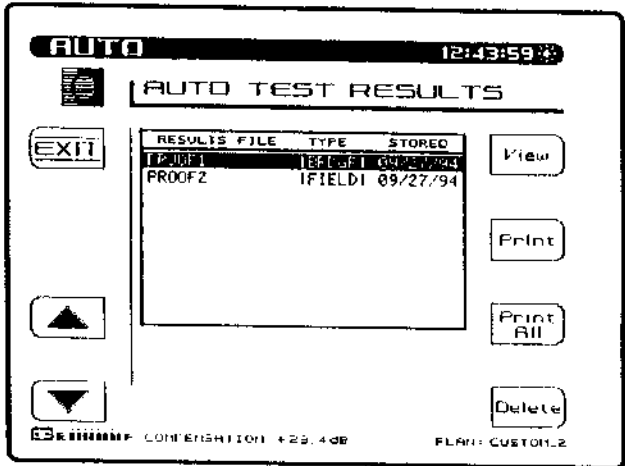

A table with all testing intervals and test site information is now displayed. If the Auto Test was performed immediately, then only one interval is displayed. If the Auto Test was performed using scheduled intervals, then all the interval numbers are displayed. The **Print All** soft key is used to send all intervals in the directory to the printer.

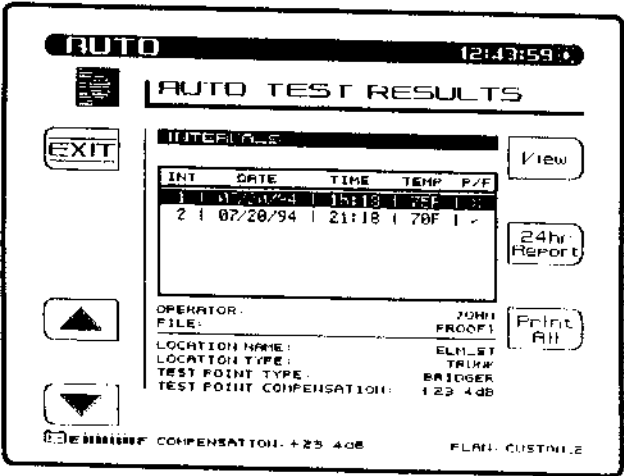

Information provided on each interval includes:

- Interval number
- Date measurement was made
- Time measurement was made
- Temperature
- Pass/Fail test results

An "X" in the Pass/Fail column indicates an overall failure of the measurements taken during that interval. A check mark indicates that all measurements were within the specified limits.

To comply with FCC 24 hour testing requirements, the 24hr Report soft key is provided. When the **24hr Report** soft key is pressed, the unit will automatically format and print the highlighted interval plus the next three intervals. The following is an example of a 24 Hour Test Report:

HAVERHILL STEALTH 24 HOUR TEST REPORT

Model: 3SR Serial No: 1234567 Cal Date: 06/21/95

Operator: JOHN File: PROOF1

Location Name: 1028_ELM ST
 Location Type: Trunk
 Test Point Type: Forward Trunk In
 Test Point Compensation: +0.0 dB

Area: 00A7
 Amp ID: 12 275Z
 Power Config: 1u
 Feeder Maker Config: 1
 Trunk Termination: No
 Voltage Setting: Low
 Reverse Peds: +0.0 dB Reverse Equalizer: +0.0 dB
 Forward Peds: +0.0 dB Forward Equalizer: +0.0 dB

AC Voltage: 110 V DC Voltage (reg): 14.8 V (unreg): 20.9 V

	#1	#2	#3	#4	
Date:	07/04/95	07/04/95	07/05/95	07/05/95	
Time:	17:00:00	21:00:00	05:00:00	11:00:00	
Temp:	-75 F	-61 F	-59 F	+83 F	
	Video Level (dBmV)	Video Level (dBmV)	Video Level (dBmV)	Video Level (dBmV)	24 Hr Deviation (dB)
Chan					
2	-9.6	+8.0	-17.7 LO	+10.7	28.4 HI
3	-9.9	+8.6	5.8 LO	+8.9	35.7 HI
4	-9.2	+8.3	2.9 LO	+10.1	33.0 HI
5	-9.3	+8.2	-9.3	+11.5	3.3
6	-8.1	+9.1	+8.6	+11.0	2.9
14	-9.7	+8.7	+9.0	+13.0	2.3
15	-9.3	+7.6	+9.6	+10.6	3.0
16	+10.2	+8.0	+10.7	+10.5	2.7
17	-9.6	7.4	+9.6	+10.8	3.4
18	-9.2	+8.0	+10.0	+10.2	2.2

LIMIT CHECK	Limit	1	2	3	4	
Min Video Carrier Level:	-0.0 dBmV			X		Fail
Max Delta Video Levels:	0.0 dB	X				Fail
Min Delta V/A:	6.5 dB			X	X	Fail
Max Delta V/A:	17.0 dB	X		X	X	Fail
Max Delta Adjacent Channels:	3.0 dB	X	X	X	X	Fail
24 Hr: Video Deviation:	8.0 dB					Fail

Conclusions: E A I L

Reviewed: _____ Date: _____

The channels with the asterisks indicate those channels that exceeded the Max Delta Adjacent Channels limit. The limits that the readings were compared to, are printed at the bottom of the report. To the right of the limits, the report displays each interval that failed the specific limit. If a particular measurement was not within the specified limit, a HI/LO marker is printed next to the reading indicating the direction that the measurement was out of specification.

Each interval can be selected and viewed as desired. Use the **Up** and **Down** arrow soft keys followed by the **View** soft key to view specific interval test results.

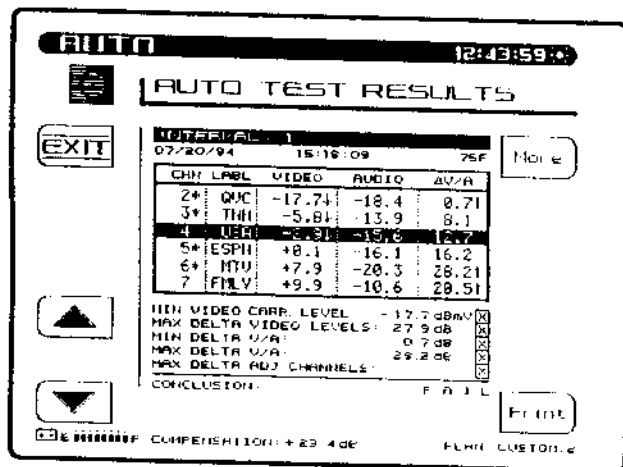

The test results along with the limits comparison is displayed. The asterisks and up/down arrows have the same meaning as on the single interval report printout. The limit that was exceeded as on the measurement reading is displayed on the lower portion of the screen. When viewing the list of Level measurements, the following symbols will appear to the right of the measurement if an error occurred:

- < under range
- > over range
- E synthesizer unlocked

Use the **More** soft key to toggle between Level measurements, C/N, Hum, and Modulation measurements.

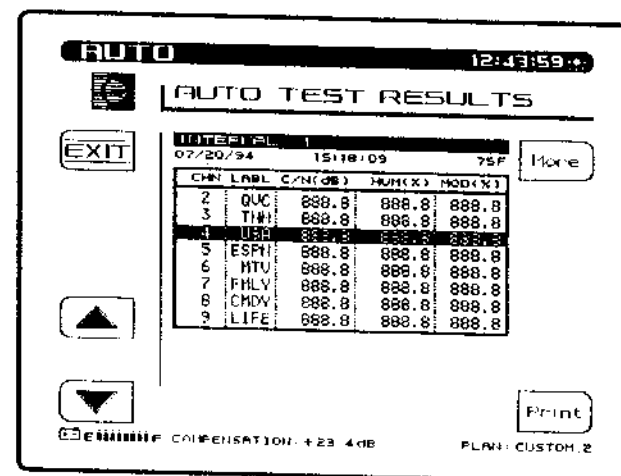

When viewing the list of C/N, Hum, and Modulation measurements, the following symbols will replace the measurement value if an error occurred:

- UNDER - under range
- OVER over range
- ERROR - synthesizer unlocked

The **Print** soft key can be used to print out the following report:

```

WAVETEK SIGNAL AUTO TEST REPORT
Model: 3SR                      Serial No: 1214567          Cal Date: 06/21/95
Operator: JOHN                  File: E800F1          Interval: 1
Date: 07/20/95                 Time: 15:18:09       Temp: 75 F
Location Name: 1028_EIN_ST
Location Type: Trunk
Test Point Type: Forward Trunk In
Test Point Compensation: +0.0 dB

Area: 00A7
Amp ID: 12-2/52
Power Config: In
Feeder Maker Config: 1
Trunk Termination: No
Voltage Setting: Low
Reverse Pad: +0.0 dB      Reverse Equalizer: +0.0 dB
Forward Pad: +0.0 dB     Forward Equalizer: +0.0 dB

AC Voltage: 110 V          DC Voltage (freq): 14.8 V (actual): 20.9 V

Chan  Label  Video      Audio      Delta V/A      C/N      Hum      Mod
      (dBmV)  (dBmV)      (dB)         (dB)         (dB)         (%)         (%)
 1 * QVC   17.7 LO    18.4        0.7 LO        13.9        1.4        86.3
 3 * TNS   5.8 LO    11.9        8.1           12.7        1.4        86.3
 4 * BSA   7.9 LO    15.6        12.7          12.7        1.4        86.3
 5 * SSPN  -0.1      16.1        16.2          12.7        1.4        86.3
 6 * MTV   -7.9      20.1        28.2 HI       12.7        1.4        86.3
 7 * FMY   -9.9      19.6        29.5 HI       12.7        1.4        86.3
 8 * CNDY  -6.9      11.5        18.4 HI       12.7        1.4        86.3
 9 * LIFE  -9.1      11.1        20.2 HI       12.7        1.4        86.3
10 * VHI   -8.5      14.3        21.8 HI       12.7        1.4        86.3
11 * CNI   -4.1      12.0        16.1          12.7        1.4        86.3
12 * A&E  -4.3      3.4         7.7           12.7        1.4        86.3
13 * CIN   -7.1      4.2        11.3          12.7        1.4        86.3
14 * SHOW -6.3      7.5         1.8           12.7        1.4        86.3
15 * NICK -10.2 HI   8.2         18.4 HI       12.7        1.4        86.3

LIMIT CHECK
Min Video Carrier Level: -0.0 dBmV      CR 1      17.7 dBmV      Pass
Max Delta Video Levels: 10.0 dB         CR 2      22.9 dB         Pass
Min Delta V/A: 6.5 dB                   CR 3      0.7 dB         Pass
Max Delta V/A: 27.9 dB                   CR 4      28.2 dB         Pass
Max Delta Adjacent Channels: 3.0 dB      CR 5      28.2 dB         Pass

Conclusion:
Reviewed:
    
```

This report is similar to the 24 hour report with only one interval being reported. The 24 hour video deviation information is not present.

4.14 STATUS

To view the Status screen, press the FCN key followed by the **Status** second function key. The Status screen provides unit information to the user. An important feature is the amount of memory currently being used. This allows the user to decide if unwanted files should be deleted to make more memory available for newer files.

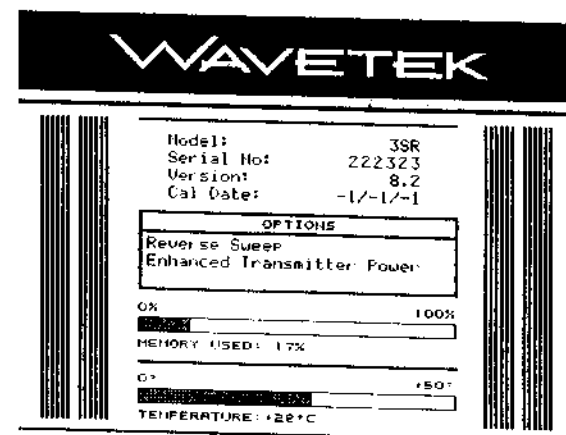

⁽¹⁾Specification Change - The transmitter output is being changed from +10 to +40 dBmV to +20 to +50 dBmV. To determine which transmitter output range is available on your unit, access the Status screen by pressing the FCN key followed by the **Status** second function key. If "Enhanced Transmitter Output" is displayed in the options box, the transmitter output range is +20 to +50 dBmV.

SECTION 5 REVERSE SWEEP OPTION

5.1 INTRODUCTION

The Stealth sweep system is designed to be non-interfering. Hence the name Stealth for something that is there and no one knows it except the sweep technicians. In general terms, the sweep is set up to measure existing signals, and insert sweep signals where there are no service channels. The system is accurate and stable on the existing signals because the Model 3ST transmitter is continuously monitoring these signals in the headend and sending the information to the Model 3ST receiver at the field test point to compensate for level drift or headend level tinkering.

This section provides detailed operation of the Model 3SRV Reverse Sweep Option. Included are detailed descriptions of how to perform reverse sweeping as well as interpret the various displays.

5.1.1 Wavetek Stealth Reverse Sweep Concept

The Stealth sweep follows a channel plan which contains information on where channels exist and where sweep signals are inserted. For forward sweeping, the channel plan is built through a process in which the 3ST transmitter tunes through a standard (or HRC or IRC) channel analog video line-up and looks for the presence of a signal on the input. If a signal is present, it builds it into the plan as a TV channel. The technician can then edit the plan and designate channels as scrambled (sweep dwells longer at that frequency to ensure acquiring the peak), or as digital (provided the 3SR has a digital option). Further, he can review other specific channel-related information. After identifying the existing channels, the technician builds sweep points to automatically set up one to three sweep points in nonexistent channels (video frequency, audio frequency and halfway in between). Individual sweep points may also be added at any specific desired frequency. The technician scrolls through the plan in the 'Edit channel parameters' mode to make sure that the sweep points are set so as not to intrude on any service channels. The sweep insertion point should be at least 100 kHz from the edge of any channel.

With the reverse sweep option, a transmitter is built into the handheld sweep receiver. The headend sweep transmitter (3ST/3HRV) is set up to receive the reverse sweep sent from the field. When a reverse sweep is activated from a field test point, the headend transmitter receives the telemetry signal that indicates which receiver is sending the sweep. The headend transmitter measures the sweep, and sends the results, along with the serial number of the sending receiver via its telemetry signal to the field. The field receiver with the tagged serial number then displays the sweep response as measured in the headend on its LCD. Only one receiver at a time can perform reverse sweeping with a 3ST. If additional receivers attempt to sweep, a message is displayed. Up to 10 different technicians can sweep the reverse path using a 3HRV. The only effect on receivers sweeping in the forward direction is a slightly slower sweep time.

Ingress Detection and Troubleshooting (3HRV only)

The 3HRV provides feedback to the field as to the current condition of noise and ingress in the headend. Even if the noise or ingress is "swamping" the telemetry a "picture" of the headend noise/ingress is sent out to the receiver via a special forward telemetry carrier for display.

Easy To Read Noise/Ingress Display (3HRV only)

The headend instrument provides a continuous display of the noise/ingress performance of the connected nodes. This provides a quick, easy way for the headend technician to verify performance. In addition, the current reverse testing activity can be monitored.

5.1.2 Basic Reverse Sweep Procedure

Sweeping the reverse path is a little different from sweeping the forward path. Because the system is designed with appropriate spacing for the forward high frequency range, the reverse path may not require amplification at each station. The lower frequencies aren't attenuated in cable as much as the higher frequencies. In sweeping the forward path, the amplifier is aligned such that its output is within certain limits (the amplifier compensates for the cable behind it). However, in sweeping the reverse path the ampli-

fier is aligned such that the response at the headend is within certain limits *from this amplifier alignment point*. So, in the reverse path the amplifier compensates for loss characteristics in the cable in front of it.

This is why it is best to transmit the sweep from the amplifier test point and measure it in the headend. This ensures that the system is properly aligned to carry signals in the reverse path.

5.1.8 Interfacing With Different Network Architectures

Single Cable - Split Band Network

The Model 3ST Sweep Transmitter or Model 3HRV Headend Reverse Sweep Receiver is connected in the headend as shown in figure 1. The connections are similar to those made for forward sweep, with the transmitter output connected to the combining network. The difference is on the input to the 3ST/3HRV. The system signals along with the transmitted signals are tapped off and coupled together with the reverse signals using a splitter. This enables the 3ST/3HRV to receive both forward and reverse telemetry and sweep (3ST) signals.

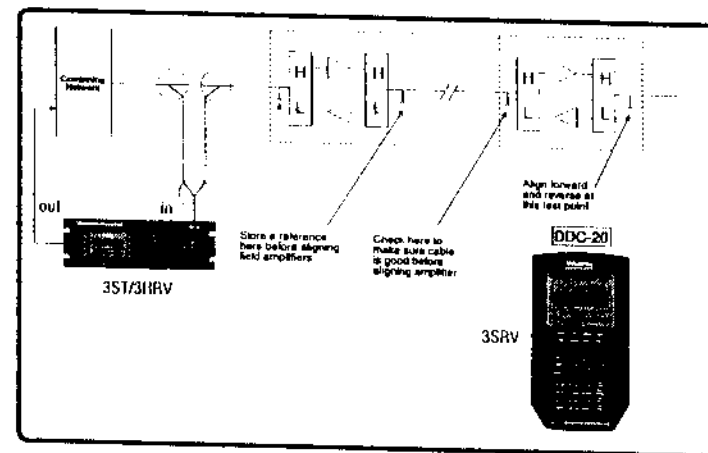

Figure 1. Single Cable – Split Band Network Reverse Sweep Configuration With Bi-Directional Test Points.

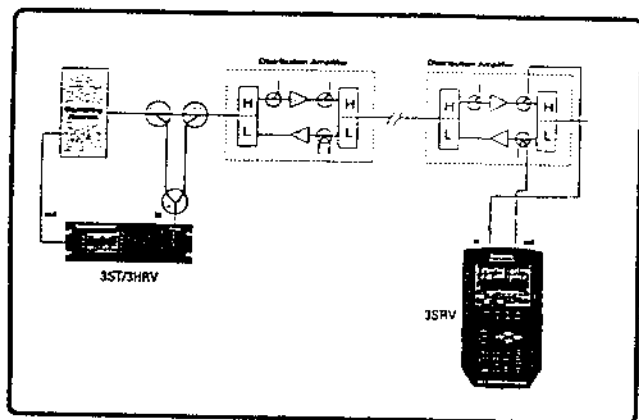

Figure 2. Single Cable - Split Band Network Reverse Sweep Configuration With Directional Test Points.

Another common architecture, which is only slightly different from those described above, prescribes the use of fiber optics to "nodes". In these architectures the installation of the transmitter in the headend is slightly modified, as shown in figure 3. Notice that a diplex filter is used on the input of the 3ST/3HRV. This provides optimal isolation between forward paths and minimal insertion loss. The connection at the node may be as shown in figure 4. Notice that in this configuration the forward and reverse test points are separated, and two directional couplers must be used. In all of these connection scenarios, either a summing network or two directional couplers are used to interface with the system test points. Care should be taken to use the same interface at each test point to ensure that the normalization process is cancelling out any response variation caused by the interface.

It is also important to remember not to make absolute level measurements through the summing network due to the insertion loss and frequency response characteristics of the interface.

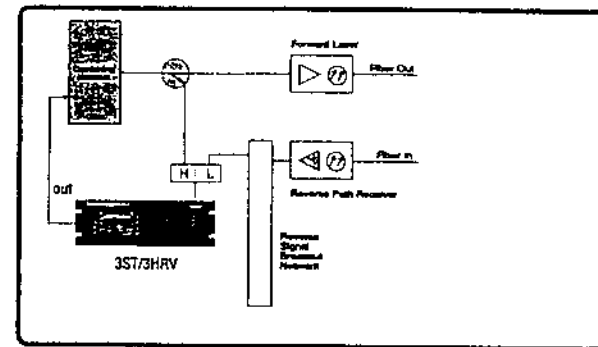

Figure 3. Transmitter Connections In Headend For Hybrid Fiber/Coax Networks

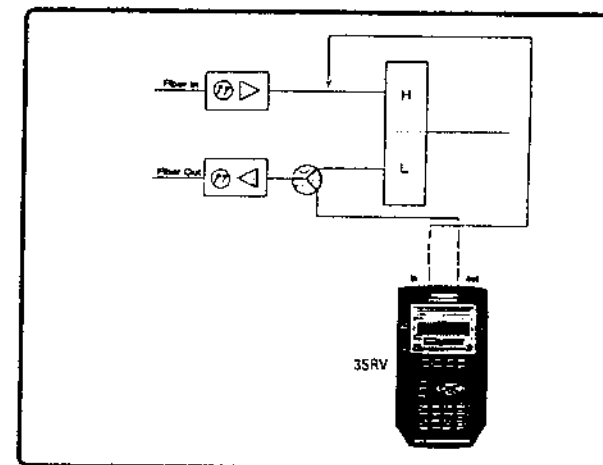

Figure 4. Fiber Node Test Point Connections

Dual Cable Network

Another possible, though rare, network configuration is the "Dual Cable Network", in which a full bandwidth is used for both forward and reverse - essentially two cable systems overlaying each other with signals carried in opposite directions. These networks are impossible to sweep simultaneously in both directions with one man.

The problem is that the two systems use the same spectrum, making it impossible to distinguish between the two with one instrument.

The recommended method for these systems is to first sweep the forward portion of the network, then move the transmitter out to the furthest extremity and sweep the reverse portion.

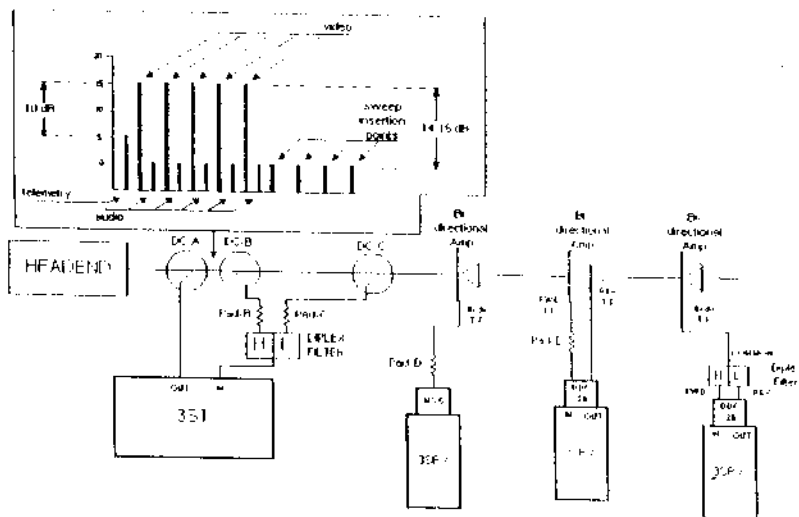

5.2 REVERSE SWEEP SETUP

If the frequency bands of the active services are known, the reverse channel plan can be built with a 250 kHz resolution. Then the active service frequencies can be quickly edited out. Alternatively, if there is any uncertainty about the frequency bands occupied by the active services, the Model 3ST or Model 3HRV reverse sweep receiver may be used to collect this information in the spectrum analyzer mode with a 50 MHz span and a center frequency of 30 MHz. A 'max-held' spectrum over an extended period can be analyzed to determine which frequencies in the reverse path contain active services so as to avoid interference.

The peak held spectrum scan shown in figure below is an example of a fully-loaded reverse band. Services carried include: telephony, data (cable modem), and PCS. One also sees a few CW signals at the high and low end of the band providing a consistent signal for the reverse laser. The spectrum scan is 45 MHz wide (5 to 50 MHz) or 4.5 MHz per division. A look at the spectrum indicates that these frequencies and bands should be omitted, namely : 6, 15-16.5, 18.5-20, 22.5-27.5, 29-30.5, 31-32.5, 33-36, 36.5-38, 40 and 41-42.5.

The best way to set up the Stealth reverse sweep channel plan is to build a plan with 250 kHz sweep insertion points from 5 to 45 MHz and then delete points that fall within the service frequencies. A close look at the peak held scan, using a marker, may indicate frequencies within the bands specified above for insertion points (34.5 MHz, for example).

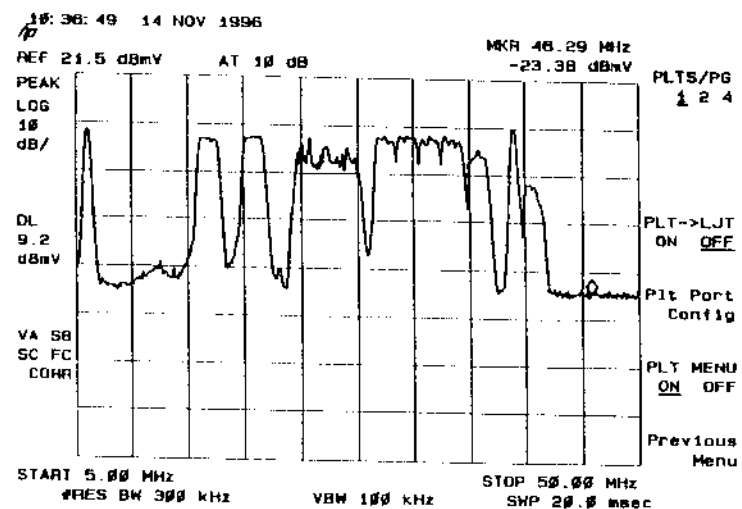

To setup the Reverse Sweep on the 3SR, press the **SETUP** key and select the "Sweep Receiver" option from the Setup menu. The Sweep Receiver setup screen will appear.

IMPORTANT: The 3SR must contain the Reverse Sweep Option to access the Reverse Sweep setup items.

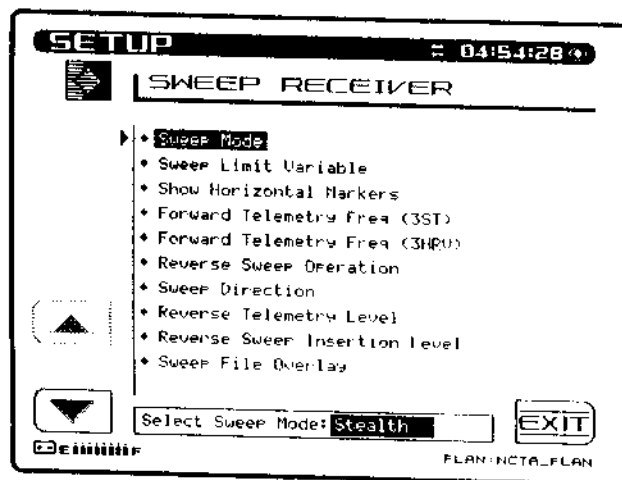

5.2.1 Reverse Sweep Insertion Level

The reverse sweep can be used to efficiently align the reverse path, while monitoring the frequency response. Proper alignment requires a reference that is relevant to typical sweep insertion point losses. A common practice is to store the reference when reverse sweeping from the node (active containing reverse laser). As the technician proceeds downstream from node to amplifier to amplifier, changes in insertion point losses may be compensated by changing either the output level or test point compensation. The active component (reverse laser or reverse amplifier) typically specifies the optimum input level for the device in terms of an analog video carrier level measured with a 300 kHz resolution bandwidth. Just as the sweep is inserted at a lower level in the forward path (for a discussion of this, see 3ST Transmitter Installation, page 5-13), the reverse sweep may also be inserted at a lower level. The target for the return level signal arriving at the passive device should be approximately 10 dB below the optimum input level specified by the manufacturer. This makes it even less likely that the sweep signal will interfere with the digital services in the reverse band.

From the manufacturer's specifications for the active device, deter-

mine the desired input level. For the sweep to arrive at the active device input 10 dB below the level of other services in the reverse spectrum, subtract 10 dB. Next, add the passive losses within the amplifier, including any internal splitting, the reverse sweep insertion test point loss, and/or any probe loss. The result gives the proper output level setting for the 3SR. For example, let us say that the return manufacturer specifies an input level of 20 dBmV (assuming 4 analog video channels). Subtract 10 dB to get 10 dBmV for the sweep input level to the amplifier. The path loss from the Model 3SR to the input of the return amplifier equals -3.5 (splitter to enable transmission of reverse sweep and reception of forward telemetry) -30 (test point) -1.5 (duplex filter) -3.5 (internal coupler for bridged ports). This gives $10 \text{ dBmV} + 3.5 \text{ dB} + 30 \text{ dB} + 1.5 \text{ dB} + 3.5 \text{ dB}$ for a sum of 48.5 dBmV for reverse sweep output level.

An alternative method for determining the optimum reverse sweep output level is to observe the reverse spectrum at the headend reverse sweep receiver (Model 3ST or 3HRV). The spectrum should be 'max held' for an extended period (one half hour or more), then printed or uploaded to a PC using StealthWare™. This will identify the active digital service frequencies and their level as they arrive at the headend reverse sweep receiver. Next, a CW signal at an unoccupied frequency is injected at the node sweep insertion point. The level is adjusted and monitored by the technician in the headend until it is 10 dB lower than the digital services as displayed on the 'max held' spectrum. The attenuator setting is subtracted from +50 dBmV to obtain the proper reverse output level.

5.2.2 Generating a CW Test Signal

The 3SR may be configured to generate a CW signal for diagnostic purposes. Proceed as follows:

NOTE: The unit must be in **General setup mode**.

1. Cursor down to Diagnostics.
2. Press Enter and cursor down to Transmitter Diagnostics.

- 3. Press Enter and highlight Transmitter On/Off.
- 4. Press Up or Down diamond key so ON appears in Edit box.
- 5. Highlight Transmitter Attenuator (0 dB corresponds to maximum output level (+50 dBmV on newer 3SR).
- 6. Determine the output level by subtracting the attenuator setting from +50 dBmV.
- 7. Highlight Transmitter Frequency and enter desired frequency.

5.2.3 Forward Telemetry Frequency (3ST)

Use the UP and DOWN arrow keys or the numeric keypad to enter the forward telemetry frequency corresponding to the 3ST.

NOTE: For successful Stealth mode operation, the Rx telemetry frequency must match the Tx telemetry frequency setting of the Model 3ST Transmitter.

Caution: Do not place the telemetry signal too close to the duplex filter cut-off frequency in that roll-off may attenuate the telemetry signal to the degree that communication fails. This same caution applies to placing the signal in the high end roll-off region.

5.2.4 Forward Telemetry Frequency (3HRV)

Use the UP and DOWN arrow keys or the numeric keypad to enter the forward telemetry frequency corresponding to the 3HRV.

NOTE: For successful operation, the 3SRV telemetry frequency must match the forward telemetry frequency setting of the Model 3HRV.

Important: To prevent the 3HRV reverse sweep from contending with the 3ST, disable the 3ST's reverse sweep. This will speed up the 3ST's forward sweep. Multi-user contention can also be eliminated by offsetting reverse channel plans, and by using different telemetry frequencies.

5.2.5 Reverse Sweep Operation (3SRV Models in Stealth mode only)

Select "Single User" for reverse operations associated with a 3ST. Select "Multiple Users" for reverse operations associated with a 3HRV. In Multi-user reverse mode the remote Stealth will display the reverse noise (or ingress at the headend).

5.2.8 Select Sweep Direction

There are two possible sweep directions on units with the Reverse Sweep Option; Forward and Reverse. Use the edit box to select the desired direction, and press the **ENTER** key.

Note: When sweeping, the direction may be changed by simply pressing the left arrow key for reverse, or the right arrow key for forward sweeping.

If the 3SRV is setup for multiple user operation with a 3HRV, reverse sweeping is performed with the 3HRV, forward sweeping is performed with the 3ST.

5.2.7 Adjust the Reverse Telemetry Level

This is the level of the carrier that the 3SR uses to transmit telemetry data. Use the edit box to set the Reverse Telemetry Level to an appropriate value. When adjusting the Reverse Telemetry Level, take into consideration the following losses; system, summing network, test point, and amplifier desired input.

NOTE: The frequency of the reverse telemetry carrier is set on the 3ST/3HRV. There is no adjustment for the Reverse Telemetry Frequency on the 3SR.

5.2.8 Adjust the Reverse Sweep Insertion Level

This is the level at which the 3SR inserts (transmits) sweep points. All sweep points are inserted at the same level. Use the edit box to set the Reverse Sweep Insertion Level to an appropriate value (This will typically be at maximum (+50 dBmV) to overcome test point loss.).

NOTE: The frequencies at which the sweep points are inserted are defined in the Reverse Sweep Plan which is set on the 3ST/3HRV. The frequency of the sweep points cannot be adjusted on the 3SR.

5.8 INSTALLATION OF 3ST SWEEP TRANSMITTER

Properly connecting the 3ST and setting up the proper levels are perhaps the two most critical steps in installing the Stealth Sweep System. Improper 3ST connections or incorrect levels on either the input or the output can result in the 3SR giving erroneous or inconsistent results. A simple and common method of connecting the 3ST in the system at the headend works for both forward and reverse sweeping.

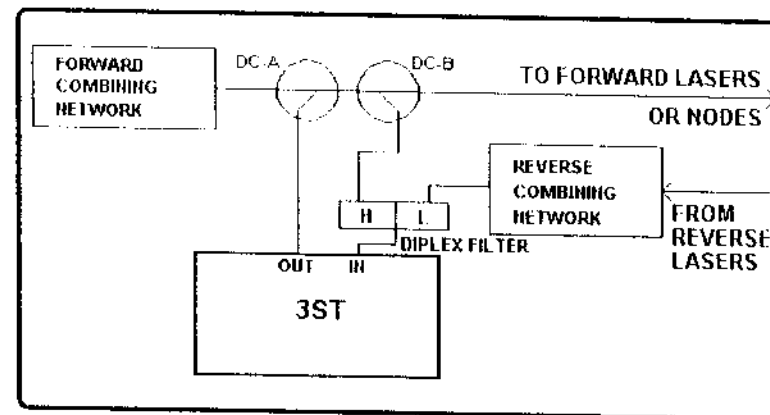

In the Sweep mode, the 3ST should never see video or carrier levels above +12 dBmV on its input. The forward sweep points being inserted into the system by the 3ST should be 14 to 16 dB below the video carrier levels at the 3ST input. The forward telemetry signal generated by the 3ST should be 4 dB higher than the sweep insertion points, or 10 dB below the video carrier levels. Figure on page 5-14 shows a graphical display of the relationship of the system's video carriers, the sweep insertion points, and the forward telemetry signal. When sweeping, this relationship can be observed on the 3ST display except for telemetry, which can not be seen.

To begin, select a value for DC-B. This allows the video carriers to 'hit' the 3ST somewhere in the $+10$ dBmV range. Additional attenuation can be achieved by using an in-line pad on the high side of the diplex filter. DC-A is the directional coupler used for inserting the forward telemetry signal and the sweep insertion points into the system from the 3ST. By selecting the proper value for DC-A and adjusting the forward telemetry level and forward sweep insertion point levels in the 'Sweep Transmitter' portion of the 3ST's Setup menu, one can achieve the correct relationship between the 3ST output signals (telemetry and sweep points) and the video carriers of the system.

When sweeping reverse using only the 3ST in the headend, the level of the telemetry (the telemetry coming back from the 3SRV) needs to 'hit' the input of the 3ST at 0 dBmV ± 10 dB. This can be easily verified by checking the telemetry level in the lower right corner of the lower right corner of the 3SRV display. Again, if additional attenuation is required, an in-line pad on the low side of the diplex filter may be used. If multiple nodes are being combined, a pre-amplifier may be required. The reverse telemetry signal needs to have a $C/N > 20$ dB (4.2 measurement bandwidth), which effectively limits the number of return nodes that can be combined on the input of the 3ST. The diplex filter is used instead of a splitter because of better isolation and impedance matching.

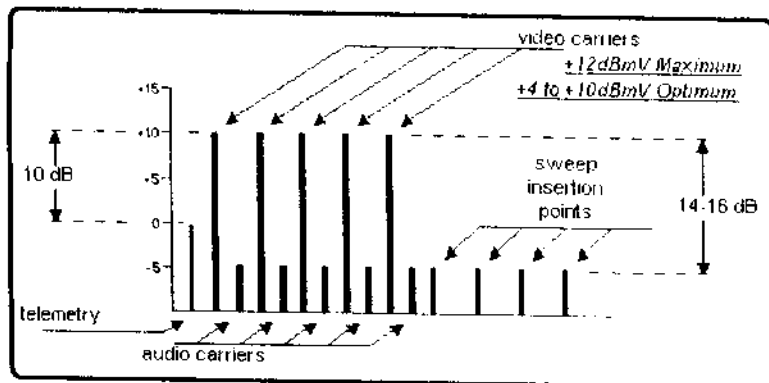

5.4 FIELD TEST POINT CONSIDERATIONS

The same basic rules apply to the 3SR/3SRV. Too much signal level on the input of the unit can cause inconsistent sweep readings. The forward telemetry level should be 0 dBmV ± 12 dB on the input of the 3SR. This again can be verified by checking the lower right corner of the 3SR/3SRV display while sweeping forward. In-line pads provide a quick way to reduce signal level on the 3SR/3SRV input. Figure below shows methods of connecting to amplifiers that have either a single bi-directional or two-directional test points.

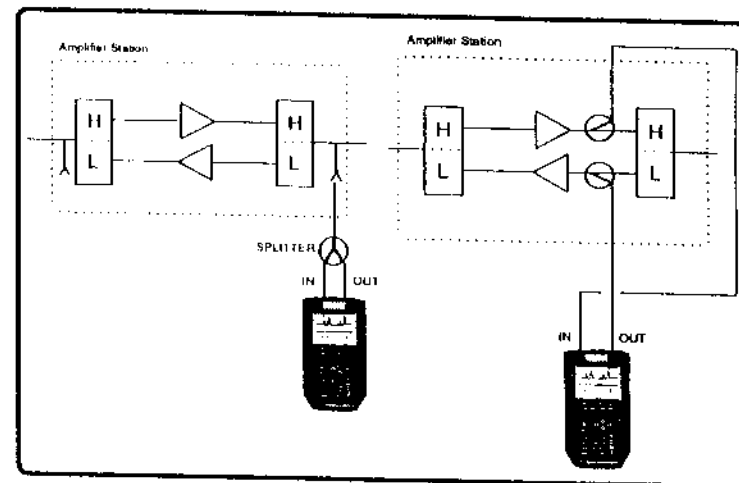

5.5 INSTALLATION OF MODEL 3HRV-- MULTI-USER REVERSE SWEEP TESTING

While adding a 3HRV to the system, a few things need to be remembered. The 3HRV has its own telemetry signal. This must be set at a different frequency from that of the forward telemetry signal in the 3ST, if both units are being used. Both telemetry frequencies must be entered in the 3SRV. If you do not have places to enter both



the forward telemetry frequency from the 3HRV and the forward telemetry frequency from the 3ST, your receiver does not have the proper version of firmware (8.3 or above) to function with the 3HRV. The 3SRV must also be set to the 'multiple user' mode even if only one of the allowed ten persons is sweeping. If you do not have the proper firmware version, call Wavetek Technical Support for upgrade instructions. The level of the forward telemetry signal is again very critical. Proper telemetry level can be achieved by inserting the signal from the 3HRV into your system using the same method and level settings as for the 3ST. In figure below, DC-A and DC-C have the same value, as also the forward telemetry levels from the 3ST and the 3HRV. As with the 3ST, the reverse telemetry level at the input of 3HRV should be 0 dBmV ±10 dB. You must also rebuild your reverse channel plan in 3HRV and, if you wish, you can disable the reverse sweep feature of the 3ST. This will speed up the forward sweep somewhat.

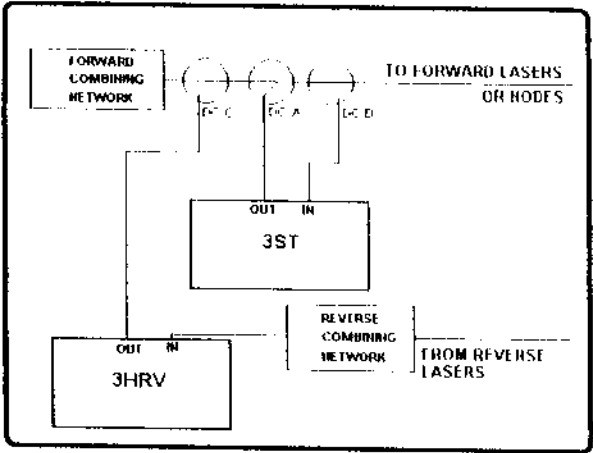

The above guidelines are quite general and your system may require a slightly different hook-up. However, the levels mentioned are extremely critical and should be met to ensure proper functioning of your Stealth Sweep System.

5.6 REVERSE INGRESS FEATURE

With a model 3SR with 3SRV option, the operator may at any time request a view of the headend reverse path ingress spectrum as seen at the headend by simply pressing the 'Ingress' soft key. If the reverse telemetry is not received by the headend unit (Model 3ST or 3HRV), the operator will be given the option to retry, or to switch to the reverse ingress mode to observe a full spectrum display of the reverse path ingress as seen in the headend.

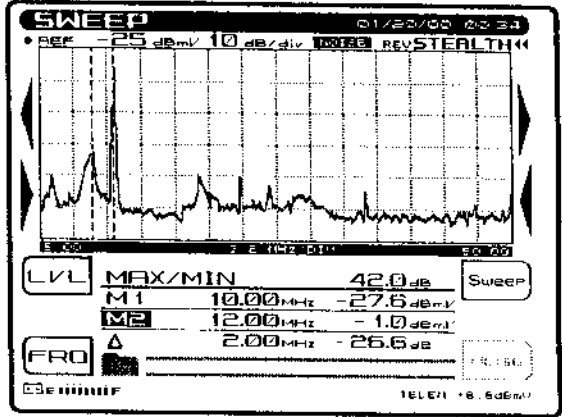

5.7 REVERSE SWEEP OPERATION

All softkeys and controls work identically whether you are Forward or Reverse sweeping.

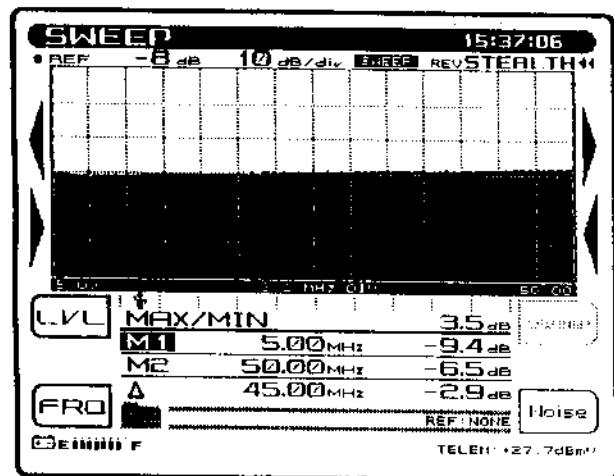

The icons at the bottom of the sweep graph are displayed in the multiple user mode when reverse sweeping with a 3HRV. Up to 10 technicians can sweep the reverse path simultaneously.

5.7.1 Sweep Direction Indicator

The sweep direction is indicated in the upper right hand corner of the Sweep screen. The letters FWD represents forward sweep while REV denotes reverse sweep. The two small arrows also indicate the sweep direction. When the arrows point to the right, a forward sweep is being performed and when they point left, a reverse sweep is occurring.

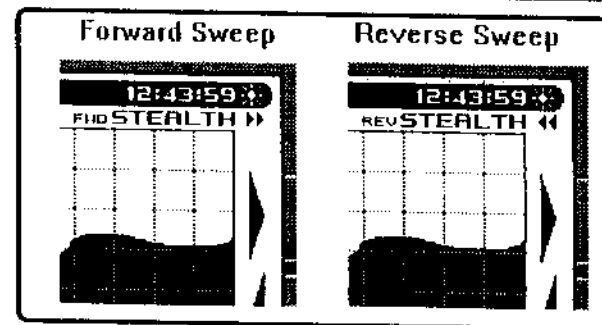

5.7.2 Changing the Sweep Direction

The sweep direction can be selected using the "Sweep Receiver" setup screen as described earlier. You can also change directions while you are viewing the Sweep response using the left and right arrows. Press the left arrow to select Reverse and the right arrow to select Forward.

5.7.3 Reverse Noise Feature

There are two key requirements to ensure proper operation of the reverse path. One is that the amplifiers be properly aligned to ensure that the digital signals are not clipped or compressed. This alignment is performed using the reverse sweep procedure. The other requirement is that a proper carrier-to-noise and carrier-to-ingress ratio be maintained. The Reverse Noise feature enables a quick swept noise test at the reverse sweep point frequencies. Simply press the "Noise" soft key while sweeping reverse, and the display will change to a noise response indicating the noise level at the same frequencies. This provides for simple, comprehensive testing of both amplifier alignment and reverse noise in the headend.

5.7.4 Telemetry Level Indicator

The level of the telemetry carrier is displayed in the lower right hand corner of the sweep screen. This is the Forward telemetry carrier level during a forward sweep, and the Reverse telemetry carrier level during a reverse sweep. The unit in which this is displayed depends upon what has been selected in setup.

5.7.5 Forward and Reverse Sweep References

Reverse sweep references are stored and selected the same as Forward references. When selecting a reference, the type of sweep in which the reference was stored can be seen in the Type column located in the Sweep References directory. The following table shows how the type of reference corresponds with the mnemonic found in the Type column:

FDSWP	Forward Sweep Reference
RVSWP	Reverse Sweep Reference
SWPLS	Sweepless Sweep Reference

The correct type of reference must be selected. For example, a reverse reference cannot be used while forward sweeping. An error message will result upon entering the Sweep screen if the type of reference selected does not match the type of sweep being performed. The reference will then default to "None".

IMPORTANT: To use a reference, its type must match the type of sweep currently being performed.

When the sweep direction is changed, the reference will automatically change to what was previously selected for that particular direction. This ensures that the reference type matches the sweep direction.

5.7.6 Storing and Viewing Reverse Sweep Files

Like Forward sweep responses, Reverse sweep responses can be stored and viewed. You can tell what type of sweep response a file contains by looking at the Type column located in the Measurement Files directory. The following table shows how the type of sweep response corresponds with the mnemonic found in the Type column:

FDSWP	Forward Sweep File
RVSWP	Reverse Sweep File
SWPLS	Sweepless Sweep File

When viewing a file, the type of sweep response is indicated in the upper right corner of the screen.

5.7.7 Recognizing 3SR in Reverse Sweep Option

You can tell if a 3SR has the Reverse Sweep option by looking at the status screen.

NOTE: To view the status screen without turning the unit off and on, press FCN+CHN to select the Status screen.

The status screen below is from a 3SR that contains the Reverse Sweep option. Notice in the options box - Reverse Sweep.

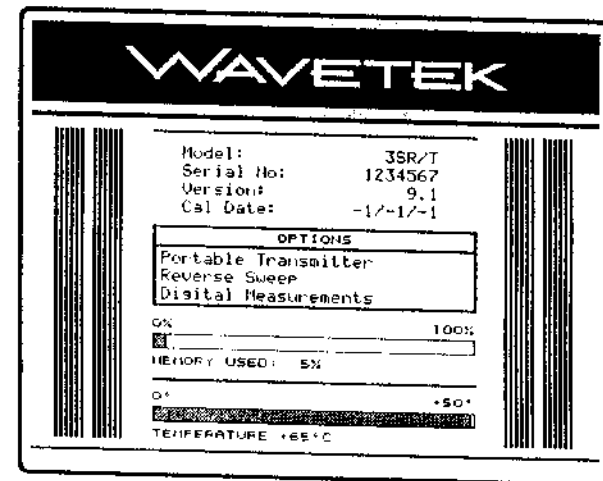

5.8 CPD (Common Path Distortion) ANALYSIS

Test Equipment / Procedure Recommendations

Description of CPD and Causes

CPD (Common Path Distortion) is a form of intermodulation distortion that occurs as the RF spectrum is mixed while passing through a non-linear junction. This phenomenon results in beats that appear in the reverse spectrum and impair communication (see figure 5).

CPD has a variety of causes, including corrosion at a dissimilar metals interface, bad solder connections, and even loose hold-down screws on amplifier modules or mother boards. The following quotes from the SCIE-List (used by permission of the authors) provide some practical insight into causes and methods for combating CPD.

"Other distortion-generating mechanisms include the use of feed-through connectors and cable with copper-clad aluminum center conductor. When an active or passive device's seizing screw cuts through the cable's center conductor and penetrates the copper, the screw will make contact with the aluminum. The result can be a dissimilar metals interface (depending on the composition of the seizing screw) that may create a diode effect. This is a good case for using only pin connectors in the RF distribution plant.

One possible cause of distortion in the reverse path that is not well understood may be related to the isolation (or lack thereof) between the downstream amplifier module output and the reverse amplifier module input in the same housing. Considering the high feeder levels now available with Mini Bridgers, DAs, and similar multi-output feeder amps, it is possible that the isolation in the diplex filter may be insufficient, particularly when single-ended circuitry is used in the reverse amp module. This would result in the downstream spectrum being present at the reverse module input, albeit at a fairly low level, but which may be enough to cause beats to be generated in the reverse amp."¹

"My experiences with CPD have been due to corrosion or oxidation on connections. So, one thing that should indicate that you are

getting close is the white powder that is a symptom of oxidation of aluminum housings; often aluminum darkens when oxidation is taking place. These instances can be due to port caps left off, missing gaskets or gaskets which have slipped out of their channel, warped or cracked housings or cracked or broken connectors. Seals have to be air-tight, otherwise, normal heating/cooling cycles can bring in moist air which dumps its moisture when the temperature cools. One of the symptoms associated with CPD is hum in the signal. This is due to the semi-conductor properties of some of the junk which forms when connections oxidize.

CPD can also be a symptom when coax experiences annular cracks (although usually the ingress is more noticeable than the CPD).

Technicians need to be able to associate seemingly "unconnected" symptoms. For example, someone notices a minor amount of hum in the picture of a customer; two blocks away error rates start going up on a data modem or DMX box. Somewhere in the area you find a connector cracked at the housing entry which has allowed moisture entry and oxidation to occur. Note that this can and does happen to F connectors in homes or institutions.

To solve such problems, the source of the moisture ingress needs to be found and removed, the moisture removed and the oxidation or corrosion removed. It's likely to be cheaper, easier and faster to remove and replace an entire device (tap, directional coupler or amplifier) than to determine and fix the cause of the moisture ingress. If a bad F connector is found, it is good practice to also replace the device to which the F connector was attached. In the case of F connectors, relocation of equipment to be out of the path of water and/or use of higher cost F connectors with better water seals is recommended (it's silly to save 25 cents on an F connector and generate a 50 dollar trouble call)."²

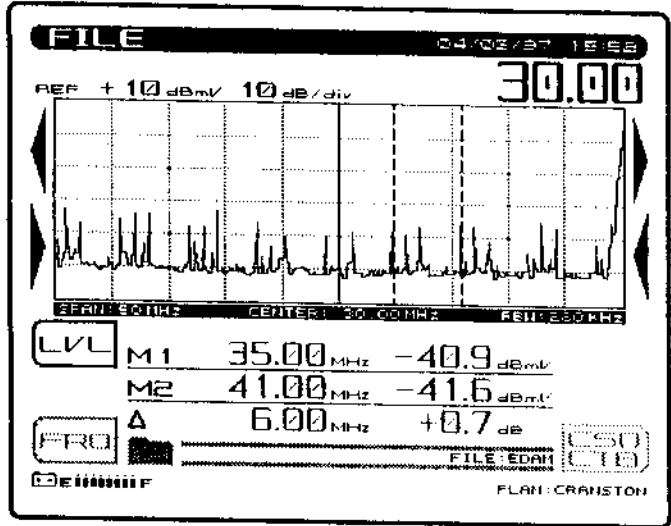

Common path distortion appears as beats at regular intervals

Recommended Setup for CPD Analysis

If the test point is not band-limited to the reverse spectrum (i.e. on the low band side of a duplex filter) a low pass filter may be needed to eliminate the possibility of instrument related intermodulation products that mimic CPD. The susceptibility to intermodulation is dependent on the total number of carriers present on the input to the instrument. The measurement technique is similar to using a band pass filter for intermodulation tests (composite second/third order). The objective is to avoid bombarding the RF input of the instrument with a large number of relatively high level signals (typically 78 channels in a 550 MHz system), while looking for low level signals. The problem is that when attenuation is removed to see the low level beats more clearly, the front end of the instrument may be overloaded with the high level signals on the same test point, and generate beats of its own.

A low pass filter may be needed (see figure 2) when connecting the instrument to a bi-directional amplifier test point – a test point with both forward and reverse signals present. This phenomenon may

present itself when performing a reverse noise test using the Stealth Model 3ST transmitter. To minimize the likelihood of this occurring, the transmitter should be configured such that the video signal input level is at approximately 0 dBmV. In the event that instrument-related intermodulation occurs, the reverse channel plan may be set up such that the frequencies at which the intermod products appear are not included. Unfortunately this eliminates the ability to monitor the headend for CPD from a field test point. Alternatively, a Stealth Model 3HRV can be used. This instrument is used for reverse testing only, and as no forward signals are present on its input, it is not susceptible to this phenomenon.

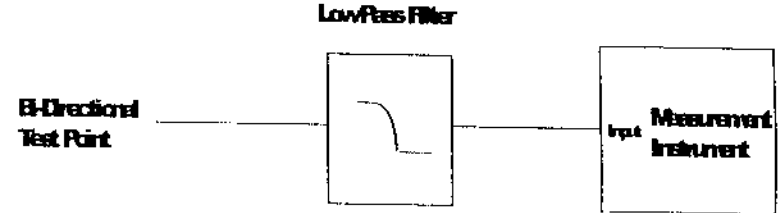

Low pass filter recommended for use in CPD analysis

¹ Ron Hranac, Coaxial International, (Rhranac@aol.com)







² David Devercaux-Weber, University of Wisconsin - Madison, djdevere@facstaff.wisc.edu







APPENDIX A STATUS INDICATORS/ICONS

INTRODUCTION

There are numerous status indicators/icons displayed on the Stealth 3SR. The following is a list of all status indicators/icons and an explanation of each. The status indicators are displayed in the title bar as shown in the example below.



-  = unlocked
-  = low battery
- FCN = function key pressed
-  = alpha entry mode
-  = numeric entry mode
-  = arrow key selection mode
-  = backlight on (manual operation)
-  = backlight on (auto operation)

-  - Video Carrier
-  - Audio Carrier
-  - Single Carrier
-  - DUAL Carrier
-  - Band Pass Filter (Hum screen)
-  - Low Pass Filter (Hum screen)
-  - Noise (C/N screen)

APPENDIX B USER MESSAGES

INTRODUCTION

There are numerous user messages that will appear on the unit. Some messages can be caused by improper operation or unit malfunction. The following list provides an explanation of the condition that caused the message to appear, followed by the suggested response:

Message	ERROR... No STEALTH telemetry!
Condition	No telemetry established between Transmitter and Receiver
Response	Check connection and ensure telemetry frequencies are matched.
Message	SORRY... The selected reference cannot be used!
Condition	The channel plan has been changed or a different channel plan has been selected since storing the reference.
Response	Delete the incompatible reference and select another or store a new reference.
Message	ERROR... The synthesizer has become unlocked!
Condition	The PLL synthesizer has become unlocked.
Response	Indicates a problem with the circuitry, service is required.
Message	ERROR... The noise frequency is out of range!
Condition	The noise offset frequency plus the carrier frequency exceeds the range of the unit.
Response	Choose a smaller noise offset frequency value.



Message **ERROR... Insufficient signal level to perform the measurement!**
 Condition A minimum carrier level is required for C/N and HUM measurements.
 Response Choose another channel or frequency with greater than the minimum level.

Message **SORRY... This is an illegal name and cannot be used.**
 Condition An illegal name has been entered.
 Response Choose another name.

Message **WARNING...A reference with this name already exists. Overwrite?**
 Condition A reference with the same name currently exists.
 Response Overwrite the existing reference or choose another name.

Message **SORRY... This is an invalid name. Please try again.**
 Condition An invalid name has been entered.
 Response The name must contain at least one character.

Message **SORRY... There is not enough memory to store a new reference!**
 Condition Memory is currently at maximum capacity.
 Response Delete unwanted files to make more memory available.

Message **WARNING... The selected reference will be deleted!**
 Condition A reference file is about to be deleted.
 Response Press OK to delete.

Message **ERROR... The selected reference has been corrupted!**
 Condition The reference cannot be used because of a non-volatile memory failure.
 Response Delete the corrupted reference and select another.

Message **SORRY... Not enough sweeps have occurred to store an accurate reference. Please allow more time in SWEEP.**
 Condition An attempt to store a reference without sufficient sweeps.
 Response Allow more time in Sweep Mode.

Message **ERROR... A system error has occurred!**
 Condition A system error has been detected.
 Response Restart the unit and try again.

Message **ERROR... There is no response from the printer!**
 Condition The printer is not responding to the unit.
 Response Check printer connection and compatibility.

Message **SORRY... There is nothing to print! Please select a measurement mode before attempting to print.**
 Condition An attempt to print was made without being in a measurement mode.
 Response Choose a measurement mode.

Message **WARNING... A sweep file with this name already exists. Overwrite?**
 Condition A sweep file with the same name currently exists.
 Response Overwrite or choose another name.

Message **SORRY... There is not enough memory to store a new file!**
 Condition Memory is currently at maximum capacity.
 Response Delete unwanted files to make more memory available.

Message **WARNING... The selected sweep file will be deleted!**
 Condition A sweep file is about to be deleted.
 Response Press OK to delete.

Message **ERROR... The selected sweep file has been corrupted!**
 Condition The file cannot be used because of a non-volatile memory failure.
 Response Delete the corrupted file and select another sweep file.

Message **ERROR... A system error has occurred! Please select another mode.**
 Condition A system error has been detected.
 Response Select another measurement mode or restart the unit and try again.

Message **ERROR... At least two tilt channels must be programmed and enabled! Please select another mode.**
 Condition Tilt mode is selected with less than two tilt channels programmed.
 Response Edit channel plan to program at least two tilt channels.

Message **WARNING... The selected plan will be deleted.**
 Condition A channel plan is about to be deleted.
 Response Press OK to delete, STOP to cancel.

Message **SORRY... The active plan cannot be deleted!**
 Condition An attempt to delete the active channel plan.
 Response Select a different plan as the active plan, then delete the desired plan.

Message **ERROR... This plan is corrupted and cannot be used!**
 Condition The plan cannot be used because of a non-volatile memory failure.
 Response Delete the plan and then choose another.

Message **WARNING... A plan with this name already exists. Overwrite?**
 Condition A channel plan with the same name currently exists.
 Response Overwrite or choose another name.

Message **SORRY...This is the name of a fixed plan and cannot be used.**
 Condition An attempt was made to name a channel plan with the name of a fixed plan.
 Response Choose another name.

Message **ERROR... The stop frequency has been set too low.**
 Condition The stop frequency has been set below the lowest channel in the selected fixed plan.
 Response Enter a higher stop frequency.

Message **SORRY... This cannot be completed due to a system error.**
 Condition A system error was detected.
 Response Restart the unit and try again.

Message **WARNING... This channel will be deleted!**
 Condition A channel is about to be deleted.
 Response Press OK to delete, STOP to cancel.

Message **SORRY... The last channel cannot be deleted!**
Condition An attempt was made to delete the last channel of a plan.
Response A channel plan must contain at least one channel. If desired, delete the entire plan.

Message **WARNING... This operation cannot be undone!**
Condition An operation has been selected that will make permanent changes to a stored file.
Response Press OK to execute, STOP to cancel.

Message **SORRY... There is not enough memory to store the new plan!**
Condition Memory is currently at maximum capacity.
Response Delete unwanted files to make more memory available.

Message **WARNING... There is not enough memory to save the changes!**
Condition Memory is currently at maximum capacity.
Response Delete unwanted files to make more memory available.

Message **SORRY... Some channels may not have been converted due to a system error.**
Condition A system error was detected.
Response Restart the unit and try again.

Message **WARNING... All files and stored settings will be lost!**
Condition The unit is being reset to the factory default settings.
Response Press OK to reset settings, STOP to cancel.

Message **ERROR... C/N cannot be measured on a scrambled channel!**
Condition A channel that has been programmed as scrambled in setup has been selected in C/N mode.
Response Select a channel that is not scrambled. C/N measurements are not possible on a scrambled channel.

Message **ERROR... Hum cannot be measured on a scrambled channel!**
Condition A channel that has been programmed as scrambled in setup has been selected in Hum mode.
Response Select a channel that is not scrambled. Hum measurements are not possible on a scrambled channel.

Message **SORRY... No more tilt channels can be programmed.**
Condition The maximum number of tilt channels has been reached.
Response To program another tilt channel, an existing tilt channel must be reprogrammed as a non-tilt channel.