

DominoFE

Interface Guide

Domino Internetwork Analyzer

BN 9316/96.04



WAVETEK
WANDEL
GOLTERMANN

Communications Test Solutions

© 2000 Wavetek Wandel Goltermann. All rights reserved.

Microsoft® and Windows® are registered trademarks of Microsoft Corporation.

2000.Net_Check, DominoFastEthernet, DominoHSSI, DominoPLUS, DominoREMOTE, DominoServer, Examine, LinkView, LinkView PRO, Mentor, NetForce, NetForce Ranger, and Wizard are trademarks of Wandel & Goltermann Technologies, Inc.

ATMSim, DA-30C, Domino, DominoATM, DominoFDDI, DominoGigabit, DominoLAN, DominoWAN, DominoWIZARD, Internetworking, RTBench, STBench, are registered trademarks of Wandel & Goltermann Technologies, Inc.

All other trademarks and/or registered trademarks mentioned in this document are the property of their respective owners.

"The parallel port technology within this product is licensed under U.S. Patent 5,299,314."

Notice

Specifications and functions described in this document are subject to change without notice.

Revision History

September 2000 Revision 3, PN 9316-8496.042

Printed in the USA on recycled paper.

Contents

Preface	v
About This Book.....	v
Document Conventions.....	v
Related Publications.....	vii
Customer Support.....	viii
1. Introduction to the DominoFE Analyzer	1-1
1.1. DominoFE Analyzer Features.....	1-1
1.2. DominoFE Analyzer Components.....	1-2
1.2.1. DominoFastEthernet DA-350 Internetwork Analyzer.....	1-2
1.2.2. DominoFE DA-362 Internetwork Analyzer.....	1-2
1.3. Important Safety Instructions.....	1-3
1.3.1. Power Supply.....	1-3
1.3.2. Safety Class.....	1-4
1.3.3. CE Mark Conformity.....	1-4
1.3.4. Clearance Requirements.....	1-7
1.4. EMC Information.....	1-7
1.5. Environmental Specifications.....	1-7
1.6. Cleaning the DominoFE Analyzer.....	1-8
2. Getting Started	2-1
2.1. Inspect the Parts.....	2-1
2.1.1. DominoFastEthernet DA-350 Internetwork Analyzer.....	2-1
2.1.2. DominoFE DA-362 Internetwork Analyzer.....	2-2
2.2. Read the Release Notes and Readme Help.....	2-2
2.3. Install the Software.....	2-3
2.4. Set Up the Domino Hardware.....	2-3
2.5. Connect the Network Cables.....	2-5
2.6. Power Up the Analyzer and Display the Workbench.....	2-6
2.7. Configure the Network Interface (optional).....	2-6
2.8. Monitor Network Traffic.....	2-8
2.9. Set Up Applications.....	2-8
2.10. Analyze Network Traffic.....	2-9
2.11. View the Results.....	2-9

3. Connecting to the Network	3-1
3.1. Rear Panel Connectors	3-1
3.1.1. DominoFastEthernet DA-350 Analyzer Rear Panel Connectors	3-1
3.1.2. DominoFE DA-362 Analyzer Rear Panel Connectors	3-3
3.2. Front Panel LED Indicators	3-5
3.2.1. DominoFastEthernet DA-350 Analyzer Front Panel	3-6
3.2.2. DominoFE DA-362 Analyzer Front Panel	3-8
3.3. Overview of Connecting to the Network	3-10
3.4. Connecting for Dual Monitoring	3-11
3.4.1. Connecting for Dual Monitoring—Example 1	3-13
3.4.2. Connecting for Dual Monitoring—Example 2	3-13
3.4.3. Connecting for Dual Monitoring—Example 3	3-14
3.4.4. Connecting for Dual Monitoring—Example 4	3-14
3.5. Connecting for Emulation	3-14
3.5.1. Connecting for MDI Emulation	3-15
3.5.2. Connecting for MDIX Emulation	3-16
3.5.3. Connecting for MII Emulation	3-17
4. Setting Up the DominoFE Interface	4-1
4.1. Main Setup Overview	4-1
4.2. Selecting the Connection Mode	4-2
4.3. Selecting the Network Speed	4-4
4.4. Selecting the Duplex Transmission Mode	4-4
4.5. Saving Setup Selections	4-5
5. Setting Up the DominoFE Interface Line	5-1
5.1. Line Setup Overview	5-1
5.2. Enabling the Transmit AutoPad Option	5-2
5.3. Enabling the Transmit Preamble Option	5-3
5.4. Enabling the Receive Group Address Option	5-4
5.5. Filtering Network Traffic by Frame Type	5-5
6. Filtering and Triggering	6-1
6.1. Working With Filters and Triggers	6-1
6.2. Setting Up Filtering and Triggering	6-3
6.2.1. Selecting the Filter Method	6-5
6.2.2. Setting Up the Post Trigger Capture	6-6
6.3. Creating a Filter/Trigger Definition	6-7
6.3.1. Defining a Filter/Trigger Using the Custom Setup Method	6-8
6.3.2. Defining a Filter/Trigger Using the Protocol Setup Method	6-12
6.4. Setting Up the Find Anywhere Filter/Trigger Definition	6-15
6.5. Naming or Renaming a Filter/Trigger Definition	6-16
6.6. Modifying a Filter/Trigger Definition	6-17
6.7. Saving Filter/Trigger Utility Selections	6-18
6.8. Canceling Filter/Trigger Utility Selections	6-19

6.9.	Managing the Filter/Trigger List	6-19
6.9.1.	Adding a New Definition to the Filter/Trigger List	6-20
6.9.2.	Copying a Definition to the Filter/Trigger List	6-20
6.9.3.	Deleting a Definition From the Filter/Trigger List	6-21
6.10.	Managing Filter/Trigger Files	6-21
6.10.1.	Opening a Filter/Trigger File	6-22
6.10.2.	Saving a Filter/Trigger File	6-22
6.10.3.	Importing a Filter/Trigger File	6-23
7.	Setting Up for Auto-Negotiation	7-1
7.1.	NWay Auto-Negotiation Overview	7-1
7.2.	Setting Up Auto-Negotiation Advertisement Options	7-2
8.	Transmitting Network Traffic	8-1
8.1.	Frame Transmission Overview	8-1
8.2.	Understanding the Transmit Buffer and Queue	8-2
8.3.	Setting Up the Analyzer to Transmit Frames	8-3
8.4.	Selecting Frames for Transmission	8-4
8.5.	Importing Capture Frames for Transmission	8-6
8.5.1.	Opening a Capture File	8-7
8.5.2.	Displaying Capture Frames	8-8
8.5.3.	Adding a Capture Frame to the Transmit List	8-9
8.5.4.	Deleting a Capture Frame From the Transmit List	8-10
8.6.	Creating a Transmit Frame	8-11
8.6.1.	Selecting the Frame Size	8-12
8.6.2.	Selecting a Fill Pattern	8-13
8.7.	Using the Frame Setup Wizard	8-14
8.7.1.	Setting Up the Source and Destination Address	8-15
8.7.2.	Setting Up the Length/Type	8-16
8.8.	Modifying a Transmit Frame	8-17
8.9.	Deleting a Transmit Frame	8-18
8.10.	Setting Up the Transmit Queue	8-18
8.10.1.	Adding a Frame to the Queue	8-20
8.10.2.	Inserting a Frame in the Queue	8-20
8.10.3.	Deleting a Frame From the Queue	8-21
8.10.4.	Editing a Queue Entry	8-22
8.11.	Setting Up the Transmit Method	8-28
8.12.	Setting Up the Transmit Mode	8-29
8.12.1.	Transmitting Frames by Percent Utilization	8-29
8.13.	Starting and Stopping Frame Transmission	8-30
8.14.	Transmitting Frames in Flood Mode	8-31
8.14.1.	Testing Maximum Network Load	8-32
8.15.	Saving the Transmission File	8-32
9.	Analyzing Network Traffic and Status	9-1
9.1.	Capturing Network Traffic	9-1
9.2.	Capturing Traffic to Your Computer's Disk	9-1

- 9.3. Limiting the Amount of Capture Data that is Saved to Disk 9-4
- 9.4. Examining Network Traffic 9-4
- 9.5. Monitoring Collisions 9-4
- 9.6. Monitoring Link Status 9-5
- 9.7. Monitoring Network Traffic 9-7
- 9.8. Monitoring Network Utilization 9-8
- 9.9. Using the LED Indicators to Determine Network Status 9-8
- 9.10. Viewing Network Traffic and Statistics 9-8
 - 9.10.1. Opening Results Windows 9-9
- 9.11. Results Window Descriptions 9-9
 - 9.11.1. Setting Up the Histogram Window 9-11
 - 9.11.2. Rebuilding the Events Window 9-17

Appendix: DominoFE Real Time Toolbar

Glossary

Index



Preface

Thank you for purchasing the DominoFastEthernet™ DA-350 Internetwork Analyzer or DominoFE DA-362 Internetwork Analyzer. The DominoFE analyzers are versatile, portable protocol analyzers that provide you with the ability to maintain 10 Mbps or 100 Mbps Ethernet networks and test equipment in those networks.

About This Book

This book provides an overview of the DominoFE Internetwork Analyzers and presents information on using the DominoFE interface for analyzing and transmitting network traffic on a Fast Ethernet network.

This book assumes that you are familiar with the basic terminology and procedures for using Microsoft® Windows™ 98, Windows NT, or Windows 2000. It also assumes that you have a basic understanding of personal computers, computer networks, and network protocols.

Document Conventions

The *DominoFE Interface Guide* uses some special keyboard reference and text conventions as well as symbols to indicate tips, notes, and cautions.



Keyboard Conventions

Convention	Description
Keys	All key names are shown as they appear on the laptop computer keyboard, for example, Ctrl, Esc, PgUp, and PgDn.
Key Combinations and Sequences	Keystroke combinations and sequences are used to invoke commands or perform operations. Key combinations are shown as Key+Key, for example, Shift+F1, which means to hold down the Shift key while pressing F1. Key sequences are shown as a comma-separated series, for example, Alt, F, A, which means to press and release each of these keys in order: first Alt, then F, then A.
Arrow Keys	The term "arrow keys" is the collective name for the Up Arrow, Down Arrow, Left Arrow, and Right Arrow keys.

Text Conventions

Convention	Description
Text That You Type	Specific text that you are to type is shown in boldface. For example, if the book says to type win you type the lowercase letters "win." What you type is always shown in lowercase letters, unless it must be typed in uppercase letters to work properly.
Filenames and Directories	Filenames and directories are shown in uppercase. For example, AUTOEXEC.BAT.
Nodenames and Programming Examples	Nodenames and programming examples are shown in Courier, a monospaced font, to more closely resemble their on-screen appearance. For example: <code>Smith.John</code>

Special Information

Convention	Description
	A tip conveys information on shortcuts or convenient procedures that are not required, but make tasks easier.
	A note conveys information, which if overlooked may seriously inconvenience you, but will not cause any permanent or unrecoverable errors.
	A caution message alerts you to the possibility of damage to the instrument. In some cases it describes the nature of the potential damage and provides steps to avoid the problem.

Related Publications

Documentation for operating the DominoFE internetwork analyzers is provided in the following publications:

Documentation	Description
DominoFE Interface Help	Provides detailed information about the DominoFE internetwork analyzers, including context-sensitive Help (available by pressing F1 or the Help button) for dialog boxes and results windows.
<i>DominoFE Interface Guide</i> (this manual)	Provides safety, connection, and setup information for the DominoFE Internetwork Analyzer. This document is available in both a printed version and in portable document format (.PDF) on the installation CD-ROM.

The following Domino publications also provide operating information and are available with the DominoFE analyzer packages:

<i>Domino Getting Started</i>	Introduces you to the Domino Internetwork Analyzer and its user interface, and provides the information that you need to set up one or more Dominos. This document is available in both a printed version and in portable document format (.PDF) on the installation CD-ROM.
<i>Domino Operating Guide</i>	Contains background information, procedures, and examples for using the Domino software. This document is available in both a printed version and in portable document format (.PDF) on the installation CD-ROM.
<i>DominoPLUS Installation Guide</i>	Contains information about installing the DominoPLUS hardware, which is applicable for the DominoFE DA-362 Internetwork Analyzer. This document is available in both a printed version and in portable document format (.PDF) on the installation CD-ROM.
Domino Core Readme Help	Provides the latest product information online, including a description of known problems and their workarounds when available.

Domino Core Release Note	Provides the latest product installation information, and other late-breaking information about the Domino Core software and related products. This document is available in hardcopy only.
Online Help	Provides detailed information about the Domino Core software, network interfaces, protocol software, and applications.

Customer Support

If you have a question about the DominoFE Internetwork Analyzer, refer to this manual, the online Help, the Release Note, or Readme Help.

To report a problem with Domino hardware or software, contact your local sales office.

When reporting a problem:

Be at your computer with the Domino analyzer running, and be prepared to provide the following information:

1. The name and version number of the Domino software that you are using.
2. The type and serial number of the WWG hardware that you are using.
3. The type of network hardware that you are using.
4. The specifications of the computer that you are using, including:
 - Make and model number
 - Processor speed
 - Amount of installed RAM
 - Available hard drive space
 - Operating system (Windows NT, Windows 98, or Windows 2000)
5. The exact wording of any messages that appeared on your screen.
6. What happened and what you were doing when the problem occurred.

Visit our Web site

For information on products, services and support, training, and how to contact your local sales office, visit WWG's Web site at:

www.wg.com

1. Introduction to the DominoFE Analyzer

This chapter provides an overview of the DominoFE Internetwork Analyzer features, a description of the DominoFE analyzer components, and extensive information about product safety, specifications, and the operational environment for the analyzer.

1.1. DominoFE Analyzer Features

The DominoFE Internetwork Analyzer provides the capability for monitoring, troubleshooting, emulation, and interconnect device testing on 10 or 100 Mbps Ethernet networks.

Key features of the DominoFE analyzer include:

- Full-duplex, full line-rate monitoring and real-time analysis of Fast Ethernet networks.
- Multiport synchronized analysis (with multiple Domino analyzers) for testing network devices.
- Full line-rate, real-time filters and triggers for received network frames that include network-level pattern matches for addressing and protocol filters. Frames can be filtered by frame type, addressing type (MAC, IP, or IPX), specific network addresses, and error condition. Custom filter setup is also provided.
- WG Mentor interactive expert analysis support.
- Link auto-negotiation status and testing, providing control of the DominoFE analyzer's advertised capabilities and monitoring of the results of link negotiation.
- Full line-rate frame transmission (and faster), with a frame setup wizard for Ethernet frame formats and addressing, including higher-level protocol encapsulation options.
- Over 100 statistics, including graphical presentations of network utilization, top station talkers, protocol distribution, frame rate, and frame size distribution.

1.2. DominoFE Analyzer Components

Two hardware models are available for the DominoFE Internetwork Analyzer:

- DominoFastEthernet DA-350 Internetwork Analyzer
- DominoFE DA-362 Internetwork Analyzer for DominoPLUS

1.2.1. DominoFastEthernet DA-350 Internetwork Analyzer

Your DominoFastEthernet DA-350 analyzer comes with the following required equipment:

- A DominoFastEthernet DA-350 Internetwork Analyzer hardware unit (9316/01)
- A Domino-to-PC cable (K9123) for connecting the analyzer to a personal computer
- A power cable, North American (K9139) or European (K9140)

1.2.2. DominoFE DA-362 Internetwork Analyzer

Your DominoFE DA-362 analyzer comes with the following equipment:

- A DominoPLUS chassis (9316/04), which can be ordered with the following modules pre-installed: 100Base-T FD interface module (9305/90.71) and 155 Mbps Broadband Analyzer Module (9305/90.69)
- A Domino-to-PC cable (K9123) for connecting the analyzer to a personal computer
- A power cable, North American (K9139) or European (K9140)
- DominoFE LED overlay (9316/90.31)

1.3. Important Safety Instructions

The DominoFE Internetwork Analyzer utilizes and connects to a variety of electrical energy levels and must therefore be operated by trained, qualified personnel to avoid property damage, serious injury, or death. To ensure this level of proficiency, operating personnel must:

- Read fully and understand the *Domino Getting Started* guide, the *DominoFE Interface Guide*, and the *DominoPLUS Installation Guide* (for the DA-362 analyzer model) before attempting to connect this equipment to any electrical power source.
- Be designated as a qualified user by their employer.



- The DominoFastEthernet DA-350 Internetwork Analyzer has no serviceable parts.
- Both models of the DominoFE analyzer must be used only for their intended purpose.

1.3.1. Power Supply

The DominoFE analyzers have an internal autoranging power supply that automatically adjusts to input voltage within the range 100-240 volts AC.

The DominoFE analyzers do not have a power on/off switch. The IEC AC power inlet must remain readily accessible.



The device has universal input and accepts an input range of 100 to 240 VAC 50/60 HZ, 150 VA. Do not connect the unit to a power source that exceeds the voltage rating of the unit.

1.3.2. Safety Class

The DominoFE analyzers (BN 9316/01 or BN 9316/04) meet the following safety specifications:

- CAN/CSA No. C22.2 1010.1-92
- UL 3111-1
- EN-61010-1
- IEC-1010-1

For additional safety information, see the *Domino Getting Started* guide and the *DominoPLUS Installation Guide* (for the DA-362 analyzer).

1.3.3. CE Mark Conformity

The DominoFE analyzers conform with the requirements of the European EMC Directive (89/336/EEC) as amended by Directive 92/31/EEC and 93/68/EEC.

The following European standards apply:

- EN 55 022 (1994) (CISPR 22): Limits and methods of measurement of radio disturbance characteristics of Information Technology Equipment.
- EN 50 082-1: Electromagnetic Compatibility - Generic Immunity Standard part 1: Residential, commercial, and light industry.

In addition, this instrument complies with the requirements of the Low Voltage Directive (73/23/EEC) as amended by Directive 93/68/EEC, applying one of the following European standards:

- EN 61010-1 (IEC1010-1): Safety regulations for electrical measuring, control and laboratory instruments: Part 1: general requirements.
- EN 950 (IEC 950): Safety of Information technology equipment, including electrical office machines.

The EC Declaration of Conformity is issued by:

Wandel and Goltermann Ltd.
Burrington Way
Plymouth
Devon PL5 3LZ
Great Britain

1.3.3.1. Radiated and Line Conducted Emissions to EN 55 022

The DominoFastEthernet DA-350 Internetwork Analyzer and the DominoFE DA-362 Internetwork Analyzer meet the following classifications for radiated and line conducted emissions:

Analyzer	EN 55 022 - Radiated Emissions	EN 55 022 - Line Conducted Emissions
DominoFastEthernet DA-350	Class B	Class B
DominoPLUS DA-360 Chassis	Class B	Class B
DominoFE DA-362	Class B	Class B

1.3.3.2. Equipment Used in Compliance Testing

Both hardware models of the DominoFE analyzers have been tested for CE Mark conformity using the corresponding equipment described below.

DominoFastEthernet DA-350 Internetwork Analyzer

The following equipment was used in compliance testing for the DominoFastEthernet DA-350 Internetwork Analyzer:

- DominoFE DA-350 Internetwork Analyzer, BN 9316/01, Part number 9316-0100.006
- Laptop: IBM Thinkpad, Type 2620-20F, S/N 78-AN432, with associated power supply P/N 84G2098, S/N 9408103047. FCC ID: ANO2620CS

The following accessories were used for compliance testing the DominoFastEthernet DA-350 analyzer:

BN Number	Part Number	Equipment Description
K9139	9314-8537.002	110v power cable for North America
K9140	9314-8538.001	220v power cable for Europe
K9123	9314-8520.006	0.45 m PC-to-Domino cable

NOTES:

- EMC compliance was achieved with the above support equipment. If any other support equipment is used, compliance is not guaranteed.
- DominoFastEthernet DA-350 analyzer series A and forward is CE Mark compliant.

DominoFE DA-362 Internetwork Analyzer

The following equipment was used in compliance testing for the DominoFE DA-362 Internetwork Analyzer:

- DominoPLUS chassis, BN 9316/04, S/N G0029
- 100Base-T FD interface module, BN 9305/90.71, S/N N0023
- 155 Mbps Broadband Analyzer Module, BN 9305/90.69, S/N AV0010
- Laptop: IBM 380ED Thinkpad, S/N 78-YD921, with associated power supply P/N 85G6709, S/N J1371298489

The following accessories were used for compliance testing the DominoFE DA-362 analyzer:

BN Number	Part Number	Equipment Description
K9139	9314-8537.002	110v power cable for North America
K9140	9314-8538.001	220v power cable for Europe
K9123	9314-8520.006	0.45 m PC-to-Domino cable
none	9315-5913.004	Ferrite kit
none	none	Category 5 STP cable

NOTES:

- EMC compliance was achieved with the above support equipment. If any other support equipment is used, compliance is not guaranteed.
- Category 5 STP cabling with an installed ferrite kit (WG Part No. 9315-5913.004) is required to maintain CE Mark compliance.

1.3.4. Clearance Requirements

The DominoFE analyzers are forced-air cooled. Both sides of the case have ventilation openings to increase air flow. The analyzer clearance requirements are shown in the following table:

DominoFE Analyzer Area	Clearance
Top	No clearance required.
Bottom	.6 cm (.25 in) provided by the feet.
Back	10 cm (4 in) for cable connections.
Sides	2.5 cm (1 in).

1.4. EMC Information

No regularly scheduled maintenance is necessary to ensure EMC compliance.

1.5. Environmental Specifications

The DominoFE analyzers are subject to the environmental specifications provided in the following table:

Condition	Specification
Installation category	Transient Overvoltage Category II
Pollution Degree	2
Operating Temperature	+5 to 40°C
Storage and Transport Temperature	-20 to +60°C
Air Humidity	Up to 30°C, relative humidity 20-80%; over 30°C, absolute humidity: ≤ 25 g/m; no guarantee for continuous operation in a warm, damp environment.
Altitude	Up to 2000 M (6562 ft)

1.6. Cleaning the DominoFE Analyzer

To clean the outside of the DominoFE analyzers, wipe the external surface with a dry cloth to remove dust. For more extensive cleaning, use a damp cloth moistened with a mild detergent solution. Do not use any abrasive cleaners or allow any liquid to enter the ventilation openings.

2. Getting Started

This chapter will help you get up and running quickly with your DominoFE Internetwork Analyzer. The chapter provides an overview of the minimum steps to set up the DominoFE analyzer and start monitoring or transmitting network traffic.

2.1. Inspect the Parts

The components that are shipped with your order depend upon the model of DominoFE analyzer that you have ordered.

2.1.1. DominoFastEthernet DA-350 Internetwork Analyzer

The DominoFastEthernet DA-350 analyzer consists of the following parts:

- A DominoFastEthernet Internetwork Analyzer hardware unit (9316/01)
- A Domino-to-PC cable (K9123) for connecting the analyzer to a personal computer
- A power cable, North American (K9139) or European (K9140)
- CD-ROM disks that contain the installation software, online Help, and portable document formats (.PDF) of the Domino publications
- Domino Core Release Note
- *Domino Getting Started*
- *Domino Operating Guide*
- *DominoFE Interface Guide* (this manual)

2.1.2. DominoFE DA-362 Internetwork Analyzer

If you have ordered a new DominoFE DA-362 Internetwork Analyzer with the 100Base-T FD interface module and 155 Mbps Broadband Analyzer Module, then the interface hardware is pre-installed in the DominoPLUS chassis.

The DominoFE DA-362 analyzer consists of the following parts:

- A DominoPLUS chassis (9316/04) optionally pre-installed with the following modules:
 - ◆ 100Base-T FD Interface Module (9305/90.71)
 - ◆ 155 Mbps Broadband Analyzer Module (BAM) (9305/90.69)
- A Domino-to-PC cable (K9123) for connecting the analyzer to a personal computer
- A power cable, North American (K9139) or European (K9140)
- CD-ROM disks that contain the installation software, online Help, and portable document formats (.PDF) of the Domino publications
- DominoFE LED Overlay (9316/90.31)
- Domino Core Release Note
- *Domino Getting Started*
- *Domino Operating Guide*
- *DominoFE Interface Guide* (this manual)
- *DominoPLUS Installation Guide*

2.2. Read the Release Notes and Readme Help

The Domino Core Release Note and Readme Help file contain the latest product information. Read the release notes and the README.HLP prior to operating your DominoFE analyzer for any special requirements or exceptions that may affect your equipment, including the latest installation information.

NOTE:

There may be more than one release note and Readme file for the WWG products that you have ordered.

2.3. Install the Software

The DominoFE analyzer software is part of the Domino Core software package, and automatically installs with the Domino Core software. General information about installing and uninstalling the Domino Core software can be found in the *Domino Getting Started* guide.

For the latest information about requirements and operating the Domino Core software and the DominoFE interface software, see the Domino Core Release Note and Readme file.

2.4. Set Up the Domino Hardware

The amount of hardware setup required for your DominoFE analyzer depends on the model of analyzer that you purchased and any optional equipment that you might have ordered or be adding to your configuration.

The basic Domino hardware configuration consists of the following equipment:

- One Domino analyzer, such as the DominoFastEthernet DA-350 analyzer or DominoFE DA-362 analyzer
- A computer (standard PC or notebook). The Domino Core software and analyzer software that provides the user interface is installed on the computer.
- A network interface connection

Additional configurations support stacks of multiple Domino analyzer units and a printer connection (Figure 2-1).

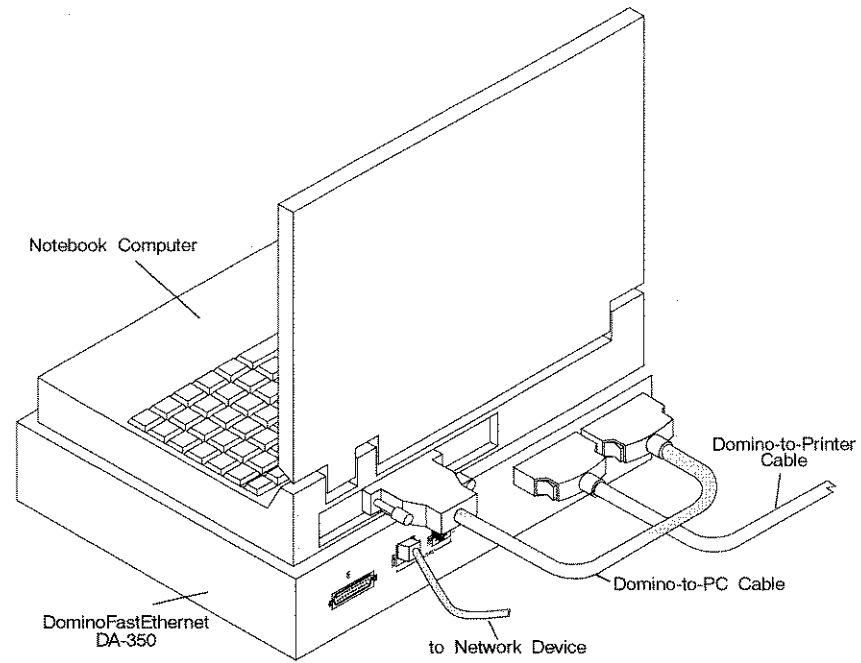

Figure 2-1. A basic Domino analyzer hardware configuration (shown with DominoFastEthernet DA-350 analyzer)

The DominoFE DA-362 analyzer consists of a DominoPLUS chassis with the following modules installed (Figure 2-2):

- Top slot—100Base-T FD interface module
- Bottom slot—155 Mbps Broadband Analyzer Module (BAM).

If you ordered a new DominoFE DA-362 analyzer, then the interface module and BAM are pre-installed for you.

If you ordered a DominoPLUS chassis and are using existing modules from your DA-30@C analyzer, then you will need to install the hardware modules into the DominoPLUS rear panel. For detailed instructions on removing and installing the modules for the DominoPLUS chassis, see the *DominoPLUS Installation Guide*.

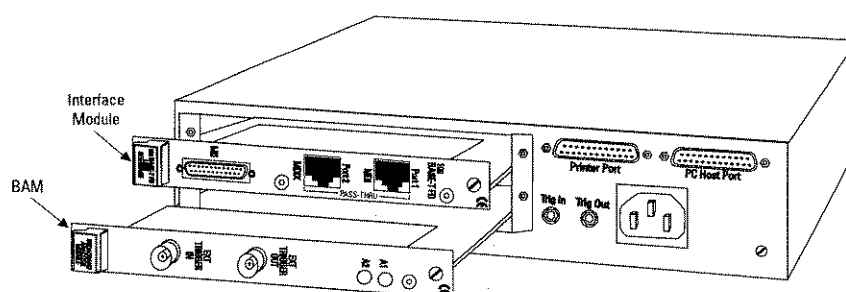

Figure 2-2. DominoFE DA-362 Analyzer hardware configuration

Additional References

For detailed instructions on connecting the DominoFE analyzers to your computer and connecting to multiple Domino analyzers see the following related publications:

- *Domino Getting Started* guide—"Setting Up a Domino System" chapter.
- *DominoPLUS Installation Guide*

For information about the minimum personal computer configuration required for operating the DominoFE analyzer and Domino Core software, see the Domino Core Release Note.

2.5. Connect the Network Cables

Network interface cabling is not included with your DominoFE analyzer package. To connect the DominoFastEthernet DA-350 or DominoFE DA-362 analyzers to the network, you can use a standard Category 5 UTP or STP cable or a Category 5 cross-over cable.

Required Cabling for CE Mark Compliance

- To maintain CE Mark compliance for both models of the DominoFE analyzers, Category 5 STP cable should be used.
- For the DominoFE DA-362 analyzer, a Category 5 STP cable should be used with an installed WG Ferrite Kit (Part No. 9315-5913.006).

For detailed information about connecting the DominoFE analyzers to the network, see the "Connecting to the Network" chapter.

2.6. Power Up the Analyzer and Display the Workbench

When you power up the DominoFE analyzer, the system performs a self-test and starts the system software. After the Microsoft Windows operating system starts, the Workbench screen (Figure 2-3) appears. If it does not, choose the Domino icon in the Start-Up group to open the Workbench screen.

From the Workbench, you can access all functions of the Domino Core software, the DominoFE analyzer software, and additional analysis applications.

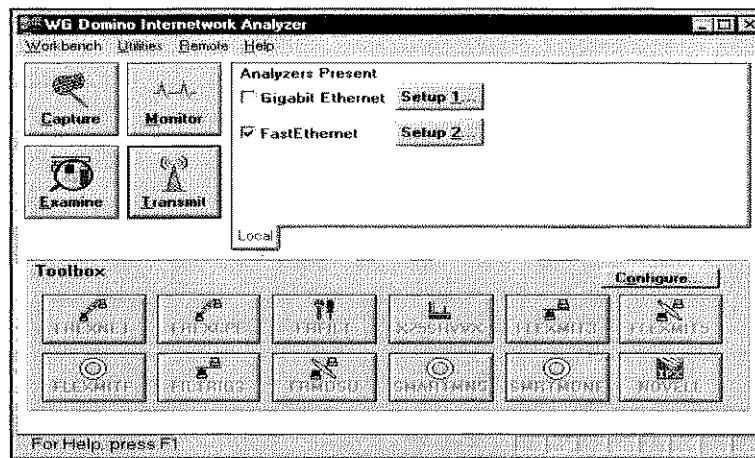

Figure 2-3. Domino Workbench screen with DominoGigabit and DominoFE analyzers installed

For more information about starting Domino and using the Workbench screen, see the *Domino Getting Started* guide.

2.7. Configure the Network Interface (optional)

The DominoFE analyzer interface is pre-configured for the TX MDI Emulate connection mode, in which the analyzer is set up to transmit and receive network traffic. As long as you have connected the DominoFE analyzer to the network as an MDI-emulating device (not as a pass-through monitor), then you can use the default analyzer interface configuration to begin monitoring network traffic.

If the DominoFE analyzer is connected for pass-through monitoring and you need to set up a different connection mode, or change other interface options, you can follow the basic procedure below to set up the DominoFE analyzer.

To configure the network interface:

1. From the Workbench screen (Figure 2-3), choose the **Setup** button next to the FastEthernet interface that you want to set up.
2. From the Fast Ethernet Main Setup dialog box (Figure 2-4), you can disable **NWay AutoNegotiation**, select the **Connection** mode, or choose a command button to make changes to other setup options.

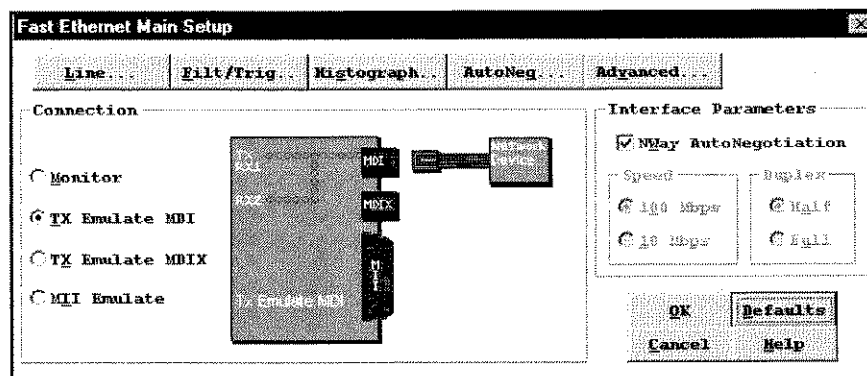

Figure 2-4. Fast Ethernet Main Setup dialog box

3. To set up advanced options, including the Protocol Stack or RAM/Disk Capture, choose the **Advanced** button.
4. From the Fast Ethernet Main Setup dialog box, choose **OK**.

For more detailed information on customizing the network interface setup, such as using filters or triggers, or setting up the advertised link capabilities, see the other related chapters of this guide.

For more information about setting up the advanced Domino Core software options, see the *Domino Operating Guide* and the Domino Core online Help.

2.8. Monitor Network Traffic

You can run the pre-defined Monitor application from the Workbench to quickly begin analyzing network traffic on the network with minimal, if any, network interface setup required.

To monitor network traffic:

1. From the Workbench screen (Figure 2-3), choose the **Monitor** button.
The Monitor application starts using the Workbench setup options and the Network Status window and Events are displayed.
2. From the Monitor screen you can display other results windows including network and error statistics, or if you are in an emulate connection mode, you can set up the interface to transmit frames.

For more information about analyzing and transmitting network traffic, see the other related chapters in this guide.

2.9. Set Up Applications

The DominoFE analyzer provides the Capture, Monitor, Examine, and Transmit applications from the Workbench. The Capture, Monitor, and Transmit applications allow you to quickly access the real-time environment for transmitting and analyzing network traffic. You can only set up and transmit network traffic by running an application. However, you cannot transmit traffic using the Examine application.

You can modify the DominoFE interface setup for an application either before running the application, or from within real-time when you are running the application. A restart of the application is required for the interface setup changes to take effect from within real-time.

For more information about capturing, monitoring, and examining network traffic, see Chapter 9, "Analyzing Network Traffic and Status." For detailed information on the Domino analyzer applications, see the *Domino Operating Guide*.

2.10. Analyze Network Traffic

Real-Time Analysis

With the DominoFE analyzer, you can run applications such as Monitor and Capture to perform real-time analysis on the network. Real-time analysis allows you to view network traffic and statistics as they are being captured by the DominoFE analyzer. You can access the Domino real-time environment by using the pre-defined applications such as Monitor or Capture.

Post-Capture Analysis

You can also save traffic captured from the network and perform post-capture analysis using Examine. Examine does not provide the capability to review network data as it is being captured from the network.

2.11. View the Results

The DominoFE interface provides a number of statistics windows and status windows from which you can analyze network status and traffic in the real-time environment. Some windows, such as the Network Status and Events windows, are automatically displayed when you run Monitor or Capture. Other results windows, such as the Histogram, are available from the menu bar or toolbar in the real-time environment.

Frame Summary, Protocol Summary, and Hexadecimal Trace windows in the Examine application provide a detailed view of the content of your captured network traffic.

You can use all of the results windows along with the front panel LED indicators to obtain a comprehensive view of your network status and traffic.

For more information about the DominoFE interface results windows, see Section 9.8, "Viewing Network Traffic and Statistics" in Chapter 9 of this guide. You can obtain specific information about a particular results window while you have it opened by pressing F1 to access the extensive Help for the Domino Core and DominoFE software.

3. Connecting to the Network

This chapter provides detailed instructions about connecting your DominoFE analyzer to the network, including descriptions of the front and rear panels of the DominoFE analyzer.

3.1. Rear Panel Connectors

The DominoFastEthernet DA-350 and DominoFE DA-362 analyzers vary slightly in their rear panel configurations, but both models provide the same basic functionality in their port connections.

3.1.1. DominoFastEthernet DA-350 Analyzer Rear Panel Connectors

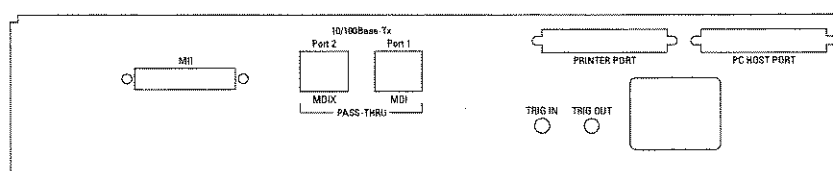

Figure 3-1. DominoFastEthernet DA-350 analyzer rear panel

The DominoFastEthernet DA-350 analyzer (Figure 3-1) and DominoFE DA-362 analyzer (Figure 3-2) provide the following ports for device connection:

MII

This 40-pin Media Independent Interface (MII) port is used for MII-compliant network transceiver connections. The MII port is used to connect the analyzer to various types of media, such as fiber, Category 3 UTP, and 150-Ohm STP.

Port 2 MDIX

This RJ-45 port is used with two- or four-pair Category 5 UTP cabling to connect the DominoFastEthernet analyzer to the network according to the 100Base-TX IEEE specification (EIA/TIA-SP2840A).

In Monitor mode, Port 2 and Port 1 are configured as straight-through connections.

In Tx MDIX Emulate mode, Port 2 functions as a Media Dependent Interface Crossed-Over (MDIX) port. An MDIX port incorporates the cross-over wiring necessary for connecting the transmit pins of one MDI to the receive pins of another MDI, and vice versa. The MDIX port is configured with Pins 1 and 2 used for receiving data and Pins 3 and 6 used for transmitting data.

**Port 1
MDI**

This RJ-45 port is used with two- or four-pair Category 5 UTP cabling to connect the DominoFastEthernet analyzer to the network according to the 100Base-TX IEEE specification (EIA/TIA-SP2840A).

In Monitor mode, Port 1 and Port 2 are configured as straight-through connections.

In Tx MDI Emulate mode, Port 1 functions as a Media Dependent Interface (MDI) port. An MDI port is configured with Pins 1 and 2 used for transmitting data and Pins 3 and 6 used for receiving data.

Printer Port

The printer port enables you to connect the DominoFastEthernet analyzer to a second Domino analyzer in the stack using a Domino-to-Domino cable (K9127), or to a printer using a Domino-to-Printer cable (K9125).

PC Host Port

The PC host port enables you to connect the DominoFastEthernet analyzer to the parallel port on your notebook computer using a Domino-to-PC cable (K9123 or K9137), or to another Domino analyzer in a stack, using a Domino-to-Domino cable (K9127).

Trig In

The external trigger input port is a 2.5 mm. audio jack that accepts a TTL pulse, which causes the DominoFE analyzer to begin data capture. (This port is not in use on the DA-362 analyzer).

Trig Out

The external trigger output port is a 2.5 mm. audio jack that produces a TTL pulse that you can use to synchronize with other equipment. (This port is not in use on the DA-362 analyzer).

AC Power

The DominoFastEthernet analyzer can be operated from line voltages ranging from 100 to 240 Volts A.C. ($\pm 10\%$), at frequencies ranging from 50 to 60 Hz. with an input current rating of 1.5 amperes, and a maximum power rating of 150 VA.

3.1.2. DominoFE DA-362 Analyzer Rear Panel Connectors

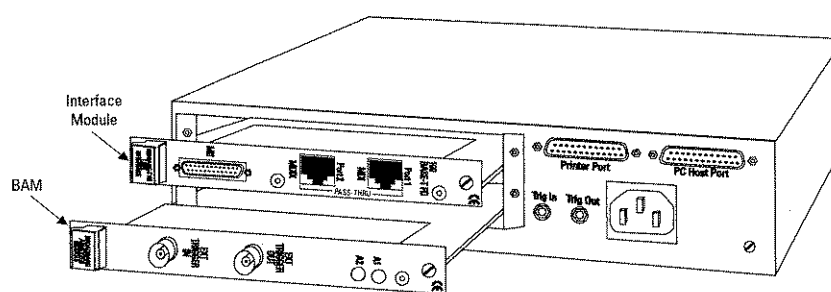

Figure 3-2. DominoFE DA-362 analyzer rear panel

3.1.2.1. DominoPLUS Chassis Connectors

The following standard port connections are provided on the rear panel of the DominoPLUS chassis (Figure 3-2):

Printer Port

The printer port enables you to connect the DominoFE analyzer to a second Domino analyzer in the stack using a Domino-to-Domino cable (K9127), or to a printer using a Domino-to-Printer cable (K9125).

PC Host Port

The PC host port enables you to connect the DominoFE analyzer to the parallel port on your notebook computer using a Domino-to-PC cable (K9123 or K9137), or to another Domino analyzer in a stack, using a Domino-to-Domino cable (K9127).

Trig In

The Trig In port on the DominoPLUS chassis is not implemented on the DominoFE DA-362 analyzer. The Trigger In function is provided by the Trig In port on the 155 Mbps BAM.

Trig Out

The Trig Out port on the DominoPLUS chassis is not implemented on the DominoFE DA-362 analyzer. The Trigger Out function is provided by the Trig Out port on the 155 Mbps BAM.

AC Power

The analyzer has an internal AC switching power supply that automatically adjusts to input voltage within the range from 100 volts AC to 240 volts AC 50/60 HZ.

3.1.2.2. 100Base-T FD Interface Module Connectors

Figure 3-3. 100Base-T FD Interface Module (BN 9305/90.71)—horizontal orientation for DA-362 analyzer

The following port connections are provided on the 100Base-T FD interface module (Figure 3-3):

**Port 1
MDI**

This RJ-45 port is used with two- or four-pair Category 5 UTP cabling to connect the DominoFE analyzer to the network according to the 100Base-TX IEEE specification (EIA/TIA-SP2840A).

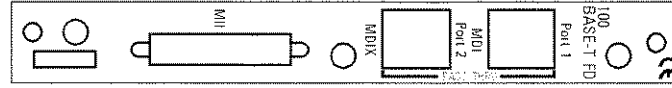
In Monitor mode, Port 1 and Port 2 are configured as straight-through connections.

In Tx MDI Emulate mode, Port 1 functions as a Media Dependent Interface (MDI) port. An MDI port is configured with Pins 1 and 2 used for transmitting data and Pins 3 and 6 used for receiving data.

**Port 2
MDIX**

This RJ-45 port is used with two- or four-pair Category 5 UTP cabling to connect the DominoFE analyzer to the network according to the 100Base-TX IEEE specification (EIA/TIA-SP2840A).

In Monitor mode, Port 2 and Port 1 are configured as straight-through connections.

In Tx MDIX Emulate mode, Port 2 functions as a Media Dependent Interface Crossed-Over (MDIX) port. An MDIX port incorporates the cross-over wiring necessary for connecting the transmit pins of one MDI to the receive pins of another MDI, and vice versa. The MDIX port is configured with Pins 1 and 2 used for receiving data and Pins 3 and 6 used for transmitting data.

MII

This 40-pin Media Independent Interface (MII) port is used for MII-compliant network transceiver connections. The MII port is used to connect the analyzer to various types of media, such as fiber, Category 3 UTP, and 150-Ohm STP.

3.1.2.3. 155 Mbps BAM Connectors

The following port connections are provided on the 155 Mbps Broadband Analyzer Module (Figure 3-2):

Trig In

The external trigger input port is a 2.5 mm. audio jack that accepts a TTL pulse, which causes the DominoFE analyzer to begin data capture.

NOTE:

The Trig In port on the DominoPLUS *chassis* is not implemented on the DominoFE DA-362 analyzer.

Trig Out

The external trigger output port is a 2.5 mm. audio jack that produces a TTL pulse that you can use to synchronize with other equipment.

NOTE:

The Trig Out port on the DominoPLUS *chassis* is not implemented on the DominoFE DA-362 analyzer.

3.2. Front Panel LED Indicators

The LED indicators that appear on the front panel of the DominoFE analyzer (Figure 3-4) provide you with a quick way to assess the status of your analyzer's network links.

3.2.1. DominoFastEthernet DA-350 Analyzer Front Panel

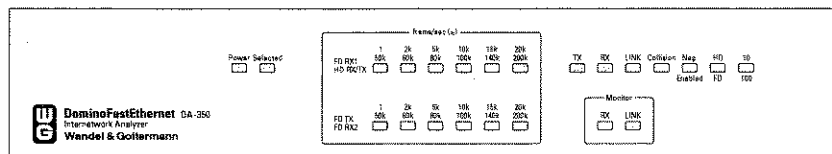

Figure 3-4. DominoFastEthernet DA-350 analyzer front panel

The front panel of the DominoFastEthernet DA-350 analyzer displays the following information:

Power

Indicates that the DominoFE analyzer is connected to an AC power source.

Selected

Indicates that the analyzer is selected as an active analyzer. (You can select the active analyzers on the Workbench screen, which is the first screen that is displayed when you start the Domino software.)

Frames/Sec (two rows of six)

Indicates the frame rate in frames per second. The rate displayed is based upon the analyzer's current transmission mode (full- or half-duplex) and connection mode (Emulate or Monitor). Listed below are the possible configurations and the row of frame rate LEDs that apply to each.

Half-Duplex Monitor Mode. In this mode, the top row of LEDs labeled HD RX/TX display the rate at which frames are received.

Full-Duplex Monitor Mode. In this mode, the top row of LEDs labeled FD RX1 display the rate at which frames are received on Port 1, and the bottom row of LEDs labeled FD RX2 display the rate at which frames are received on Port 2.

Half-Duplex Emulate Mode. In this mode, the top row of LEDs labeled HD RX/TX display the frame rate, which is based on total frames transmitted and received.

Full-Duplex Emulate Mode. In this mode, the top row of LEDs labeled FD RX1 display the rate at which frames are received, and the bottom row of LEDs labeled FD TX display the rate at which frames are transmitted.

Interpreting the LED Colors

The LEDs are read from left to right, with the frame rate represented by the colors green or orange.

All LEDs are green. The frame rate is less than or equal to 20 k/sec. The actual frame rate is indicated by the right-most LED that is illuminated green. The frame rate value is determined by reading the top number in the group of numbers directly above the right-most, green LED.

Some or all LEDs are orange. The frame rate is greater than 20 k/sec, and you may see both green and orange LEDs illuminated in the row. The actual frame rate is indicated by the right-most LED that is illuminated orange. The frame rate value is determined by reading the bottom number in the group of numbers directly above the right-most, orange LED. When all LEDs are orange, the frame rate is 200 k/sec.

TX

Flashes green when the analyzer is transmitting frames.

RX

Flashes green when the analyzer is receiving frames.

Monitor RX

Used only in Monitor mode, this LED flashes green when the analyzer is receiving on Port 2 (Rx2).

LINK

Indicates the analyzer's connection status. The available states are:

Green. Indicates that the analyzer is connected to the network.

Off. Indicates that the analyzer is not connected to the network.

Monitor LINK

Used only in Monitor mode, this LED indicates the status of Port 2's (Rx2) connection to the network.

Collision

Indicates whether collisions are detected on the network. The analyzer only detects station-level collisions, which means that it displays collisions in which the DominoFE analyzer was directly involved.

The available states are:

Red. Flashes red when a collision is detected, except in Monitor mode.

Off. Indicates that no collisions are detected on the network.

**Neg.
Enabled**

Indicates whether NWay AutoNegotiation is enabled.

**H/D
F/D**

Indicates the transmission mode of the analyzer. The available states are:

Green. Indicates that the analyzer is configured for half-duplex transmission.

Orange. Indicates that the analyzer is configured for full-duplex transmission.

**10
100**

Indicates the transmission speed for the analyzer. The available states are:

Green. Indicates that the analyzer is configured for 10 Mbps transmission.

Orange. Indicates that the analyzer is configured for 100 Mbps transmission.

3.2.2. DominoFE DA-362 Analyzer Front Panel

Figure 3-5. DominoFE DA-362 analyzer front panel

The front panel of the DominoFE DA-362 analyzer displays the following information:

Power

Indicates that the DominoFE analyzer is connected to an AC power source.

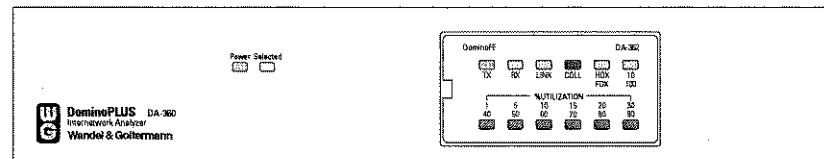
Selected

Indicates that the analyzer is selected as an active analyzer. (You can select the active analyzers on the Workbench screen, which is the first screen that is displayed when you start the Domino software.)

TX

Flashes green when the DA-362 analyzer is transmitting frames.

RX

Flashes green when the DA-362 analyzer is receiving frames.

LINK

Displays the status of the DA-362 analyzer's connection to the network. The available states are:

Green. Constant green indicates that the analyzer is connected to the network.

Off. Indicates that the analyzer is not connected to the network.

COLL

Displays the detection of transmit collisions on the DA-362 analyzer. The available states are:

Red. Flashes red when a transmit collision is detected.

Off. Indicates that no transmit collisions are detected on the DA-362 analyzer.

FDX**HDX**

Displays the transmission mode of the DA-362 analyzer. The available states are:

Green. Indicates that the analyzer is configured for half-duplex transmission.

Orange. Indicates that the analyzer is configured for full-duplex transmission.

10
100

Displays the transmission speed for the DA-362 analyzer. The available states are:

Green. Indicates that the analyzer is configured for 10 Mbps transmission.

Orange. Indicates that the analyzer is configured for 100 Mbps transmission.

% Utilization

Displays a color-coded indicator of the percent utilization of network bandwidth across six LEDs. The LEDs are read from left to right, with the percent utilization represented by the colors green or orange.

All LEDs are green. The utilization percentage is less than or equal to 30%. The actual utilization is indicated by the right-most LED that is illuminated green. The utilization value is determined by reading the top number in the group of numbers directly above the right-most, green LED.

Some or all LEDs are orange. The utilization percentage is greater than 30%, and you may see both green and orange LEDs illuminated in the row. The actual utilization is indicated by the right-most LED that is illuminated orange. The utilization value is determined by reading the bottom number in the group of numbers directly above the right-most, orange LED. When all LEDs are orange, network utilization is $\geq 90\%$.

3.3. Overview of Connecting to the Network

In order for two devices to communicate over a network link, the transmit data pins of one device must be wired to the receive data pins of the other device, and vice versa. For 100Base-T network devices, this wiring is achieved through connecting an MDI port on one device to an MDIX port on the other device using a standard two- or four-pair Category 5 cable.

If it is not possible to interconnect an MDI port to an MDIX port, and two of the same port types must be connected, such as MDI to MDI or MDIX to MDIX, the wiring of the transmit pins to the receive pins must be accomplished through a Category 5 cross-over cable.

An MDI port transmits data on Pins 1 and 2, and receives data on Pins 3 and 6. In contrast, an MDIX port transmits data on Pins 3 and 6, and receives data on Pins 1 and 2.

The DominoFE analyzers have two RJ-45 ports, where Port 1 functions as an MDI port and Port 2 functions as an MDIX port.

Basic Cabling Rules

- Use standard Category 5 cables to connect an MDI port on one device to an MDIX port on another device.
- Use Category 5 cross-over cables to connect an MDI or MDIX port on one device to the same port type on another device.

CE Mark Compliance

To be compliant with CE Mark specifications, a Category 5 STP cable should be used. For the DominoFE DA-362 analyzer, a WG Ferrite Kit (Part No. 9315-5913.006) should be installed with Category 5 STP cable.

3.4. Connecting for Dual Monitoring

Figure 3-6. Connecting for dual monitoring—DA-350 analyzer

You can connect both of the RJ-45 ports (MDI and MDIX) on a DominoFE analyzer, to monitor the network in full duplex or half duplex monitoring modes.

The cabling rules for connecting a DominoFE analyzer for dual monitoring are:

- Use standard Category 5 cables to connect both network devices to the analyzer if one of the network device ports to be connected to the analyzer is MDI and the other network device port to be connected to the analyzer is MDIX (either device can be connected to either Port 1 or Port 2 on a DominoFE analyzer).
- Use one Category 5 cross-over cable and one standard Category 5 cable if the two network device ports to be connected to the analyzer are both MDI or both MDIX. Connect one of the device ports to the analyzer (Port 1 or Port 2) using a Category 5 cross-over cable and connect the other device port to the remaining analyzer port using a standard Category 5 cable.

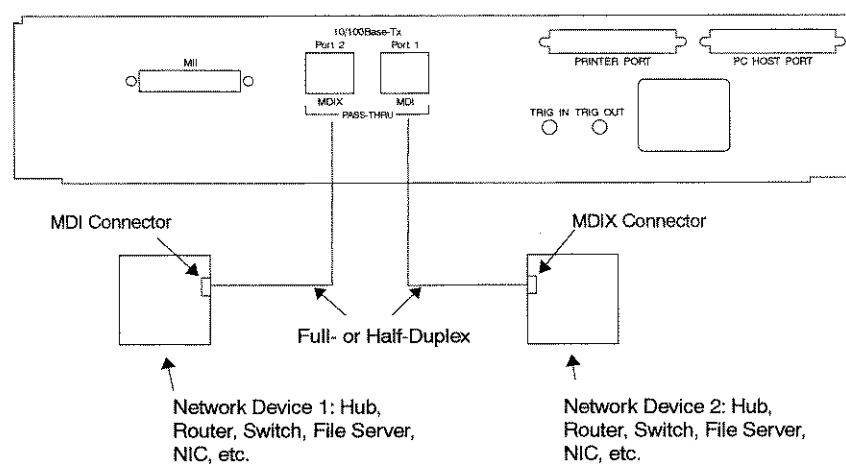
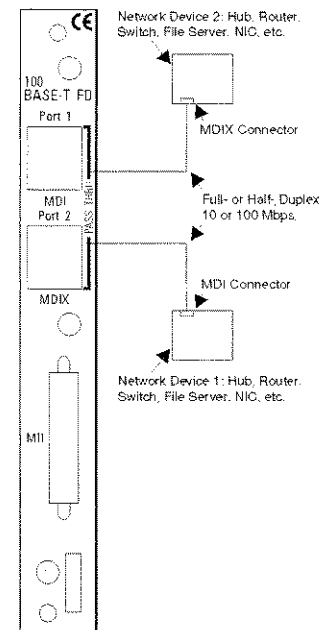

Figure 3-7. Connecting for dual monitoring—DA-362 analyzer

Dual Monitoring Connection Scenarios

When connecting a DominoFE analyzer for monitoring, several connection scenarios can be achieved depending upon the types of device ports being interconnected on either side of the 100Base-T FD interface module. The DominoFE analyzer is inserted between two network devices when it is configured for monitoring. Therefore, in Monitor mode, the MDI and MDIX ports (1 and 2) on the DominoFE analyzer are configured as pass-through connections (Pin 1 of MDI is wired to Pin 1 of MDIX, and so on). When the analyzer is configured for monitoring, it does not matter which network device is connected to the analyzer's MDI or MDIX ports.

When analyzing statistics while you are connected for monitoring, it is very important to understand how the network device connections are made to the DominoFE analyzer (especially when using a cross-over cable) and their relationship to the analyzer's receivers.

Receiver 2 (Rx2) on Port 2 (MDIX) always monitors the data that is being sent on Pins 1 and 2, regardless of which device is transmitting. Receiver 1 (Rx1) on Port 1 (MDI) always monitors the data that is being sent on Pins 3 and 6, regardless of which device is transmitting.

For more information about setting up the DominoFE analyzer for dual monitoring, see Section 9.5, "Monitoring Network Traffic."

3.4.1. Connecting for Dual Monitoring—Example 1

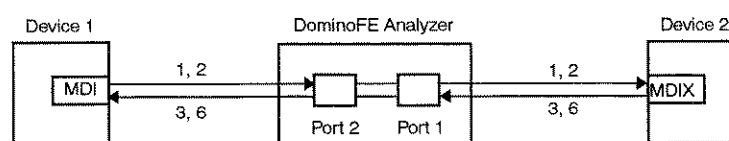

Figure 3-8. Connecting for dual monitoring between an MDI and MDIX device

In Example 1, Device 1 has an MDI port, and Device 2 has an MDIX port. The cross-over function takes place in Device 2, and no cross-over cables are needed.

Port 1 monitors the frames transmitting on Pins 3 and 6, which is coming from Device 2. Port 2 monitors the frames transmitting on Pins 1 and 2, which is coming from Device 1.

3.4.2. Connecting for Dual Monitoring—Example 2

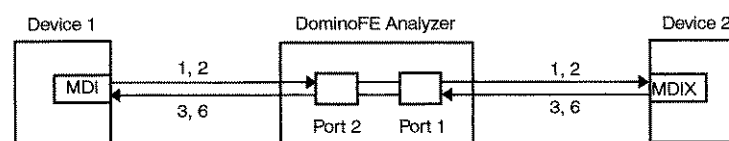

Figure 3-9. Connecting for dual monitoring between an MDIX and MDI device

In Example 2, Device 1 has an MDIX port, and Device 2 has an MDI port. The cross-over function takes place in Device 1, and no cross-over cables are needed.

Port 1 monitors the frames transmitting on Pins 3 and 6, which is coming from Device 1. Port 2 monitors the data transmitting on Pins 1 and 2, which is coming from Device 2.

3.4.3. Connecting for Dual Monitoring—Example 3

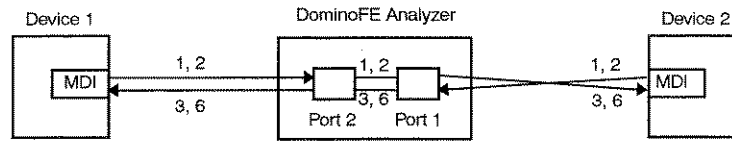

Figure 3-10. Connecting for dual monitoring between two MDI devices

In Example 3, both network devices have MDI ports. A cross-over cable is used between Device 2 and the DominoFE analyzer.

Port 1 monitors the frames transmitting on Pins 3 and 6, which is coming from Device 2. Port 2 monitors the frames transmitting on Pins 1 and 2, which is coming from Device 1.

3.4.4. Connecting for Dual Monitoring—Example 4

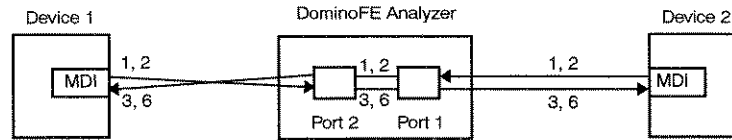

Figure 3-11. Connecting for dual monitoring between two MDI devices

In Example 4, both network devices have MDI ports. A cross-over cable is used between Device 1 and the DominoFE analyzer.

Port 1 monitors the frames transmitting on Pins 3 and 6, which is coming from Device 1. Port 2 monitors the frames transmitting on Pins 1 and 2, which is coming from Device 2.

3.5. Connecting for Emulation

If you want to transmit frames on the network, you need to connect the DominoFE analyzer for emulation. When you have connected for emulation, you must also be sure to set up the corresponding emulation Connection mode that matches your network configuration on the Fast Ethernet Main Setup dialog box.

3.5.1. Connecting for MDI Emulation

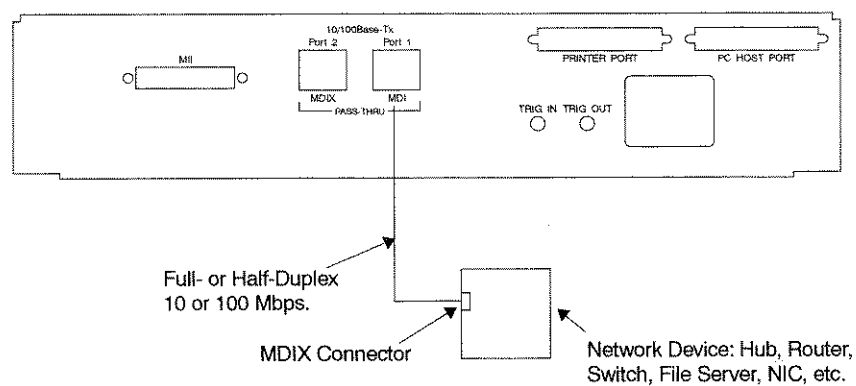
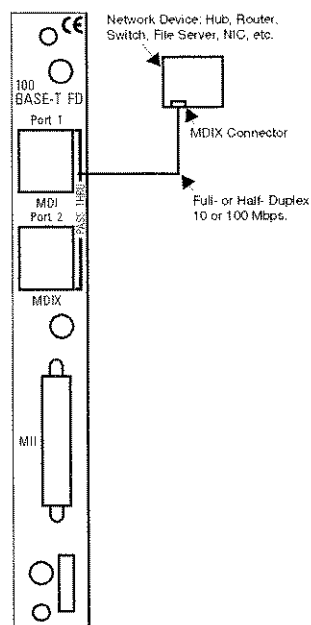

Figure 3-12. Connecting for MDI emulation—DA-350 analyzer



You can connect a DominoFE analyzer for MDI emulation using the corresponding RJ-45 ports on the rear panel of the analyzer and by following the basic cabling rules in Section 3.3 for connecting MDI to MDI or MDI to MDIX.

An MDI port transmits data on Pins 1 and 2, and receives data on Pins 3 and 6. The RJ-45 port that functions as the MDI port on the DominoFE analyzers is labeled Port 1 or MDI.

Figure 3-13. Connecting for MDI emulation—DA-362 analyzer

3.5.2. Connecting for MDIX Emulation

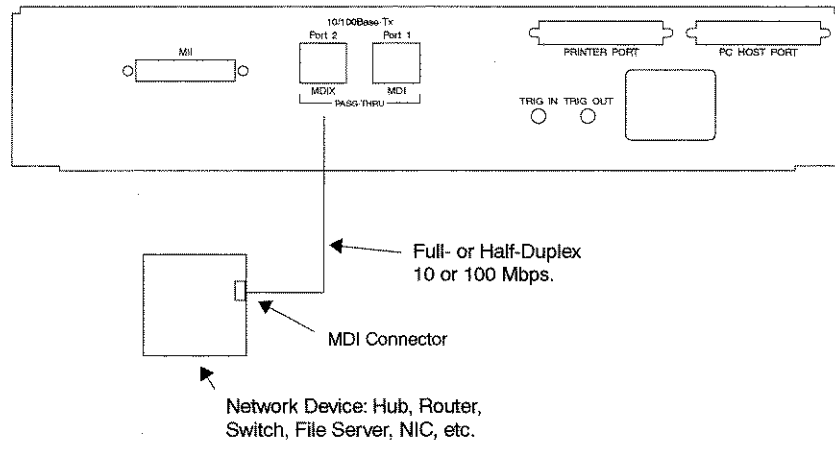
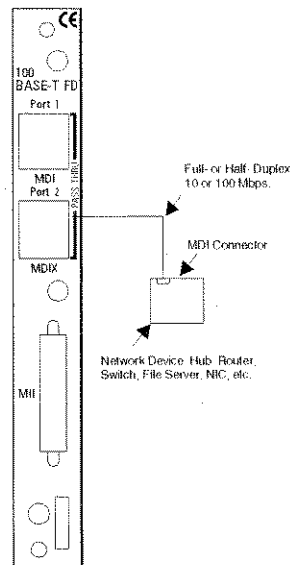

Figure 3-14. Connecting for MDIX emulation—DA-350 analyzer



You can only connect a DominoFE analyzer for MDIX emulation using the RJ-45 port labeled Port 2 or MDIX and by following the basic cabling rules in Section 3.3. for connecting MDIX to MDIX or MDIX to MDI.

An MDIX port transmits data on Pins 3 and 6, and receives data on Pins 1 and 2.

Figure 3-15. Connecting for MDIX emulation—DA-362 analyzer

3.5.3. Connecting for MII Emulation

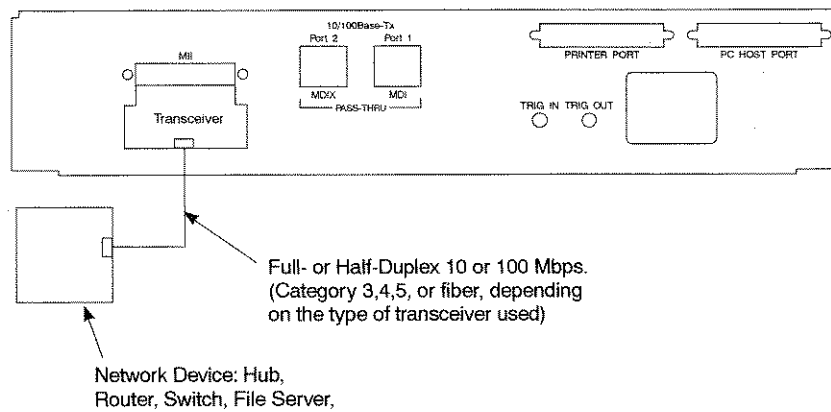
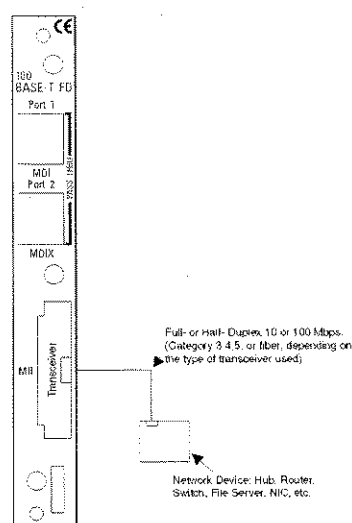

Figure 3-16. Connecting for MII emulation—DA-350 analyzer



You can connect a DominoFE analyzer for MII emulation using the MII port on the rear panel analyzer and a transceiver module that supports the type of cabling media you want to connect. The 40-pin MII port supports a variety of cabling media including fiber, Category 3 UTP and 150-Ohm STP.

Figure 3-17. Connecting for MII emulation—DA-362 analyzer

For more information about setting up the interface for an emulation connection mode and transmitting frames, see Section 4.2, "Selecting the Connection Mode" and Section 8.3, "Setting Up the Analyzer to Transmit Frames."

4. Setting Up the DominoFE Interface

4.1. Main Setup Overview

Use the Fast Ethernet Main Setup dialog box (Figure 4-1) to set up global configuration parameters for the DominoFE analyzer. The basic configuration options for the analyzer include the connection mode and whether or not you want the analyzer to negotiate its link configuration with the network devices to which it connects.

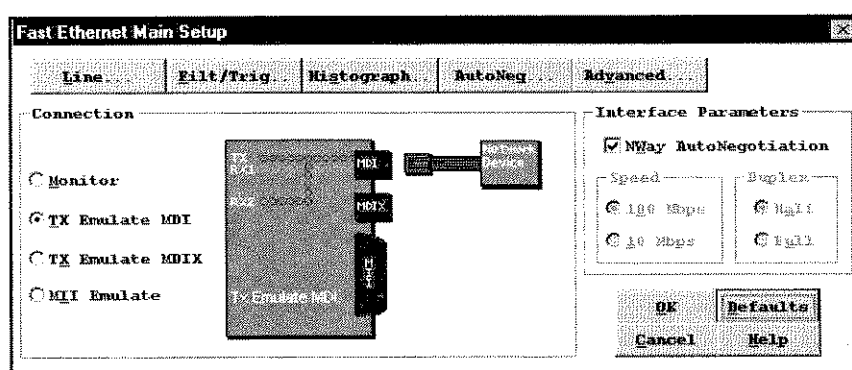

Figure 4-1. Fast Ethernet Main Setup dialog box

The **Connection** options designate the type of network connection and the operating mode for the analyzer. The **Interface Parameters** allow you to set up the analyzer for NWay Auto-Negotiation or to manually specify the network speed and duplex transmission mode. The NWay AutoNegotiation option enables the **AutoNegotiate** button and the default auto-negotiation advertisement options for the analyzer.

The analyzer setup dialogs have a hierarchical structure, where the Fast Ethernet Main Setup dialog box is the top-level, or "parent," dialog box that is the main entry point for all of the setup options. The lower level dialog boxes accessed from the main setup dialog box are the "child" setup dialog boxes.

Using the command buttons from the main setup dialog, you can access the following child setup dialogs:

- Line Setup dialog box—Allows you to select MAC-level transmit and receive options for the DominoFE analyzer.
- Filter/Trigger Setup dialog box—Allows you to specify the filter/trigger conditions and pattern matches to be applied to received traffic.
- Histogram Setup dialog box—Allows you to specify the sampling interval and select the statistics that you want to plot on the Histogram window.
- Auto-Negotiation Advertisement dialog box—Allows you to specify the type of transmission options that you want to advertise support of (duplex mode and speed) when the DominoFE analyzer is in an Emulate mode.
- Advanced Setup dialog box—Provides access to procedures for setting up non-interface-specific setup parameters, such as setting up the protocol stack and RAM/Disk capture options.

If you do not change the child setup dialog box selections, then the analyzer uses the default selections or the last dialog box selections that were saved.

You must click OK in both the child setup dialog box and the Fast Ethernet Main Setup dialog box to save changes made to the setup selections. In real time, changes to setup selections are activated when you restart the real time application.

4.2. Selecting the Connection Mode

The DominoFE analyzer can be connected to a number of different network media using either the RJ-45 or Media Independent Interface (MII) connectors on the rear panel of the device. You configure the analyzer for the type of network connection by choosing an option in the **Connection** box on the Fast Ethernet Main Setup dialog box. You can configure the DominoFE analyzer either to monitor a network segment or to emulate a network device.

To select the connection mode:

1. Under **Connection** on the Fast Ethernet Main Setup dialog box, do one of the following:
 - Choose **Monitor**.

The analyzer is configured to receive network data only. In monitor mode, Ports 1 and 2 on the rear panel of the DominoFE analyzer are configured as straight-through connections. This is the default selection. The transmitter ports are used internally to regenerate the signal from the receiver ports back onto the network.
 - Choose **TX Emulate MDI**.

The analyzer is configured to emulate a network device that uses an MDI port. An MDI port uses Pins 1 and 2 for transmitting data and Pins 3 and 6 for receiving data. Use the analyzer's MDI port (Port 1) and two- or four-pair Category 5 UTP wiring to connect the analyzer to the network according to the 100 Base-TX IEEE specification (EIA/TIA-SP2840A).

TX Emulate MDI supports auto-negotiation.
 - Choose **TX Emulate MDIX**.

The analyzer is configured to emulate a network device that uses an MDIX port. An MDIX port uses Pins 1 and 2 for receiving data and Pins 3 and 6 for transmitting data. Use the analyzer's MDIX port (Port 2) and two- or four-pair Category 5 UTP wiring to connect the analyzer to the network according to the 100 Base-TX IEEE specification (EIA/TIA-SP2840A).

TX Emulate MDIX supports auto-negotiation.
 - Choose **MII Emulate**.

The MII option configures the analyzer according to the Media Independent Interface specifications to support a variety of network connection media including fiber, Category 3 UTP, and 150-ohm STP. The analyzer is configured for MII-compliant network transceiver connections into the MII connector on the rear panel of the DominoFE analyzer.
2. Click **OK**.

The setup selections are saved, and you return to the Workbench screen or to the Real Time screen. From Real Time, a prompt appears asking if you want to restart your application before returning you to the Real Time screen.

4.3. Selecting the Network Speed

You can use the Fast Ethernet Main Setup dialog box to manually select the network speed supported by the analyzer, or you can specify auto-negotiation of the network speed. The available network speeds are 10 Mbps and 100 Mbps.

To select the network speed:

1. Under **Interface Parameters** on the Fast Ethernet Main Setup dialog box, do one of the following:

- Select the **NWay AutoNegotiation** checkbox.

The Speed and Duplex options are disabled and the network speed will be negotiated between the analyzer and the network device with which it is communicating, according to the options selected in the Auto-Negotiation Advertisement Setup dialog box. This is the default selection.

- In the **Speed** box, select **10 Mbps** or **100 Mbps**.

2. Click **OK**.

The setup selections are saved, and you return to the Workbench screen or to the Real Time screen. From Real Time, a prompt appears asking if you want to restart your application before returning you to the Real Time screen. You must restart the application for the changes to take affect.

NOTE:

Auto-negotiation is only supported when the analyzer is configured for a TX connection mode.

4.4. Selecting the Duplex Transmission Mode

You can use the Fast Ethernet Main Setup dialog box to manually select the duplex transmission mode supported by the analyzer, or you can specify auto-negotiation of the duplex mode. The available duplex transmission modes are full duplex and half duplex.

To select the duplex transmission mode:

1. Under **Interface Parameters** on the Fast Ethernet Main Setup dialog box, do one of the following:
 - Select the **NWay AutoNegotiation** checkbox.

The **Speed** and **Duplex** options are disabled and the duplex transmission mode will be negotiated between the analyzer and the network device with which it is communicating, according to the options selected in the Auto-Negotiation Advertisement Setup dialog box. This is the default selection.
 - Clear the **NWay AutoNegotiation** checkbox. Then in the **Duplex** box, select **Full** or **Half**.

The interface is configured for either full duplex or half duplex transmission.
2. Click **OK**.

The setup selections are saved, and you return to the Workbench screen or to the Real Time screen. From Real Time, a prompt appears asking if you want to restart your application before returning you to the Real Time screen.

NOTE:

Auto-negotiation is only supported when the analyzer is configured for a TX connection mode.

4.5. Saving Setup Selections

Save the setup selections for the DominoFE analyzer by clicking **OK** on the Fast Ethernet Main Setup Dialog Box (Figure 4-1). The **OK** button on the Fast Ethernet Main Setup dialog box saves both the main setup selections and all of the selections on the Fast Ethernet Main Setup child dialog boxes.

If you have made changes to any of the options on a child setup dialog box, you must first click **OK** on the child setup dialog box to accept your selections. Then, you can save those selections by clicking **OK** on the Fast Ethernet Main Setup dialog box.

In real time, changes to setup selections are activated when the real time application is restarted.

To save setup selections:

1. From a Fast Ethernet Main Setup child dialog box, click **OK**.
The child setup dialog box selections are accepted, and you return to the Fast Ethernet Main Setup dialog box.
2. Click **OK**.
The setup selections are saved, and you return to the Workbench screen or to the Real Time screen. From Real Time, a prompt is issued about whether to restart your application before returning you to the Real Time screen.

NOTE:

You can also save the options on the Filter/Trigger Setup dialog by clicking **Save**. However, once the **Save** button has been used, the filter/trigger selections are stored in the filter file, and the **OK** and **Cancel** buttons are no longer valid for those selections.

5. Setting Up the DominoFE Interface Line

This chapter describes the MAC-Layer transmit and receive options that you can set up from the Line Setup dialog box.

5.1. Line Setup Overview

You can use the Line Setup dialog box (Figure 5-1) to select MAC-Layer transmit and receive options.

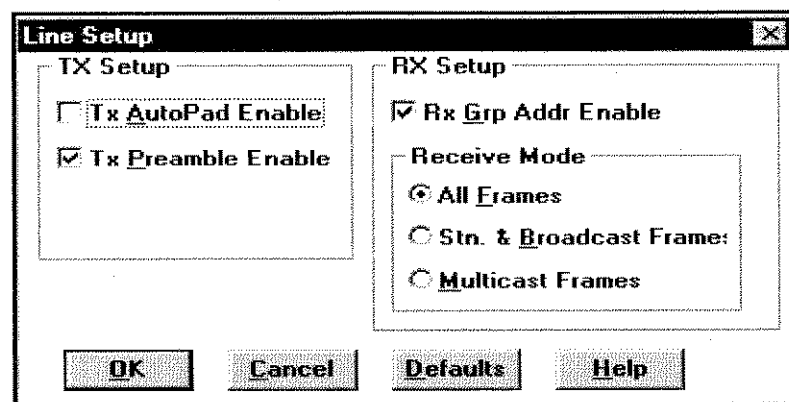

Figure 5-1. Line Setup dialog box

The transmit setup options allow you to pad transmit frames to a minimum of 60 bytes (excluding FCS) and add a preamble pattern to transmit frames.

The receive setup options allow you to ignore the last four bits of the destination address in received frames and filter received network traffic by frame type.

To configure the line setup:

1. From the Fast Ethernet Main Setup dialog box, click **Line**.
The Line Setup dialog box is displayed.
2. Select and enter the corresponding transmit and receive options that are suitable for your application.
A checkmark is displayed in the checkbox, or the radio button is filled in, beside the option(s) that you enabled. An empty checkbox or radio button indicates that the option is disabled.

3. Click **OK**.

The options that you selected are accepted and you return to the Fast Ethernet Main Setup dialog box.

4. Click **OK**.

The setup selections are saved, and you return to the Workbench screen or to the Real Time screen. From Real Time, a prompt is issued about whether to restart your application before returning you to the Real Time screen.

5.2. Enabling the Transmit AutoPad Option

You can set up the DominoFE interface to automatically pad short frames that are to be transmitted by the analyzer by enabling the **Tx AutoPad** option on the Line Setup dialog box (Figure 5-1). When the **Tx AutoPad** option is enabled, transmit frames are padded with bytes containing hexadecimal 55 patterns to be a minimum of 60 bytes, excluding the frame check sequence (FCS).

To enable the transmit autopad option:

1. Under **TX Setup** on the Line Setup dialog box, select the **Tx AutoPad Enable** option.

Tx AutoPad Enable is a toggle option. A checkmark appears in the box beside the option when it is enabled.

2. Click **OK**.

The options that you selected are accepted and you return to the Fast Ethernet Main Setup dialog box.

3. Click **OK**.

The setup selections are saved and you return to the Workbench screen or to the Real Time screen. From Real Time, a prompt is issued about whether to restart your application before returning you to the Real Time screen.

5.3. Enabling the Transmit Preamble Option

You can insert a preamble pattern in frames to be transmitted by the analyzer by enabling the **Tx Preamble** option on the Line Setup dialog box. A preamble indicates the beginning of frame transmission and provides a means of signal synchronization for a receiver.

When the **Tx Preamble** option is enabled, a group of seven bytes, each containing the pattern 10101010, is added to the beginning of the transmit frame prior to the start-of-frame delimiter. The **Tx Preamble** option is enabled as a default option.

To enable the transmit preamble option:

1. Under **TX Setup** on the Line Setup dialog box, select the **Tx Preamble Enable** option.
Tx Preamble Enable is a toggle option. A checkmark appears in the box beside the option when it is enabled.
2. Click **OK**.
The options that you selected are accepted, and you return to the Fast Ethernet Main Setup dialog box.
3. Click **OK**.
The setup selections are saved, and you return to the Workbench screen or to the Real Time screen. From Real Time, a prompt is issued about whether to restart your application before returning you to the Real Time screen.

5.4. Enabling the Receive Group Address Option

You can specify that the last four bits of the destination address be ignored in frames received by the analyzer by enabling the **Rx Grp Addr** option on the Line Setup dialog box.

When the receive group address option is enabled, the last four bits of the destination address are ignored when comparing the address to determine whether or not the network frame is designated for the DominoFE analyzer.

To enable the receive group address option:

1. Under **RX Setup** on the Line Setup dialog box, select the **Rx Grp Addr Enable** option.

Rx Grp Addr Enable is a toggle option. A checkmark appears in the box beside the option when it is enabled.

2. Click **OK**.

The options that you selected are accepted, and you return to the Fast Ethernet Main Setup dialog box.

3. Click **OK**.

The setup selections are saved, and you return to the Workbench screen or to the Real Time screen. From Real Time, a prompt is issued about whether to restart your application before returning you to the Real Time screen.

NOTE:

This option has no effect when the **All Frames** receive mode option is selected.

5.5. Filtering Network Traffic by Frame Type

You can specify the type of frames to be received by the analyzer by using the **Receive Mode** option on the Line Setup dialog box. You can receive all network frames, filter in station and broadcast frames, or filter in multicast frames.

NOTE:

To filter network traffic for pause frame types, use the Protocol Filter/Trigger Setup dialog box. See Section 6.3.2.3, "Filtering Network Traffic for Pause Frames" in the "Filtering and Triggering" chapter.

To filter network traffic by frame type:

1. Under **Receive Mode** on the Line Setup dialog box, do one of the following:
 - Select the **All Frames** option.
Specifies that the analyzer is to receive all network frames.
 - Select the **Station & Broadcast Frames** option.
Specifies that the analyzer is to receive frames with its own destination address and all broadcast frames.
 - Select the **Multicast Frames** option.
Specifies that the analyzer is to receive frames with its own destination address, all broadcast frames and all multicast frames.
2. Click **OK**.
The options that you selected are accepted, and you return to the Fast Ethernet Main Setup dialog box.
3. Click **OK**.
The setup selections are saved, and you return to the Workbench screen or to the Real Time screen. From Real Time, a prompt is issued about whether to restart your application before returning you to the Real Time screen.

NOTE:

The **Rx Grp Addr** option has no effect when the **All Frames** receive mode option is selected.

6. Filtering and Triggering

6.1. Working With Filters and Triggers

Network frames are first received by the DominoFE analyzer and filtered according to the **RX Setup** options on the Line Setup dialog box before being processed by the analyzer's filter/trigger utility. The filter/trigger utility allows you to create up to nine definitions that can be applied simultaneously as filter and trigger criteria to received network traffic. Multiple filter/trigger definitions are applied to received data using a logical-OR methodology.

The filter function scans received network traffic for the specified filter condition and either saves the data to the capture buffer or discards it, depending on the selected filter **Method** option. The trigger function scans received network traffic for the specified trigger criteria or event, and sets the trigger point in the capture buffer when it occurs, filling the capture buffer according to the specified trigger criteria and **Post Trigger Capture** option.

The Filter/Trigger Setup dialog box offers two basic options for filter/trigger definitions: **Method** and **Post Trigger Capture**. The filter **Method** option applies only to designated filter criteria, and the **Post Trigger Capture** option applies only to designated trigger criteria. When both filters and triggers are defined, these two options together determine the disposition of data in the capture buffer.

Using Filters Only

When using filters only, the entire capture buffer is used to store filtered network data. The **Method** option determines the disposition of data in the capture buffer.

If you are filtering "In" network data, then data matching any of the specified filter criteria is stored in the capture buffer. If you are filtering "Out" network data, then data matching any of the specified filter criteria is excluded from the capture buffer.

Once the capture buffer is full (at 100%), the buffer begins to wrap and newly captured data overwrites the oldest data in the buffer (unless you have selected the **Stop at End** option for the Domino analyzer's capture buffer).

Using Triggers Only

When using triggers only, the received data is screened for any of the specified trigger conditions. The analyzer uses the entire capture buffer for storing network data until any of the specified trigger conditions are met.

The **Post Trigger Capture** option determines the percentage of the capture buffer that is used to store network data after a trigger event occurs. Capturing stops when the specified **Post Trigger Capture** condition is met. The remainder of the capture buffer contains network data received prior to the trigger event.

Using Both Filters and Triggers

When using both filters and triggers, the analyzer always processes the received network data according to the specified filter conditions, whether or not a trigger event has occurred.

The analyzer uses the entire capture buffer for storing filtered data until any of the specified trigger conditions are met. Once a trigger event occurs, then that percentage of the capture buffer selected in the **Post Trigger Capture** option is used to store filtered network data since the trigger event occurred. Network data is still processed in or out of the capture buffer according to the filter **Method** option and the defined filter conditions.

Capturing stops when the specified **Post Trigger Capture** condition is met. So, part of the buffer contains filtered data captured prior to the trigger event, and part of the buffer contains filtered data captured after the trigger event, where the percentages are determined by the **Post Trigger Capture** option.

NOTES:

- The 16 MB capture RAM consists of 128 pages of storage, with each page storing 128 kilobytes of data. If you specify a post trigger capture of 0%, the analyzer completes filling the current page of RAM storage when the trigger event occurs. Therefore, the last frame in the capture buffer is not necessarily the trigger frame, depending on how much data has already been stored in the current page of RAM.
- Trigger events are displayed in the Events Window.

For information about setting up the DominoFE interface line to filter frame types, see Section 5.5, "Filtering Network Traffic by Frame Type" in the "Setting Up the DominoFE Interface Line" chapter.

6.2. Setting Up Filtering and Triggering

You can use the Filter/Trigger Setup dialog box (Figure 6-1) to specify the filter/trigger conditions to be applied to received network traffic.

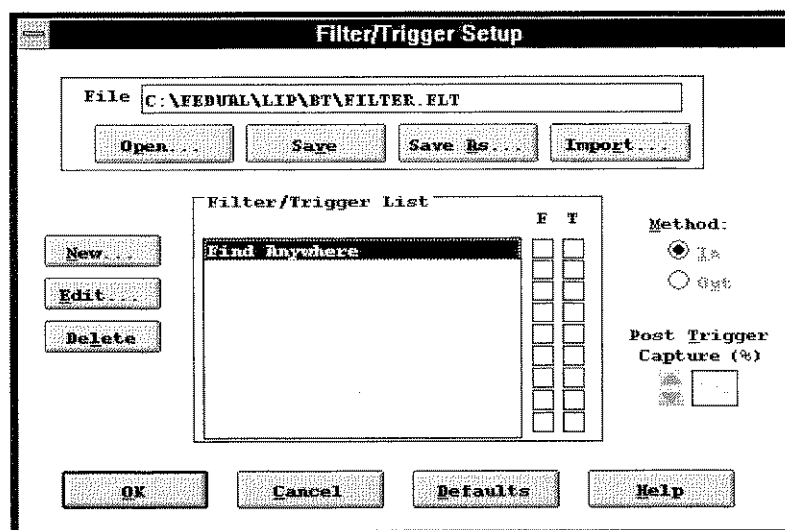

Figure 6-1. Filter/Trigger Setup dialog box

You can specify up to nine definitions at one time to be applied as both filters and triggers to the received data. Multiple filter/trigger definitions are applied to the received data using a logical-OR methodology. A standard filter/trigger definition included in the utility is called the **Find Anywhere** filter/trigger. When specified, the **Find Anywhere** filter/trigger allows you to search for up to eight contiguous bytes throughout an entire frame.

Other filter/trigger utility options include the ability to filter network traffic in or out of the capture buffer and to specify the percentage of the capture buffer to be filled after a trigger event.

To set up the filter/trigger:

1. From the Fast Ethernet Main Setup Dialog Box click **Filt/Trig**.
The Filter/Trigger Setup dialog box is displayed.
2. To define a new filter/trigger definition, click **New** and create a filter/trigger definition.
The filter/trigger definitions that you created are displayed in the **Filter/Trigger List**.
3. To copy filter/trigger definitions from another filter file, click **Import**.
The filter/trigger definitions that you copied are displayed in the **Filter/Trigger List**.
4. To search for eight contiguous bytes of data anywhere in the frame, set up the **Find Anywhere** filter/trigger.
The **Find Anywhere** filter/trigger is always displayed in the **Filter/Trigger List**, and contains hexadecimal X values in all eight bytes as the default setup.
5. If you have set up a filter, select the filter **Method**.
The received network data will be filtered into or out of the capture buffer according to the option that you selected.
6. If you have set up a trigger, specify the **Post Trigger Capture** buffer percentage.
The default selection is 100 percent. When a trigger occurs, the percentage of the capture buffer that you specified is used to store filtered data since the trigger event. The disposition of data in the remaining percentage of the capture buffer depends upon the applied criteria.
7. Click **OK**.
The filter/trigger utility options that you set up are temporarily accepted, and you return to the Fast Ethernet Main Setup dialog box. Setup selections are not stored in the filter/trigger file until you click **OK** on the Fast Ethernet Main Setup dialog box.
8. Click **OK**.
The main setup dialog box and all of the child setup dialog box selections are saved. Filter/trigger setup selections are saved in the filter/trigger file. You return to the Workbench screen or to the Real Time screen. From Real Time, a prompt is issued about whether to restart your application before returning you to the Real Time screen.

NOTES:

- The 16 MB capture RAM consists of 128 pages of storage, with each page storing 128 kilobytes of data. If you specify a post trigger capture of 0%, the analyzer completes filling the current page of RAM storage when the trigger event occurs. Therefore, the last frame in the capture buffer is not necessarily the trigger frame, depending on how much data has already been stored in the current page of RAM.
- You can also filter received network traffic using the **Rx Setup** options on the Line Setup dialog box. Network frames are first received by the analyzer and filtered according to the **Rx Setup** options before being sent to the capture buffer.

6.2.1. Selecting the Filter Method

You can include or exclude network data from the capture buffer using the **Method** option on the Filter/Trigger Setup dialog box. The **Method** option applies only to filters.

Your choices for the filter **Method** are **In** (default) or **Out**. When you choose **In**, the network data matching the specified filtering criteria is collected in the capture buffer. When you choose **Out**, all of the network data except that matching the specified filtering criteria is collected in the capture buffer.

To select the filter method:

- ◆ From the Filter/Trigger Setup dialog box, do one of the following:
 - Choose **In**.
Network data matching the filter criteria is filtered into the capture buffer. This is the default selection.
 - Choose **Out**.
Network data matching the filter criteria is filtered out of the capture buffer.

6.2.2. Setting Up the Post Trigger Capture

You can specify the percentage of the capture buffer to be used for collecting network data after a selected trigger event occurs by using the **Post Trigger Capture** option on the Filter/Trigger Setup dialog box. This option applies only to triggers.

You can select the percentage using the spin buttons, or you can enter a percentage between 0 and 100 directly in the edit box. The default selection is 100 percent.

The disposition of data in the capture buffer is determined by the defined filters and triggers, and post trigger capture percentage. If the analyzer is filtering only, then the entire capture buffer is used to store data according to the filtering criteria and filter **Method** option.

If both filters and triggers are defined, then the analyzer uses the entire capture buffer for storing filtered data until the trigger conditions are met. Then, according to the selected post trigger capture percentage, that percentage of the capture buffer is used to store filtered network data captured after the trigger event occurred. So, part of the buffer contains filtered data captured prior to the trigger event, and part of the buffer contains filtered data captured after the trigger event.

To set up the post trigger capture:

- ◆ From the Filter/Trigger Setup dialog box, do one of the following:
 - Use the spin arrow buttons next to the **Post Trigger Capture** edit box to select a percentage number.
The box displays the percentage number that you selected.
 - Enter a value from **0** to **100** directly into the **Post Trigger Capture** edit box.
The box displays the percentage number that you selected.

NOTES:

- The size of the actual capture RAM used may be one percent larger or smaller than the number that you selected in the **Post Trigger Capture** option.
- The 16 MB capture RAM consists of 128 pages of storage, with each page storing 128 kilobytes of data. If you specify a post trigger capture of 0%, the analyzer completes filling the current page of RAM storage when the trigger event occurs. Therefore, the last frame in the capture buffer is not necessarily the trigger frame, depending on how much data has already been stored in the current page of RAM.

6.3. Creating a Filter/Trigger Definition

The filter/trigger utility allows you to specify up to nine definitions at one time to be applied as both filters and triggers to received data. You can create filter/trigger definitions or copy them from another filter file using the Import option. Multiple filter/trigger definitions are applied to the received data using a logical-OR methodology.

To create a filter/trigger definition, you can specify byte patterns that you want to screen for in received frames. You can use X values as wildcard characters in these patterns to ignore the contents in that location during filtering of a frame.

A standard filter/trigger definition included in the utility is called the **Find Anywhere** filter/trigger. When specified, the **Find Anywhere** filter/trigger allows you to search for up to eight contiguous bytes throughout an entire frame.

The filter/trigger utility allows you to set up a filter/trigger definition by protocol and encapsulation type, or to set up a custom filter/trigger. The protocol setup method provides a template that allows you to set up a filter on the source and destination address fields of a frame according to the protocol type that you select, and to filter by frame error condition. The custom setup method displays a list of the 116-byte patterns for the filter/trigger definition and allows you to edit the definition using binary, decimal, or hexadecimal formats.

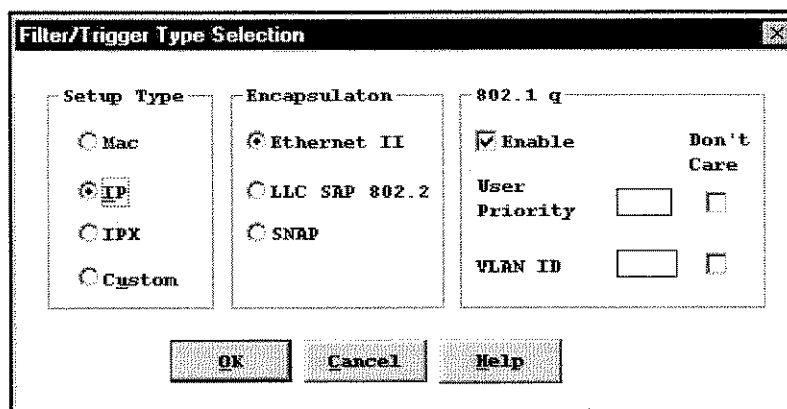

Figure 6-2. Filter/Trigger Type Selection dialog box

After you create a filter/trigger definition using the protocol method, you can also view or edit the contents of the definition using the custom method.

To create a filter/trigger definition:

1. From the Filter/Trigger Setup dialog box, click **New**.
The Filter/Trigger Type Selection dialog box is displayed.
2. Do one of the following:
 - To set up a protocol filter/trigger definition, select the **MAC**, **IP**, or **IPX** option. Depending on the protocol type that you select, you can choose a protocol encapsulation option, enable the **802.1q** option, and specify a **VLAN ID** and **User Priority**.
 - To set up a custom filter/trigger definition, select the **Custom** option.
3. Click **OK**.
The Protocol Filter/Trigger Setup dialog box or the Custom Filter/Trigger Setup dialog box is displayed according to the options that you selected.

6.3.1. Defining a Filter/Trigger Using the Custom Setup Method

You can use the Custom Filter/Trigger Setup dialog box (Figure 6-3) to specify byte patterns as filter/trigger criteria for the first 116 bytes of a frame. The byte patterns can be entered in hexadecimal, decimal, or binary format.

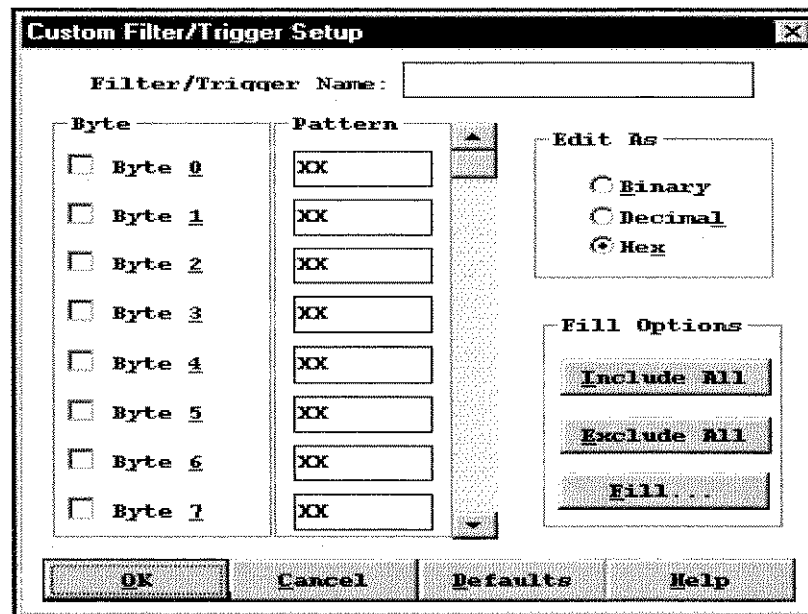

Figure 6-3. Custom Filter/Trigger Setup dialog box

Values can be entered in the byte **Pattern** boxes by either specifying values for individual bytes or by using the Custom Filter/Trigger Fill Setup dialog box. The Custom Filter/Trigger Fill Setup dialog box allows you to quickly replicate a specified pattern in a range of bytes, or in all 116 bytes of the filter/trigger definition.

You can select certain bit or byte patterns as wildcard characters to be ignored in the filter by placing an X in the corresponding field position. Received frames can contain any value in the positions specified with an X to match the filter condition. These X values are the default entries for the **Custom filter/trigger** fields.

To define a filter/trigger using the custom setup method:

1. From the Filter/Trigger Setup dialog box, click **New**.
The Filter/Trigger Type Selection dialog box is displayed.
2. Select the **Custom** option and click **OK**.
The Custom Filter/Trigger Setup dialog box is displayed.
3. In the **Byte** boxes, choose the checkboxes of the bytes you want to select for the filter/trigger definition.
The checkboxes of the bytes that you selected contain a checkmark.
4. In the **Edit As** box, select a format.
The pattern values are displayed and edited in the format that you selected.
5. To enter values in the byte **Pattern** boxes, do one of the following:
 - Enter values directly into the individual byte **Pattern** boxes.
 - Click **Fill**, to use the Custom Filter/Trigger Fill Setup dialog box.The received frames will be filtered according to the values specified in the byte locations that you selected.
6. In the **Filter/Trigger Name** box, enter a name for the filter/trigger definition.
The name that you specified is displayed in the **Filter/Trigger Name** box.
7. Click **OK**.
The dialog box selections are accepted, and you return to the Filter/Trigger Setup dialog box. The filter name is displayed in the **Filter/Trigger List**.
8. In the **Filter/Trigger List**, select the **F** or **T** (or **both**) checkbox beside the filter name.
A checkmark appears in the box that you selected, and the definition is set up as a filter (F), a trigger (T), or both a filter and a trigger. The corresponding filter **Method** or **Post Trigger Capture** option is enabled.

NOTE:

When single X bits are specified in binary, and you change the format to hexadecimal, a message box appears notifying you of an invalid conversion. The conversion is not performed. To avoid invalidating your data when specifying binary X bit values, select a format and maintain its use throughout the editing of the Custom filter/trigger.



If you want to change formats when entering patterns and also specify binary X bit values, edit all the patterns that are not going to have X bit values first, in hexadecimal or decimal format. Select the **Binary** format last to enter the final patterns, including the X bit values.

6.3.1.1. Using the Edit As Option

The **Edit As** option allows you to select the format (hexadecimal, decimal, or binary) in which to display and edit the byte patterns on the Custom Filter/Trigger Setup dialog box.

You are not restricted to editing all patterns in a single format; however, all patterns will always be displayed in the last format that you selected.

When you change the **Edit As** format option after entering some patterns, the values that you have already entered in the pattern boxes are converted to the newly selected format. This conversion works best when you are not specifying X values for any bits in the field values.

If you have specified single X bits in binary, and you change the format to hexadecimal, a message box is displayed notifying you of an invalid conversion. The conversion is not performed. To avoid invalidating your data when specifying binary X bit values, select a format and maintain its use throughout the editing of the custom filter/trigger.



If you want to change formats when entering patterns and also specify binary X bit values, edit all the patterns that are not going to have X bit values first, in hexadecimal or decimal format. Select the **Binary** format last to enter the final patterns, including the X bit values.

6.3.1.2. Selecting a Fill Pattern

You can specify a value, or pattern, to be replicated in a range of bytes or in all 116 bytes of the filter/trigger definition, using the Custom Filter/Trigger Fill Setup dialog box (Figure 6-4).

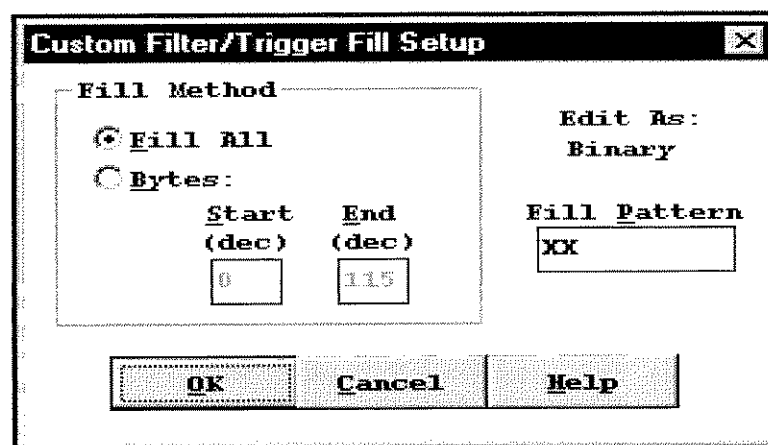

Figure 6-4. Custom Filter/Trigger Fill Setup dialog box

The filter fill function is useful when you want to set up most (or a large group) of the filter bytes with the same pattern. You can fill the entire filter with the specified pattern, and then go back to edit the specific bytes that you want to change.

The pattern can be entered in hexadecimal, decimal, or binary formats.

To select a fill pattern:

1. In the **Edit As** box, choose the format in which you want to display and edit the byte patterns.
 - The patterns are displayed and edited in the format that you selected.
2. In the **Fill Options** box, click **Fill**.
 - The Custom Filter/Trigger Fill Setup dialog box is displayed.
3. In the **Fill Pattern** box, specify a value to be replicated in the filter/trigger definition.
 - The value to be replicated is displayed in the **Fill Pattern** box.
4. In the **Fill Method** box, do one of the following:
 - To enter the fill pattern in all 116 bytes of the definition, select the **Fill All** option.
 - To enter the fill pattern in a specific byte range, select the **Bytes** option. Then enter the beginning and ending bytes (decimal) in the **Start** and **End** boxes.
5. Click **OK**.
 - The fill pattern that you specified is entered in the bytes that you selected, and you return to the Custom Filter/Trigger Setup dialog box.

6.3.2. Defining a Filter/Trigger Using the Protocol Setup Method

The protocol setup method provides a convenient way to select protocol-specific information in a filter/trigger definition.

6.3.2.1. Filtering Network Traffic by Protocol Address

You can use the Protocol Filter/Trigger Setup dialog box (Figure 6-5) to set up filtering of received data by the source and destination address fields of a frame. The contents of the filter/trigger definition that you create using the protocol method can also be displayed and edited using the custom method.

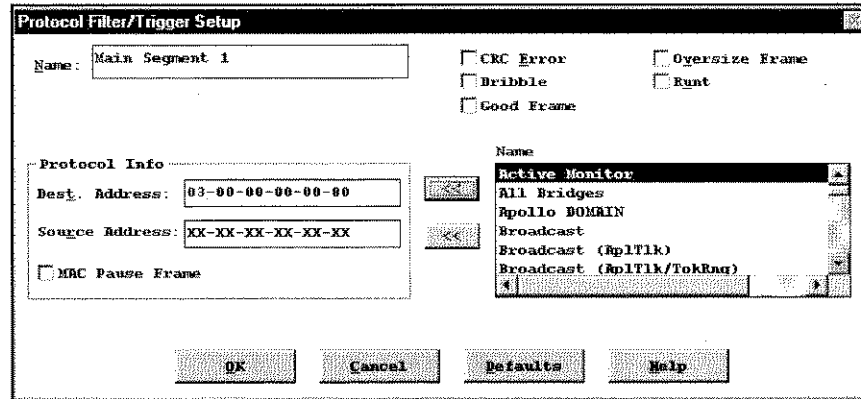

Figure 6-5. Protocol Filter/Trigger Setup dialog box

To filter network traffic by protocol address:

1. From the Filter/Trigger Setup dialog box, click **New**.
The Filter/Trigger Type Selection dialog box is displayed.
2. Select the **MAC**, **IP**, or **IPX** Setup Type and click **OK**.
The Protocol Filter/Trigger Setup dialog box is displayed. The addressing format appears according to the Setup Type that you selected.
3. To filter on a specific protocol destination and source address, do one of the following:
 - Select the symbolic name of the station in the list and click the arrow button to automatically add the corresponding address to the destination or source address box.
 - Or, you can specify the address directly in the **Dest. Address** or **Source Address** edit boxes.

4. In the **Name** box, enter a name for the filter/trigger definition.
The name that you specified is displayed in the **Filter/Trigger Name** box.
5. Click **OK**.
The dialog box selections are accepted, and you return to the Filter/Trigger Setup dialog box. The filter name is displayed in the **Filter/Trigger List**.
6. In the **Filter/Trigger List**, select the **F** or **T** (or **both**) checkbox beside the filter name.
A checkmark is displayed in the box that you selected, and the definition is set up as a filter (F), a trigger (T), or both a filter and a trigger. The corresponding filter **Method** or **Post Trigger Capture** option is enabled.

6.3.2.2. Filtering Network Traffic by Frame Error Condition

You can use the Protocol Filter/Trigger Setup dialog box (Figure 6-5) to set up filtering of received data by the frame error condition. The available options are CRC error, dribble, good frame, oversize frame, and runt.

The frame error options on the Protocol Filter/Trigger Setup dialog box are specified in an additive fashion, so they are logically ANDed. Therefore, multiple option selections specify that a frame must meet all of the selected conditions in order to match the filter criteria. For example, selection of **CRC Error** and **Oversize Frame** specifies that a frame must be 1519 bytes or greater AND contain a CRC error to match the filter. To filter for frames without any error condition, be sure to select only the **Good Frame** option.

The contents of the frame error condition criteria that you create using the protocol setup method cannot be displayed or edited on the Custom Filter/Trigger Setup dialog box.

To filter network traffic by frame error condition:

1. From the Filter/Trigger Setup dialog box, click **New**.
The Filter/Trigger Type Selection dialog box is displayed.
2. Select a **Setup Type** (other than Custom) and click **OK**.
The Protocol Filter/Trigger Setup dialog box is displayed.
3. Select the type of frame conditions that you want to define.
Multiple frame error conditions are logically ANDed for the filter criteria.
4. In the **Name** box, enter a name for the filter/trigger definition.
The name that you specified is displayed in the **Filter/Trigger Name** box.
5. Click **OK**.

The dialog box selections are accepted, and you return to the Filter/Trigger Setup dialog box. The filter name is displayed in the **Filter/Trigger List**.

6. In the **Filter/Trigger List**, select the **F** or **T** (or **both**) checkbox beside the filter name.

A checkmark is displayed in the box that you selected, and the definition is set up as a filter (F), a trigger (T), or both a filter and a trigger. The corresponding filter **Method** or **Post Trigger Capture** option is enabled.

6.3.2.3. Filtering Network Traffic for Pause Frames

You can use the Protocol Filter/Trigger Setup dialog box (Figure 6-5) to filter pause frames in the data received by the analyzer.

To filter network traffic for pause frames:

1. From the Filter/Trigger Setup dialog box, click **New**.
The Filter/Trigger Type Selection dialog box is displayed.
2. Select **MAC** and click **OK**.
The Protocol Filter/Trigger Setup dialog box is displayed.
3. Select the **MAC Pause Frame** option.
4. In the **Name** box, enter a name for the filter/trigger definition.
The name that you specified is displayed in the **Filter/Trigger Name** box.
5. Click **OK**.
The dialog box selections are accepted, and you return to the Filter/Trigger Setup dialog box. The filter name is displayed in the **Filter/Trigger List**.
6. In the **Filter/Trigger List**, select the **F** or **T** (or **both**) checkbox beside the filter name.
A checkmark is displayed in the box that you selected, and the definition is set up as a filter (F), a trigger (T), or both a filter and a trigger. The corresponding filter **Method** or **Post Trigger Capture** option is enabled.

6.4. Setting Up the Find Anywhere Filter/Trigger Definition

The **Find Anywhere** filter/trigger is a standard definition included in the filter/trigger utility. You can use the **Find Anywhere** definition in combination with up to eight additional filter/trigger definitions, resulting in a total of nine possible filter/trigger definitions that can be saved to a filter/trigger file and applied to received data.

When specified, the **Find Anywhere** filter/trigger allows you to search for up to eight contiguous bytes throughout an entire frame. The **Find Anywhere** filter/trigger contains all "X" values as the default entries for the **Find Anywhere** definition fields. You can specify the content of the **Find Anywhere** filter/trigger definition using the Custom Filter/Trigger Setup dialog box.

The screenshot shows the 'Custom Filter/Trigger Setup' dialog box. At the top, the title bar reads 'Custom Filter/Trigger Setup'. Below the title bar, there is a text field labeled 'Filter/Trigger Name:' containing the text 'Find Anywhere'. The main area is divided into three sections:

- Byte/Pattern Table:** A table with two columns: 'Byte' and 'Pattern'. There are eight rows, each with a checkbox and a text input field. All checkboxes are unchecked, and all text input fields contain 'XX'.

Byte	Pattern
<input type="checkbox"/> Byte 0	XX
<input type="checkbox"/> Byte 1	XX
<input type="checkbox"/> Byte 2	XX
<input type="checkbox"/> Byte 3	XX
<input type="checkbox"/> Byte 4	XX
<input type="checkbox"/> Byte 5	XX
<input type="checkbox"/> Byte 6	XX
<input type="checkbox"/> Byte 7	XX
- Edit As:** A section with three radio buttons: 'Binary', 'Decimal', and 'Hex'. The 'Hex' radio button is selected.
- Fill Options:** A section with three buttons: 'Include All', 'Exclude All', and 'Fill...'. The 'Include All' button is highlighted.

At the bottom of the dialog box, there are four buttons: 'OK', 'Cancel', 'Defaults', and 'Help'.

Figure 6-6. Custom Filter/Trigger Setup for Find Anywhere definition

To set up the Find Anywhere filter/trigger definition:

1. Under **Filter/Trigger List** on the Filter/Trigger Setup dialog box, select the **Find Anywhere** name.

The **Find Anywhere** name is highlighted.

2. Click **Edit**.
The Custom Filter/Trigger dialog box is displayed.
3. Under **Edit As**, select a format.
The filter values are displayed and edited in the format that you selected.
4. Under **Byte**, select the checkboxes that correspond to the byte position for which you want to specify filter values.
A checkmark is displayed in the byte boxes that you selected.
5. In the box that corresponds to each selected byte, enter the pattern or value for which you want to search.
The received data will be parsed for the contiguous byte values that you specified.
6. Click **OK**.
The dialog box selections are accepted, and you return to the Filter/Trigger Setup dialog box.
7. Under **Filter/Trigger List**, select the **F** or **T** (or **both**) checkbox beside the **Find Anywhere** filter name.
A checkmark is displayed in the box that you selected, and the definition is set up as a filter (F), a trigger (T), or both a filter and a trigger. The corresponding filter **Method** or **Post Trigger Capture** option is enabled.

NOTES:

- You cannot rename the **Find Anywhere** filter/trigger definition.
- Certain rules govern the acceptability of format changes in the **Edit As** box when specifying bits to be ignored. A message is issued if attempted format changes are not compliant with the values specified in the byte fields.

6.5. Naming or Renaming a Filter/Trigger Definition

You can specify a name or description for a filter/trigger definition, or rename a filter/trigger definition, to identify it in the **Filter/Trigger List** on the Filter/Trigger Setup dialog box (Figure 6-1). You cannot modify the name of the **Find Anywhere** filter/trigger.

To name or rename a filter/trigger definition:

1. From the Filter/Trigger Setup dialog box, do one of the following:
 - Click **New** and select a setup method to create a new filter/trigger definition.
 - Select an existing filter/trigger definition and click **Edit**.

2. In the **Name** box on the Custom Filter/Trigger Setup dialog box or Protocol Filter/Trigger Setup dialog box, specify a name or description for the filter/trigger definition.

The name that you selected is displayed in the **Name** box.

3. Click **OK**.

The dialog box selections are accepted and the name appears in the **Filter/Trigger List** on the Filter/Trigger Setup dialog box.

NOTE:

A filter name is only used to identify a single filter/trigger definition (displayed in the **Filter/Trigger List**) within a filter/trigger file and is not the name of the filter file itself. The default DominoFE filter filename, FILTER.FLT, is stored on the hard disk. The FILTER.FLT file (or any filter file that you create) can contain up to nine filter/trigger definitions.

6.6. Modifying a Filter/Trigger Definition

You can use either the protocol or custom setup method to change the content of or rename an existing filter/trigger.

To modify a filter/trigger definition:

1. Under **Filter/Trigger List** on the Filter/Trigger Setup dialog box, select the name of the filter/trigger that you want to modify.

The name of the filter/trigger that you selected is highlighted.

2. Click **Edit**.

The Filter/Trigger Type Selection dialog box is displayed.

3. Do one of the following:

- Select the **Protocol** option and click **OK**.

The Protocol Filter/Trigger Setup dialog box is displayed, which allows you to modify the protocol address fields of the filter/trigger definition.

- Select the **Custom** option and click **OK**.

The Custom Filter/Trigger Setup dialog box is displayed, which allows you to modify the 116 byte fields of the filter/trigger definition.

NOTE:

The Custom Filter/Trigger dialog box is automatically displayed when the **Find Anywhere** filter/trigger is selected.

4. Modify the name or content of the filter/trigger definition.
5. Click **OK**.

The dialog box selections are accepted, and you return to the Filter/Trigger Setup dialog box.

6.7. Saving Filter/Trigger Utility Selections

There are two ways in which the filter/trigger setup and all of its child setup dialog boxes can be saved to the current filter/trigger file:

- By clicking **Save** on the Filter/Trigger Setup dialog box.
- By clicking **OK** on both the Filter/Trigger Setup dialog box and the Fast Ethernet Main Setup Dialog Box.

You can save the filter/trigger selections to another filter/trigger filename by choosing the **Save As** button.

To save filter/trigger selections:

1. From the filter/trigger child setup dialog box, click **OK**.

The dialog box selections on the child setup dialog box are accepted, and you return to the Filter/Trigger Setup dialog box.

2. Do one of the following:

- Click **Save**.

The filter/trigger setup and all of its child setup dialog box selections are saved to the current file displayed in the **File** box. You remain in the Filter/Trigger Setup dialog box.

- Click **Save As**.

The Save As dialog box is displayed, which allows you to save the filter/trigger selections to another filename (with extension .FLT) and location.

- Click **OK** on both the Filter/Trigger Setup dialog box and the Fast Ethernet Main Setup dialog box.

The filter/trigger setup and all of its child setup dialog box selections are accepted, and after choosing **OK** on the main setup dialog box, are saved to the current filter file.

NOTE:

The cancel operation is no longer valid if you have saved the dialog box selections to the filter/trigger file prior to clicking **Cancel** on the Filter/Trigger Setup dialog box.

6.8. Canceling Filter/Trigger Utility Selections

You can use the **Cancel** button on the Filter/Trigger Setup dialog box to cancel the Filter/Trigger Setup dialog box selections, and all of its child setup dialog box selections.

The **OK** and **Cancel** buttons on the Filter/Trigger Setup dialog box determine the disposition of all of the filter/trigger setup dialog box selections. If the **OK** button has been selected on a child setup dialog box, those child setup dialog box selections can be removed by choosing the **Cancel** button on the Filter/Trigger Setup dialog box.

To cancel filter/trigger utility selections:

1. To cancel filter/trigger selections on an individual child setup dialog box, click **Cancel** from the filter/trigger child setup dialog box.
The selections on the child dialog box are not accepted, and you return to the Filter/Trigger Setup dialog box.
2. To cancel all filter/trigger setup dialog box selections (including all child setup selections), click **Cancel** from the Filter/Trigger Setup dialog box.
None of the filter/trigger dialog box selections since the last save operation are accepted, and you return to the Fast Ethernet Main Setup dialog box.

NOTE:

The cancel operation is no longer valid if you have saved the dialog box selections to the filter/trigger file prior to clicking **Cancel** on the Filter/Trigger Setup dialog box.

6.9. Managing the Filter/Trigger List

Up to eight filter/trigger definitions can be set up in the **Filter/Trigger List** of a filter file, in addition to the **Find Anywhere** filter/trigger.

You can add or delete filter/trigger definitions from the **Filter/Trigger List** on the Filter/Trigger Setup dialog box.

6.9.1. Adding a New Definition to the Filter/Trigger List

You can add a new definition to the **Filter/Trigger List** on the Filter/Trigger Setup dialog box by creating a filter/trigger definition or copying a definition from another filter/trigger file to the filter/trigger list.

6.9.2. Copying a Definition to the Filter/Trigger List

You can copy a filter/trigger definition from another filter/trigger file using the Import Filter/Triggers dialog box (Figure 6-7).

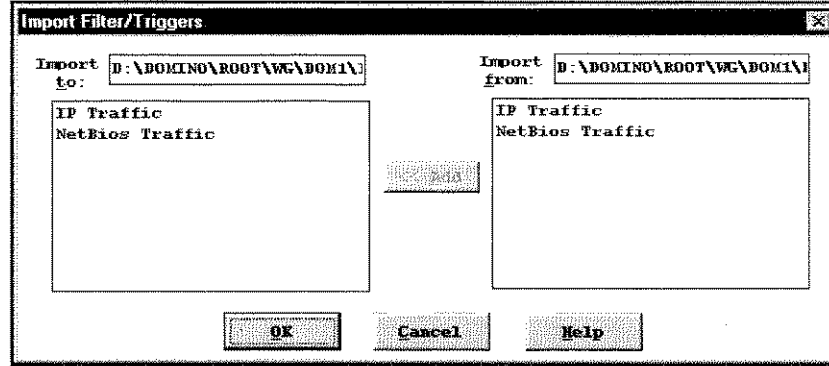

Figure 6-7. Import Filter/Triggers dialog box

To copy a definition to the filter/trigger list:

1. From the Filter/Trigger Setup dialog box, click **Import**.
The Open dialog box is displayed, and the filter/trigger files with extension .FLT are displayed in the file list box.
2. Select the filter filename and location from which you want to copy and click **OK**.
The Import Filter/Triggers dialog box is displayed to copy existing filter/trigger definitions to the current filter file.
3. From the **Import From** list, select the filter/trigger definition you want to add to the current filter/trigger file (Import To).
The filter/trigger definition that you selected is highlighted.
4. Click **Add**.
The filter/trigger definition that you selected in the **Import From** list is copied to the file displayed in the **Import To** box.

5. Click **OK**.

The filter/trigger definitions that you copied are added and displayed in the **Filter/Trigger List**. You return to the Filter/Trigger Setup dialog box.

NOTE:

The filter/trigger definition remains intact in the filter file from which it was copied.

6.9.3. Deleting a Definition From the Filter/Trigger List

You can remove a definition from the **Filter/Trigger List** using the **Delete** button on the Filter/Trigger Setup dialog box.

To delete a definition from the filter/trigger list:

1. Under **Filter/Trigger List** on the Filter/Trigger Setup dialog box, select the filter/trigger definition that you want to delete.

The filter/trigger definition that you selected is highlighted.

2. Click **Delete**.

The filter/trigger definition is removed from the filter/trigger list.

6.10. Managing Filter/Trigger Files

The default filter/trigger file for the DominoFE analyzer is called FILTER.FLT. Every time you set up a filter/trigger for a new application, the FILTER.FLT file is opened as the default file.

In addition to the default FILTER.FLT file, you can open and save other filter/trigger files (with extension .FLT) from the Filter/Trigger Setup dialog box. Filter/trigger files can be opened from or saved to any directory location. You can also import, or copy, filter/trigger definitions between filter/trigger files.

6.10.1. Opening a Filter/Trigger File

You can open an existing filter/trigger file using the **Open** button on the Filter/Trigger Setup dialog box.

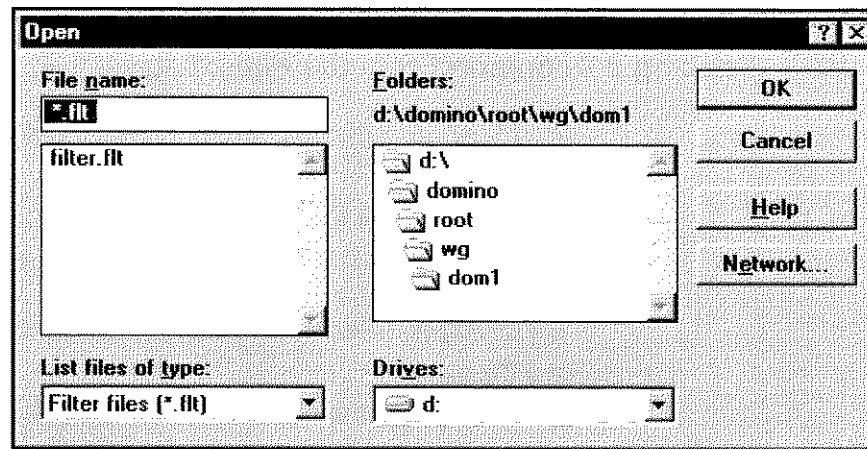

Figure 6-8. Open Dialog Box for filter/trigger files

To open a filter/trigger file:

1. From the Filter/Trigger Setup dialog box, click **Open**.
The Open dialog box is displayed (Figure 6-8), and the filter/trigger files with extension .FLT are displayed in the file list box.
2. Select the location and name of the filter/trigger file that you want to open, and click **OK**.
You return to the Filter/Trigger Setup dialog box. The name of the filter/trigger file that you opened is displayed in the **File** box, and the contents of the filter/trigger file that you opened is displayed.

6.10.2. Saving a Filter/Trigger File

You can save all of the filter/trigger dialog box selections to the filter/trigger file that is currently open by clicking **OK** or **Save** on the Filter/Trigger Setup dialog box.

You can save the current filter/trigger file to another filter/trigger file with a new name and location using the **Save As** button on the Filter/Trigger Setup dialog box.

To save the current filter/trigger file as another filter/trigger file:

1. From the Filter/Trigger Setup dialog box, click **Save As**.
The Save As dialog box is displayed.
2. Enter the location and name of the filter/trigger file that you want to save, and click **OK**.

The contents of the open filter/trigger file is saved to the filter/trigger filename and location that you selected. You return to the Filter/Trigger Setup dialog box, where the newly saved filter/trigger file is displayed.

NOTE:

The contents of the filter/trigger file from which the **Save As** operation was performed remains intact with its original filename and location.

6.10.3. Importing a Filter/Trigger File

You can import, or copy, custom filter/trigger definitions between filter/trigger files using the Import Filter/Triggers dialog box. A maximum of nine filter/trigger definitions can be stored in a filter/trigger file, including the **Find Anywhere** filter/trigger. You can only copy definitions to the filter/trigger file if the destination filter/trigger file contains less than eight custom filter/trigger definitions.

Definitions can only be copied between filter/trigger files in one direction—from the second filter/trigger file (Import From) to the original filter/trigger file opened in the Filter/Trigger Setup dialog box (Import To).

7. Setting Up for Auto-Negotiation

7.1. NWay Auto-Negotiation Overview

When the analyzer is configured for a TX Emulate connection, the DominoFE analyzer supports the NWay Auto-Negotiation algorithm according to the IEEE 802.3u specification.

Auto-Negotiation allows a network device to advertise its supported modes of operation out of band to a device at the remote end of a link segment. The network devices determine a compatible transmission mode based upon their advertised abilities. When more than one compatible transmission mode is available, a priority resolution table allows the devices to agree upon a single mode of operation.

The DominoFE analyzer supports 100 Mbps full-duplex, 100 Mbps half-duplex, 10 Mbps full-duplex, and 10 Mbps half-duplex transmission modes. The default analyzer setup enables the **NWay Auto-Negotiation** option and advertises all transmission modes. The network speed and duplex mode can be manually set up when the **NWay AutoNegotiation** option is disabled.

NOTE:

If you want to support NWay Auto-Negotiation between two DominoFE analyzers that are connected back-to-back, then both interfaces must have the **NWay Auto-negotiation** option enabled. It is not a valid test configuration if only one analyzer is set up for NWay-Autonegotiation.

7.2. Setting Up Auto-Negotiation Advertisement Options

You can set up the DominoFE analyzer auto-negotiation advertisement options using the Auto-Negotiation Advertisement Setup dialog box. Auto-negotiation is only supported when the interface is configured for the **TX Emulate (MDI or MDIX)** connection mode.

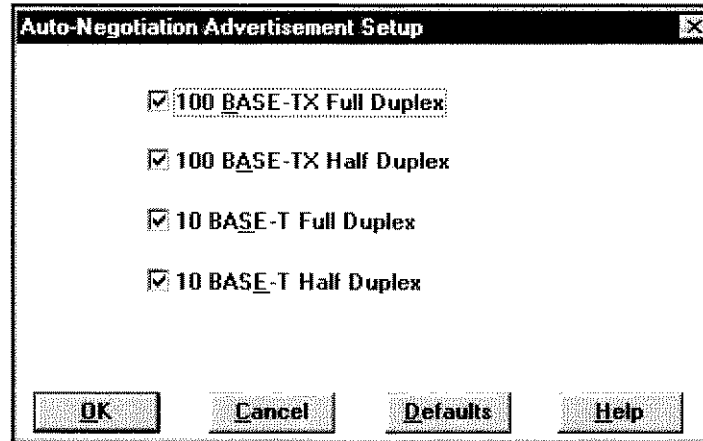

Figure 7-1. Auto-Negotiation Advertisement Setup dialog box

To set up auto-negotiation advertisement options:

1. Be sure the interface is configured for **TX Emulate (MDI or MDIX)** on the Fast Ethernet Main Setup dialog box.
2. Under **Interface Parameters** on the Fast Ethernet Main Setup dialog box, enable the **NWay AutoNegotiation** option.

A checkmark is displayed in the checkbox beside the **NWay AutoNegotiation** option when the option is enabled. The **AutoNeg** button is enabled and the **Speed** and **Duplex** options for manual set up are disabled.

3. Click **AutoNeg**.
The Auto-Negotiation Advertisement Setup dialog box is displayed.
4. Select one or more of the transmission modes that you want to advertise.
A checkmark is displayed in the checkbox beside the option(s) that you enabled. The default selection enables all auto-negotiation advertisement options.

5. Click **OK**.
The options that you selected are accepted, and you return to the Fast Ethernet Main Setup dialog box.
6. Click **OK**.
The setup selections are saved, and you return to the Workbench screen or to the Real Time screen. From Real Time, a prompt is issued about whether to restart your application before returning you to the Real Time screen.

8. Transmitting Network Traffic

8.1. Frame Transmission Overview

The DominoFE analyzer allows you to define, import, and transmit test frames at speeds of 10 Mbps or 100 Mbps on an Ethernet network when the analyzer is configured for **TX Emulate** or **MII Emulate**.

There are three main functions to perform when setting up the analyzer for frame transmission:

- Setting up transmit frames.
- Setting up the transmit queue.
- Setting up the transmit method.

The Transmit Screen is the main window from which all of the frame transmit functions are performed. The Transmit Screen allows you to select available frames for the transmit queue and to start and stop transmission of the queue.

From the Transmit Screen, you can access the following setup dialog boxes:

- Transmit Frame Setup dialog box to define and edit frames.
- Capture Frame Selections dialog box to import frames from an opened capture file.
- Transmit Queue Setup dialog box to set up the transmit queue and additional frame parameters.
- Transmit Method Setup dialog box to specify the frequency of transmission for the entire transmit queue.

All frame transmit parameters are saved to a default transmission file called TRANSMIT.BTX, which is stored in the root directory for the analyzer (for example, C:\DOMINO\DOM2 for the second analyzer in a stack).

8.2. Understanding the Transmit Buffer and Queue

The DominoFE analyzer uses both a transmit buffer and a transmit queue to transmit the frames that you have selected on the Transmit Screen. In setting up the analyzer to transmit frames, it is important to understand the size limits for the transmit buffer and queue and how the buffer and queue work together.

Transmit Buffer Capacity

The transmit buffer holds each frame that you have selected for transmission on the Transmit Screen, up to a total of 256 KB. The buffer does not hold all of the available frames that you have created or imported on the Transmit Screen—only those frames that you have selected.

You will exceed the transmit buffer capacity by:

- Selecting too many frames, whose total byte count exceeds 256 KB.
- Modifying the size of a selected frame that would increase the total byte count for all selected frames above 256 KB.

Transmit Queue Capacity

When you select the frames you want to transmit, the frames are loaded into the transmit buffer and then entered into the transmit queue. The queue controls the transmission parameters for each of the frames in the transmit buffer. It keeps track of the number of times a frame is transmitted and the order in which frames are transmitted by using pointers to the frames in the 256 KB transmit buffer.

The transmit queue supports transmission of up to 1000 frames (unique or repeated). A pointer is allocated for every frame in the queue, and for every number of times a frame is repeated in the queue, up to a total of 1000.

You will exceed the transmit queue capacity by:

- Selecting more than 1000 individual transmit frames on the Transmit Screen.
- Selecting transmit frames on the Transmit Screen and repeating those frames more than 1000 times cumulatively using the **Repeats** option on the Transmit Queue Setup dialog box.

8.3. Setting Up the Analyzer to Transmit Frames

Use the Transmit Screen to set up the analyzer to transmit frames. Once you have defined or imported frames for transmission, the most basic transmit setup procedure involves selecting from the available frames for transmission and starting the transmit queue. In this case, the default transmit queue options and transmit method options are used.

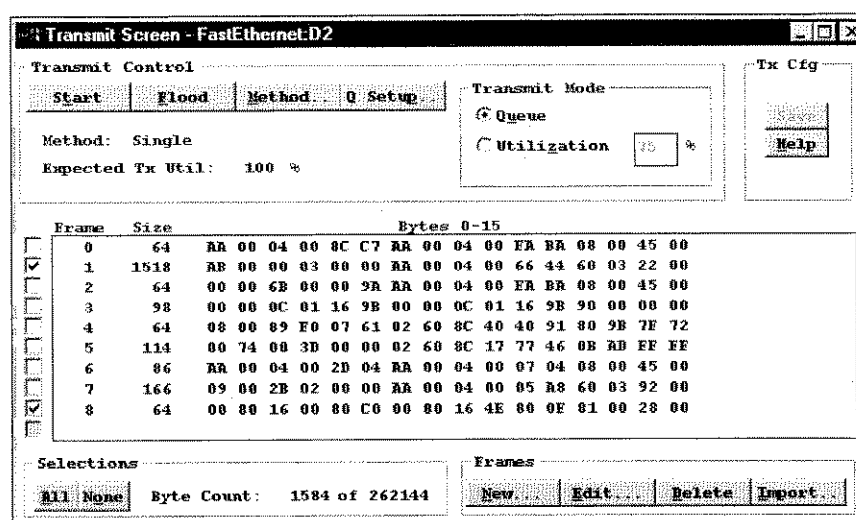

Figure 8-1. Transmit Screen

From the Transmit Screen, you can access additional setup dialog boxes to define new or edit existing frames, import frames from a capture file, and modify the default transmit queue and transmit method options.

To set up the analyzer to transmit frames:

1. Be sure the analyzer is configured for an **Emulate** connection.
You choose the connection type on the Fast Ethernet Main Setup dialog box.
2. If the frame you want to transmit is not in the list of frames on the Transmit Screen, set up a new transmit frame, modify an existing frame, or import a frame from a capture file.
The available frames for the transmit queue are displayed in the frame list on the Transmit Screen.

3. From the Transmit Screen, select the frames that you want to transmit.

The boxes next to the frames you want to transmit contain a checkmark, and the selected frame is placed into the transmit buffer and queue.

NOTE:

After you have selected frames for the queue, you can start frame transmission. The queue will be transmitted according to the default transmit queue options and transmit method options. If you are currently transmitting frames, you must stop and restart frame transmission to apply the new setup changes.

4. If you want to modify the queue order or edit a queue entry, set up the transmit queue options.

The transmit queue options are set up in the Transmit Queue Setup dialog box.

5. If you want to modify the number of times the queue is transmitted, set up the transmit method option.

The transmit method is set up in the Transmit Method Setup dialog box.

6. If you are currently transmitting frames, you must stop and restart frame transmission to apply the new setup changes.

NOTES:

- Frames are selected for transmission on the Transmit Screen, but the order in which they are actually transmitted is determined by the transmit queue.
- If you do not save the transmit file, the frame setup and all transmit dialog box selections are only available for the current transmit session.

8.4. Selecting Frames for Transmission

You can select all available frames or individually select frames for transmission on the Transmit Screen up to the limits of the transmit buffer (256 KB) and transmit queue (1000 entries). Frames are selected for transmission on the Transmit Screen, but the order in which they are actually transmitted is determined by the transmit queue.

The Transmit Screen displays the frame number, the frame size, and the first 16 bytes of each available transmit frame. A checkbox next to each frame specifies whether or not the frame is selected for the transmit buffer and queue. You can use the **Byte Count** display field on the Transmit Screen to track the number of selected bytes out of the total 256 KB transmit buffer capacity.

When you choose the **All** button from the **Selections** box on the Transmit Screen, the analyzer attempts to sequentially load as many frames as it can completely fit within the transmit buffer and queue. If the transmit buffer capacity or queue capacity is reached before all frames can be loaded, a message is issued. You may be able to individually select additional frames to fit into the remaining area of the transmit buffer.

To select/clear frames for transmission:

1. From the Transmit Screen, use the scroll box or scroll arrows to display the available frame you want to select or clear.

Up to ten available transmit frames are displayed at one time, in numerical frame order, on the Transmit Screen.

2. Do one of the following:

- To individually select or clear a transmit frame, select the checkbox next to the frame.

A checkmark is displayed in the box next to the frame that you selected, and the frame is entered into the transmit buffer and added to the bottom of the transmit queue. When a frame is cleared, the checkmark is removed and the frame is cleared from the transmit buffer and queue.

- To select all transmit frames, click **All in the Selections** box.

The analyzer sequentially loads as many frames as it can fit into the transmit buffer and the transmit queue. A checkmark is displayed in the box next to each selected frame.

- To clear all transmit frames, click **None** in the **Selections** box.

The analyzer clears all frames from the transmit buffer and queue.

3. If you are currently transmitting frames, you must stop and restart frame transmission to apply the new setup changes.

8.5. Importing Capture Frames for Transmission

You can use the Capture Frame Selections dialog box to import frames from a capture file to the transmit list on the Transmit Screen. You can open a capture file and import up to 1000 frames from it.

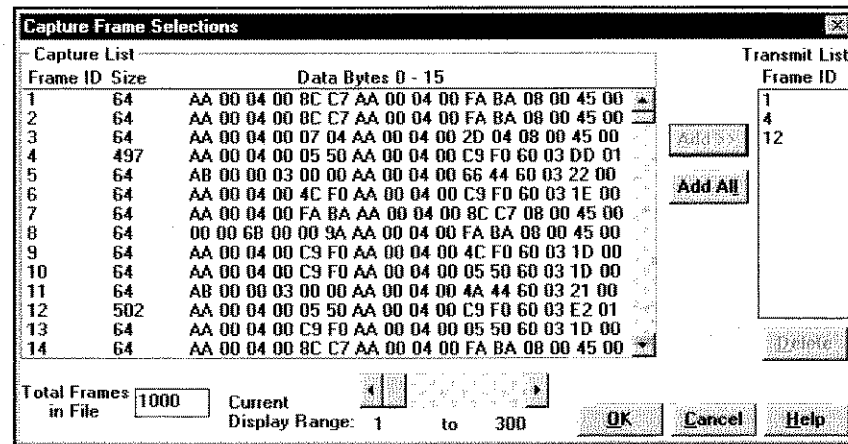

Figure 8-2. Capture Frame Selections dialog box

The range of capture frames that are displayed from the capture file is controlled by the **Current Display Range** scroll bar option, which allows you to select and display 300-frame blocks from the capture file. You can use the vertical scroll box to the right of the capture list to view other frames within the selected 300-frame block.

You can import up to the first 1536 bytes of original data for each captured frame. Once you have imported capture frames for transmission, they are available for selection to the transmit queue from the Transmit Screen. When a capture frame with length greater than 1536 is selected for the transmit queue, the first 1536 bytes of data are retained, and the remainder of the frame is padded with hexadecimal A5s.

NOTE:

The original FCS of an imported capture frame is copied by the analyzer but is not used by default. Since appending an FCS is the default option in the analyzer's transmit queue setup, the imported frame has a new FCS generated by the analyzer. If you want to use the original FCS of the imported capture frame, increase the frame size by 4 bytes on the Transmit Frame Setup dialog box and then clear the **Append FCS** option for the frame on the Transmit Queue Setup dialog box.

To import capture frames for transmission:

1. From the Transmit Screen, click **Import** and open the capture file from which you want to copy frames.
The Capture Frame Selections dialog box is displayed.
2. Select the 300-block range of capture frames that you want to display.
You can use the **Current Display Range** scroll bar to change the range of frames available for display in the Capture Frame Selections dialog box.
3. Select and add up to 1000 capture frames.
The **Frame ID** of the capture frames that you added are displayed in the **Transmit List** on the Capture Frame Selections dialog box. You can add up to 300 frames at one time. Repeat the process to add additional frames.
4. Click **OK**.
You return to the Transmit Screen and the capture frames that you imported are displayed in the transmit list.
5. Select the frames that you want to transmit.

8.5.1. Opening a Capture File

You can open a Domino capture file to import capture frames for the DominoFE interface using the **Import** button on the Transmit Screen.

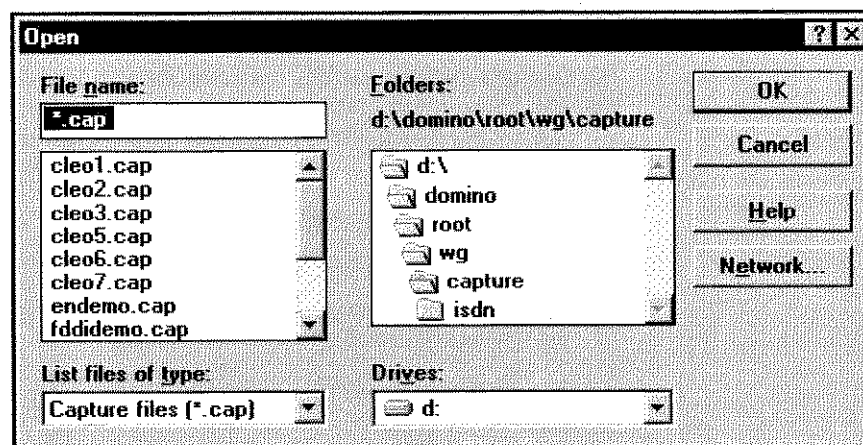

Figure 8-3. Open dialog box for capture files

To open a capture file:

1. From the Transmit Screen, click **Import**.
The Open dialog box is displayed (Figure 8-3), and the capture files in the root installation directory with extension .CAP are displayed in the file list box.
2. Select the location and name of the capture file that you want to open, and click **OK**.
The Capture Frame Selections dialog box is displayed (Figure 8-2).

8.5.2. Displaying Capture Frames

You can select the range of capture frames in the open capture file to be displayed on the Capture Frame Selections dialog box using the **Current Display Range** scroll bar option.

The total number of frames that are contained in the capture file is displayed in the **Total Frames in File** box. Not all of the capture frames from a large capture file can be displayed at one time in the **Capture List** box. The **Current Display Range** scroll bar allows you to page down proportionally through the frames in the capture file to select a 300-block range of frames for display.

The numbers to the left and right of the **Current Display Range** scroll bar represent the frame IDs of the first frame in the range and the last frame in the range, respectively. (Note that if the frame IDs between the first and last frames are not numbered consecutively, it may not appear that 300 frames are being displayed.)

The **Capture List** box displays the frame ID, size, and the first 16 bytes of each captured frame in the specified range of the capture file. You can use the vertical scroll box to the right of the capture list to view other frames in the selected range.

To select the current display range:

- ◆ In the **Current Display Range** scroll bar, do one of the following:
 - To adjust the range up or down by a single frame at a time, select the left or right scroll arrow.
 - To adjust the range proportionally within the capture file, move the scroll box.
 - To select the next block of 300 frames, select any area within the horizontal scroll bar to the right of the scroll box.

To display frames in the current range:

- ◆ Under **Capture List**, select the up or down scroll arrow or move the scroll box to view other frames in the selected 300-block range.

8.5.3. Adding a Capture Frame to the Transmit List

You can add 300 capture frames at a time to the **Transmit List**, up to a total of 1000 capture frames, using the **Add** or **Add All** buttons on the Capture Frame Selections dialog box. If you attempt to add more than 1000 frames, the surplus frames will not be accepted.

You can select a single frame, multiple frames, or all frames to be added to the transmit list. The Capture Frame Selections dialog box supports extended selection, so you can select multiple frames using a Shift-click, Ctrl-click, or hold and drag sequence with the left mouse button. The same capture frame cannot be added to the transmit list more than one time.

When a capture frame has been selected for the transmit list, the frame is set up with its original size, but only the first 1536 bytes of the original data are retained in the frame. When the frame is selected for the transmit queue, the remaining bytes are padded with A5s to complete the full capture frame length.

To add a capture frame to the transmit list:

- ◆ Do one of the following:
 - To add a single frame or group of frames to the transmit list, select the frames that you want to add and click **Add**.
The frames that you selected are highlighted, and the frame ID of the frames that you added are displayed in the **Transmit List** box.
 - To add all frames to the transmit list, click **Add All**.
The frame ID of the frames that you added are displayed in the **Transmit List** box.



You can double-click with the mouse on a single frame that you want to select to automatically add it to the transmit list.

8.5.4. Deleting a Capture Frame From the Transmit List

You can remove one or more capture frames that you just imported to the transmit list using the **Delete** button on the Capture Frame Selections dialog box. The Capture Frame Selections dialog box supports extended selection, so you can select multiple frames using a Shift-click, Ctrl-click, or hold and drag sequence with the left mouse button. The delete function removes the frame ID from the transmit list but leaves the original frame in the capture file intact.

If you want to delete a capture frame after you have already imported and added it to the transmit list on the Transmit Screen, you can use the **Delete** button on the Transmit Screen.

To delete a capture frame from the transmit list:

1. Under **Transmit List**, select the frame ID or group of frame IDs that you want to delete.
The frame IDs that you selected are highlighted.
2. Click **Delete**.
The selected frame IDs are removed from the transmit list.

8.6. Creating a Transmit Frame

You can use the Transmit Frame Setup dialog box (Figure 8-4) and the Frame Setup Wizard to create a new frame. From the Transmit Frame Setup dialog box, you can define a frame between 4 and 8192 bytes long and use the **Fill Control** options to specify a hexadecimal pattern to be replicated within the frame.

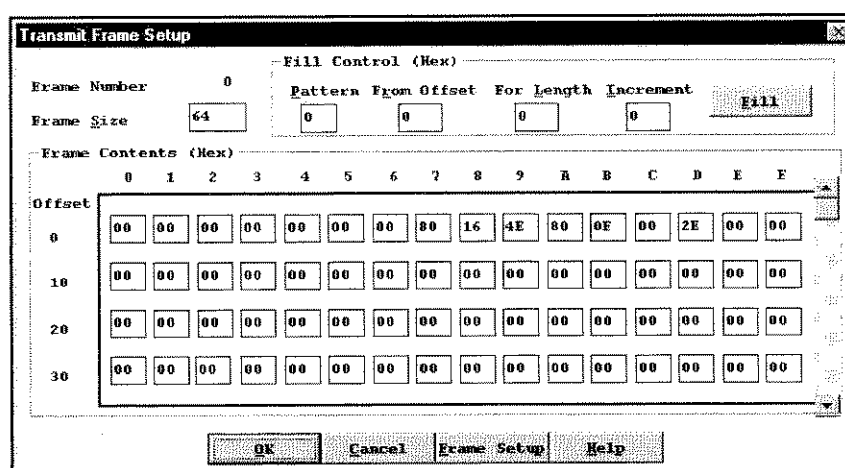

Figure 8-4. Transmit Frame Setup dialog box

To easily set up the source and destination address fields and protocol encapsulation information, you can use the Frame Setup Wizard by clicking the **Frame Setup** button.

To create a transmit frame:

1. From the Transmit Screen, click **New** in the Frames box.
The Transmit Frame Setup dialog box is displayed with the next available frame number.
2. Under **Frame Size**, enter the size (in bytes, including FCS) of the frame you want to define.
The frame size is entered in decimal, between 4 and 8192 bytes.
3. To enter hexadecimal values in the bytes of the frame, do one of the following:
 - In the **Fill Control** box, select the options to replicate a fill pattern in the frame.

- In the **Frame Contents** box, enter the values directly in the byte locations.

The fill pattern or byte values that you entered are displayed in hexadecimal in the byte locations that you selected.

4. To open the Frame Setup Wizard to specify protocol-specific addressing and encapsulation options, click **Frame Setup**. The Frame Setup Wizard - Ethernet dialog box is displayed (Figure 8-5).

Select the protocol options that you want to specify, and click **Finish** to return to the Transmit Frame Setup dialog box.

5. Click **OK**.

Protocol validation is performed on the first 1536 bytes of the transmit frame. If there are any errors, such as a mismatch between the frame length specified in the Ethernet header and the length of the frame in the Transmit Frame Setup dialog box, then you are given an option to correct the problem.

The frame that you specified is accepted, and you return to the Transmit Screen. The frame number, size, and first 16 bytes of the frame that you set up is displayed in the Transmit Screen.

NOTE:

The specified frame size does not determine how many bytes can be edited in the **Frame Contents** boxes. You can always edit 1536 bytes regardless of the frame size.

For more information about setting up a transmit frame using the Frame Setup wizard, see Section 8.7, "Using the Frame Setup Wizard" in this chapter.

8.6.1. Selecting the Frame Size

You can select or modify the size of a transmit frame in the **Frame Size** box on the Transmit Frame Setup dialog box (Figure 8-4). The frame size (in bytes) is entered in decimal format, and can be between 4 and 8192 bytes. The frame size does not include the number of FCS bytes, which are appended to the frame when the **Append FCS** option is enabled.

Very short frames (less than 20 bytes) with a minimum interframe gap of 1.2 microseconds cannot be transmitted reliably in continuous mode.

To select the frame size:

- ◆ Under **Frame Size** on the Transmit Frame Setup dialog box, enter the size of the frame (as a decimal number of bytes).

The size that you entered is displayed in decimal in the **Frame Size** box.

NOTES:

- The total number of bytes in a transmit frame is the frame size plus four bytes for the FCS, if appended.
- The byte count on the Transmit Screen displays the total number of bytes rounded to the nearest multiple of 4 for each selected frame. So, a frame that is 65 bytes long is counted as a 68-byte frame, a 5-byte frame is counted as an 8-byte frame, and so on. The total number of bytes displayed on the Transmit Screen would be 76 bytes for a 65-byte frame and a 5-byte frame.

8.6.2. Selecting a Fill Pattern

You can use the **Fill Control** box on the Transmit Frame Setup dialog box (Figure 8-4) to quickly enter the same hexadecimal data pattern into multiple bytes of the frame. You can also increase the value of each subsequent byte (in the specified range) by an incremental value. All values are specified in hexadecimal format.

For example, a pattern AB from offset 0 for length 10, will fill bytes 0 through 9 with the value AB. A pattern 00 from offset 10 for length 5 with an increment of 2, will fill byte 10 with 00, byte 11 with 02, byte 12 with 04, byte 13 with 06, and byte 14 with 08.

This function is useful when you want to set up most of the frame, or a large group of bytes in the frame, with the same pattern. You can fill the entire frame with the specified pattern and then go back to edit the specific bytes that you want to change.

To select a fill pattern:

1. Under **Pattern** on the Transmit Frame Setup dialog box, enter the value that you want to repeat in specified bytes of the frame.
The hexadecimal value that you specified is displayed in the pattern box.
2. Under **From Offset**, enter the beginning offset of the byte to contain the pattern.
When the fill is performed, the pattern will be entered in the byte position that you specified.
3. Under **For Length**, enter the number of bytes from the offset byte to contain the pattern.
When the fill is performed, the pattern will be replicated for the number of bytes that you specified.
4. Under **Increment**, enter the value to be added to each previous byte pattern.

When the fill is performed, the first byte will contain the pattern. Each subsequent byte specified for the fill will contain the replicated value of the previous byte, increased by the value that you specified.

5. Click **Fill**.

The pattern that you specified is entered in the corresponding bytes of the **Frame Contents** box.

8.7. Using the Frame Setup Wizard

You can use the Frame Setup wizard to create or modify a frame that you want to transmit from the DominoFE analyzer. The Frame Setup wizard allows you to specify protocol-specific information including source and destination addressing and encapsulation options for your transmit frame. You can access the Frame Setup wizard from the Transmit Frame Setup dialog box, when you create a new frame or edit an existing transmit frame.

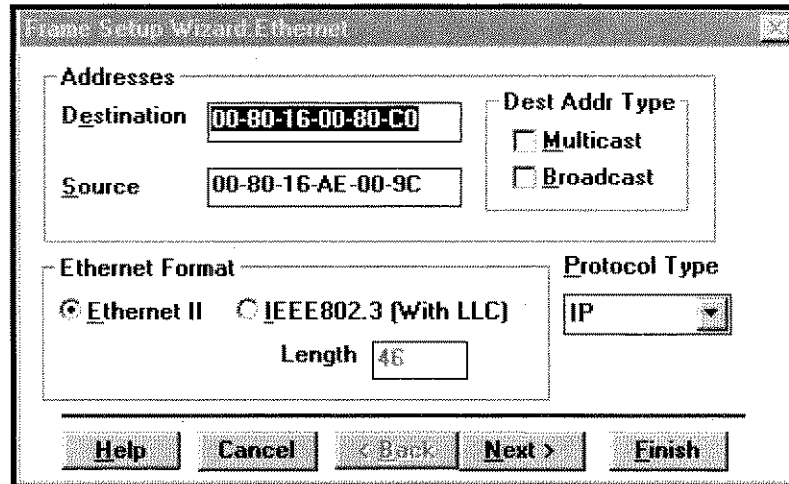

Figure 8-5. Frame Setup Wizard - Ethernet dialog box

The first wizard dialog box (Figure 8-5) allows you to specify the Ethernet options for the transmit frame including MAC addresses, address type, Ethernet frame format, and the next-layer protocol type. From there, depending on the Ethernet frame format that you selected and the next-layer protocol type, you can access the following wizard dialog boxes to set up other protocol information:

- Frame Setup Wizard - IP—Allows you to specify IP source and destination addresses, the total frame length, next layer protocol, and checksum.
- Frame Setup Wizard - UDP—Allows you to specify the UDP source and destination ports and the data length in the header for the UDP frame.

- Frame Setup Wizard - ARP—Allows you to encapsulate an ARP Request or an ARP Reply frame in the Ethernet frame.
- Frame Setup Wizard - MAC Control—Allows you to set up a MAC Pause Control frame.
- Frame Setup Wizard - 802.1q—Allows you to specify values for the user priority and virtual LAN (VLAN) identifier (ID) in the Tag Control Information (TCI) field of the tag header.

If you are modifying an existing frame that contains information for other protocol types in its fields, the Frame Setup Wizard indicates **Unknown** in the **Protocol Type** or **Next Layer Protocol** options. This means that the Frame Setup Wizard detects information that cannot be shown in the wizard setup, but that information will remain intact in the frame.

To use the frame setup wizard:

1. From the Transmit Frame Setup dialog box (Figure 8-4), click **Frame Setup**. The Frame Setup Wizard - Ethernet dialog box is displayed (Figure 8-5).
2. Select the Ethernet options. The **Ethernet Format** that you select determines the available choices in the **Protocol Type** option.
3. Choose one of the following buttons (when available) according to the setup task that you want to perform:
 - To set up additional protocol options (if you selected a next-layer protocol type), click **Next**.
 - To go back to a previous wizard setup dialog box, click **Back**.
 - To accept the setup selections that you made and return to the Transmit Frame Setup dialog box, click **Finish**.
 - To abandon the setup selections that you made and return to the Transmit Frame Setup dialog box, click **Cancel**.
 - To get more information about the options on the wizard dialog box, click **Help**.

8.7.1. Setting Up the Source and Destination Address

You can use the Frame Setup Wizard - Ethernet dialog box (Figure 8-5) to select the destination address type and specify the source and destination address fields for a frame that you want to transmit. From the Frame Setup Wizard - Ethernet dialog box, you can continue to specify higher-level protocol addressing, such as IP, when you choose **IP** for the **Protocol Type** option and click **Next**.

To set up the source and destination address:

1. From the Transmit Frame Setup dialog box, click **Frame Setup**.
The Frame Setup Wizard - Ethernet dialog box is displayed.
2. To specify the destination address type, do one of the following in the **Dest Addr. Type** box:
 - Select **Multicast**.
The multicast bit is set in the destination address of the transmit frame.
 - Select **Broadcast**.
A destination address of FF-FF-FF-FF-FF-FF is specified for the transmit frame.
3. In the **Addresses** box, type the six-byte hexadecimal destination and source address fields (with each byte separated by a hyphen) in the corresponding **Destination** and **Source** edit boxes.

The default destination address is 00-80-16-00-80-C0. The default source address is 00-80-16-xx-xx-xx, where 00-80-16 is the manufacturer's ID, and xx-xx-xx is a unique identifier that is read from the DominoFE analyzer.
4. Click **OK**.

The dialog box selections are accepted, and you return to the Transmit Frame Setup dialog box. The destination and source address fields that you specified appear in offsets 0 through 11 of the **Frame Contents** box.

8.7.2. Setting Up the Length/Type

Use the Frame Setup Wizard - Ethernet dialog box (Figure 8-5) to specify the length or protocol type of the Ethernet frame that you want to transmit. Depending on the type of Ethernet frame format that you are setting up, you can specify either the frame length (for Ethernet II) or the protocol type (for IEEE 802.3).

To set up the length/type:

1. From the Transmit Frame Setup dialog box, click **Frame Setup**.
The Frame Setup Wizard - Ethernet dialog box is displayed.
2. To specify the frame length, choose the **IEEE802.3 (With LLC)** format and enter a decimal value (representing the two-byte hexadecimal value) in the **Length** box for the length of the frame.
3. To specify the protocol type, select a protocol in the **Protocol Type** box.

4. Click **Finish**.

The dialog box options that you selected are accepted, and you return to the Transmit Frame Setup dialog box. The **Length/Type** field that you specified appears in offsets 12 and 13 of the **Frame Contents** box.

8.8. Modifying a Transmit Frame

You can select an existing transmit frame on the Transmit Screen to edit the frame size and contents. This is useful for modeling a new frame from an existing transmit frame, or an imported capture frame.

To modify a transmit frame:

1. From the Transmit Screen, move the mouse pointer to the frame you want to modify and double-click on the frame.

The Transmit Frame Setup dialog box is displayed (Figure 8-4), and you can edit the frame contents.

2. To edit the frame using the Frame Setup wizard, click **Frame Setup**.

The Frame Setup Wizard - Ethernet dialog box is opened showing the contents of the Ethernet frame header for the frame that you selected.

- To modify other protocol layer settings, click **Next** until you have completed all of your selections.
- Then, click **Finish**.

3. When you have completed editing the frame contents, click **OK**.

The changes that you made to the frame are accepted, and you return to the Transmit Screen.

4. If you are currently transmitting frames, you must stop and restart frame transmission to apply the new setup changes.

NOTE:

If you do not save the transmit file, the frame contents are only saved for the current Transmit session.

8.9. Deleting a Transmit Frame

You can remove one or more existing transmit frames on the Transmit Screen using the **Delete** button.

To delete a transmit frame:

1. From the Transmit Screen, select the frame that you want to delete. To select multiple transmit frames, use any Windows extended selection method including Shift-Arrow, Shift-Click, Ctrl-Click, or a hold and drag combination with the left mouse button.
The frames that you selected are highlighted.
2. In the Frames box, click **Delete**.
The frames are removed from the Transmit Screen.
3. If you are currently transmitting frames, you must stop and restart frame transmission to apply the new setup changes.

NOTE:

If you do not save the transmit file, the frame is only removed for the current Transmit session.

8.10. Setting Up the Transmit Queue

You can use the Transmit Queue Setup dialog box (Figure 8-6) to do the following:

- Change the order of the queue entries.
- Modify a frame number.
- Specify the number of times to repeat a frame.
- Specify the interframe or interpacket gap.
- Append a frame check sequence.
- Insert a symbol error.

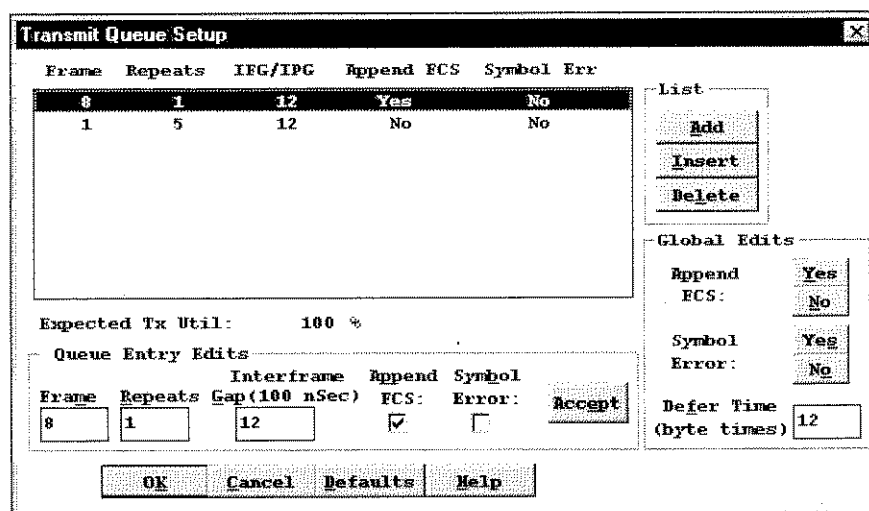

Figure 8-6. Transmit Queue Setup dialog box

Frames that are available for transmission are selected for the transmit queue from the Transmit Screen. The default order that frames are entered into the queue is in sequential order, by frame number. Frames are transmitted from top to bottom of the queue.

The transmit queue can hold a total of 1000 frames, including the frame repeat counts. For example, you can select one frame to be repeated 1000 times, or you can select five frames to each be repeated 200 times. You can select any multiple combination of frames and repeat counts, as long as the total frame count (including repeated frames) does not exceed 1000.

If no changes are made to the transmit queue, frames are transmitted in default order using the default queue setup options (1 for Repeats, 12 Interframe Gap units, and Yes to Append FCS for all entries in the queue).

To set up the transmit queue:

1. Under **Transmit Mode** on the Transmit Screen, select **Queue**.
The Q Setup button is enabled.
2. Under **Transmit Control**, click **Q Setup**.
The Transmit Queue Setup dialog box is displayed.
3. From the **List** box, modify the list of queue entries.
The default order for queue entries is in sequential order, by frame number. Frames are transmitted from top to bottom of the queue.
4. In the **Queue Entry Edits** box, specify the queue entry options and choose the **Accept** button.

The queue entry options that you specified are accepted, and you return to the Transmit Screen.

5. If you are currently transmitting frames, you must stop and restart frame transmission to apply the new setup changes.

NOTE:

The Transmit Method Setup dialog box allows you to specify the frequency of transmission for the entire queue.

8.10.1. Adding a Frame to the Queue

You can add a default entry (frame number 0) to the transmit queue using the **Add** button in the **List** box on the Transmit Queue Setup dialog box (Figure 8-6). The transmit queue can hold a total of 1000 frames, including the frame repeat counts.

To be a valid queue entry, the default frame number must be modified to match one of the frame numbers already selected for the queue on the Transmit Screen.

To add a frame to the queue:

1. In the **List** box on the Transmit Queue Setup dialog box, click **Add**.
A default entry (frame number 0) is added to the end of the queue.
2. If necessary, edit the frame number of the new queue entry to match one of the frame numbers selected on the Transmit Screen.
3. Click **OK**.
The Transmit Queue Setup dialog box options that you selected are accepted, and you return to the Transmit Screen.
4. If you are currently transmitting frames, you must stop and restart frame transmission to apply the new setup changes.

8.10.2. Inserting a Frame in the Queue

You can insert a default entry (frame number 0) in the transmit queue using the **Insert** button in the **List** box on the Transmit Queue Setup dialog box (Figure 8-6). The transmit queue can hold a total of 1000 frames, including the frame repeat counts.

To be a valid queue entry, the default frame number must be modified to match one of the frame numbers selected on the Transmit Screen.

To insert a frame in the queue:

1. From the Transmit Queue Setup dialog box, select the queue entry immediately below the position you want to insert the new entry.
The queue entry that you selected is highlighted.
2. In the **List** box, click **Insert**.
A default entry (frame number 0) is inserted immediately above the queue entry that you selected.
3. If necessary, edit the frame number of the new queue entry to match one of the frame numbers selected on the Transmit Screen.
4. Click **OK**.
The Transmit Queue Setup dialog box options that you selected are accepted, and you return to the Transmit Screen.
5. If you are currently transmitting frames, you must stop and restart frame transmission to apply the new setup changes.

8.10.3. Deleting a Frame From the Queue

You can delete an entry from the transmit queue using the **Delete** button in the **List** box on the Transmit Queue Setup dialog box (Figure 8-6).

To delete a frame from the queue:

1. From the Transmit Queue Setup dialog box, select the queue entry that you want to delete.
The queue entry that you selected is highlighted.
2. In the **List** box, click **Delete**.
The entry that you selected is removed from the queue.
3. Click **OK**.
The Transmit Queue Setup dialog box options that you selected are accepted, and you return to the Transmit Screen.
4. If you are currently transmitting frames, you must stop and restart frame transmission to apply the new setup changes.

8.10.4. Editing a Queue Entry

You can use the options in the **Edit Queue Entry** box on the Transmit Queue Setup dialog box (Figure 8-6) to:

- Modify a frame number.
- Specify the number of times to repeat a frame.
- Specify the interframe or interpacket gap.
- Append a frame check sequence to an individual frame or all transmit frames.
- Insert a symbol error in an individual frame or in all frames.

To edit a queue entry:

1. From the Transmit Queue Setup dialog box, select the queue entry that you want to edit.

The queue entry that you selected is highlighted, and the options for the selected queue entry are displayed in the **Queue Entry Edits** box.

2. In the **Queue Entry Edits** box, specify the new queue entry options.

The queue entry options that you selected are displayed in the **Queue Entry Edits** box.

3. Click **Accept**.

The queue entry options that you selected are accepted and displayed in the queue list.

NOTES:

- If you click **OK** without clicking **Accept** first, the queue entry options that you selected are not accepted, and are not displayed in the queue list.
- To activate the accepted queue entry options, you must click **OK** to return to the Transmit Screen. If you are currently transmitting frames, you must stop and restart frame transmission to apply the new setup changes.

8.10.4.1. Selecting the Frame Number

You can select the queue entry frame number in the **Frame** box of the **Queue Entry Edits** options, on the Transmit Queue Setup dialog box (Figure 8-6). The frame number is entered in decimal format and must match one of the frame numbers already selected for the queue on the Transmit Screen.

To select the frame number:

1. From the Transmit Queue Setup dialog box, select the queue entry that you want to edit.

The queue entry that you selected is highlighted, and the options for the selected queue entry are displayed in the **Queue Entry Edits** box.

2. In the **Frame** box of the **Queue Entry Edits** options, enter the new number of the frame.

The decimal number that you entered is displayed in the **Frame** box.

3. Click **Accept**.

If the frame number that you selected is a valid frame number (that is, it is selected for the queue on the Transmit Screen), the frame number is accepted, and it is displayed in the queue list.

NOTES:

- If you click **OK** without clicking **Accept** first, the queue entry options that you selected are not accepted, and are not displayed in the queue list.
- To activate the accepted queue entry options, you must click **OK** to return to the Transmit Screen. If you are currently transmitting frames, you must stop and restart frame transmission to apply the new setup changes.

8.10.4.2. Selecting the Repeat Count

You can select the number of times to repeat transmission of the frame by specifying a number in the **Repeats** box of the **Queue Entry Edits** options, on the Transmit Queue Setup dialog box (Figure 8-6). The repeat count is entered in decimal format.

You can repeat a frame up to 1000 times if the frame is the only queue entry. The transmit queue can support a total of 1000 entries, which includes an entry for every frame and for each of its repeat counts.

To select the repeat count:

1. From the Transmit Queue Setup dialog box, select the queue entry that you want to edit.

The queue entry that you selected is highlighted, and the options for the selected queue entry are displayed in the **Queue Entry Edits** box.

2. In the **Repeats** box of the **Queue Entry Edits** options, enter the number of times you want to repeat transmission of the frame.

The decimal number that you entered is displayed in the **Repeats** box. The default selection is 1.

3. Click **Accept**.

If the frame number that you selected is a valid frame number (that is, it is selected for the queue on the Transmit Screen), the frame number is accepted, and it is displayed in the queue list.

NOTES:

- If you click **OK** without clicking **Accept** first, the queue entry options that you selected are not accepted, and are not displayed in the queue list.
- To activate the accepted queue entry options, you must click **OK** to return to the Transmit Screen. If you are currently transmitting frames, you must stop and restart frame transmission to apply the new setup changes.

8.10.4.3. Selecting the Interframe Gap

You can select the number of 100-nanosecond interframe gap units for 100Base-T (1-microsecond units for 10Base-T) to be transmitted between frames, in the **Interframe Gap** box of the **Queue Entry Edits** options on the Transmit Queue Setup dialog box (Figure 8-6).

The interframe gap is entered in decimal format, and can be between 12 and 65547, which is equivalent to 1.2 microseconds up to 6.5547 milliseconds for 100Base-T (12 microseconds up to 65.5547 milliseconds for 10Base-T). Very short frames (less than 20 bytes) with a minimum interframe gap of 1.2 microseconds cannot be transmitted reliably in continuous mode.

The **Interframe Gap** option is not used when transmitting frames in **Flood** mode. For more information about **Flood** mode, see section 8.14 "Transmitting Frames in Flood Mode."

To select the interframe gap:

1. From the Transmit Queue Setup dialog box, select the queue entry that you want to edit.

The queue entry that you selected is highlighted, and the options for the selected queue entry are displayed in the **Queue Entry Edits** box.

2. In the **Interframe Gap** box of the **Queue Entry Edits** options, enter the number of 100-nanosecond units (for 100Base-T) or 1-microsecond units (for 10Base-T) to be transmitted between frames.

The decimal number that you entered is displayed in the **Interframe Gap** box. The default selection is 12, which is equivalent to 1.2 microseconds (100Base-T) or 12 microseconds (10Base-T).

3. Click **Accept**.

If the frame number that you selected is a valid frame number (that is, it is selected for the queue on the Transmit Screen), the frame number is accepted, and it is displayed in the queue list.

NOTES:

- If you click **OK** without clicking **Accept** first, the queue entry options that you selected are not accepted, and are not displayed in the queue list.
- To activate the accepted queue entry options, you must click **OK** to return to the Transmit Screen. If you are currently transmitting frames, you must stop and restart frame transmission to apply the new setup changes.
- If you want to specify a percent utilization for transmission instead of the interframe gap, use the **Utilization** transmit mode option on the Transmit Screen.

8.10.4.4. Appending a Frame Check Sequence

You can append a frame check sequence to an individual transmit frame, or specify a frame check sequence to be appended to all transmit frames using the **Global Append FCS** option on the Transmit Queue Setup dialog box (Figure 8-6). The default option is to append an FCS to all transmit frames. You can remove the FCS field from all transmit frames by choosing the No button in the **Global Append FCS** option.

The original FCS of an imported capture frame is copied by the analyzer but is not used by default. Since appending an FCS is the default option in the analyzer's transmit queue setup, the imported frame has a new FCS generated by the analyzer. If you want to use the original FCS of the imported capture frame, increase the frame size by 4 bytes on the Transmit Frame Setup dialog box and then clear the **Append FCS** option for the frame on the Transmit Queue Setup dialog box.

To append a frame check sequence to an individual transmit frame:

1. From the Transmit Queue Setup dialog box, select the queue entry to which you want to add the FCS.

The queue entry that you selected is highlighted, and the options for the selected queue entry are displayed in the **Queue Entry Edits** box.

2. Select **Yes** for the **Append FCS** option, and choose the **Accept** button.

A frame check sequence will be added to the frame that you selected and **Yes** is displayed beside the frame in the queue list.

NOTE:

If you click **OK** without clicking **Accept** first, the queue entry options that you selected are not accepted, and are not displayed in the queue list.

To append/remove a frame check sequence for all transmit frames:

- To append an FCS for all transmit frames, choose the **Yes** button in the **Global Append FCS** option.

A frame check sequence will be added to all frames in the transmit queue, and **Yes** is displayed in the **Append FCS** column for all frames in the queue list.

- To remove an FCS for all transmit frames, choose the **No** button in the **Global Append FCS** option.

A frame check sequence will be removed from all frames in the transmit queue, and **No** is displayed in the **Append FCS** column for all frames in the queue list.

NOTE:

To activate the accepted queue entry options, you must click **OK** to return to the Transmit Screen. If you are currently transmitting frames, you must stop and restart frame transmission to apply the new setup changes.

8.10.4.5. Inserting a Symbol Error

You can insert a symbol error for an individual transmit frame, or specify that a symbol error be inserted for all transmit frames using the **Symbol Error** option on the Transmit Queue Setup dialog box (Figure 8-6). You can remove the symbol error from all transmit frames by clicking **No** for **Symbol Error** in the **Global Edits** box. The default option is to not insert symbol errors for any transmit frames.

To insert a symbol error in an individual transmit frame:

1. From the Transmit Queue Setup dialog box, select the queue entry to which you want to add the symbol error.

The queue entry that you selected is highlighted, and the options for the selected queue entry are displayed in the **Queue Entry Edits** box.

2. Select **Yes** for the **Symbol Error** option, and click **Accept**.

A symbol error will be inserted to the frame that you selected, and **Yes** is displayed beside the frame in the queue list.

NOTE:

If you click **OK** without clicking **Accept** first, the queue entry options that you selected are not accepted, and are not displayed in the queue list.

To insert/remove a symbol error for all transmit frames:

- To insert a symbol error in all transmit frames, click **Yes** in the **Global Edits Symbol Error** option.

A symbol error will be added to all frames in the transmit queue, and **Yes** is displayed in the **Symbol Error** column for all frames in the queue list.

- To remove symbol errors for all transmit frames, click **No** in the **Global Edits Symbol Error** option.

Symbol errors will be removed from all frames in the transmit queue, and **No** is displayed in the **Symbol Error** column for all frames in the queue list.

NOTE:

To activate the accepted queue entry options, you must click **OK** to return to the Transmit Screen. If you are currently transmitting frames, you must stop and restart frame transmission to apply the new setup changes.

8.10.4.6. Selecting the Defer Time

Using the **Defer Time** option on the Transmit Queue Setup dialog box, you can specify the number of byte times that the analyzer's transmitter waits before transmission of a frame due to Carrier Sense Detect. When transmitting frames in **Flood** mode, you can also use the defer time to achieve smaller gaps between frames (down to 480 nanoseconds) than you can with the **Interframe Gap** option in normal transmission mode.

The valid entries for the defer byte time are between 6 and 133 byte times. 12 is the default value.

To select the transmit defer time:

1. Under **Global Edits** on the Transmit Queue Setup dialog box, enter a value between **6** and **133** in the **Defer Time** edit box.

The default value is 12 byte times.

2. Click **Accept**.

The queue entry options that you selected are accepted and displayed in the queue list.

8.11. Setting Up the Transmit Method

You can use the Transmit Method Setup dialog box (Figure 8-7) to specify the number of times to repeat transmission of the entire transmit queue. You can transmit the queue one time, repeat transmission of the queue for a period of 9999 seconds, repeat transmission of the queue up to 255 times, or continuously repeat transmission of the queue.

If you do not specify a transmit method option, the default option (Single) is selected, and the queue is transmitted one time.

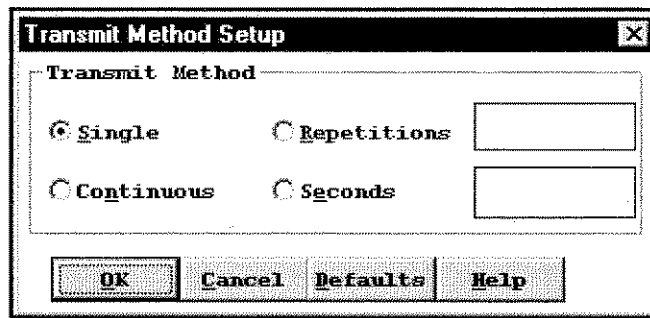

Figure 8-7. Transmit Method Setup dialog box

To set up the transmit method:

1. In the **Transmit Control** box on the Transmit Screen, click **Method**.
The Transmit Method Setup dialog box is displayed.
2. Do one of the following:
 - To transmit the queue one time only, choose the **Single** option.
This is the default selection.
 - To transmit the queue repeatedly without stopping, choose the **Continuous** option.
 - To transmit the queue a certain number of times, choose the **Repetitions** option and enter a decimal value between **1** and **255** in the option box.
 - To transmit the queue for a certain period of time (in seconds), choose the **Seconds** option and enter a decimal value between **1** and **9999** in the option box.
3. Click **OK**.
The dialog box option that you selected is accepted, and you return to the Transmit Screen.

4. If you are currently transmitting frames, you must stop and restart frame transmission to apply the new setup changes.

8.12. Setting Up the Transmit Mode

Use the **Transmit Mode** options on the Transmit Screen to specify the method used to set up the frames for transmission and determine the expected transmit utilization percentage.

You can specify one of the following two transmit modes:

- **Queue**—Select this option and click **Q Setup** to modify the order of frames to be transmitted in the queue, specify interframe gap options, repeat the transmission of a particular frame for a specified number of times, or indicate FCS preferences.
- **Utilization**—Select this option to transmit the selected frames in the buffer according to a specific percentage of network utilization. The analyzer automatically determines the corresponding interframe gap for the selected frames and reports the utilization in the **Expected Tx Util** field.

NOTE:

If you want to transmit frames by a specific utilization percentage, and you also want to modify some of the queue setup options, be sure to set up the queue options first. Then select the **Utilization** transmit mode option on the Transmit Screen when you are ready to transmit frames.

8.12.1. Transmitting Frames by Percent Utilization

Use the **Utilization** transmit mode option on the Transmit Screen to specify a bandwidth percentage that you want to transmit onto the network. The analyzer automatically calculates the corresponding interframe gap for the frames that you selected in the transmit buffer and shows the expected utilization value in the **Expected Tx Util** field.

To transmit frames by percent utilization:

1. Under **Transmit Mode** on the Transmit Screen, select **Utilization**.
The default selection is 100% utilization.
2. In the edit box, specify an integer value up to 100 for the percent utilization that you want to transmit.

NOTE:

If you want to transmit frames by a specific utilization percentage, and you also want to modify some of the queue setup options, be sure to set up the queue

options first. Then select the **Utilization** transmit mode option on the Transmit Screen when you are ready to transmit frames.

8.13. Starting and Stopping Frame Transmission

You can use the **Start/Stop** button in the **Transmit Control** box on the Transmit Screen to begin or end transmission of the frames in the transmit queue. When you click **Start**, frames are transmitted from the queue, according to the options specified in the Transmit Queue Setup dialog box and the Transmit Method Setup dialog box. If you have not specified any options in either the Transmit Queue or Transmit Method setup dialog boxes, the frames selected on the Transmit Screen are transmitted according to the default setup options.

To start frame transmission:

1. Be sure that the analyzer is configured for the **Emulate** connection mode.
You choose the connection type on the Fast Ethernet Main Setup dialog box.
2. From the Transmit Screen, be sure frames have been selected for the transmit buffer and queue.
The selected frames for the transmit buffer and queue are checked in the box beside the frame. The **Start** button is enabled in the **Transmit Control** box.
3. In the **Transmit Control** box, click **Start**.
Entries in the transmit queue begin transmission according to the options selected in the Transmit Queue Setup and Transmit Method Setup dialog boxes. The **Start** button becomes a **Stop** button, which allows you to end active frame transmission.

To stop frame transmission:

- ◆ While the queue is transmitting, click **Stop** in the **Transmit Control** box on the Transmit Screen.
Transmission of the queue is ended, and the frames that were selected for the transmit queue remain selected.

NOTE:

The **Start** button is disabled if there are no frames selected for the transmit queue. The analyzer must be configured for **Emulate** in order to transmit frames.

8.14. Transmitting Frames in Flood Mode

You can use the transmit **Flood** mode in the DominoFE interface to perform benchmark testing or stress testing on your network. Flood mode is an alternative way to transmit frames from the DominoFE interface. It makes use of the **Defer Time** option to allow you to stream frames onto the network with much smaller gaps (down to 480 nanoseconds) between frames than you otherwise could achieve using normal frame transmission and the **Interframe Gap** option. The **Interframe Gap** option is not used when flooding frames.

However, if a late collision is experienced during frame transmission in **Flood** mode, it may take several frames before the DominoFE interface can re-synchronize to transmit additional frames completely. The collided frame and one or two additional frames may be transmitted with unexpected results after a late collision has occurred. Therefore, if you have a network where late collisions occur, you may want to avoid transmitting frames in **Flood** mode.

Flood mode transmission is initiated by using the **Flood** button on the Transmit Screen, rather than the **Start** button, which begins normal frame transmission of the frames in the transmit queue.

To transmit frames in flood mode:

1. Be sure the analyzer is setup for an **Emulate** connection mode.
The connection mode is selected on the Fast Ethernet Main Setup dialog box.
2. From the Transmit Screen, be sure frames have been selected for the transmit buffer and queue.
The selected frames for the transmit buffer and queue contain an "X" in the box beside the frame. The **Start** button is enabled in the **Transmit Control** box.
3. From the Transmit Queue Setup dialog box, be sure the **Defer Time** option is set to the desired value.
The default **Defer Time** is 12 byte times, or 960 nanoseconds. (.960 microseconds for 100Base-T, or 9.6 microseconds for 10Base-T.)
4. In the **Transmit Control** box on the Transmit Screen, click **Flood**.
Entries in the transmit queue begin transmission according to the options selected in the Transmit Queue Setup and Transmit Method Setup dialog boxes.

8.14.1. Testing Maximum Network Load

You can set up the DominoFE transmit interface to test 100% network load by specifying 12 byte times (960 nanoseconds, which is .960 microseconds for 100Base-T and 9.6 microseconds for 10Base-T) for the **Defer Time** option (default) and continuously transmitting frames in **Flood** mode.

To test the network under maximum load:

1. Be sure the 100Base-T interface is set up for an **Emulate** connection mode.
The connection mode is selected on the Fast Ethernet Main Setup dialog box.
2. From the Transmit Screen, be sure frames have been selected for the transmit buffer and queue.
The selected frames for the transmit buffer and queue contain an "X" in the box beside the frame. The **Start** button is enabled in the **Transmit Control** box.
3. From the Transmit Queue Setup dialog box, specify **12** for the **Defer Time** option.
The default **Defer Time** is 12 byte times, or 960 nanoseconds (.960 microseconds for 100Base-T, or 9.6 microseconds for 10Base-T.)
4. From the Transmit Screen, click **Method**.
The Transmit Method Setup dialog box is displayed.
5. Select **Continuous**.
6. In the **Transmit Control** box on the Transmit Screen, click **Flood**.
The frames selected in the transmit queue begin transmission repeatedly according to the options specified in the Transmit Queue Setup dialog box, until you click **Stop**.

8.15. Saving the Transmission File

Save the transmit frames, queue setup, and transmit method options using the **Save** button on the Transmit Screen. The options are saved to a default file called TRANSMIT.BTX, which is stored in the root directory for the corresponding analyzer number, such as C:\DOMINO\DOMx. So, the transmit file for Domino analyzer number two is found in C:\DOMINO\DOM2. You can save one transmit file for each DominoFE analyzer.

If you do not save the transmit frames and options, the dialog box selections are lost when you exit the Transmit Screen from Real Time.

To save the transmission file:

- ◆ In the **Tx Cfg** box on the Transmit Screen, click **Save**.
The transmit frames and queue and transmit method setup options are saved to the TRANSMIT.BTX file.

9. Analyzing Network Traffic and Status

9.1. Capturing Network Traffic

You can use the **Capture** command in the **Workbench** menu on the Workbench screen, or the **Capture** task button on the Workbench screen, to save network traffic in a capture file and display the Real Time screen. From the Real Time screen, you can access the Examine screen, which allows you to examine the contents of the capture buffer.

The DominoFE analyzer continuously receives network traffic (subject to any filters and triggers that you may have defined) into its 16 MB capture buffer at full line rates. During real-time analysis, the analyzer passes a portion of the network data to the PC for protocol decoding (for example, in the Hexadecimal Trace window).

9.2. Capturing Traffic to Your Computer's Disk

When you capture an amount of traffic that you expect will exceed the capacity of the RAM buffer, you can set up the system so that it automatically performs a capture, saves the captured traffic to your computer's disk, and repeats the process. You can specify how and when you want the process to start and to repeat. The cycle of automatic capturing, saving, and repeating can begin:

- Each time the Domino capture buffer is filled to a specified level
- At a specified time, repeating at specified intervals
- Each time a specified trigger occurs during a specified interval

The Capture to Disk feature is one of the options available in Advanced Setup (Figure 9-1).

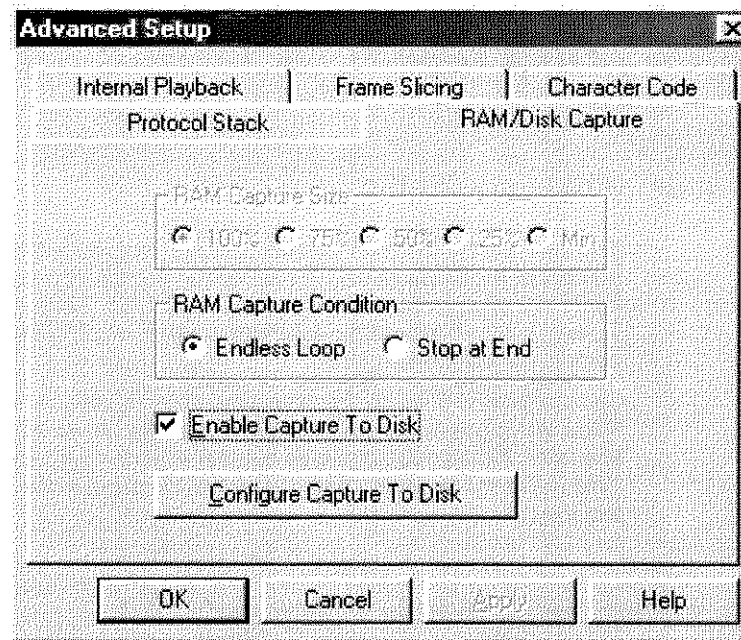

Figure 9-1. Advanced Setup screen

To repeat captures to your disk automatically:

1. On the Workbench screen, click the **Setup** button next to the name of the analyzer from which you want to capture traffic.
2. On the Fast Ethernet Main Setup dialog box, click **Advanced**.
3. In the Advanced Setup dialog box, click the **RAM/Disk Capture** tab.
4. Select **Enable Capture to Disk**; then click **Configure Capture to Disk**.
The Configure Capture to Disk dialog box appears (Figure 9-2).

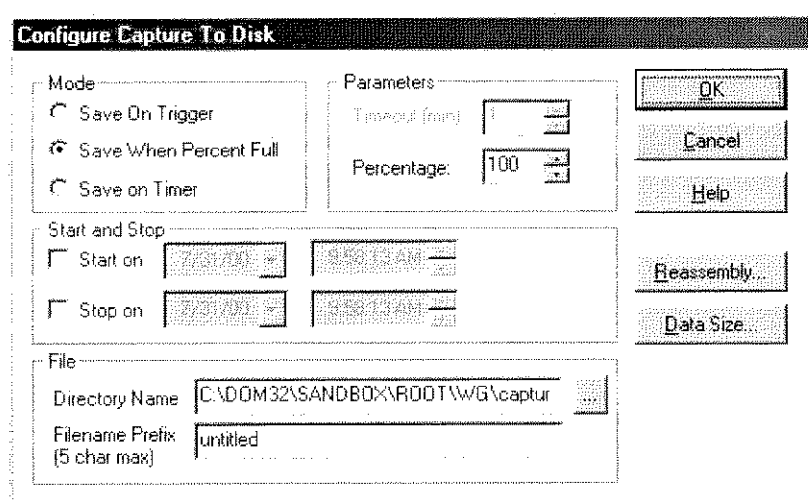

Figure 9-2. Configure Capture to Disk dialog box

5. Under **Mode**, take one of the following actions:
 - To save captured data and clear the Domino capture buffer each time that a trigger condition is met, click **Save on Trigger**. (This option is available for FastEthernet, HSSI, and Gigabit interfaces only.)
To learn how to set up a trigger, see, 6.2, "Setting up Filtering and Triggering."
 - To save captured data each time the Domino capture buffer is filled to a certain limit, click **Save When Percent Full**. Under **Parameters**, specify the point at which you want to initiate the save action (in terms of the percent of the buffer to be filled.)
 - To save a specified percentage of the RAM buffer at regular intervals, click **Save on Timer**. Under **Parameters**, use **Timeout** to specify how often you want to save the captured data (in minutes). Use **Percentage** to specify how much of the traffic in the buffer to save each time.
To limit the interval in which the capturing and saving process occurs, specify the dates and times under **Start and Stop**.
6. Under **File**, type a name in the **Filename Prefix** box. (Click the button to browse to the directory that you want.)
With each successive data capture, a new number is appended to the filename prefix.
7. Click **OK**.
You return to the Advanced Setup dialog box. The process that you have set up will be activated when you start the analyzer.

9.3. Limiting the Amount of Capture Data that is Saved to Disk

When you set up the Domino system to save captured data to your disk repeatedly, the amount of data that is saved can grow very large. To preserve space on your disk, you can set limits on the total amount of capture data that is saved.

To limit the total amount of capture data:

1. In the **Configure Capture to Disk** dialog box, click **Data Size**.
The Data Size dialog box appears, which displays the amount of disk space that is available on your disk.
2. Take one or both of the following actions:
 - To limit the amount of data to be saved to your disk, specify a maximum amount in **Max Data Size**.
 - To limit the amount of disk space to be used, specify a minimum amount of your disk space to keep available in **Min Available Disk Space**.
3. Click **OK** to return to the Configure Capture to Disk dialog box.

9.4. Examining Network Traffic

You can use the **Examine** command to analyze captured network traffic. Examine is the Domino application that enables you to review and analyze network traffic. For detailed information about using Examine, see the *Domino Operating Guide* or online Help.

To examine network traffic:

1. From the Real Time screen menu bar, choose the **Control** menu.
The Control menu is displayed.
2. Choose the **Examine** command.
A confirmation box is displayed. Click **Examine** to continue. After the contents of the capture buffer are prepared, the Examine screen is displayed.

9.5. Monitoring Collisions

You can monitor a number of collision statistics with the DominoFE interface using the statistics windows. The DominoFE interface keeps track of collisions in several ways:

- It monitors carrier sense (CRS) on the network and counts collisions when CRS activates and inactivates within a preamble collision window for network frames received by the DominoFE interface. For a description of the preamble collision window, see the Glossary.

The network collision statistic can be monitored by looking at the **Collisions** statistic under the **RX** column on the Detailed Network Statistics window.

- It monitors collisions in which the DominoFE interface is directly involved that occur during an attempt to transmit network frames — these are called transmit collisions. Statistics are also maintained to track late or excess transmit collisions.

The transmit collision statistics can be monitored by looking at the transmitter **Collisions** statistic on the Network Status window, and the **Excess Collisions** and **Late Collisions** statistics on the Error Statistics window. You can also monitor the COLLISION front panel LED indicator to see when transmit collisions are occurring.

- It monitors collision fragments, which are processed network frames that are less than 64 bytes with a bad FCS.

Collision Fragments can be monitored by looking at the **Collision Frag** statistic under **runt/Short Event** on the Detailed Capture Statistics window.

You can obtain descriptions of each of the statistics online while viewing the different results windows by pressing F1 to open the Help.

9.6. Monitoring Link Status

You can use the Network Status window, Events window, and the front panel LED indicators to monitor the status of the DominoFE analyzer's network links.

The Events window (Figure 9-1) indicates when auto-negotiation has completed and the link has been successfully established. A failed network link can be detected when the Link LED is off, or by the **Link Failed** event on the Events window.

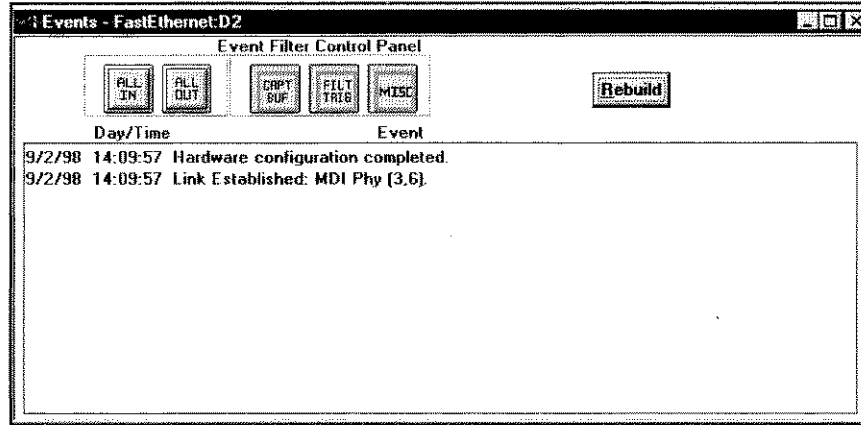

Figure 9-3. Events window

The Network Status window shows how the line is currently configured, including the connection mode, network speed, and duplex mode. You can also use the Network Status window and the TX/RX LED indicators to determine the activity of the network transmitter and receiver on the DominoFE interface.

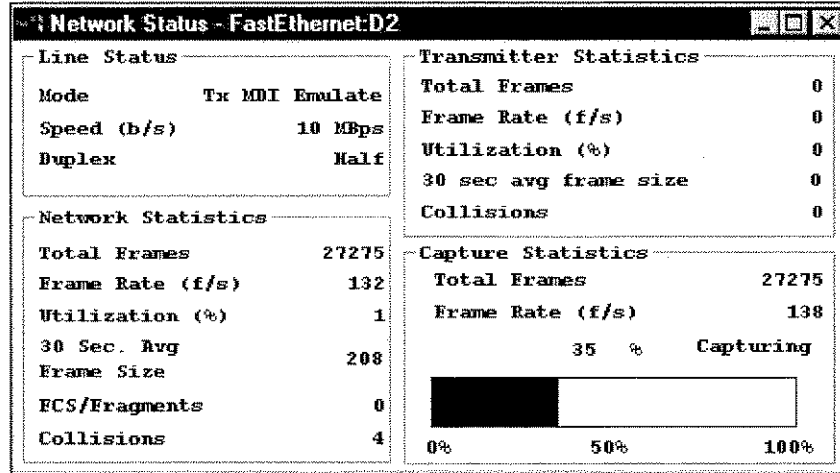

Figure 9-4. Network Status window

For more information about the LED indicators, see Section 9.7, "Using the LED Indicators to Determine Network Status," and Section 3.2, "Front Panel LED Indicators" in chapter 3. For detailed information about the DominoFE interface results windows, refer to the Help by pressing F1 while displaying the window.

9.7. Monitoring Network Traffic

You can use the **Monitor** command in the **Workbench** menu on the Workbench screen, or the **Monitor** task button on the Workbench screen to display the Real Time screen.

From the Real Time screen, you can display network statistics or you can transmit frames, if the analyzer is configured for an **Emulate Connection** mode. In the Monitor application, certain network statistics, such as Station Statistics, Frame Size, and Protocol Statistics, are sampled from the network receiver. So, these statistics might not initially reflect the actual network environment. However, over longer periods of time, the relative percentages of these statistics more closely reflect the actual representation on the network.

When you display network statistics using the Monitor application, you should interpret these statistics accordingly.

NOTE:

The **Monitor** button does not have any relationship with the Monitor connection type, an option that is set on the Fast Ethernet Main Setup dialog box. When you choose the **Monitor** task button, the Real Time screen is displayed using the last interface setup that was saved.

Pass-Through Monitoring

You can set up the DominoFE analyzer as a pass-through monitor using Port 1 and Port 2 to connect between two network devices. When performing dual monitoring on the network, auto-negotiation is not supported. The analyzer receives network traffic on each port.

When analyzing statistics while you are connected for pass-through monitoring, you need to understand how the network device connections are made to the DominoFE analyzer, (especially when using a cross-over cable) and their relationship to the analyzer's receivers. An MDI port transmits data on Pins 1 and 2 and an MDIX port transmits data on Pins 3 and 6.

When the analyzer is set up for pass-through monitoring, it is important to remember the following:

- Receiver 1 (Rx1) on the analyzer's Port 1 (or MDI) always monitors the data that is being transmitted on Pins 3 and 6, regardless of which device is doing the transmitting.
- Receiver 2 (Rx2) on the analyzer's Port 2 (or MDIX) always monitors the data that is being transmitted on Pins 1 and 2, regardless of which device is doing the transmitting.

For more information about connecting to the network, see Chapter 3 "Connecting to the Network."

9.8. Monitoring Network Utilization

You can use the network statistics results windows and the front panel LED indicators to monitor utilization and frame rates on the network. For a graphical representation of the network utilization (perhaps plotted simultaneously with network frame rates) you can use the Histogram window.

The Network Status window displays values for the current network and transmit utilization. The Detailed Network and Detailed Capture Statistics windows provide current, peak, and average utilization for the DominoFE interface transmitter and receiver.

The LED indicators indicate the current network utilization (% Utilization on the DA-362 analyzer) or network frame rates (frames/sec on the DA-350 analyzer). For more information about the LED Indicators, see Section 3.2, "Front Panel LED Indicators" in the "Connecting to the Network" chapter. For detailed information about the DominoFE analyzer statistics windows, refer to the Help by pressing F1 while displaying the window.

9.9. Using the LED Indicators to Determine Network Status

The LED indicators can be used in combination with several of the DominoFE results windows to provide an effective means of monitoring network conditions. (The LED indicators are not intended for use when connected for MII emulation).

You can use the front panel LED indicators to monitor:

- Whether a successful network link is established.
- The presence or absence of transmit and receive activity on the line.
- Connection and duplex mode of operation.
- Presence of transmit collisions.
- Current network utilization or frame rates.

For a description of the LED indicators, see Section 3.2, "Front Panel LED Indicators" in the "Connecting to the Network" chapter.

9.10. Viewing Network Traffic and Statistics

This section describes how to view the network traffic and statistics windows that are specific to the DominoFE interface. There are many other results windows and features that are part of the overall Domino Core software, whose details are not provided in this book. For more information about the Domino Core statistics windows, see the *Domino Operating Guide*.

9.10.1. Opening Results Windows

You can open the DominoFE interface results windows when you run an application from the Workbench screen. The results windows show network traffic, status, and statistics for the DominoFE interface.

The interface-specific network results windows are opened by choosing commands on the Interface menu, or by selecting a DominoFE Real Time Toolbar button. Other results windows, such as the Hexadecimal Trace window and Protocol Summary window, are a standard part of the Domino Core software, and are available for all of the network interfaces. The Domino Core results windows can be opened from other areas of the menu bar and toolbar.

To open results windows:

1. From the menu bar on the Real Time screen, choose the **Interface** command.

The Interface menu is displayed.

2. Choose a command from the menu or sub-menu.

The results window that you selected is displayed.



You can use the buttons on the DominoFE Real Time Toolbar to quickly open the DominoFE interface results windows.

9.11. Results Window Descriptions

The DominoFE interface consists of eight interface-specific results windows. The table below provides a brief description of each results window. For detailed information about the DominoFE interface results windows and dialog boxes, refer to the interface Help by pressing F1 while displaying the window.

Window Name	Description
Detailed Capture Statistics	Displays comprehensive statistics for frames captured by the DominoFE analyzer. The statistics are shown categorized by receiver and transmitter ports, and by cumulative total.
Detailed Network Statistics	Displays comprehensive network statistics on valid frames, frame rates, network utilization, and average frame size for frames received by the analyzer before filtering and capturing are performed. The statistics are shown categorized by receiver and transmitter ports, and by cumulative total.

Error Statistics	Provides comprehensive error statistics on frames transmitted and received by the analyzer. The statistics are shown categorized by receiver and transmitter ports.
Events	Displays tracked events from the Events buffer, which can store up to 500 events at a time. The Events window allows you to select the type of events to be viewed.
Histogram	Displays a histogram of up to four recorded statistics from the history buffer for the duration of a test. The vertical axis represents the unit of measure as a percentage or rate of the statistics. The horizontal axis represents time.
MII Registers	Displays the values of 32 registers for an addressable device connected to the DominoFE interface MII connector, or for the transmit device on the DominoFE interface when the MII connector is not in use.
Network Status	Displays summary network, transmit, and capture statistics, link status, and status of the capture buffer on the DominoFE analyzer. Additional statistics are shown on the detailed statistics windows. Additional error statistics are provided on the Error Statistics window.

Table 9-1. Results window descriptions

9.11.1. Setting Up the Histogram Window

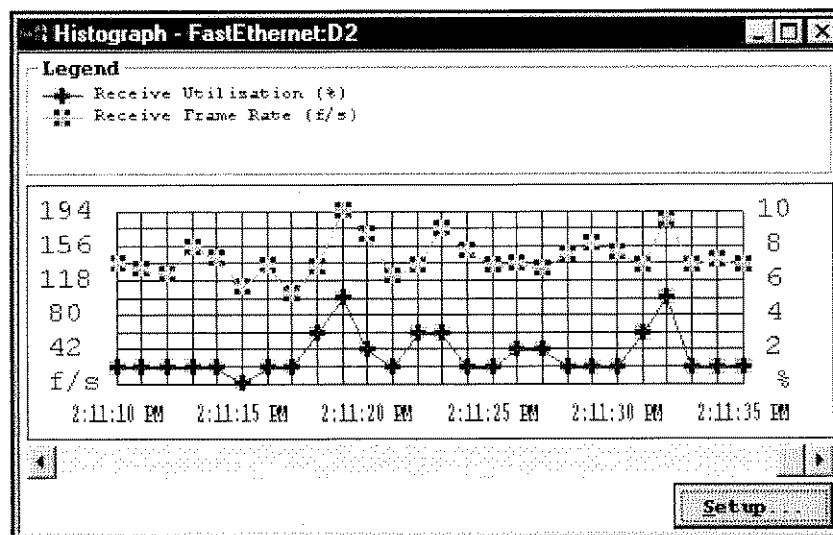

Figure 9-5. Histogram window

You can open the Histogram window (Figure 9-3) to graphically represent the statistics tracked in the history buffer over time. The Histogram window can plot 1024 samples of up to four statistics at a time, which can be viewed using the scroll box or scroll arrows at the bottom of the display. A legend at the top of the display identifies each statistic that you selected with a patterned box and a colored line.

To display a graph of statistics in the Histogram window, you must first select statistics to be displayed from the history buffer using the Histogram Setup dialog box (Figure 9-4). You can use the Histogram Setup dialog box to select up to four statistics at one time to be tracked in the history buffer and displayed in the Histogram window. You can also specify the scale and the sampling interval to be used for the statistics that you selected.

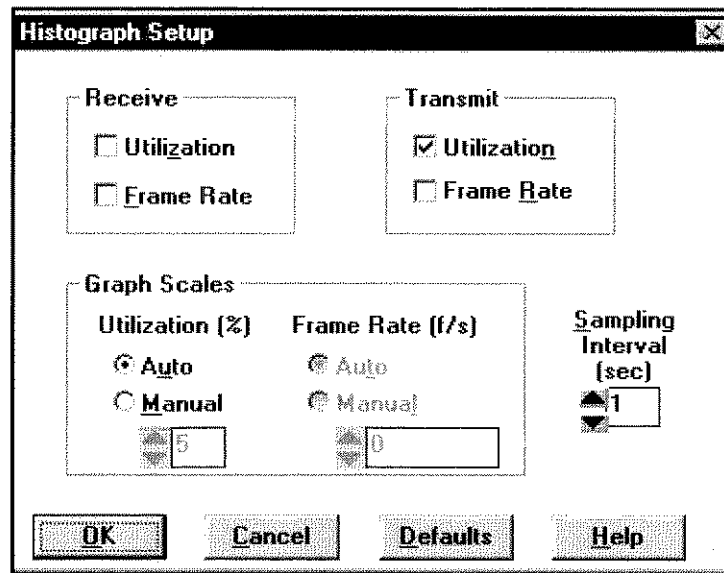

Figure 9-6. Histogram Setup dialog box

There are two different scale options: **Utilization** and **Frame Rate**. These scales are associated with the two types of statistics that can be tracked. For each of the scale options, you can specify automatic scaling, or manually specify the maximum value for the vertical axis. The sampling interval specifies how frequently the tracked statistics are to be sampled. You can select an interval between 1 (default) and 30 seconds.

You can display the Histogram Setup dialog box from the Fast Ethernet Main Setup dialog box by choosing the **Histogram** button, or by choosing the **Setup** button on the Histogram window.

If you have not performed an initial histogram setup during the current real time session, you can also display the Histogram Setup dialog box on the Real Time screen, either by choosing the **HI** toolbar button or by choosing the Histogram command on the Interface menu. Otherwise, the toolbar button and command display the Histogram window using the current setup.

To set up the Histogram window:

1. Do one of the following:
 - From the Fast Ethernet Main Setup dialog box, click **Histogram**.
The Histogram Setup dialog box is displayed.
 - From the Real Time screen, do one of the following:
 - ◆ Choose the **Histogram** command on the Interface menu.
The Histogram Setup dialog box is displayed.
 - ◆ Click the **HI** toolbar button.
The Histogram Setup dialog box is displayed.
2. Under **Receive and Transmit**, select the statistics that you want to graph.
The statistics that you selected contain a checkmark in the checkbox, and the corresponding scale options are enabled.
3. Under **Graph Scales**, select the scale divisions you want to use for the vertical axis.
The histogram will display the vertical axis divisions according to the scale that you specified. **Auto Scale** is the default selection.
4. Under **Sampling Interval**, use the spin buttons to select the interval at which to sample the selected statistics.
The number of seconds that you selected is displayed. One second is the default selection.
5. Click **OK**.
 - If you accessed the Histogram Setup dialog box from the Real Time screen, the Histogram window is displayed, plotting the statistics in real time.
 - If you accessed the Histogram Setup dialog box from the Launch Pad screen or Create Application screen, you return to the Fast Ethernet Main Setup dialog box.

NOTE:

The sampling interval option is not available when accessing the Histogram Setup dialog box directly from the Histogram window.

9.11.1.1. Selecting or Clearing a Histogram Statistic

On the Histogram Setup dialog box, you can select up to four statistics to be displayed in the Histogram window.

You can select Receive and Transmit utilization and rate statistics for display. A checkbox next to each statistic specifies whether or not the statistic is selected.

To select or clear a histogram statistic:

1. From the Histogram Setup dialog box, do one of the following:
 - If the checkbox beside the statistic is empty, select the checkbox to enable the statistic for tracking.
A checkmark is displayed in the checkbox beside the statistic that you selected.
 - If a checkmark is displayed in the checkbox beside the statistic, select the checkbox to disable the statistic for tracking.
The checkmark is removed from the checkbox of the statistic that you selected.
2. Click **OK**.
The dialog box options that you selected are accepted and the Histogram window is displayed.

9.11.1.2. Selecting the Histogram Sampling Interval

You can select how frequently the selected tracked statistics are sampled using the **Sampling Interval** option on the Histogram Setup dialog box. You can specify a period of 1 second (default) to 30 seconds between sampling times.

To select the sampling interval:

1. In the **Sampling Interval** box, use the spin buttons to select the interval at which to sample the selected statistics.
The number of seconds that you selected is displayed. One second is the default selection.
2. Click **OK**.
The dialog box options that you selected are accepted, and the Histogram window is displayed.

NOTE:

The sampling interval option is not available when accessing the Histogram Setup dialog box directly from the Histogram window.

9.11.1.3. Selecting the Histogram Scales

There are two types of scale options that can be defined in the Histogram Setup dialog box for the divisions on the vertical axis of the histogram: **Utilization** and **Frame Rate**. These scale options correspond to the different units of measure associated with the available tracked statistics, which can be measured by percent utilization or as a rate, in frames per second.

When you select a histogram statistic, the corresponding scale option is enabled for you to specify the range of the vertical axis. For each type of scale option, you can either select the **Auto** option, or manually specify a number using the spin buttons. Auto scaling is the default selection.

The specified scale applies to all statistics of that type. When more than one scale is enabled for the histogram, the scales are displayed on either side of the graph on the Histogram window.

Enabling or Disabling the Auto Scale

Automatic scaling dynamically adjusts the maximum range of the vertical axis according to the range of statistics displayed. When automatic scaling is disabled, the spin buttons are enabled allowing you to manually specify the maximum value for the vertical axis unit of measure. **Auto** is the default selection.

To enable or disable the auto scale:

- ◆ In the **Graph Scales** box on the Histogram Setup dialog box, do one of the following:
 - If the **Manual** option is selected, select **Auto** to enable automatic scaling.
The **Auto** option is selected, or zero is specified for the **Manual** option. The **Manual** option is disabled.
 - If the **Auto** option is selected, select **Manual** to disable automatic scaling.
The **Manual** option is selected, and the spin buttons are enabled. The **Auto** option is disabled.

Manually Selecting the Histogram Scale

When the **Auto** option is disabled, you can manually select the scale range for the vertical axis of the histogram using the spin buttons or editing a value directly in the option box. The vertical scale divisions are adjusted according to the value that you selected.

To manually select the histogram scales:

1. Under **Graph Scales** on the Histogram Setup dialog box, select the **Manual** option.
The **Manual** option is selected, and the **Auto** option is disabled. The spin buttons are enabled for manual selection of the vertical scale.
2. Do one of the following:
 - Choose the up or down spin button to increase or decrease the maximum vertical scale value.
The maximum range of the vertical scale on the histogram is set according to the value that you selected.
 - Enter the value that you want for the vertical scale directly in the option box.
The maximum range of the vertical scale on the histogram is set according to the value that you selected.
3. Click **OK**.
The Histogram window is displayed, and the number that you selected is displayed at the top of the vertical axis. The scale divisions are adjusted evenly between zero and the number that you selected.

NOTE:

Specifying a manual value of zero automatically selects auto scaling.

9.11.2. Rebuilding the Events Window

You can change the kinds of events that you want to view in real time on the Events window, using the **Rebuild** button. When the rebuild button is used, the events buffer is filtered for the currently selected **Event Filter Control Panel** buttons. The DominoFE interface continuously collects event data in its Events buffer, which can store up to 500 events at one time.

To rebuild the Events window:

1. From the Events window, choose the **Event Filter Control Panel** buttons for the events that you want to view.

The buttons that you selected appear pressed "in." You can select all events by choosing the **All In** button.

2. Click **Rebuild**.

The events buffer is screened for the currently selected events, which are displayed on the Events window.











Click the **EV** toolbar button to display the Events window.

Appendix: DominoFE Real Time Toolbar



The buttons that control the DominoFE interface are displayed on the Real Time Toolbar, in addition to the standard Real Time buttons.

Click		To
	Restart	Restart the application.
	Pause	Pause the scrolling of the statistics windows and the Events window while continuing to monitor subsequent network traffic. When you are finished viewing the traffic, choose the Pause button again to resume the display of traffic. The Pause button does not apply to the Transmit screen, and it does not work for the Histogram.
	Network Status	Display the Network Status window.
	Detailed Statistics	Display the Detailed Statistics Selection dialog box.
	Events	Display the Events window.
	Histogram	Display the Histogram Setup dialog box for initial setup, or the Histogram window.
	Transmit	Display the Transmit Screen.
	Error Statistics	Display the Error Statistics window.

Click

To



MII Registers

Display the MII Registers window.



Hex Trace

Display the Hexadecimal Trace window for the current frame.



To hide or display the Real Time Toolbar, choose **Options/View Toolbar** from the **Control** menu.

Glossary

100Base-FX

IEEE 802.3u Physical Layer specification for 100 Mbps Ethernet using two-pair fiber medium.

100Base-T4

IEEE 802.3u Physical Layer specification for 100 Mbps Ethernet using four-pair Category 3, 4, and 5 UTP or STP media.

100Base-TX

IEEE 802.3u Physical Layer specification for 100 Mbps Ethernet using two-pair Category 5 UTP medium.

30 sec. avg frame size

The 30-second average frame size is calculated using the equation, (Total frame size) / (Total frame count). The measurement is calculated over the last 30 seconds. For capture statistics, only captured frames are used to calculate the statistic; only transmitted frames are used to calculate the transmit statistics.

address resolution

A process defined by protocols where corresponding types of network addresses are determined from a known address. For example, address resolution may be used to determine a node's hexadecimal address from the symbolic name. Address resolution is used when a network node has more than one address (hardware and protocol) associated with it.

average frame rate

The average frame rate is reported in frames per second and is calculated since the start of Real Time using the equation, (Total of frame rate values) / (Number of samples). For capture statistics, only captured frame rates are used to calculate the statistic; for transmit statistics, only transmitted frame rates are used.

bit times

The duration of bits transferred to and from the Media Access Controller (MAC).

broadcast frames

Network frames that are transmitted to all network stations; such frames all have a destination address of FF-FF-FF-FF-FF-FF.

byte times

The duration of a byte transferred to and from the Media Access Controller (MAC).

capture buffer

A part of the available Domino RAM set aside for the temporary storage of frames as they are received from the network.

child setup dialog box

Describes a setup dialog box that is accessed or "born" from a higher level dialog box, which controls the status of the child setup selections. The Filter/Trigger Setup dialog box is a child dialog of the Fast Ethernet Main Setup dialog box. The Custom Filter/Trigger Setup dialog box is a child dialog of the Filter/Trigger Setup dialog box.

detailed statistics windows

The detailed statistics windows are available from Real Time and include the Detailed Network Statistics window and the Detailed Capture Statistics window.

dribble

A framing error when extra bits or nibbles create a frame that does not end on an octet boundary.

excess collision

A transmit collision statistic (on the Error Statistics window) that keeps track of the number of times that a frame from the DominoFE interface collided 16 times without successful transmission.

filter

Describes a user-defined set of parameters to be applied to received network data to limit the type of data to be examined in the capture buffer.

FILTER.FLT

The file name for the default filter/trigger definition file.

filter/trigger child setup dialog box

Identifies all of the filter/trigger dialog boxes that are accessed from the Filter/Trigger Setup dialog box including: Custom Filter/Trigger Setup dialog box, Custom Filter/Trigger Fill Setup dialog box, Import Filter/Triggers dialog box, and Protocol Filter/Trigger Setup dialog box.

flood mode

An alternative way to transmit frames from the DominoFE interface. Flood mode makes use of the Defer Time option to allow you to stream frames onto the network with much smaller gaps (down to 480 nanoseconds) between frames than you otherwise could achieve using normal frame transmission and the **Interframe Gap** option. The **Interframe Gap** option is not used when flooding frames.

frame rate

The frame rate is reported in frames per second and is calculated using the equation, (Total frame rate in the last interval) / (interval). The interval is approximately 1 second for capture statistics, and 0.5 second for network, transmit and receive statistics. For capture statistics, only captured frame rates are used to calculate the statistic; for transmit statistics, only transmitted frame rates are used.

full-duplex

A method of data transmission that allows simultaneous transmission and receipt of frames over the network link.

half-duplex

A method of data transmission that allows either transmission or receipt of frames over the network link at any one time.

late collision

A collision that occurs after the first 64 bytes of a frame have been transmitted.

LLC

Logical Link Control. A protocol that was originally defined in the IEEE 802.2 standard and adopted by ISO 8802 that describes functionality in the upper sub-layer of the Data Link Layer. LLC can be used to provide either connection-based or connectionless services in transferring data.

MAC

Media Access Control. A protocol for the Data Link Layer of the OSI model that determines how a device can access the physical media.

MDI

Media Dependent Interface.

MDIX

Media Dependent Interface (Crossed-Over).

MII

Media Independent Interface.

multicast frames

Network frames that are sent to a group of network stations using a group destination address, which allows multiple stations to listen to a single address.

network utilization percentage

The actual network load (valid frames) expressed as a percentage of the maximum possible network load. In full-duplex mode, because data is transmitted and received simultaneously (effectively doubling the bandwidth), the utilization percentage can be as high as 200%.

operating mode

Describes one of two ways to set up the DominoFE analyzer: **Monitor** or **Emulate** mode. **Monitor** mode sets up the analyzer to receive network traffic only. **Emulate** mode sets up the analyzer to both receive and transmit network traffic.

packet translation

Describes the process of decoding or interpreting the fields contained in a network frame, or packet.

parent dialog

Describes the controlling or top-level dialog from which other dialogs (child dialogs) are accessed; Fast Ethernet Main Setup is a parent dialog.

PCS

Physical Coding Sublayer. Part of the Physical Layer implementation for 100BASE-X Fast Ethernet devices that is defined at the upper sub-Layer of the Physical Layer Device (PHY). The PCS uses a 4B/5B coding method.

preamble collision window

Describes a period of time used to determine if a network collision has occurred during receipt of a network frame by the DominoFE interface. Each network frame is analyzed by the DominoFE interface and carrier sense (CRS) is monitored to determine if a network collision has occurred in this time period. If CRS returns anywhere during receipt of the frame preamble, up to 8 bytes past the Start of Frame Delimiter (SFD), then a collision is counted.

preamble pattern

A pattern indicating the beginning of frame transmission. The standard preamble consists of a total of 64 bits, or eight octets. The first seven octets contain the bit pattern 10101010. The last octet of the preamble contains the two bits for the start frame delimiter (SFD), with the bit pattern 10101011.

processed frame

A frame that is copied from the capture buffer and sent to the PC.

Real Time

The part of the Domino software that monitors network traffic and interfaces with the analyzer and the network interface. Capture, Monitor, Transmit, and the Toolbox applications run over the Real Time software and add their own unique features to those available from Real Time.

short events

Network frames received by the DominoFE analyzer in less than 84 bit times.

symbol error

A symbol error occurs when an invalid symbol is received by the Physical Layer. The DominoFE analyzer reports the number of frames containing a symbol error on the Error Statistics window when the analyzer is operating at 100 Mbps.

toggle option

An option that is alternatively enabled or disabled when it is selected. A checkmark indicates that the option is enabled. If the option is currently disabled, selecting it enables the option. If the option is currently enabled, selecting it disables the option.

transmit buffer

A hardware buffer that stores up to 256 KB of frames that have been selected for transmission on the Transmit Screen.

transmit collisions

Detected by the DominoFE analyzer when it attempts to transmit a network frame at the same time another network station is trying to transmit on the network.

transmit queue

A software buffer that contains up to 1000 pointers to reference frames stored in the transmit buffer. The transmit queue maintains transmission options such as the transmission order, repetition of frames, FCS, and interframe gap for frames that have been selected for transmission.

transmit.btx

The file name for the analyzer's transmit file, which is stored in the PC subdirectory C:\DOMINO\DOMx. The extension .BTX distinguishes the DominoFE transmit file from other interface files.

trigger

Describes a user-defined set of parameters to be applied to received network data to identify a network event and capture network data for examination in the capture buffer.

undersized

Network frames received by the DominoFE analyzer that are less than 64 bytes in length, not including Short Events.

unicast frames

Network frames that are transmitted to a single network station destination address.

valid frame

A frame that adheres to the IEEE 802.3 Ethernet frame format.

X Values

Values that can be specified in a filter/trigger definition to indicate wildcard bit patterns, or bit patterns that can contain any value in order to pass the filter/trigger conditions.

Index

A

- addressing
 - filter receive address 5-4
- advanced setup 2-6, 9-1, 9-4. *See also* "Domino Operating Guide"
- Advanced Setup dialog box
 - description 4-2
- analyzing
 - post-capture 2-9
 - real-time 2-9
- applications
 - Capture 2-8, 2-9
 - Examine 2-8, 2-9
 - Monitor 2-8, 2-9
 - setting up 2-8
 - Transmit 2-8
- auto-negotiation
 - advertisement options 7-2–7-3
 - for duplex mode 4-4–4-5
 - for network speed 4-4
 - overview 7-1
 - setup 7-1–7-3
 - using two analyzers 7-1
- autopad, enabling 5-2

C

- cables
 - connecting 2-5
 - Domino-to-Domino 3-2, 3-3
 - Domino-to-PC 1-2, 3-2, 3-3
 - Domino-to-Printer 3-2, 3-3
 - power cable 1-2
- cabling
 - basic rules 3-10
 - media types
 - for MII 3-17
 - pin wiring 3-10
 - for dual monitoring 3-12–3-14
 - for MDI emulation 3-15
 - for MDIX emulation 3-16
 - for MII emulation 3-17
 - rules for dual-monitoring connections 3-11

- Capture application 2-8, 2-9
- capture buffer 5-5
 - DominoFE analyzer 9-1
 - using filters 6-1–6-2, 6-5
 - using post-trigger capture option 6-6
- capture data
 - limiting 9-4
- capture file
 - importing frames for transmission 8-6–8-7
 - opening for import 8-7–8-8
 - saving network traffic 9-1
- capture statistics, detailed *See* detailed capture statistics
- capturing network traffic 9-1–9-4
- capturing traffic to disk 9-1
- carrier sense detect 8-27
- CD-ROM 2-1, 2-2
- CE mark conformity 1-4
- chassis 1-2
- cleaning the DominoFE analyzer 1-8
- clearance requirements 1-7
- collisions
 - fragments 9-5
 - monitoring 9-4–9-5
 - network 9-5
 - transmit 9-5
- components, DominoFE analyzer 1-2, 2-1
- connecting to the network
 - dual monitoring 3-11
 - scenarios 3-12–3-14
 - MDI to MDI 3-10
 - MDI to MDIX 3-10
 - MDIX to MDIX 3-10
 - monitoring status 9-5–9-6
 - overview 3-10
- connection mode 4-1
 - for auto-negotiation 7-1
 - for transmitting 8-1, 8-3
 - selecting 4-2–4-3
- connectors *See also* connecting to the network
 - overview of connecting 3-10
- Customer Support viii

D

- detailed capture statistics
 - description 9-9
 - monitoring network utilization 9-8

- detailed network statistics
 - description 9-9
 - monitoring network utilization 9-8
- disk
 - capture traffic 9-1
- documentation
 - release notes 2-2
- DominoFE analyzer
 - components 1-2, 2-1
 - features 1-1
- Domino-to-Domino cable 3-2, 3-3
- Domino-to-PC cable 1-2, 3-2, 3-3
- Domino-to-Printer cable 3-2, 3-3
- dual monitoring
 - connecting between MDI and MDIX devices 3-13
 - connecting between MDI devices 3-14
 - connection scenarios 3-12-3-14
- dual monitoring 3-11
- duplex mode
 - selecting 4-4-4-5
- E**
- electrical safety 1-3
- emulate mode, selecting 4-2-4-3
- emulation
 - connecting for 3-14-3-17. *See also*
 - connecting to the network
 - MDI 3-15
 - MDIX 3-16
 - MII 3-17
- environmental specifications 1-7
- error statistics, description 9-10
- events buffer 9-17
- events window
 - description 9-10
 - monitoring link status 9-5
 - rebuilding 9-17
- Events window 2-9
- Examine application 2-8, 2-9
- examining network traffic 9-4
- F**
- FCS *See* transmit frames, FCS appending
- features, DominoFE analyzer 1-1
- Filter/Trigger Setup dialog box
 - description 4-2
- filters
 - by address 6-12-6-13
 - by error condition 6-13-6-14
 - canceling 6-19
 - changing byte format 6-10
 - creating 6-7-6-8
 - custom method 6-7, 6-8-6-10
 - protocol method 6-7, 6-12-6-14
 - editing 6-17-6-18
 - file names 6-17
 - filter files
 - default 6-21
 - importing 6-23
 - managing 6-21-6-23
 - opening 6-22
 - saving 6-22-6-23
 - with applications 6-21
 - filter method
 - selecting 6-5
 - using 6-1-6-2
 - find anywhere
 - setting up 6-15-6-16
 - Find Anywhere 6-7
 - finding bytes anywhere in a frame 6-15-6-16
 - for pause frames 6-14
 - frame type 5-5
 - importing 6-7
 - list of definitions
 - adding to 6-20
 - deleting 6-21
 - importing 6-20-6-21
 - maximum 6-19
 - working with 6-19-6-21
 - multiple definitions 6-3
 - naming 6-16-6-17
 - post-trigger capture, setting up 6-6
 - receive group address 5-4
 - saving 4-5, 6-18-6-19
 - setting up 6-3-6-5
 - using a fill pattern 6-10-6-11
 - using multiple definitions 6-1-6-2, 6-7
 - using wildcards 6-7, 6-9
 - working with 6-1-6-2
- flood mode *See* transmit, flood mode
- flow control
 - filtering 6-14
- frame setup wizard
 - using 8-14-8-15

Frame Summary window 2-9
frames, transmit *See* transmit frames
front panel LED indicators 3-5–3-10
full-duplex
 selecting 4-4–4-5

H

half-duplex, selecting 4-4–4-5
hardware
 cleaning 1-8
 clearance requirements 1-7
 DominoPLUS chassis 1-2
 environmental specifications 1-7
 front panel 3-5
 interfaces 1-2
 setting up 2-3
 used in compliance testing, DA-350 1-5
 used in compliance testing, DA-362 1-6

help
 accessing 9-9
 online 2-1, 2-2, 2-9
 readme 2-2

Help
 about statistics 9-5
 accessing 9-6

Hexadecimal Trace window 2-9, 9-1

histograph
 description 9-10
 monitoring network utilization 9-8
 sampling interval
 selecting 9-14–9-15
 scale options 9-12
 selecting 9-15–9-16
 selecting statistics 9-14
 setting up 9-11–9-16
history buffer 9-11

I

IEEE 802.3u 7-1
installation
 procedure, software 2-3
 software requirements 2-3
interface setup
 basic procedure 2-6–2-7

interframe gap *See also* transmit frames, defer time
 flood mode restriction 8-24, 8-31
 queue transmit mode 8-29
 selecting 8-24
 short frames restriction 8-12
 utilization transmit mode 8-29

L

LED indicators 2-9, 3-5–3-10
 interpreting colors 3-7
 monitoring
 link status 9-5
 network status 9-8
 network utilization 9-8

limiting capture data 9-4

line setup
 filters 6-1
 overview 5-1–5-2

Line Setup dialog box
 description 4-2

Link Capability Advertisement dialog box
 description 4-2

link configuration
 enabling 4-1

link status
 monitoring 9-5–9-6

M

MAC-Layer options
 frame type filtering 5-5
 receive group address, enabling 5-4
 setting up 5-1
 transmit autopad, enabling 5-2
 transmit preamble, enabling 5-3

MII registers
 description 9-10

Monitor application 2-8, 2-9

monitor mode, selecting 4-2–4-3

monitoring
 connecting for dual *See* dual monitoring
 full-duplex 2-6
 getting started 2-8
 link status 9-5–9-6
 network traffic 9-7
 network utilization 9-8

N

network load
 testing maximum 8-32
network speed
 selecting 4-4
network statistics, detailed *See* detailed
 network statistics
network status window
 description 9-10
 monitoring network utilization 9-8
Network Status window 2-9
NWay auto-negotiation *See* auto-negotiation

O

online help 2-1, 2-2, 2-9
operating voltage 1-3

P

pause frames, filtering 6-14
PC host port 3-2, 3-3
portable document format 2-1, 2-2
ports 4-2. *See also* connecting to the network
 overview of connecting 3-10
 PC host 3-2, 3-3
 printer 3-2, 3-3
post-capture analysis 2-9
post-trigger capture 6-1–6-2
 setting up 6-6
power cable 1-2
power supply 1-3
preamble, enabling 5-3
printer port 3-2, 3-3
protocol decodes 9-1, 9-4
protocol stack 2-6
 setting up 4-2, 9-4
Protocol Summary window 2-9
publications
 related vii

R

RAM
 capture 2-6
 setting up options 4-2
 stop condition 9-1
readme help 2-2

Index-4

Real Time, analysis 2-9, 9-1
receive group address, enabling 5-4
related publications vii
release notes 2-2

S

safety 1-2–1-7
 class 1-4
saving
 DominoFE interface setup selections 4-5
 filter files 6-22–6-23
 filter options 6-18–6-19
 transmit files 8-32–8-33
saving traffic 9-1
setting up the DominoFE interface
 overview 4-1–4-2
 saving selections 4-5
software
 CD-ROM 2-1, 2-2
 requirements *See* installation, software
 requirements
speed *See* network speed
statistics 2-8
 graphing 9-11–9-16
 opening windows 9-9–9-10
 viewing 2-9
 window descriptions 9-9–9-10
support
 technical viii
symbol errors *See* transmit frames, inserting
 symbol errors

T

technical support viii
traffic
 capturing to disk 9-1
 saving 9-1
transmit
 basic setup procedure 8-3
 benchmark testing 8-31
 buffer description 8-2
 flood mode 8-27, 8-31–8-32
 interframe gap restriction 8-24
 late collisions 8-31
 testing maximum network load 8-32
 overview 8-1
 saving selections 8-4, 8-32–8-33

