

OPERATION MANUAL

## **MODEL 3HRV**

# **HEADEND REVERSE SWEEP RECEIVER**

This document contains information proprietary to Wavetek. The information in this document is not to be used or duplicated in any manner without the prior approval, in writing, of Wavetek.

### **Wavetek**

#### **CATV Division**

5808 Churchman Bypass

Indianapolis, IN 46203-6109

(800)851-1198

(317)788-5960

Fax: (317)782-4607

E-Mail: [catvsupport@wavetek.com](mailto:catvsupport@wavetek.com)

Internet: <http://www.wavetek.com>

11/96 Rev. A

Manual Part No.

6510-00-0300

## WARRANTY

Wavetek warrants that all Products manufactured or procured by Wavetek conform to Wavetek's published specifications and are free from defects in materials and workmanship for a period of one (1) year from the date of delivery to the original Buyer, when used under normal operating conditions and within the service conditions for which they were designed. This warranty is not transferrable and does not apply to used or demonstration products.

The obligation of Wavetek arising from a Warranty claim shall be limited to repairing, or at its option, replacing without charge, any assembly or component (except batteries) which in Wavetek's sole opinion proves to be defective within the scope of the Warranty. In the event Wavetek is not able to modify, repair or replace nonconforming defective parts or components to a condition as warranted within a reasonable time after receipt thereof, Buyers shall receive credit in the amount of the original invoiced price of the product.

Wavetek must be notified in writing of the defect or nonconformity within the Warranty period and the affected Product returned to Wavetek's factory, designated Service Provider, or Authorized Service Center within thirty (30) days after discovery of such defect or nonconformity. Buyer shall prepay shipping charges and insurance for Products returned to Wavetek or its designated Service Provider for warranty service. Wavetek or its designated Service Provider shall pay costs for return of Products to Buyer.

Wavetek shall have no responsibility for any defect or damage caused by improper storage, improper installation, unauthorized modification, misuse, neglect, inadequate maintenance, accident or for any Product which has been repaired or altered by anyone other than Wavetek or its authorized representative or not in accordance with instructions furnished by Wavetek.

The Warranty described above is Buyer's sole and exclusive remedy and no other warranty, whether written or oral, expressed or implied by statute or course of dealing shall apply. Wavetek specifically disclaims the implied warranties of merchantability and fitness for a particular purpose. No statement, representation, agreement, or understanding, oral or written, made by an agent, distributor, or employee of Wavetek, which is not contained in the foregoing Warranty will be binding upon Wavetek, unless made in writing and executed by an authorized representative of Wavetek. Under no circumstances shall Wavetek be liable for any direct, indirect, special, incidental, or consequential damages, expenses, or losses, including loss of profits, based on contract, tort, or any other legal theory.

### **Extended Warranty Programs**

Extended warranties and service contracts are available for new and currently owned equipment for an additional cost. Contact the Customer Service Department (800 851-1198) for details pertaining to extended warranties and service contracts.

### **Return Authorization Procedure**

The customer **MUST** obtain a RETURN AUTHORIZATION NUMBER from the Customer Service Department (800 851-1198) prior to returning any equipment for warranty or non-warranty repair. Wavetek accepts no liability for any instrument or subassembly returned to the factory without this number. Any correspondence regarding returned instruments or subassemblies should be referenced to that number.

# Contents

## SECTION 1 - GENERAL INFORMATION

1.1 INTRODUCTION .....	1-1
1.2 SPECIFICATIONS .....	1-2
1.2.1 Frequency .....	1-2
1.2.2 Level Measurement .....	1-2
1.2.3 Hum Measurement .....	1-3
1.2.4 Carrier to Noise Measurement .....	1-3
1.2.5 Telemetry .....	1-4
1.2.6 Transmitter .....	1-4
1.2.7 Spectrum Mode .....	1-4
1.2.8 Intermodulation Distortion .....	1-5
1.2.9 Depth of Modulation .....	1-5
1.2.10 Serial Interface .....	1-5
1.2.11 General .....	1-5
1.2.12 Powering .....	1-6
1.2.13 Standard Accessories .....	1-6
1.2.14 Options .....	1-6
1.2.15 Optional Accessories .....	1-6

## SECTION 2 - INSTALLATION

2.1 INTRODUCTION .....	2-1
2.2 UNPACKING AND INSPECTION .....	2-1
2.3 INSTALLATION .....	2-1
2.4 WARRANTY INFORMATION .....	2-2
2.5 POWER REQUIREMENTS .....	2-3
2.6 CABLE SPECIFICATIONS .....	2-3
2.7 TECHNICAL SUPPORT .....	2-5

2.8 WORLDWIDE SALES OFFICES .....	2-5
-----------------------------------	-----

## **SECTION 3 - USER INTERFACE**

3.1 INTRODUCTION .....	3-1
3.2 FRONT-PANEL DESCRIPTION .....	3-1
3.2.1 Soft Keys .....	3-1
3.2.2 Measurement Mode Selection Keys .....	3-2
3.2.3 Support Mode Selection Keys .....	3-3
3.2.4 Arrow Keys .....	3-4
3.2.5 Alpha-Numeric Entry Keys .....	3-5
3.2.6 Printing .....	3-6

## **SECTION 4 - OPERATION - HOW TO USE THE 3HRV HEADEND REVERSE SWEEP RECEIVER**

4.1 INTRODUCTION .....	4-1
4.1.1 Wavetek Stealth Reverse Sweep Concept .....	4-1
4.1.2 Basic Reverse Sweep Procedure .....	4-1
4.1.3 Interfacing With Different Network Architectures .....	4-2
4.2 HOW TO SETUP YOUR 3HRV .....	4-5
4.2.1 How to Setup for Reverse Sweeping .....	4-5
4.2.2 How to Setup for Measurement Modes .....	4-12
4.3 SETUP .....	4-13
4.3.1 General Setup .....	4-14
4.3.2 Measurement Setup .....	4-18
4.3.3 How To Setup Your Channel Plan .....	4-19
4.3.4 How To Edit Channel Parameters .....	4-22
4.3.5 Reverse Sweep .....	4-28
4.3.6 Editing a Reverse Sweep Plan .....	4-34
4.4 HOW TO PERFORM LEVEL MEASUREMENTS ....	4-35
4.5 HOW TO MEASURE TILT-BALANCING AN AMPLIFIER .....	4-37
4.6 SCAN MODE .....	4-39

4.7 HOW TO MEASURE C/N .....	4-43
4.8 HOW TO MEASURE HUM .....	4-45
4.9 MODULATION .....	4-46
4.10 SPECTRUM ANALYZER MODE .....	4-47
4.11 SWEEP MODE .....	4-52
4.12 FILE .....	4-54
4.12.1 How to Store/View/Delete Measurement Files ...	4-54
4.13 AUTO .....	4-55
4.13.1 How to Create/Edit/Delete Test Locations .....	4-55
4.13.2 How to Perform an Auto Test .....	4-59
4.13.3 Viewing/Printing Auto Test Files .....	4-67
4.14 STATUS .....	4-73
APPENDIX A: STATUS INDICATORS .....	A-1
APPENDIX B: USER MESSAGES .....	B-1

# MODEL 3HRV

## SECTION 1 GENERAL INFORMATION

### 1.1 INTRODUCTION

The 3HRV Reverse Sweep Receiver is a headend rack mounted unit that handles the reverse sweep job for up to 10 different technicians on the same cluster of nodes.

The addition of the 3HRV to the Wavetek Sweep System takes the responsibility of the reverse sweep away from the 3ST. This serves to speed up the reverse sweep rate. In addition, the 3HRV sends out reverse ingress/noise information with every update of its forward telemetry, so reverse telemetry need not be received in order to check the reverse ingress condition.

#### **Reverse Sweep Alignment**

Reverse sweep alignment provides an optimum view of the frequency response in unoccupied reverse spectrum, leaving nothing to the imagination. A reverse sweep can uncover mismatch problems which reveal themselves as standing waves, or diplex filter roll-offs that can severely hamper the carriage of services in the reverse band.

#### **Ingress Detection and Troubleshooting**

The 3HRV provides feedback to the field as to the current condition of noise and ingress in the headend. Even if the noise or ingress is "swamping" the telemetry a "picture" of the headend noise/ingress is sent out to the receiver via a special forward telemetry carrier for display.

#### **Easy To Read Noise/Ingress Display**

The headend instrument provides a continuous display of the noise/ingress performance of the connected nodes. This provides a quick, easy way for the headend technician to verify performance. In addition, the current reverse testing activity can be monitored.

The 3HRV also performs essential cable TV system preventive maintenance tests with accuracy and ease. Signal levels, hum, C/N, and frequency response can be quickly tested without subscriber interference.

The 3HRV is a full-featured signal analysis meter, with a complete spectrum display and an analog representation of single channel measurement data. When tuned to a specific channel, a comprehensive set of information is provided: tuned channel, video frequency and level, audio frequency and level, the difference between video and audio carrier levels.

The 3HRV is a standard 19" rack mount unit, that weighs approximately fifteen pounds. Its 320 X 240 dot matrix LCD shows measurement data in both graphical and numerical form.

The contents of this manual will describe the care and operation of the Headend Reverse Sweep Receiver, including Reverse Sweep operation.

## 1.2 SPECIFICATIONS

### 1.2.1 Frequency

Range:	5 to 1,000 MHz
Accuracy:	$\pm 10$ ppm at 25°C; $\pm 10$ ppm drift over temp.; $\pm 3$ ppm/year aging
Resolution Bandwidths:	30, 280 kHz (30 kHz for CSO)/CTB only)
Tuning Resolution:	10 kHz
Sweep Resolution:	250 kHz maximum

### 1.2.2 Level Measurement

Range:	-40 to +60 dBmV
Resolution:	0.1 dB
Accuracy:	$\pm 1.0$ dB from 0 to + 40°C (typical), (relative to 25°C)

Digital Average Power

Option Accuracy:  $\pm 1.8$  dB at 25°C

### 1.2.3 Hum Measurement

(carrier  $\geq 0$  dBmV) Non-scrambled channels only

Range: 0 to 10%

Resolution:  $<0.2\%$

Accuracy:  $\pm 0.7\%$

### 1.2.4 Carrier to Noise Measurement

Non-scrambled channels only. No preselection required for 78 channels at +10 dBmV input level.

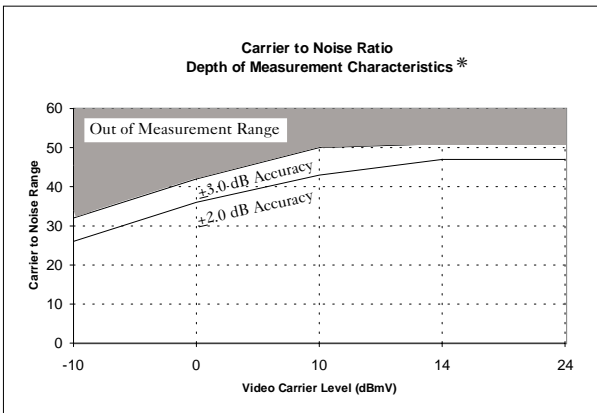

\*Specified results with the measurement offset within 2 to 3 MHz range above the video carrier.”

Resolution: 0.5 dB

Range: 52 dB maximum

## 1.2.5 Telemetry

Frequency: User defined, 5 to 1,000 MHz

Modulation: FSK, 100 kHz deviation

Spectrum Required:  $\approx$ 1 MHz recommended

## 1.2.6 Transmitter

Frequency Range: 5 to 1,000 MHz

Level Range: +20 to +50 dBmV; settable in 2 dB increments

Spectral Purity: Hars -30 dBc; Spurs -35 dBc

## 1.2.7 Spectrum Mode

Spans: 3, 5, 10, 20, and 50 MHz (0.3, 0.5, 1, 2, and 5 MHz/div)

Sweep Rates: 2 seconds (50 & 5 MHz)

Display Scaling and Range: 0.5, 1, 2, 5, and 10 dB/division; 6 vertical divisions

Spurious Free Dynamic Range: 60 dB (typical specifications)

## 1.2.8 Intermodulation Distortion

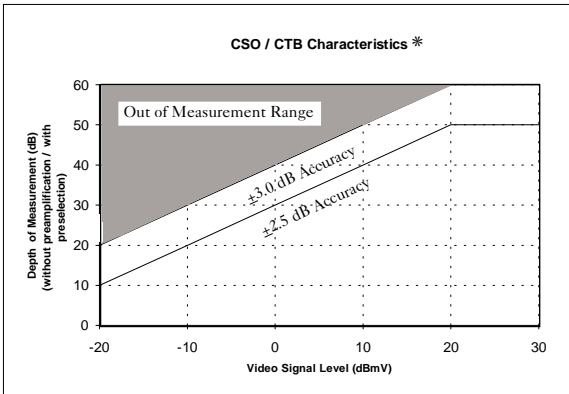

### \*Typical Specifications

Range: 60 dB maximum

Resolution: 1 dB

## 1.2.9 Depth of Modulation

Assumes presence of white reference on any VITS line. Non-scrambled channels only.

Range: 80 to 100%

Resolution: <0.5% at 85%

## 1.2.10 Serial Interface

Serial, RS232; Epson, IBM Printers

## 1.2.11 General

Log Linearity:  $\pm 0.5$  dB (typical)

Flatness:  $\pm 0.5$  dB @ 25 °C, @ 20 dBmV

Dimensions: 3HRV: 48.3 cm (W) x  
13.3 cm (H) x 35.6 cm (D), 19" (W) x 5.25"  
(H) x 14" (D)

Weight: 3HRV: 6.8 kg (15 lbs.)

Operating  
Temperature Range: 0 to +50°C; 32 to 122°F

## 1.2.12 Powering

Frequency 47 to 63 Hz ~ 100 VA

Input Current: 1.2A @ 100 VAC.  
0.5A @ 265 VAC.

Fuse 1.25 A, 250V 5X20mm SLO-BLO (2  
required)

## 1.2.13 Standard Accessories

Line Cord  
Channel Plan Transfer Cable  
Operations Manual

## 1.2.14 Options

16/64 QAM Digital Carrier Power Measurement - Enables Stealth to perform accurate level measurements on digital carriers.

## 1.2.15 Optional Accessories

1010-00-0342	Citizen PN60 (thermal fusion) Printer
1019-00-0457	Optional Battery for PN60 Printer
3010-59-0009	Citizen PN60 Printer Ribbons (2) (included with printer)
1217-50-0159	Citizen PN60 Printer Cable (included with printer)
4010-00-0105	Charger/Adapter 120VAC to 18VDC
1019-00-0437	Charger/Adapter 220VAC to 18 VDC

SBC-1	Charger for one spare Stealth Battery Cartridge
SBC-6	Charger for up to six spare Stealth Battery Cartridges
1217-50-0151	Stealth Serial Printer Cable
PP-75	Precision Preselector for Carrier-To-Noise and Intermodulation Distortion Testing (55 to 440 MHz)
PP-55-110	Tunable Precision Preselector (55 to 110 MHz)
PP-110-220	Tunable Precision Preselector (110 to 220 MHz)
PP-220-440	Tunable Precision Preselector (220 to 440 MHz)
PP-440-880	Tunable Precision Preselector (440 to 880 MHz)
7201	Tunable Precision Preselector (31 to 62 MHz)
7202	Tunable Precision Preselector (62 to 125 MHz)
7203	Tunable Precision Preselector (125 to 250 MHz)
7204	Tunable Precision Preselector (250 to 500 MHz)

## SECTION 2 INSTALLATION

### 2.1 INTRODUCTION

This section provides information on how to install the 3HRV Headend Reverse Sweep Receiver.

### 2.2 UNPACKING AND INSPECTION

The instrument was inspected, and given final operational and quality control tests prior to being carefully packaged for shipment. The unit should operate in accordance with the specifications listed in this manual.

When unpacking the instrument, inspect the shipping container and instrument for shipping damage. If the container is damaged, phone Wavetek immediately. Save the shipping carton and packing materials for possible future use.

FOR CUSTOMER SERVICE call: WAVETEK: (800) 851-1198, International Customers, contact your local Wavetek Representative.

### 2.3 INSTALLATION

Proper installation of the 3HRV is essential to correct operation of the system. The 3HRV is typically installed in a headend rack. There are two different recommendations for setting up the system. One entails receiving the reverse sweep signal at a standard reverse node combiner, and inserting the telemetry with a directional coupler (test point) at the input of the forward combining network.

Alternately, to prevent from having to tap into the system an additional time, you may also insert the telemetry by connecting to the output of the 3ST. The telemetry insertion directional coupler (DC b) tap loss must be taken into account when setting the insertion level of the telemetry signal.

The transmitter output level is variable from +20 to +50 dBmV in 2 dB increments. The output level will be attenuated by the tap value of the directional coupler. For example, if a telemetry signal level of +16 dBmV is desired on the system and the output of the 3HRV is set to +36 dBmV, a directional coupler value of 20 dB may be used, or the combination of a lower value directional coupler and an attenuator pad.

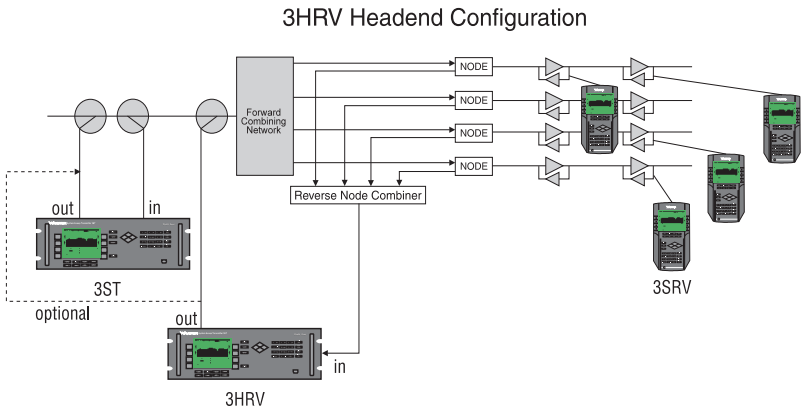

An alternate method would be to insert the 3ST Transmitter output at one of the combining network inputs, and connect the (transmitter) reference input to the headend amplifier input test point. This method eliminates the need to add directional couplers at the combiner output.

**Note: A duplex filter must be used to couple the forward path to the input of the 3HRV for all measurement mode operations other than reverse sweeping.**

For detailed setup information, see "Stealth Sweep Start-up Procedure", page 4-1.

## 2.4 WARRANTY INFORMATION

The 3HRV is covered by a one year parts and labor warranty (for details, see "Warranty", opposite Table of Contents).

## 2.5 POWER REQUIREMENTS

The 3HRV operates on 90-265 VAC, 57-63 Hz single phase input power source.

## 2.6 CABLE SPECIFICATIONS

There are two cables associated with the operation of the 3HRV; Stealth to Stealth, and a Serial Printer cable. The following information describes each of the associated cables.

### Stealth to Stealth

The Stealth to Stealth cable, (1217-50-0149) provided with each 3HRV, is used for communications between Stealth units.

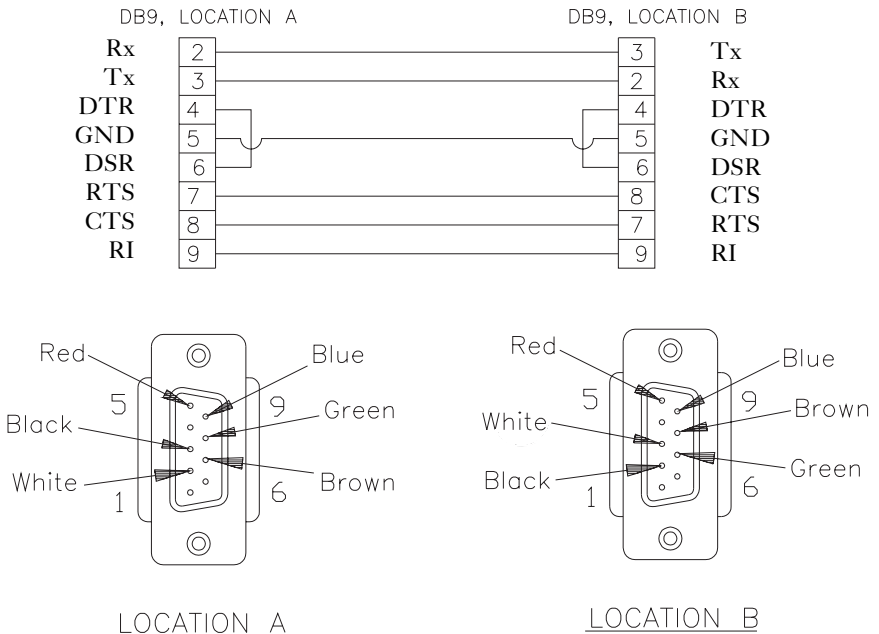

## Serial Printer Cable

The Serial Printer Cable, (1217-50-0151) can be used to print data directly from the 3HRV.

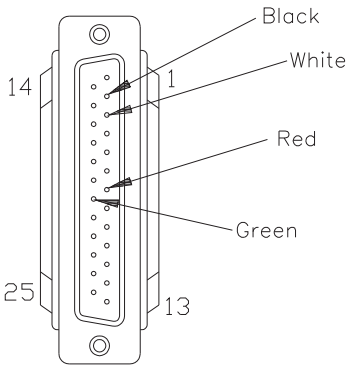
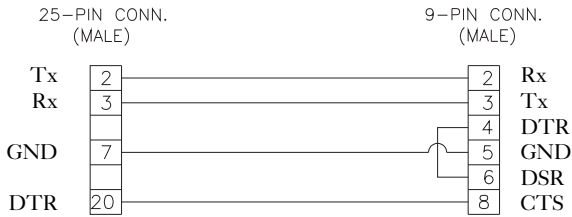

LOCATION A

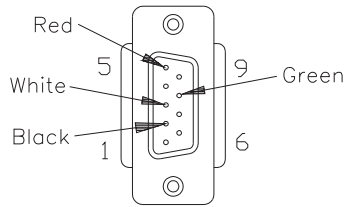

LOCATION B

## 2.7 TECHNICAL SUPPORT

We've worked hard to make the 3HRV as easy-to-use as possible. However, if you have a problem using your unit you can contact Wavetek's Technical Support for help. You can reach Wavetek's Technical Support, Monday through Friday between 8 am and 5 PM at **(317) 788-5960**. Wavetek also maintains a support forum on the Internet. You can leave messages and a Support Specialist will get back to you at Internet address: [CATVSUPPORT@wavetek.com](mailto:CATVSUPPORT@wavetek.com).

If you received your Stealth unit and found it to be damaged or incomplete in any way, phone Wavetek immediately. Save the shipping carton and packing material in the event that you have to return it.

FOR CUSTOMER SERVICE call: WAVETEK (800) 851-1198, International Customers, contact your local Wavetek Representative.

The above numbers can also be accessed on your unit by pressing the **FCN** key followed by the **help** key.

## 2.8 Worldwide Sales Offices

Austria (Vienna)

Tel: (43) 1-214-5110

Fax: (43) 1-214-5109

China (Beijing)

Tel: (86) 10-592-8044

Fax: (86) 10-500-8199

France (Paris)

Tel: (33) 1-4746-6800

Fax: (33) 1-4746-5656

Germany (Munich)

Tel: (49) 89-996-410

Fax: (49) 89-996-41160

Hong Kong

Tel: (852) 2788-6221

Fax: (852) 2788-6220

Japan (Tokyo)

Tel: (81) 427-57-3444

Fax: (81) 427-57-5722

Singapore

Tel: (65) 356-2522

Fax: (65) 356-2553

United Kingdom (Norwich)

Tel: (44) 1603-404-824

Fax: (44) 1603-483-670

## **SECTION 3 USER INTERFACE**

### **3.1 INTRODUCTION**

This section will help you become familiar with the front-panel controls of the Model 3HRV. Included are descriptions of the front-panel and notes on the use of features.

### **3.2 FRONT-PANEL DESCRIPTION**

The hardware portion of the user interface consists of a 320x240 dot matrix LCD and a 40-key keypad. The keypad includes:

- eight Soft keys
- eight Measurement Mode selection keys
- four Support Mode selection keys
- four Arrow keys
- sixteen Numeric Entry keys

#### **3.2.1 Soft Keys**

There are a total of eight vertically oriented soft keys, four on either side of the display. The function of each soft key changes depending on the particular operation being performed. The function is indicated on the display next to the associated soft key. Soft keys are not always active. When a soft key is inactive, its indicator is either dimmed (grayed) or does not appear at all.



## 3.2.2 Measurement Mode Selection Keys

Measurement modes are chosen by pressing the appropriate Measurement Mode Selection key. There is a key for each of the eight major measurement functions. These keys are located directly below the display.

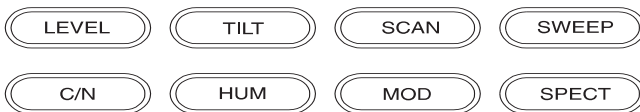

**LEVEL:** Signal level measurements on individual channels are made by entering a specific channel number and pressing the channel key. Measurements can also be made by selecting the carrier with a marker in the Scan mode and pressing the Level key.

**TILT:** The Tilt mode simplifies the balancing of pilot levels by displaying a bar graph with a representation of up to nine different user selected video carrier levels.

**SCAN:** Use the Scan mode to get a good look at absolute carrier levels. In this mode a bar graph showing all carrier levels is displayed.

**SWEEP:** This mode monitors the signals injected into vacant spectrum areas by the 3SRVs. Also, through telemetry transmits to the field current condition of noise and ingress to any 3SRV Receivers that are connected to the system.

**NOTE:** Telemetry occurs only while the unit is in Sweep mode. Selecting another mode will result in a loss of telemetry to any Receivers connected to the system.

**C/N:** Measures the C/N (carrier to noise) ratio of the tuned channel or frequency will be displayed.

**HUM:** Measures the hum modulation of the tuned channel, will display in either % or dB as selected by the operator.

**MOD:** Allows the user to listen to the modulation of the tuned channel of frequency and measure Depth of Modulation of a video carrier.

**SPECT:** Provides a Spectrum Analyzer display, and CSO/CTB measurements.

### 3.2.3 Support Mode Selection Keys

Support modes are accessed using the Support Mode Selection keys. There is a key for each of the four support functions. These keys are located to the right of the display.

File

Auto

Setup

Print

**File:** Allows the user to access measurement files.

**Auto:** This function provides automated FCC 24 hour testing capabilities.

**Setup:** The setup functions are used to set or adjust the operating parameters of the unit.

**Print:** Allows the user to print the current measurement screen.

### 3.2.4 Arrow Keys

The four Arrow keys are used for various purposes. Their functions are described in the individual sections for each operating mode. These keys are located to the right of the Support Mode Selection keys.

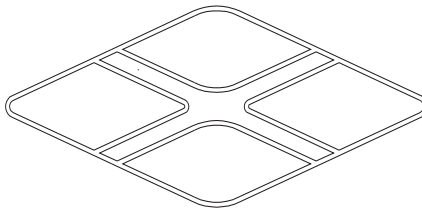

## 3.2.5 Alpha-Numeric Entry Keys

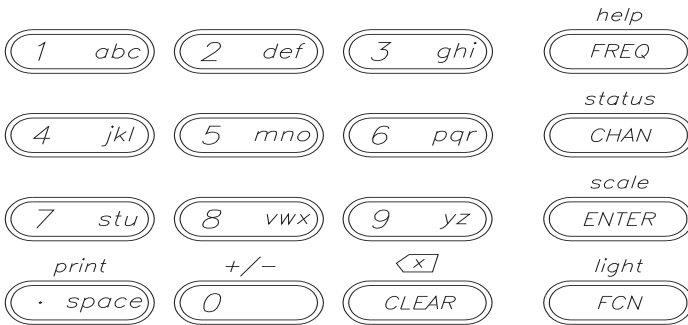

The Alpha-Numeric keys are used to enter data as needed during the operation of the unit. There are three indicators associated with keypad entry. These indicators appear in the title bar to the left of the time. The three are as follows:

$\text{A}_{\text{B}}\text{C}$  - alpha entry mode

$1_{23}$  - numeric entry mode

$\text{⬆}\text{⬇}\text{⬆}$  - multiple choice mode

### Alpha Entry Mode

Most numeric keys have alphabetic characters printed on them. These characters can be accessed when the alpha entry indicator appears in the title bar. In the alpha entry mode, a cursor appears below the active position. Repeated pressing of an alphanumeric key sequences through the values printed on the key. Once the desired character is selected, the cursor is moved to the next position using the **LEFT** or **RIGHT** arrow keys. Special characters are available using the **UP** and **DOWN** arrow keys.

Alpha entry must be terminated by pressing the **ENTER** key.

## **Numeric Entry Mode**

In the numeric entry mode, only the numerals 0 through 9 and the decimal point can be entered. When negative values are allowed, the FCN, +/- key sequence toggles between positive and negative entry. The numeric value may also be incremented and decremented using the **UP** and **DOWN** arrow keys.

Numeric entry must be terminated by pressing the **ENTER** key.

## **Multiple Choice Mode**

This mode allows you to sequence through a series of choices which appear in the edit box.

### **3.2.6 Printing**

Any measurement mode screen can be printed directly. Press the **Print** key to print the current measurement screen. To print a measurement file, simply view the file and print it as you would a current measurement screen.

## SECTION 4 OPERATION - HOW TO USE THE 3HRV HEADEND REVERSE SWEEP RECEIVER

### 4.1 INTRODUCTION

This section provides detailed operation of the 3HRV. Included are detailed descriptions of the various displays of the selected modes of operation.

#### 4.1.1 Wavetek Stealth Reverse Sweep Concept

With the reverse sweep option, a transmitter is built into the hand-held sweep receiver. The headend reverse sweep receiver (3HRV) is set up to receive the reverse sweep sent from the field. When a reverse sweep is activated from a field test point, the 3HRV receives the telemetry signal that indicates which receiver is sending the sweep. The headend receiver measures the sweep, and sends the results, along with the serial number of the sending receiver via its telemetry signal to the field. The field receiver with the tagged serial number then displays the sweep response as measured in the headend on its LCD. Up to 10 receivers at a time can perform reverse sweeping. If additional receivers attempt to sweep a message is displayed.

#### 4.1.2 Basic Reverse Sweep Procedure

Sweeping the reverse path is a little different from sweeping the forward path. Because the system is designed with appropriate spacing for the forward high frequency range, the reverse path may not require amplification at each station. The lower frequencies aren't attenuated in cable as much as the higher frequencies. In sweeping the forward path the amplifier is aligned such that its output is within certain limits (the amplifier compensates for the cable behind it). However in sweeping the reverse path the amplifier is aligned such that the response at the headend is within certain limits *from this amplifier alignment point*. So, in the reverse path the amplifier compensates for loss characteristics in the cable in front of it.

This is why it is best to transmit the sweep from the amplifier test point and measure it in the headend. This ensures that the system is properly aligned to carry signals in the reverse path.

### 4.1.3 Interfacing With Different Network Architectures

#### Single Cable - Split Band Network

The Model 3HRV is connected in the headend as shown in figure 1. The connections are similar to those made for forward sweep, with the monitor output connected to the combining network. This allows the 3SRV to receive telemetry signal from the 3HRV.

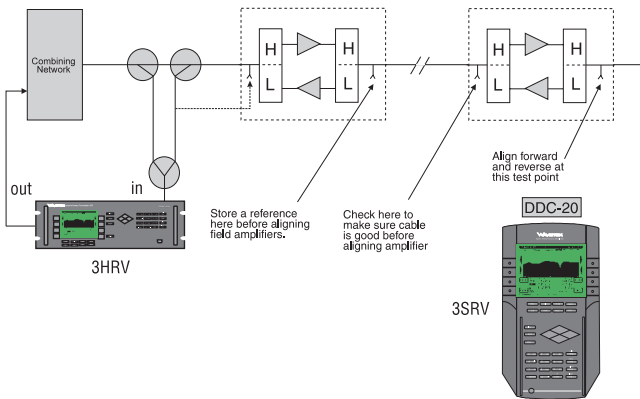
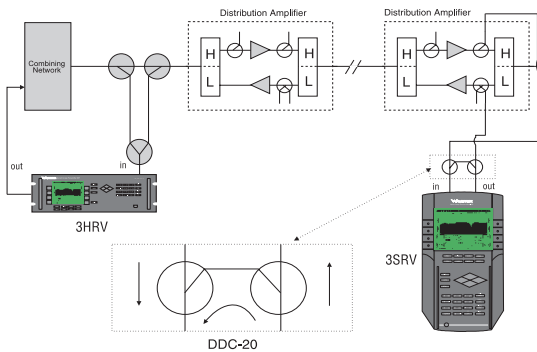

*Figure 1. Single Cable — Split Band Network Reverse Sweep Configuration With Bi-Directional Test Points.*

In the field, systems with bidirectional test points, (forward and reverse signals both present on the same test point) a summing network (provided with each reverse sweep option) is used to enable reception of forward telemetry and sweep, as well as inject reverse telemetry and sweep. This summing network simplifies the connection of the field receiver to the test point.

Systems with directional test points are set up as shown in figure 2. In this configuration two directional couplers are used to provide a sample of the reverse sweep output to the input of the 3SRV receiver.

The directional coupler on the input side should be designed for at least the frequency range of the forward bandwidth of the network under test. (This coupler network should never be connected to the system without the 3SRV attached, or the resulting lack of isolation may cause signals from the forward path to bleed over to the reverse path.)



*Figure 2. Single Cable - Split Band Network Reverse Sweep Configuration With Directional Test Points.*

Another common architecture, which is only slightly different from those described above, prescribes the use of fiber optics to "nodes". In these architectures the installation of the 3HRV in the headend is as shown in figure 3. The connection at the node may be as shown in figure 4. Notice that in this configuration the forward and reverse test points are separated, and two directional couplers must be used. In all of these connection scenarios, either a summing network or two directional couplers are used to interface with the system test points. Care should be taken to use the same interface at each test point to ensure that the normalization process is cancelling out any response variation caused by the interface.

It is also important to remember not to make absolute level measurements through the summing network due to the insertion loss and frequency response characteristics of the interface.

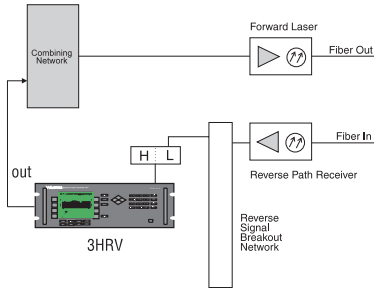

*Figure 3. Transmitter Connections In Headend For Hybrid Fiber/Coax Networks*

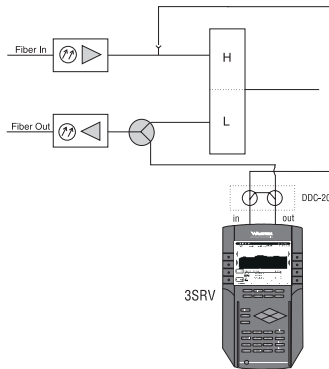

*Figure 4. Fiber Node Test Point Connections*

## Dual Cable Network

Another possible, though rare, network configuration is the "Dual Cable Network", in which a full bandwidth is used for both forward and reverse - essentially two cable systems overlaying each other with signals carried in opposite directions. These networks are impossible to sweep simultaneously in both directions with one man.

The problem is that the two systems use the same spectrum, making it impossible to distinguish between the two with one instrument.

The recommended method for these systems is to first sweep the forward portion of the network, then move the transmitter out to the furthest extremity and sweep the reverse portion.

## 4.2 HOW TO SETUP YOUR 3HRV

### 4.2.1 HOW TO SETUP FOR REVERSE SWEEPING

To setup the Reverse Sweep on the 3HRV, press the **SETUP** key and select the “Reverse” option from the Setup menu. The Reverse Sweep setup screen will appear.

**Important: To prevent the 3HRV reverse sweep from contending with the 3ST, disable the 3ST's reverse sweep. This will speed up the 3ST's forward sweep. Multi-user contention can also be eliminated by offsetting reverse channel plans, and by using different telemetry frequencies.**



## Forward Telemetry Frequency

Use the **UP** and **DOWN** arrow keys or the numeric keypad to enter the telemetry frequency.

**NOTE: For successful Stealth mode operation, the Rx Forward Telemetry frequency (3HRV) must match the Tx telemetry frequency setting of the Model 3SRV.**

**Caution: Do not place the telemetry signal too close to the diplex filter cut-off frequency in that roll-off may attenuate the telemetry signal to the degree that communication fails. This same caution applies to placing the signal in the high end roll-off region.**

## Forward Telemetry Level

This is the level of the carrier that the 3HRV uses to transmit telemetry data. Use the edit box to set the Telemetry Level to an appropriate value. When adjusting the Telemetry Level, take into consideration the following losses; system, summing network, test point, and amplifier desired input.

Use the **UP** and **DOWN** arrow keys or the numeric keypad to enter the telemetry level (20-50 dBmV).

## Reverse Telemetry Frequency

This is the frequency at which 3SRV units with the Reverse Sweep option will transmit telemetry data. Optimally this will be in a portion of the reverse frequency band with at least 1 MHz free, and at best case, in the high end of the return band to avoid potential interference from ingress.

**IMPORTANT: The frequency of the reverse telemetry carrier should be carefully selected such that it will not interfere with any existing carriers on the reverse plant.**

## Reverse Sweep Plans

Reverse Sweep Plans are used to define the frequencies at which sweep points will be inserted by 3SRV units with the Reverse Sweep option. To access Reverse Sweep Plans, select the “Reverse Sweep Plans” option and then press the **ENTER** key.

### Selecting a Reverse Sweep Plan

The Reverse Sweep Plan screen presents a list of all Reverse Sweep Plans stored in memory. The current active Reverse Sweep Plan is displayed beneath the list of plans. Use the up or down arrow to select the plan you want, then press the Load soft key to load the selected plan into memory for use. Press the **Exit** soft key to return to the previous screen or the **SWEEP** key to begin sweeping.

**SETUP** 00:38:03

**REVERSE SWEEP PLANS**

PLAN_NAME	MODIFIED
REVERSE_PLAN	04/08/05 23:46
PLAN1	04/08/05 23:49

ACTIVE PLAN: PLAN1

PLAN: NCTA\_PLAN

### Creating a New Reverse Sweep Plan

Press the **New** soft key to create a new Reverse Sweep Plan. You will be asked to enter a name for the plan that you are creating. Use the alphanumeric keys followed by the **ENTER** key. Then press the **OK** soft key to continue.

**NOTE:** A warning message will appear if a Reverse Sweep Plan currently exists with the same name as the plan you are creating.



Next, enter the Start Frequency. This will be the frequency of the first sweep point in the plan. Use the numeric keys followed by the **ENTER** key. Then press the **OK** soft key to continue.



The Interval is entered next. This interval determines the spacing between sweep points. Use the numeric keys followed by the **ENTER** key. Then press the **OK** soft key to continue.

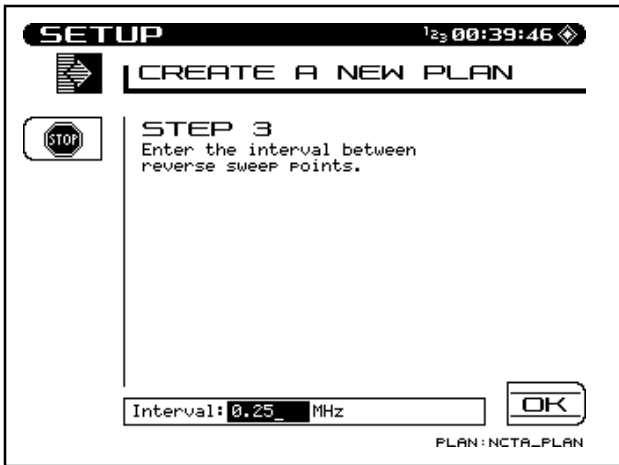

Finally, you are asked to enter the Stop Frequency. There will be no sweep points generated beyond the Stop Frequency. Use the numeric keys followed by the **ENTER** key. Then press the **OK** soft key to continue.

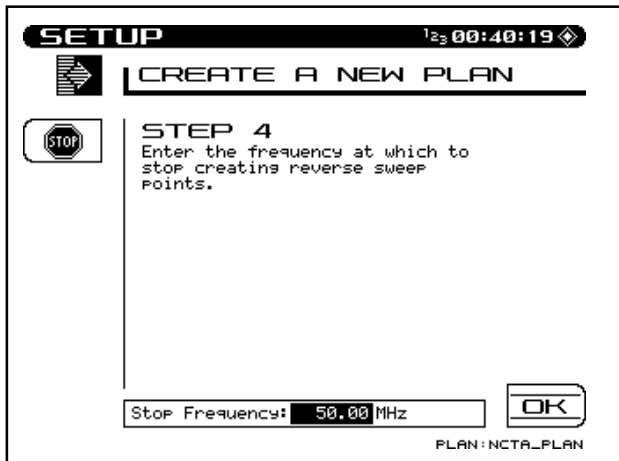

Sweep points are generated beginning at the Start Frequency and continuing until the Stop Frequency is reached. The frequency of each point is calculated by adding the Step Interval to the frequency of the previous point.



After it has been created, the new plan will appear in the Reverse Sweep Plan list.

**IMPORTANT:** You should verify that none of the sweep points contained within the Reverse Sweep Plan will interfere with existing carriers on the reverse plant including other reverse telemetries if the single user is still active. See below to view and edit your channel plan.

### Editing a Reverse Sweep Plan

If desired, the selected Reverse Sweep Plan can be viewed and modified.

Press the **Edit** soft key to display the following screen:

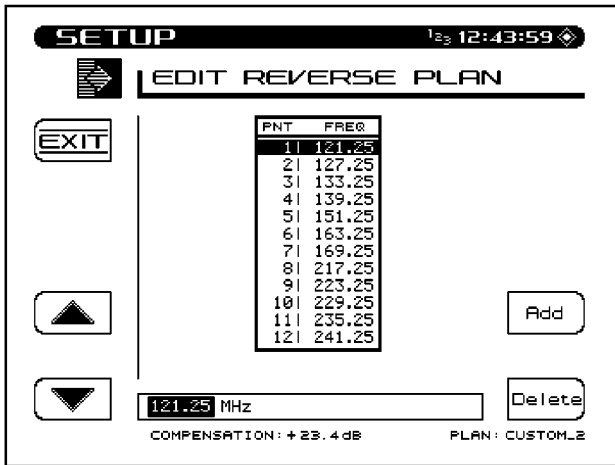

This screen shows a list of sweep points contained within the selected Reverse Sweep Plan. The list consists of the sweep point number followed by the frequency of the sweep point. Use the up and down arrows to scroll through the list.

Note that the frequency of the selected sweep point also appears in the edit box below the list. You can change the frequency by using the numeric keys followed by the **ENTER** key. The list will be updated when the **ENTER** key is pressed.

To remove a sweep point, use the up or down arrow to select the point to be removed, then press the **Delete** soft key.

Press the **Add** soft key to insert a new sweep point into the plan. The new point will be at the same frequency as the point that was selected when the Add soft key was pressed. You will need to set the new point to the desired frequency using the edit box.

When you are finished editing the Reverse Sweep Plan, press the **Exit** soft key to return to the previous screen.

## 4.2.2 How to Setup for Measurement Modes

The following procedure describes the steps to prepare the 3HRV for measurement modes.

### Building A Channel Plan

1. To build a channel plan, first enter the setup mode by pressing the **SETUP** key.
2. Press the Channel Plan soft key, and cursor down the menu to Build Channel Plan.
3. Press the **ENTER** key, and you will be prompted at the first step to name the channel plan to be built. The name should be a logical one that will be easy to remember. The location of the headend is usually a good name for the channel plan. When the name is typed in, press the **ENTER** key.
4. The next step is to choose a channel plan from the built-in list that most closely resembles the plan of your system. Typically your system channel plan will be a subset of the built-in plan. Cursor down to the appropriate channel plan and press the **ENTER** key or the **OK** soft key.
5. You will then be prompted to enter the highest frequency that you would like to scan. Type in the frequency and press the **ENTER** key followed by the **OK** soft key. The unit will then commence a scan for the presence of channels. After the scan is done, this phase of the channel plan building process is complete. Press the **Exit** soft key to return to the Channel Plan menu.

### Editing A Channel Plan

The next step is to edit the channel plan to characterize it for your particular system. Cursor down to Edit Channel Parameters and press **ENTER**. A listing of all the channels within the frequency range designated in the Build Channel Plan phase will appear on the screen. Notice that there are columns for enabled, channel type, channel number, label, frequency (video carrier), sweep, tilt, and, scrambled.

Each of these features for each channel may be edited by cursoring to the channel to be edited and pressing the **Edit** soft key.

Check the listed channels to ensure that channels that you know are not video are not listed as video channels. If during the Build Channel Plan phase the receiver detects a signal at a video carrier frequency it assumes it is a video channel. Some FM carriers may happen to fall at video carrier frequencies for channels 95-97. Be sure these channels are properly designated as video or single carriers. FM signals may be entered as channels, but must be designated as Single Carriers.

At this time be sure to edit each scrambled channel to ensure that it is designated appropriately. A special algorithm is used to ensure that the peak of these signals is measured.

At this time you may also wish to designate tilt channels, and label the channels with call letters, but this is not essential to begin the measurement process.

## **4.3 SETUP**

There are four setup modes for the 3HRV; General, Measurements, Channel Plan, and Reverse Sweep. General setup allows the operator to configure general aspects of the unit (not specifically related to measurements) for personal taste. Measurements setup permits the operator to setup certain parameters that apply to specific measurements. Channel Plan setup allows the operator to configure channel tuning to match the specific characteristics of a particular cable system. Reverse Sweep setup lets the operator setup reverse sweep receiver parameters.

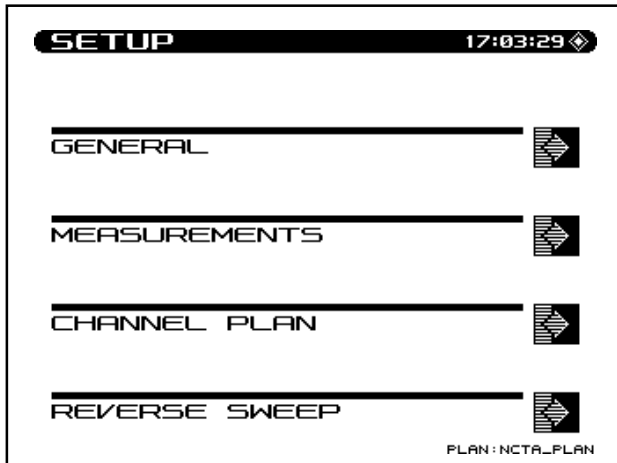

### 4.3.1 General Setup

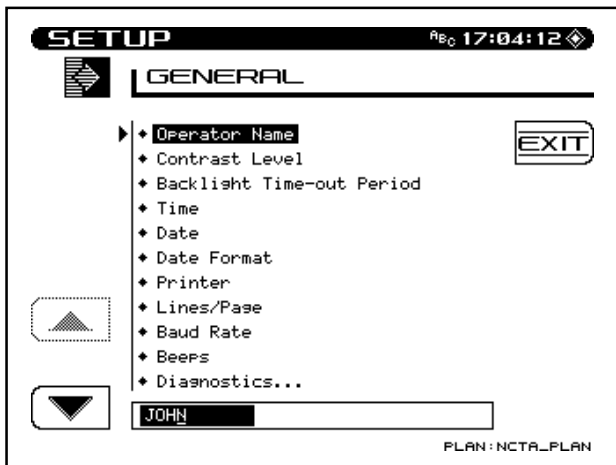

Use the **Up** and **Down** soft keys to scroll to additional setup items. When lists are being displayed, the up arrow soft key dims when the first item in the list is reached and the down arrow soft key dims upon reaching the last item.

## **Operator Name**

Allows the user to enter the operators name. The name will appear in the header section of the Auto Test report.

## **Contrast Level**

Adjusts the contrast level of the LCD for optimum viewing by the operator. The level is varied on a scale from 1-15. Use the **UP** and **DOWN** arrow keys to adjust the contrast.

## **Backlight Time-out Period**

An additional feature is an automatic Backlight Time-out. The time out period is programmable to; always off, 5 sec, 10 sec, or always on. Use the **UP** and **DOWN** arrow keys to set the time-out period. The Backlight can be manually turned on/off at any time by pressing the **Function** key followed by the **Light** second function key.

## **Time**

Use the numeric entry keys to enter the time in the HH:MM:SS format (24 hour).

## **Date**

Use the numeric entry keys to enter the date. The date will be displayed in the format chosen in the Date Format setup menu.

## **Date Format**

Use the **UP** and **DOWN** arrow keys to select the desired date format. When the date format is changed, the new format will appear everywhere the date is displayed or printed. The following date formats are available:

- MM/DD/YY
- DD.MM.YY
- YY.MM.DD

## Printer

Sets the printer interface to the specific type of printer used. Use the **UP** and **DOWN** arrow keys to select the desired printer. The required serial printer configuration is as follows:

- baud rate consistent with 3HRV (recommend 9600 or 19.2K)
- 8 data bits
- 1 stop bit
- no parity
- flow control - hardware handshaking

A serial to parallel converter (such as the one manufactured by Black Box Corp.) is required for printing to a parallel printer. The setup is the same as the serial printer configuration.

## Lines/Page

The number of Lines/Page (min 30, max 255) can be specified for text printouts. This determines the number of lines that are printed before a form feed command is sent. If no form feeds are desired, enter zero for the Lines/Page.

## Baud Rate

The Baud rate is used when establishing communications between the 3HRV and another device. The Baud rates available are; 1200, 2400, 4800, 9600, and 19.2k. The **UP** and **DOWN** arrow keys are used to set the Baud rate.

## Beeps

The 3HRV produces beeps to alert you of certain operating conditions.

The **UP** and **DOWN** arrow keys are used to turn Beeps on or off as desired.

## Diagnostics

**Note: If the Diagnostics selection does not appear on the screen, keep pressing the Down arrow soft key until it scrolls onto the list.**

Press the **ENTER** key to enter the diagnostic mode. The diagnostic mode allows the user to perform the following functions:

### Default to Factory Settings

When this item is selected and the **ENTER** key is pressed, the unit will automatically set all parameters to the factory default values.

**Warning: All files and references will be lost when resetting the unit to factory default settings.**

### Display Test

Allows the user to test the operation of the display. Press the **ENTER** key to begin the display test. Follow the instructions displayed while performing the test.

### Transmitter Diagnostics

Press the **ENTER** key to access the following Transmitter Diagnostic features:

- Transmitter On/Off - When turned on, provides a CW RF signal that can be used as a troubleshooting, or installation aid. The signal is only present when the diagnostic screen is displayed.
- Transmitter Attenuator - Use the **UP** and **DOWN** arrow keys to enter the amount of attenuation for the CW transmitted signal.
- Transmitter Frequency - Enter the frequency for the transmitted signal.

**Warning: Subscriber interference could result, if the frequency is set to a local carrier frequency.**

- Sweep Telemetry On/Off - When turned on, will modulate the CW signal similar to the telemetry signal.

## 4.3.2 Measurements Setup

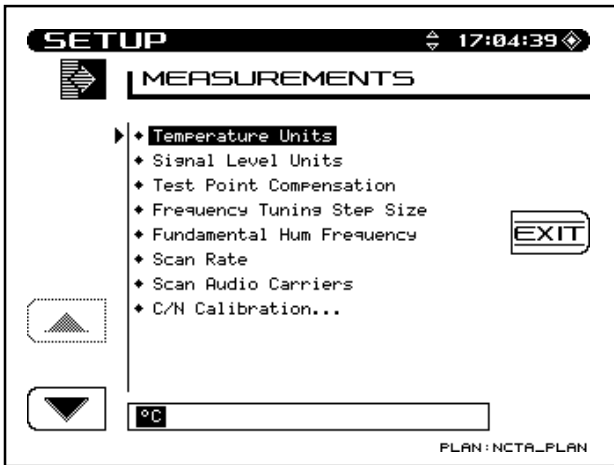

### Temperature Unit

Use the **UP** and **DOWN** arrow keys to select the desired temperature units (°C, °F).

### Signal Level Units

Use the **UP** and **DOWN** arrow keys to select the desired level units (dBmV, dBμV, dBm).

### Test Point Compensation

Test Point Compensation is used to account for losses associated with certain amplifiers. Use the **UP** and **DOWN** arrow keys or the numeric entry keys to enter the Test Point Compensation. (-100.0 to +100.0 dB in 0.1 dB steps).

## Frequency Tuning Step Size

The Tuning Step Size can be adjusted using the **UP** and **DOWN** arrow keys or the numeric entry keys (0.01 to 100.00 MHz in 10 kHz steps).

## Fundamental Hum Frequency

The fundamental hum frequency to be measured can be selected using the **UP** and **DOWN** arrow keys (60 Hz, 50 Hz, Auto). When Auto is selected the unit will automatically switch to 50 Hz on PAL type plans and 60 Hz for NTSC plans.

## Scan Rate

Two scan rates are available in the Scan mode, normal and fast. The scan rate is selected using the **UP** and **DOWN** arrow keys. The Fast scan feature allows for rapid scan displays, while sacrificing accuracy. Normal scan rate is slower, but more accurate.

## Scan Audio Carriers

If desired, the audio carriers can be omitted resulting in a faster scan. This feature is selected using the **UP** and **DOWN** arrow keys (yes, no).

## C/N Calibration

To increase the accuracy of the C/N measurements, a noise floor calibration is performed. This allows the user to characterize the noise floor of the unit. To perform the calibration, highlight the selection and press the **ENTER** key. The unit will provide a prompt to ensure that no cable is connected to the RF input. Once verified, press the **OK** soft key to perform the calibration. The unit will display the system noise level when the calibration is complete.

### 4.3.3 How To Setup Your Channel Plan

The procedure explained in Section 4.2.2 should be performed when first using the Model 3HRV.



### Select Channel Plan

Press the **ENTER** key to call up a list of existing channel plans. If the unit is being used for the first time, the only Channel Plan available will be the standard NCTA plan. Refer to the "Build Channel Plan" section to create a channel plan that matches your system. Use the **UP** and **DOWN** arrow keys to scroll through the list. When the desired channel plan is highlighted, press the **Exit** soft key to activate the selected channel plan. Channel plans can also be deleted from the list using the **Delete** soft key. An **OK** and **Stop** soft key is then displayed to confirm or stop the deletion of the channel plan.

The currently active channel plan (as indicated in the lower right hand corner of the screen) cannot be deleted. To delete this plan, first select a different plan by using the arrow keys to highlight another plan and then press the **Load** soft key. The previously active channel plan can now be deleted.

Press the **Info** soft key to view the following channel plan information:

- Plan name
- The Channel Plan that the plan was based on
- The number of enabled channels
- Date the plan was last modified

## Video Signal Type

The type of video signal to be measured can be selected using the **UP** and **DOWN** arrow keys (NTSC, PAL).

## Channel Tuning Sequence

Use the **UP** and **DOWN** arrow keys to select either numeric order or frequency order, for the channel tuning sequence.

## Build Channel Plan

Press the **ENTER** key to begin the Build Channel Plan sequence. This sequence allows the user to create a channel plan by "learning" the channels on a cable system.

**NOTE: Ensure that the 3HRV is connected to the cable system.**

Step 1: Enter a name for the new channel plan that will be built.

Use the alphanumeric keypad to enter a channel plan name. Press the **OK** soft key when completed.

Step 2: Select a fixed channel plan to use for building the new plan.

Use the **UP** and **DOWN** arrow keys to select a fixed channel plan to build the new plan from. Press the **OK** soft key when completed.

Step 3: Enter the frequency at which to stop searching for channels.  
Press the **ENTER** key followed by the **OK** soft key to set the stop frequency.

The 3HRV will sequence through all channels in the selected fixed plan until the stop frequency is reached. This operation can be terminated by pressing the **Stop** soft key. When completed, individual channels contained in the newly built plan can be edited.

**NOTE: Some channel plans have interlaced channels. To prevent interference, delete interlaced channels prior to building sweep points.**

## 4.3.4 How To Edit Channel Parameters

This setup feature allows the user to edit an existing channel plan. Press the **ENTER** key to initiate channel plan editing.

A list of all channels contained within the active plan is presented.

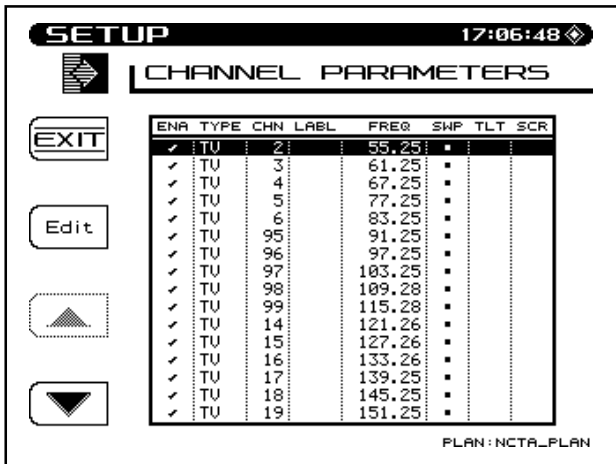

Use the **UP** or **DOWN** arrow keys to select the channel that you wish to edit.

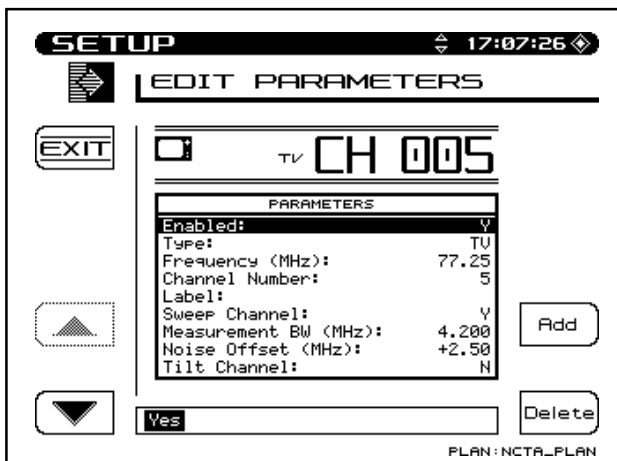

Press the **Edit** soft key to view and edit the following parameters:

**Note: If the parameter that you wish to edit does not appear on the screen, keep pressing the arrow soft key to scroll through the list.**

## **Enabled**

Y/N - If the channel is not enabled it will not be included in any measurement modes. At least one channel must be enabled. If a channel is not enabled, it will be converted to sweep points in the "Build Sweep Points" process.

## **Channel Type**

TV - Includes standard video carrier with audio carrier offset.

DUAL - European system which incorporates video plus two independent audio carriers.

Single Carrier - Can be used for an FM or data carrier.

Sweep Insertion Point - Used to insert sweep points into vacant spectrum areas.

Digital Carrier - Can be used for 16/64 QAM digital carrier power measurement. Only supported in the Level, Sweep, and Spectrum measurement modes. An RMS detection mode is used when measuring the level of a digital channel.

## **Frequency**

The frequency of the carrier (for TV and DUAL types, this is the frequency of the video carrier) Enter frequency by using the numeric entry keys or the arrow keys.

## Channel Number

The channel number of the carrier. Enter channel number by using the numeric entry keys or the arrow keys.

## Label

The label is provided to associate a channel's number with it's programming. Using the alpha keys, label the channel with a desired name (up to four characters). "Special" characters can be selected using the up/down arrow keys. The label will appear to the left of the channel number on most screens.

## Sweep Channel

Y/N - Designates that the channel will be used for Sweep measurements.

**NOTE: Adding sweep points at increments other than 250 kHz will slow the sweep speed by 15 msec per non-250 kHz increment.**

## Measurement Bandwidth Adjustments

To edit the bandwidth, cursor to the **Measurement BW** selection. The bandwidth can be adjusted by using the **UP** and **DOWN** arrow keys or by entering a value using the numeric keypad and then pressing the **ENTER** key. The FCC specification for C/N measurements is a bandwidth of 4.200 MHz. CATV organizations outside of the United States may have different requirements.

## Noise Offset Frequency Adjustments

The frequency at which the noise level is measured is the Carrier frequency plus the noise offset. To adjust the noise offset, cursor to the **Noise Offset** selection. The offset can be adjusted by using the **UP** and **DOWN** arrow keys or by entering a value using the numeric keypad and then pressing the **ENTER** key.

## **Tilt Channel**

Y/N - Designates which channels are used for the Tilt mode. Up to nine channels can be designated as Tilt channels.

## **Scrambled**

Y/N - Select Yes if the channel is scrambled. When a channel is designated as scrambled, the sweep will only look at the video carrier as a sweep reference, instead of both the video and audio carrier.

Note: a diamond will appear to the left of the channel type indicator on most screens.

## **Audio Offset**

Specifies the audio offset of the channel.

## **Audio Offset 2**

Specifies the offset for the second audio carrier of a Dual type channel.

An **ADD** and **DELETE** soft key allows for adding new channels to the plan or deleting existing channels from the plan.

Press the **Exit** soft key to return to the Edit Channel Parameters display.

## **Delete Unused Channels**

Once the channel plan has been built, unused channels can be deleted if desired. Doing this frees memory for other uses and "unclutters" the channel plan. Select the Delete Unused Channels in the Channel Plan menu and press **ENTER**.

## **Specify Auto Measurements**

Press the **ENTER** key to specify the measurements to be taken during the performance of an Auto Test. This feature allows the user to specify which channels, C/N, Hum, and Modulation measurements are made on.

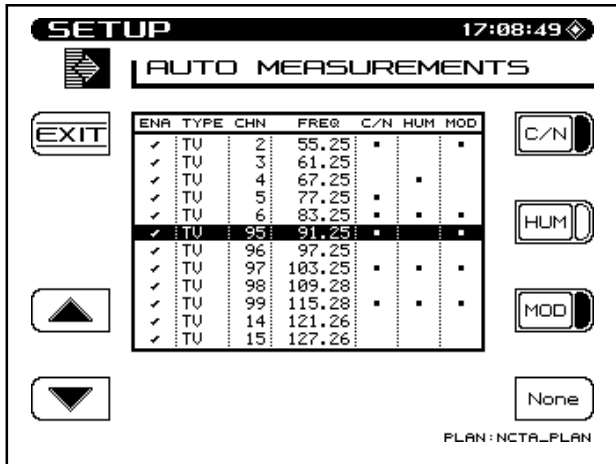

Use the **Up** and **Down** arrow soft keys to cursor to a channel. Use the **C/N**, **HUM**, and **MOD** soft keys to select the desired Auto Test measurements.

**Note: C/N, Hum, and Modulation cannot be measured on a scrambled channel or a sweep point. Hum and Modulation cannot be measured on a Digital type carrier.**

Use the **All/None** soft key to quickly select or deselect Auto Test measurements. If a test is selected, the **None** soft key is displayed. If no tests are selected for a particular channel, then the **All** soft key is displayed.

## Edit Limits

SETUP 12:3 17:09:36

EDIT LIMITS

EXIT

LIMITS	
Min Video Level (dBmV):	+0.0
Max Delta Vid Levels (dB):	10.0
Min Delta U/A (dB):	10.0
Max Delta U/A (dB):	17.0
Max Delta Adj Chans (dB):	3.0
24 Hr Vid Deviation (dB):	8.0

+0.0 dBmV Set for FCC

PLAN: NCTA\_PLAN

The Edit Limits function works in conjunction with the performance of an Auto Test. As the Auto Test measurements are made, the values are compared to the above limits. Use the **Up** and **Down** arrow soft keys to select the limit to be edited. Use the numeric entry keys or the **UP** and **DOWN** arrow keys to enter a value. Once the value has been entered, press the **ENTER** key to update the display.

## Copy Remote Plan

This selection allows you to copy a channel plan from one unit to another.

Connect a cable between the serial ports of two units. Ensure that the baud rate is set the same for each unit (General Setup screen). A baud rate of 19.2K is recommended for uploading plans.

Select **Copy Remote Plan** from the menu and press the **ENTER** key. A list of plans located in the remote units memory will appear. Select the plan that you want to copy and press the **Copy** soft key. The selected plan will be transferred from the remote unit and stored in the unit that you are operating. It will also become the active plan.

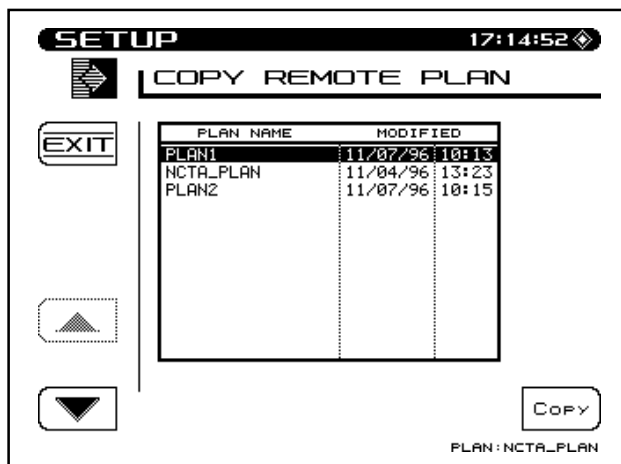

### 4.3.5 Reverse Sweep



## Forward Telemetry Frequency

Use the **UP** and **DOWN** arrow keys or the numeric keypad to enter the telemetry frequency.

**NOTE: For successful Stealth mode operation, the Rx Forward Telemetry frequency (3HRV) must match the Tx telemetry frequency setting of the Model 3SRV.**

**Caution: Do not place the telemetry signal too close to the duplex filter cut-off frequency in that roll-off may attenuate the telemetry signal to the degree that communication fails. This same caution applies to placing the signal in the high end roll-off region.**

## Forward Telemetry Level

This is the level of the carrier that the 3HRV uses to transmit telemetry data. Use the edit box to set the Telemetry Level to an appropriate value. When adjusting the Telemetry Level, take into consideration the following losses; system, summing network, test point, and amplifier desired input.

Use the **UP** and **DOWN** arrow keys or the numeric keypad to enter the telemetry level (20-50 dBmV).

## Reverse Telemetry Frequency

This is the frequency at which 3SRV units with the Reverse Sweep option will transmit telemetry data. Optimally this will be in a portion of the reverse frequency band with at least 1 MHz free, and at best case, in the high end of the return band to avoid potential interference from ingress.

**IMPORTANT:** The frequency the reverse telemetry carrier should be carefully selected such that it will not interfere with any existing carriers on the reverse plant.

## Reverse Sweep Plans

Reverse Sweep Plans are used to define the frequencies at which sweep points will be inserted by 3SRV units with the Reverse Sweep option. To access Reverse Sweep Plans, select the “Reverse Sweep Plans” option and then press the **ENTER** key.

### Selecting a Reverse Sweep Plan

The Reverse Sweep Plan screen presents a list of all Reverse Sweep Plans stored in memory. The current active Reverse Sweep Plan is displayed beneath the list of plans. Use the up or down arrow to select the plan you want, then press the Load soft key to load the selected plan into memory for use. Press the **Exit** soft key to return to the previous screen or the **SWEEP** key to begin sweeping.

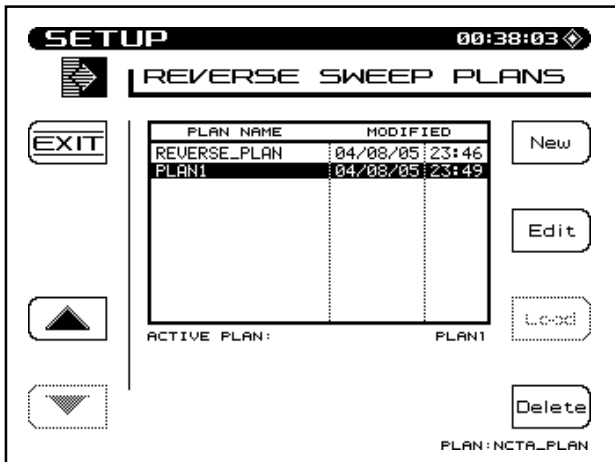

## Creating a New Reverse Sweep Plan

Press the **New** soft key to create a new Reverse Sweep Plan. You will be asked to enter a name for the plan that you are creating. Use the alphanumeric keys followed by the **ENTER** key. Then press the **OK** soft key to continue.

**NOTE:** A warning message will appear if a Reverse Sweep Plan currently exists with the same name as the plan you are creating.



Next, enter the Start Frequency. This will be the frequency of the first sweep point in the plan. Use the numeric keys followed by the **ENTER** key. Then press the **OK** soft key to continue.

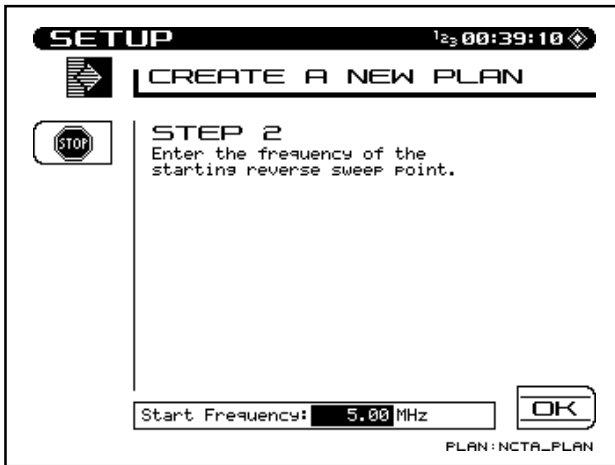

The Interval is entered next. This interval determines the spacing between sweep points. Use the numeric keys followed by the **ENTER** key. Then press the **OK** soft key to continue.



Finally, you are asked to enter the Stop Frequency. There will be no sweep points generated beyond the Stop Frequency. Use the numeric keys followed by the **ENTER** key. Then press the **OK** soft key to continue.

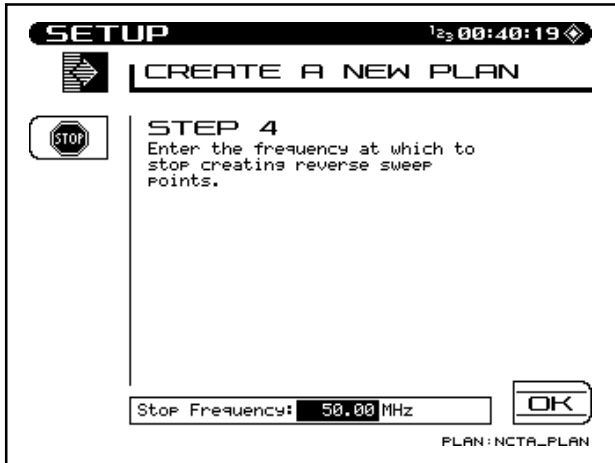

Sweep points are generated beginning at the Start Frequency and continuing until the Stop Frequency is reached. The frequency of each point is calculated by adding the Step Interval to the frequency of the previous point.



After it has been created, the new plan will appear in the Reverse Sweep Plan list.

### 4.3.6 Editing a Reverse Sweep Plan

If desired, the selected Reverse Sweep Plan can be viewed and modified.

**IMPORTANT:** You should verify that none of the sweep points contained within the Reverse Sweep Plan will interfere with existing carriers on the reverse plant.

Press the **Edit** soft key to display the following screen:

The screenshot displays the 'EDIT REVERSE PLAN' screen. At the top, it says 'SETUP' and '12:43:59'. Below that is 'EDIT REVERSE PLAN'. On the left, there is an 'EXIT' button and two arrow buttons (up and down). In the center is a table of sweep points:

PNT	FREQ
1	121.25
2	127.25
3	133.25
4	139.25
5	151.25
6	163.25
7	169.25
8	217.25
9	223.25
10	229.25
11	235.25
12	241.25

Below the table is an input field showing '121.25 MHz'. To the right of the input field are 'Add' and 'Delete' buttons. At the bottom, it says 'COMPENSATION: +23.4 dB' and 'PLAN: CUSTOM\_2'.

This screen shows a list of sweep points contained within the selected Reverse Sweep Plan. The list consists of the sweep point number followed by the frequency of the sweep point. Use the up and down arrows to scroll through the list.

Note that the frequency of the selected sweep point also appears in the edit box below the list. You can change the frequency by using the numeric keys followed by the **ENTER** key. The list will be updated when the **ENTER** key is pressed.

To remove a sweep point, use the up or down arrow to select the point to be removed, then press the **Delete** soft key.

Press the **Add** soft key to insert a new sweep point into the plan. The new point will be at the same frequency as the point that was selected when the Add soft key was pressed. You will need to set the new point to the desired frequency using the edit box.

When you are finished editing the Reverse Sweep Plan, press the **EXIT** soft key to return to the previous screen.

## 4.4 HOW TO PERFORM LEVEL MEASUREMENTS

Signal levels are measured in the Level and Scan Modes. The Level display provides both a numeric indication of signal level and an analog meter. The audio and video carrier levels of a channel are displayed simultaneously. Alternately, an individual carrier can be measured (as in the case for a data or pilot carrier) or the unit can be tuned to a specific frequency.

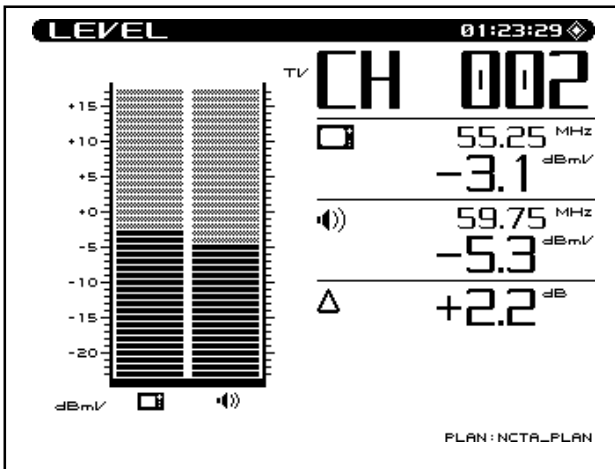

Information displayed in the Level mode is as follows:

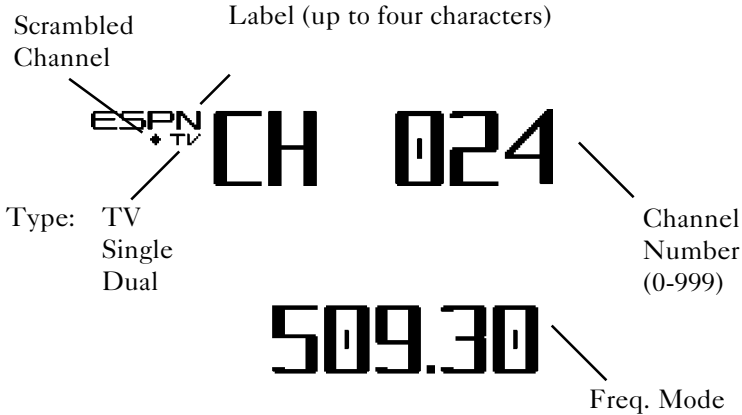

- Channel number or frequency
- Channel label
- Video carrier frequency and level (numerical)
- Audio carrier frequency and level (numerical)
- Analog meter of carrier levels
- Delta between audio and video levels
- Selected channel plan
- Test point compensation (appears only if a nonzero value is programmed during setup) - used to eliminate the test point loss or probe loss from the measurement result to show the signal level "on the system".

## Tuning by Channel or Frequency

When the level mode is selected the unit can be tuned by channel or frequency. When in the channel mode, the channel and channel label will appear at the top of the display. The left and right arrow keys can be used to decrement and increment the channels. Channels can also be entered using the numeric keys followed by the **CHAN** key.

To tune by frequency, use the numeric keys to enter a frequency followed by the **FREQ** key. The frequency can then be decremented by using the left key or incremented using the right arrow keys. The step size when tuning by frequency is programmed during setup.

## Scale Adjustment

The **UP** and **DOWN** arrow keys can be used to adjust the reference level on the analog meter. This is helpful when the audio and video levels differ by large amounts.

To automatically scale the analog meter, press the **FCN** key followed by the **Scale** second function key.

When in the TV channel mode, the level is represented using dual analog meters; one for the video carrier and one for the audio carrier (two in the video + dual audio channels mode).

When in the frequency mode or single channel mode, the level is indicated by a single meter.

## 4.5 HOW TO MEASURE TILT - BALANCING AN AMPLIFIER

A cable system is designed for unity gain, and the output of each like type of amplifier (trunk, bridger/line extender) should be as close to identical as physically possible. The amplifiers are set up with specified levels for signals at the high and low end of the spectrum that are used for Automatic Gain Control (AGC) or Automatic Slope Control (ASC). In the amplifier balancing process, these signals are measured and adjusted to specification. Before making an adjustment, ensure that there are no problems in the system that should not be compensated with an adjustment but repaired instead.

To balance the amplifier, ensure that the AGC and ASC is switched off. Tilt mode simplifies the actual balancing by displaying a bar graph with a representation of up to nine different user selected video carrier levels. Adjust the high pilot level to the specified level using the gain control. The gain control tends to affect the overall amplitude throughout the spectrum equally. Adjust the low pilot level to the specified level using the slope control. The slope control affects the low end of the spectrum more than the high end. Due to the interaction between the two controls, repeat this process until the pilots are "balanced". Then switch on the AGC and ASC, wait a moment to measure the signal levels with the AGC and ASC activated.

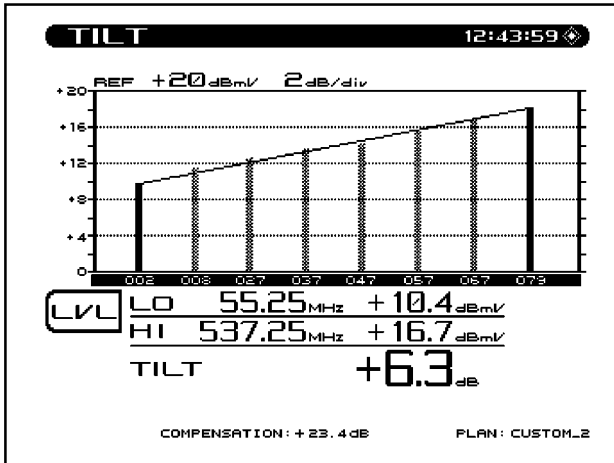

Information displayed in the Tilt mode is as follows:

- High and low carrier frequencies
- High and low carrier levels
- Tilt measurement
- Reference level and scale
- Selected channel plan
- Test point compensation (appears only if a nonzero value is programmed during setup)

When the **TILT** key is pressed the screen will automatically display up to nine video carrier levels that were defined in the Edit Channel Parameters portion of the Channel Plan Setup menu.

The **UP** and **DOWN** arrow keys can be used to adjust the reference level of the graph.

### Level Adjustments

Press the **LVL** soft key to edit the scale and reference level of the Tilt display. To adjust the Scale, use the **UP** and **DOWN** arrow keys to select a scale that will provide the best viewing of the Tilt levels.

To adjust the Ref Level, press the Ref Level soft key. Now the Ref Level can be changed by using the **UP** and **DOWN** arrow keys or by entering a numeric value followed by the **ENTER** key. The reference level is at the top of the graph.

**NOTE: The reference value is limited by unit and the scale setting.**

Pressing the **Auto Scale** soft key will automatically set the reference level for an optimum Tilt display. The **FCN + Scale** key can also be used to automatically set the reference level.

## 4.6 SCAN MODE

Use the Scan mode to get a good look at the whole spectrum of absolute carrier levels. In this mode a bar graph showing all carrier levels is displayed. A marker selects which carrier level is displayed on the bottom of the screen.

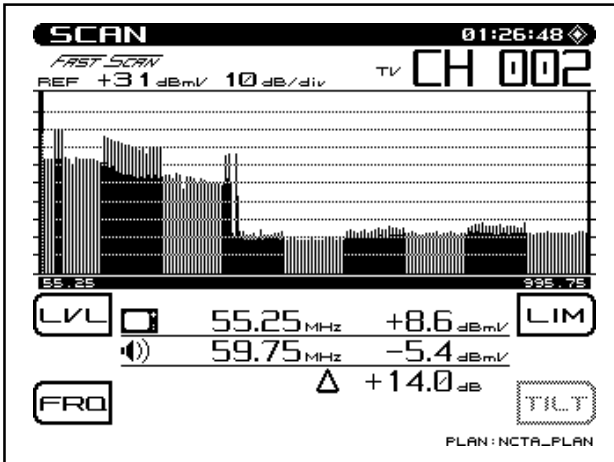

Information displayed in the Scan mode is as follows:

- Channel number
- Channel label
- Video carrier frequency and level (numerical)
- Audio carrier frequency and level (numerical)

- Histogram graph of carrier levels
- Delta between audio and video levels
- Selected channel plan
- Test point compensation (appears only if a nonzero value is programmed during setup)
- Limits annunciators

When the **SCAN** key is pressed a graph showing all carrier levels is displayed. Use the **RIGHT** and **LEFT** arrow keys to position the marker to the desired channel. The channel numbers can also be entered directly using the numeric entry keys.

The **UP** and **DOWN** arrow keys can be used to adjust the reference level of the graph.

## Level Adjustments

Press the **LVL** soft key to edit the scale and reference level of the Scan display. To adjust the Scale, use the **UP** and **DOWN** arrow keys to select a scale that will provide the best viewing of the carrier levels. To adjust the Ref Level, press the Ref Level soft key. Now the Ref Level can be changed by using the **UP** and **DOWN** arrow keys or by entering a numeric value followed by the **ENTER** key. The reference level is the top line of the graph.

**NOTE: The reference value is limited by unit and the scale setting.**

Pressing the **Auto Scale** soft key will automatically set the reference level for an optimum Scan display. The **FCN + Scale** key can also be used to automatically set the reference level.

## Frequency Adjustments

Press the **FRQ** soft key to edit frequency range parameters of the Scan display. Use the **UP** and **DOWN** arrow keys or the numeric entry keypad to set the start frequency. Press the **Stop** soft key to adjust the stop frequency. The **Full Span** soft key can be used to set the start and stop frequency to the full range of the unit.

Press the **TILT** soft key to turn tilt compensation on or off. Tilt channels must be programmed in the Channel Plan Edit mode, before this function can be implemented. The tilt is based on the levels of the highest and lowest channels configured for tilt.

When turned on, the compensation value can be adjusted using the **UP** and **DOWN** arrow keys or by entering a numeric value followed by the **ENTER** key. When tilt compensation is in effect, a "TILT ON" indicator appears in the upper left portion of the scan screen.

### **Tilt Compensation**

The tilt compensation feature allows the user to enter the cable loss for a particular section of line and then using the scan display adjust the gain of the amplifier to compensate for this loss.

### **Scan Rate**

Two scan rates are available in the Scan mode, normal and fast. The scan rate is selected in the Measurement Setup menu. The Fast scan feature allows for rapid scan displays, while sacrificing accuracy (as much as 2 dB on scrambled channels). Normal scan rate is slower, but much more accurate. An indicator appears in the upper left hand corner of the Scan screen when the Fast Scan mode is selected.

### **Audio Carriers**

If desired, the audio carriers can be omitted resulting in a faster scan. This feature is selected in the Measurement Setup menu. An indicator appears in the upper left hand corner of the Scan screen when audio carriers are omitted.

### **Limits**

The Limits feature allows for comparison of the current scan measurement with the "FCC" limits that are defined in Setup. There are two parts to this feature.

When an out of tolerance condition exists a set of annunciators will appear below the scan graph. The annunciators indicate the following out of tolerance conditions:

- Adjacent Channel Error
- Video Level Too High/Low
- $\Delta$ VA Too High/Low

The limit annunciators are updated with each scan update.

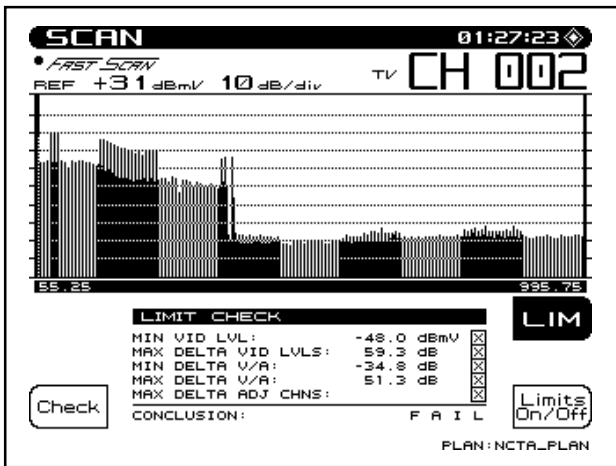

An "aggregate" result summary can be accessed by pressing the **LIM** soft key. This performs a limit check of all channels contained within the scan and reports an overall pass/fail conclusion. The aggregate limit check is not performed with each scan update, however, a **Check** soft key is provided to repeat the limit check whenever desired.

The **Limits On/Off** soft key toggles the limit check feature on & off. When turned off, the limit annunciators do not appear.

## 4.7 HOW TO MEASURE C/N

It is a good engineering practice to use a bandpass filter on the input of the receiver when making C/N measurements. This is to ensure accuracy and extend measurement range. If a preamplifier is used to boost test point levels prior to measurement, it should be placed between the bandpass filter and the receiver. This measurement is simply a comparison in amplitude between the video carrier reference signal and the noise (FCC limit: > 43 dB). The noise measurement must be made at least 2 to 2.5 MHz from any other carrier on the system.

In the C/N mode the carrier to noise ratio of the tuned channel or frequency is displayed. The C/N measurement bandwidth and the frequency offset for the noise measurement may be controlled from the screen. A proprietary DSP technique allows C/N measurements on modulated carriers (non-scrambled channels). The measurement is made by measuring the video carrier level and then tuning to the offset frequency. Once a line is found, the unit will then measure four consecutive frames and average the values together. The value is then corrected for the selected bandwidth, and the C/N ratio is computed. If the mode is selected before a carrier is available on the input, it will cause the readings to be wrong. If this occurs, change to another mode or channel and then return to the desired channel.

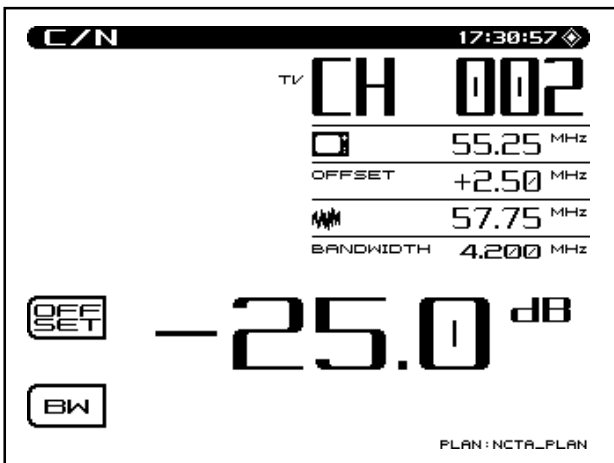

Information displayed in the C/N mode is as follows:

- Channel number
- Channel label
- Carrier frequency
- Noise offset frequency
- Noise frequency
- Bandwidth
- C/N ratio
- Channel plan

To make a carrier to noise measurement, press the **C/N** key. The C/N ratio of the tuned channel or frequency will be displayed.

## **Bandwidth Adjustments**

To edit the bandwidth, press the **BW** soft key. The bandwidth can be adjusted by using the **UP** and **DOWN** arrow keys or by entering a value using the numeric keypad and then pressing the **ENTER** key. The FCC specification for C/N measurements is a bandwidth of 4.200 MHz. CATV organizations outside of the United States may have different requirements.

## **Noise Offset Frequency Adjustments**

The frequency at which the noise level is measured is the Carrier frequency plus the noise offset. To adjust the noise offset, press the **OFFSET** soft key. The offset can be adjusted by using the **UP** and **DOWN** arrow keys or by entering a value using the numeric keypad and then pressing the **ENTER** key.

**Note: BW and Noise Offset values can be defined individually for each channel (see section 4.3.4 "How To Edit Channel Parameters"). When tuning by channel number, the BW and Noise Offset values can be adjusted using the Offset and BW soft keys. However, these adjustments will affect the C/N screen only and will not change the setup value in the channel plan.**

## 4.8 HOW TO MEASURE HUM

Hum is undesirable modulation of the television video carrier by power line frequencies and harmonics (e.g., 60 or 120 Hz), or other low frequency disturbances (FCC limit: < 3%). To measure Hum, simply press the **Hum** key when tuned to any non-scrambled channel. In the Hum mode the hum modulation of the tuned channel or frequency will be displayed in either % or dB as selected by the operator. Soft keys allow the operator to select 60, 120 (50, 100 Hz), or <1,000 Hz filters for this measurement to help in troubleshooting. A 60 Hz modulation component suggests a possible corroded connector, a 120 Hz component tends to indicate a possible failure related to the DC supply in the amplifier - possibly a capacitor going bad and aggravating the ripple. A proprietary DSP technique enables Hum measurements on modulated carriers (non-scrambled channels).

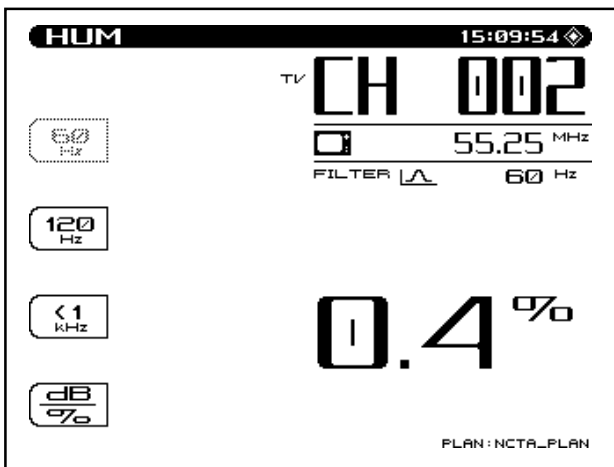

Stealth has been given the capability of measuring the 1Hz Hum component. To activate this feature, set the Fundamental Hum Frequency in the MEASUREMENTS setup screen to 1Hz. The filter options on the Hum screen will then become; 1Hz, <50Hz, and, <1kHz.

**Note: The <1kHz setting does not include the 1Hz component, it only includes 50 to 1000Hz. Information displayed in the Hum mode is as follows:**

**NOTE: HUM measurements taken while the desktop charger is in use will affect the HUM reading. For the most accurate reading disconnect the charger prior to taking HUM measurements.**

## 4.9 MODULATION

This function allows you to monitor the video depth of modulation in graphical and precise numerical format. A marker is placed at the optimal modulation level (NTSC 87.5%, PAL 90%) to assist technicians while making adjustments.

An **Audio** and **Depth** soft key is used to select the type of modulation to be displayed.

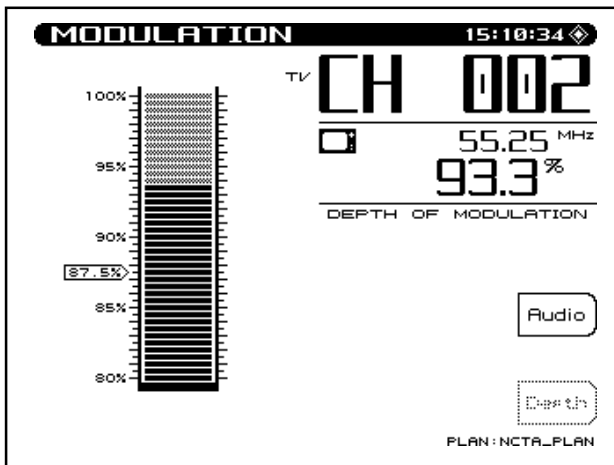

An additional feature is the ability to listen to the audio modulation of the tuned channel or frequency. Use the **Audio** soft key to listen to the audio modulation.

Use the **UP** and **DOWN** arrow soft keys to adjust the volume.

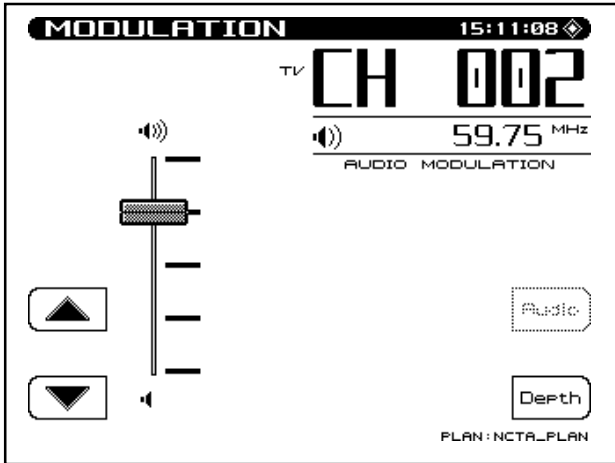

## 4.10 SPECTRUM ANALYZER MODE

The spectrum analyzer display provides a view of the system spectrum with variable spans from 50 MHz to 3 MHz and a dynamic range of better than 60 dB. When the **Spectrum** key is pressed, the following screen is displayed.

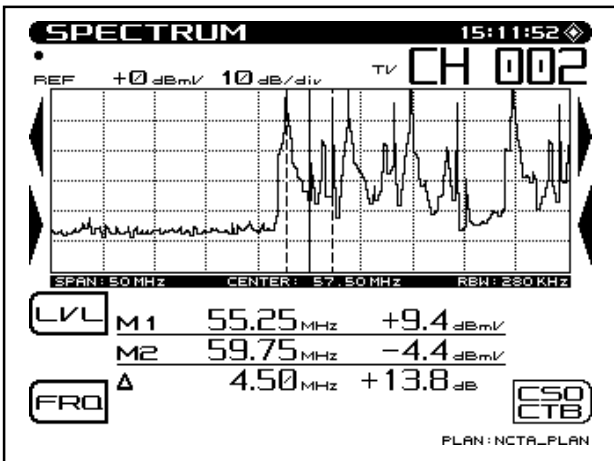

## Level Adjustments

A **LVL** (level) soft key is used to adjust the vertical parameters of the graph. These parameters include Max Hold, Ref Level and Scale.

The Max Hold function ensures that the highest signal over multiple sweeps is displayed. When the Max Hold soft key is pressed, as indicated in the left hand corner of the display, the highest signal level is displayed. The M1/M2 readings correspond to the max hold levels. As multiple sweeps are performed, the maximum level trace will only change if new sweep levels exceed the existing levels.

The reference level is located at the top line of the graph. The Ref Level can be adjusted using the cursor keys or by entering a numeric value followed by the enter key.

The scale parameter (1,2,5, & 10 dB/Div) can only be adjusted with the cursor keys. For example, if the reference level was set at 0 dB and the scale was set at 10 dB/div the first horizontal grid line above the center would be equal to -30 dB. Press the **LVL** soft key to return to the main spectrum analyzer display.

## Frequency Adjustments

Press the **FRQ** soft key to edit frequency range parameters of the Spectrum Analyzer display. Use the **UP** and **DOWN** arrow keys or the numeric entry keypad to set the center frequency. Press the **Span** soft key to adjust the span frequency. The **Full Span** soft key can be used to set the start and stop frequency to the full range of the unit. Press the **FRQ** soft key to return to the main spectrum analyzer display.

## How To Make FCC In-Channel Response Measurements

(FCC limit: ,  $\pm 2$  dB)

The frequency response of any channel can be measured using the spectrum analyzer mode. A flat signal source must be inserted at the input of the modulator or processor. In testing a modulator this source may be a full field multiburst signal, or a sweeping function generator. For a processor, a bench sweep generator or a broadband noise source may be used. The response is monitored with the Stealth receiver in the spectrum analyzer mode. A 5 or 10 MHz span may be used. The “Max Hold” function is used to ensure that the peak levels are measured at all frequencies. The scale may be set to as low as 0.5 dB/div, but the operator will use the appropriate scale setting to enable display of the full response on screen. The operator then positions the markers at the maximum and minimum points of the display and reads the “delta” indicated at the bottom of the screen. The FCC requirement is a window of  $\pm 2.0$  dB, which means the delta should be  $< 4$  dB.

## How To Make CSO/CTB Measurements

CSO (Composite Second Order) is a clustering of second order beats at any frequency in the spectrum, which causes interference to picture quality when they fall within the video bandwidth. CTB (Composite Triple Beat) is a clustering of third order distortion products usually around the video carrier frequency.

The ability to make these measurements allows the technician to troubleshoot and correct the cause of this unwanted distortion.

**NOTE: It is recommended that a  $\leq 12$  MHz band pass filter be used to limit the amount of intermodulation distortion caused by overload of the RF input of the receiver. If a preamplifier is used, it should be placed between the bandpass filter and the receiver.**

Press the **CSO/CTB** soft key to initiate CSO/CTB measurements. The unit will first switch to a 30 kHz resolution bandwidth, measure the carrier and then prompt you to turn the carrier off.

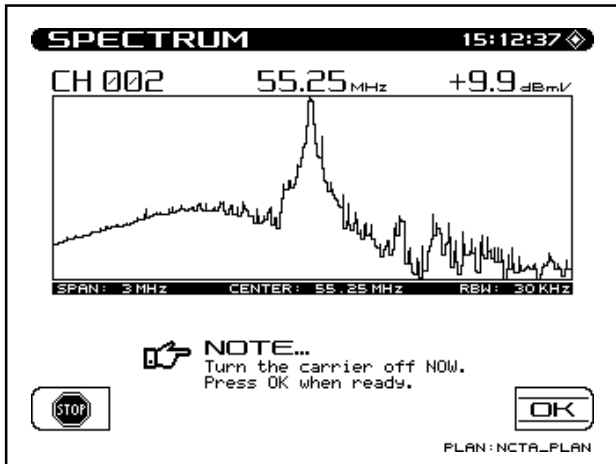

Press the **OK** soft key once the carrier has been turned off. The CSO/CTB measurement is now displayed.

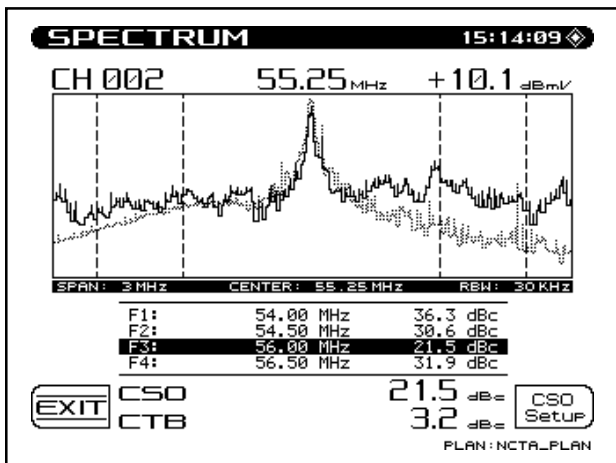

The light trace represents the carrier prior to it being turned off. The dark trace represents the distortion products. The measurement value is computed by a ratio of the peak level of the video carrier to the peak of the distortion products of the second and third order beats. The "worst case" CSO value is highlighted and is the overall CSO value. Press the **CSO Setup** soft key to adjust the offset values for the CSO measurement.

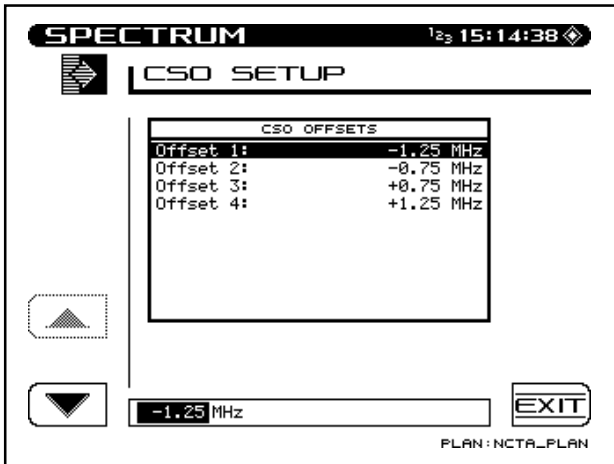

Using the **Up** and **Down** arrow soft keys, select the CSO Offset number to change. Use the numeric entry keys or the **UP** and **DOWN** arrow keys to enter a new CSO Offset value.

When exiting out of the CSO/CTB measurement, the unit will prompt you to turn the carrier back on.

## 4.11 SWEEP MODE

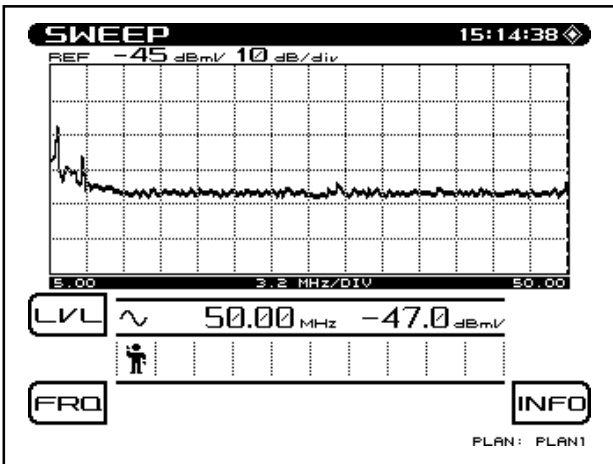

The Sweep mode displays and provides feedback to the field as to the current condition of noise and ingress in the headend. Even if the noise or ingress is "swamping" the telemetry a "picture" of the headend noise/ingress is sent out to the receiver via a special forward telemetry for display. The number of active users accessing return sweep information is indicated by the number of icons displayed below the level information. The 3HRV can handle up to 10 different technicians on the same cluster of nodes.

**NOTE: Sweep telemetry will cease when another mode is selected.**

3SRV operator information can be accessed by pressing the **INFO** soft key. The information screen displays the active user names, instrumental serial numbers and the reverse telemetry level reaching the 3HRV.

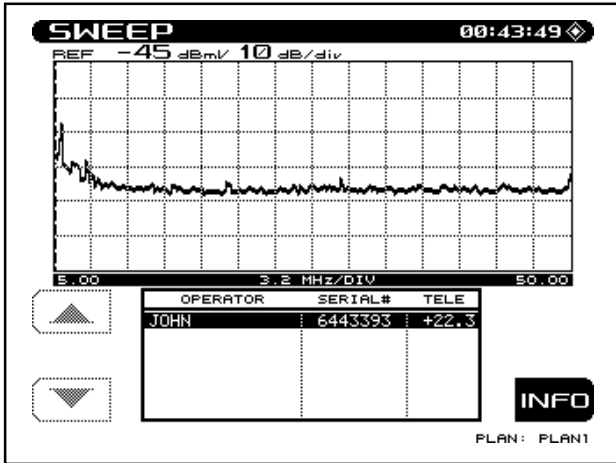

### Frequency Adjustments

The **FRQ** (frequency) soft key is used to set the start and stop frequency (for the display only). A start and stop soft key is displayed to select the parameter to be changed. The frequency is varied by using the cursor keys or a specific value can be entered using the numeric keys followed by the **ENTER** key.

A sub-function under the **Frequency** soft key is **Marker Zoom**. This will change the start and stop frequency to coincide with the marker value. The soft key will change to **Undo** to return to original start and stop values. Press the **FRQ** soft key to return to main sweep display.

### Level Adjustments

A **LVL** (level) soft key is used to adjust the vertical parameters of the graph. These parameters include Ref Level and Scale. The reference level is the midpoint level displayed on the graph. The Ref Level can be adjusted using the cursor keys or by entering a numeric value followed by the **ENTER** key.

The scale parameter (1,2,5, & 10 dB/Div) can only be adjusted with the cursor keys. For example, if the reference level was set at 2 dB and the scale was set at 5 dB/div the first horizontal grid line above the center would be equal to 7 dB. An **Auto Scale** soft key will automatically set the reference level for an optimum sweep display. The **FCN + Scale** key will also automatically scale the sweep display. Press the **LVL** soft key to return to main sweep display.

## 4.12 FILE

The File menu consists of two File submenus; Store File, and Measurement Files.

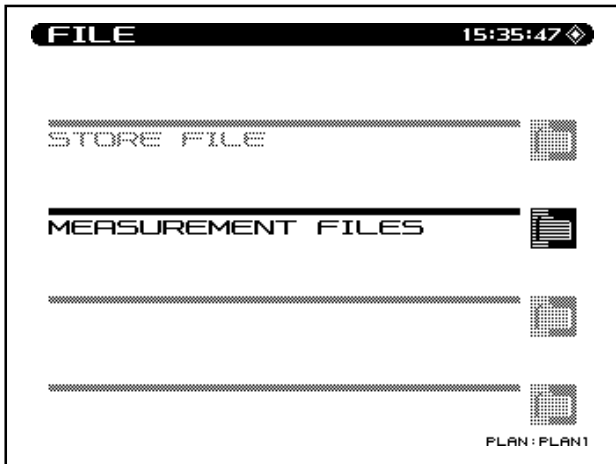

### 4.12.1 How to Store/View/Delete Measurement Files

The Store File feature allows the user to store sweep, spectrum and scan measurements. To store a measurement, press the **File** key while taking the measurement. Press the **Store Measurement** soft key to access the measurement files. To store the measurement, press the **Store** soft key. The unit will then prompt for a file name. Once a name is entered, press the **OK** soft key to execute the operation.

To view measurement files, press the **Measurement Files** soft key. A listing of all currently stored measurement files is displayed. Use the **UP** and **DOWN** arrow keys to select the file to be viewed. Once selected, press the **View** soft key. Scan measurements can be stored, but can only be viewed/printed using the Stealthware Data Analysis software. Once a file is selected it can be printed using the **Print** soft key. All measurement files, with the exception of scan files, can be printed using the **Print All** soft key. Use the **Delete** soft key to delete all unwanted files.

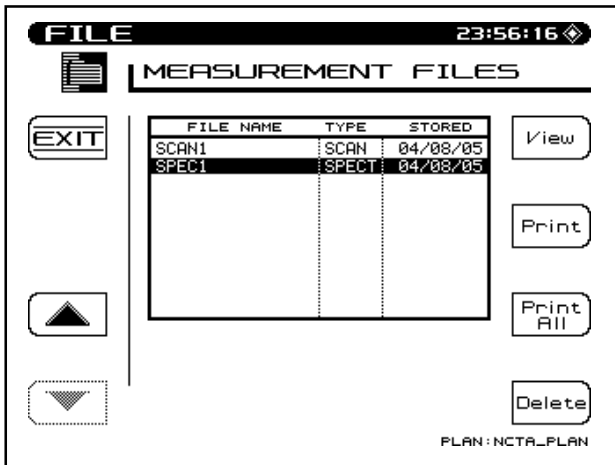

## 4.13 AUTO

The Auto menu consists of three File submenus; Test Locations, Perform Auto Test, and Auto Test Results.

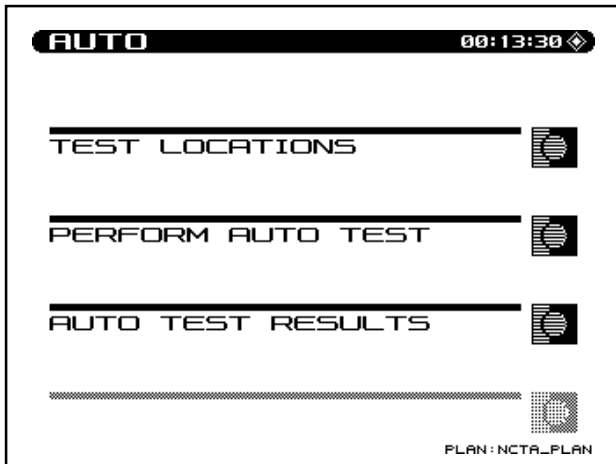

#### 4.13.1 How To Create/Edit/Delete Test Locations

Test Locations allow the user to create specific test point location parameters used in the Auto Test report. The Test Locations can be created directly on the Stealth unit, or using the SteathWare Data Analysis software and downloaded to the Stealth unit. The Test Location is used to identify where the data is collected. The user then simply selects the corresponding location, and the location data is automatically included in the Auto Test report.

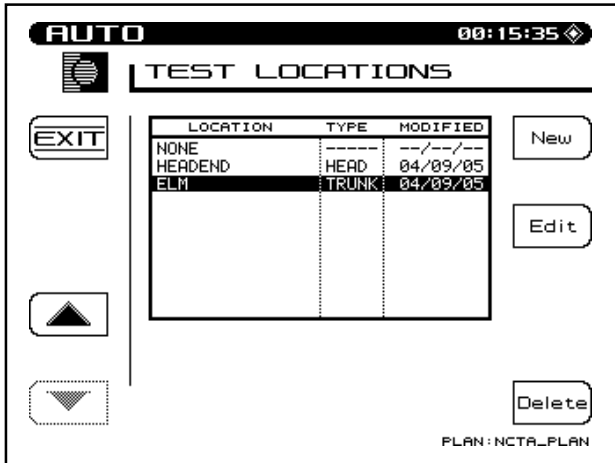

Press the **New** soft key to create a new Test Location file.

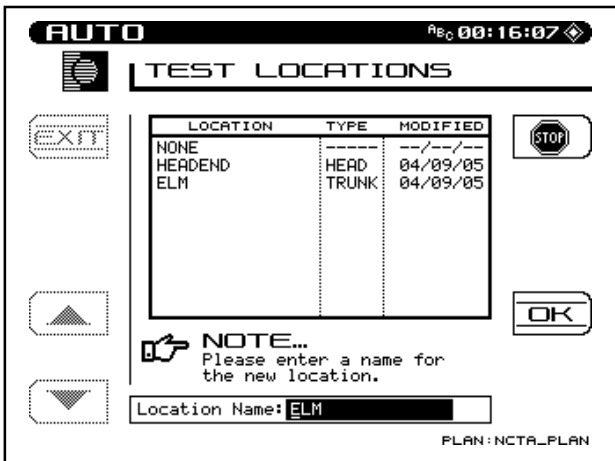

The unit will then prompt for a file name. Once a name is entered, press the **OK** soft key to execute the operation.

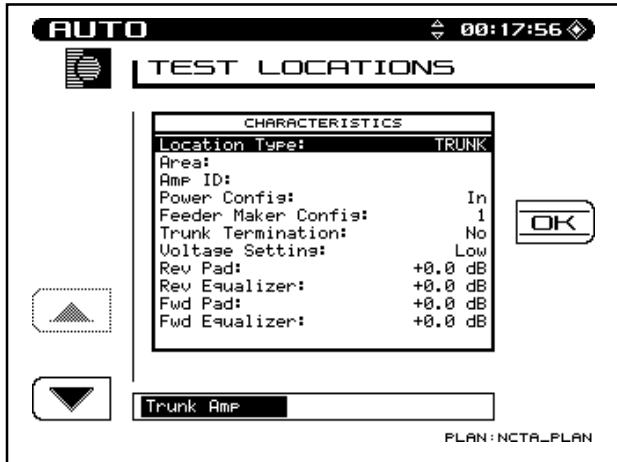

Each location in the list has an associated type and values for the descriptive parameters. The parameters are shown in the following table.

Parameter	Min	Max	Default	Units
1 Area				15 column alpha numeric field
2 Amp Id				15 column alpha numeric field
3 Power Configuration				IN / OUT / THROUGH
4 Feeder Maker Config	1	9	1	
5 Trunk Termination	NO	YES	NO	
6 Voltage Setting				LOW / MID / HIGH
7 Rev Pad	-100.0	+100.0	0.0	dB
8 Rev Equalizer	-100.0	+100.0	0.0	dB
9 Fwd Pad	-100.0	+100.0	0.0	dB
10 Fwd Equalizer	-100.0	+100.0	0.0	dB

There are five types of locations associated with a cable system: Trunk Amp, Headend, Line Extender, Fiber Node, and Field Test. Some of the parameters do not apply to certain types of locations. The following table shows which of the parameters in the table above apply to each of the location types.

<u>Characteristic</u>	<u>Trunk</u>	<u>Head</u>	<u>Extender</u>	<u>Fiber</u>	<u>Field</u>
1 Area	yes		yes	yes	yes
2 Amp Id	yes		yes	yes	
3 Power Configuration	yes		yes	yes	
4 Feeder Maker Config	yes		yes	yes	
5 Trunk Termination	yes		yes	yes	
6 Voltage Setting	yes		yes	yes	
7 Rev Pad	yes		yes	yes	
8 Rev Equalizer	yes		yes	yes	
9 Fwd Pad	yes		yes		
10 Fwd Equalizer	yes		yes		

Editing of location files is done by pressing the **Edit** soft key. The optional fields will be enabled or disabled according to the location type selected (see table above).

Use the **Up** and **Down** arrow soft keys to scroll to the desired parameter. Use the **UP** and **DOWN** arrow keys or the numeric entry keypad to enter the desired value. Once all the desired parameters have been edited, press the **OK** soft key.

The **Delete** soft key is used to delete a specific location file.

## 4.13.2 How To Perform An Auto Test

The Auto Test mode provides automated FCC 24 hour testing capabilities. Video & audio carrier levels will be measured for each enabled channel. Additionally, the following can be selectively measured for each channel: C/N, Hum, and Modulation. See Section 4.3.3 How To Setup Your Channel Plan for instructions on how to enable these individual measurements. Tests can be made immediately or at timed intervals, with the instrument sleeping between tests to conserve battery life. Upon test completion, the test results can be viewed on the LCD display before printing or downloading to StealthWare.

Press the **Perform Auto Test** soft key to enter the Auto test mode. The instrument provides a step-by-step procedure on how to perform an Auto Test.

## Auto Test Location

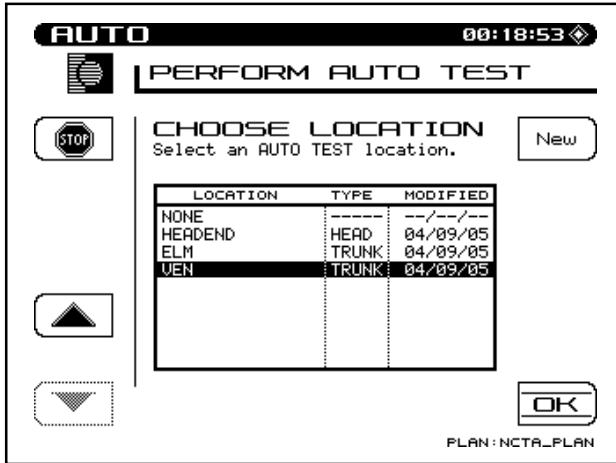

Using the **Up** and **Down** arrow keys, select an Auto Test location. Select **NONE** if location information is not desired. Press the **OK** soft key when completed. To create a new Auto Test location, press the **New** soft key.

## Auto Test Characteristics

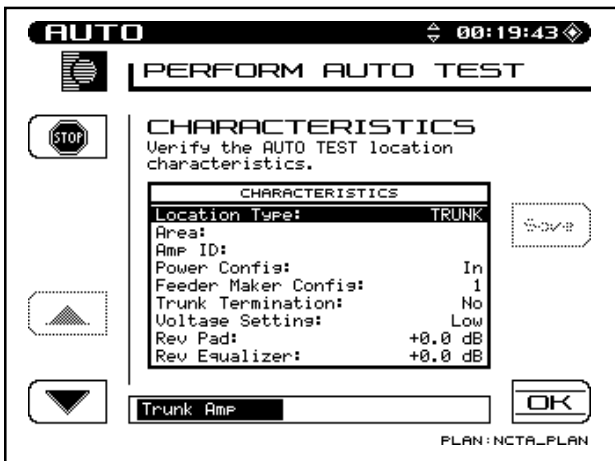

Use **Up** and **Down** arrow soft keys to scroll through the location characteristics for the test being performed. Press the **ENTER** key after each parameter is entered to update the display. If changes are made and you want them updated in the location file, press the **Save** soft key. If changes are made and the **Save** soft key is not pressed, the changes will only affect the Auto Test that is about to be performed. Press the **OK** soft key when completed.

## Test Point Type

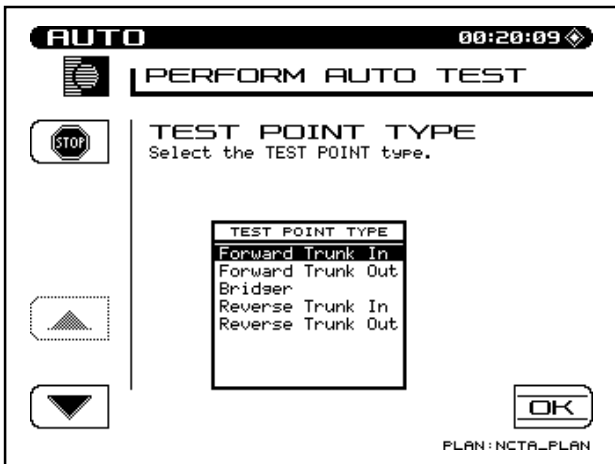

Use the **Up** and **Down** arrow keys to select the Test Point type. When the desired Test Point type is selected, press the **OK** soft key. The following is a list of Test Point types available:

Trunk Amp:      Forward Trunk In  
                     Forward Trunk Out  
                     Bridger  
                     Reverse Trunk In  
                     Reverse Trunk Out

Line Extended: Line Extended In  
                     Line Extended Out

## Voltage Measurements

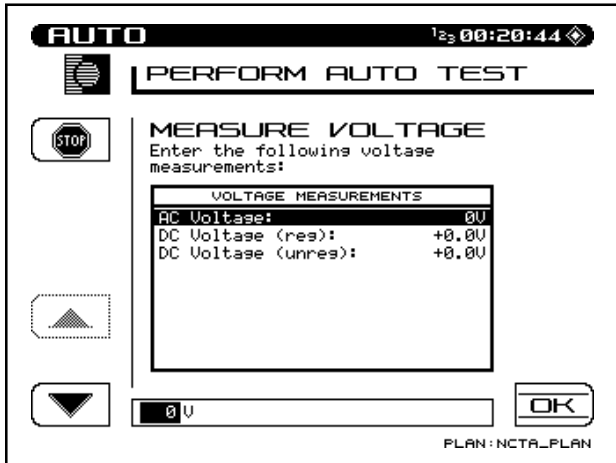

Use the numeric entry keys to enter the following system voltage measurements:

- AC Voltage
- DC Voltage (regulated)
- DC Voltage (unregulated)

The voltage measurements are printed in the Auto Test report. Press the **OK** soft key when completed.

## Test Point Compensation

**AUTO** 12:00:21:14

**PERFORM AUTO TEST**

**STOP**

**COMPENSATION**  
Enter the TEST POINT compensation value.

Compensation: +0.0 dB **OK**

PLAN: NCTA\_PLAN

Test Point Compensation is used to account for losses associated with certain amplifiers. Use the **UP** and **DOWN** arrow keys or the numeric entry keys to enter the Test Point Compensation. (-100.0 to +100.0 dB in 0.1 dB steps). Press the **OK** soft key when the desired value has been entered.

## Results File

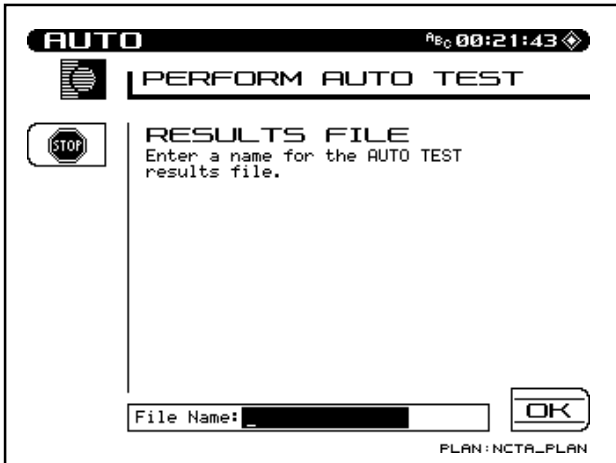

Enter a file name for the Auto Test results to be stored. If an existing file name is used, a warning message will appear prompting the user to overwrite the existing file or create a new one. When the desired file name has been entered, press the **OK** soft key to proceed with the Auto Test.

## Type Of Test

Press the **Immediate** soft key to commence the Auto Test. Press the **Scheduled** soft key to perform the Auto Test repeatedly at scheduled intervals.

## Immediate

If the Immediate mode is selected the unit will commence the Auto Test sequence. Prior to starting the test, the unit will prompt you to enter the ambient temperature. The temperature displayed is the temperature sensed by the unit. Use the numeric entry keys to enter the ambient temperature. Press the **OK** soft key when the desired temperature has been entered. While the Auto Test is in progress, the following screen is displayed:

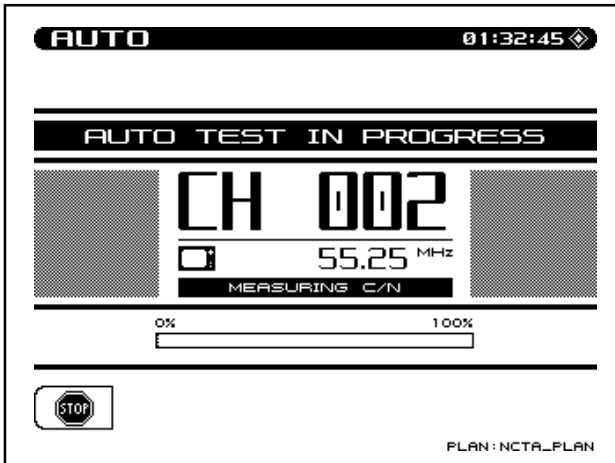

While the Auto Test is in progress, the measurement currently being performed (i.e. Level, C/N, Hum, or Modulation) is indicated on the screen. A bar graph showing the percentage of completion is displayed.

## Scheduled

If the Scheduled mode is selected, the start, stop, and interval information must be entered prior to commencing the Auto Test.

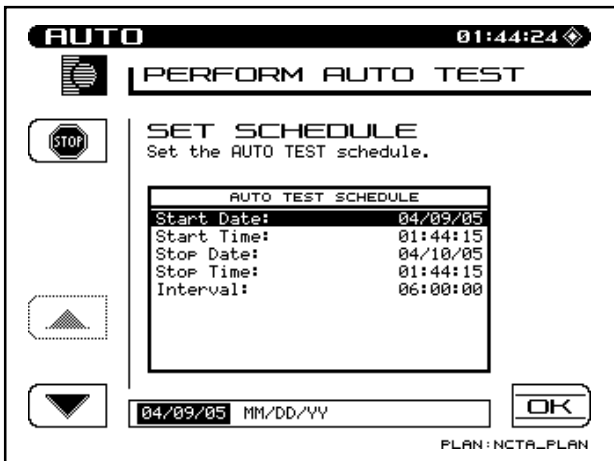

Using the numeric entry keys, enter the start and stop information for the date and time as well as the interval amount. Press the **ENTER** key after each parameter is entered to update the display. Use the **Up** and **Down** arrow soft keys to select the parameter to be entered. Press the **OK** soft key to commence the Schedule Auto Test. If the first interval is to commence immediately, the unit will prompt you to enter the ambient temperature. The temperature displayed is the temperature sensed by the unit. Use the numeric entry keys to enter the ambient temperature. Press the **OK** soft key when the desired temperature has been entered. If the first interval is to commence immediately, the "Auto Test In Progress" screen is displayed. When the unit is between testing intervals, the following screen is displayed:

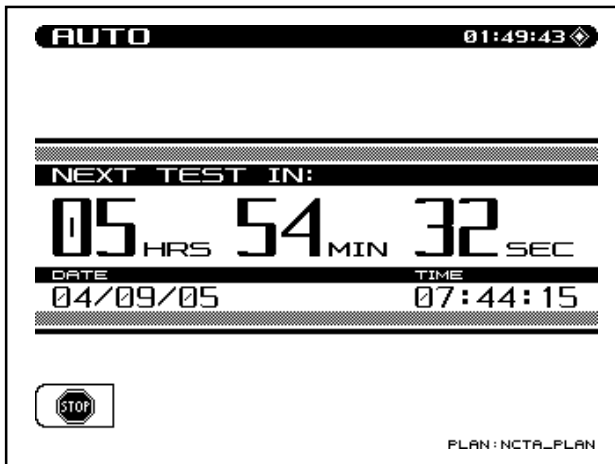

When the unit is between testing intervals it will enter a sleep mode in order to conserve battery life. All other unit functions are disabled during the performance of the Auto Test.

### 4.13.3 Viewing/Printing Auto Test Files

Upon completion of the Auto Test, the unit will enter the Auto Test Results Mode to display the Auto Test files. This allows the user to view or print the Auto Test results. Use the **Up** and **Down** arrow soft keys to select a file, then press the **View** soft key. A **Print All** soft key is available to print all intervals from all files in the directory to the printer. The **Info** soft key displays the Test Location Characteristics for the selected file.

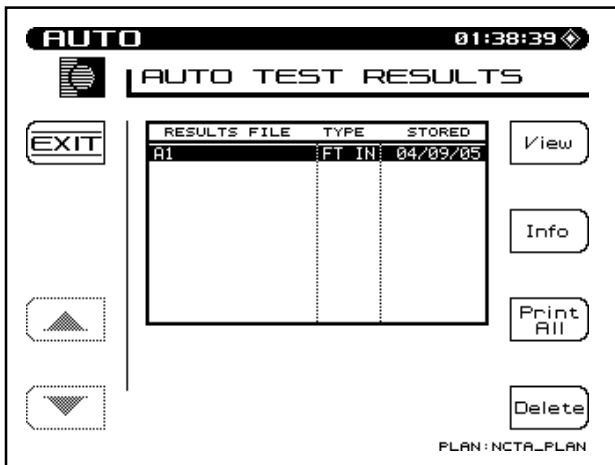

A table with all testing intervals and test site information is now displayed. If the Auto Test was performed immediately, then only one interval is displayed. If the Auto Test was performed using scheduled intervals, then all the interval numbers are displayed. The **Print All** soft key is used to send all intervals in the directory to the printer.

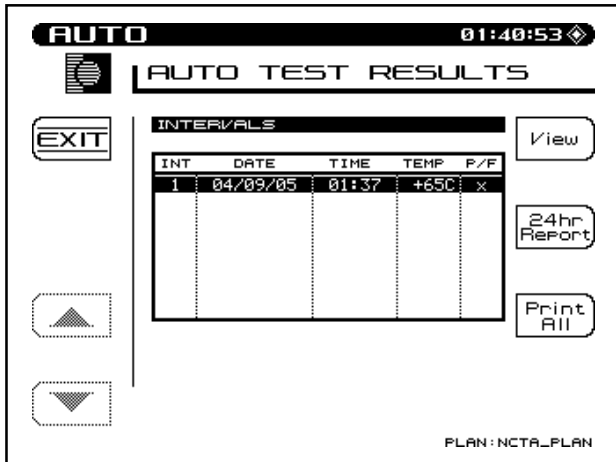

Information provided on each interval includes:

- Interval number
- Date measurement was made
- Time measurement was made
- Temperature
- Pass/Fail test results

An "X" in the Pass/Fail column indicates an overall failure of the measurements taken during that interval. A check mark indicates that all measurements were within the specified limits.

To comply with FCC 24 hour testing requirements, the 24hr Report soft key is provided. When the **24hr Report** soft key is pressed, the unit will automatically format and print the highlighted interval plus the next three intervals. The following is an example of a 24 Hour Test Report:

-----  
 WAVETEK STEALTH 24 HOUR TEST REPORT  
 Model: 3HRV                      Serial No: 1234567                      Cal Date: 06/21/95  
 -----

Operator: JOHN                      File: PROOF1  
 -----

Location Name:                      1028\_ELM\_ST  
 Location Type:                      Trunk  
 Test Point Type:                      Forward Trunk In  
 Test Point Compensation:                      +0.0 dB  
 -----

Area:                      00A7  
 Amp ID:                      12-275Z  
 Power Config:                      In  
 Feeder Maker Config:                      1  
 Trunk Termination:                      No  
 Voltage Setting:                      Low  
 Reverse Pad: +0.0 dB                      Reverse Equalizer: +0.0 dB  
 Forward Pad: +0.0 dB                      Forward Equalizer: +0.0 dB  
 -----

AC Voltage: 110 V                      DC Voltage (reg): 14.8 V                      (unreg): 20.9 V  
 -----

	#1	#2	#3	#4	
Date:	07/04/95	07/04/95	07/05/95	07/05/95	
Time:	17:00:00	23:00:00	05:00:00	11:00:00	
Temp:	+75 F	+61 F	+59 F	+83 F	
	Video	Video	Video	Video	24 Hr
Chan	Level	Level	Level	Level	Deviation
	(dBmV)	(dBmV)	(dBmV)	(dBmV)	(dB)
2 *	+9.6	+8.8	-17.7 LO	+10.7	28.4 HI
3 *	+9.9	+8.6	-5.8 LO	+8.9	15.7 HI
4	+9.2	+8.3	-2.9 LO	+10.1	13.0 HI
5	+9.3	+8.2	+9.3	+11.5	3.3
6	+8.1	+9.1	+8.6	+11.0	2.9
14	+9.7	+8.7	+9.0	+11.0	2.3
15	+9.3	+7.6	+9.6	+10.6	3.0
16	+10.2	+8.0	+10.7	+10.5	2.7
17	+9.6	+7.4	+9.4	+10.8	3.4
18	+9.2	+8.0	+10.0	+10.2	2.2

LIMIT CHECK	Limit	1	2	3	4	
Min Video Carrier Level:	+0.0 dBmV			X		Fail
Max Delta Video Levels:	10.0 dB	X				Fail
Min Delta V/A:	6.5 dB			X	X	Fail
Max Delta V/A:	17.0 dB	X		X	X	Fail
Max Delta Adjacent Channels:	3.0 dB	X	X	X	X	Fail

24 Hour Video Deviation:                      8.0 dB                      Fail

Conclusion:                      F A I L  
 -----

Reviewed: \_\_\_\_\_ Date: \_\_\_\_\_

The channels with the asterisks indicate those channels that exceeded the Max Delta Adjacent Channels limit. The limits that the readings were compared to, are printed at the bottom of the report. To the right of the limits, the report displays each interval that failed the specific limit. If a particular measurement was not within the specified limit, a HI/LO marker is printed next to the reading indicating the direction that the measurement was out of specification.

Each interval can be selected and viewed as desired. Use the **Up** and **Down** arrow soft keys followed by the **View** soft key to view specific interval test results.

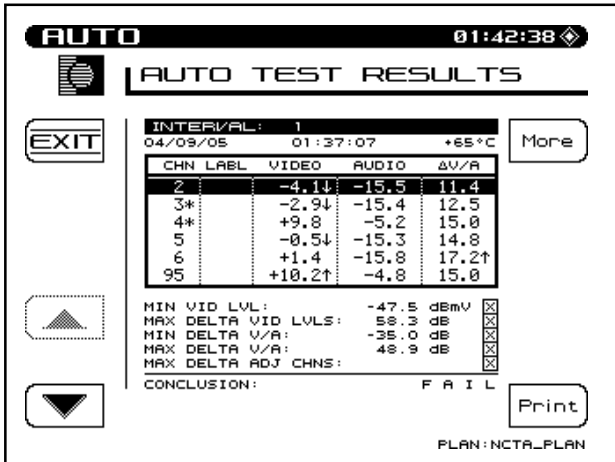

The test results along with the limits comparison is displayed. The asterisks and up/down arrows have the same meaning as on the single interval report printout. The limit that was exceeded along with the measurement reading is displayed on the lower portion of the screen. When viewing the list of Level measurements, the following symbols will appear to the right of the measurement if an error occurred:

- < under range
- > over range
- E synthesizer unlocked

Use the **More** soft key to toggle between Level measurements, C/N, Hum, and Modulation measurements.

**AUTO** 01:43:09

**AUTO TEST RESULTS**

INTERVAL: 1  
04/09/05 01:37:07 +65°C More

CHN	LABEL	C/N (dB)	HUM (%)	MOD (%)
2		ERROR	ERROR	ERROR
3		ERROR	ERROR	77.9
4		+46.7	0.3	ERROR
5		ERROR	ERROR	92.0
6		ERROR	0.8	89.3
95		+46.2	1.1	88.3
96		+46.1	0.8	75.1
97		ERROR	ERROR	ERROR

Print

PLAN: NCTA\_PLAN

When viewing the list of C/N, Hum, and Modulation measurements, the following symbols will replace the measurement value if an error occurred:

- UNDER - under range
- OVER over range
- ERROR - synthesizer unlocked

The **Print** soft key can be used to print out the following report:

```

-----
WAVETEK STEALTH AUTO TEST REPORT
Model: 3HRV                Serial No: 1234567                Cal Date: 06/21/95
-----
Operator: JOHN             File: PROOF1             Inverval: 1
Date: 07/20/95            Time: 15:18:09          Temp: 75 F
-----
Location Name:             1028_ELM_ST
Location Type:             Trunk
Test Point Type:          Forward Trunk In
Test Point Compensation:   +0.0 dB
-----
Area:                      00A7
Amp ID:                    12-275Z
Power Config:              In
Feeder Maker Config:      1
Trunk Termination:        No
Voltage Setting:           Low
Reverse Pad: +0.0 dB       Reverse Equalizer: +0.0 dB
Forward Pad: +0.0 dB       Forward Equalizer: +0.0 dB
-----
AC Voltage: 110 V          DC Voltage (reg): 14.8 V  (unreg): 20.9 V
-----
Chan  Label  Video      Audio      Delta V/A      C/N      Hum      Mod
      (dBmV)  (dBmV)      (dB)
2 *   QVC   -17.7 LO   -18.4      0.7 LO         43.9     1.4     86.3
3 *   TNN   -5.8 LO   -13.9      8.1            ---      ---     ---
4 *   USA   -2.9 LO   -15.6      12.7           ---      0.9     ---
5 *   ESPN  +0.1      -16.1      16.2           48.2     ---     ---
6 *   MTV   +7.9      -20.3      28.2 HI        ---      ---     88.2
7 *   FMLY  +9.9      -10.6      20.5 HI        ---      ---     ---
8 *   CMDY  +6.9      -11.5      18.4 HI        ---      12.7    ---
9 *   LIFE  +9.1      -11.1      20.2 HI        ---      ---     ---
10 *  VH1   +8.5      -13.3      21.8 HI        57.9     ---     ---
11 *  CNN   +4.1      -12.0      16.1           ---      ---     ---
12 *  A&E   +4.3      -3.4       7.7            ---      ---     87.5
13 *  CINE  +7.1      -4.2       11.3           ---      2.1     ---
14 *  SHOW  +6.3      -7.5       3.8            ---      ---     ---
15 *  NICK  +10.2 HI  -8.2       18.4 HI        55.1     ---     86.9
-----
LIMIT CHECK                Limit                Actual
Min Video Carrier Level:   +0.0 dBmV           CH 2    -17.7 dBmV   Fail
Max Delta Video Levels:    10.0 dB             CH 2 & 15 27.9 dB   Fail
Min Delta V/A:             6.5 dB              CH 2     0.7 dB      Fail
Max Delta V/A:             17.0 dB             CH 6    28.2 dB      Fail
Max Delta Adjacent Channels: 3.0 dB              Fail
-----
Conclusion:                                                         F A I L
-----

```

Reviewed: \_\_\_\_\_ Date: \_\_\_\_\_

This report is similar to the 24 hour report with only one interval being reported. The 24 hour video deviation information is not present.

## 4.14 STATUS

To view the Status screen, press the **FCN** key followed by the **Status** second function key. The Status screen provides unit information to the user. An important feature is the amount of memory currently being used. This allows the user to decide if unwanted files should be deleted to make more memory available for newer files.

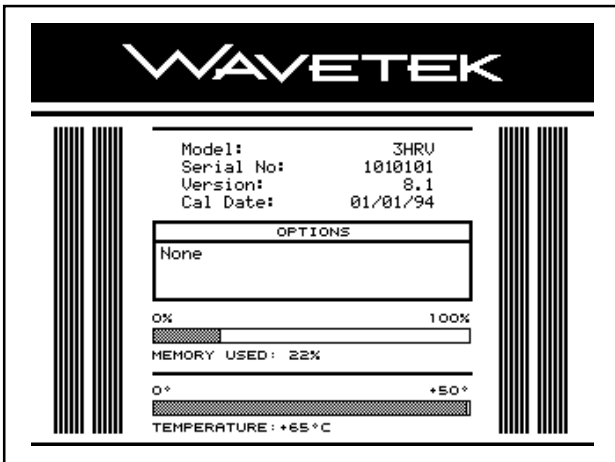

## APPENDIX A STATUS INDICATORS/ICONS

### INTRODUCTION

There are numerous status indicators/icons displayed on the Stealth 3HRV. The following is a list of all status indicators/icons and an explanation of each. The status indicators are displayed in the title bar as shown in the example below.





 = unlocked

 = low battery

**FCN** = function key pressed

 = alpha entry mode

 = numeric entry mode

 = arrow key selection mode

 = backlight on (manual operation)

 = backlight on (auto operation)



- Video Carrier



- Audio Carrier



- Single Carrier



- DUAL Carrier



- Band Pass Filter (Hum screen)



- Low Pass Filter (Hum screen)



- Noise (C/N screen)



<b>Message</b>	<b>ERROR... Insufficient signal level to perform the measurement!</b>
Condition	A minimum carrier level is required for C/N and HUM measurements.
Response	Choose another channel or frequency with greater than the minimum level.
<b>Message</b>	<b>SORRY... This is an illegal name and cannot be used.</b>
Condition	An illegal name has been entered.
Response	Choose another name.
<b>Message</b>	<b>WARNING...A reference with this name already exists. Overwrite?</b>
Condition	A reference with the same name currently exists.
Response	Overwrite the existing reference or choose another name.
<b>Message</b>	<b>SORRY... This is an invalid name. Please try again.</b>
Condition	An invalid name has been entered.
Response	The name must contain at least one character.
<b>Message</b>	<b>SORRY... There is not enough memory to store a new reference!</b>
Condition	Memory is currently at maximum capacity.
Response	Delete unwanted files to make more memory available.
<b>Message</b>	<b>WARNING... The selected reference will be deleted!</b>
Condition	A reference file is about to be deleted.
Response	Press OK to delete.

<b>Message</b>	<p><b>ERROR... The selected reference has been corrupted!</b></p> <p>Condition      The reference cannot be used because of a non-volatile memory failure.</p> <p>Response      Delete the corrupted reference and select another.</p>
<b>Message store time in</b>	<p><b>SORRY... Not enough sweeps have occurred to an accurate reference. Please allow more SWEEP.</b></p> <p>Condition      An attempt to store a reference without sufficient sweeps.</p> <p>Response      Allow more time in Sweep Mode.</p>
<b>Message</b>	<p><b>ERROR... A system error has occurred!</b></p> <p>Condition      A system error has been detected.</p> <p>Response      Restart the unit and try again.</p>
<b>Message</b>	<p><b>ERROR... There is no response from the printer!</b></p> <p>Condition      The printer is not responding to the unit.</p> <p>Response      Check printer connection and compatibility.</p>
<b>Message</b>	<p><b>SORRY... There is nothing to print! Please select a measurement mode before attempting to print.</b></p> <p>Condition      An attempt to print was made without being in a measurement mode.</p> <p>Response      Choose a measurement mode.</p>
<b>Message</b>	<p><b>WARNING... A sweep file with this name already exists. Overwrite?</b></p> <p>Condition      A sweep file with the same name currently exists.</p> <p>Response      Overwrite or choose another name.</p>

<b>Message</b>	<b>SORRY... There is not enough memory to store a new file!</b>
Condition	Memory is currently at maximum capacity.
Response	Delete unwanted files to make more memory available.
<b>Message deleted!</b>	<b>WARNING... The selected sweep file will be</b>
Condition	A sweep file is about to be deleted.
Response	Press OK to delete.
<b>Message</b>	<b>ERROR... The selected sweep file has been corrupted!</b>
Condition	The file cannot be used because of a non-volatile memory failure.
Response	Delete the corrupted file and select another sweep file.
<b>Message select</b>	<b>ERROR... A system error has occurred! Please another mode.</b>
Condition	A system error has been detected.
Response	Select another measurement mode or restart the unit and try again.
<b>Message</b>	<b>ERROR... At least two tilt channels must be programmed and enabled! Please select another mode.</b>
Condition	Tilt mode is selected with less than two tilt channels programmed.
Response	Edit channel plan to program at least two tilt channels.
<b>Message</b>	<b>WARNING... The selected plan will be deleted.</b>
Condition	A channel plan is about to be deleted.
Response	Press OK to delete, STOP to

cancel.

**Message**

**SORRY... The active plan cannot be deleted!**

Condition An attempt to delete the active channel plan.

Response Select a different plan as the active plan, then delete the desired plan.

**Message**

**ERROR... This plan is corrupted and cannot be used!**

of failure.

Condition The plan cannot be used because a non-volatile memory

Response Delete the plan and then choose another.

**Message**

**WARNING... A plan with this name already exists. Overwrite?**

Condition A channel plan with the same name currently exists.

Response Overwrite or choose another name.

**Message**

**SORRY...This is the name of a fixed plan and cannot be used.**

Condition An attempt was made to name a channel plan with the name of a fixed plan.

Response Choose another name.

**Message**

**ERROR... The stop frequency has been set too low.**

Condition The stop frequency has been set below the lowest channel in the selected fixed plan.

Response Enter a higher stop frequency.

**Message**

**SORRY... This cannot be completed due to a system error.**

Condition A system error was detected.

Response Restart the unit and try again.

**Message**

**WARNING... This channel will be deleted!**

Condition A channel is about to be deleted.

	Response	Press OK to delete, STOP to cancel.
<b>Message</b>	<b>SORRY... The last channel cannot be deleted!</b>	
	Condition	An attempt was made to delete the last channel of a plan.
least delete the	Response	A channel plan must contain at one channel. If desired, entire plan.
<b>Message</b>	<b>WARNING... This operation cannot be undone!</b>	
	Condition	An operation has been selected that will make permanent changes to a stored file.
	Response	Press OK to execute, STOP to cancel.
<b>Message</b>	<b>SORRY... There is not enough memory to store the new plan!</b>	
	Condition	Memory is currently at maximum capacity.
	Response	Delete unwanted files to make more memory available.
<b>Message</b>	<b>WARNING... There is not enough memory to save the changes!</b>	
	Condition	Memory is currently at maximum capacity.
	Response	Delete unwanted files to make more memory available.
<b>Message</b>	<b>SORRY... Some channels may not have been converted due to a system error.</b>	
	Condition	A system error was detected.
	Response	Restart the unit and try again.
<b>Message</b>	<b>WARNING... All files and stored settings will be lost!</b>	
	Condition	The unit is being reset to the factory default settings.

Response Press OK to reset settings, STOP to cancel.

**Message ERROR... C/N cannot be measured on a scrambled channel!**

Condition A channel that has been programmed as scrambled in setup has been selected in C/N mode.

Response Select a channel that is not scrambled. C/N measurements are not possible on a scrambled channel.

**Message ERROR... Hum cannot be measured on a scrambled channel!**

Condition A channel that has been programmed as scrambled in setup has been selected in Hum mode.

Response Select a channel that is not scrambled. Hum measurements are not possible on a scrambled channel.

**Message SORRY... No more tilt channels can be programmed.**

Condition The maximum number of tilt channels has been reached.

Response To program another tilt channel, an existing tilt channel must be reprogrammed as a non-tilt chan-

nel.