

Communication Monitor
STABILOCK® 4015

Operating Instructions

Manual Version: 9211-132-A

Schlumberger Technologies GmbH, Gutenbergstr. 2 – 4, D-8045 Ismaning

List of Contents

Chapter 1: Startup

For the Reader in a Hurry	1-1
First-time startup	1-1
Declarations	1-2
Working with masks	1-3
Working with menus	1-5
Examples for practice	1-8
Introduction	1-9
Standard Equipment	1-10
Safety Notes	1-11
Before startup	1-11
During tests	1-11
During maintenance and repair	1-11
Shutdown when defective	1-12
Notes on health and environmental protection	1-12
Permissible RF Input Power	1-13
TX SENS socket	1-13
RX/TX socket	1-13
Line Power	1-15
Permissible line AC voltage	1-15
Power connection	1-15
Power fuse	1-15
Battery Power	1-16
Powering from internal battery (option)	1-16
Powering from external battery	1-16
Fuse protection of internal/external battery	1-16
Powering on	1-17
Line powering	1-17
Battery powering or parallel line/battery powering	1-17
Data Retention	1-18
Data retention when powering off	1-18
Data retention upon power disconnection	1-18
Data retention upon change of mask	1-18
Total reset	1-18
Calibration	1-19
Why calibrate?	1-19
What happens in calibration?	1-19
Temperature-regulated calibration	1-20
Specific calibration	1-21
Forced calibration	1-22
Error message during calibration	1-22

Chapter 2: Operating Rules

Operating Concept	2-1
Mask Callup	2-2
Callup of basic masks	2-2
Mask callup with softkeys	2-2
Meaning of LEDs	2-4
Colors of LEDs	2-4
Filling in Entry Fields	2-5
Locating entry field	2-5
Entering new numeric value	2-6
Operating procedure	2-6
Rejection of impermissible entries	2-7
Correcting entries	2-7
Continuously altering entries	2-8
Operating procedure	2-8
Spinwheel function in menu windows	2-8
Selecting units of numeric value	2-9
What entry fields offer a choice of units?	2-9
How are units selected?	2-9
What units are there?	2-10
Working with a "units calculator"	2-11
Calling up Test Instruments	2-12
24 instruments in one case	2-12
The Way to Results	2-13
Settings in menus	2-13
Coupling signals	2-13
Typical test setups	2-13
Reading results	2-14
HELP Function	2-15
Built-in manual	2-15
Requesting information	2-16
HELP after incorrect entry	2-16
HELP before filling in entry field	2-16
ZOOM Function	2-17
Selecting instrument	2-17
Setting pointer damping	2-18
Selecting measurement range	2-19
Automatic range switching	2-19
Defining measurement range	2-20
Superimposing tolerance zone	2-21
Adopting entry fields from basic mask	2-21
Special functions	2-22
VOLT softkey	2-22
PEAK softkey	2-22
STORE/RECALL Function	2-23
Storing instrument setting	2-23
Recalling instrument setting	2-24
Special NOTEBOOK function	2-24

Chapter 3: Front Panel and Rear Panel

Front Panel	3-1
Rear Panel	3-6
Power supply	3-6
Removing power supply	3-7
Port A	3-7
Port B	3-7
CONTROL INTERFACE (Bu 18)	3-8
Adjustment of internal reference oscillator	3-9

Chapter 4: Menus of Basic Masks

Introduction	4-1
AF-PAR	4-2
Calling up RMS, AF-Pwr or DC-VOLT meter	4-2
Special functions for modulation measurements	4-3
RF-PAR	4-4
Activating automatic tuning	4-4
Setting PWR meter	4-4
Defining terminal/source voltage	4-5
Compensating external preattenuation	4-5
Activating squelch	4-6
Selecting IF bandwidth	4-6
MOD-PAR	4-7
Selecting modulation/demodulation	4-7
Activating 1-kHz generator	4-8
Working with external modulation signal	4-8
FILTER	4-10
Activating weighting filter	4-10
Activating highpass filter	4-11
Activating lowpass filter	4-11
Combining highpass and lowpass filters	4-12
Activating bandpass/bandstop	4-12
Setting DIST test frequency	4-13
Rules for AF filters	4-14
PRINT	4-15
Selecting printer	4-15
Selecting interface	4-15
Setting RS-232 transmission protocol	4-16
Configuring IEEE interface	4-17
Printing out masks	4-18
Printer HP 2225	4-18
Printer FX80 and compatibles	4-19
Printing out test reports and listings	4-19
RELAYS	4-20
Setting and resetting relays	4-20
Setting and resetting TTL outputs	4-22
Coding channel numbers	4-23
Hex coding	4-23

BCD coding	4-23
NoL/U	4-24
Defining channel/duplex spacing	4-24
Defining channel/frequency assignment	4-24
Automatic RX/TX combination	4-25
CHAN	4-27
Defining frequency pairs	4-27
Recalling frequency pairs	4-27
STATUS	4-28
Standard complement	4-28
Options	4-28
HW REV	4-30
CALBRT	4-31
Calibrating	4-31
Self-check	4-31
What to do if the self-check signals failed	4-33

Chapter 5: Standard Measuring Devices

Introduction	5-1
Test Setup	5-2

RF measuring devices

Available RF Measuring Devices	5-3
Test Receiver	5-4
Standard use	5-4
Adjustable variables	5-4
Activating test receiver	5-4
Entries	5-4
Automatic tuning	5-6
Connecting RF input socket	5-8
Applying modulation signal to test item	5-9
Standard measurements in TX mode	5-10
RF measurements	5-10
AF measurements	5-10
Signal Generator	5-12
Standard use	5-12
Adjustable variables	5-12
Activating and deactivating signal generator	5-12
Entries	5-13
Connecting RF output socket	5-16
Modulation test	5-17
Standard measurements in RX mode	5-18
RF measurements	5-18
AF measurements	5-18
RF Offset Counter OFFSET	5-20
RF Counter	5-22
RF Power Meter PWR	5-24
Modulation Meter MOD	5-26
Modulation Meter DEMOD	5-28

Spectrum Analyzer	5-32
Calling analyzer	5-32
Settings	5-33
Analyzer functions	5-34
Continuous spectral display (CONTIN)	5-34
Frozen spectral display (FREEZE)	5-34
One-shot measurement (1-SHOT)	5-35
Evaluating signal spectrum (MARKER)	5-35
Monitoring Receiver	5-38
AF measuring devices	
AF Signal Analysis	5-40
Connecting test signal	5-41
Available AF measuring devices	5-41
RMS Meter/AF Frequency Counter	5-43
Relative Level Meter dB-REL	5-44
SINAD Meter	5-46
Distortion-factor Meter DIST	5-48
AF Power Meter AF-Pwr	5-50
Digital Storage Oscilloscope	5-52
Calling scope	5-52
Connecting test signals (SOURCE menu)	5-53
Setting deflection coefficients	5-54
Vertical deflection coefficient (AMPLI menu)	5-54
Horizontal deflection coefficient (TIME menu)	5-54
Trigger settings (TRIGGER menu)	5-55
Scope functions	5-57
Continuous curve display (CONTIN)	5-57
Frozen curve (FREEZE)	5-57
One-shot measurement (1-SHOT)	5-58
Measuring curve (MARKER)	5-58
AF Generators	5-59
Operating generator GEN	5-60
Operating 1-kHz generator	5-62
Applying external AF signal	5-63
Overlaid signals	5-65
Checking AF output signals	5-66
DC measuring devices	
DC Voltmeter DC-VOLT	5-67
System tester	
Selective-call Tester	5-68
Choosing selective-call mode	5-69
Connecting test item	5-70
RF signal path	5-70
AF signal path	5-70
Declaring test parameters	5-71
Entries in basic mask	5-71
Entries in test mask	5-72

Choosing tone sequence (STND menu)	5-73
Test parameters under PARMs menu	5-74
Altering frequencies (FREQ menu)	5-75
Altering tone/pause duration (TIME menu)	5-76
Special functions	5-77
Starting test cycle	5-78
One-shot test	5-78
Continuous test	5-78
Acoustic check	5-79
Results of decoding	5-80
Computer-aided processing of results	5-81
A/B Tone Encoder	5-82
Selecting pager type	5-83
Declaring test parameters	5-83
Starting test cycle	5-84

Chapter 6: Hardware Options

Introduction	6-1
------------------------	-----

- Duplex synthesizer
- Data module
- DTMF module
- Interface Centronics/RS-232/keyboard
- Interface IEEE-488/RS-232/keyboard cross as applicable
- External synchronization
- Internal battery
-

Chapter 7: Specials

Introduction	7-1
RX Special SENS	7-2
RX Special BANDW	7-4
RX Special AF RESP	7-6
RX Special SQLCH	7-8
TX Special SENS	7-10
TX Special VSWR	7-12
TX Special AF RESP	7-16
TX Special F-BRST	7-18
DUPLEX Special DESENS	7-20
DUPLEX Special AF RESP	7-22
DUPLEX Special F-BRST	7-24

Chapter 8: MEMORY

Introduction	8-1
What are files ?	8-1
Memory Card	8-2
Slot for memory cards	8-2

Replacing batteries	8-3
Procedure for replacing button cell	8-3
Proper disposal of used button cells	8-3
Write-protect switch	8-4
MEMORY Mask	8-5
Softkeys of MEMORY mask	8-5
Directories	8-6
Directory of main memory	8-6
Directory of memory card	8-6
Selecting entries	8-7
Identifying file types	8-7
Formatting Memory Cards	8-8
Reserved memory locations	8-9
Copying Memory Cards	8-10
A little bit at a time	8-10
Software Write Protection	8-12
Setting write protection	8-12
Resetting write protection	8-13
Assigning File Names	8-14
Tips on assigning file names	8-15
Renaming Files	8-16
Deleting Files	8-17
Saving and Loading Setups	8-18
Loading setups	8-18
Saving setups	8-19
Saving and Loading Masks	8-20
Saving masks	8-21
Loading masks	8-22
Loading System Program	8-23
Saving and Loading AUTORUN Programs	8-24

Chapter 9: AUTORUN

Introduction	9-1
Rationalized testing with AUTORUN programs	9-1
Requirements	9-1
AUTORUN = BASIC + IEEE	9-2
AUTORUN Mask	9-4
Calling up AUTORUN mask	9-4
Display field	9-6
Editing line	9-6
Status line	9-7
Softkeys of AUTORUN mask	9-8
Editing Programs	9-9
Editing keys	9-9
Editing commands	9-10
Writing Programs	9-12
Fundamentals	9-12
Syntax check	9-13

Variables and units	9-14
Variables in IEEE commands	9-14
String variables	9-15
Internally used string variable M\$	9-15
String variables in IEEE commands	9-15
Splitting and joining strings	9-16
Permissible operands	9-17
Joining operands	9-17
When memory gets scarce	9-19
Executing Programs	9-20
Saving Programs	9-21
Loading Programs	9-22
Deleting Program in RAM	9-23
BASIC Commands	9-24
BEEP	9-25
CHAIN	9-26
CHR\$	9-28
CLS	9-29
END	9-30
FOR...NEXT	9-32
GOSUB...RETURN	9-34
GOTO	9-36
HEX	9-37
IF...THEN	9-38
IF OUTLIMIT / IF INLIMIT	9-40
INPUT	9-42
KEY	9-44
LEN	9-47
LET	9-48
ONERROR GOTO	9-49
ONERROR GOSUB	9-50
PAUSE	9-51
PRINT	9-52
RDOUT	9-55
REMARK	9-56
SETUP	9-57
TRACE	9-58
VAL	9-59
VAL\$	9-60
WAIT	9-61
Error Messages	9-62
IEEE Commands	9-64
Introduction	9-64
Actions in masks	9-65
Actions on front panel	9-69
Actions in menus	9-70
Test jobs	9-72
Special commands	9-77

Chapter 10: Software Options

Introduction	10-1
Loading and Starting System Programs	10-2
Errors in loading	10-2
Resetting write protection	10-3
<input type="checkbox"/> NMT 450/900 Scandinavia	
<input type="checkbox"/> NMT 450	
<input type="checkbox"/> NMT 900	
<input type="checkbox"/> NMT 450 universal	
<input type="checkbox"/> C-Netz Austria	
<input type="checkbox"/> NMT Benelux	
<input type="checkbox"/> NMT France	
<input type="checkbox"/> Netei-C Switzerland	
<input type="checkbox"/> ETACS UK	
<input type="checkbox"/> NTACS	
<input type="checkbox"/> JTACS (ETACS Japan)	cross as applicable
<input type="checkbox"/> EAMPS	
<input type="checkbox"/> RC 2000	
<input type="checkbox"/> POCSAG	
<input type="checkbox"/> POCSAG FFSK	
<input type="checkbox"/> Tracking with Cable Fault Finder	
<input type="checkbox"/> Trunking MPT 1327/PAA 2424	
<input type="checkbox"/> Microcell	
<input type="checkbox"/> US Signalling	
<input type="checkbox"/> LTR and US Signalling	
<input type="checkbox"/>	
<input type="checkbox"/>	

Chapter 11: Remote Control

The IEEE-488 Bus	11-1
History	11-1
Bus structure	11-1
Creating IEEE-488 system	11-3
What settings are necessary ?	11-3
When IEEE and when AUTORUN ?	11-4
How to create an IEEE program	11-5
Notation	11-5
Programming examples	11-6
Tips & tricks	11-7
Output format	11-8
Normal presentation	11-8
Technical presentation	11-8
Service request	11-9
IEEE commands only for remote control	11-10

Chapter 12: Appendix

Appendix A	A-1
Technical Data	A-1
Appendix B	B-1
Working with channel numbers	B-1
Entering conversion parameters	B-1
Entering channel numbers	B-2
Exchanging upper band and lower band	B-4
Returning to frequency entry	B-4
Appendix C	C-1
Version status	C-1
Appendix D	D-1
Executing firmware update	D-1
Recording instrument settings	D-1
Replacing EPROMs	D-1
Appendix E	E-1
Functional description of STABILOCK 4015	E-1
Front panel foldout	E-3
STABILOCK 4015 block diagram	E-4
Appendix F	F-1
Quick Reference	F-1
Index	F-7

Remarks



As you can see, we are now printing our manuals on recycled paper. Perhaps you would also like to know why we have decided to do this: because in our opinion 50 kg of chlorine organic compounds (eg dioxine) per ton of white, chlorine-bleached paper is simply too much. Quite apart from the fact that two or three trees also have to be felled for the purpose. By the way, from one ton of paper we can produce about a thousand manuals.



Our new folders are 90% recycled paper. To protect new manuals against damp and dirt, they will be covered with a 120-micrometer-thin polypropylene film, which is quite unobjectionable in ecological terms.



DBP 527 GI

STABILOCK 4015 has been tested to DIN VDE 0871/6.78 in conjunction with German PTT decrees 1046/1984 and 483/1986 as well as DIN VDE 0875 part 1/12.88 and EC directive 87/308/EEC plus German PTT decree 527/1979. STABILOCK 4015 has thus been awarded the symbol for RFI suppression.



Trade names, article names and the like are used in this manual without any special identification because they are generally known by the reader. But these names can be the copyright of companies, institutes, etc.



Software and Documentation © 1985-1992 Schlumberger Technologies GmbH. All rights reserved. No part of this manual or the associated program may be reproduced or copied in any form (print, photocopy or any other process) without the written approval of Schlumberger Technologies GmbH.

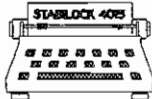

These operating instructions were made with the DTP software VENTURA Publisher 3.0.

Startup

For the Reader in a Hurry



This section is intended for all of those who find operating manuals a torture. If you sacrifice just 15 minutes of your time at this point, you will find information that you just should not be without. This is information about first-time startup, important declarations for understanding the manual and elementary operating rules.

First-time startup

If you want to start up your STABLOCK 4015 right away, please note the following:

- Permissible line AC voltage 110 V or 220 V. The Communication Monitor adjusts itself automatically to the voltage you apply.
- Only insert the power plug in an outlet with a ground contact.
- To start, set the power switch to LINE or BATT.









Immediately after you power on, all the LEDs will light up briefly (working check). Then the monitor shows one of the so-called masks.

Now you can calibrate STABLOCK 4015 (see "Calibration" section in this chapter) and get acquainted with it by trial and error. If you feed in any signals, be absolutely sure to observe the input-power limits for the RF sockets (see "Permissible RF Input Power" section in this chapter). All outputs are shortcircuit-proof. If you make grossly wrong entry combinations and STABLOCK 4015 refuses to accept any more entries from you, the **RESET** key will break the blockade.

Incorrect entries are answered with a signal tone. If you then simply tap **HELP**, the monitor will show you information about the cause of the error. Tapping **HELP** without first having made a mistake, however, produces a table of contents of the "built-in" manual, which contains important notes on use.

Declarations

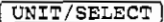
So that you can understand the abbreviated forms of notation used in the manual, you should first familiarize yourself with the following declarations:

	Notation for keys.
	Notation for softkeys (these are the five function keys along the bottom edge of the monitor).
 + 	Notation for entry prompts. In plain text this example means: first press the  key and then the  key.
Offset	Notation for texts when they are to be read off the monitor.
{FM ΦM AM}	In the so-called menus you will find different menu items for setting the operating status of STABILOCK 4015. In the entry prompts the menu item that is to be selected is shown between braces. If one of a number of menu items is to be chosen, all permissible menu items will be listed and separated by the " " character. You <i>always</i> choose menu items with the  key; that is why this key is not mentioned extra in the entry prompts (see also "Examples for practice" section). There are details about finding and choosing menu items in the "Working with menus" section.
...9 kHz ¹⁾	Upper indexes refer to Appendix C (Chapter 12). There you will find <i>important</i> details concerning the marked passage in the text and the hardware and software versions of STABILOCK 4015.
	Reference to an important passage in the text.
	Danger warning

Working with masks

The major operating modes of STABLOCK 4015 are called up with the following keys:

- TX** Calls the basic TX mask (tests on transmitters).
- DUPL** Calls the basic DUPLEX mask (tests on transmitters and receivers); requires the "DUPLEX Synthesizer" option.
- RX** Calls the basic RX mask (tests on receivers).

Proceeding from the basic masks, you call up further modes with the softkeys. The masks that appear will cover the basic mask entirely or in part:

- SCOPE** Calls up the digital storage oscilloscope.
- ZOOM** Full-screen display of one of the pointer meters.
- SPECIAL** Selection menu of ready programs for routine tests.
- SYSTEM** Calls up the system tester (selective call, PL/DPL, DTMF or system test program on a memory card).
- ANALYZ** Calls up the spectrum analyzer (only in the basic TX mask).

 **TX**, **DUPL** and **RX** always take you from any mask back to the particular basic mask.

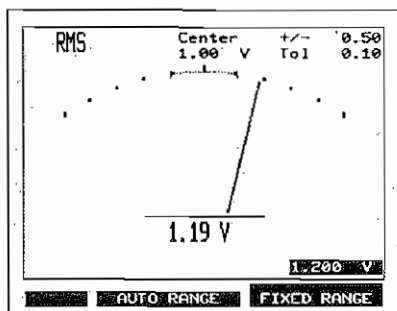

Fig. 1.1: Full-screen display of RMS pointer meter. The **TX**, **DUPL** and **RX** keys take you back to the basic mask.

In the upper half of each basic mask you find entry fields for the test parameters (tuned frequency, RF output level, etc). Entry fields are always – in every mask – reached with the cursor keys. Only the basic masks offer fast access:

- FREQ** Opens the **Frequ** field (tuned frequency of the test receiver or signal generator).
- LEVEL** Opens the **Lev** field (RF output level) in the RX and DUPLEX modes.
- MODFREQ** Opens the field for entering the frequency of the standard AF generator **GEN**.
- MOD** Opens the level/modulation entry field of the standard AF generator **GEN**.

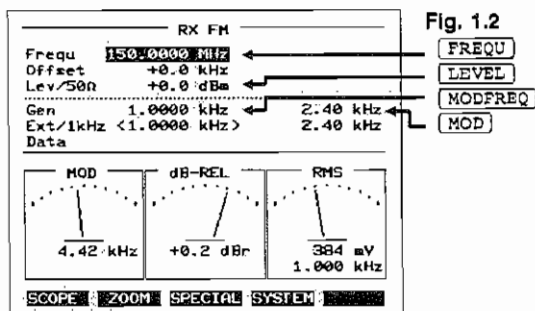

Fig. 1.2



Always close numeric entries with **ENTER**. In some entry fields you can open a small screen window with **UNIT/SELECT** beforehand (Fig. 1.3) to permit alteration of the unit (eg **Lev** field). Continuous alteration of numeric values with the spinwheel (eg tuned frequency) requires *no* confirmation by **ENTER**. If entries are rejected accompanied by a signal tone, tap **HELP** and read the cause of the error on the monitor.

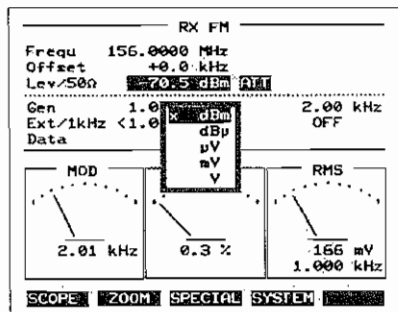

Fig. 1.3: Selecting unit for the **Lev** field. Place the cursor bar on the required unit with the cursor keys or spinwheel and press **UNIT/SELECT**.

The bottom half of the mask can show RF and AF pointer meters, the particular AF meter that you want being called up with keys **dBrel/VOLT** and **SINAD/DIST**. **VOLTM**, **DEM0D** and **RX MOD/MODGEN** determine whether the AF meters evaluate a signal fed in on the VOLTM socket, the received and demodulated signal or the signal of the internal AF generators.

Working with menus

The settings that do not constantly have to be altered (IF bandwidth, type of modulation, etc) are made in so-called menu windows (menus for short). These do not become visible on the monitor until you open them by pressing a key.

Open menu window

Press the **MENU** key. This opens a menu window on the monitor that usually shows a number of menu items (Fig. 1.4). The softkeys now indicate new functions and all tests are interrupted (exception: monitoring of permissible input power on the RF socket RX/TX).

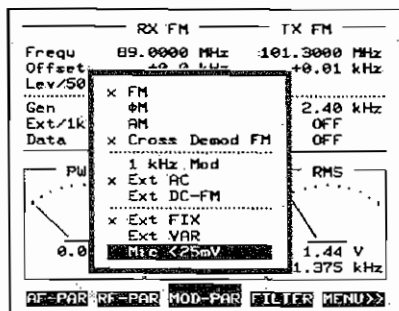

Fig. 1.4: Here the MOD PAR menu has been opened, which permits the setting of various modulation parameters.

Change menu window

Once the monitor is showing a menu window, other menu windows can be opened with the softkeys. The softkey whose menu window is momentarily open is highlighted. The softkey designations indicate what settings the menus will allow. The menus that are offered will depend on the operating mode of STABLOCK 4015. If a mode gives you more than five menu windows, softkey **MENU>>** appears (scroll to next menu selection).

Close menu window

Press the **MENU** key. This closes the menu window that is currently open (**TX**, **DUPL** and **RX** also close menu windows correctly). The monitor again shows the original mask and its softkey functions. Tests are continued, but all alterations made in the menu windows now apply.

You produce the required operating status on STABLOCK 4015 simply by selecting one or more of the menu items that are offered. In the MOD-PAR menu, for instance, you can set frequency modulation by choosing menu item FM.

Locate menu item

Before selecting a menu item, you have to locate it. To do this, move the cursor bar to the required menu item with the cursor keys or the spinwheel. If you keep the cursor keys depressed, the cursor bar is moved on automatically. Menu items that are shown with only half brightness are momentarily disabled (eg because an option is missing); these cannot be located until a certain requirement is fulfilled.

Select menu item

There are two kinds of menu item:

- Type A: menu items that are fully covered by the cursor bar (Fig. 1.5).
- Type B: menu items that are only partly covered by the cursor bar (Fig. 1.6).

Menu items of type A are selected simply by striking the **UNIT/SELECT** key. A cross is entered in front of the menu item for confirmation. If menu items are interdependent, the selection of one menu item will cancel the cross in front of an adjoining menu item. Thus, in the MOD-PAR menu for instance, only one of the three kinds of modulation can be crossed at any one time. If a menu item is independent of others, the cross in front can be canceled by striking **UNIT/SELECT** again.

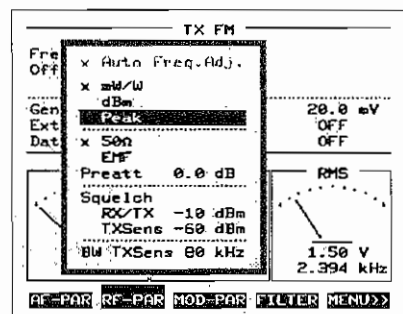

Fig. 1.5: Here a menu item of type A has been located. Menu item Auto Freq. Adj. (activates automatic tuning) is disabled, because the RX/TX socket was not connected when this picture was taken.

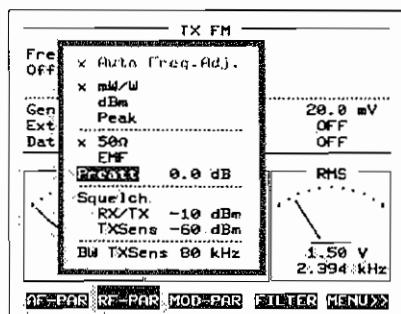

Fig. 1.6: This is a menu item of type B. The two menu items under Squelch and the menu item BW TXSens are also of this type (can be recognized by the numeric values).

**Select
menu item**
(continued)

Menu items of type B permit either entry of a numeric value or selection of a setting from an offered list of settings. The selection of these menu items also starts with **UNIT/SELECT**. There can be three different reactions to this:

- A cross is entered in front of the menu item, ie the menu item is selected and the numeric value to the right of the menu item applies. To alter the numeric value, move the cursor to the right, type in the new value and confirm your entry with **ENTER**.
Example: RF-PAR menu, menu item RX/TX (switch squelch to RX/TX socket and enter the squelch response level).
- You can start straight away by typing in a numeric value (confirmation with **ENTER**). The numeric value assumes the function of the cross, ie for numeric values of $\neq 0$ the menu item is selected automatically.
Example: RF-PAR menu, menu item Preatt (enter value of external preattenuation for compensation purposes).
- A submenu opens on the monitor that offers given settings (Fig. 1.7). Mark the required settings with the cursor bar and select them with **UNIT/SELECT**. These menu items are not crossed because the associated function must always have one of the offered values.
Example: RF-PAR menu, menu item BW TXSens (select IF bandwidth of test receiver).

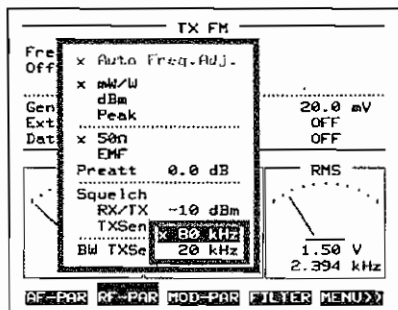

Fig. 1.7: The menu item BW TXSens conceals a submenu that allows you to select IF bandwidth.

Examples for practice

Example 1: Chapter 5, for instance, contains the following entry prompt for setting the IF bandwidth of the test receiver:

Opens menu window.
Testing is interrupted.

Move cursor bar to menu item BW TXSens and select this menu item by striking **UNIT/SELECT** key. This opens submenu.

Closes menu window RF-PAR. Tests are continued; selected IF bandwidth is now applicable.

MENU + **RF-PAR** + {BW TXSens} + {80 kHz | 20 kHz | 9 kHz¹⁾} + **MENU**

Strike softkey **RF-PAR** and open associated menu window.

This submenu offers various IF bandwidths. Move cursor bar to required entry and choose it with **UNIT/SELECT**.
¹⁾ refers you to Appendix C, where you can read that the entry 9 kHz only comes with a certain version of the demodulator stage.

Example 2: And this is the entry prompt for setting the modulation:

Opens menu window.
Testing is interrupted.

The menu window offers three menu items for the modulation. Move cursor bar to required entry and select it by striking **UNIT/SELECT** key.

MENU + **MOD-PAR** + {AM | FM | Φ M} + **MENU**

Strike softkey **MOD-PAR** and open associated menu window.

Closes menu window MOD-PAR. Tests are continued; selected modulation is now applicable.

Introduction

In the development of the STABLOCK 4015 Communication Monitor, careful attention was paid to intuitively correct operation of all elementary functions. Fast familiarization is assisted by a powerful HELP function. This lets you know straight away that you have done something wrong by means of an acoustic warning signal. The HELP function will also give you information about what you have done wrong (insertion of HELP texts on the monitor) and about the meaning of important masks and keys.

This manual is primarily a source of reference, with indexes that let you find what you are looking for fast. We suggest that you just take a look at the list of contents. This will be enough to familiarize you with the structure of the manual so well that you will soon be able to find your way about very easily.



After first getting acquainted with STABLOCK 4015 you really should read the sections "Safety Notes" and "Permissible RF Input Power" in this chapter. They contain important information that will help safeguard you against injury and the instrument against damage.

Standard Equipment

	Ordering code
1 x STABLOCK 4015	108 901
1 x Operator manual	290 089
1 x Memory card (32 kbytes, blank)	897 050
2 x 50- Ω terminations for sockets RX HIGH, TX SENS (BNC connector)	874 009
1 x Power cable, standard or	880 604
Power cable USA or	880 620
Power cable UK	880 621
1 x Female connector for battery cable	884 015
1 x Jack plug for headphones	884 123
1 x Set of miniature fuses (power)	849 036
1 x Set of miniature fuses (battery)	849 064
1 x Set of protective covers for front and rear panel	501 370

Internal hardware options (see Chapter 6) ordered together with the Communication Monitor will usually be ready installed ex works.

STABLOCK 4015 tells you on its screen what hardware options are installed. For this call up the STATUS menu as described in Chapter 4.

Safety Notes

STABILOCK 4015 is built and tested in line with DIN 57411 part 1 (protective measures for electronic test equipment). The instrument complies with safety class I; it left the works in a perfectly safe condition for operation. To make sure it stays this way and can be operated without any risk, take good note of the following instructions, which are based on section 17 of DIN 57411 part 1a:

Before startup

Before powering on, ensure that the operating voltage which is permitted for STABILOCK 4015 ($115\text{ V} \pm 20\%$ or $220\text{ V} \pm 20\%$) is the same as your power source. STABILOCK 4015 adjusts itself automatically to the applied (permissible) line voltage.



The power plug must only be inserted in an outlet with a ground contact. You should not cancel the resulting protective effect by using an extension cable without a protective conductor.

Any interruption of the protective conductor inside or outside of the instrument or undoing of the connection of the protective conductor can make the instrument a potential risk.

During tests

The power plug of STABILOCK 4015 must be inserted before connecting to live test circuits that are not joined to a protective conductor.

During maintenance and repair

Live parts can be exposed when you open covers or remove components. Connecting parts can also be live.

Before any adjustment, maintenance, repair or replacement of parts the instrument must be separated from all voltage sources if it will be necessary to open it.

If any jobs have to be performed on the instrument while voltage is applied, they should only be undertaken by a specialist who is aware of the dangers that are involved.

Capacitors in the power supply can still be charged, even though the instrument has been separated from all voltage sources.



High and dangerous voltages can still be present in the instrument when it is being powered from a battery.

Only use fuses of the stated type (see "Line Power" section). You should never patch fuses or short the fuse holder.

Shutdown when defective

If you think that it is unsafe to continue operating the 4015, shut it down immediately and secure it in such a way that nobody else can start it up again, ie especially for the protection of third parties. Get in touch with your nearest SCHLUMBERGER service station.

In the following cases, safe operation is very likely no longer possible:

- if the instrument exhibits visible damage,
- if the instrument will no longer work,
- after a longish period of storage under the wrong conditions (see data sheet),
- following transport under adverse conditions.

Notes on health and environmental protection



The internal 20-dB attenuator contains beryllium oxide. This material can be carcinogenic if it comes into contact with the skin or particles are inhaled. The component is normally quite harmless, but it should not be opened up or destroyed. There is an appropriate warning on the cover of the attenuator. If the component has to be disposed of, take it to a special-refuse treatment plant or a SCHLUMBERGER service station.

The internal battery (option) contains nickel-cadmium cells. Cadmium is poisonous, so when the battery is used up, do not put it into the normal waste disposal but instead take it to a proper recycling plant, a station for used batteries or a SCHLUMBERGER service station.

Permissible RF Input Power

STABILOCK 4015 has two RF input sockets: socket TX SENS for low-power signals and socket RX/TX for power signals.

TX SENS socket

$P_{\max} = 0.1 \text{ W}$ (no time limit)



Input signals of $P > 0.25 \text{ W}$ will destroy the highly sensitive RF input stage of the Communication Monitor.

RX/TX socket

$P_{\max} = 50 \text{ W}$ (no time limit)

$P_{\max} = 150 \text{ W}$ (with time limit)

Fig. 1.8 illustrates for $P = 150 \text{ W}$ the relationship between permissible duration of application and the waiting time between two tests:

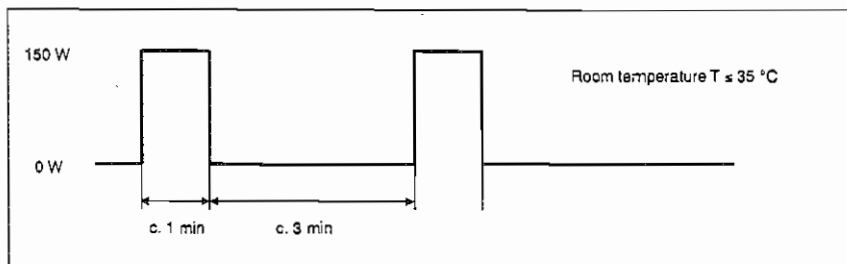
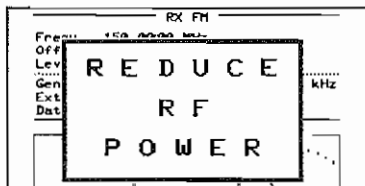

Fig. 1.8: The maximum permissible power of 150 W may be applied for c. 1 min. Then you must wait c. 3 min before again applying 150 W for c. 1 min. If the time is shortened to 30 s for example, the duration of the following test phases (with 150 W) is reduced to c. 20 s.

For power of $50 \text{ W} < P < 150 \text{ W}$ the permissible duration of application is correspondingly longer. If this permissible duration of application is exceeded, a warning signal will sound and the monitor shows **REDUCE RF POWER**.



When the monitor shows **REDUCE RF POWER**, the applied power must be reduced immediately to $P < 50 \text{ W}$. Otherwise the internal attenuator will overheat. The display **REDUCE RF POWER** goes off after c. 30 s. Then the attenuator will have cooled down to c. 90 °C and Communication Monitor is ready to continue testing.





If the monitor shows **REDUCE RF POWER** after an unusually short time, check the two screws indicated in **Fig. 1.9** to make sure they are still tight. These screws are important for the thermal coupling of the RF module with the heatsink on the side of the enclosure.

Fig. 1.9: These two screws on the left-hand side panel must be tight to ensure that the RF module will only heat up slowly when high RF input power is applied.

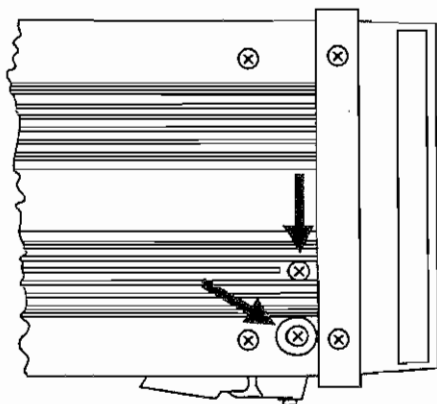

As long as power of $P > 50 \text{ W}$ is applied, STABILOCK 4015 should never be switched off. The input power can still cause the attenuator to overheat but no warning would be visible!

Line Power

Permissible line AC voltage

115 V \pm 20% and 220 V \pm 20%

STABILOCK 4015 sets itself automatically for 115 V_{ac} or 220 V_{ac}.



If the line AC voltage is out of tolerance, the specifications of STABILOCK 4015 will no longer be true. Line voltages of more than 264 V can damage the Communication Monitor.

Power connection

Connect the supplied power cable between the LINE socket of the power-supply module and a power outlet with a ground contact.

Power fuse

Fuse holder Si1 on the power-supply module.

Fuse insert: T1.6/250 D (slow, 1.6 A, size 5.2 mm x 20 mm).

Fig. 1.10: Rear panel of power-supply module. To take this module out of its slot, you must first undo the screws on the black strips at top and bottom and the two Phillips screws on the lefthand side panel (as seen from the rear) of the STABILOCK enclosure. The screws on the side are also important for thermal coupling of the power supply with the chassis, so you should not forget to tighten them again.

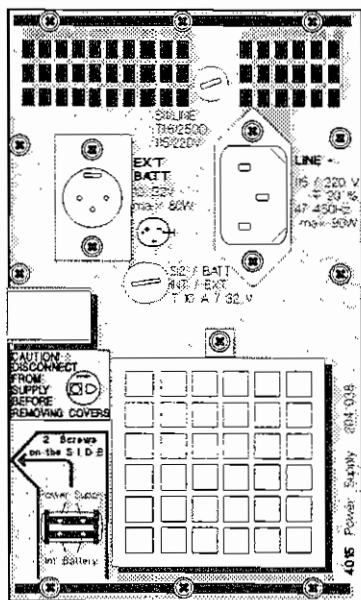

Battery Power

With STABILOCK 4015 there are two ways of battery powering:

- Powering from internal battery (option 205 006).
- Powering from external battery (eg car battery).

Powering from internal battery (option)

The internal battery (12-V nickel-cadmium block) has a capacity of 7 Ah. This is enough to power STABILOCK 4015 for about one hour. When the Communication Monitor is connected to the line, the internal battery is charged with approx. 0.7 A and switches automatically to floating operation when it is fully charged. The momentary voltage of the battery can be read off at any time in the STATUS menu (Battery field, see Chapter 4). If the field only shows dashes, there is no internal battery installed. The installation of the battery is explained in Chapter 6.

Powering from external battery

Fig. 1.11: The feed-in point EXT BATT (three-pin flange plug) for the external battery is located on the rear panel of the power-supply module. The polarity is also shown. The flange plug and the battery socket (ordering code 884 015) are non-interchangeable. If the polarity of the battery is reversed, an internal protective diode will prevent any damage to STABILOCK 4015.

Technical data of external battery: see Appendix A.

The external battery is not charged by the Communication Monitor.

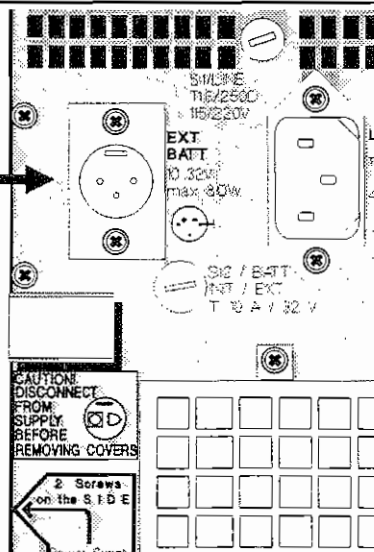

Fuse protection of internal/external battery

Fuse holder Si2 on the power-supply module.

Fuse insert: T10 A (slow, 10 A, size 6.5 mm x 32 mm).

Powering on

Line powering

Set the power switch to LINE or BATT. BATT is permissible because STABILOCK 4015 automatically selects line powering if there is no battery voltage.



If, after you power on STABILOCK 4015, a menu window appears with the title CALIBRATION REQUIRED, this can be for two reasons: the stored calibration factors have been lost (then you *must* calibrate afresh), or the stored calibration factors apply for a different interior temperature of the Communication Monitor (then you *can* calibrate afresh). Refer to the "Calibration" section for more details.

Battery powering or parallel line/battery powering

Depending on the voltage supply and the three settings of the power switch, STABILOCK 4015 is either line or battery powered. The following table shows the different possibilities:

Voltage supply			Setting of power switch	Operating status
Line voltage present?	Internal battery present?	External battery present?		
Unimportant	Unimportant	Unimportant	OFF	Instrument inoperative
Yes	Unimportant	No or $V_{\text{batt}} < \text{c. } 17 \text{ V}$	LINE or BATT	Line powering
No	Yes	No or $V_{\text{batt}} < \text{c. } 13 \text{ V}$	BATT	Powering from internal battery
Unimportant	Unimportant	Yes $V_{\text{batt}} > \text{c. } 17 \text{ V}$	BATT	Powering from external battery
No	Unimportant	Yes $V_{\text{batt}} > \text{c. } 13 \text{ V}$		
No	No	Yes $V_{\text{batt}} > \text{c. } 10 \text{ V}$		
Yes	Yes	Unimportant	LINE or OFF	Internal battery being charged

Table: Operating status of STABILOCK 4015 depending on voltage supply and setting of power switch



Bypassing power failure with internal battery (option): if the power switch is set to BATT instead of LINE during line powering, the internal battery will take over powering without interruption if there is a power failure.

Data Retention

Data retention when powering off

STABILOCK 4015 stores the complete instrument settings in a battery-buffered RAM (NiCd battery). When you power the Communication Monitor on again, it logs on with the basic mask that was last in use and the operating modes are exactly the same as when it was powered off (coupled sockets, menu settings, entries in fields, etc). So if you had to interrupt a test, you can continue it right away.

Data retention upon power disconnection

The data are preserved just as if you powered off STABILOCK 4015 intentionally.

Data retention upon change of mask

When you change from one basic mask to another, the momentary instrument settings are stored. These settings are then restored when you recall the particular basic mask. In this case instrument settings mean:

- entries in the mask fields and called-up pointer meters,
- coupling of sockets, AF test signals and AF generators.

On the other hand, a declaration made in the menus of the basic masks does *not* only apply to the basic mask you are using but to all masks (the few exceptions are pointed out in Chapter 5).

The entry fields of the basic DUPLEX mask adopt the contents of the appropriate fields in the basic RX and TX mask (and vice versa).

Total reset

A total reset puts STABILOCK 4015 into a specific operating status (resetting as ex works, see also Chapter 11, IEEE command ERASE). This is useful if the Communication Monitor has been set to an unknown status by someone else and the original operating status cannot be produced as a setup.

To execute a total reset, press the **OFF** key, keep it depressed and additionally press the **RESET** key for a short time.



A total reset clears programs stored in RAM and all setups stored in RAM are reset as they were ex works.

Calibration

Why calibrate?

STABILOCK 4015 needs to be calibrated from time to time to ensure that it adheres to its strict specifications. You can start the calibration operation at any time yourself, so environmental effects (eg changes of temperature) and component aging will not result in any loss of precision.

What happens in calibration?

STABILOCK 4015 feeds the various stages with internally generated reference signals for level and frequency. The signal that a stage produces is then compared to the reference values. This leads to the creation of correction factors that are stored by the RAM and which are afterwards taken into account when measured results are displayed and signals are generated.

Every time you power STABILOCK 4015 on, it checks the stored calibration factors. If any error is detected, a menu window will open automatically on the display and prompt you to carry out fresh calibration.

The interior temperature of STABILOCK 4015 plays an important role in calibration: if the Communication Monitor is calibrated straight after it is powered on for example, the calibration factors will no longer be right after warmup. The situation is the same if there are strong fluctuations in ambient temperature or changes of temperature because you feed in powerful RF signals. So, to prevent any "concealed" measuring errors, a sensor constantly monitors the interior temperature of the Communication Monitor. If the temperature difference exceeds about 6 °C, a menu window will open automatically on the display and suggest that you make fresh calibration³⁾. You can accept the suggestion or ignore it.

So STABILOCK 4015 offers three different kinds of calibration:

- Calibration when the interior temperature has altered by more than 6 °C³⁾ (temperature-regulated calibration).
- Calibration at any time regardless of the temperature control (specific calibration).
- Calibration if an error is found when checking the stored calibration factors (forced calibration).

Temperature-regulated calibration

If the interior temperature of STABILOCK 4015 alters by about 6 °C, a menu window automatically appears on the display³⁾ (Fig. 1.12). You can then choose to start the calibration operation or just continue working.

START CALIBRATE

Starts the calibration operation. First you have to withdraw all test cables from the front panel, because these could produce incorrect calibration factors²⁾. During calibration the display will read CALIBRATING. If this disappears after a few seconds, it means that all stages have been calibrated properly (new calibration factors in RAM, valid for the momentary interior temperature) and the Communication Monitor can continue working.

IGNORE

The calibration operation is *not* started. The stored calibration factors are kept but are related to the momentary interior temperature. Strike the softkey and the Communication Monitor is ready to continue. (IGNORE) should only be used in exceptional cases, eg if you want to continue a series of tests *without* any change in measuring accuracy.

STABILOCK 4015 only shows the menu window (Fig. 1.12) while one of the three basic masks or a ZOOM mask is called up (if the optional DATA Module is installed, neither the encoder or decoder may be activated).

In the warmup phase ($\Delta\theta \gg 6\text{ °C}$) STABILOCK 4015 may show the menu window a number of times. If you do not want to risk a measuring error, you should calibrate each time. If you have plenty of time, you can leave the (first) menu window on the display and wait until the Communication Monitor has warmed up (about 15 min) before starting the calibration routine. In this way you achieve high measuring accuracy that is only bettered by specific calibration.

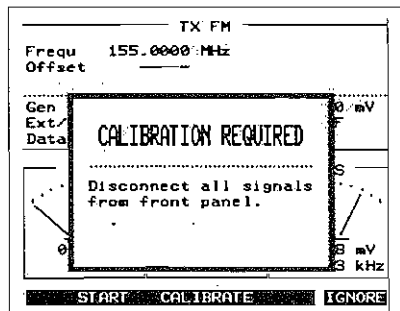

Fig. 1.12: If the interior temperature of STABILOCK 4015 alters and affects measuring accuracy, the display will show this menu window.

In the AUTORUN and REMOTE modes, temperature-regulated calibration in the way described is not possible (no basic mask). But IEEE commands can query the need for calibration and start the operation as necessary (see Chapter 9).

Specific calibration

If you calibrate immediately before testing, this will guarantee optimal measuring accuracy (especially in RF tests). Specific calibration also eliminates extremely small measuring errors that can be produced at only 4 °C temperature drift, for instance, and therefore cannot be corrected by temperature-regulated calibration. So, before carrying out precise measurements, you are advised to proceed as follows:

- **MENU** + **MENU>>** + **MENU>>** + **CALBRT** takes you to the menu shown in Fig. 1.13.
- Withdraw all test cables ²⁾, move the cursor to the menu item **Start Calibrate** and strike the **UNIT/SELECT** key. This starts the calibration operation, which you can recognize by the message **CALIBRATING**.
- The message **CALIBRATING** extinguishes after a few seconds if calibration is successful. After you close the menu window with **MENU** the process is finished and **STABLOCK 4015** uses calibration factors for the following measurements that exactly match the momentary interior temperature.



If you calibrate **STABLOCK 4015** during the warmup phase (lasts approx. 15 min), the calibration factors are only valid for a short time. So you should not carry out precise measurements during warmup.

Specific calibration is also advisable immediately before calling up modes that do not permit temperature-regulated calibration (eg scope, analyzer, work with a software option).

Fig. 1.13: This menu window permits specific calibration at any time. This ensures optimal accuracy for the following measurements.

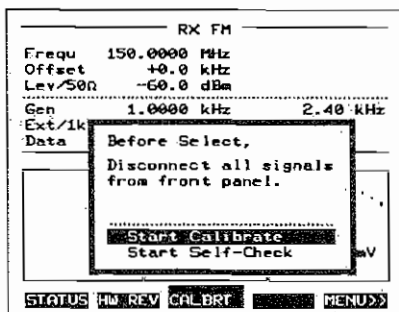

Forced calibration

Every time it is powered on, STABLOCK 4015 checks the calibration factors held in RAM by the checksum procedure. Any error that is detected will force the calibration routine (Fig. 1.14).

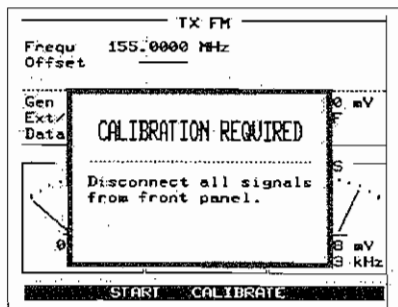

Fig. 1.14: If the display shows this menu window after you power on the Communication Monitor, it means the stored calibration factors are wrong. The menu requires you to withdraw all test cables from the front-panel sockets ²⁾. Strike any softkey to start the calibration.

Error message during calibration

If defective stages are detected during calibration, the SELF-CHECK is automatically called up (Fig. 1.15).



Fig. 1.15: If any stage cannot be calibrated, the display will show this message. Strike any key to start the SELF-CHECK. This only takes a few seconds (see Chapter 4, "CALBRT").

TX, **DUPL** or **RX** take you back to the basic mask after ending the SELF-CHECK.

Operating Rules

Operating Concept

The operating concept of STABLOCK 4015 is based on the same scheme for performing all tests:

- 1) Call up the required mask.
- 2) Fill in the entry fields of the mask (test parameters).
- 3) Call up the required test instruments.
- 4) Declare further test parameters in menu windows as required.
- 5) Connect test signal(s) and – if necessary – modulation generator(s).
- 6) Read the results directly from the meters or start the test and wait for the numeric results.

This chapter tells you how to perform the individual steps in operation. As preparation, read the section "For the Reader in a Hurry" in Chapter 1.

Mask Callup

The setting of a particular operating status always starts with the calling up of the appropriate "basic mask" (setting the mode). Calling up the basic RX mask, for example, straight away puts the Communication Monitor into the mode for receiver tests.

Callup of basic masks

Basic masks are always called up with the mutually canceling keys **TX**, **DUPL** or **RX**:

- TX** Callup of TX mode (transmitter tests).
- DUPL** Callup of DUPLEX mode (transmitter and receiver tests). This basic DUPLEX mask can only be called up if the optional DUPLEX synthesizer is incorporated.
- RX** Callup of RX mode (receiver tests).

The top half of each basic mask has entry fields for setting the required test parameters, while the bottom half is always reserved for displaying test instruments.

Mask callup with softkeys

The so-called softkeys (the row of keys beneath the monitor) are assigned their functions by the mask that is called up. The function of a softkey is shown by the bright-up fields along the bottom edge of the monitor. Just strike a softkey and the particular function will be executed.

In the basic masks all softkeys serve the purpose of calling up other masks. These masks cover the basic mask either entirely or in part, ie its bottom half (Fig. 2.1 and 2.2).

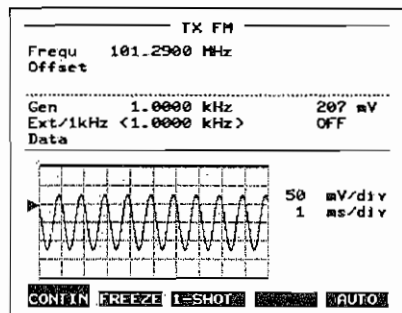

Fig. 2.1: Here the bottom half of the basic TX mask is concealed by the scope mask.

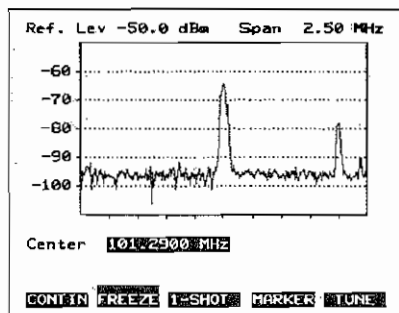

Fig. 2.2: The mask of the spectrum analyzer entirely conceals the basic TX mask.

☞ When a basic mask is concealed by another mask, the mode produced by the basic mask is still maintained. If you display the scope in the basic TX mask for instance (Fig. 2.1), the Communication Monitor is still in the TX mode (transmitter tests). The monitor will not show any pointer meters in the bottom half however, but the scope mask instead. Then you can look at an oscillogram of the demodulated received signal.

The softkeys of the basic masks call up the following masks:

(SCOPE) Callup of the scope mask (digital AF storage oscilloscope). With the scope you can examine an external AF signal, the demodulated received signal or the modulation signal of the signal generator (see Chapter 5, "Digital Storage Oscilloscope").

(ZOOM) Callup of a ZOOM mask (full-screen display of a pointer meter). The ZOOM masks are particularly useful for adjustments (see section "ZOOM Function" in this chapter).

(SPECIAL) Callup of ready programmed test routines. These SPECIALs execute time-consuming routine measurements, like that of modulation frequency response, in a matter of seconds (see Chapter 7).

(SYSTEM) Callup of masks for testing selective-call sets, radio-data sets or radiotelephones (see Chapter 5 and 10).

(ANALYZ) Callup of the spectrum-analyzer mask (only possible from the basic TX mask). The spectrum analyzer will show the spectral distribution of a carrier signal, for example, or the occupancy of stations in a frequency band (see Chapter 5, "Spectrum Analyzer").

☞ (TX), (DUPL) and (RX) will take you back to the basic mask from *each* mask.

If a mask conceals a basic mask entirely, you normally no longer have access to the entry fields of the basic mask. But to enable alteration of things like RF output level for instance, important entry fields are transferred to the superimposed mask. Here they have exactly the same features as in the basic mask.

Example: The entry field **Center** in the analyzer mask (Fig. 2.2) is the **Frequ** field (RF tuning frequency) from the basic TX mask. So, when you return to the basic TX mask, the **Frequ** field will contain the value that was last entered in the **Center** field (and vice versa).

Meaning of LEDs

Illuminated LEDs indicate that the particular function is active. When the LED above the **VOLTM** key lights up for instance, this means that the input signal on the VOLTM socket is connected through to the AF meters of the Communication Monitor. If the LED of the adjacent **DEMODO** key lights up, the demodulated received signal is connected, even if you still apply an AF signal to the VOLTM socket.

If there are several LEDs assigned to a key, you have to tap the key repeatedly to call up a particular function (if it is not disabled).

The LEDs "CCITT", "LP/HP" and "1 kHz" are not assigned to a key. These functions are called up from menu windows (see Chapter 4, "FILTER" and "MOD-PAR").

Colors of LEDs

A number of functions are disabled in the TX and RX modes. In the RX mode, for instance, you cannot connect a demodulated received signal with the **DEMODO** key because the signal generator is activated and not the test receiver.

You can see immediately what function is possible in what mode by the colors of the associated LEDs:

- TX In TX mode only those functions are accessible that have **red** or **yellow** LEDs.
- DUPLEX In DUPLEX mode every function is accessible.
- RX In RX mode only those functions are accessible that have **green** or **yellow** LEDs.

The colors of the LEDs correspond to the colors of the keys **TX**, **DUPL** and **RX**. Yellow has a special significance because the related functions are accessible in each mode.

Example: The **RX MOD/MODGEN** key has two functions. In TX mode only the MODGEN function can be accessed (red LED illuminated), in RX mode only the RX MOD function (green LED illuminated). In DUPLEX mode either of the functions can be activated by repeatedly tapping the key (meaning of functions; see Chapter 5, "AF Signal Analysis").

Filling in Entry Fields

The fields of a mask are divided into entry fields and display fields. The contents of an entry field – besides the settings made in the menu – affect the momentary operating status of STABLOCK 4015 (eg tuned frequency of the signal generator). Display fields are for the alphanumeric readout of measured values.

When you first start up, all entry fields contain default values (ie the values that are set ex works).

Locating entry field

Before you can fill in an entry field, you have to locate it. There are two ways of doing this:

- Fast access with the keys **[FREQ]**, **[LEVEL]**, **[MODFREQ]** and **[MOD]** (see Chapter 1, "Working with masks").
- Positioning with the four cursor keys (movement of the cursor bar).



The bright cursor bar always marks the located entry field (**Fig. 2.3**). Only this field will accept an entry. If an entry field indicates OFF, you cannot position it with the cursor keys until you have activated the associated test device (signal generator or one of the A generators). In other words you must press **[LEVEL]**, **[GEN]**, **[DATA]** or **[EXTMOD]**.

The fast access will only take you to the most important entry fields of a basic mask (even if the bottom half is concealed by another mask or a ZOOM mask is called up). With the cursor keys, however, you can reach *every* single entry field.

Fig. 2.3: This mask (basic RX mask and a system test mask) has nine entry fields. The Timeout entry field is the one that is momentarily located. The DATA Module option is not installed, so the entry fields of the AF generator DATA are missing in the data line.

What fields of a mask are entry fields can be found by moving the cursor bar.

RX FM	
Frequ	78.0000 MHz
Offset	+0.0 kHz
Lev/50Ω	1.000 V

Gen	1.0000 kHz
Ext/1kHz	<1.0000 kHz>
Data	

CCIR	
Call Number	123456
Decode Tones	5
Timeout	1000 ms
Decoded Tones :	
Response Time :	
1-SHOT CONTIN [RECALL] [RESULT]	

Annotations in the image:
- A bracket on the right side groups the top three fields (Frequ, Offset, Lev/50Ω) and the two fields below the dashed line (Gen, Ext/1kHz) as "Entry fields".
- A cursor bar is positioned over the "Timeout" field.
- A bracket on the right side groups the "Call Number", "Decode Tones", and "Timeout" fields as "CALL + DECODE".

Entering new numeric value

Most entry fields simply require the entry of a numeric value, the units already being firmly assigned. If the AF generator GEN is to be set to 1 kHz for example, all you have to do is enter the figure 1 in the appropriate entry field of the line Gen. The units kHz apply automatically, they cannot (at least in this entry field) be altered (Fig. 2.4).

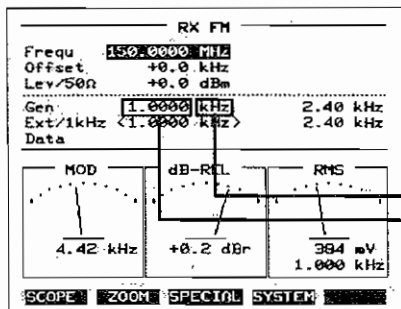

Fig. 2.4: The entry field for the frequency of the AF generator GEN only requires the entry of a numeric value. The units kHz are firmly assigned.

Operating procedure

- 1) Locate the required entry field.
- 2) Type in the new numeric value on the numeric block. Upon entry of the first digit the original value is deleted. A flashing cursor marks the entry position you are located at. The remaining zeroes do not have to be entered (example: entry field for frequency of AF generator GEN → entry 1.5 corresponds to 1.5000 kHz).
- 3) Confirm the entry with **ENTER**. Only then is the new numeric value adopted, which is shown by the disappearance of the flashing cursor. Any missing zeroes are added automatically.

With the fast access you leave a located entry field even if the entry has not yet been terminated by **ENTER**. In this case the entry is lost and is replaced by the original contents. This also applies if an entry field is left prematurely with the cursor keys pointing up/down. So you should always close entry fields *immediately* after making your entry.

Rejection of impermissible entries

STABILOCK 4015 checks an entry after **ENTER** to see if it is within the permissible limits. Impermissible entries are rejected with an accompanying signal tone (the entry field adopts its previous value). If you want to, you can then call up an information window with **HELP** to see what the permissible range of values is (Fig. 2.5). Make sure that you do not press any other key than **HELP** after the signal tone (see also section "HELP Function" in this chapter). **QUIT** closes the information window and you can then repeat the entry straight away.

Fig. 2.5: Information windows like this can always be called up if an entry is rejected. Here an attempt has been made to enter an RF output level of -87 dBm in the Lev field, while the RX HIGH socket is connected. Why this did not work can be seen from the information window.

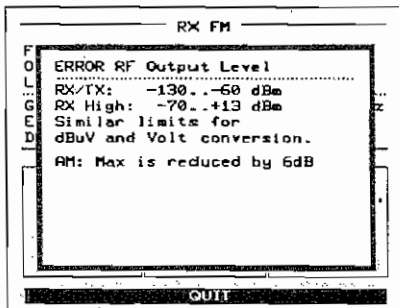

Correcting entries

Correction during entry

Incorrect entries can be corrected during the entry. Locate the position with the cursor keys that point left/right and overwrite the error.

Correction after entry

If you do not detect an incorrect entry until after you have confirmed it with **ENTER**, you can "open" the entry field again by striking **ENTER** a second time (the cursor flashes in the field). The contents of the field are not deleted. So you can locate the error with the cursor keys that point left/right and overwrite it.

Continuously altering entries

With the spinwheel VAR you can continuously alter the contents of each entry field *without* having to confirm the entry with **ENTER**. This enables you to gradually alter the tuned frequency, for example, and observe the effect of this on the measured result.

Operating procedure

- 1) Locate the required entry field. Use one of the keys for fast access or position the entry field with the cursor keys and open it with **ENTER**.
- 2) Move the cursor to the required place with the cursor keys and turn the VAR spinwheel until the value you want appears at the cursor location. Turning to the right produces higher figures and turning to the left lower ones. Note: When you reach 0 or 9, depending on the direction you turn, there is a carry over to the next place.
- 3) If you then want to move to any other field with the cursor keys, close this entry field first with **ENTER**.

Spinwheel function in menu windows

In menu windows the spinwheel has a dual function:

- Immediately after you open a menu window, the required menu item can be located quickly by turning the spinwheel (see also Chapter 1, "Working with menus").
- If you move the cursor with the cursor keys to the *entry field* of a menu item (eg menu item RX/TX in the RF-PAR) menu, the spinwheel will again enable you to alter a value continuously.

Selecting units of numeric value

In some entry fields you can assign a numeric value the units that you wish. If you are used to setting RF output levels in dBm for instance, you can still do this just as easily as someone who would rather work in dB μ or V. When the units are changed, the numeric value is converted automatically. In this way the fields concerned can also be used as "unit calculators".

What entry fields offer a choice of units?

All level entry fields (RF/AF) as well as the entry fields for RF frequencies offer a choice of units (Fig. 2.6), even if one of these fields has been adopted in a superimposed mask.

Fig. 2.6: Here all fields are marked that permit the assignment of units. The corresponding fields of the basic TX and RX mask offer the same assignment.

Note: The entry fields in the lines Gen, Ext/1kHz and Data (option) will only enable the assignment of units if the appropriate AF generators are switched to the TX signal path (see also Chapter 5, "AF Generators").

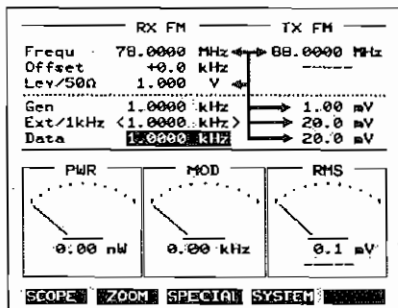

How are units selected?

- 1) Locate the required entry field (the field is brightened up).
- 2) Type in the numeric value and, *before* confirming it with **ENTER**, tap the **UNIT/SELECT** key. This opens a small window on the monitor that shows a list of the available units (Fig. 2.7). The momentarily valid unit will be "crossed".
- 3) Set the cursor bar to the required units with the cursor keys or the spinwheel and tap the **ENTER** or **UNIT/SELECT** key. This closes the window; the selected units are now valid.



As long as a window is open, all tests are interrupted. In entry fields where you cannot assign the units, pressing **UNIT/SELECT** will only cause the cursor to flash in the field (entry prompt).

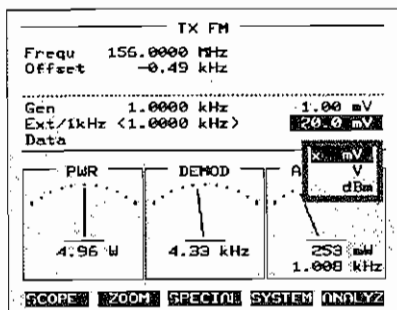

Fig. 2.7: The small window here shows the available units (V and dBm) for setting the level of the 1-kHz AF generator. V units are also offered with the dimension mV. From 999 mV onwards there is an automatic switch to the dimension V (example: entry 1500 mV becomes 1.500 V).

What units are there?

Entry field (see also Fig. 2.6)	Field contained in basic mask	Available units, dimensions	Use
Frequ	TX, RX DUPLEX (2 x)	MHz, NoL, NoU, Chn	Setting tuned frequency (MHz); special functions for working with channel num- bers (see Appendix B)
Lev (EMF or 50Ω)	RX, DUPLEX	dBm*, dBμ, μV, mV, V	Signal generator: setting RF output level
Level entry field Gen	TX, DUPLEX	mV, V, dBm (into 600 Ω)	Generator GEN: setting AF output level
Level entry field Ext/1kHz	TX, DUPLEX	mV, V, dBm (into 600 Ω)	1-kHz generator: setting AF output level
Level entry field Data	TX, DUPLEX	mV, V, dBm (into 600 Ω)	Generator DATA (option): setting AF output level

Available units and dimensions of all entry fields that permit individual assignment

* In a field designated Lev/EMF (source voltage) the units dBm are not permissible. If you do select these units, STABLOCK 4015 will switch automatically to a field designated Lev/50Ω (terminal voltage into 50 Ω) (see also Chapter 5, "Signal Generator").

Working with a "units calculator"

The entry field **Lev** and the level entry fields of the AF generators are very suitable for simply converting a numeric value into an equivalent value with different units (units calculator).

Operating procedure

- 1) Enter the known numeric value with its units as described and close the entry with **ENTER** (observe the permissible limits; if an entry in the **Lev** field is rejected, select the other RF output socket).
- 2) Tap **UNIT/SELECT** again, select different units and close the entry with **ENTER** or **UNIT/SELECT**.
- 3) The entry field will now show the numeric value you are looking for.



Only convert an RF level to dBm units if the field is designated **Lev/50Ω** (otherwise the result will be too small by a factor of 2). Do *not* convert any RF levels with the level entry fields of the AF generators because here the dBm units are referred to 600 Ω. If you are converting to V units, any dimension can be selected in step 2) (eg mV) because STABLOCK 4015 optimizes automatically when converting (0.001 V becomes 1.00 mV for instance).

Example: You want to convert the known value +40 dBμ into the equivalent dBm value (50 Ω).

- 1) **LEVEL** + 40 + **UNIT/SELECT** + {dBμ} + **ENTER**
- 2) **UNIT/SELECT** + {dBm} + **ENTER**
- 3) The **Lev/50Ω** field will now show the result -67.0 dBm.

Calling up Test Instruments

Working with test instruments is described in detail in Chapters 5, 6, 7 and 10. So here is just a brief overview:

RF instruments	AF instruments	DC meters	System testers	Optional instruments
Chapter 5 and 7		Chapter 5	Chapter 5 and 10	Chapter 6
Offset counter	RMS voltmeter	Voltmeter	Sequential tester	DUPLEX synthesizer
RF counter	Relative-level meter		A/B tone tester	PL/DPL tester
RF power meter	SINAD meter		Radio-data tester*)	DTMF tester
Modulation meter	AF frequency counter		Radiotelephone tester*)	Additional AF generator DATA
Spectrum analyzer	Distortion meter			
Signal generator	AF power meter			
Test receiver	Storage oscilloscope			
Monitoring receiver	AF generators			

Available test instruments of STABLOCK 4015; *) requires software options

24 instruments in one case

Working with the instruments is described as if they really were individual instruments. This means that, in Chapter 5 in the section "RF Counter" for example, you can read *everything* that is necessary for measuring the frequency of an RF signal: from preparation right through to reading the result. If you then want to measure the power of the signal, simply turn to the section "RF Power Meter PWR".

The Way to Results

The remaining three points of the operating concept (page 2-1) are quickly explained:

Settings in menus

Working with menus was already looked at in Chapter 1. Do not forget Chapter 4 either: here all twelve menus of the basic masks are illustrated and each menu item is briefly explained (for reference). All other menus are tied to individual instruments. So they are presented together with the particular instrument.



Menus or menu items are mentioned every time they are necessary for a setting, or if a menu item can have an unintentional effect on a measurement.

Coupling signals

Normally you should use the joint input/output socket RX/TX for RF measurements (maximum measuring accuracy, see Appendix A). The sockets TX SENS and RX HIGH are only necessary for very weak input signals or strong output signals. There are details of signal coupling in Chapter 5 under the following sections: "Test Setup", "Signal Generator", "Test Receiver", "AF Signal Analysis" and "AF Generators".

Typical test setups

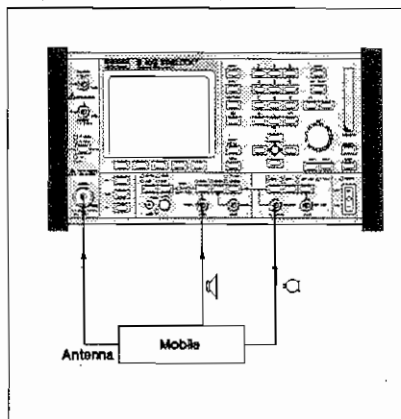

Fig. 2.8: Basic test setup for stationary measurements on one-port duplex radio sets

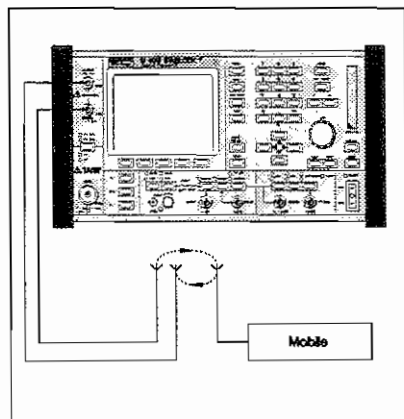

Fig. 2.9: Test setup for remote measurements on one receiving and one transmitting antenna

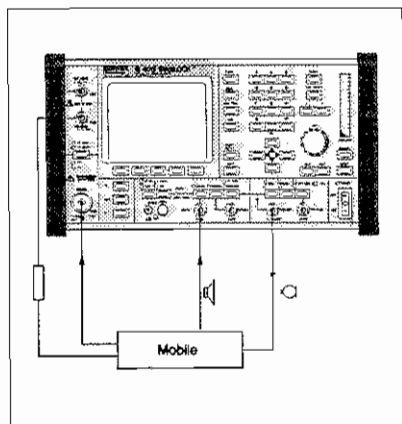

Fig. 2.10: Test setup for stationary measurements on dual-port duplex radio sets. The external preattenuation reduces the level on the receiver input of the test item.

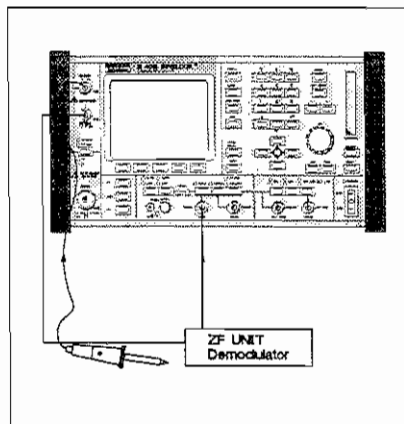

Fig. 2.11: Setup for board tests, eg for measurements on the IF stage of a mobile (RF measurements with probe and evaluation of the demodulated signal)

Reading results

All RF and AF instruments as well as the DC voltmeter start to measure immediately after they are called up. The results displayed by these instruments will be in one of the following forms:

- Pointer meter (for recognition of trend) plus numeric indication.
- Only numeric indication (RF counter and offset counter).
- Graphic display (scope and spectrum analyzer).

All system tests (radiotelephones, selective-call sets, etc) must be started extra after entry of the test parameters. The appropriate masks are produced by special softkeys. As soon as a test is completed, the results appear in numeric form in display fields of the test mask. If a system test produces very many results, there will be separate masks available (analysis masks, result masks) that can be called up and examined eg after the particular test.

HELP Function

The HELP function is always called up with **HELP**. This gives you assistance in the following situations:

- When you want basic information as fast as possible about the meaning of a key or function ("built-in manual").
- When an entry is rejected and you want to know why.
- When you want to know, before making an entry, what values are permissible.

Built-in manual

HELP calls up the index of the contents of the built-in manual if the following has been done:

- If an entry in the momentarily located entry field has been terminated with **ENTER** (no flashing cursor in the field).
- If, before striking **HELP**, you have not made an incorrect entry (no acoustic error signal).

The index shows on two pages (switch between them with the softkeys **FUNCT** and **KEYS**) for what functions and keys there is information stored (Fig. 2.12 and 2.13).

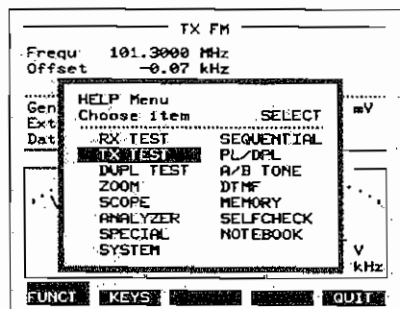

Fig. 2.12: The built-in manual provides information about these functions.

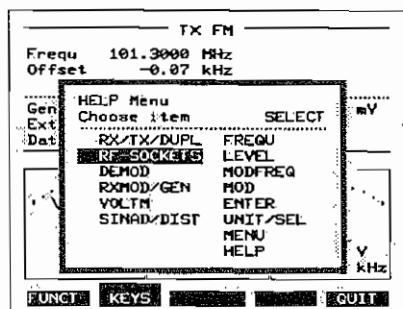

Fig. 2.13: The built-in manual can also tell you about these keys.

Requesting information

- 1) Place the cursor bar on the required entry with the cursor keys.
- 2) Tap the **UNIT/SELECT** key. This calls up the stored information pages (Fig. 2.14). Scroll up and down with **NEXT** and **LAST**.
- 3) Return to the index with **FUNCT** or **KEYS**. Exit from the HELP function with **QUIT**.

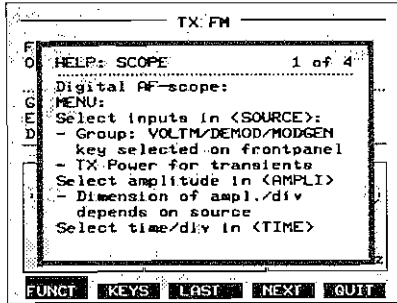

Fig. 2.14: If a single information page is not enough, like here, repeatedly tap **NEXT** to scroll through the following pages.

HELP after incorrect entry

As already explained in the section "Filling in Entry Fields", impermissible entries are rejected with an accompanying signal tone. If you want to know what was wrong about the entry, you can call up an information window with **HELP**. But this will only give you information about what has been done wrong if, after the sound of the signal tone, no other key except **HELP** has been tapped. If this rule is not followed, you will not see the required information but instead the index of the built-in manual.

HELP before filling in entry field

If you do not want to run the risk of an error message, **HELP** will give you information about the permissible range of values *before* you make your entry. This works as follows:

- 1) Locate the required entry field. The cursor must flash in the field. If not, tap the **ENTER** key.
- 2) Tap the **HELP** key. This opens an information window with details of the positioned entry field. If the monitor shows the index of the built-in manual instead, this means that there is no information window for the particular entry field.

ZOOM Function

The ZOOM function enables you to show each pointer meter of a basic mask in full-screen size on the monitor. This also applies to the OFFSET counter (normally only a numeric display). This ZOOM function is especially useful for adjustments. The following features are available:

- Automatic range switching or manual setting of any measurement range.
- Superimposition of a tolerance zone (permissible deviation from set value).
- Transfer of important entry fields of the basic mask into the ZOOM mask (permits alteration of a test parameter and at the same time observation of the effect of this on the pointer meter).

Selecting instrument

The ZOOM function is available in each of the three basic masks.

- 1) Tap the **ZOOM** softkey.
- 2) **MENU** + **SIGNAL** open a menu window offering the following menu items for you to cross (Fig. 2.15):

Menu Item	Function
AF	Callup of AF pointer meters (after closing menu window) with keys dBre1/VOLT and SINAD/DIST . AF power meter AF-Pwr and DC voltmeter DC-VOLT can also be zoomed (see appropriate sections in Chapter 5).
Mod/Demod	Callup of modulation meter MOD (RX mode) or DEMOD (TX mode). In DUPLEX mode callup of required modulation meter with RX MOD/MODGEN
RF Power	Callup of RF power meter PWR (not in RX mode)
offset	Callup of OFFSET counter (not in RX mode)

- 3) Locate the required menu item, cross it with **UNIT/SELECT** and close the menu window with **MENU**. If you have crossed AF, call up the required AF pointer meter.

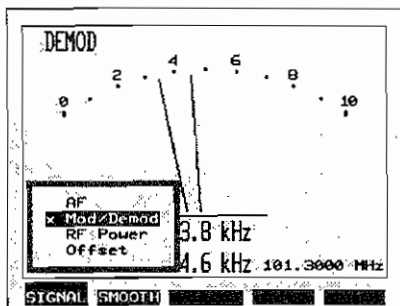

Fig. 2.15: The menu items of the SIGNAL menu determine what pointer meter is shown full-screen. In the background the dual-pointer display of the DEMOD meter can clearly be seen.

Setting pointer damping

The SMOOTH menu of the ZOOM mask enables you to set damping that is effective for all pointer meters:

- 1) Open the menu window with **[MENU]** + **[SMOOTH]** (Fig. 2.16).
- 2) In the entry field of the menu item Damping enter a numeric value between 0 (no pointer damping) and 99 (maximum pointer damping) and terminate the entry with **[ENTER]**.
- 3) Close the menu window with **[MENU]**.



No pointer damping is effective in automatic range switching (AUTO RANGE). Recommended figure for practical pointer damping: 10 to 15. At high values the settling time is very long.

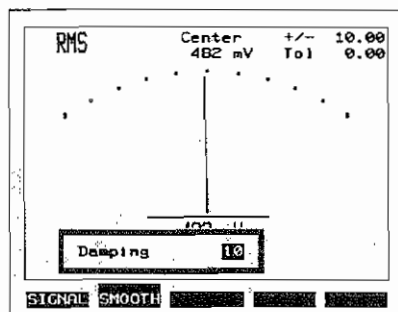

Fig. 2.16: A flickering pointer can be damped by entering a figure between 10 and 15 in the SMOOTH menu.

Selecting measurement range

Each ZOOM mask offers a choice between automatic range switching (AUTO RANGE) and manual setting of a measurement range (FIXED RANGE).

Automatic range switching

AUTO RANGE produces automatic range switching. The effect of this is as follows:

- The **AUTO RANGE** softkey is highlighted (acknowledgement).
- If test results are in the units dB, dBr or dBm, the scaling with the end-of-scale values will depend on the active measurement range (Fig. 2.17). In all other cases the scaling is 0 through 10, regardless of the active range (Fig. 2.18). For the meters RMS (RMS voltmeter) and PWR (RF power meter) the measured unit is as declared in the menus AF-PAR and RF-PAR of the basic masks.
- Because of the automatic range switching, the pointer will never "stick" at the end of the scale.
- Return to the basic mask with **TX**, **DUPL** or **RX**.

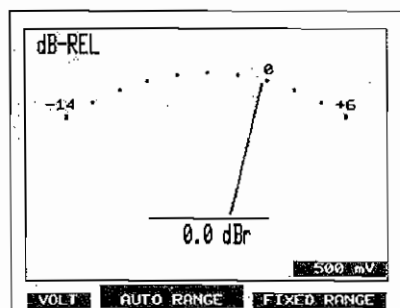

Fig. 2.17: Result measured with dB_r units. The end-of-scale values are updated automatically when the range is switched.

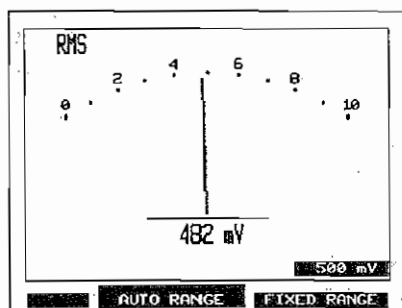

Fig. 2.18: Result measured with v units. Regardless of range switching, the scale of 0 to 10 will be preserved.

Defining measurement range

FIXED RANGE disables automatic switching of the measurement range. A defined measurement range will then be effective. This will either have been defined in a previous ZOOM call of the meter or you can define it now:

- 1) Locate field 1 with the cursor keys (Fig. 2.19) and enter a value that is to produce pointer deflection to center scale. In certain conditions (eg RF power measurement with units watt) the required dimension can be set with **UNIT/SELECT** (W, mW, μ W, nW) before confirming the entry. Whether or not **UNIT/SELECT** offers this function will depend on the called instrument and the unit of measurement and is best found out by trying the key.
- 2) Locate field 2 with the cursor keys and enter the end-of-scale value. This entry relates to the value for center scale (field 1) and its units.
Example: Entry in field 1 = 20.0 mV, entry in field 2 = 0.50 (mV).
Bottom of scale: 20.0 mV - 0.5 mV = 19.5 mV
Top of scale: 20.0 mV + 0.5 mV = 20.5 mV
The entry in field 2 in this case produces very high sensitivity (resolution) of the meter.

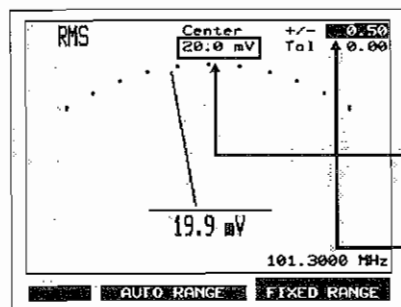

Fig. 2.19: The contents of the two marked entry fields decide what measurement range is valid in **FIXED RANGE** mode.

Field 1: defines the measured value that will produce pointer deflection to center scale.

Field 2: defines the upper and lower scale limits.

Superimposing tolerance zone

In the **FIXED RANGE** mode you can superimpose a tolerance zone on the scale arc symmetrically about the center-of-scale figure (Fig. 2.20). This simplifies adjustments when the measurement range is defined so that the set point is on center scale. The extent of the tolerance zone depends on the entry in the τ_{01} field. This value also relates to the value set for center scale.

Example: Adjustment with RMS meter to set point = $1\text{ V} \pm 0.1\text{ V}$ (Fig. 2.20). This produces for field 1 (as in Fig. 2.19) an entry of 1 V and for field 2 an entry of 0.5 for example (indication of measured values that deviate from the set point by up to $\pm 500\text{ mV}$). The entry in the τ_{01} field must be 0.1 (width of tolerance zone $\pm 0.1\text{ V}$).

Fig. 2.20: Here you can see immediately that the measured value is outside of the permitted tolerances.

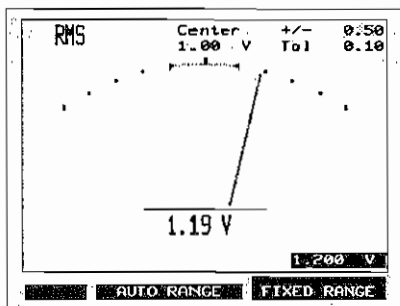

Adopting entry fields from basic mask

Keys **FREQ**, **LEVEL**, **MODFREQ** and **MOD** superimpose the corresponding entry field from the (concealed) basic mask in the bottom right corner of the **ZOOM** mask. A field that is adopted in this way has the same features as in the basic mask (eg selection of units, continuous alteration of the value with the spinwheel). So in the **ZOOM** mask you can also alter test parameters and at the same time observe the effect on the measured result.

Special functions

VOLT softkey

The ZOOM masks of the meters dB-Rel, DIST and SINAD offer the **(VOLT)** softkey (Fig. 2.21). This inserts a display field at bottom left that, in addition to the actual measured value, shows the voltage of the AF test signal (rms value). In this way it is possible, for example, to avoid overdriving/underdriving of the AF signal evaluation of the Communication Monitor, which might otherwise go unnoticed (permissible input voltages, see Appendix A).

PEAK softkey

The ZOOM mask of the DEMOD meter shows softkey **(PEAK)** (Fig. 2.22). When you tap this, a test phase is started that lasts until another key is struck. The DEMOD meter will then show the maximum modulation peak that has appeared during the test phase (peak-hold function, see also Chapter 5, "Modulation Meter DEMOD").

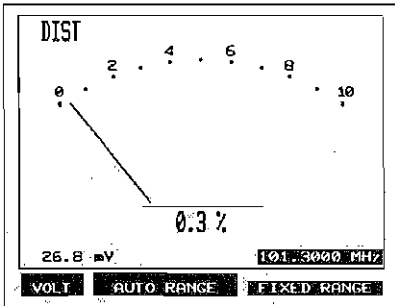

Fig. 2.21: In addition to the distortion, this ZOOM mask shows the voltage of the measured signal.

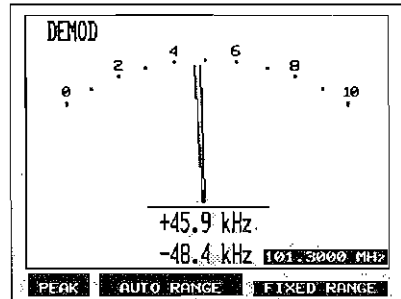

Fig. 2.22: This is how the ZOOM mask of the DEMOD meter indicates the maximum deviation peaks of an FM signal.

STORE/RECALL Function

STABILOCK 4015 stores up to nine complete instrument settings internally that can be recalled at any time. This STORE/RECALL function is useful in the following situations for example:

- Several users work with the same STABILOCK 4015. Each one will want to start using the Communication Monitor in the status he is familiar with without having to check all the menus.
- The STORE/RECALL function shortens the setup time considerably for measurements that are entirely different but repeatedly necessary.
- In the course of a series of measurements you want to call up previously defined instrument settings with a minimum of operator effort.

If nine internal setups are not enough, you can store extra ones on a memory card (see Chapter 8, "Saving and Loading Setups").

Storing instrument setting

- 1) Set the required operating status (call up mask, select menu items, couple sockets and AF generators, etc).
- 2) Tap **STORE/RECALL**. This produces a new function of the softkeys (Fig. 2.23).
- 3) Tap the **STORE** softkey and then one of the digit keys **[1]** through **[9]** on the numeric block (number of memory location). This restores the original function of the softkeys. The momentary operating status is now stored under the entered location number in memory. If another operating status was already stored there, this will have been overwritten! To simplify recall of the settings, it is advisable to create a list of the assignments in the memory locations.

Fig. 2.23: After you tap **STORE/RECALL**, the Communication Test Set is ready to store an instrument setting or to recall an instrument setting that was stored earlier.

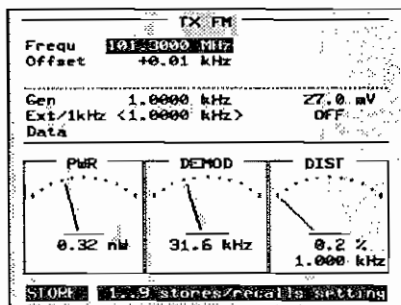

When you make a total reset or a firmware update, your stored setups are lost (cf Appendix D). So you should document important setups, and then you can easily reproduce them.

Recalling Instrument setting

- 1) Tap **STORE/RECALL**. This again produces the softkey functions shown in Fig. 2.23.
- 2) Now, instead of tapping the **STORE** softkey, enter the required location number in memory (1 through 9) on the numeric block. STABLOCK 4015 will then immediately adopt the settings stored under the particular number in memory.

Special NOTEBOOK function

The entry **STORE/RECALL** + **MENU** opens the so-called "Notebook" (close the notebook with **RX**, **TX** or **DUPL**). This is an automatically updated mask that gives you information about the last 98 key operations before the notebook is called up (Fig. 2.24). This can be useful if you want to reproduce exactly a previous sequence of entries. In this way you can detect errors in operation for instance. And if you want advice from SCHLUMBERGER about operating problems, your notebook recordings will help our support engineers to find the right solution.

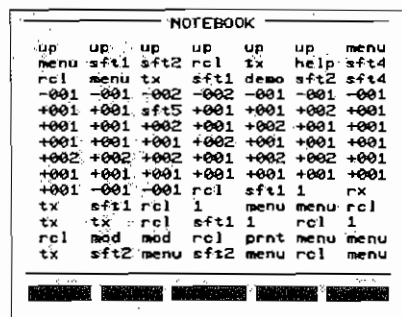

Fig. 2.24: The Notebook records all entries and provides you with reliable information about the last 98 key operations in the form of mnemonic abbreviations. Even a total reset will not delete these data. If a printer is available, this mask can be read out.

Special mnemonics

RES0	RESET + OFF (total reset)
±xxx	Spinwheel VAR turned xxx increments to right (+) or left (-).
-	Entry was made during a blockade of the digital signal processing and cannot be identified.
sckt	Selector key for RF sockets
modl	MOD
rcl	STORE/RECALL
sftx	Softkey x

**Front Panel
and
Rear Panel**

Front Panel

Open the foldout "Front Panel" in Appendix E. The following explanation of the front-panel elements refers to the numbers that are shown there.

- 1 TX SENS:** RF input socket of high sensitivity. Maximum permissible input power: 0.1 W. Upwards of $P > 0.25$ W the RF input stage will be destroyed! (see also Chapter 5, "Test Setup" and "Test Receiver").
- 2 RX HIGH:** RF output socket for high RF output levels up to $P_{\max} = +13$ dBm = 20 mW (see also Chapter 5, "Test Setup" and "Signal Generator").
- 3 Selector key:** Repeatedly tap this to couple the RF socket TX SENS, RX HIGH or RX/TX to the signal generator/test receiver of the 4015. The socket or sockets connected are shown by the four LEDs assigned to the selector key (see also Chapter 5, "Test Receiver", "Signal Generator" and Chapter 6, "DUPLEX Synthesizer").
- 4 RX/TX:** RF output/input socket. Maximum output level -60 dBm. Sustained input power maximum 50 W, briefly up to 150 W (see also Chapter 1, "Permissible RF Input Power" and Chapter 5, "Test Setup").
- 5 TX:** Calls up the basic TX mask for transmitter measurements (see also Chapter 5, "Test Receiver").
- 6 DUPL:** Calls up the basic DUPLEX mask if the optional DUPLEX Synthesizer is being used (transceiver measurements, see also Chapter 6, "DUPLEX Synthesizer").
- 7 RX:** Calls up the basic RX mask for receiver measurements (see also Chapter 5, "Signal Generator").
- 8 dBrel/VOLT:** Switchover key for calling up pointer meters dB-REL and RMS (see also Chapter 5, "Relative Level Meter dB-REL" and "RMS Meter/AF Frequency Counter"). The switchover keys dBrel/VOLT and SINAD/DIST are mutually canceling.
- 9 PHONE:** Output socket for headphones. Recommended load impedance: at least 25 Ω . When headphones are connected, the internal loudspeaker is disabled.
- 10 Volume control** for headphones and integrated loudspeaker.
- 11 SINAD/DIST:** Switchover key for calling up pointer meters SINAD and DIST (see also Chapter 5, "SINAD Meter" and "Distortion-factor Meter DIST"). The switchover keys SINAD/DIST and dBrel/VOLT are mutually canceling.

- 12 **FILTER:** The LEDs light up if filters are cut into the AF test path (see also Chapter 4, "FILTER").
- 13 **VOLTM:** Unbalanced input socket for measuring external AF signals. The socket is connected to the AF instruments with the **VOLTM** key (see also Chapter 5, "AF Signal Analysis"). Normally AC coupling is used; but DC coupling for DC voltage measurements with the DC-VOLT meter.
- 14 **VOLTM:** Connects the signal applied to the VOLTM socket to the AF instruments. The **VOLTM** key is mutually canceling with the keys **DEMODO** and **RX MOD/MODGEN** (see also Chapter 5, "AF Signal Analysis").
- 15 **DEMODO:** Connects the demodulated RF received signal to the AF instruments. The **DEMODO** key is mutually canceling with the keys **VOLTM** and **RX MOD/MODGEN**. In RX mode **DEMODO** is disabled because there is no demodulated signal available (see also Chapter 5, "AF Signal Analysis").
- 16 **DEMODO:** Unbalanced DC-coupled output socket for the demodulated RF received signal (shortcircuit-proof). This output is always coupled in TX and DUPLEX modes regardless of the **DEMODO** key. $V_{out} = 1 V_p$ at 10 kHz or 10 rad deviation; $V_{out} = 0$ to 5 V for AM (depending on modulation depth and RF received level).
- 17 **RX MOD/MODGEN:** Couples the signal of the internal AF generators (including the AF signal applied to the EXT MOD socket) to the AF instruments. Depending on the mode, this will permit the following kinds of analysis (see also Chapter 5, "AF Signal Analysis"):
RX mode: Examination of the signal that feeds the modulator of the signal generator.
TX mode: Examination of the AF signal that appears on the MODGEN output socket (modulation signal for the microphone input on the test item).
DUPLEX mode: By repeatedly tapping the key, you can examine the modulation signal (green LED lights up) or the signal output on the MODGEN socket (red LED lights up).
The **RX MOD/MODGEN** key is mutually canceling with the keys **VOLTM** and **DEMODO**. The **RX MOD/MODGEN** key has *no* effect on the feeding of the signal generator with the modulation signal.
- 18 **MODGEN:** Unbalanced AC-coupled output socket (shortcircuit-proof) for the signal of the internal AF generators (see also Chapter 5, "AF Generators"). In RX mode MODGEN will not have any signal. In TX and DUPLEX modes the signal is available to those AF generators that are connected to the MODGEN socket. Connect with **GEN**, **DATA** and **EXTMOD**. If the red LED lights up above these keys, the particular generator is connected to the MODGEN socket.

- 19 **GEN**: Switches the internal AF generator GEN on/off. The signal path is switched at the same time according to the mode (see also Chapter 5, "Operating generator GEN");
RX mode: The AF signal feeds the modulator of the signal generator (green LED lights up).
TX mode: The AF signal is output on the MODGEN socket (red LED lights up).
DUPLEX mode: By repeatedly tapping the key, you can connect to the signal generator (green LED lights up) or to the MODGEN socket (red LED lights up).
If both LEDs are dark, the generator is switched off.
- 20 **DATA**: Switches the AF generator DATA (part of the optional DATA Module) on/off. The signal path is switched as for **GEN** (number 19).
- 21 **EXT MOD**: Unbalanced AF input socket for the external modulation signal. AC/DC FM coupling is selectable by menu MOD-PAR (modulation sensitivity: see Chapter 5, "Applying external AF signal" and Appendix A, section "RX modulation").
- 22 **EXTMOD**: Switches the internal 1-kHz generator on/off or connects a modulation signal fed in on the EXT MOD socket to the signal path of the AF generators (selectable by menu MOD-PAR, see also Chapter 5, "Operating 1-kHz generator" and "Applying external AF signal"). The signal path is switched as for **GEN** (number 19).
- 23 **1 kHz**: The LED lights up if the 1-kHz generator is switched on with the **EXTMOD** key. A signal applied to the EXT MOD socket has no effect as long as this LED is illuminated.
- 24 **BATT/OFF/LINE**: Power switch for selecting internal/external battery or line (see also Chapter 1, "Powering on").
- 25 **HELP**: Produces a window on the monitor with further information about operating procedure (see also Chapter 2, "HELP Function").
- 26 **REMOTE**: This LED lights up when STABLOCK 4015 is being remotely controlled and manual entries have no effect (exception: **RESET** key and power switch).
- 27 **PRINT**: Produces readout of the current screen contents to a printer. Selection of the printer driver and printer interface (option) in the PRINT menu (see also Chapter 4, "PRINT").
- 28 **RESET**: Produces a reset of the microcomputer (eliminates input blockades). All settings are preserved. A total reset is possible in conjunction with the **OFF** key (resetting as ex works, see Chapter 1, "Total reset").

- 29 **Cursor block:** As long as no entry field is opened, any entry field of a mask can be located with the four cursor keys. If an entry field is opened (the cursor in the field flashes), the cursor keys pointing left and right will move the cursor within the field. In menu windows you can locate a menu item with the cursor keys (see also Chapter 1, "Working with menus").
- 30 **MEMORY:** Calls up the memory mask. This permits callup of the AUTORUN function (program-controlled measurements) and enables the storage/recall of complete instrument settings on a memory card (see also Chapter 8 and 9).
- 31 **VAR:** Multifunction spinwheel for continuous alteration of numeric values in entry fields and for selecting menu items in menu windows (see also Chapter 2).
- 32 **MEMCARD:** Slot for memory cards (see also Chapter 8).
- 33 **-** and **+**: Sign keys (eg for level entry -60 dBm). If the **Frequ** entry field (tuned frequency of the signal generator) is marked by the cursor bar in the basic RX and DUPLEX mask, **-** or **+** will automatically open the **offset** entry field (for intentional mistuning).
- 34 **UNIT/SELECT:** Calls up for level entry fields (eg **Lev** field) and the entry field for the tuned RF frequency (**Frequ** field) a screen window for selecting the units (eg mV or dBm, see also Chapter 2). Within menu windows you cross (select) menu items with **UNIT/SELECT** or delete a previously set cross (see also Chapter 1, "Working with menus").
- 35 **ENTER:** Numeric entries must *always* be terminated with **ENTER** (see also Chapter 2).
- 36 **OFF:** Switches off the signal generator if the cursor bar is marking the **Lev** entry field of the RX or DUPLEX mask. If, in addition to the **OFF** key, the **RESET** key is briefly pressed, all data stored in RAM will be cleared (including stored programs and setups). STABLOCK 4015 is thus reset as it was ex works (total reset).
- 37 **.** or **F/#:** decimal-point key. In certain masks (selective-call systems, cellular networks, memory mask), as required, not the decimal point but the hex character "F", the letter "F" or the dialing sign "#" is entered.
- 38 **Numeric block**

- 39 **FREQ**: Prepares the Freq entry field (RF frequency) for a numeric entry in all basic masks.
- 40 **LEVEL**: Prepares the Lev entry field (RF output level) for a numeric entry in the basic RX and DUPLEX mask.
- 41 **MODFREQ**: Prepares the frequency entry field of the AF generator GEN in line Gen for a numeric entry in all basic masks.
- 42 **MOD**: Prepares the level entry field of the AF generator GEN in line Gen for a numeric entry. In the basic RX mask no voltage value is entered (as in the basic TX mask), but instead the required modulation depth/deviation of the signal generator. In the basic DUPLEX mask it depends on the switched signal path of the AF generator GEN (see number 19) whether a voltage or modulation value is to be entered (see also Chapter 5, "Signal Generator" and "Operating generator GEN").
- 43 **STORE/RECALL**: Stores complete instrument settings (setups) in the RAM of the Communication Monitor or recalls ready stored setups (see also Chapter 2, "STORE/RECALL Function").
- 44 **MENU**: Interrupts measurements and opens menu windows for selecting/setting test parameters (see also Chapter 1, "Working with menus").
- 45 **Softkeys**: These five keys are assigned functions depending on the particular mode of STABLOCK 4015. The momentarily available functions are shown by the monitor in the bottom line.

Rear Panel

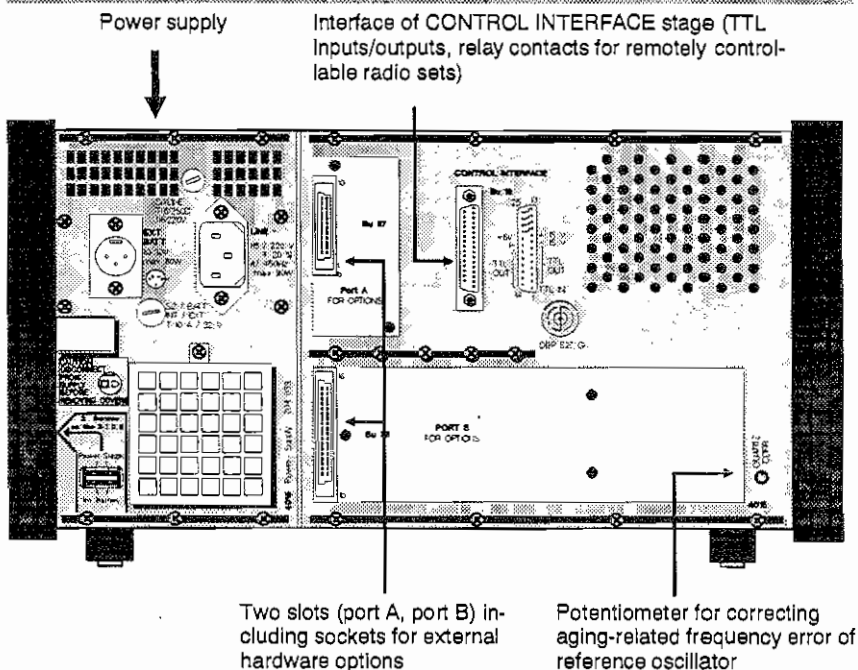

Power supply

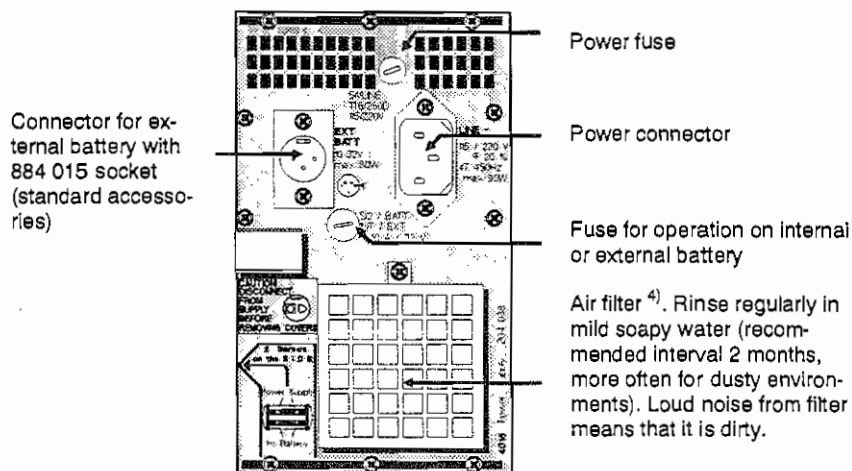

Notes on line and battery power: see Chapter 1.

Removing power supply

- 1) Switch off STABLOCK 4015 and withdraw the power cable.
- 2) Undo the screws on the black strips on the rear of the power supply (six screws).
- 3) Undo the two Phillips screws in the lefthand side panel (seen from the rear) of STABLOCK 4015 and pull out the power supply.



When replacing the power supply, do not forget to tighten the two Phillips screws on the side again (thermal coupling of power supply with chassis).

Port A

Slot and connector (Bu 27) for external hardware option "External Synchronization (10 MHz)" (synchronization of the internal reference oscillator with an external reference signal). For more about this option, see Chapter 11.

Port B

Slot and connector (Bu 26) for external hardware option "Interface Centronics/RS-232/Keyboard" or "Interface IEEE-488/RS-232/Keyboard" (interfaces for remote control of the Communication Monitor and for connecting a printer and an ASCII keyboard). For more about these options, see Chapter 11.



Always leave the metalized caps of sockets Bu 26 and Bu 27 in place if no option is fitted (shielding against radiated interference).

CONTROL INTERFACE (Bu 18)

Different control functions can be executed on the standard CONTROL INTERFACE (handling see Chapter 4, "RELAYS"). The interface Bu 18 (25-way sub-min D) offers the following inputs/outputs:

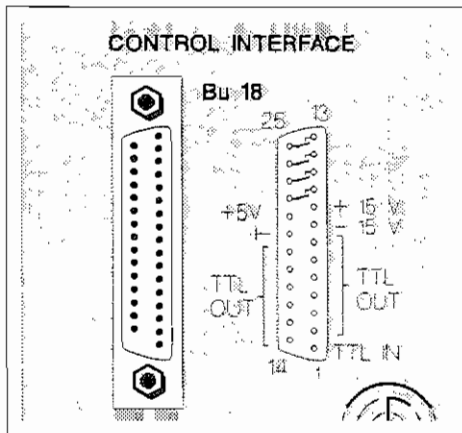

4 relays

Each with 1 x ON. Contact loading 0.5 A/30 V. The relays are bistable (switched contact position is maintained in the absence of current).

Relay	RLY1	RLY2	RLY3	RLY4
Pin no.	13 and 25	12 and 24	11 and 23	10 and 22

Relays pinning (see also Chapter 4, "RELAYS")

±15 V/+5 V

Shortcircuit-proof voltage supply for external circuits (I_{max} is 100 mA in each case).

12 TTL outputs

Fan-out = 3 standard TTL

$V \leq +0.5 \text{ V} = \text{L}$

$V \geq +1.5 \text{ V} = \text{H}$

TTL output no.	12	11	10	9	8	7	6	5	4	3	2	1
Pin no.	4	5	6	7	14	15	16	17	18	19	2	3

TTL pinning (see also Chapter 4, "RELAYS")

1 TTL input

$V \leq +0.5 \text{ V} = \text{L}$

$V \geq +1.5 \text{ V} = \text{H}$

Input impedance approx. 100 k Ω

Voltage strength $\approx 30 \text{ V}$

Use: trigger input for oscilloscope

Adjustment of internal reference oscillator

Frequency drift of the internal 20-MHz reference oscillator caused by aging can be corrected with the "QUARTZ CORR" potentiometer:

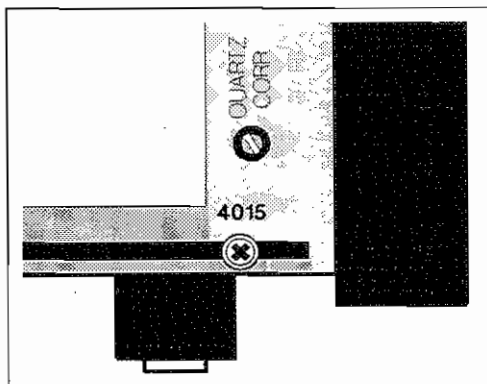

1. Apply a precise reference signal of as high a frequency as possible ($f > 500$ MHz) to the socket RX/TX or TX SENS (eg signal of a precision-off-set TV transmitter).
2. Call up the basic TX mask and enter the frequency of the applied reference signal in the `Frequ` field.
3. The `Offset` field now shows the frequency error of the internal reference oscillator. Alter the adjusting potentiometer until the `Offset` field indicates zero.



Only adjust the internal reference oscillator when the Communication Monitor is warmed up.

(

(

(

(

Menus of Basic Masks

(

(

Introduction

Each of the three basic masks RX, TX and DUPLEX (option) offers you access to twelve menu windows. The declarations that you make in one of these menu windows – with a few exceptions – will always apply. So it is quite sufficient, if you start in the basic RX mask for example, to cross the FM item just once in the MOD-PAR menu. FM modulation/demodulation will then also apply for all other modes of working like TX, DUPLEX or the spectrum analyzer (but for DUPLEX mode you can still declare a type of demodulation that differs from the modulation).

An exception is that of the system programs for testing radiotelephones or radio-data sets (see Chapter 10): these do not go by the current menu items, instead they automatically select all relevant menu items that are required for a particular test. At the end of a test, when you return to a basic mask, these new menu items then apply (which is useful if the usual RF/AF measurements are carried out following a signalling test).



In what follows, the permissible entry for each menu item is given in abbreviated form (eg cross or cross/delete). For precise explanation of the entries, refer to the section "Working with menus" in Chapter 1.

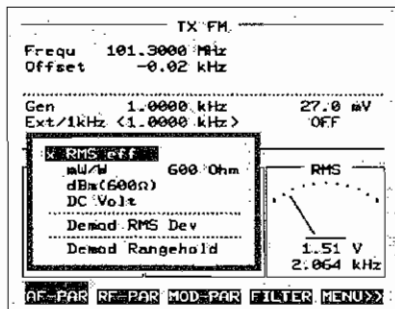

Fig. 4.1: Menu AF-PAR governs RMS, AF-Pwr, DC-VOLT and DEMOD meters.

Calling up RMS, AF-Pwr or DC-VOLT meter

- | | |
|-------------------------|--|
| RMS eff | Effect: Inserts the RMS pointer meter in the basic masks (RMS voltmeter/AF frequency counter).
Entries: Cross.
Application: See Chapter 5, "RMS Meter/AF Frequency Counter". |
| mW/W xxx Ohm | Effect: Inserts the AF-Pwr meter in the basic masks (AF power meter). The result display is in units of watts referred to a definable load resistance.
Entries: Cross and enter the value of load resistance in the xxx Ohm field.
Application: See Chapter 5, "AF Power Meter AF-Pwr".
If the defined and the actual load resistance do not correspond → measuring error. |
| dBm(600Ω) | Effect: Inserts the AF-Pwr meter in the basic masks (AF power meter). The result display is in units of dBm referred to 600 Ω load resistance.
Entries: Cross.
Application: See Chapter 5, "AF Power Meter AF-Pwr". |
| DC volt | Effect: Inserts the DC-VOLT meter in the basic masks (DC voltmeter).
Entries: Cross.
Application: See Chapter 5, "DC Voltmeter DC-VOLT". |

Special functions for modulation measurements

Demod RMS Dev **Status:** Not selectable in RX mode.
Effect: RMS-weighted measurement of frequency deviation. From the result the peak FM deviation is calculated and shown on the RMS meter (special function).
Entries: Cross/delete.
Application: Deviation measurement on a very weak or heavily disturbed receive signal (see also Chapter 5, "Modulation Meter DEMOD").

Demod Rangehold **Status:** Not selectable in RX mode.
Effect: Freezes the gain figures in the entire RF/AF signal path of the test receiver (no more automatic range switching). The overall gain is frozen that was effective when the menu window was opened. An RNG entry in the header of the DEMOD pointer meter acknowledges selection of this menu item.
Entries: Cross/delete.
Application: Elimination of disturbing effects caused by the automatic range switching (abrupt volume fluctuations when listening in to stations, incorrect analysis of AM tone sequences).



When the overall gain is frozen, do *not* increase the modulation of the receive signal. This can overdrive the test receiver and lead to incorrect results on the DEMOD meter (limiting).

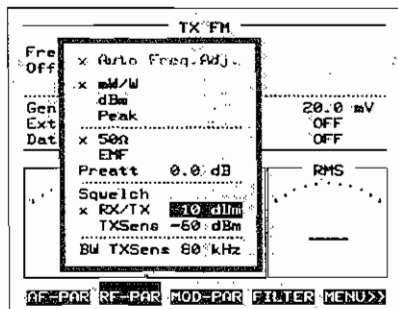

Fig. 4.2: Menu RF-PAR governs RF counter, PWR meter, signal generator and test receiver.

Activating automatic tuning

Auto Freq. Adj. **Status:** Not selectable in RX mode. In the other modes only if the RX/TX input socket is connected.

Effect: As soon as the RF power applied to the RX/TX socket exceeds approx. +10 dBm, the test receiver tunes itself automatically to the test signal. The **Freq** entry field becomes a display field and reports the frequency of the test signal (more in Chapter 5, "Test Receiver").

Entries: Cross/delete.

Application: Fast tuning, also to unknown test signals. Simple selective power measurement because there is no manual tuning.



When you are measuring harmonics, the **Auto Freq. Adj.** menu item must not be crossed because otherwise tuning will automatically be to the fundamental.

Setting PWR meter

mW/W **Status:** Not selectable in RX mode.

Effect: The measured power is shown in units of watts (see also **Peak** menu item).

Entries: Cross.

Application: See Chapter 5, "RF Power Meter PWR".

dBm **Status:** Not selectable in RX mode.

Effect: The measured power is shown in units of dBm (see also **Peak** menu item).

Entries: Cross.

Application: See Chapter 5, "RF Power Meter PWR".

Peak	<p>Status: Not selectable in RX mode.</p> <p>Effect: Selection of the peak/average measurement mode. If the menu item is <i>not</i> crossed, the PWR meter measures the average of the applied RF power, regardless of the demodulation. If the menu item is crossed, the peak power is <i>only</i> measured for AM demodulation (for the other two types of demodulation the measurement is always average, regardless of whether the Peak menu item is crossed or not).</p> <p>Entries: Cross/delete.</p> <p>Application: See Chapter 5, "RF Power Meter PWR".</p>
-------------	--

Defining terminal/source voltage

50Ω	<p>Effect: The figure in the Lev/50Ω field (RX or DUPLEX mask) defines the terminal voltage of the signal generator into 50 Ω load.</p> <p>Entries: Cross.</p> <p>Application: See Chapter 5, "Signal Generator".</p>
EMF	<p>Effect: The figure in the Lev/EMF field (RX or DUPLEX mask) defines the source voltage of the signal generator.</p> <p>Entries: Cross.</p> <p>Application: See Chapter 5, "Signal Generator".</p>

Compensating external preattenuation

Preatt xx dB	<p>Effect: Compensates for external preattenuation (cable attenuation, attenuator pad) on the RX/TX socket. This means a corresponding increase in the level of the signal generator and correction of the measured figure for RF power. The entry ATT following the Lev field and in the header of the PWR meter draws your attention to this compensation.</p> <p>Entries: Enter the value of external preattenuation in the xx dB field.</p> <p>Application: See Chapter 5, "Signal Generator" and "RF Power Meter PWR".</p> <p>If the compensation value and the external preattenuation do not correspond ⇒ measuring error.</p>
---------------------	---



Activating squelch

RX/TX xx dBm **Status:** Not selectable in RX mode.
Effect: Crossing activates the squelch on the RX/TX socket.
Entries: Cross/delete; enter the response level of the squelch in the xx dBm field.
Application: Disables AF analysis as soon as the received RF level on the RX/TX socket goes below the squelch response level.

TXSens xx dBm **Status:** Not selectable in RX mode.
Effect: Crossing activates the squelch on the TX SENS socket.
Entries: Cross/delete; enter the response level of the squelch in the xx dBm field.
Application: Disables AF analysis as soon as the received RF level on the TX SENS socket goes below the squelch response level.



Squelch hysteresis = approx. 3 dB (for AM 3 to 9 dB, depending on modulation depth 100 to 0%).
Example: squelch response level = -60 dBm; for FM signals < -60 dBm the squelch disables; from signals of ≥ -57 dBm onwards there is again AF analysis. If the squelch response level is set too high, no AF measurements will be possible even if the received RF level is sufficient (no aural monitoring of the demodulated signal).

Selecting IF bandwidth

BW TXSens xx kHz **Effect:** Selects the IF bandwidth of the test receiver. The selected figure only applies if the TX SENS socket is connected and an FM or Φ M signal is demodulated. In all other cases: IF bandwidth b = 80 kHz (see also Chapter 5, "Test Receiver").

Entries: Strike **UNIT/SELECT** and select from the values that are offered.

Application: Selective measurements in dense channel occupancy.



If too small an IF bandwidth limits the modulation spectrum, there will be distortion of the demodulated signal (measuring error).

MOD-PAR

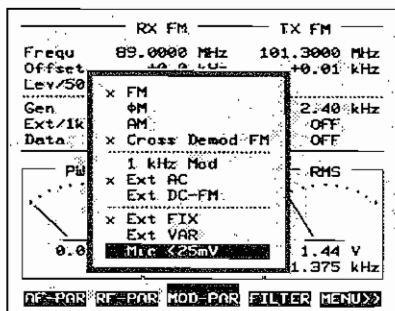

Fig. 4.3: Menu MOD-PAR governs modulation parameters of signal generator.

Selecting modulation/demodulation

FM **Effect:** Modulation/demodulation = FM.
Entries: Cross.

Φ M **Effect:** Modulation/demodulation = Φ M.
Entries: Cross.

AM **Effect:** Modulation/demodulation = AM.
Entries: Cross.

Cross Demod xx **Status:** Only selectable in DUPLEX mode.

Effect: In DUPLEX mode a type of demodulation is effective that differs from the modulation (entry in xx field).

Entries: Cross/delete. If the menu item is crossed, the entry in the xx field determines the type of demodulation (to set the modulation, cross menu item FM, Φ M or AM).

Setting different demodulation: locate the cursor on the xx field (Cross Demod must be crossed), strike **UNIT/SELECT** and select the required entry (FM, Φ M or AM) from the list that is offered.

Application: Special radio systems.

When the basic RX or TX mask is called up, the entry in the xx field is altered automatically so that modulation and demodulation again correspond.



Activating 1-kHz generator

- 1 kHz Mod** **Effect:** If you cross this menu item, you can switch on the internal 1-kHz generator with the **EXTMOD** key (see also Chapter 5, "Operating 1-kHz generator").
Entries: Cross.
Application: Superimposed modulation, eg with the variable AF generator GEN.
-  If this menu item is crossed, an AF signal applied to the EXT MOD socket will have *no* effect (LED "1 kHz" lights up).

Working with external modulation signal

- Ext AC** **Effect:** An AF signal applied to the EXT MOD socket is AC-coupled.
Entries: Cross.
Application: Modulation of the signal generator with an external modulation signal (modulation sensitivity: see menu items Ext FIX and Ext VAR).
- Ext DC-FM** **Status:** Only selectable if the FM menu item is crossed first.
Effect: A modulation signal applied to the EXT MOD socket is DC-coupled (see Chapter 5, "Applying external AF signal").
Entries: Cross.
Application: Distortion-free modulation of the signal generator with an external NRZ (Non Return to Zero) signal or extremely low-frequency signal (modulation sensitivity: see menu items Ext FIX and Ext VAR).
- Ext FIX** **Status:** Only selectable if the Ext AC or Ext DC-FM menu item is crossed first.
Effect: The modulation sensitivity of the signal generator for an external modulation signal (EXT MOD socket) is set as ex works (see Appendix A). In addition the Mic <25mV menu item is offered. Crossing this will increase modulation sensitivity by a factor of 100; see Chapter 5, "Applying external AF signal").
Entries: Cross.
Application: Modulation of the signal generator with an external modulation signal (the level setting of the external signal produces the required modulation).
-

Ext VAR

Status: Only selectable if the Ext AC or Ext DC-FM menu item is crossed first.

Effect: Sets the modulation sensitivity of the signal generator for an external modulation signal. For this the 1kHz ← xx mVp menu item is offered (in RX mode) or the 100mV ← xx mV menu item (in TX mode). In DUPLEX mode there is a choice between the two menu items with **EXTMOD**. Both menu items contain an entry field for a voltage figure.

Entries: Cross and locate the entry field.

a) An entry in the xx mVp field defines the modulation sensitivity of the signal generator for the AF signal applied to the EXT MOD socket.

b) An entry in the xx mV field defines the gain/attenuation for the signal path from the EXT MOD input socket to the MODGEN output socket (see also Chapter 5, "Applying external AF signal").

Application: a) Matching the modulation sensitivity of the signal generator to an external modulation signal (an external signal permits no level setting).

b) AF amplifier with definable gain, eg for matching the level of an external modulation-signal source to an insensitive microphone input.

Mic <25mV

Status: Only visible if the Ext FIX menu item has been crossed.

Effect: Increases the standard modulation sensitivity of the signal generator by a factor of 100 (see Ext FIX).

Entries: Cross/delete.

Application: Connect the microphone (ordering code: 248 147) offered as a recommended accessory to the EXT MOD input socket (see also Chapter 5, "Applying external AF signal").

1kHz ← xx mVp
or
100mV ← xx mV

See Ext VAR menu item.

FILTER

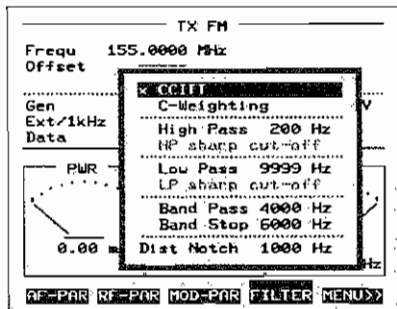

Fig. 4.4: Menu FILTER permits connection of various AF filters into AF signal path of Communication Monitor.

Activating weighting filter

CCITT

Effect: Cuts a CCITT filter into the signal path to the AF meters (acknowledgement: LED "CCITT" lights up).

Entries: Cross/delete.

Application: Aurally compensated weighting of measured results to CCITT standard P53A.



An incorrectly cut in weighting filter produces the risk of incorrect measurement (observe LED).

C-Weighting

Status: When you cross C-weighting, other menu items that may not be active at the same time are 50% intensity modulated (disabled).

Effect: Cuts a C-weighting filter into the signal path to the AF meters (acknowledgement: LED "CCITT" lights up). But no effect on the scope.

Entries: Cross/delete.

Application: Aurally compensated weighting of measured results to IEEE standard 743-1984.

Activating highpass filter

High Pass xxxx Hz **Status:** Only selectable if the C-weighting menu item is not crossed. A cross in front of Band Stop or Band Pass is deleted automatically, because simultaneous operation with a highpass filter is not permissible.

Effect: Cuts a highpass filter into the signal path to the AF meters (acknowledgement: LED "LP/HP" lights up). But *no* effect on the instruments DIST, SINAD and scope. Filter type: 2nd-order Butterworth (typical cutoff 12 dB/octave).

Entries: Cross/delete; enter the 3-dB cutoff frequency in the xxxx Hz field (200 to 9999 Hz).

Application: Separation of subaudio tone from useful signal for measuring useful signal (tests on selective-call radios).

HP sharp cut-off **Effect:** If you cross this menu item in addition to High Pass xxxx Hz, the cutoff of the highpass filter increases to 24 dB/octave.

Entries: Cross/delete.

Activating lowpass filter

Low Pass xxxx Hz **Status:** Only selectable if the C-weighting menu item is not crossed. A cross in front of Band Stop or Band Pass is deleted automatically, because simultaneous operation with a lowpass filter is not permissible.

Effect: Cuts a lowpass filter into the signal path to the AF meters (acknowledgement: LED "LP/HP" lights up). But *no* effect on the instruments DIST, SINAD and scope. Filter type: 2nd-order Butterworth (typical cutoff 12 dB/octave).

Entries: Cross/delete; enter the 3-dB cutoff frequency in the xxxx Hz field (200 to 9999 Hz).

Application: Separation of subaudio tone from useful signal for measuring subaudio tone. When testing radiotelephones for separation of SAT (supervisory audio tone, pilot tone) from useful signal and measuring useful signal.

LP sharp cut-off **Effect:** If you cross this menu item in addition to Low Pass xxxx Hz, the cutoff of the lowpass filter increases to 24 dB/octave.

Entries: Cross/delete.

Combining highpass and lowpass filters

The menu items for the highpass and lowpass filters can both be crossed at the same time (although only without sharp cut-off). Whether a bandpass or a bandstop characteristic results from this will depend on the cutoff frequencies (cutoff approx. 12 dB/octave). The smaller the difference between the two cutoff frequencies, the greater is the passband attenuation ($a_{\max} = 6 \text{ dB at } \Delta f = 0 \text{ Hz}$).

Example:

High Pass 2000 Hz + Low Pass 3000 Hz = 2–3 kHz bandpass

High Pass 3000 Hz + Low Pass 2000 Hz = 2–3 kHz bandstop

Activating bandpass/bandstop

Band Pass xxxx Hz **Status:** Only selectable if the C-weighting menu item is not crossed. Crosses in front of Band Stop, High Pass and Low Pass are deleted automatically, because simultaneous operation with a bandpass filter is not permissible. **Effect:** Cuts the bandpass filter into the signal path to the AF meters (acknowledgement: LED "LP/HP" lights up). But *no* effect on the instruments DIST, SINAD and scope. Cutoff = typ. 48 dB/octave; 3-dB bandwidth = $\pm 8\%$ of center frequency, passband attenuation at center frequency = 0 dB. **Entries:** Cross/delete; enter the center frequency in the xxxx Hz field (50 to 9999 Hz). **Application:** Filters a useful signal (eg SAT) out of a composite signal for further processing.

Band Stop xxxx Hz **Status:** Only selectable if the C-weighting menu item is not crossed. Crosses in front of Band Pass, High Pass and Low Pass are deleted automatically, because simultaneous operation with a bandstop filter is not permissible. **Effect:** Cuts the bandstop filter into the signal path to the AF meters (acknowledgement: LED "LP/HP" lights up). But *no* effect on the instruments DIST, SINAD and scope. Cutoff = typ. 24 dB/octave; 3-dB bandwidth = $\pm 13\%$ of center frequency, stopband attenuation at center frequency = typ. 40 dB. **Entries:** Cross/delete; enter the 3-dB cutoff frequency in the xxxx Hz field (50 to 9999 Hz). **Application:** Stops a certain component of a composite signal (eg SAT) for further processing of the useful signal.

Setting DIST test frequency

Dist Notch **xxxx Hz** **Effect:** Sets the test frequency for measuring distortion factor with the DIST meter. This menu item has no effect on distortion-factor measurement with the SINAD meter (test frequency = 1 kHz).

Entries: Enter the test frequency in the **xxxx Hz** field (200 to 5000 Hz. The specification applies up to 2000 Hz; at larger values the measuring error increases because there are more harmonics outside of the 10-kHz test bandwidth.).

Application: Distortion-factor measurements at different test frequencies (see also Chapter 5, "Distortion-factor Meter DIST").



If the signal frequency and the set test frequency do not correspond in distortion-factor measurement ⇒ measuring error.

Rules for AF filters

- All filters apart from the CCITT filter are simulated by digital signal processing (software filters). Activated software filters (especially C-weighting) reduce the cycle rate of the signal processing (effect: slower reaction to entries by spinwheel, longer testing time).
- The following schematic shows what filters can be active *simultaneously*:

CCITT	and	Highpass (without sharp cut-off)	and	Lowpass (without sharp cut-off)
CCITT	and	Highpass (with sharp cut-off)	or	Lowpass (with sharp cut-off)
CCITT	and	Bandpass	or	Bandstop
C-Weighting	No combination permissible with other filters			

- No AF filter affects acoustic signal reproduction and the signal on the DEMOD output.
- All AF filters, as shown by the following **Table**, only affect the AF meters. Only the bandpass filter affects the AF counter (SAT measurement).
- Measuring errors can result from incorrectly connected filters. This is why the LEDs "CCITT" and "LP/HP" point out activated (crossed) filters. The LEDs only light up if the particular filter is actually effective. If the lowpass filter is active for instance, the LED "LP/HP" will go off as soon as the DC voltmeter is called up instead of the RMS meter. The LED "HP/LP" will also go off if the DIST or SINAD meter is called up in addition to the RMS meter in the basic RX mask. In this case the RMS meter too will receive *no* filtered signal.

Filter	Test instruments				
	RMS, dB-REL AF-Pwr, RMS-Dev*)	AF counter	SINAD DIST	Scope	DC-VOLT
CCITT	✘	-	✘	✘	-
C-Weighting	✘	-	✘	-	-
High Pass	✘	-	-	-	-
Low Pass	✘	-	-	-	-
Band Pass	✘	✘	-	-	-
Band Stop	✘	-	-	-	-

*) Deviation measurement with RMS meter, see Chapter 5, "Modulation Meter DEMOD"

The table shows whether a filter affects an instrument (✘) or not (-).

PRINT

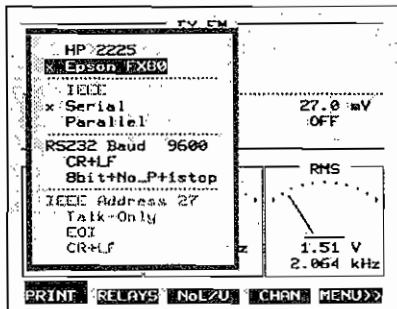

Fig. 4.5: Menu PRINT is for selecting input/output interface and setting transmission parameters.

Selecting printer

HP 2225

Effect: Matches the data format to the ink-jet printer HP 2225 (recommended accessory, ordering code: 896 092) in print output.

Entries: Cross. Depending on the printer interface that is used, you also have to cross one of the menu items IEEE or Serial.

Application: Prints the current screen contents (eg mask with test results) or outputs an AUTORUN test report (see also Chapter 9).

Epson FX80

Effect: Matches the data format to the printer FX80 or printers that are compatible with it.

Entries: Cross. Depending on the printer interface that is used, you also have to cross one of the menu items IEEE, Serial or Parallel.

Application: Prints the current screen contents (eg mask with test results) or outputs an AUTORUN test report (see also Chapter 9).

Selecting interface

IEEE

Status: You can only reach this if the hardware option "Interface IEEE-Bus/RS-232/Keyboard" is installed.

Effect: Activates the IEEE-488 interface.

Entries: Cross.

Application: Remote control of STABILOCK 4015 and querying of test results with an external computer (controller) or print output.

- Serial** **Status:** You can only reach this if the hardware option "Interface IEEE-Bus/RS-232/Keyboard" or "Interface Centronics/RS-232/Keyboard" is installed.
Effect: Activates the RS-232-C interface.
Entries: Cross.
Application: Serial data output (eg for initializing a radio set) or print output.
- Parallel** **Status:** You can only reach this if the hardware option "Interface Centronics/RS-232/Keyboard" is installed.
Effect: Activates the Centronics interface.
Entries: Cross.
Application: Print output.

Setting RS-232 transmission protocol

- RS232 Baud xxxx** **Status:** You can only reach this and the following two menu items if one of the two interfaces is installed.
Effect: Sets the baud rate for data transfer on the RS-232-C interface.
Entries: Strike **UNIT/SELECT** and select the required baud rate from the list that is presented (110 Baud to 9600 Baud).
Application: Harmonizes the baud rate of the devices involved in serial data transfer (eg 4015/printer).
- CR+LF**
(for example) **Effect:** Automatically inserts a selectable control character in the serial data stream at the end of each character string (text line) (note: only applies to data output with the PRINT and LIST commands in AUTORUN mode. **PRINT** and the IEEE command **HARDCopy** cause output in the *graphics format* of the selected printer).
Entries: Strike **UNIT/SELECT** and select the required control character from the list that is presented (CR+LF, CR, LF, EOT or ETX).
Application: Matching to the present setting of the printer. If the printer automatically only executes a carriage return (CR) at the end of a character string for example, control character LF will be necessary for the line feed.

8bit+No_P+1stop (for example) **Effect:** Defines the transmission format of serial data output.
Entries: Strike `UNIT/SELECT` and select the required transmission format from the list that is presented. The list contains all combinations for the following transmission parameters: 7 or 8 data bits, even parity (Even), odd parity (Odd), no parity check (No_P), 1 or 2 stop bits.
Application: Harmonizes the transmission format of the devices involved in serial data transfer (eg 4015/printer).

Configuring IEEE interface

IEEE Address xx **Status:** You can only reach this menu item and the following ones if the hardware option "Interface IEEE-Bus/RS-232/Keyboard" is installed.

Effect: Defines the IEEE address of STABLOCK 4015.

Entries: Enter the declared address in the xx field (permissible values: 1 to 31).

Application: Remote control of the Communication Monitor from an IEEE controller.

Talk-Only

Effect: Selects the IEEE status TALK + LISTEN (menu item not crossed) or TALK ONLY (menu item crossed).

Entries: Cross/delete.

Application: For remote control select TALK + LISTEN, for print output TALK ONLY (note: at present no entry necessary because there is an automatic switch to TALK ONLY for print output).

EOI

Effect: The IEEE control line EOI is set (menu item crossed) or not set (menu item not crossed) if the data lines carry the CR+LF or CR control character (see next menu item).

Entries: Cross/delete.

Application: Querying of the EOI control line by the IEEE controller and system-specific evaluation.

CR+LF
(for example)

Effect: Automatically inserts a selectable control character in the parallel data stream at the end of each character string (text line) (note: only applies to data output with the PRINT and LIST commands in AUTORUN mode. **PRINT** and the IEEE command **HARDCopy** cause output in the *graphics format* of the selected printer).

Entries: Strike **UNIT/SELECT** and select the required control character from the list that is presented (CR+LF or CR).

Application: Matching to the present setting of the printer. If the printer automatically only executes a line feed (LF) at the end of a character string for example, control character CR will be necessary for the carriage return.

Printing out masks

The **PRINT** key and the IEEE command **HARDCopy** (see Chapter 9) initiate printout of the current screen contents (mask). In both cases the *graphics format* of the printer is used (no output of ASCII characters).

The following two subsections detail the steps that are necessary for printing out masks.

Printer HP 2225

1. Switch off **STABILOCK 4015** and install the hardware option "Interface IEEE-Bus/RS-232/Keyboard" in Port B (rear panel).
2. Set the DIP switch **LISTEN ALWAYS** on the rear of the printer to position "I". The setting of all other DIP switches then becomes unimportant.
3. Connect the IEEE interfaces of the printer and the Communication Monitor with the IEEE cable. Switch on the printer and **STABILOCK 4015**.
4. Call up the **PRINT** menu and cross menu items **HP 2225** and **IEEE**.
5. Strike **PRINT** (test printout of the current mask).

Printer FX80 and compatibles

1. Switch off STABILOCK 4015 and install the hardware option "Interface Centronics/RS-232/Keyboard" or "Interface IEEE-Bus/RS-232/Keyboard" in Port B (rear panel).
2. Depending on the configuration, connect the IEEE, Centronics or RS-232-C interface of the printer to the appropriate interface on the Communication Monitor. Switch on the printer and STABILOCK 4015 and proceed according to the following Table:

RS-232-C	IEEE	Centronics
Check or set following parameters on printer: baud rate, number of data bits, parity, number of stop bits. If test printout is incorrect (step 3) set CR + LF on printer in addition.	Set printer to LISTEN ALWAYS as explained in manual.	Call up PRINT menu and cross menu items Epson FX80 and Parallel.
Call up PRINT menu and cross menu items Epson FX80 and Serial.	Call up PRINT menu and cross menu items Epson FX80 and IEEE.	
Match menu items RS232 Baud xxxx and 8bit+No_P+1stop to related parameters of printer.		

3. Strike **PRINT** (test printout of current mask).

Printing out test reports and listings

The AUTORUN mode offers you the possibility of printing out test reports and program listings (PRINT command and **LIST** softkey; see Chapter 9). In contrast to the printout of masks, here there is no output in graphics format but instead of ASCII characters. So the right control character, matching the setting of the printer, has to be entered under the CR+LF menu item (RS-232-C or IEEE). Only then will the printer work correctly. Apart from this, the procedure is the same as when printing out masks.

RELAYS

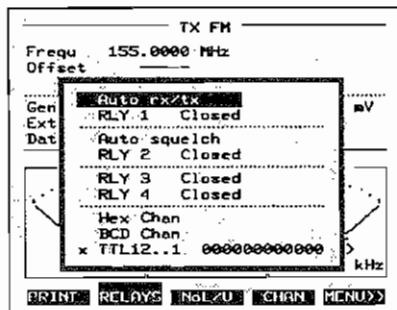

Fig. 4.6: Menu RELAYS governs control interface (remote control of radio sets).

Setting and resetting relays

Note: The pinning and technical data of the relays/TTL outputs are stated in Chapter 3.

Auto rx/tx

Effect: If you cross this menu item, the contacts of relay RLY 1 (socket Bu 18, pins 13 and 25) change position automatically when you switch between RX and TX modes. In TX mode (and DUPLEX) the relay is closed, in RX mode it is open. Menu item RLY 1 Closed is thus automatically set too.

Entries: Cross/delete.

Application: Remotely controllable semiduplex radio sets can automatically follow a change of mode on the Communication Monitor (transmit ↔ receive).

RLY 1 Closed

Effect: If this menu item is crossed/deleted, relay RLY 1 (socket Bu 18, pins 13 and 25) is closed/open after closing the menu window. Note: This manual setting of the contact position takes priority over the Auto rx/tx menu item and so it deletes a cross that is set there.

Entries: Cross/delete.

Application: Any control function.

- Auto squelch** **Effect:** If this menu item is crossed, relay RLY 2 (socket Bu 18, pins 12 and 24) is closed for the duration of the RX Special SQLCH. Note: All other RX Specials have no effect on the contacts of the relay. In line with this function, a cross on the menu item RLY 2 Closed will be deleted automatically.
Entries: Cross/delete.
Application: Automatic setting of a remotely controllable squelch on the test item just for the duration of a test (squelch response point, hysteresis).
- RLY 2 Closed** **Effect:** If this menu item is crossed/deleted, relay RLY 2 (socket Bu 18, pins 12 and 24) is closed/open after closing the menu window. Note: This manual setting of the contact position takes priority over the Auto squelch menu item and so it deletes a cross that is set there.
Entries: Cross/delete.
Application: Any control function.
- RLY 3 Closed** **Effect:** If this menu item is crossed/deleted, relay RLY 3 (socket Bu 18, pins 11 and 23) is closed/open after closing the menu window.
Entries: Cross/delete.
Application: Any control function.
- RLY 4 Closed** **Effect:** If this menu item is crossed/deleted, relay RLY 4 (socket Bu 18, pins 10 and 22) is closed/open after closing the menu window.
Entries: Cross/delete.
Application: Any control function.

Setting and resetting TTL outputs

Hex Chan

Effect: After you close the menu window there is hexadecimal output of the momentarily set channel number (Frequ field) on the TTL outputs of socket Bu 18 (see also "Coding channel numbers" overleaf). Notes: Channel numbers > 4095 cannot be coded. Field xxxx of the TTL12..1 menu item shows the logic level (1 or 0) of each TTL output as a check.

Entries: Cross.

Application: Remotely controllable radio sets can automatically follow a change of channel on the Communication Monitor.

BCD Chan

Effect: After you close the menu window there is BCD-coded output of the momentarily set channel number (Frequ field) on the TTL outputs of socket Bu 18 (see also "Coding channel numbers" overleaf). Notes: Channel numbers > 999 cannot be coded. Field xxxx of the TTL12..1 menu item shows the logic level (1 or 0) of each TTL output as a check.

Entries: Cross.

Application: Remotely controllable radio sets can automatically follow a change of channel on the Communication Monitor.

TTL12..1 xxxx

Effect: Permits manual setting of the twelve TTL outputs of socket Bu 18.

Entries: Cross; then locate the xxxx entry field with the cursor bar and open the field with **ENTER**. Place the cursor on the required positions and enter 1 or 0. Before closing the menu window, terminate your entries with **ENTER**.

Assignment of twelve TTL outputs in entry field											
12	11	10	9	8	7	6	5	4	3	2	1

Application: Any control function.

Coding channel numbers

Menu items Hex Chan and BCD Chan permit setting of the channel number on remotely controllable radio sets (TTL output). The following Tables illustrate the relationship between the channel number and the logic levels on the TTL outputs.

Hex coding

Weighting factor	2048	1024	512	256	128	64	32	16	8	4	2	1
TTL output no.	12	11	10	9	8	7	6	5	4	3	2	1
Logic level	0	0	1	0	0	0	1	0	0	0	1	1

Hexadecimal coding with weighting factors (eg decimal number 547)

Example: The channel number 547 (decimal) is the sum of the weighting factors $512 + 32 + 2 + 1$. TTL outputs assigned to weighting factors are logic 1, all others are logic 0 (see Table). The sum of all weighting factors is the highest permissible channel number (4095) that can still be hex coded.

BCD coding

Place	Hundreds				Tens				Ones			
Weighting factor	8	4	2	1	8	4	2	1	8	4	2	1
TTL output no.	12	11	10	9	8	7	6	5	4	3	2	1
Logic level	0	1	0	1	0	1	0	0	0	1	1	1

BCD coding with weighting factors (eg decimal number 547)

Example: The channel number 547 (decimal) has three places. Each digit is again the sum of the weighting factors:

Ones place = $7 = 4 + 2 + 1$

Tens place = $4 = 4$

Hundreds place = $5 = 4 + 1$

TTL outputs assigned to weighting factors are logic 1, all others are logic 0 (see Table). Because of the BCD coding, 9 ($8 + 1$) is the maximum figure that can be output for each place. This means that 999 is the highest channel number that can be BCD coded.

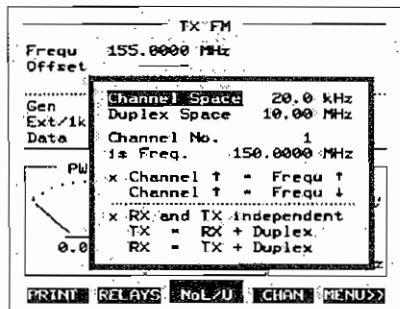

Fig. 4.7: Menu NoL/U (Lower/Upper) governs use of channel numbers and DUPLEX mode.

Defining channel/duplex spacing

Channel Space xxx **Effect:** Defines the channel spacing for working with channel numbers (Frequ field) (see also Appendix B).

Entries: Enter the channel spacing in the xxx field.

Duplex Space xxx **Effect:** Defines the duplex spacing when working in DUPLEX mode.

Entries: Enter the duplex spacing in the xxx field.

Application: Tests on duplex radio sets. If the figure 0 is entered, it is no longer necessary to observe upper-band and lower-band channels (NoU = NoL) when testing semiduplex radio sets.

Defining channel/frequency assignment

Channel No. xxx **Effect:** Defines the channel number that is assigned the frequency of menu item is Freq. xxx (see also Appendix B).

Entries: Enter the required channel number in the xxx field.

is Freq. xxx **Effect:** Defines the frequency that is assigned to the channel number of menu item channel No. xxx.

Entries: Enter the required frequency in the xxx field.

Channel ↑ = Frequ ↑ **Effect:** The frequencies increase with increasing channel number.

Entries: Cross.

Channel ↑ = **Frequ** ↓ **Effect:** The frequencies decrease with increasing channel number.
Entries: Cross.
Application: Necessary in some cellular mobile-radio systems, eg NMT Austria.

Automatic RX/TX combination

Note: The following menu items are only of importance if the signal generator and test receiver are tuned to *frequencies*. As soon as you start working with channel numbers (see appendix B), there is always automatic RX/TX combination according to the first items of this menu.

RX and TX independent **Effect:** You can tune the frequencies of the signal generator (RX) and test receiver (TX) quite independently of one another in each basic mask (no automatic RX/TX combination).

Entries: Cross.

TX = RX+Duplex

Effect: MHz values of the RX and TX tuning frequency are combined by the duplex spacing according to the equation $TX = RX + Duplex$. Changing one value is sufficient, the other value changes (tracks) automatically.

Entries: Cross.

Application: Tests on duplex radio sets.

RX = TX+Duplex

Effect: MHz values of the RX and TX tuning frequency are combined by the duplex spacing according to the equation $RX = TX + \text{Duplex}$. Changing one value is sufficient, the other value changes (tracks) automatically.

Entries: Cross.

Application: Tests on duplex radio sets.



If you enter a frequency (Frequ field) for automatic RX/TX combination that causes the *tracking* frequency to go outside the permissible frequency band, the entry will be rejected.

Automatic RX/TX combination does not take immediate effect after you close the menu window. First you have to enter a new frequency.

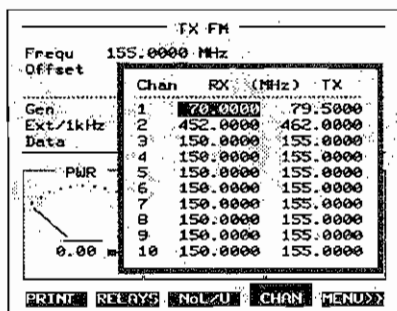

Fig. 4.8: Menu CHAN offers same simplicity as working with programmable station buttons.

The CHAN menu is useful if you often have to tune to frequencies that do not follow a fixed pattern (eg channel spacing, duplex spacing). You can define up to ten frequency pairs (signal generator/test receiver) and recall them when you need them simply by entering the appropriate channel number.

Defining frequency pairs

For defining frequency pairs the menu offers you ten lines (Chan 1 to 10), each with an entry field for the RX tuned frequency (signal generator) and TX tuned frequency (test receiver). You can locate each entry field with the cursor keys. Always terminate your entries with **ENTER**.

Recalling frequency pairs

1. Call up the basic RX, TX or DUPLEX mask.
2. Strike the **FREQU** key and enter the number (Chan) of the required frequency pair, but do not confirm with **ENTER**.
3. Strike **UNIT/SELECT**. This opens a small screen window. Move the cursor bar to the Chn entry and close the window again with **UNIT/SELECT**.
4. The Frequ field will now show the entered Chn number. The test receiver is tuned to the corresponding TX frequency and the signal generator to the RX frequency. To set a different frequency pair, simply turn the spinwheel VAR and set the required Chn number (permissible values: 1 to 10). Note: The function is also available when the Frequ field is adopted in another mask, eg as the Center field in the analyzer mask.
5. Returning to MHz display: strike **UNIT/SELECT** and select the MHz entry in the screen window.

STATUS

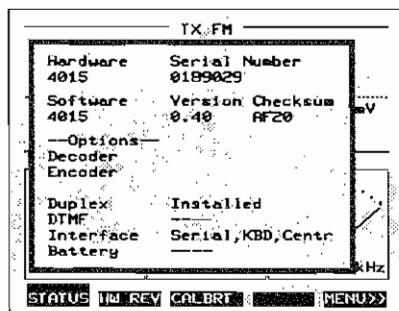

Fig. 4.9: Menu STATUS tells you about software status of Communication Monitor and installed options.

The STATUS menu is an information window that tells you the momentary hardware and software complement of STABILOCK 4015. You can find out what hardware options are installed for instance. Please name all status messages if you have to consult SCHLUMBERGER for advice (see also HW REV and CALBRT menu).

Standard complement

Serial Number Serial number of your STABILOCK 4015.

Version Software version of the firmware (EPROMs).

Checksum Checksum of the firmware.

Options

Decoder If the optional DATA Module is installed, display of the software version of the decoder plus checksum.

Encoder If the optional DATA Module is installed, display of the software version of the encoder plus checksum.

Duplex The message Installed means that the optional DUPLEX Synthesizer is installed.

DTMF The message Installed means that the optional DTMF Device is installed.

Interface The message Serial, KBD, Centr or Serial, KBD, IEC means that an external hardware option is installed in Port B (rear panel) (KBD = keyboard).

Battery

If the optional "Internal Battery" is installed, display of the battery voltage. As long as the battery is being charged, you will also see the message Charging.

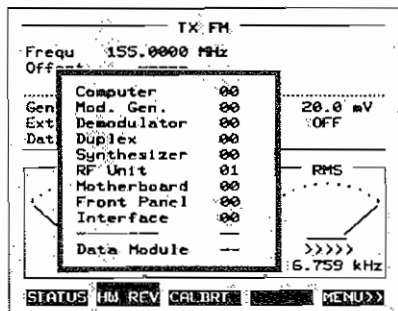

Fig. 4.10: Numbers are version status of individual 4015 boards.

The **HW REV** menu (hardware revision) documents the version status of the individual boards of your STABLOCK 4015 (including major hardware options). You should also have these status messages on hand if you consult SCHLUMBERGER for advice (see also **STATUS** and **CALBRT** menu).

The **HW REV** menu covers all boards whose version status can affect the way in which STABLOCK 4015 works (eg new or modified feature). In such cases the particular text passages in the manual are marked by number indexes. Appendix C (Chapter 12) tells you under the corresponding number how operation differs.

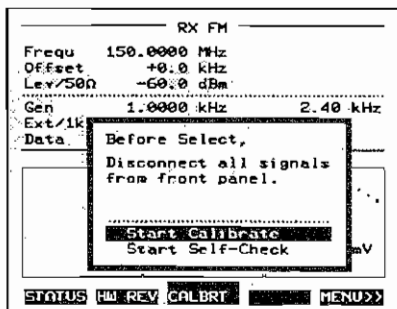

Fig. 4.11: Menu CALBRT²⁾ starts calibration routine or self-check.

Calibrating

Calibration procedures are detailed in Chapter 1, "Specific calibration".

Self-check

The self-check (lasts about 1 min) is an important aid in troubleshooting on the job.

Preparation

Withdraw all test cables from the front panel of Communication Monitor²⁾.

Calling up self-check

In the CALBRT menu, position the cursor bar on the entry Start Self-Check and strike UNIT/SELECT. This calls up the SELF-CHECK menu (Fig. 4.12).

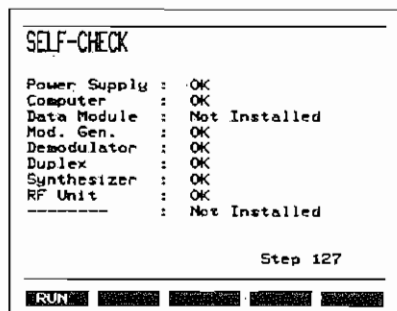

Fig. 4.12: Menu SELF-CHECK tells you whether major boards of Communication Monitor are OK.

Starting self-check Strike the **(RUN)** softkey. This causes the **(STOP)** softkey to appear and the callup of the individual test routines can be followed by the count of the **STEP** display field. Note: Individual routines last up to about 10 s.

**Messages
In self-check**

As soon as a board has been tested, the self-check produces one of the following entries:

- **OK** → Board is working correctly.
- **Not installed** → Board is missing (option).
- **Related Test Failed** → This board could not be tested because another board – which is defective – would have been required to do so.
- **Failed** → Board is defective.

The end of the self-check is marked by an acoustic signal, and at the same time the **(RUN)** softkey reappears.

**Aborting
self-check**

You can terminate the self-check at any time with **(STOP)**. Note: The test routine in progress is always completed, so it may take a few seconds to end the self-check.

Return

Strike **(RX)**, **(TX)** or **(DUPL)**.

What to do If the self-check signals failed

If the self-check signals that one or more boards are defective, you are advised to proceed as follows:

1. Perform a total reset (see Chapter 1) and repeat the self-check.
2. If the self-check again signals defects, fill in the following form (copy) and telephone your nearest SCHLUMBERGER service station or an authorized service firm.

STABILOCK 4015 Service Checklist

(SAMPLE)

Name and address	Magic Electronics 1 Long Road Anytown 987654		
Telephone	012/345678		

Software Version, Checksum and Options

To help you answer the following, open the STATUS menu

Serial number	0189029	Software version	1.00
Checksum	ABD1	Installed options	Duplex
Serial, XBD, Centr	-	-	-

Hardware Version Status

To help you answer the following, open the HW REV menu

Computer	00	Motherboard	00
Mod. Gen	00	Front Panel	00
Demodulator	00	Interface	00
Duplex	00	---- (Option)	-
Synthesizer	00	Data Module	-
RF Unit	01		

Results of Self-Check

To help you answer the following open, the CALBRT menu and start the self check

Power Supply	OK	Demodulator	Failed
Computer	OK	Duplex	OK
Data Module	Not Installed	Synthesizer	OK
Mod. Gen.	OK	RF Unit	Failed
		---- (Option)	Not Installed

Defect Symptoms

The following check points help to find a defect faster

Did anything go wrong in a test? If so, in what test?	
Measurement of receiver sensitivity was wrong	
Does the defect occur all the time or just sporadically?	All the time
How long had the 4015 been in use before the defect appeared?	About 30 min
Had you been using a system program? If so, which one?	
Yes, NMT 900	
In what mode and at what frequency does the defect occur?	RX 156 MHz
How is the signal generator modulated when the defect occurs?	2.4 kHz
What is the RF output level of the signal generator when the defect occurs?	2 mV
Remarks: Defect was first noticed after fitting the printer interface	

STABILOCK 4015 Service Checklist

Name and address

Telephone

Software Version, Checksum and Options

To help you answer the following, open the STATUS menu

Serial number:		Software version	
Checksum		Installed options	

Hardware Version Status

To help you answer the following, open the HW REV menu

Computer		Motherboard	
Mod. Gen		Front Panel	
Demodulator		Interface	
Duplex		---- (Option)	
Synthesizer		Data-Module	
RF Unit			

Results of Self-Check

To help you answer the following open the CALBRT menu and start the self check

Power Supply		Demodulator	
Computer		Duplex	
Data-Module		Synthesizer	
Mod. Gen.		RF Unit	
		---- (Option)	

Defect Symptoms

The following check points help to find a defect faster

Did anything go wrong in a test? If so, in what test?

Does the defect occur all the time or just sporadically?

How long had the 4015 been in use before the defect appeared?

Had you been using a system program? If so, which one?

In what mode and at what frequency does the defect occur?

How is the signal generator modulated when the defect occurs?

What is the RF output level of the signal generator when the defect occurs?

Remarks:

(

(

**Standard
Measuring Devices**

(

(

(

(

Introduction

This chapter tells you how to work with the different measuring devices of STABILOCK 4015. For better understanding of the internal AF signal paths, we advise you in particular to read the two sections "AF Signal Analysis" and "AF Generators".

The chapter is broken down into the following main sections:

- RF measuring devices
- AF measuring devices
- DC measuring devices
- System tester (selective call, A/B tone)

The technical data are listed in Appendix A. Refer to these when you require preciser details of general remarks (like "input signal too weak").

In many cases STABILOCK 4015 will also permit measurements outside of its specified range (but without any guarantee of accuracy!).

You can find out the permissible range of values *before* entering a value in a field. Just locate the particular field and open it with **ENTER** (the cursor flashes in the field). Striking **HELP** produces an information window that shows the permissible limits.

Test Setup

With the test setup shown here (Fig. 5.1) you should be able to perform all standard measurements on radio sets. Normally the test item should be connected to the common RF input/output socket RX/TX (preciser results). When you are working with input signals of less than -10 dBm or require an RF output level of more than -60 dBm however, it is best to use the TX SENS and RX HIGH sockets.



Bild 5.1: Typical test setup for standard RX/TX measurements. If required, eg for complex overlaid modulation, an external AF signal can be applied to the EXT MOD socket.

Available RF Measuring Devices

STABILOCK 4015 offers you six RF measuring devices. Pointer meters appear in the bottom half of the mask, purely numerically indicating instruments use display fields in the top half of the mask. Only the spectrum analyzer uses a separate mask.

Designation of instrument	Meaning
OFFSET	RF offset counter
RF counter	RF frequency meter
PWR	RF power meter
MOD	Modulation meter of signal generator
DEMODO	Modulation meter of test receiver
Spectrum analyzer	Shows power spectrum of received signal

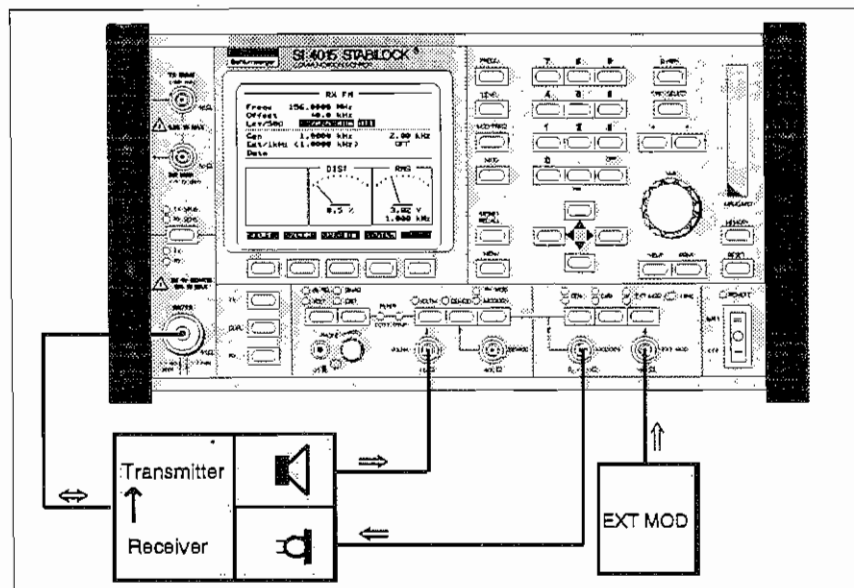
Available RF measuring devices of STABILOCK 4015.

The signal generator and test receiver of STABILOCK 4015 access the RF measuring devices (and also the AF measuring devices). Which of the RF measuring devices are actually available will depend on the operating mode:

Availability of RF test instruments, depending on operating modes TX, RX and DUPLEX.

The space for instruments on the right is reserved for AF test instruments.

— means that the mask shows no pointer meter or an AF instrument.

Mask	Instrument left	Instrument center	Display field
TX	PWR	DEMODO	RF counter and OFFSET
	Spectrum analyzer		
RX	MOD	—	None
DUPLEX	PWR	MOD or DEMODO	RF counter and OFFSET

Test Receiver

Standard use

Reception and demodulation of an RF signal (AM, FM, Φ M). Measurement of major RF parameters and AF measurements on the demodulated signal.

Adjustable variables

- Tuned frequency (manual or automatic tuning)
- Type of demodulation
- IF bandwidth
- Squelch response
- Frequency and level of AF generators (see "AF Generators" section). The AF signal appears on the MODGEN socket. It can be used to modulate a radio transmitter.

Activating test receiver

Call up the basic TX mask with **TX**. This automatically activates the test receiver with the settings that were last made on it.

Entries

Tuning frequency **FREQU** + Numeric value + **ENTER**

Instead of the tuning frequency you can also enter a channel number (see Chapter 12, Appendix B). Automatic tuning is described in the next section.

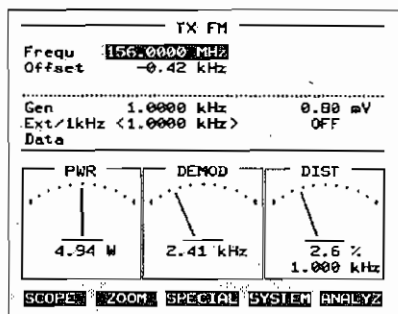

Fig. 5.2: Basic TX mask for transmitter testing. Above are the test parameters and the measured frequency offset, below the pointer meters.

Type of demodulation

MENU + **MOD-PAR** + {FM | Φ M | AM} + **MENU**

Acknowledgement: the mask header shows the selected type of demodulation (eg TX FM).

IF bandwidth

MENU + **RF-PAR** + {TXSens BW} + {80 kHz | 20 kHz | 9 kHz¹⁾} + **MENU**

The IF bandwidths 20 kHz and 9 kHz¹⁾ are only available in the following cases:

- When the TX SENS socket is connected.
- For FM or Φ M demodulation.



When the RX/TX socket is connected and/or AM demodulation is selected, the IF bandwidth is always 80 kHz, regardless of the value that is crossed.

Squelch response

The squelch can be switched and set separately for the RF sockets TX SENS and RX/TX:

- ⇒ Switch on squelch: open **RF-PAR** menu and cross menu item RX/TX and/or TxSens.
- ⇒ Switch off squelch: delete cross.
- ⇒ Set squelch: locate entry fields next to both menu items with cursor, enter required squelch response level and confirm entries with **ENTER**.



If the squelch response level is too high it will not be possible to analyze the demodulated signal.

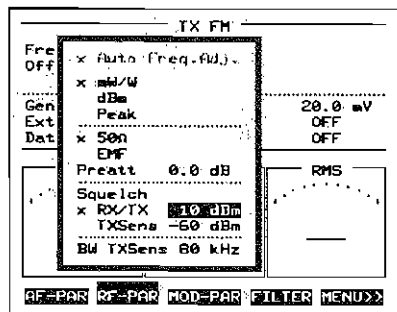

Fig. 5.3: The **RF-PAR** menu allows, among other things, setting of the squelch and the IF bandwidth.

Automatic tuning

Besides manual tuning (entry of the frequency to be tuned) the test receiver also permits automatic tuning to the applied RF signal. This simplifies selective power measurement, for instance, because the PWR meter will show the measured value immediately after the test signal is applied. Automatic tuning can generally remain active as a standard setting; you will only have to resort to manual tuning in exceptional cases like tuning to an harmonic.

Boundary conditions

Automatic tuning is only carried out if the following boundary conditions apply:

- Signal applied to the RX/TX socket, ie the RX/TX socket must be coupled.
- $P_{in} > \text{approx. } 10 \text{ mW (10 dBm)}$



Automatic tuning is only effective in the basic TX and DUPLEX masks (not in ZOOM, scope, analyzer mask, etc).

Activating auto-tuning

MENU + **RF-PAR** + {Auto Freq. Adj.} + **MENU**

Disabling auto-tuning

Delete the cross in front of menu item Auto Freq. Adj. with **UNIT/SELECT**.

Working with auto-tuning

⇒ If the boundary conditions are satisfied, the test receiver will tune within approx. 1 s to the applied RF test signal. The **Frequ** field shows the frequency value and all pointer instruments function as usual. Only the offset counter (**Offset** field) is inoperative (see "Technical background" below). Manual retuning of the test receiver is not possible in this status because the **Frequ** field is no longer an entry but a display field.

⇒ To tune the test receiver manually you must first strike the **FREQU** key. In this status the offset counter is also active because the entry in the **Frequ** field can be used as a reference.

⇒ If the offset exceeds approx. $\pm 40 \text{ kHz}$ (or if the input power briefly drops below approx. 10 mW), the test receiver will again tune automatically.



If you change to another mode (eg spectrum analyzer), the frequency value last confirmed with **FREQU** is always adopted.

Example

	Action	Reaction
1.	Frequ field shows entry 45.0000 MHz. Carrier signal with $f = 75.00000$ MHz and $P > 10$ mW is available, but is not yet fed in.	Scan finds no signal larger than approx. 10 mW. So Frequ field is still entry field and Offset field shows dashes because offset = ∞ .
2.	Apply carrier signal.	Test receiver tunes to carrier. Frequ field shows 75.00000 MHz and is now display field. No offset measurement because large offset (> 40 kHz).
3.	Disconnect carrier signal.	Frequ field is again entry field and shows 45.0000 MHz because there was no confirmation beforehand with FREQU .
4.	Apply carrier signal and confirm display 75.00000 MHz with FREQU .	Test receiver again tunes to 75.00000 MHz. FREQU makes this reference value for offset measurement. Offset field shows 0 kHz offset, Frequ field is entry field.
5.	Disconnect carrier signal.	Frequ field continues to show 75.0000 MHz because of preceding confirmation. Offset field shows dashes because offset = ∞ .
6.	Apply carrier signal.	Test receiver again tunes to 75.00000 MHz. Offset is < 40 kHz, so no confirmation with FREQU is necessary; Offset field immediately shows 0 kHz offset.
7.	Alter tuned frequency of test receiver in 10-kHz increments (Frequ field).	Offset field shows offset up to approx. ± 40 kHz. Larger offset automatically starts scan and status is as described under point 2.

Technical background

As soon as the automatic tuning is activated, the test receiver scans the entire TX frequency range continuously for an RF signal $>$ approx. 10 mW. The Frequ field in this status is still an entry field that can accept values. The scan is noticeable acoustically if you listen to the demodulated received signal with **DEMODO**.

When the test receiver finds an RF signal, it tunes itself exactly to this carrier (± 10 Hz). Then a check is made to see how much the tuned frequency differs from the value last entered in the Frequ field:

- If the offset exceeds approx. ± 40 kHz (normal case), the `Frequ` field (now a display field) shows the tuned frequency. There is no valid reference value for the offset counter (offset > 40 kHz), so it is inoperative. It is not activated until you confirm the measured value as a reference with `FREQU` (offset = 0 kHz). The `Frequ` field then again takes on the status of an entry field (automatically adopting the tuned frequency).
- If the offset goes below approx. ± 40 kHz, the test receiver was probably tuned to the RF signal beforehand. In this case the test receiver will reject the exact tuning and tune itself to the frequency entered in the `Frequ` field (the `Frequ` field remains an entry field). At the same time the offset counter is activated so that the `Offset` field shows the offset from the actual carrier frequency.

The following conditions trigger a restart of the scan:

- $P_{in} < \text{approx. } 10 \text{ mW}$
- measured frequency offset > approx. ± 40 kHz

Connecting RF input socket

The power of the input signal will decide whether you select the `RX/TX` socket or the `TX SENS` socket. The `RX/TX` socket is generally used for stationary measurements and the `TX SENS` socket for remote measurements (reception on an antenna).

`RX/TX`

Acknowledgement: only the red LED "TX" beneath the selector key lights up.

Maximum measurable RF input level = 150 W (briefly).

If the message `REDUCE RF POWER` appears, reduce immediately to < 50 W (see also Chapter 1).

`TX SENS`

Acknowledgement: only the red LED "TX SENS" above the selector key lights up.

Maximum measurable RF input level = 0.1 W.

$P_{in} > 0.25 \text{ W}$ will destroy the input stage!



Applying modulation signal to test item

In TX mode an AF signal can be brought out on the MODGEN output socket and applied to the microphone input on the test item. The signal sources are the internal AF generators GEN, DATA (option) and the 1-kHz generator or an external AF signal.

Operation of the AF generators (frequency and level setting, signal superimposition) is described in the "AF Generators" section.

- ☞ If TX Specials are used (Chapter 7), the test item *must* have the modulation signal fed to it from MODGEN.

Standard measurements in TX mode

RF measurements

- RF frequency ⇒ see RF counter.
- Frequency offset ⇒ see offset counter.
- RF power ⇒ see RF power meter PWR.
- Modulation ⇒ see demodulation meter DEMOD.
- Modulation sensitivity ⇒ see Chapter 7, TX Special "SENS".
- RF spectrum ⇒ see spectrum analyzer.

AF measurements

If the demodulated received signal is connected to the AF signal processing with **DEMODO**, this AF signal can also be examined:

- AF level, AF frequency ⇒ see RMS meter/AF frequency counter.
- Modulation-frequency response ⇒ see Chapter 7, TX Special "AF RESP".
- AF power ⇒ see AF power meter AF-Pwr.
- Relative level ⇒ see relative level meter dB-REL.
- Distortion factor ⇒ see distortion-factor meter DIST.
- Signal shape ⇒ see digital storage oscilloscope.
- Aural monitoring ⇒ see monitoring receiver.

This page is intentionally left blank.

Signal Generator

Standard use

Output of an unmodulated or modulated RF carrier signal (AM, FM, Φ M). At the same time check of the modulation signal or measurement of an external AF signal with the AF measuring devices.

Adjustable variables

- Carrier frequency, offset
- Output level, level matching (EMF or to 50 Ω), compensation of external preattenuation
- Type of modulation, modulation frequency, modulation deviation/depth

Activating and deactivating signal generator

Starting Call up the basic RX mask with **[RX]**. This automatically activates the signal generator with the settings that were last made on it.

Deactivating **[LEVEL]** + **[OFF]**

Acknowledgement: Lev field shows OFF.

Reactivating **[LEVEL]**

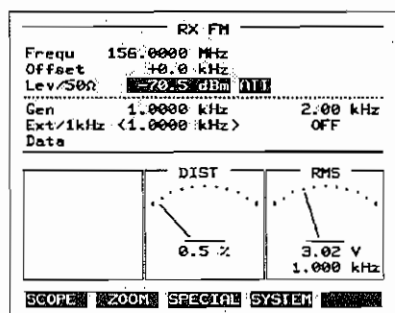

Fig. 5.4: Basic RX mask for receiver testing. The ATT indication reminds you of the compensation of external preattenuation.

Entries

Carrier frequency **FREQU** + Numeric value + **ENTER**

Instead of the carrier frequency you can also enter a channel number (see Appendix B).

Offset **FREQU** + **+** or **-** + Numeric value + **ENTER**

An entry in the **Offset** field has no effect on the **Frequ** field. The actual carrier frequency is the sum of the two values.

Output level **LEVEL** + Numeric value + **ENTER**

- ⇒ If the numeric value requires different units, replace it where you would otherwise just press **ENTER** with **UNIT/SELECT** + {dBm | dBμ | μV | mV | V} + **ENTER**.
- ⇒ The minimum/maximum output level depends on which RF output socket (RX/TX or RX HIGH) is connected. For AM the maximum output level is 6 dB less.



If compensation of preattenuation is set (**RF-PAR** menu), the note **ATT** next to the **Lev** field draws your attention to the resulting increase in level.

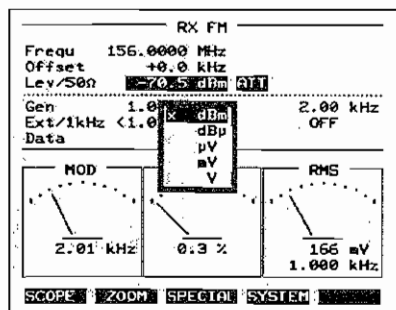

Fig. 5.5: When you set the RF output level, you can select the units to match your requirements.

Level matching

MENU + **RF-PAR** + {50Ω | EMF} + **MENU**

Acknowledgement: addition of 50Ω or EMF to the Lev field.

⇒ Lev/EMF = level setting affects source voltage (EMF).

The actual output level depends on the termination (ie therefore no level setting permissible here with dBm units).

⇒ Lev/50Ω = level setting affects terminal voltage on 50-Ω termination.

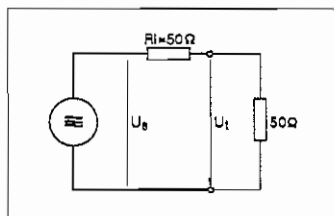

Fig. 5.6: With a 50-Ω termination the EMF (U_s) is double the terminal voltage U_t .

Type of modulation

MENU + **MOD-PAR** + {FM | ΦM | AM} + **MENU**

Acknowledgement: the mask header shows the selected type of modulation (eg RX FM).

Modulation frequency

MODFREQ + Numeric value + **ENTER**

Modulation depth, deviation

MOD + Numeric value + **ENTER**

Depending on the type of modulation, enter the frequency deviation (in kHz), phase deviation (in rad) or modulation depth (in %).

⇒ Striking the **MOD** key automatically activates the internal generator **GEN** (deactivate with **GEN** key).

⇒ Additional modulation with the 1-kHz generator and DATA generator: see "AF Generators".

Compensating preattenuation

⇒ The level loss on the antenna input of the test item that results from preattenuation (cable attenuation, attenuator) is automatically compensated by the following entry:
 $\text{[MENU]} + \text{[RF-PAR]} + \{\text{Preatt } \text{xx.x dB}\} + \text{[MENU]}$
xx.x = entry field for the compensating value. The value entered must correspond exactly to that of the external preattenuation.



The compensation of preattenuation is only effective when the RX/TX socket is connected.

⇒ Entry field Lev now shows the output level directly on the antenna input of the test item (the actual level on the RX/TX socket is higher by the compensating value).

⇒ The note ATT after the Lev field reminds you that compensation of preattenuation is set.



Compensation of preattenuation that is declared applies to the signal generator (RF output level) and the test receiver (RF power meter PWR).

Connecting RF output socket

The required output level will decide whether you select the RX/TX socket or the RX HIGH socket.

RX/TX Acknowledgement: only the green LED RX beneath the selector key lights up.

RF output level = -130 to -60 dBm (0.14 to 447 μ V EMF)

RX HIGH Acknowledgement: only the green LED RX HIGH above the selector key lights up.

RF output level = -70 to $+13$ dBm (141 μ V to 2 V EMF)

Impermissible level entries in the Lev field are rejected depending on the RF output socket that is connected.

For amplitude modulation the maximum RF output level that can be set is 6 dB smaller.

Modulation test

Starting

[RX MOD/MODGEN] calls up the modulation meter MOD and at the same time connects the modulation signal to the AF analyzer of the 4015.

Acknowledgement: the green LED above **[RX MOD]** lights up.

[RX MOD/MODGEN] has *no* effect on feeding the modulation signal to the signal generator.

Measuring modulation

⇒ The MOD instrument shows the peak modulation of the 4015 carrier signal (depending on type of modulation: kHz, rad or %). MOD is particularly useful for indicating the result of sum modulation.

⇒ After **[ZOOM]**+**[MENU]**+{Mod/Demod}+**[MENU]** display of modulation balance (return with **[RX]**).

Measuring level

The RMS meter shows the level of the (sum) modulation signal.

Measuring distortion

The dual-function key **[SINAD/DIST]** calls up the distortion-factor meter.

Acknowledgement: the LED DIST lights up.

Acoustic check

Monitoring of the modulation signal on the internal loud-speaker. Volume control with the knob next to the PHONE socket.

Visual check

[SCOPE]

The scope shows the oscillogram of the (sum) modulation signal. Return to the basic RX mask with **[RX]**.

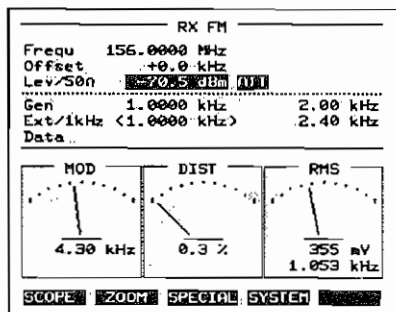

Fig. 5.7: If the signal generator is modulated with overlaid AF signals, the MOD meter shows the resulting sum modulation.

Standard measurements in RX mode

RF measurements

- Receiver sensitivity ⇨ see SINAD instrument and Chapter 7, RX Special "SENS".
- IF bandwidth and offset ⇨ see Chapter 7, RX Special "BANDW".
- Squelch response ⇨ see Chapter 7, RX Special "SQLCH".

AF measurements

If the AF signal of a receiver fed in on the VOLTM socket is connected to the AF signal processing by **VOLTM**, this signal can be examined as a function of the RF signal that is applied:

- AF level, AF frequency ⇨ see RMS instrument/AF frequency counter.
- AF frequency response ⇨ see Chapter 7, RX Special "AF RESP".
- AF power ⇨ see AF power meter AF-Pwr.
- Relative level ⇨ see relative level meter dB-REL.
- Distortion factor ⇨ see distortion-factor meter DIST.
- Signal shape ⇨ see digital storage oscilloscope.
- Aural monitoring ⇨ Monitoring of the AF signal on the internal loudspeaker. Volume control with the knob next to the PHONE socket.

This page is intentionally left blank.

RF Offset Counter OFFSET

The offset counter (Offset field) shows the difference between the actual carrier frequency of the input signal and the tuned frequency of the test receiver.

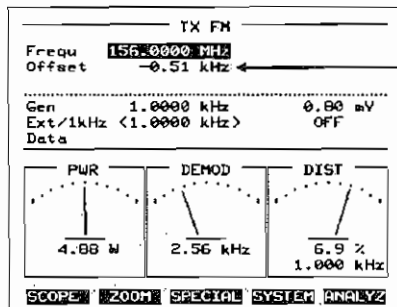

Fig. 5.8: The Offset display field shows the difference between the frequency of the applied RF signal and the tuned frequency of the test receiver.

Starting

- ⇒ Call up the basic TX or DUPLEX mask.
- ⇒ Select the TX SENS or RX/TX socket and feed in the RF test signal (watch P_{max} !). Heavily modulated test signals can corrupt the measured result!
- ⇒ Check whether automatic tuning is activated or not (menu item Auto Freq. Adj. in the RF-PAR menu; see section "Test Receiver").
- ⇒ The IF bandwidth set in the RF-PAR menu (menu item TXSens Bw) limits the offset measurement range to about half the IF bandwidth (only when the signal is applied to TX SENS). This permits selective offset measurement for dense channel occupancy.

Measuring routine

With auto-tuning	Without auto-tuning
<p>As soon as carrier signal is applied ($P >$ approx. 10 mW, fed in on RX/TX socket), Frequ field shows actual value of carrier frequency.</p> <p>Call up offset counter with [FREQU] and enter supposed value of carrier frequency in Frequ* field.</p> <p>Read frequency offset from Offset field.</p>	<p>Enter supposed value of carrier frequency in Frequ field.</p> <p>No further entries required.</p> <p>Read frequency offset from Offset field.</p>
<p>* In the basic DUPLEX mask you cannot locate the Frequ field (test receiver) with the cursor until the Frequ field (signal generator) has been closed with [ENTER].</p>	

Display

- ⇒ The `offset` field produces a numeric display of the frequency offset of the input signal referred to the tuned frequency.
- ⇒ Frequency offset > approx. 40 kHz: display -----
- ⇒ Input signal too weak: display ----- (try setting a larger IF bandwidth).

Options

After `[ZOOM]` + `[MENU]` + {`Offset`} + `[MENU]` display of the offset by full-screen pointer meter (return with `[TX]` or `[DUPL]`).

RF Counter

The RF frequency counter is effective in the basic TX and DUPLEX mask as soon as automatic tuning of the test receiver is declared instead of manual tuning.

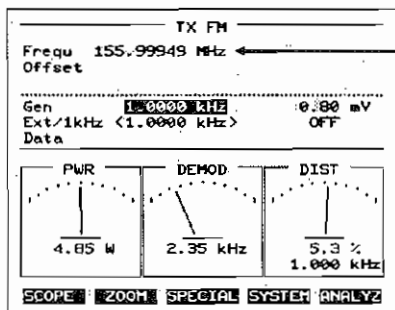

Fig. 5.9: When automatic tuning is activated, the Frequ field indicates the measured frequency.

Starting

- ⇒ Call up the basic TX or DUPLEX mask.
- ⇒ Select the RX/TX socket (otherwise the RF counter cannot be called up).

Calling auto-tuning

[MENU] + [RF-PAR] + {Auto Freq.Adj.} + [MENU]

Applying test signal

Apply the test signal to the RX/TX socket (P_{min} = approx. 10 dBm, watch P_{max} !).

Measuring routine

- ⇒ No further entries required. The Frequ field immediately shows the frequency of the applied RF signal in numeric form (resolution: 10 Hz).
- ⇒ The test receiver is tuned to the RF signal, so other measured values, eg power and modulation of the test signal, can immediately be read from the pointer meters.
- ⇒ If the test receiver is to stay tuned to the measured frequency, confirm the displayed value with [FREQU]. Acknowledgement: the Offset field shows the measured offset (see section "Test Receiver").



If no frequency is displayed when you are testing a one-port radio set (DUPLEX mode), an entry [LEVEL] + [OFF] + [LEVEL] will eliminate the blockade (brief cutout of the signal generator). Such a blockade can occur if the levels are unfavourable ($TX \text{ level} - RX \text{ level} \leq 80 \text{ dB}$).

- Display** ⇨ The Freq field shows the measured frequency.
⇨ Input level < approx. 10 dBm: display -----
⇨ $f_{RF} \approx 1.45$ to 1000 MHz: display -----
- Deactivating counter** In the RF-PAR menu delete the previously entered cross in front of the menu item Auto Freq.Adj with UNIT/SELECT.
- Options** For measuring the frequency of non-continuous signals (bursts) there is the TX/DUPLEX Special F-BRST⁵⁾.

RF Power Meter PWR

The RF power meter PWR measures *selectively* with 80 kHz bandwidth. The specified measuring accuracy applies if the test receiver is tuned to the test signal with a maximum offset of ± 3 kHz. If you have declared FM or Φ M demodulation, the average value of the applied RF power is measured. If AM is declared, you can optionally measure peak power. Measurements can be made in watts and dBm. The pointer meter appears constantly in the basic TX and DUPLEX mask.

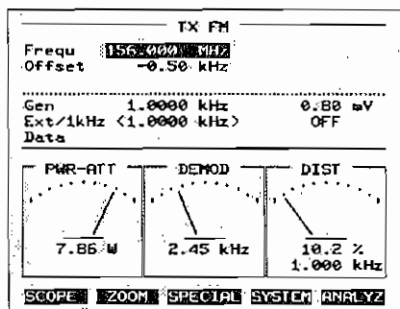

Fig. 5.10: The RF power meter PWR measures *selectively*. For this reason the test receiver must be tuned to the frequency of the test signal.

Starting

- ⇒ If you want maximum accuracy, start the specific calibration process (see Chapter 1).
- ⇒ Select the TX SENS or RX/TX socket and apply the RF test signal (watch P_{max}). AM test signals should be applied unmodulated.
- ⇒ Enter the tuning frequency in the **Frequ** field (or tune the test receiver automatically, see section "Test Receiver"). The offset must not exceed ± 3 kHz (otherwise measuring error).
- ⇒ If the PWR meter indicates ATT, check the compensation of preattenuation in the RF-PAR menu (**Preatt** field).

Selecting unit and measurement mode

- ⇒ Average (for FM/ Φ M/AM):
 $\text{[MENU]} + \text{[RF-PAR]} + \{\text{mw/W} \mid \text{dBm}\} + \text{[MENU]}$
(menu item **Peak** must *not* be crossed)
- ⇒ Peak (only for AM):
 $\text{[MENU]} + \text{[RF-PAR]} + \{\text{mw/W} \mid \text{dBm}\} + \{\text{Peak}\} + \text{[MENU]}$

Measuring routine

No further entries required. The PWR meter immediately shows the power of the applied RF signal with the selected units.



Automatic tuning is not permissible for measuring harmonics (menu item **Auto Freq.Adj.** in the RF-PAR menu must *not* be crossed) because otherwise the fundamental will always be tuned.

Display

- ⇒ Pointer display for recognition of trend plus numeric display with autoranging.
- ⇒ P_{in} on TX SENS socket ≥ 100 mW: display >>>>>
- ⇒ P_{in} on RX/TX socket > 150 W: display >>>>>
- ⇒ Input signal too weak: display -----



Compensating preattenuation

If the **REDUCE RF POWER** display appears while the signal is applied to the RX/TX socket, reduce the power immediately to $P < 50$ W.

Corruption of the measured value by known, external preattenuation (cable attenuation, attenuator) is automatically compensated by the following entry:

MENU + **RF-PAR** + {Preatt xx.x dB} + **MENU**

xx.x = entry field for the compensating value. The value entered must correspond exactly to that of the external preattenuation. Then the measured result is the RF power directly on the output of the test item. The **ATT** indication at the top of the pointer meter reminds you that compensation of preattenuation is set.



The compensation of preattenuation is only effective when the RX/TX socket is connected. The compensating value is automatically adopted from the signal generator and the RF output level increased accordingly.

Options

- ⇒ After **ZOOM** + **MENU** + {RF Power} + **MENU** full-screen display of the meter (return with **TX** or **DUPL**).

Modulation Meter MOD

The pointer meter MOD shows the modulation depth/deviation of the signal generator. This is particularly useful for sum modulation. In the basic RX mask the MOD meter can be inserted on the left and in the basic DUPLEX mask in the center.

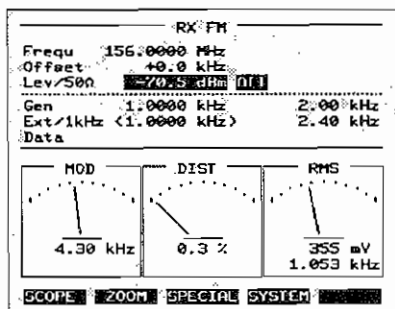

Fig. 5.11: The MOD meter shows the momentary modulation of the signal generator (peak values).

Starting

- ⇒ Call up the basic RX or DUPLEX mask.
- ⇒ Set the signal generator (carrier frequency, level, modulation).

Callup

Strike **[RX MOD/MODGEN]**.

Acknowledgement: the green LED above the key lights up.

Measuring routine

No further entries required. The MOD meter shows the peak value of the momentary modulation. Changes in the level of the modulation-signal sources (GEN, DATA, EXT MOD) are indicated immediately.

Display

Pointer display for recognition of trend plus numeric display with autoranging.

Options

After **[ZOOM] + [MENU] + {Mod/Demod} + [MENU]** full-screen display of the meter for positive and negative peak value (return with **[RX]** or **[DUPL]**).

This page is intentionally left blank.

Modulation Meter DEMOD

The pointer meter DEMOD measures the modulation depth/deviation of the received signal (peak values). It is always active in the basic TX mask. In the basic DUPLEX mask it can be called up with **DEMOD**. When FM signals have a lot of interference (eg noise, ripple), the RMS meter can also be used to display the nominal modulation. In the ZOOM mode it is possible to display modulation symmetry and the maximum modulation peaks (peak hold).

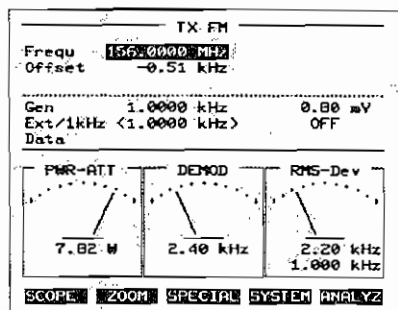

Fig. 5.12: The DEMOD meter shows the modulation of the received signal.

Starting

- ⇒ If you want maximum accuracy, start the specific calibration process (see Chapter 1).
- ⇒ Call up the basic TX or DUPLEX mask (in DUPLEX mode call up the modulation meter with **DEMOD**).
- ⇒ Select the TX SENS or RX/TX socket and apply the modulated RF test signal (watch P_{max} !).
- ⇒ Enter the tuning frequency in the **Frequ** field (or tune the test receiver automatically with the RF counter).
- ⇒ The menu item **Demod Rangehold** must not be crossed in the **AF-PAR** menu.
- ⇒ If an FM/ΦM signal is applied to the TX SENS socket, check the set IF bandwidth in the **RF-RAR** menu (see also section "Test Receiver"). At IF bandwidths of < 80 kHz there can be undesirable limiting of the modulation spectrum, ie test errors. The risk of such limiting increases with the modulation frequency and deviation of the test signal.

Measuring routine No further entries required. The DEMOD meter shows the peak value of the momentary modulation.

- Display** ⇨ Pointer display for recognition of trend plus numeric display with autoranging.
 ⇨ Overdriving: display >>>>>
- Measuring symmetry** After **ZOOM**+**MENU**+{Mod/Demod}+**MENU** full-screen display of the meter for positive and negative peak value (return with **TX** or **DUPL**).
- Peak-hold measurement**
 (only for FM/ΦM) Striking **PEAK** in ZOOM mode (highlights the softkey) starts a test phase in which a peak detector measures the *maximum* positive/negative modulation peak. While this is going on, the monitor shows an information window. Striking any key terminates the measurement. The pointer meter then shows the maximum positive/negative modulation peak that has been detected. Striking **PEAK** again will restart the continuous measurement.
- ⇨ For demodulation of FM signals the peak detector is DC-coupled. An offset of the test signal from what is set (offset display field) will therefore enter directly into the peak-hold result.
- Example:* modulation = ±2.4 kHz, offset = +1.2 kHz
 Display (w/o peak hold): ±2.4 kHz
 Display (with peak hold): +3.6 kHz/--1.2 kHz

PTO

Suppressing super-imposed noise
(only for FM)

Problem: instability of the display of frequency deviation on the DEMOD meter, caused by superimposed noise or a very weak received signal.

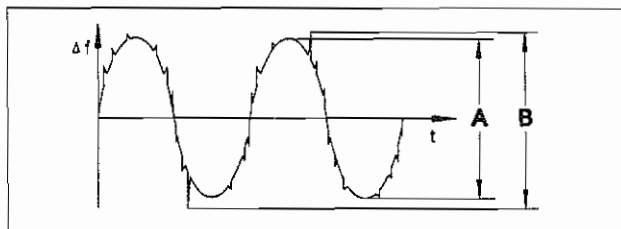

Fig. 5.13: The DEMOD meter shows the peak deviation B with its noise spikes. With the RMS meter it is possible to display the actual, nominal peak deviation A.

Remedy: measure the demodulated signal with the RMS meter (this eliminates the interference); the original peak frequency deviation is obtained from this result by multiplying it by the factor 1.414 and is shown by the RMS meter.
Required entries:

[DEMOD] + [MENU] + [AF-PAR] + {Demod RMS .Dev} + [MENU]

Acknowledgement: the Dev indication at the top of the RMS meter.

The RMS meter then shows, instead of a voltage value, the calculated peak deviation of the received signal.

The display is only correct for a sinusoidal modulation signal!

If the AF signal analysis is coupled to a different AF signal source with [VOLTM] or [RX MOD/MODGEN], the RMS meter assumes its normal function.



This page is intentionally left blank.

Spectrum Analyzer

The spectrum analyzer of STABILOCK 4015 shows, in a 7.5 cm x 4.5 cm window, the power spectrum of the received RF signal (technical data: see Appendix A). Application examples: checking occupancy of a frequency band, analysis of spectral distribution of a carrier signal or determining the frequency of an unknown, low-power signal.

Calling analyzer

Starting

- ⇒ Set TX mode with **[TX]**.
- ⇒ Set the required type of demodulation in the MOD-PAR menu (permits aural monitoring of modulated signals).
- ⇒ Apply the RF test signal to the RX/TX or TX SENS socket (watch P_{max} !) and connect the chosen RF socket with the selector key.

Callup

Strike the **[ANALYZ]** softkey. This clears the basic TX mask on the monitor and produces a full-screen display of the analyzer mask. The softkeys show new functions for the operation of the analyzer. **[MENU]** now presents menu windows for selecting the reference level and frequency resolution.



Calling up the analyzer automatically activates the automatic gain control (AF-PAR menu, the cross in front of the menu item Demod Rangehold is automatically deleted).

Return

[TX], **[DUPL]** or **[RX]** takes you back to the appropriate basic mask. The center frequency last set in the analyzer mask is adopted in the basic TX and DUPLEX mask so that continuing measurements are possible straight away.

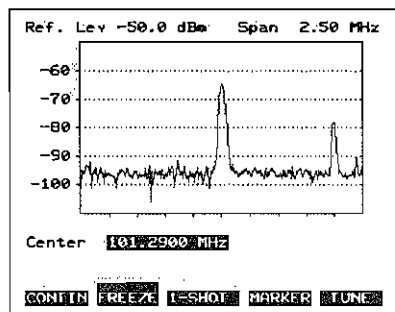

Fig. 5.14: Display of an RF power spectrum by the analyzer.

Settings

Center frequency Enter the required center frequency (channel number) in the Center entry field (confirm with **ENTER**) or alter the existing entry continuously with the spinwheel.



If the entry of the required center frequency is rejected at the limits of the frequency range, cross the menu item RX and TX independent in the NoL/U menu.

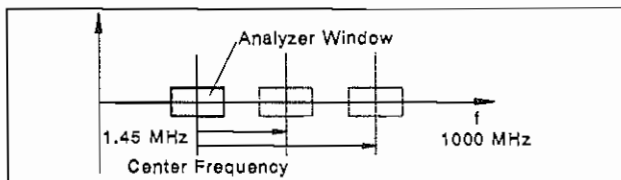

Fig. 5.15: The center frequency determines what segment is displayed on the frequency axis of the analyzer window.

Window width **MENU** + **SPAN** opens the menu window for selecting the window width (the frequency span displayed in the analyzer window, 0.25 to 10 MHz). **MENU** closes the menu window and adopts the selected window width.

Acknowledgement: display of the window width in the Span display field.

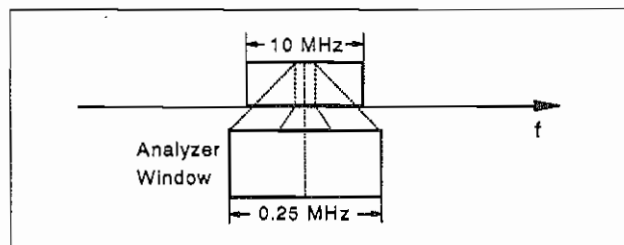

Fig. 5.16: The window width (span) determines the frequency resolution in the displayed frequency segment.

Example: center = 100.0000 MHz, span = 10 MHz.
The analyzer shows the signal spectrum in the frequency band 95 to 105 MHz (resolution: 40 kHz/pixel).

Reference level

MENU + **LEVEL** offers the menu window for selecting the reference level. Depending on the RF input socket that is connected, reference levels from +50 to +10 dBm or from 0 to -50 dBm can be set. **MENU** closes the menu window and adopts the selected reference level.

Acknowledgement: display of the reference level in the Ref. Lev display field.

The reference level is important for the input sensitivity of the analyzer. The smaller the reference level, the greater is the sensitivity. The reference level should be chosen so that the strongest spectral component is just short of the top edge of the analyzer window. This avoids overdriving and makes the best possible use of the display range of the analyzer.



Outside of the displayed frequency range there should be no spectral components that are larger than the reference level, because these can also overdrive the analyzer (broadband input stage).

Analyzer functions

Continuous spectral display (CONTIN)

CONTIN produces a continuous display of the signal spectrum that is refreshed at the rate of the sweep time (< 2.5 s). This standard function permits observation of a frequency band or the spectrum of a transmitted signal during an adjustment.

Frozen spectral display (FREEZE)

The **FREEZE** softkey freezes the signal spectrum on the monitor as it is when the key is pressed (the softkey is highlighted). The display becomes continuous again and is refreshed when you press **CONTIN**. The FREEZE function can be used to freeze a spectrum with a transmitting station that only appears briefly. In this way the frequency and received power of the station can be determined with the MARKER function when it is no longer transmitting.

One-shot measurement (1-SHOT)

The **(1-SHOT)** softkey triggers a one-shot measurement and freezes the displayed signal spectrum. The one-shot measurement is called up by AUTORUN routines or with an IEEE-bus command, eg at specific points in time. Striking **(CONTIN)** again produces the continuous spectral display.

Evaluating signal spectrum (MARKER)

Starting

The **(MARKER)** softkey produces a marker (vertical line), the Marker display field and the **(TUNE)** softkey in the analyzer mask.

Evaluating

As the position of the marker is altered with the spinwheel, the Marker display field shows the frequency and received power of the spectral component that is momentarily marked (units: dBm). The alteration in frequency with each increment of the spinwheel depends on the selected window width, ie the frequency span.

The analyzer is of limited use for measuring harmonics. Inaccurate results can be expected in particular with strong input signals ($P > +40$ dBm).



Any compensation of preattenuation that is declared in the RF-PAR menu (Preatt field) is *ineffective* in the analyzer mode. Remember this when judging the received power.

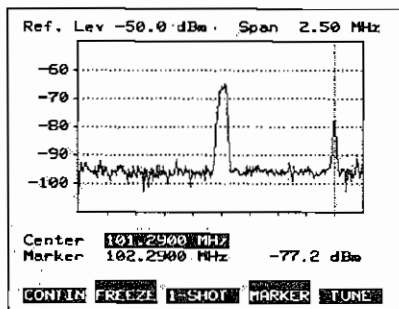

Fig. 5.17: With the marker you can determine the frequency and received power for each spectral line.

- Aural monitoring**
- ⇒ Freeze the signal spectrum with the **(FREEZE)** softkey, turn up the volume control and position the marker with the spinwheel on the spectral line (choose a small span for accurate tuning).
 - ⇒ For the demodulation of FM/ΦM and when applying signals to the TX SENS socket it is possible to improve selectivity by selecting a narrow IF bandwidth in the RF-PAR menu. The selected IF bandwidth has no effect on the display of the signal spectrum.
 - ⇒ For AM or when RF signals are applied to the RX/TX socket the IF bandwidth remains 80 kHz.
 - ⇒ If you hear signals when the marker is *not* on a spectral component, these will be image frequencies (IF = 450 kHz) or intermodulation products.

Tuning **(TUNE)** adopts the frequency from the **Marker** display field in the **Center** select field. Immediately after this the signal spectrum is displayed with the new center frequency.



In each analyzer function: alterations of the center frequency, the window span or the reference level always cause a refresh of the displayed signal spectrum.

This page is intentionally left blank.

Monitoring Receiver

STABILOCK 4015 can be used over the entire frequency range from 1.45 to 1000 MHz as a monitoring receiver for AM, FM or Φ M signals (reproduction on internal loudspeaker or headphones). Filters crossed in the **FILTER** menu have *no* effect on the reproduction.

 Remember that there are legal regulations about the monitoring of radiocommunications.

Starting

- ⇒ Call up the basic TX mask with **[TX]**.
- ⇒ Select the TX SENS socket and connect the antenna.
- ⇒ Select the type of demodulation:
[MENU] + [MOD-PAR] + {FM | Φ M | AM} + [MENU]
- ⇒ Connect the demodulated received signal to the AF signal analysis with **[DEMOD]**.
- ⇒ Turn up the volume control.

Tuning

Enter the tuning frequency in the **Frequ** entry field or set it by turning the spinwheel. Tuning is also possible by entering channel numbers (see Appendix B).

Setting

IF bandwidth

For FM or Φ M demodulation the selectivity can be improved by selecting a narrow IF bandwidth in the **RF-PAR** menu (see also "Test Receiver").



If the IF bandwidth is *too* narrow, there will be distortion.

Setting squelch

Activate the squelch in the **RF-PAR** menu (see "Test Receiver").



If the squelch response level is too high, there will be no signal reproduction.

Finding stations

With the spectrum analyzer it is possible to monitor station occupancy visually in a frequency band of maximum 10 MHz. Tune to a station and monitor the modulation (see "Spectrum Analyzer").

Using

station memory

Fast tuning to any ten stations with the spinwheel:

- ⇒ Enter the required frequencies in the **CHAN** menu (column **TX**) and note the associated channel number (column **Chan**).
- ⇒ Locate the **Frequ** entry field of the TX mask, strike the **[UNIT/SELECT]** key and cross **Chn**.
- ⇒ Set the required channel number between 1 and 10 with the spinwheel in the **Frequ** field.

Freezing gain

Sudden volume fluctuations are caused by the automatic gain control in the test receiver. There are two different ways of countering this:

- ⇒ After tuning to a station, freeze the gain. To do this, cross the menu item `Demod Rangehold` in the `AF-PAR` menu (this freezes the momentarily set gain values in the entire RF/AF signal path of the test receiver). Before changing stations the gain should be released again because otherwise the reproduction of the signals from the new station could be too loud or too quiet.
- ⇒ Strike `[MENU]` (opens a random menu window). This also freezes the momentary gain, but no more measurements are possible (pure monitoring operation).

AF Signal Analysis

The AF signal analysis of STABILOCK 4015 permits comprehensive measurements on AF signals. The following test signals can be connected to the input of the AF signal analysis (Fig. 5.18):

- Demodulated received signal (TX DEMOD).
- Internally generated AF signal (GEN, DATA, 1-kHz signal).
- External AF signal fed in on VOLT M socket.

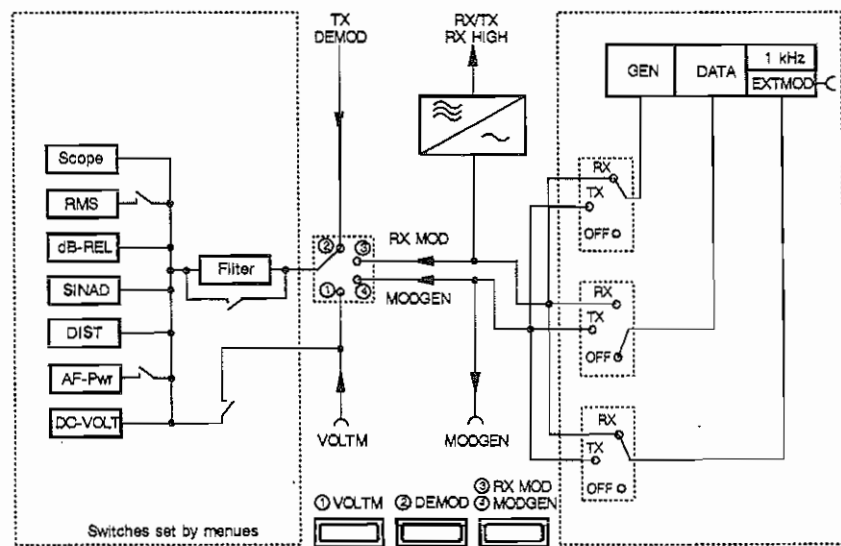

Fig. 5.18: The AF signal analysis (left) can be connected to the test signals TX DEMOD, RX MOD, MODGEN and VOLT M. In RX mode the TX DEMOD and MODGEN signals are not available; in TX mode there is no RX MOD signal. In DUPLEX mode all test signals are available.

Connecting test signal

Demodulated received signal

Strike **DEM**.

Acknowledgement: the red LED above the key lights up. Analysis of the demodulated received signal is only possible in TX and DUPLEX modes (test receiver active).

Internal AF signal

Strike **RX MOD/MODGEN**.

Acknowledgement: in TX mode the red LED lights up, in RX mode the green LED above the key lights up.

By repeatedly striking **RX MOD/MODGEN** in DUPLEX mode, either all the signal generators switched to TX can be connected (red LED lights up) or all the AF generators switched to RX (green LED lights up). This enables you to check the signal that is output on the MODGEN socket and also to check the internal modulation signal (see also Fig. 5.18 and "AF Generators" section).

External AF signal

Strike **VOLTM**.

Acknowledgement: the yellow LED above the key lights up. Feed in the external AF signal on the VOLTM socket.

The **VOLTM**, **DEM** and **RX MOD/MODGEN** keys are mutually canceling so that the AF signal analysis can only be connected to one of the test signals at any one time.

Available AF measuring devices

The AF pointer meters, like the RF pointer meters, appear in the bottom half of a basic mask. They are ready to use immediately, without any further entries. With the exception of the oscilloscope, STABLOCK 4015 produces all AF measuring devices as quasianalog pointer meters (trend recognition). The exact measured value is indicated in numeric form at the same time.

Designation of instrument	Meaning
RMS	RMS voltmeter with AF frequency counter
dB-REL	Relative level meter (reference level = 0 dB)
SINAD	SINAD meter
DIST	Distortion-factor meter
AF-Pwr	AF power meter
	AF generators
Scope	Digital storage oscilloscope

Available AF measuring devices of STABLOCK 4015



Each AF pointer meter can be called up in each of the three basic masks. But the basic TX and DUPLEX masks can only show one of the AF pointer meters at a time, whereas the basic RX mask can show two simultaneously. The following table tells you where the pointer meters are placed and which of them can be visible on the monitor at the same time.

Mask	Instrument left	Instrument center	Instrument right
TX	—	—	dB-REL
	—	—	RMS*
	—	—	DIST
	—	—	SINAD
	Scope		
RX	—	dB-REL	RMS
	—	—	RMS*
	—	DIST	RMS
	—	SINAD	RMS
	Scope		
DUPLEX	—	—	dB-REL
	—	—	RMS*
	—	—	DIST
	—	—	SINAD
	Scope		

Placement of the AF pointer meters in the three basic masks.

*) As long as the VOLTM socket is connected as an AF signal source, the AF power meter (AF-Pwr) or the DC voltmeter (DC-Volt) can be called up instead of the RMS meter.

— means that the mask shows no pointer meter or an RF instrument.

The following pages explain how the individual AF measuring devices are called up and used.

RMS Meter/AF Frequency Counter

The RMS voltmeter can be called up in any basic mask. It is always shown on the right of the monitor.

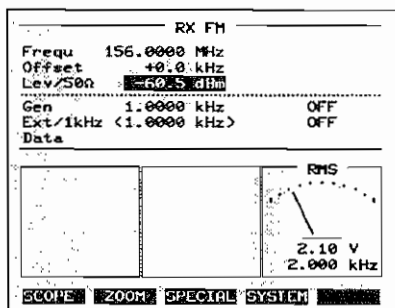

Fig. 5.19: The RMS meter measures the RMS value and the frequency of the connected test signal.

Starting

⇒ **MENU** + **AF-PAR** + {**RMS eff**} + **MENU**

⇒ Check that AF filters are switched off or correctly set (**FILTER** menu).

Callup

Strike **dBrel/VOLT** until the "VOLT" LED lights up.

Connecting test signal

Strike **VOLTM**, **DEMOM** or **RX MOD/MODGEN**.

Measuring routine

No further entries required. The RMS meter immediately shows the voltage value of the connected test signal.

Display

⇒ Voltage value: pointer display for recognition of trend plus numeric display with autoranging.

⇒ Frequency value (AF): numeric display.

⇒ Input signal too strong: display >>>>

⇒ Input signal too weak: display -----

Options

⇒ AF filters can be connected ahead (see Chapter 4, **Filter** menu).

⇒ After **ZOOM** + **MENU** + {**AF**} + **MENU** full-screen display of the meter (return with **TX**, **DUPL** or **RX**).

Relative Level Meter dB-REL

The dB-REL meter measures voltage levels referred to any reference level that is selected. In this way you can very quickly determine the 3-dB points of a transmission band for example. The basic RX mask shows the dB-REL meter in the center, the basic TX and DUPLEX masks show it on the right.

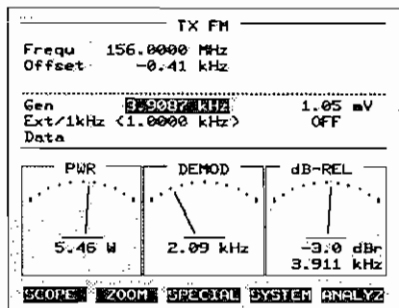

Fig. 5.20: With the dB-REL meter the 3-dB points of a transmission band are soon determined.

Starting

- ⇒ Call up the RMS meter.
- ⇒ Check that AF filters are switched off or correctly set (FILTER menu).

Connecting test signal

Strike **VOLTM**, **DEMOD** or **RX MOD/MODGEN**.

Measuring routine

- ⇒ Set test parameters (eg f_{mod}) so that the RMS meter shows the voltage value that is to be the reference level.
- ⇒ Call up the dB-REL meter, ie strike **dBrel/VOLT** (acknowledgement: the "dBrel" LED lights up). The dB-REL meter adopts the voltage value previously indicated by the RMS meter as its reference level 0 dB.
- ⇒ Every change in the voltage of the test signal (eg caused by change in frequency) is now indicated by the dB-REL meter directly in dB.

Display

- ⇒ Relative level: pointer display for recognition of trend plus numeric display with autoranging.
- ⇒ AF frequency of test signal: numeric display.
- ⇒ Input signal too strong: display >>>>>
- ⇒ Input signal too weak: display -----

Options

- ⇒ AF filters can be connected ahead (see **FILTER** menu).
- ⇒ After **(ZOOM)** + **(MENU)** + **{AF}** + **(MENU)** full-screen display of meter (return with **(TX)**, **(DUPL)** or **(RX)**).

SINAD Meter

The SINAD meter is normally used in RX mode to determine the AF signal quality of a receiver referred to the received RF level (receiver sensitivity). The SINAD value incorporates the AF signal level, the noise level and the distortion according to the following formula:

$$\text{SINAD [dB]} = \frac{\text{Signal} + \text{Noise} + \text{Harmonic}}{\text{Noise} + \text{Harmonic}}$$

CEPT recommendations say that a receiver should require maximally 2 μV EMF at the antenna input in order to produce 12 dB SINAD. The basic RX mask shows the SINAD meter in the center, the basic TX and DUPLEX masks show it on the right.

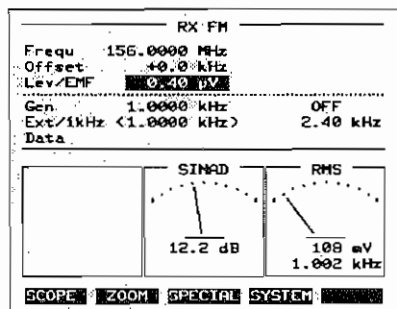

Fig. 5.21: The level value read in the Lev field is the sensitivity of the receiver referred to the displayed SINAD value.

Starting

- ⇒ Call up the basic RX mask and fill in the entry fields (carrier frequency, modulation frequency, degree of modulation, RF output level in EMF).
- ⇒ The modulation frequency must be 1 kHz so that the distortion analysis of the SINAD measurement is correct.
- ⇒ Switch on filters C-weighting or CCITT as required (FILTER menu). Other AF filters have no effect on the SINAD measurement, so it does not matter if they are left switched on.
- ⇒ Connect the AF output of the test item to the VOLTM socket.

Connecting test signal

Strike **VOLTM**.

- Measuring routine** ⇨ Call up the SINAD meter, strike **[SINAD/DIST]** until the "SINAD" LED lights up.
- ⇨ Alter the RF output level of the signal generator (with the spinwheel) until the SINAD meter shows the required value (eg 12 dB). The RF level that you now see in the Lev field is the sensitivity of the receiver referred to the measured SINAD value.
- Display**
- ⇨ SINAD value: pointer display for recognition of trend plus numeric display with autoranging.
- ⇨ Frequency value (AF): numeric display.
- ⇨ Input signal too strong: display >>>>>
- ⇨ Input signal too weak: display -----
- Options**
- ⇨ After **[ZOOM]+[MENU]+{AF}+[MENU]** full-screen display of the meter (return with **[TX]**, **[DUPL]** or **[RX]**).
- ⇨ Automatic sensitivity measurement (SINAD and S/N) with RX Special "SENS" (see Chapter 7).

Distortion-factor Meter DIST

The DIST meter not only offers the usual measurement of distortion factor with a test frequency of 1 kHz, it also permits measurements with an adjustable frequency. The basic RX mask shows the DIST meter in the center, the basic TX and DUPLEX masks show it on the right.

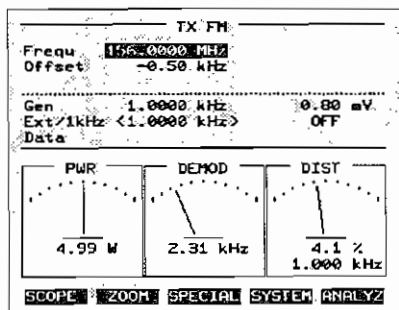

Fig. 5.22: In distortion measurements always make sure that the test frequency set in the FILTER menu and the signal frequency correspond.

Starting

- ⇒ Enter the required test frequency of the distortion-factor meter in the FILTER menu (menu item Dist Notch). Any crossed highpass/lowpass filters have *no* effect on the measurement of distortion.
- ⇒ Cross the CCITT filter or the C-weighting filter in the FILTER menu if required (acknowledgement: CCITT LED lights up).

Callup

Strike **SINAD/DIST** until the "DIST" LED lights up.

Connecting test signal

Strike **VOLTM**, **DEMOM** or **RX MOD/MODGEN**. The signal frequency must correspond to the set test frequency.

Measuring routine

No further entries required. The DIST meter immediately shows the distortion factor of the connected test signal.

Display

- ⇒ Distortion factor: pointer display for recognition of trend plus numeric display with autoranging.
- ⇒ Frequency value (AF): numeric display.
- ⇒ Input signal too strong: display >>>>
- ⇒ Input signal too weak: display -----

Options

After **ZOOM** + **MENU** + {AF} + **MENU** full-screen display of the meter (return with **TX**, **DUPL** or **RX**).

This page is intentionally left blank.

AF Power Meter AF-Pwr

The AF power meter AF-Pwr can be inserted in all basic masks as an alternative to the RMS/DC-VOLT meter. The pointer meter shows the result either in dBm (referred to 600 Ω load) or in mW/W (referred to any load).

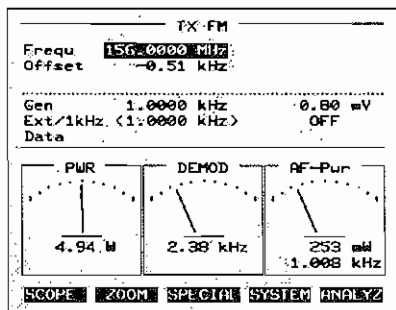

Fig. 5.23: The AF power meter AF-Pwr measures the signal applied to the VOLTM socket.

Starting

- ⇒ **MENU** + **AF-PAR** + {mW/W xxx Ohm | dBm (600Ω)} + **MENU**
xxx = entry field for defining the load resistance.
- ⇒ Check that AF filters are switched off or correctly set (**FILTER** menu).
- ⇒ Connect the VOLTM socket with **VOLTM** and apply the test signal to it.
- ⇒ The declared load resistance must be connected externally across VOLTM and ground if the AF signal source is not terminated with the load (input VOLTM $R_i = 1 \text{ M}\Omega$).

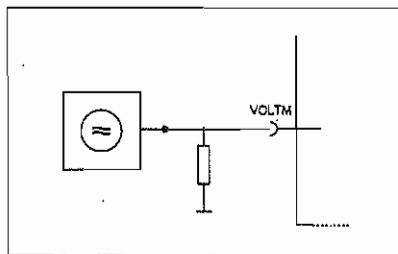

Fig. 5.24: If the AF signal source is not terminated (loudspeaker disconnected), the declared load resistance must be simulated externally.

Callup	Strike [dBre1/VOLT] until the "VOLT" LED lights up.
Connecting test signal	The AF power meter AF-Pwr will only appear if the VOLTM socket is connected. [DEM0D] and [RX MOD/MODGEN] replace the AF-Pwr meter with the RMS meter.
Measuring routine	No further entries required. The AF-Pwr meter immediately measures the power of the AF signal applied to the VOLTM socket.
Display	<ul style="list-style-type: none"> ⇨ AF power: pointer display for recognition of trend plus numeric display with autoranging. ⇨ Frequency value (AF): numeric display. ⇨ Input signal too strong: display >>>>> ⇨ Input signal too weak: display -----
Options	<ul style="list-style-type: none"> ⇨ AF filters can be connected ahead (see Chapter 4, FILTER menu). ⇨ After [ZOOM]+[MENU]+{AF}+[MENU] full-screen display of meter (return with [TX], [DUPL] or [RX]).

Digital Storage Oscilloscope

The digital storage oscilloscope of STABLOCK 4015 can be called from each of the three basic masks. In the bottom half of the mask it replaces the pointer meters with a 6 cm x 3 cm scope window (grid: 10 x 6). The scope offers numerous trigger settings, continuous measurement, one-shot measurement, freezing of a curve at any points in time plus precisely timed measurement of curve segments (technical data: see Appendix A).

Entries can still be made in the upper half of the basic mask. If the test receiver is retuned in TX mode (Frequ entry field) for example, the scope will show the effect of this on the demodulated received signal.

Calling scope

Starting

- ⇒ Call up one of the three basic masks with **TX**, **DUPL** or **RX**.
- ⇒ Cross menu item CCITT, if required, in the FILTER menu. All other crossed filters have *no* effect on the scope.

Callup

Strike the **SCOPE** softkey. The scope window replaces the pointer meters in the basic mask. At the same time the softkeys take on new functions for the operation of the scope. **MENU** now offers menu windows for setting scope test parameters.

Return

TX, **DUPL** or **RX** shows the basic mask again with pointer meters.

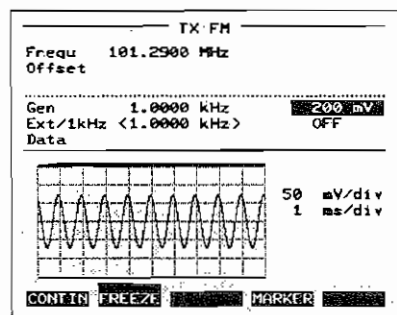

Fig. 5.25: Window of the digital storage oscilloscope.

Connecting test signals (SOURCE menu)

AF signals

[MENU] + [SOURCE] + {VOLTM/DEMODO/MOD} + [MENU]

After this the same AF test signals can be connected, with [VOLTM], [DEMODO] or [RX MOD/MODGEN], as in the case of the pointer meters. To select the trigger conditions, call up the [TRIGGER] menu.



When analyzing the demodulated received signal, observe the IF bandwidth set in the RF-PAR menu (see also "Test Receiver").

TX power

[MENU] + [SOURCE] + {TX Power (DC)} + [MENU]

After this the three keys [VOLTM], [RX MOD/MODGEN] and [DEMODO] are disabled. The test signal that is now connected is the one applied to the selective RF power meter PWR. So the scope can display the transient response of a radio transmitter for example.



The IF test bandwidth is now fixed at 80 kHz (± 40 kHz), regardless of the IF bandwidth set in the RF-PAR menu.

Type of coupling

If you have declared analysis of AF signals, the coupling of the scope input to the test signal can be set with the AC coupled or DC coupled menu item. In analysis of TX power both menu items are disabled because DC coupling is automatic in this case.

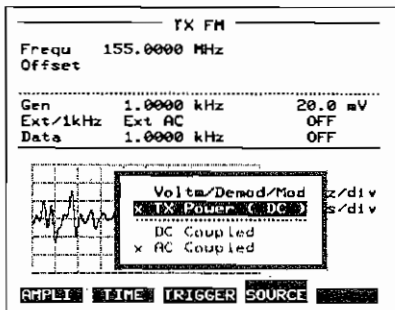

Fig. 5.26: SOURCE menu.

Setting deflection coefficients

Vertical deflection coefficient (AMPLI menu)

MENU + **AMPLI** opens a menu window that permits selection of the vertical deflection coefficient. What deflection coefficients are offered depends on the momentary operating status of STABLOCK 4015 (connected test signal, type of modulation):

Dependence of the vertical deflection coefficient on type of modulation and signal connection.

Connected test signal	Type of modulation		
	AM	FM	Φ M
VOLTM or MODGEN	V/div		
DEMODO	%/div	Hz/div	rad/div
RX MOD	%/div	Hz/div	rad/div
TX Power	W/div		

If TX-FM mode is set, for example, and the demodulation signal is connected with **DEMODO**, the **AMPLI** menu offers vertical deflection coefficients with Hz/div units. The scope then shows the frequency deviation of the received signal. Asymmetry of the deviation and the start of deviation limiting can immediately be recognized.

The deflection coefficient chosen in the menu is shown next to the scope window after the menu window is closed.

Horizontal deflection coefficient (TIME menu)

MENU + **TIME** opens a menu window that permits selection of the horizontal deflection coefficient (100 μ s/div to 500 ms/div in 1-2-5 increments) independently of the momentary operating status of STABLOCK 4051.

The deflection coefficient chosen in the menu is shown next to the scope window after the menu window is closed.

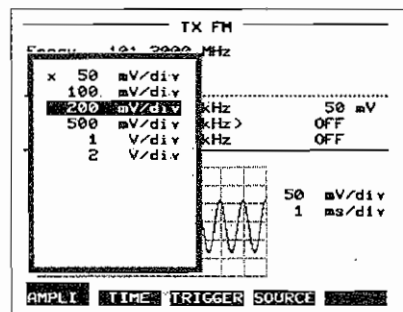

Fig. 5.27: AMPLI menu.

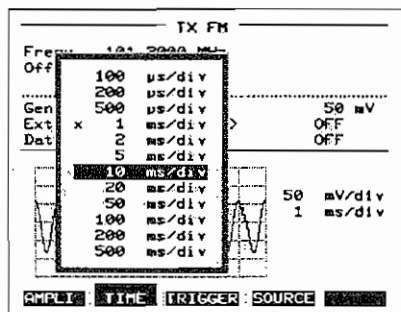

Fig. 5.28: TIME menu.

Trigger settings (TRIGGER menu)

With the trigger setting it is possible to define the time instant when the curve display begins in the scope window. When the proper trigger setting is made, the scope shows precisely the signal segment that you want to look at more closely.

MENU + **TRIGGER** opens a menu window offering the following menu items:

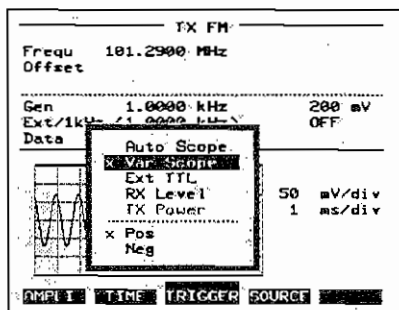

Fig. 5.29: The trigger setting is made by crossing the required menu item.

Auto Scope

This is the standard setting. The trigger level is fixed to the zero line. This means continuous horizontal deflection and display of the curve.

Var Scope

Permits manual setting of the trigger level. Position the cursor in the scope window to the level marker ► (see **Fig. 5.30**) and set the trigger level with the spinwheel (move the marker along the vertical axis). Trigger start: see menu items Pos and Neg.



Ext TTL

If the trigger level is too high, no curve will be displayed.

This permits triggering with external TTL signals applied to socket Bu 18, pin 1 (rear panel). Trigger start: see menu items Pos and Neg.

RX Level

This menu item can only be reached when the scope is called up from RX or DUPLEX mode. Trigger start: turn-on or turn-off time of the signal generator.

Application: measuring a squelch delay. The procedure is as follows:

- Cross **RX Level** and close the menu.
- Apply the AF test signal to the VOLTM socket and connect the socket with **VOLTM**.
- Switch the signal generator off with **LEVEL** + **OFF**.
- Start the measurement with **1-SHOT**.
- Switch the signal generator on with **LEVEL** (trigger instant).

TX Power

This menu item can only be reached when the menu item **TX Power** is crossed in the **SOURCE** menu. Trigger start: the applied TX power reaches a level of 0.3 of the set vertical deflection coefficient (5 % from the top line). Example: vertical deflection coefficient = 3 W/div; top line = 3 W/div × 6 div = 18 W; trigger level = 0.9 W.

Application: measuring transmitter transients. The procedure is as follows:

- Cross **TX Power** and close the menu.
- Start the measurement with **1-SHOT**.
- Switch on the transmitter.

Pos Neg

The menu items **Pos** and **Neg** can only be reached if the menu item **Var Scope** or **Ext TTL** is crossed beforehand.

- ⇒ **Var Scope**: Trigger start = set trigger level is reached by the rising (**Pos**) or falling (**Neg**) signal edge.
- ⇒ **Ext TTL**: trigger start = H level (**Pos**) or L level (**Neg**) on pin 1, socket Bu 18.

Scope functions

Trigger setting	Scope function		
	CONTIN	FREEZE	1-SHOT
Auto Scope	X	X	
Var Scope	X	X	X
TX Power			X
RX Level			X
EXT TTL	X	X	X

Scope functions for selected trigger settings.

Continuous curve display (CONTIN)

CONTIN produces a continuous curve display. This standard scope function is best for periodic test signals. If the set trigger condition is fulfilled at least every 30 ms, the window will show a stationary curve.

The **AUTO** softkey selects the vertical deflection coefficient automatically so that the window is optimally filled. The selected value is displayed to the right of the window. The softkey is only available when the CONTIN function is active.

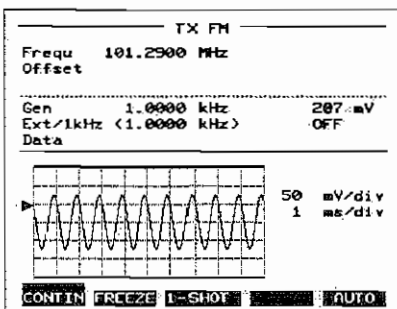

Fig. 5.30: Here the CONTIN function is active, noticeable by the highlighted softkey.

Frozen curve (FREEZE)

The **FREEZE** softkey freezes the curve that is displayed at the instant the key is operated (softkey is highlighted). This produces a stationary curve of non-periodic signals too. **FREEZE** is required for precisely timed measurement of curve segments with the MARKER function. Striking **CONTIN** produces the continuous curve display again.

One-shot measurement (1-SHOT)

The **(1-SHOT)** softkey starts a one-shot measurement. First the scope waits until the test signal satisfies the set trigger condition (message: Waiting for Trigger). From then on the test signal is recorded and then displayed as a frozen curve. The 1-SHOT function is best in the case of a transient signal (see also "Trigger settings"). Striking **(CONTIN)** produces the continuous curve display again.

Measuring curve (MARKER)

A curve that has been frozen with **(FREEZE)** can be precisely timed with the MARKER function.

Calling up marker Strike **(MARKER)**. This produces the display of a "time-measurement field", the width of which can be varied with the spinwheel.

Setting marker Move the right edge of the measurement field to the required start position (beginning or end of the curve segment that is to be measured) and strike **(SET)**.

Measuring Expand the measurement field to the required curve segment. Read the duration of the marked segment in the display field (resolution: 1/200 of the horizontal deflection coefficient).

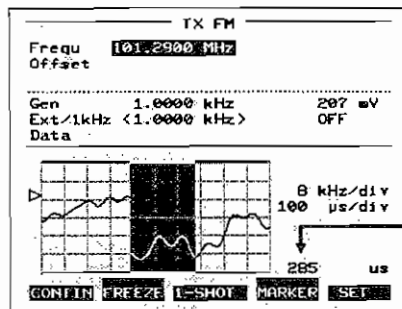

Fig. 5.31: The measurement field permits precise determination of the time duration of any curve segments.

AF Generators

The standard STABILOCK 4015 incorporates the AF generator GEN (frequency and level variable) and a fixed-frequency generator ($f = 1$ kHz, level variable). The optional DATA module offers an AF generator DATA in addition (frequency and level variable).

Depending on the operating mode of STABILOCK 4015, the AF generators offer the following possibilities of use:

- In RX mode: feeding of the signal generator with up to three modulation signals.
- In TX mode: output of up to three superimposed AF signals on the MODGEN socket, eg for feeding the microphone input on the test item.
- In DUPLEX mode: combination of modulation of the signal generator and signal output on the MODGEN socket (only with the optional DUPLEX synthesizer).

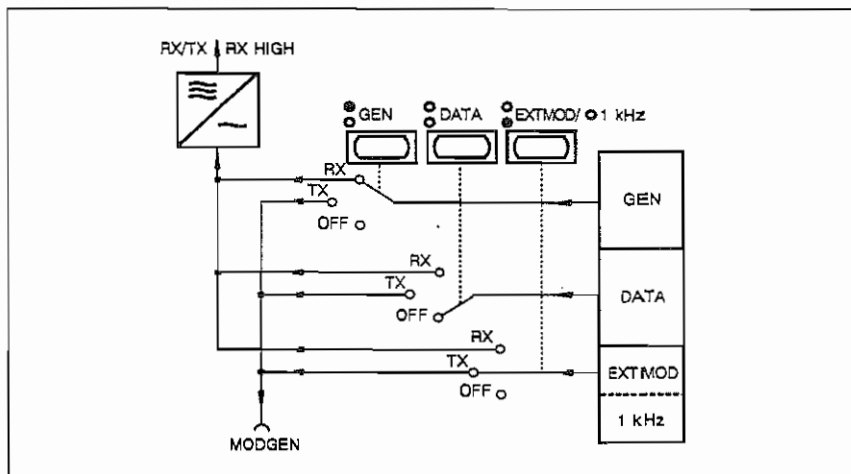

Fig. 5.32: Depending on the operating modes RX and TX, the signal of the AF generators can either be connected to the signal generator or output on the MODGEN socket. Only in DUPLEX mode do you have the choice between the two signal paths.

Operating generator GEN

Switching on generator GEN, depending on the operating mode, also switches the AF signal path (feeding of the signal generator or signal output on the MODGEN socket, see Fig. 5.32):

Switching on

- ⇒ RX mode: generator GEN is switched on and off with **GEN**.
- Acknowledgement: when the generator is switched on, the green LED lights up (RX signal path switched; AF signal feeds 4015 signal generator).
- ⇒ TX mode: generator GEN is switched on and off with **GEN**.
- Acknowledgement: when the generator is switched on, the red LED lights up (TX signal path switched; signal appears on MODGEN socket).
- ⇒ DUPLEX mode: generator GEN is *alternately* connected to the RX or TX signal path or switched off by repeatedly striking the **GEN** key.
- Green LED lights up: AF signal feeds 4015 signal generator (RX signal path).
- Red LED lights up: AF signal appears on MODGEN socket (TX signal path).

Setting frequency

MODFREQ + Numeric value + **ENTER**

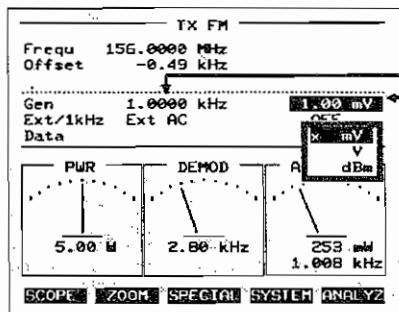

Fig. 5.33

Frequency entry
Level entry

In level entries (in TX mode) you can select the units.

Setting level

MOD + Numeric value + **ENTER**

- ⇒ Green LED "GEN" lights up: numeric value = modulation deviation or depth.
- ⇒ Red LED "GEN" lights up: numeric value = voltage value.
If the voltage value requires different units, replace the **ENTER** entry with:
UNIT/SELECT + {mV | V | dBm} + **ENTER**
- When dBm units are declared, the displayed level value is only correctly referred to 600 Ω load if the source resistance on the MODGEN socket (R_i = approx. 5 Ω) is increased to 600 Ω with an external series resistor.
- ⇒ Striking **MOD** automatically switches on generator GEN.

Operating 1-kHz generator

Switch the 1-kHz generator on with the **EXT MOD** key. If the "1 kHz" LED does not light up, you will have to start as follows:

Starting **MENU** + **MOD-PAR** + {1 kHz Mod} + **MENU**

Acknowledgement: entry <1.0000 kHz> in the frequency entry field of the Ext/1kHz line.

Switching on Like generator GEN but with the **EXT MOD** key.

The yellow LED "1 kHz" signals that the internal 1-kHz generator has been switched on with **EXT MOD**.



A signal applied to the EXT MOD socket will have no effect if the "1 kHz" LED lights up!

Setting frequency

Not possible ($f = 1$ kHz).

Setting level

Locate the level entry field in the Ext/1kHz line with the cursor keys, enter the value and confirm it with **ENTER** (otherwise like generator GEN).

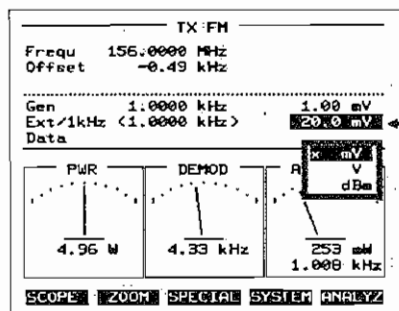

Fig. 5.34

Level entry

Applying external AF signal

Alternatively to the internal 1-kHz generator, an external signal can be used, applied to the EXT MOD socket. The coupling of this signal is selectable (AC or DC) and the modulation sensitivity of the signal generator can be adjusted for this signal.

AC/DC coupling **[MENU] + [MOD-PAR] + {Ext AC | Ext DC-FM} + [MENU]**

Ext DC-FM can only be crossed if FM modulation is crossed first in the MOD-PAR menu window.

⇒ Acknowledgement for AC coupling: display Ext AC in line Ext/1kHz.

⇒ Acknowledgement for DC coupling: display Ext DC-FM in line Ext/1kHz.

⇒ The selection of AC/DC coupling automatically disables the internal 1-kHz generator.

Switching on

Like generator GEN but with the **[EXT MOD]** key.

The yellow LED "1 kHz" remains dark. This confirms that the external AF signal is connected with **[EXT MOD]**.

Standard modulation sensitivity

[MENU] + [MOD-PAR] + {Ext FIX} + [MENU]

Acknowledgement: display FIX in line Ext/1kHz.

The signal on EXT MOD now produces certain modulation of the signal generator (see "Technical Data").

If this modulation sensitivity is insufficient (eg for a condenser microphone), it is possible, by crossing the menu item Mic <25mV, to cut in an AC-coupled 40-dB amplifier (f = 300 Hz to 3 kHz), which increases the standard modulation sensitivity by a factor of 100 (from V > 25 mV over-driving!).

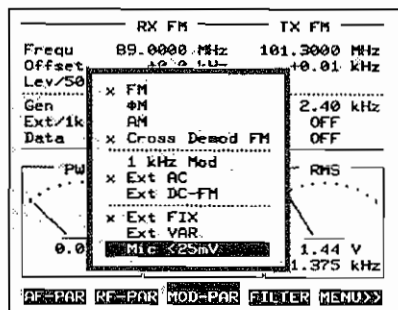

Fig. 5.35: In the MOD-PAR menu, the menu item Mic <25mV only appears if the menu item Ext FIX is crossed.



If all the following apply at the same time, there may be microphonics:

- A microphone is connected to the EXT MOD socket.
- High modulation sensitivity is set.
- The signal has been connected to the internal AF signal analysis with **[RX MOD/MODGEN]**.

Remedy: reduce the volume with the control next to the PHONE socket.

Variable modulation sensitivity

If continuously adjustable modulation sensitivity is required, cross the menu item **Ext. VAR** in the **MOD-PAR** menu and then locate the level entry field in the bottommost menu item with the cursor keys. Enter the value and confirm it with **[ENTER]**.

Acknowledgement: display **VAR** in line **Ext / 1kHz**.

- Example: 1kHz ← 50.0 mVp means that a 50-mV signal applied to the EXT MOD socket produces 1 kHz frequency deviation.
- ⇒ If the EXT MOD socket is connected to the TX signal path (see generator GEN), gain/attenuation can be declared with the bottommost menu item.
- Example: 100 mV ← 50.0 mV means that a 50-mV signal applied to the EXT MOD socket is output on the MODGEN socket with 100 mV.

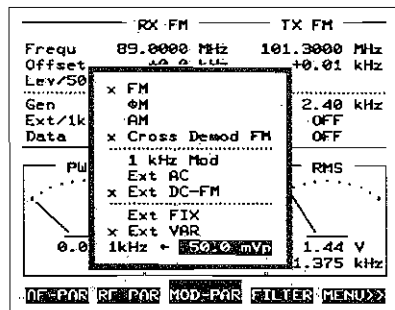

Fig. 5.36: Here variable modulation sensitivity has been set in the **MOD-PAR** menu.

Overlaid signals

If a number of AF signal sources (GEN, DATA, 1 kHz/EXT MOD) are switched on at the same time, the RX or TX signal path will carry the sum signal. In DUPLEX mode the LEDs signal not only the startup of a generator but also whether the signal is switched to the RX or TX signal path.

RX mode All signal sources (green LEDs light up) feed the modulator of the signal generator (RX signal path). The modulation meter MOD shows the result of this overlaid modulation.

TX mode The MODGEN output socket carries the sum signal of all activated signal sources (TX signal path, red LEDs light up).

DUPLEX mode

- ⇒ Green LED light up: the signal source is switched to the RX signal path and feeds the signal generator.
- ⇒ Red LED light up: the signal source is switched to the TX signal path and feeds the MODGEN output socket.

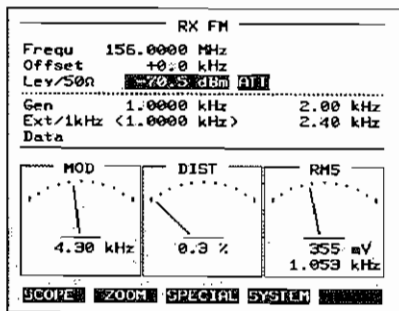

Fig. 5.37: With overlaid modulation the MOD meter shows the sum modulation in RX mode.

Checking AF output signals

Connecting the internal AF signal analysis to the AF signal generators enables the AF output signals to be checked with the AF measuring devices (RMS, dB-REL, DIST, AF-Pwr, Scope). This is particularly useful for overlaid signals.

- Connection In RX mode** Strike **RX MOD/MODGEN**.
Acknowledgement: green LED above **RX MOD/MODGEN** lights up.
Check of the signal feeding the modulator of the signal generator.
- Connection In TX mode** Strike **RX MOD/MODGEN**.
Acknowledgement: red LED above **RX MOD/MODGEN** lights up.
Check of the signal that appears on the MODGEN socket.
- Connection In DUPLEX mode** Repeatedly strike **RX MOD/MODGEN**.
Acknowledgement: above **RX MOD/MODGEN** the green or red LED lights up.
⇒ Green LED lights up: check of the signal that feeds the modulator of the signal generator.
⇒ Red LED lights up: check of the signal that appears on the MODGEN socket.

DC Voltmeter DC-VOLT

The pointer meter DC-VOLT can be called up in all basic masks as an alternative to the RMS/AF-Pwr meters.

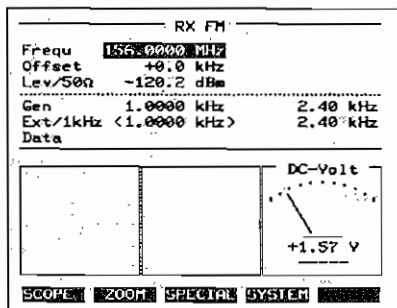

Fig. 5.38: The DC voltmeter measures a DC signal applied to the VOLTm socket.

- Starting** ⇒ **MENU** + **AF-PAR** + {DC Volt} + **MENU**
⇒ Connect the VOLTm socket with **VOLTm** and apply the test signal.
- Callup** Strike **dBrel/VOLT** until the "VOLT" LED lights up.
- Connecting test signal** The DC voltmeter only appears when the VOLTm socket is connected.
DEM0D and **RX MOD/MODGEN** replace the DC-VOLT meter with the RMS meter.
- Measuring routine** No further entries required. The DC-VOLT meter immediately measures the DC voltage applied to the VOLTm socket.
- Display** ⇒ DC-voltage value: pointer display for recognition of trend plus numeric display with autoranging.
⇒ Input signal too strong: display >>>>
⇒ Input signal too weak: display -----
- Options** After **Z00M** + **MENU** + {AF} + **MENU** full-screen display of the meter (return with **TX**, **DUPL** or **RX**).

Selective-call Tester

For testing selective-call radio sets STABLOCK 4015 comes fitted to standard with a selective-call encoder and decoder that offers ten standard tone sequences (eg CCIR, CCITT and ZVEI). The parameters of each tone sequence (frequency, tone duration, pause) can be altered as wished. Any user tone sequences that are produced in this way can be stored and recalled at any time. The following selective-call modes are available to you: "Call only", "Decode only" and "Call → decode".

For all entries you have a "test mask" and its menus available. This test mask also shows the decoded call tones of a received tone sequence. If an acknowledgement call is received, the response time of the acknowledgement-call system will also be indicated. For detailed analysis of all decoded call tones there are two "result masks".

Calling up test mask

You can call up the test mask from any of the three basic masks. The complete call instruction is:

(SYSTEM) + (MENU) + (SYSTEM) + {Sequential} + (MENU)

Once you cross the Sequential menu item (Fig. 5.39), it is sufficient to tap the **(SYSTEM)** softkey in the basic mask to call up the test mask. This test mask covers the bottom half of the basic mask (Fig. 5.40).

Returning to basic mask

(TX), **(DUPL)** or **(RX)** take you back to the basic mask.

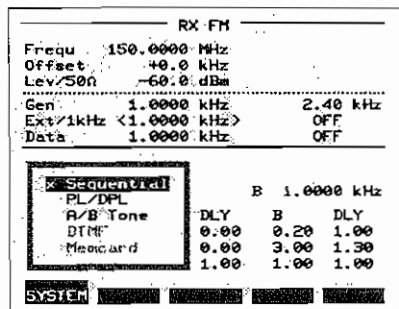

Fig. 5.39: The SYSTEM menu permits, independently of the status of the Communication Monitor, call up of the selective-call tester.

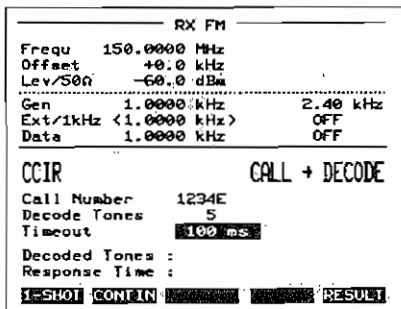

Fig. 5.40: The test mask of the selective-call tester (bottom half) shows the entries from the last session when it is called up.

Choosing selective-call mode

Entry The PARMS menu of the test mask offers three menu items to cross for choosing the selective-call mode (Fig. 5.41):

[MENU] + [PARMS] + {CALL → DECODE | CALL ONLY | DECODE ONLY} + [MENU]

Acknowledgement: display of the selected mode in the test mask.

CALL → DECODE Mode for acknowledgement calls (only possible if the optional DUPLEX Synthesizer is installed). First the encoder generates the required tone sequence. As soon as the last tone has been sent, the tester switches from encode to decode and waits for the arrival of a tone sequence (the last pause of the output tone sequence is not awaited).

CALL ONLY The encoder generates the required tone sequence. There is no decoding of received tone sequences (the decoder is not activated).

DECODE ONLY The decoder awaits the arrival of a tone sequence. When it is received, it is decoded. The encoder is not activated in this mode.

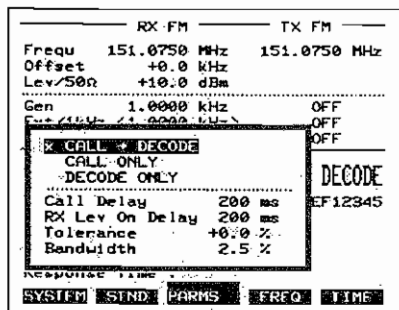

Fig. 5.41: The mode of the selective-call tester is declared in the PARMS menu.

Connecting test item

Before calling up the test mask you must call up the correct basic mask, because this determines the signal path between the test item and the tester (Fig. 5.42). The signal paths (RF/AF), depending on the basic mask, that are possible in the three selective-call modes are shown in the following Table:

Mode	Basic mask in background		
	TX	DUPLEX	RX
CALL→DECODE	Illegal combination	RF	Illegal combination
CALL ONLY	AF	RF	RF
DECODE ONLY	RF and AF	AF	AF

Permissible signal paths as function of basic mask and mode

Example: You call up the selective-call tester from the basic TX mask and choose the CALL ONLY mode. The table shows that in this case a tone sequence can only be output on the AF signal path.

RF signal path

Selecting input/output

Couple the required RF input/output socket with the selector key and connect the test item accordingly.

Coupling demodulated signal

Couple the AF signal to the decoder with **DEMOD** (only necessary for receiving tone sequences in the two modes CALL→DECODE or DECODE ONLY).

AF signal path

Input socket

Feed in incoming tone sequences on the VOLTM socket and couple this socket to the decoder with **VOLTM**.

Output socket

The tone sequence generated by the encoder appears on the MODGEN socket.

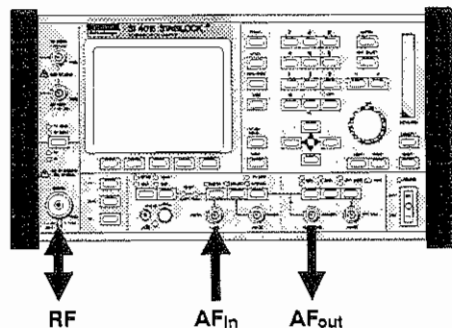

Fig. 5.42: The selective-call tester can send and receive tone sequences on the RF or AF signal path. The signal path that is permissible depends on which basic mask is visible in the top half of the monitor.

Declaring test parameters

Declaring test parameters involves entries in the basic mask, in the test mask and in the menus of the test mask.

Starting

- ⇒ Switch off all AF generators. When a tone sequence is output, the generator GEN is automatically activated for the duration of the tone sequence (see also "Special functions").
- ⇒ Check that the basic settings (eg type of modulation, selected IF bandwidth, squelch) are correct.

Entries in basic mask

The entries that are necessary in the current basic mask depend on the selective-call mode and the signal path (RF/AF) that is used:

CALL→DECODE	RF signal path: enter transmit and receive frequency plus RF output level. Switch generator GEN to the RX signal path (green LED lights up) and enter the required modulation in the Gen line. Then switch generator GEN off again! AF signal path: not allowed.
CALL ONLY	RF signal path: enter transmit frequency and RF output level. Switch on generator GEN (green LED lights up) and enter the required modulation in the Gen line. Then switch generator GEN off again! AF signal path: switch on generator GEN (red LED lights up) and enter the required AF output level in the Gen line. Then switch generator GEN off again!
DECODE ONLY	RF signal path: enter receive frequency. AF signal path: no entries necessary.

Entries in test mask

RX FM	
Frequ	150.0000 MHz
Offset	+0.0 kHz
Lev/50n	-60.0 dBm

Gen	1.0000 kHz 2.00 kHz
Ext/1kHz	<1.0000 kHz> OFF
Data	1.0000 kHz OFF

CCIR	CALL → DECODE
Call Number	1234E
Decode Tones	5
Timeout	100 ms
Decoded Tones :	
Response Time :	
<input type="checkbox"/> SHOW <input type="checkbox"/> CONTIN <input type="checkbox"/> RESULT	

Fig. 5.43: The test mask offers three entry fields: one for the encoder and two for the decoder. All entry fields are accessible with the cursor keys.

Call Number

Locate the Call Number entry field (Fig. 5.43) with the cursor and strike **[OFF]**: this deletes an existing call number and assigns to the softkeys the functions **[A]** through **[E]** (entry of hexadecimal digits; enter F on the decimal-point key). Then enter a new call number (max. 20 places). Correct entry errors by overwriting them. Terminate your entry with **[ENTER]**.

Decode Tones

The figure in the Decode Tones entry field specifies how many call tones of an incoming tone sequence are to be decoded (permissible range: 0 to 20).

Timeout

The entry in the Timeout field (permissible range: 0 to 9999 ms) prevents incomplete tone sequences from continuously blocking the decoder. The timeout counter is started at the end of the first decoded call tone. With the beginning of each following call tone there is a restart. If no call tone arrives during the timeout, there is no restart and the decoder stops decoding.

A timeout figure that is too small can cause decoding to stop in the case of tone sequences that contain pauses.

Arriving tone sequence	Continuous tone
------------------------	-----------------

Timeout counter is not started

Arriving tone sequence	1st tone	Pause	2nd tone	Pause
Timeout = long enough		Start	Restart	

Timeout causes no decoding halt

Arriving tone sequence	1st tone	2nd tone	Pause	3rd tone
Timeout = too short		Start		Halt

Timeout causes decoding halt

Choosing tone sequence (STND menu)

Entry

MENU + **STND** opens a menu window offering ten standard tone sequences and one user tone sequence (Fig. 5.44). Mark the required entry with the cursor bar, strike **UNIT/SELECT** and close the menu window again with **MENU**. The selected tone sequence is shown top left in the test mask.



With the **FREQ** and **TIME** menus you can also alter a standard tone sequence. In such cases non-standard will appear in the test mask to remind you of the alteration.

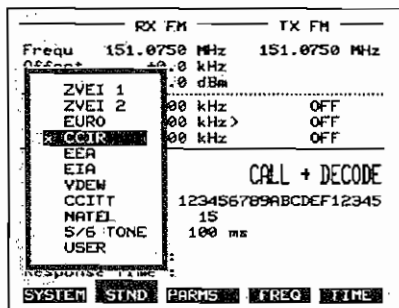

Fig. 5.44: The STND menu offers selection of all common tone sequences.

Test parameters under PARMS menu

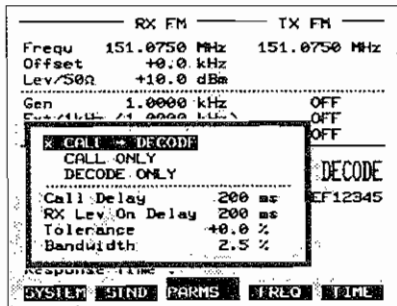

Fig. 5.45: The PARMS menu, in the bottom half of the window, presents four menu items for entering test parameters.

Call Delay

The value entered under the Call Delay menu item (Fig. 5.45) is inserted as a pause between the repeated output of a tone sequence. So this call delay is only effective if a test is started with **CONTIN** (continuously repeated output of a tone sequence).

1st call	Call delay	2nd call	Call delay	3rd call	Call delay
----------	------------	----------	------------	----------	------------

RX Lev On Delay

The value entered under the RX Lev On Delay menu item defines a delay between the keying of the signal generator and the beginning of tone-sequence output (application: awaiting transients of the test item). This "lead" or "warmup" time is only effective if the signal generator has been switched off with **LEVEL** + **OFF** before starting a test.

Tolerance

A purposely entered frequency offset of the output call tones tests the decoder bandwidth of the test item. The frequency offset is entered as a percentage deviation of the call-tone frequencies from their supposed values under the Tolerance menu item (permissible range: 0 to $\pm 9.9\%$). The supposed frequencies of the current tone sequence are listed in the FREQ menu.

Bandwidth

If call tones are received with a frequency offset, it will depend on the value under the Bandwidth menu item whether these tones can still be decoded by the tester. In analogous manner to the tolerance when sending call tones, this bandwidth also refers to their supposed frequency. Values from 0 to 9.9% are permissible (typical: 2.5%).

Altering frequencies (FREQ menu)

Altering frequency of call tones For the selected tone sequence the FREQ menu (Fig. 5.46) shows the allocation between call tones and frequencies. The frequencies can be altered as wished (locate entry with cursor bar, alter and confirm with **ENTER**). After you return to the test mask, the non-standard message reminds you of these alterations. The next time you call up the altered tone sequence (STND menu) it will have its original values again.

Altering repeat tone

Move the cursor to the entry field of the Repeat Tone menu item and enter the number of the call tone that is to be used as a repeat tone. For entering A through E first strike **ENTER**: this permits entry of the hex characters with the softkeys (enter F with the decimal-point key).

Call number	5	6	7	7	8	8	8
Tone sequence	5	6	7	F	8	F	8

Example: repeat tone F replaces the second of a number of identical call digits.

Restoring standard values

Following alterations in the FREQ menu it is very simple to restore the standard values of the current tone sequence: move the cursor bar to the Norm menu item and strike **UNIT/SELECT**.

Creating user tone sequence

Alter the frequencies as you want them, move the cursor bar to the Store to User menu item and strike **UNIT/SELECT**. Alter the values for tone duration and pause in the TIME menu. In the STND menu you call up a user tone sequence with the USER menu item.

The screenshot shows the FREQ menu with the following data:

Frequency (Hz)	CCIR	
0 1951.0	B	1747.0
1 1124.0	9	1860.0 OFF
2 1197.0	A	2400.0 OFF
3 1275.0	B	930.0 OFF
4 1358.0	C	2247.0
5 1446.0	D	991.0
6 1540.0	E	0.0
7 1640.0	F	2110.0

Additional menu items and settings visible in the screenshot:

- Repeat Tone: F
- Store to User: Norm
- DECODE: EF12345
- Buttons at the bottom: SYSTEM, STND, HARMS, FREQ, TIME

Fig. 5.46: Here the FREQ menu shows the frequencies of the CCIR tone sequence.

Altering tone/pause duration (TIME menu)

Altering tone and pause duration

The TIME menu (Fig. 5.47) shows the following allocation for the selected tone sequence: call digit, associated tone duration and pause duration until the output of the next call digit. The values of the 1st through the 14th call digit can be altered individually (locate entry with cursor bar, alter value and confirm with **ENTER**). The values of the 15th through the 20th call digit can only be altered jointly. After you return to the test mask, the non-standard message reminds you of these alterations

Setting entries to same value

It is very simple to give all call digits the same value of tone and pause duration. Locate the entry field of the All Durations or All Pauses menu item with the cursor, enter the required value and confirm your entry with **ENTER**. The value will be adopted immediately in all entry fields concerned.

Restoring standard values

Following alterations in the TIME menu it is very simple to restore the standard values of the current tone sequence: move the cursor bar to the Norm menu item and strike **UNIT/SELECT**.

Creating user tone sequence

Alter the values as you want them, move cursor bar to the Store to User menu item and strike **UNIT/SELECT**. The assignments between call tones and frequencies can be altered in the FREQ menu. In the STND menu you call up a user tone sequence with the USER menu item.

Duration, Pause (ms)	CCIR	kHz
1st 100 0	8th 100 0	
2nd 100 0	9th 100 0	
3rd 100 0	10th 100 0	
4th 100 0	11th 100 0	
5th 100 0	12th 100 0	
6th 100 0	13th 100 0	
7th 100 0	14th 100 0	
	>15th 100 0	
All Durations: 100		
All Pauses: 0		
Store to User	Norm	

Response time

SYSTEM STND PARMS FREQ TIME

Fig. 5.47: Here the TIME menu shows the tone durations and pauses of the CCIR tone sequence.

Special functions

Carrier keying

⇒ For output on the RF signal path, switch the signal generator off with **LEVEL** + **OFF** before starting a test. When the test is started, the signal generator is keyed automatically for the duration of a tone sequence. If required, declare a call delay in the **PARMS** menu under the **RX Lev On Delay** menu item (awaiting transients of the test item).

Implanting continuous tone

⇒ Continuous tone before and after output of a tone sequence: before starting the test, switch on the generator **GEN** and enter the frequency of the continuous tone in the **Gen** line.

⇒ 1-kHz continuous tone before, *during* and after a tone sequence: before starting the test, switch on the 1-kHz generator and enter the required level in the **Ext/1kHz** line (see also major section "AF Generators", subsection "Operating 1-kHz generator"). If the optional **DATA** Module is installed, the **DATA** generator can be used instead of the 1-kHz generator.

Starting test cycle

After selecting the mode, connecting the test item and declaring the test parameters, start the test with **(1-SHOT)** or **(CONTIN)**.

One-shot test

(1-SHOT) produces a single run of the test cycle in the declared selective-call mode:

- | | |
|-------------|---|
| CALL ONLY | The encoder outputs the declared tone sequence once. For carrier keying the call delay entered in the PARMS menu will be effective (RX Lev On Delay menu item). |
| DECODE ONLY | The decoder awaits the arrival of a tone sequence. As soon as it is received, it is decoded and the result is displayed (Decoded Tones display field and result masks). |
| CALL→DECODE | The encoder outputs the declared tone sequence once. For carrier keying the call delay entered in the PARMS menu will be effective (RX Lev On Delay menu item). Then the decoder awaits the arrival of the acknowledgement call. When the acknowledgement call is received, it is decoded and the results are displayed (Decoded Tones and Response Time display fields plus result masks). |

For as long as the test lasts, softkey **(1-SHOT)** adopts the function **(STOP)**; all other keys are locked.

Continuous test

(CONTIN) produces repeated running of the test cycle in the declared selective-call mode:

- | | |
|-------------|---|
| CALL ONLY | The encoder outputs the declared tone sequence continuously. Before each output of the tone sequence there is the call delay declared in the PARMS menu (Call Delay menu item). For carrier keying there is also the call delay declared under the RX Lev On Delay menu item. Press (STOP) to halt the test. |
| DECODE ONLY | Received tone sequences are decoded and the results continuously updated in the Decoded Tones display field and the result masks. Press (STOP) to halt the test. |

CALL→DECODE The call/decode test cycle is repeated continuously. Before each output there are the call delays declared in the **PARMS** menu (Call Delay menu item and RX Lev On Delay for carrier keying). The received acknowledgement calls are decoded and the results continuously updated in the **Decoded Tones** and **Response Time** display fields plus the result masks. Press **(STOP)** to halt the test.

Acoustic check

When sending Couple the internal AF-signal analysis to the decoder with **(RX MOD/MODGEN)** and turn up the volume control.

When receiving Turn up the volume control.

Results of decoding

Decoded Tones

The Decoded Tones field of the test mask shows - in modes DECODE ONLY and CALL→DECODE - the decoded call tones of the received tone sequence (Fig. 5.48). You evaluate the number of call tones declared in the Decode Tones field (max. 20 single tones; no double tones). Dashes symbolize missing or non-decodable call tones.

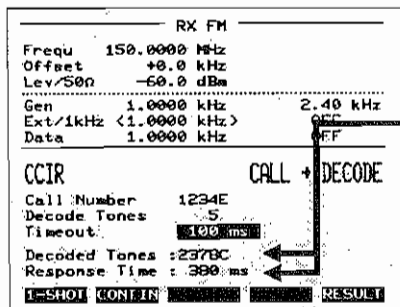

Fig. 5.48: In the Decoded Tones and Response Time fields the test mask shows important results.

Response Time

In the CALL→DECODE mode the Response Time field shows the response time of an acknowledgement-call system (measured time between the end of the last tone sent and the beginning of the acknowledgement call).

Last call tone sent		1st tone of acknowledgement call	
Tone	Pause		Tone	Pause
Response time				

If the last call tone is followed by a pause (depending on the tone sequence), this will be ignored when measuring the response time.

Result masks

(RESULT) takes you from the test mask to the result masks (return from there with (SYSTEM)). The received call digits are presented with the following results (Fig. 5.49):

- decoded call tones (Nr)
- measured frequency of call tones (Freq)
- frequency deviation from supposed value (Dev)
- measured tone duration (Duration)
- measured pause duration (Pause)

Dashes symbolize missing or non-decodable call tones. If a tone or a pause lasts longer than 10 s, the display will show >>>>.> (always for the last pause of a decoded tone sequence).

Sequential Results					1..10
	Nr	Freq. (Hz)	Dev. (%)	Duration (ms)	Pause (ms)
1	2	1198.0	0.1	105.0	0.7
2	3	1275.1	0.0	98.6	1.1
3	7	1640.4	0.0	98.6	0.6
4	8	1747.1	0.0	97.3	0.8
5	C	2247.8	0.0	102.2	>>>>.>
6					
7					
8					
9					
10					

1-SHOT CONTIN 1..10 11..20 SYSTEM

Fig. 5.49: The result masks show the parameters of up to 20 decoded tone sequences.

(11..20) scrolls the second result mask (parameters of call digits 11 through 20), (1..10) scrolls back to the first result mask.

(1-SHOT) and (CONTIN) will also trigger a test in the result masks so that the decoding of received call digits can be observed direct. During decoding it is permissible, without disturbing the process, to change from one result mask to another.

(MENU) in the result masks takes you to the same menus as in the test mask.

Computer-aided processing of results

The IEEE command RESULT1 reads the contents of the Decoded Tones field of the test mask. RESULT1 can then be further processed like a string variable, eg printout of the decoded tone sequence with PRINT RESULT1 in an AUTORUN program.

A/B Tone Encoder

STABILOCK 4015 is also fitted to standard for testing selective-call radios that work by the A/B tone principle (A/B tone pagers). These units are addressed by two consecutive call tones of freely definable frequency (tone A and tone B). After each tone there is a pause, the duration of which depends on the pager type (pause duration can also be 0).

Calling up test mask

The test mask can be called up from any of the three basic masks. The complete call instruction is:

(SYSTEM) + **(MENU)** + **(SYSTEM)** + {A/B Tone} + **(MENU)**

Once the A/B Tone menu item is crossed, you only have to strike the **(SYSTEM)** softkey in the basic mask to call the test mask up again. The test mask appears in front of the bottom half of the basic mask (Fig. 5.50).

Calling the test mask automatically puts you into RX mode.

Returning to basic mask

(TX), **(DUPL)** or **(RX)** takes you back to the particular basic mask.

RX FM			
Frequ	55.0000 MHz		
Offset	+0.0 kHz		
Lev/50n	+13.0 dBm		

Gen	1.0000 kHz	2.40 kHz	
Ext./1kHz	<1.0000 kHz>		OFF
Data			
A/B Tone Encode			
A	1.0000 kHz	B	1.0000 kHz
x TONE	A 0.40	DLY 0.00	B 0.20 DLY 1.00
TN&VCE	1.00	0.00	3.00 1.30
USER	1.00	1.00	1.00 1.00
1-SHOT CONTIN			

Bild 5.50: Test mask of A/B tone encoder

Frequency entry fields for tones A and B

Tone B: entry field for pause duration

Tone A: entry field for tone duration

Tone A: entry field for pause duration

Tone B: entry field for tone duration

All time figures in **seconds**

Selecting pager type

With STABLOCK 4015 you can test the following types of pager:

Pager type	Tone/pause duration	Entry field
Tone only	Tone and pause duration are fixed, see Fig. 5.50.	TONE
Tone & voice	Tone and pause duration are fixed, see Fig. 5.50.	TN&VCE
Random A/B tone pagers	Tone and pause duration variable (max. 9.99 s).	USER

Selecting type Move the cursor bar to the entry field for the required pager type (Fig. 5.50) and cross field with **UNIT/SELECT**.

Declaring test parameters

Frequency Enter the required value in the frequency fields for tones A and B (Fig. 5.50) and confirm with **ENTER** (permissible values: 30 Hz to 30 kHz).

 Defining the tone and pause duration for both tones is only possible in the USER line. The entered values do not become effective until the USER entry field is crossed.

Tone duration Enter the required values in the fields for tone duration (Fig. 5.50) and confirm with **ENTER** (permissible values: 0.01 s to 9.99 s).

Pause duration Enter the required values in the fields for pause duration (Fig. 5.50) and confirm with **ENTER** (permissible values: 0 s to 9.99 s).

Starting test cycle

Starting

- ⇒ Tune the signal generator to the receive frequency of the pager.
- ⇒ Couple the RF socket RX HIGH and connect the antenna to it.
- ⇒ Set maximum RF output level.
- ⇒ Select the pager type.
- ⇒ Declare the test parameters.

One-shot test

Strike **(1-SHOT)**. The Communication Monitor transmits the two tones A and B once on the carrier frequency with the declared parameters.

Tone A	Tone B	End
Pause A	Pause B	

Continuous test

Strike **(CONTIN)**. The Communication Monitor transmits the two tones A and B continuously on the carrier frequency with the declared parameters.

Tone A	Tone B	Tone A
Pause A	Pause B	Pause A

Pager reactions

Pagers of the tone-only type respond with an acoustic signal or with vibration for example. On tone & voice pagers, addressing with the correct A/B tone sequence causes the squelch to open. Some also respond for the duration of the B tone with an acoustic signal or vibration.

Further measuring devices: see Chapter 6

Some hardware options make further measuring devices or test functions available (DUPLEX synthesizer, DTMF module, PL/DPL tester, etc). The instructions for these are supplied with the hardware options. For units that already include hardware options, works, Chapter 6 contains the matching instructions.

(

(

(

Hardware Options



Introduction



Chapter 6 is reserved for describing the hardware options. When you order one of these hardware options, you will receive the pages that describe its use. You can then file them under this chapter.

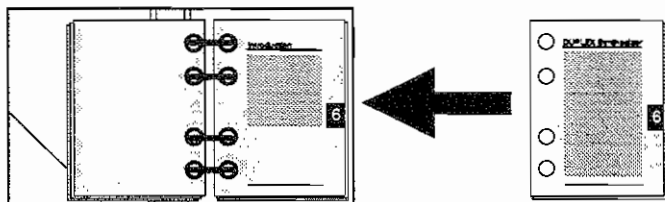

In the list of contents under Chapter 6 you will find the hardware options listed. Cross the appropriate field if you add the description of a hardware option to the operating instructions.

Hardware option	Ordering code	Function
DUPLEX Synthesizer	229 038	Signal generator and test receiver can be operated simultaneously.
DATA Module	236 016	a) Coding and decoding of telegrams (radio data, cellular radiotelephones) in conjunction with software options (see Chapter 10) b) Addition of AF generator DATA c) PL/DPL tester (selective-call system used in USA and Asia)
DTMF Module	248 171	Coding and decoding of DTMF tone sequences
Interface Centronics/RS-232/Keyboard	236 012	a) Printout with conventional printers b) Connection of keyboard (248 192) for writing AUTORUN programs
Interface IEEE-488/RS-232/Keyboard	236 013	a) Printout with conventional printers b) Printout with ink-jet printer (896 092) c) Connection of keyboard (248 192) for writing AUTORUN programs d) Connection of PC with IEEE card for convenient writing of AUTORUN programs with AUTORUN editor ARE (897 100) e) Remote control by IEEE controller
External Synchronization	214 026	Synchronization of STABLOCK 4015 by external 10-MHz reference signal
Internal Battery	205 006	a) Operation of STABLOCK 4015 away from AC power source (approx. 1 h) b) Bridging power outages

Optional test devices and what they do

(

(

(

(

STABILOCK 4015

Hardware Option 229 038

DUPLEX Synthesizer

Installation

and

Operating Instructions

Installation Instructions

During installation make sure you observe the usual safeguards for electronic components, especially where electrostatic discharge is concerned.

- 1) Switch off STABLOCK 4015 and remove the back panel (see Appendix D).
- 2) Detach the ribbon cable from modules A and B (**Fig. A**). To do this, press the clips in the direction of the arrows as shown in **Fig. B** until the female connectors of the ribbon cable come away from the male connectors of the stages.
- 3) Carefully slide the DUPLEX module into the chassis on the guide rails at the location shown in **Fig. A**. Make sure that the ribbon cable is not damaged and the male connector of the DUPLEX module is the same way round as on modules A and B.
- 4) Connect the ribbon cable to the three modules. Press the female connectors onto the male connectors (**Fig. C**) until you hear the clips engage. Make sure that no RF cables get caught up!
- 5) Connect socket 49 on the DUPLEX module and on module A with the shorter of the two RF cables that are supplied (**Fig. D**).
- 6) Connect socket 48 on the DUPLEX module and on module B with the longer RF cable (**Fig. D**).
- 7) Replace the back panel and tighten all screws with a black underlay.
- 8) Switch on STABLOCK 4015.
- 9) Call up the STATUS menu. If you have installed it correctly, the Communication Monitor recognizes the new option and shows this in the Duplex line by the entry Installed.
- 10) Call up the CALBRT menu and make a self-check (see Chapter 4). If the DUPLEX synthesizer is in order, the self-check will report OK in the Duplex line.

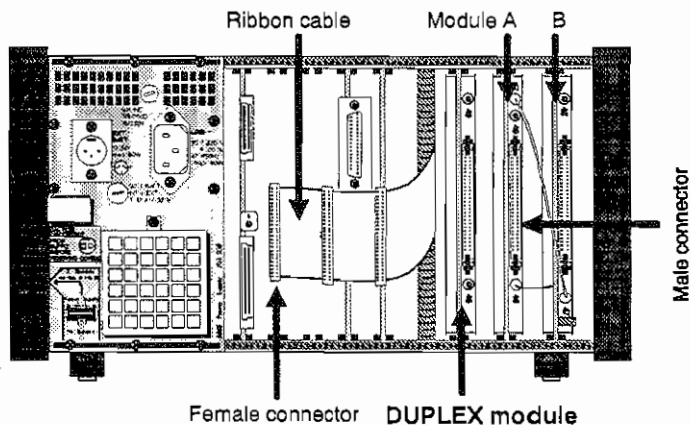

Fig. A: Before installation of the DUPLEX module, the ribbon cable must be detached from the male connectors of modules A and B.

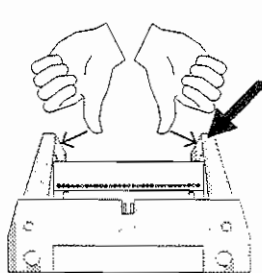

Fig. B: Strong pressure applied in the direction of the arrows releases the clips.

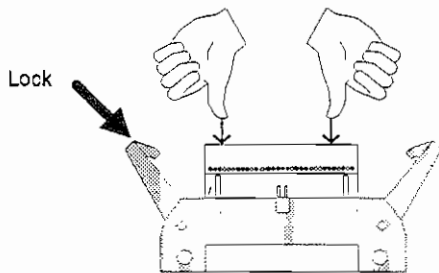

Fig. C: Strong pressure applied in the direction of the arrows locks them again.

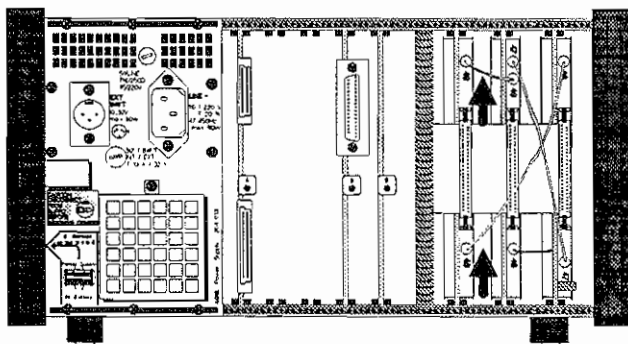

Fig. D: The last step in installing the DUPLEX module is the connection of the two RF cables.

Introduction

If your STABLOCK 4015 is fitted with the optional DUPLEX synthesizer, the Communication Monitor can transmit and receive *simultaneously*. This is a requirement for testing duplex radio sets (eg radiotelephones).

Adjustable variables

In DUPLEX mode there are all the possibilities listed in the sections on the test receiver and signal generator. The following duplex parameters can be set in addition:

- Duplex spacing.
- Automatic linking of the RX and TX tuning frequency by the duplex spacing.
- Modulation independent of demodulation.

Switching on DUPLEX mode

Call up the basic DUPLEX mask with **[DUP]** (Fig. 6.1). The test receiver and the signal generator are then active simultaneously. The entry fields of the basic DUPLEX mask adopt the values last entered in the basic TX and RX mask.

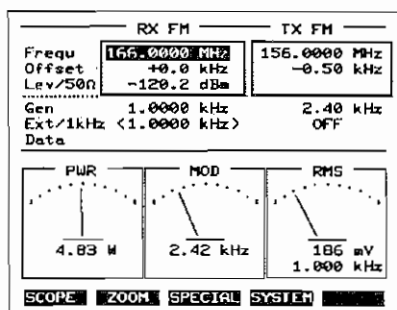

Fig. 6.1: In the upper area the DUPLEX mask is composed of the RX mask and the TX mask.

Entries

Tuning frequency signal generator (RX) **FREQU** + Numeric value + **ENTER**

Instead of the carrier frequency, a channel number can also be entered (see Appendix B).

Tuning frequency test receiver (TX) Locate the **FREQU** entry field in the TX half of the basic mask with the cursor keys, enter the numeric value and confirm it with **ENTER**.

Declaring duplex spacing Call up the **NoL/U** menu and enter the duplex spacing in the Duplex Space entry field.

Automatic RX/TX linking When automatic RX/TX linking is declared, only the TX or RX tuning frequency has to be entered. The other value is entered automatically, offset by the duplex spacing. The **NoL/U** menu (see Chapter 4) offers the following menu items for crossing to reset/set the automatic linking (Fig. 6.2):

- ⇒ **RX and TX independent**: the RX and TX tuning frequencies are independent of one another (no linking by the duplex spacing).
- ⇒ **TX = RX + Duplex**: the TX tuning frequency is higher than the RX tuning frequency by the duplex spacing.
- ⇒ **RX = TX + Duplex**: the RX tuning frequency is higher than the TX tuning frequency by the duplex spacing.

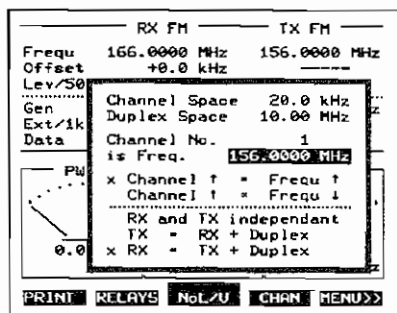

Fig. 6.2: The DUPLEX parameters are declared in the **NoL/U** menu.



The automatic RX/TX linking does not immediately affect the entries in the two **FREQU** entry fields after the menu window is closed, a frequency value has to be entered first.

Modulation Demodulation

⇒ In DUPLEX mode the type of modulation and demodulation can be declared independently of one another. For details see Chapter 4, section "MOD-PAR" (menu item Cross Demod xx).

Further entries

- ⇒ All other entries (RF output level, offset, modulation values, etc) are explained in the "Test Receiver" and "Signal Generator" sections.
- ⇒ In DUPLEX mode each AF generator can be used either to modulate the signal generator or, via the MODGEN socket, to modulate the test item (see "AF Generators").

Selecting RF input/output

In DUPLEX mode there are four different connection possibilities for the RF sockets by repeatedly tapping the selector key (acknowledgement by LEDs):

TX SENS + RX	Input = TX SENS, output = RX/TX. Only for special applications.
TX SENS + RX HIGH	Input = TX SENS, output = RX HIGH. Application: remote measurements over antenna.
RX HIGH + TX	Input = RX/TX, output = RX HIGH. Only for special applications.
TX + RX	Input = RX/TX, output = RX/TX. Application: standard measurements on cable (single-port radio sets).

 Do not exceed maximum permissible input levels (see front-panel inscriptions). If, when applying a signal ($P > 50$ W) to the RX/TX socket, the **REDUCE RF POWER** message appears on the monitor, reduce the power immediately to $P < 50$ W.

Standard Measurements in DUPLEX Mode

RX/TX measurements	The DUPLEX mode permits all manual measurements that are possible with the test receiver and signal generator (see there). Only the TX frequency range is slightly smaller than in TX mode (see Appendix A, "Technical Data").
Diplexer transfer	See Chapter 7, DUPLEX Special "DESENS".
AF frequency response	See Chapter 7, DUPLEX Special "AF RESP"

STABILOCK 4015

Hardware Option 236 016

DATA Module

Installation

and

Operating Instructions

Installation Instructions

During installation make sure you observe the usual safeguards for electronic components, especially where electrostatic discharge is concerned.

- 1) Switch off STABILOCK 4015 and remove the back panel (see Appendix D).
- 2) Slide the DATA module into the slot with the male connector leading (Fig.). The component side must face away from the power supply.
- 3) Replace the back panel and tighten all screws with a black underlay. The location of the supplied retaining screw for the DATA module is marked by an arrow in the picture.
- 4) Switch on STABILOCK 4015.
- 5) Call up the **STATUS** menu. If you have installed it correctly, the Communication Monitor recognizes the new option and will indicate the version number and checksum of the decoder/encoder software in the lines **Decoder** and **Encoder**.
- 6) Call up the **CALBRT** menu and make a self-check (see Chapter 4). **OK** should appear next to **Data Module**.

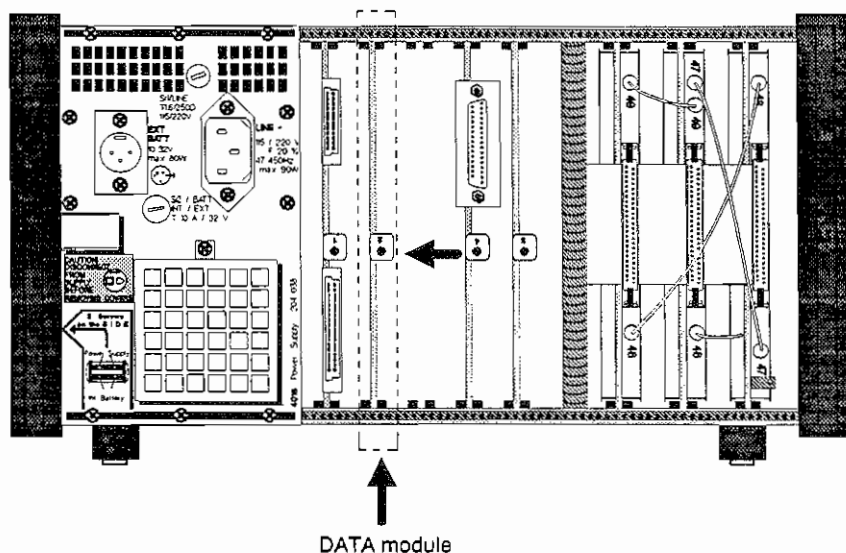

Introduction

The DATA module has three functions: the most important of these is its hardware for testing radio-data sets and radiotelephones. The option simulates and decodes the signals that are exchanged between a base station and a subscriber set. The software for these tests also comes as options. Their system programs access the DATA module. Manual operation of the module is unnecessary. The test masks of this function do not appear until a system program is loaded. So you will find the individual test functions explained in Chapter 10 (Software Options).

The other two functions of the DATA module are available straight after installation; these are not bound by other requirements and are explained on the following pages.

- Extra AF generator DATA
- Tester for PL (private line) and DPL (digital private line) selective-call sets

AF Generator DATA

The DATA module provides you with an extra AF generator. This is operated in the same way as the AF generator GEN (see Chapter 5).

Switching on

Strike **DATA**. Switching on the AF generator connects the AF signal path according to the set mode (RX, TX, DUPLEX).

Switching off

Strike **DATA** until neither of the two LEDs above the **DATA** key is illuminated.

Setting frequency

Locate the frequency entry field in the Data line with the cursor keys. Enter the frequency and confirm this with **ENTER**.

Setting level

Locate the level entry field in the Data line with the cursor keys. Enter the level and confirm this with **ENTER**.

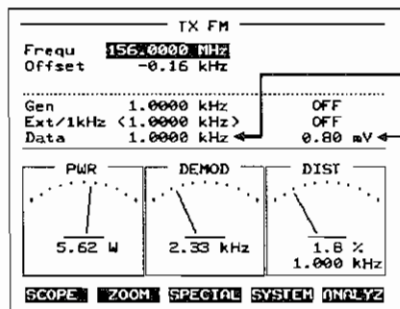

Fig. 6.1

Frequency entry

Level entry

PL/DPL Tester

The PL/DPL tester, according to the system selected, transmits or decodes PL and DPL codes for RF call setup. As soon as the call is set up, you can call up the basic DUPLEX or RX mask and carry out the usual tests (eg receiver sensitivity). The call is maintained because the Communication Monitor continues to transmit the codes.

Basic settings

Calling up test mask

The test mask (Fig. 6.2) can be called up from each of the three basic masks. The complete instruction is:

(SYSTEM) + (MENU) + (SYSTEM) + {PL/DPL} + (MENU)

This call automatically produces the following settings: change to DUPLEX mode and coupling of the demodulated TX signal to AF signal analysis.

Transmit frequency

as in Chapter 5: Signal Generator.

Offset

as in Chapter 5: Signal Generator.

Output level

as in Chapter 5: Signal Generator.

Receive frequency

as in Chapter 5: Test Receiver.

Frequency deviation

Locate the Deviation entry field with the cursor keys. Enter the frequency deviation (permissible values: 0 to 9.9 kHz) and confirm this with (ENTER).

Return

(TX), (DUPL) or (RX) takes you back to the basic mask.

Testing PL systems

Selecting PL tester

Strike (PL) softkey.

	RX FM	TX FM
Frequ	89.0000 MHz	89.0000 MHz
Offset	+0.0 kHz	
Lev/S0n	-60.0 dBm	

Gen	1.0000 kHz	OFF
Ext/1kHz	<1.0000 kHz>	OFF
Data	1.0000 kHz	OFF

PL x Common Tones	XZ : 67.0 Hz	
Free defined	192.8 Hz	
Deviation	0.50 kHz	

DECODE SEND CLEAR PL DPL

Fig. 6.2: PL test mask

Entry field for standard code

Entry field for freely definable code

PL codes

Either a standard code recommended by Motorola is transmitted (see **Table**) or a user-definable PL code.

Standard PL codes					
Frequency (Hz)	PL code	Frequency (Hz)	PL code	Frequency (Hz)	PL code
67.0	XZ	103.5	1A	162.2	5B
69.3	WZ	107.2	1B	167.9	6Z
71.9	XA	110.9	2Z	173.8	6A
74.4	WA	114.8	2A	179.9	6B
77.0	XB	118.8	2B	186.2	7Z
79.7	WB	123.0	3Z	192.8	7A
82.5	YZ	127.3	3A	203.5	M1
85.4	YA	131.8	3B	206.5	8Z
88.5	YB	136.5	4Z	210.7	M2
91.5	ZZ	141.3	4A	218.1	M3
94.8	ZA	146.2	4B	225.7	M4
97.4	ZB	151.4	5Z	229.1	9Z
100.0	1Z	156.7	5A	250.3	M7

Selecting standard code

First cross the entry field **Common Tones**. Then move the cursor bar to the entry field for standard codes **Fig. 6.2**) and open the entry window with **UNIT/SELECT** (**Fig. 6.3**). Place the cursor bar on the required standard code and choose the code with **UNIT/SELECT**. The entries **Next** and **Prev** mean that more standard codes can be found above and below those shown. You can move to these by repeatedly tapping the cursor keys.

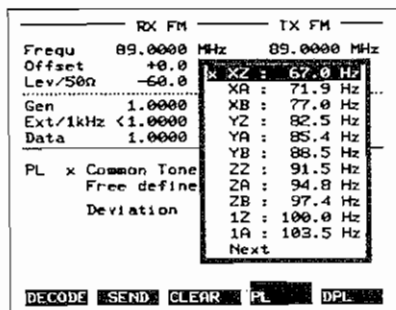

Fig. 6.3: PL standard codes

Freely definable code

First cross the entry field **Free defined**. Then move the cursor bar to the entry field for freely definable codes (Fig. 6.2) and enter the required frequency. Only values between 60 and 250 Hz are meaningful. Confirm with **ENTER**.

Performing PL test

Receiver test		
Action	Confirmation	Result
Strike (SEND) .	PL ON appears in Data line . Green LED above (DATA) key lights.	Selected code is transmitted continuously until you end call with (CLEAR) .
Transmitter test		
Strike (DECODE) .	Green LED above (DATA) key lights.	The received RF signal is demodulated and the frequency of the AF signal compared to the frequencies of the standard code. The frequency closest to the demodulated signal and the associated code are displayed next to the Common Tones field. The actual frequency of the demodulated signal is shown next to the Free defined field.



During transmission of a code, the frequency deviation, RF output level or the PL code can be altered.

Performing DPL test

Receiver test		
Action	Confirmation	Result
Strike (SEND) .	DPL ON appears in Data line. Green LED above (DATA) key lights.	Entered DPL code is continuously transmitted.
Ending receiver test with clear signal		
Strike (CLEAR) .	Green LED above (DATA) key goes off.	STABLOCK 4015 sends 134-Hz clear signal for 208 ms.
Ending receiver test		
Strike (DATA) .	OFF entry in Data line. LED above (DATA) goes off.	Transmission of DPL code is terminated without final transmission of clear signal.
Transmitter test		
If no standard code is sent from test item, enter expected DPL code in Encoding field. Then strike (DECODE) .	Green LED above (DATA) key goes off.	Decoded field shows code transmitted by test item. Terminate with (STOP) .



During transmission of a code, the frequency deviation, RF output level or the DPL code can be altered.

CODE menu

The CODE menu permits fast tests with defined codes on up to ten different RF frequencies. The preparations for this are as follows:

- 1) Starting from one of the basic masks, call up the CHAN menu and enter up to ten RF transmit and receive frequencies (see Chapter 4, "CHAN").
- 2) Call up the PL/DPL test mask and place the cursor bar on one of the Freq_u entry fields. Enter a channel number between 1 and 10, but do not confirm with **ENTER**, instead strike **UNIT/SELECT**. Cross Chn in the menu window that opens.
- 3) Open the CODE menu (Fig. 6.5). There each of the ten channel numbers can be assigned either a PL frequency or a DPL code.
- 4) This completes the preparations. All you do now is enter the required channel number in the Freq_u field (eg with the spinwheel). Entry of the associated PL frequency or DPL code is made automatically: in PL mode the frequency is entered in the Freq_u defined field, in DPL mode the code in the Encode field. Switchover to PL or DPL mode occurs automatically upon setting of the channel numbers. Manual switching is no longer permissible and not possible again until the Freq_u entry fields no longer show Chn channel numbers but frequencies or NoL/NoU channel numbers.

	RX FH		TX FH
	2 Chn		2 Chn
Off			
Lev	Chan	PL(Hz)	DPL
Gen	1	69.3	---
Ext	2	67.0	---
Dat	3	100.0	---
	4	---	023
PL	5	103.5	---
	6	---	025
	7	---	732
	8	---	243
	9	---	465
	10	---	071

: 229.1 Hz
111.0 Hz
50 kHz

SYSTEM CODE

Fig. 6.5: CODE menu

STABILOCK 4015

Hardware Option 248 171

DTMF Module

Installation

and

Operating Instructions

Installation Instructions

During installation make sure you observe the usual safeguards for electronic components, especially where electrostatic discharge is concerned.

- 1) Switch off STABLOCK 4015 and remove the back panel (see Appendix D).
- 2) Pull the MOD GEN module (**Fig. A**) out of the chassis.
- 3) Attach the DTMF module to the MOD GEN module (**Fig. B**) and fasten it with the supplied screws.
- 4) Slide the MOD GEN module back into the chassis. The component side must face away from the power supply. Make sure the male connector is the right way round.
- 5) Replace the back panel and tighten all screws with a black underlay.
- 6) Switch on STABLOCK 4015.
- 7) Call up the **STATUS** menu. If you have installed it correctly, the Communication Monitor recognizes the new option and shows this in the **DTMF** line by the entry **Installed**.

Fig. A: Location of MOD GEN module in chassis of Communication Monitor

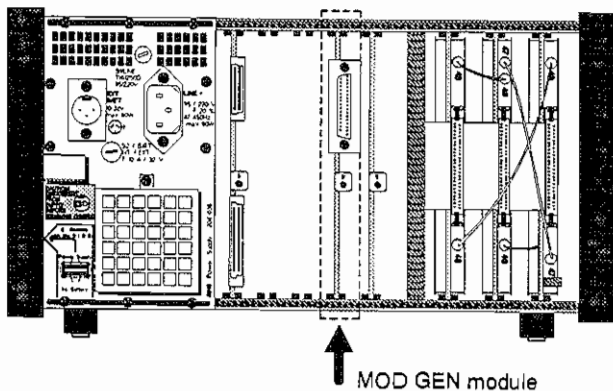
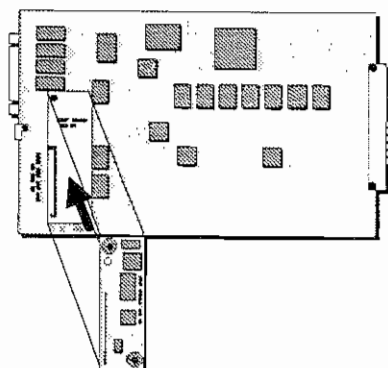

Fig. B: Mounting of DTMF module on MOD GEN module



Introduction

The DTMF module generates and decodes DTMF (dual-tone multiple-frequency) dialing signals. This enables all telephone devices to be checked that work with DTMF.

The dual tones can be output and received on either the RF or AF signal path. When dual tones are output, their duration and the pause between the dual tones is adjustable. When dual tones are received, they are decoded according to the **Table** and the associated dialing digits appear on the display. You can limit the number of dual tones to be decoded and declare a timeout.

Digit	1	2	3	4	5	6	7	8	9	0	*	#	A	B	C	D
f ₁	697	697	697	770	770	770	852	852	852	941	941	941	697	770	852	941
f ₂	1209	1336	1477	1209	1336	1477	1209	1336	1477	1336	1209	1477	1633	1633	1633	1633

Frequencies in Hz assigned to DTMF dialing digits

Calling up test mask

The test mask (**Fig. 6.1**) can be called up from each of the three basic masks. The complete instruction is:

(SYSTEM) + **(MENU)** + **(SYSTEM)** + {DTMF} + **(MENU)**

Once menu item DTMF is crossed, all you have to do is strike the **(SYSTEM)** softkey in the basic mask to call up the test mask again.

Return

(TX), **(DUPL)** or **(RX)** takes you back to the basic mask.

DTMF

DTMF Generator

Call Number 12345

Deviation 20 nV

Time 35 ms

Pause 0 ms

DTMF Analyzer

Decode Tones 5

Timeout 1000 ms

Decoded Tones : ----

SEND DECODE SINGLE SINGLE

Fig. 6.1: The DTMF test mask has entry fields for the test parameters and a display field for decoded dialing digits. The softkeys trigger the individual tests: output of complete call number (**(SEND)**), decoding of incoming tone sequence (**(DECODE)**) and output of individual dual tones (**(SINGLE)**).

Preparations

As preparation for a test, you have to call up the right basic mask *before* the DTMF test mask because this determines the signal path between the test item and the Communication Monitor.

Connecting test item

The signal paths (RF/AF), dependent on the basic mask, that are permissible for connecting the test item are shown by the following Table:

DTMF mode	Basic mask in background		
	TX	DUPLEX	RX
Encode	AF	RF	RF
Decode	AF or RF	AF or RF	AF

Permissible signal paths, depending on basic mask and DTMF mode

- RF signal path**
- ⇒ Couple the required RF input/output socket with the selector key and connect the test item.
 - ⇒ Couple the AF signal to the decoder with **DEM0D** (only necessary if tone sequences are received).
- AF signal path**
- ⇒ Apply incoming tone sequences to the VOLTM socket and couple the socket to the decoder with **VOLTM**.
 - ⇒ The tone sequence generated by the encoder appears on the MODGEN socket.

Example: You have called up the DTMF test mask starting from the basic TX mask. According to the table, the output of a DTMF tone sequence is only possible on the AF signal path (MODGEN socket). But for decoding you can choose between the RF signal path (couple the demodulated received signal with **DEM0D**) and the AF signal path (couple the VOLTM socket with **VOLTM**).

Setting RF parameters

Only for tests on the RF signal path do you have to set the usual RF parameters (tuned frequency, modulation, RF output level, IF bandwidth) before calling the DTMF test mask. Modulation depth and modulation deviation are exceptions: these parameters are entered in the DTMF test mask.

Switching off AF generators

Normally no other AF signals should be superimposed on DTMF tone sequences. So before starting a test, switch off all AF generators. The DTMF module uses the signal path of the DATA generator (option), so this generator is cut out automatically during the output of a tone sequence.

Declaring Test Parameters

For the DTMF generator the DTMF test mask offers four entry fields in the top half and for the DTMF analyzer two in the bottom half. All entry fields can be located with the cursor bar.

DTMF generator

Call Number The Call Number field accepts numbers of up to 16 places. Enter digits on the numeric block, the special characters A to D and * by softkeys and special character # with the decimal- point key. If you open the field with **ENTER**, one of the special characters can be entered straight away. **OFF** deletes all characters to the right of the write position (remainder of old call number). Correct entry errors by overwriting them. Finish your entry with **ENTER**.

Deviation Depending on the mode that is active in the background (RX, DUPLEX, TX), the entry in the Deviation field decides the modulation or the AF output level (**Fig. 6.2**):

- RX or DUPLEX: enter modulation depth or deviation (modulation of signal generator).
- TX: enter rms figure for AF output level (AF output signal on MODGEN socket). Maximum output level: 999 mV.

You can see what mode is set by the LEDs of the selector key for the RF sockets.

Time The entry in the Time field determines the duration of the individual dual tones. Maximum tone duration: 999 ms.

Pause This field defines the duration of the pause after each DTMF dual tone.

The screenshot shows a terminal window titled "DTMF". It is divided into two sections: "DTMF Generator" and "DTMF Analyzer".

DTMF Generator

Call Number	12345
Deviation	20 mV
Time	35 ms
Pause	0 ms

DTMF Analyzer

Decode Tones	5
Timeout	1000 ms
Decoded Tones :	---

At the bottom, there are four buttons: SEND, DECODE, and two unlabeled buttons, followed by a SING F button.

Blld 6.2: The DTMF test mask shown here was called up from TX mode. So the Deviation entry field does not show modulation depth/deviation but a voltage figure. This is the rms of the AF level at which the tone sequence is output on the MOD GEN socket.

DTMF analyzer

- Decode Tones** The figure in the `Decode Tones` field determines how many dual tones of an incoming tone sequence are to be decoded by the analyzer (permissible value: 1 to 16).
- Timeout** The entry in the `Timeout` field prevents incomplete tone sequences from permanently blocking the analyzer (permissible value: 0 to 9999 ms). The timeout counter is started *at the end of the first* decoded dual tone and reset at the beginning of each following dual tone. If there is no restart, the analyzer terminates decoding after the timeout. The timeout figure must not be shorter than the pauses in the received tone sequence (see Chapter 5, "Selective-call Tester").

Starting Test

Once you have carried out the preparations and declared the test parameters, you can start one of the following tests with the softkeys:

- SEND**
- ⇒ The number entered in the `Call Number` field is output once with the declared test parameters (modulation/level, tone duration, tone pause) (halt with **STOP**). The test item should decode this call number correctly.
 - ⇒ Acoustic check: couple the AF signal analyzer to the DTMF generator with **RX MOD/MODGEN** and turn up the volume control on the Communication Monitor.
- DECODE**
- ⇒ The DTMF analyzer awaits an incoming tone sequence. As soon as this arrives, the declared number of dual tones is decoded and the result shown in the `Decoded Tones` display field. As long as the analyzer is ready, the Communication Monitor allows no change of mode. **STOP** terminates analyzer readiness.
 - ⇒ Acoustic check: turn up the volume control on the Communication Monitor.
- SINGLE**
- ⇒ In this test the DTMF generator *immediately* outputs the call digit selected on the numeric block or by softkey. A change of mode is not possible during this test.
 - ⇒ **OFF** ends the test.
 - ⇒ After you strike the **SINGLE** softkey, the softkeys show the special characters. If you then strike the key for any dialing digit or a special character, the DTMF generator will output the associated dual tone immediately (no confirmation necessary with **ENTER**). The duration entered in the `Time` field will apply, ie unless you enter another digit during output. The last digit output can always be read from the `Call Number` field.

- ⇒ Continuous transmission: before the test enter 999 in the **Time** field. The current dialing digit is then output continuously. During output you can change the digit at any time. Any other key operation, eg **ENTER**, will interrupt continuous transmission.
- ⇒ Acoustic check: couple the AF signal analyzer to the DTMF generator with **RX MOD/MODGEN** and turn up the volume control on the Communication Monitor.

DES

STABILOCK 4015

Hardware Option 205 006

Internal Battery

Installation

and

Operating Instructions

Installation Instructions

- 1) Switch off STABILOCK 4015 and withdraw the power cable.
- 2) Remove the baseplate. To do this, undo the six Phillips screws (two at the bottom of each side panel, two in the baseplate).
- 3) Undo and remove the two socket-head cap screws on the righthand side with the supplied screwdriver (**Fig. A**).
- 4) Remove the spacer tubes and (if present) plastic sleeves (**Fig. A**).
- 5) Connect the battery plug to the battery socket. Bend the battery leads if necessary so that they cannot contact the chassis of the Communication Monitor during installation (risk of shorting). Then slide the battery into its compartment so that the temperature sensor is underneath, ie lies on the cable in the bottom of the battery compartment (**Fig. B**). Place the battery connection between the air baffle and the battery so that air circulation in the unit is not hindered.
- 6) Attach the battery with the socket-head cap screws.
- 7) Replace the baseplate of the Communication Monitor.
- 8) Switch on STABILOCK 4015 (power switch on BATT, no power cable connected). If the display remains dark, the battery is flat and must first be charged (see following section "Before first use").
- 9) Call up the **STATUS** menu (see Chapter 4). If you have installed it correctly, the Communication Monitor recognizes the battery and shows the battery voltage in the **Battery** line plus the note **Installed**.
- 10) Connect the power cable and set the power switch to **LINE**. Call up the **STATUS** menu again. The battery is not normally supplied fully charged, so the **Battery** line should now show the battery voltage plus the message **Charging**.

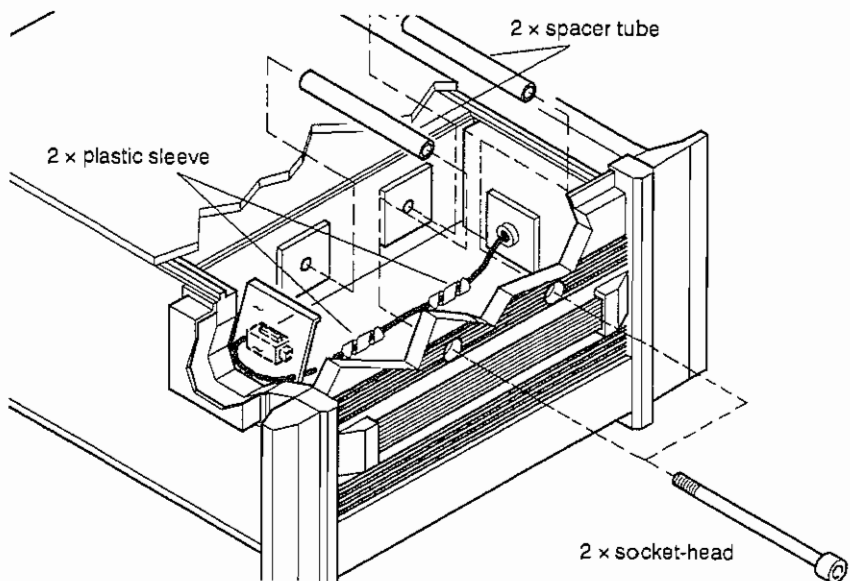

Fig. A: Battery compartment of STABILOCK 4015. The two spacer tubes and the plastic sleeves have to be removed before the battery is inserted.

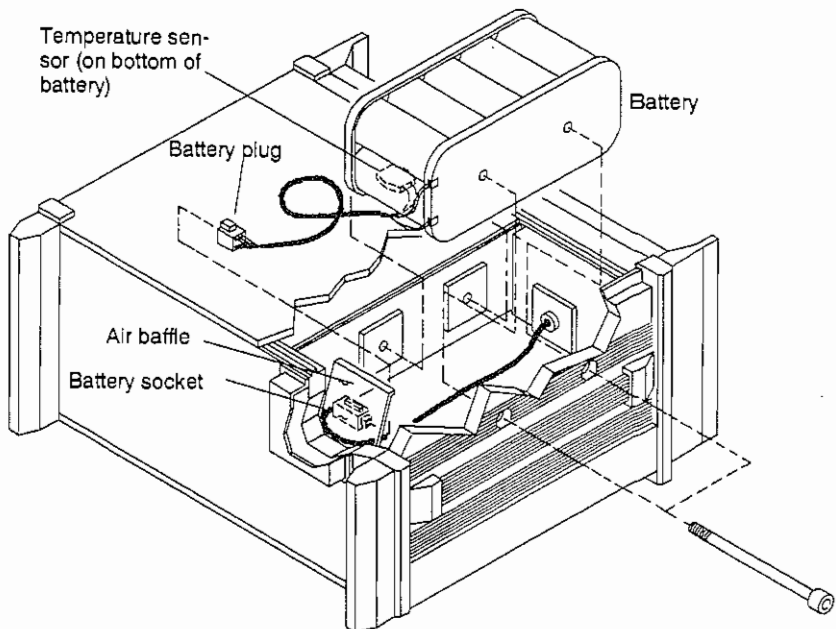

Fig. B: Incorporation of battery in compartment. So that the air circulation of the fan is not hindered, route the lead to the battery socket under the battery and place the battery connection between the battery and the air baffle.

Notes on Use

Fitted with the internal battery, STABLOCK 4015 can be operated for about one hour away from a power source. The battery can also sustain power outages without any interruption when the Communication Monitor is being powered from an AC line source if the power switch is set to BATT (see Chapter 1, "Powering on"). The charge of the battery is monitored by a temperature sensor. When the battery heats up (full charge), the charging current is reduced automatically (charge retention). So the battery cannot be overcharged.

Before first use

A brand-new NiCd battery must first be formed so that it reaches full capacity. This is done by complete charging, complete discharging and recharging:

- **Charging battery:** Connect the Communication Monitor to the line. As long as the power switch is on LINE or OFF, the battery is charged. This must be done for at least 14 hours.
- **Discharging battery:** Withdraw the power cable, set the power switch to BATT and operate the Communication Monitor like this for at least one hour. This discharges the battery.
- **Recharging battery:** Recharge the discharged battery for at least 14 hours.

Operating states

Depending on how you set the power switch, the battery can have the following operating states (see Chapter 1, "Powering on"):

LINE	STABLOCK 4015 is powered from the AC line and the internal battery is charged. Upon full charge there is automatic switchover to a retaining charge. No uninterruptible power supply.
OFF	STABLOCK 4015 is switched off. As long as the power cable is connected, the internal battery is charged. Upon full charge there is automatic switchover to a retaining charge.
BATT	STABLOCK 4015 is powered by the internal battery if the power cable is withdrawn. With the power cable connected: line powering; internal battery is <i>not</i> charged; uninterruptible power supply is assured.

Assessing charge

The battery voltage indicated in the **STATUS** menu (**Battery** line) enables you to estimate the momentary charge of the battery. The following table shows typical figures that can vary upwards or downwards by about 0.5 V depending on the battery model:

Battery voltage (standard)	Charge	Battery voltage (individual)
12.7 V	100%	
11 V	75 to 25%	
10 V	10 to 5%	
9 V	Switch off	

Typical relation between battery voltage (shown in STATUS menu) and charge of battery. The figures apply when the Communication Monitor is powered from the battery (no AC line). The right column is for individual entries.

For precise individual entries in the table you need the discharge curve of the battery. First charge the battery full, then withdraw the power cable, set the power switch on the Communication Monitor to **BATT** and call up the **STATUS** menu. During battery powering strike the **(STATUS)** softkey about every 10 min (updates the measured voltage in the **Battery** line) and note the voltage figure. The battery loses capacity in the course of time, so the individual entries in the table should be checked about every six months.

What to watch out for

- Avoid power interruptions: After each power interruption the battery receives the full charge current, even if the battery is already fully charged. Charge retention does not occur until the temperature sensor signals warmup of the battery again. If this charge cycle occurs frequently, it can reduce the lifetime of the battery somewhat. So the Communication Monitor should always be shut down with the power switch and not by withdrawing the power cable.
- Do not work constantly in the **BATT** setting: This may ensure an uninterruptible power supply in line operation, but the battery is not charged. Every battery discharges itself, so continuous line operation of the Communication Monitor (in **BATT** setting) will produce a flat battery at some time or other. Remedy: set the power switch to **OFF** during longish pauses.
- As long as the power supply of **STABILOCK 4015** charges the battery with 0.7 A, extra heat dissipation is produced. In these charging phases make sure of good air circulation (see if the air filter of the fan has to be cleaned, place the Communication Monitor so that the fan does not suck in warm air).

Technical data

Battery capacity	7 Ah (sufficient for about 1 h of battery power)
Rated voltage	12 V
Charge current	0.7 A
Retaining charge current	70 mA
Full charge	after about 14 h



Battery disposal

Cadmium is poisonous. So do not throw the battery into the trash can when it is finished. For environment-friendly disposal go to a recycling firm, a battery bank or the nearest SCHLUMBERGER office.

YES

STABILOCK 4015

Hardware Option 236 013

Interface
IEEE-488/RS-232/Keyboard

Installation Instructions

and

Notes on Use

Installation Instructions

- 1) Switch off STABLOCK 4015.
- 2) Attach interface as shown below to port B of Communication Monitor and fasten with knurled-head screws.
- 3) Switch on STABLOCK 4015.
- 4) Call up STATUS menu. If the interface is correctly installed, the Communication Monitor recognizes the new option and signals this in the Interface line with Serial, KBD, IEC. If this entry is missing, check that the screw marked by an arrow in the illustration is properly tightened (otherwise there is no electric contact between the interface and the Communication Monitor).

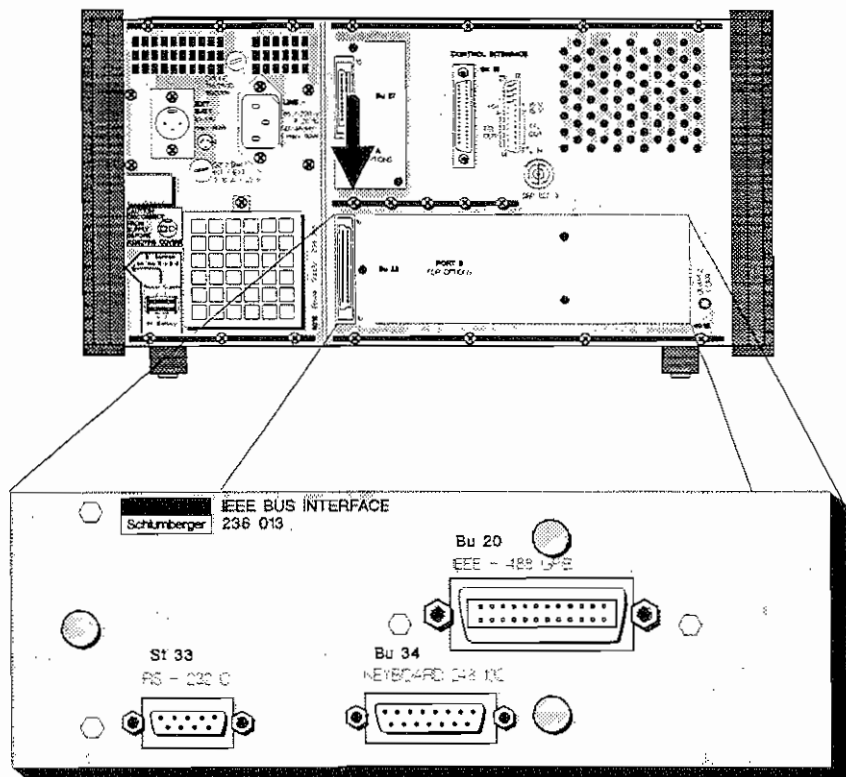

Notes on Use

In the following table you will find applications for the interface and the appropriate sections of the operating instructions that you should consult for the particular application.

Application	Reference
Print output (masks, program listings or AUTORUN test reports) via RS-232-C or IEEE-488 interface	Chapter 4 "PRINT" (selecting printer and interface, setting transmission protocol and configuring interface)
Writing AUTORUN programs with external keyboard (accessory), connection to KEYBOARD socket	Chapter 9 "Editing Programs" (description of keyboard)
Convenient writing of AUTORUN programs with AUTORUN Editor ARE (requires PC with IEEE interface card of type PCIIA (National Instruments))	Chapter 9 "Requirements" (brief presentation of Autorun Editor, which comes with separate operating instructions) Chapter 4 "PRINT" (configuring IEEE interface)
Remote control of STABILOCK 4015 via IEEE-488 interface	Chapter 4 "PRINT" (configuring IEEE interface) Chapter 11 "IEEE-488 Bus" (general information on IEEE-488 bus)

Pinning of interfaces

IEEE-488 GPIB (pins 1-24)



1	DI 01	7	NRFD	13	DI 05	19	GND
2	DI 02	8	NDAC	14	DI 06	20	GND
3	DI 03	9	IFC	15	DI 07	21	GND
4	DI 04	10	SRQ	16	DI 08	22	GND
5	EOI	11	ATN	17	REN	23	GND
6	DAV	12	SHIELD	18	GND	24	LOGIC GND

RS-232-C (pins 1-9)

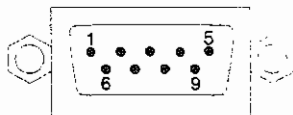

1	DCD	4	DTR	7	RTS
2	RXD	5	GND	8	CTS
3	TXD	6	DSR	9	RI

KEYBOARD (pins 1-15)

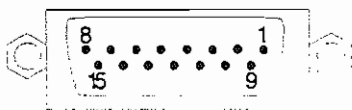

1	D0	6	D5	11	KEY ACTIVE
2	D1	7	D6	12	V _{cc}
3	D2	8	NC	13	NC
4	D3	9	KEY STROBE	14	NC
5	D4	10	GND	15	NC

Specials

Introduction

Specials automatically carry out standard tests on radio sets in a matter of seconds (see **Table**). There are only a few settings that you have to make yourself, eg selecting the required test method. Everything else, like coupling the RF sockets, is taken care of by the Specials. Then, when you start the same Special again, under the same conditions, even the few manual settings are no longer necessary.

RX Specials	Test performed by Special
SENS	Receiver sensitivity (SINAD or S/N)
BANDW	IF bandwidth and center-frequency offset of receiver
AF RESP	Receiver AF response
SQLCH	Switching response of squelch
TX Specials	
SENS	Transmitter modulation sensitivity
VSWR	Voltage-standing-wave ratio of antenna
AF RESP	Transmitter AF response
F-BRST ⁵⁾	Frequency measurement on RF bursts
DUPLEX Specials	
DESENS	Desensitization of duplex radio
AF RESP	AF response (transmitter + receiver)
F-BRST ⁵⁾	Frequency measurement on RF bursts

In the three modes **RX**, **TX** and **DUPLEX** the Specials (test routines) perform these standard tests automatically.

Selecting Special

Call up the required basic mask (see **Table**) and strike the **(SPECIAL)** softkey. The bottom half of the display will then show the mask of the Special last selected. Now you can choose the required Special with the softkeys.

Entries

Depending on the selected Special, you will see new entry fields and (in part) new menu windows. These enable you to match a Special to your individual requirements (more about that later when the different Specials are explained). As usual, all entry fields can be located with the cursor keys, but some fields do not accept numeric values, instead you cross them like menu items with the **(UNIT/SELECT)** key.

Return

(RX), **(TX)** or **(DUPL)** takes you back to the particular basic mask.

RX Special SENS

The SENS Special measures the sensitivity of a receiver, referred to a signal/noise figure that you define.

Measuring receiver sensitivity		
Getting ready	<ol style="list-style-type: none">1. Connect radio to test set. Switch radio to receive and cut out squelch.2. Call up basic RX mask. Cut weighting filter in or out according to test specification (FILTER menu).3. Tune signal generator to receive frequency of radio.4. Choose Special with (SPECIAL) + (SENS).	Fig. 7.1.
Settings	<ol style="list-style-type: none">1. Test method: position cursor bar on entry field SINAD or S/N and strike (UNIT/SELECT).2. Reference: position cursor bar on entry field and enter value of signal/noise to which measured value is to refer.3. Units: open UNIT menu and select units that measured result is to have.4. Modulation: enter figure for test modulation in level field of 1-kHz generator.	Fig. 7.2 Fig. 7.2 Fig. 7.2
Starting Special	Strike (RUN) softkey. Special starts to measure sensitivity. Abort with (STOP).	
Auto settings	Automatic settings after start of Special: <ol style="list-style-type: none">1. Coupling of RF socket RX/TX and AF socket VOLTM.2. Operation of signal generator.3. Switch-on of 1-kHz generator.	
Reading result	Special is finished when (STOP) softkey changes back to (RUN). Read sensitivity from display field.	Fig. 7.2
Special internal	<p>The Special increases the RF output level of 4015 in increments from 4.02 μV to maximally 221 μV. After each increment it measures the signal/noise.</p> <p>As soon as the signal/noise is better than the reference which you have set, the RF level is reduced in smaller increments. If the signal/noise becomes poorer than the reference, the Special increases the RF level, again with a smaller increment.</p> <p>In this way it finds the RF level that produces the set signal/noise on the item under test (tolerance for S/N: 0.5 dB, for SINAD: 0.8 dB).</p>	

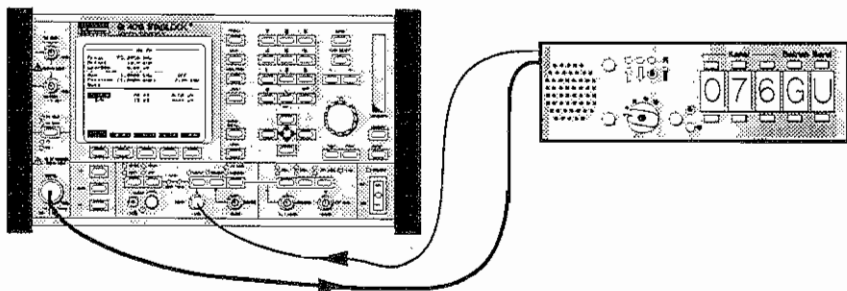
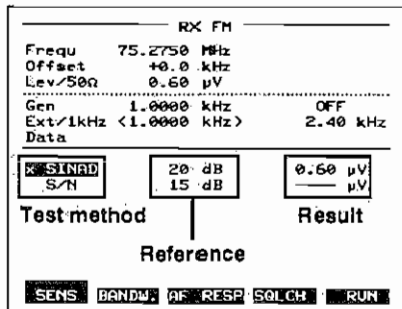

Fig. 7.1: Setup for measuring sensitivity. Connect antenna terminal of radio to RX/TX socket. Feed AF output signal of radio to AF socket VOLT/M of test set.

Fig. 7.2: Mask of RX Special SENS. Here the SINAD test method was declared before starting the Special, a reference of 20 dB and μV as the units for the result. As the mask shows, the Special determines receiver sensitivity of 0.60 μV for the test item, referred to the signal/noise of 20 dB.



RX Special BANDW

The BANDW Special measures the IF bandwidth of a receiver and the center-frequency offset of the IF.

Measuring receiver bandwidth		
Getting ready	<ol style="list-style-type: none">1. Connect radio to test set. Switch radio to receive and cut out squelch.2. Call up basic RX mask. Cut AF filter in or out according to test specification (FILTER menu).3. Tune signal generator to receive frequency of radio.4. Choose Special with (SPECIAL) + (BANDW.) (AF generators are cut out automatically).	Fig. 7.3
Settings	Reference attenuation: position cursor bar on entry field and enter reference attenuation. This is attenuation to which measured bandwidth refers (x-dB point, x = normally 6 dB).	Fig. 7.4
Starting Special	Strike (RUN) softkey. Special starts to measure bandwidth. Abort with (STOP).	
Auto settings	Automatic settings after start of Special: <ol style="list-style-type: none">1. Coupling of RF socket RX/TX and AF socket VOLTM.2. Operation of signal generator.	
Reading result	Special is finished when (STOP) softkey changes back to (RUN). Read measured results from display fields: bandwidth top, center-frequency offset bottom.	Fig. 7.4
Special internal	<p>The Special first measures the noise level of the receiver with the signal generator cut out. Then it activates the signal generator and sets its RF level (normally unmodulated) so that the noise level decreases by 10 dB (noise rejection).</p> <p>This RF level is then increased by the entered reference attenuation (noise level drops). After that the carrier frequency is increased (noise level rises) until 10 dB noise rejection can be measured again. The Special stores this frequency offset (A). The frequency is then detuned in the same way but downwards, and the frequency offset (B) is again stored.</p> <p>From these two offsets the Special calculates the bandwidth $(A+B)$ and the center-frequency offset $((A-B)/2)$.</p>	

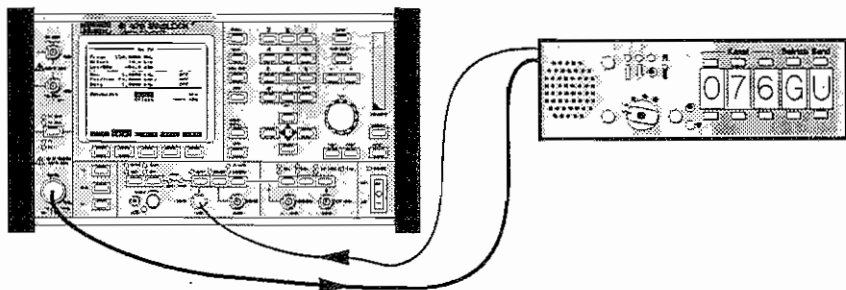
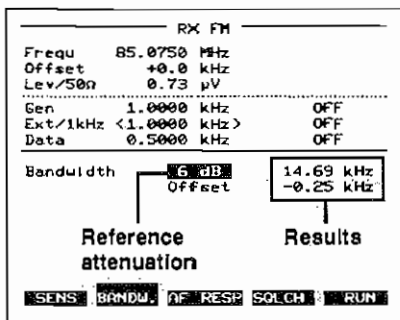

Fig. 7.3: Setup for measuring receiver bandwidth. Connect antenna terminal of radio to RX/TX socket. Feed AF output signal of radio to AF socket VOLTM of test set.

Fig. 7.4: Mask of RX Special BANDW. Before starting the Special, 6 dB was entered for the reference attenuation (the figure to which the measured bandwidth relates). As the mask shows, the Special measures a receiver bandwidth of approx. 14.7 kHz on the test item and an acceptable center-frequency offset.



RX Special AF RESP

The AF RESP Special determines the frequency response of the AF section of a receiver.

Measuring receiver AF response		
Getting ready	<ol style="list-style-type: none"> 1. Connect radio to test set. Switch radio to receive and cut out squelch. 2. Call up basic RX mask. Cut out all AF filters (FILTER menu). 3. Tune signal generator to receive frequency of radio. 4. Choose Special with (SPECIAL) + (AF RESP). 	Fig. 7.5
Settings	<ol style="list-style-type: none"> 1. Reference frequency: position cursor bar on entry field Ref and enter reference frequency (standard: 1 kHz). Special determines frequency response referred to AF level measured at reference frequency (0-dB reference). 2. Test frequencies: check that seven displayed test frequencies are those required. If necessary, position cursor bar on fields and enter new frequencies (f_{max} is 9.99 kHz). 3. Modulation: enter figure for test modulation in level field of generator GEN. 	Fig. 7.6 Fig. 7.6 Fig. 7.6
Starting Special	Strike (RUN) softkey. Special starts to measure frequency response. Abort with (STOP).	
Auto settings	Automatic settings after start of Special: <ol style="list-style-type: none"> 1. Coupling of RF socket RX/TX and AF socket VOLTM. 2. Operation of generator GEN. 3. RF output level = 223 μV (-60 dBm). 	
Reading result	Special is finished when (STOP) softkey changes back to (RUN). Result is relative attenuation at individual test frequencies referred to 0 dB (reference frequency).	Fig. 7.6
Special Internal	First the Special measures the AF level of the receiver at the reference frequency and stores this as a reference level (0 dB) for the following measurements of relative level. Then it measures the difference from the reference level at each test frequency.	

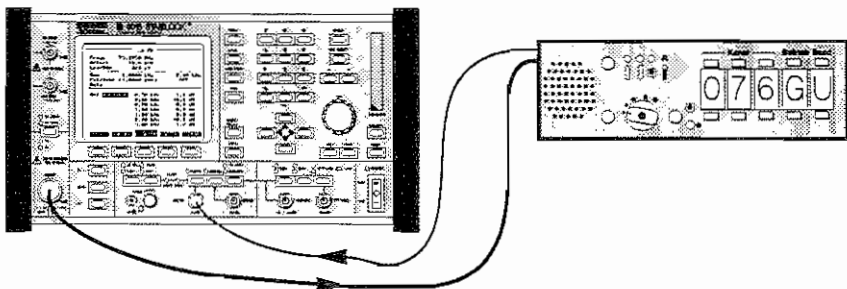
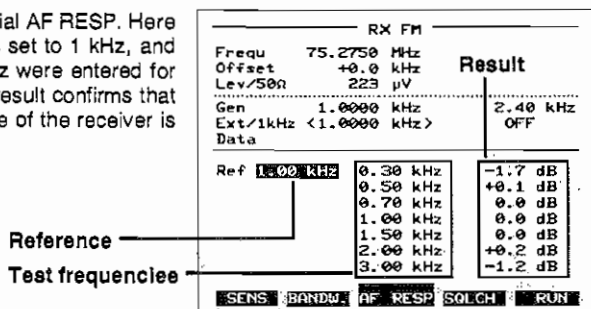

Fig. 7.5: Setup for measuring receiver AF response. Connect antenna terminal of radio to RX/TX socket. Feed AF output signal of radio to AF socket VOLTM of test set.

Fig. 7.6: Mask of RX Special AF RESP. Here the reference frequency is set to 1 kHz, and figures of 0.3 kHz to 3 kHz were entered for the test frequencies. The result confirms that the AF frequency response of the receiver is sufficiently linear.



RX Special SQLCH

The SQLCH Special finds the RF receive levels at which the squelch of a receiver mutes and unmutes the AF signal.

Measuring squelch switching response		
Getting ready	<ol style="list-style-type: none"> 1. Connect radio to test set. Switch radio to receive and cut in squelch. 2. Call up basic RX mask. Cut out all AF filters (FILTER menu). 3. Tune signal generator to receive frequency of radio. 4. Choose Special with (SPECIAL)+(SQLCH). 	Fig. 7.7
Settings	<ol style="list-style-type: none"> 1. Units: open UNIT menu and select units in which squelch switching levels are to be displayed. 2. Delay: for slow-acting squelch open DELAY menu and enter delay. This time is waited after each change of RF level before Special determines status of squelch. 3. Modulation: enter figure for test modulation in level field of 1-kHz generator. 	Fig. 7.8 Fig. 7.8
Starting Special	Strike (RUN) softkey. Special starts to measure. Abort with (STOP).	
Auto settings	Automatic settings after start of Special: <ol style="list-style-type: none"> 1. Coupling of RF socket RX/TX and AF socket VOLTM. 2. Switch-on of 1-kHz generator. 3. Relay RLY 2 is made (see Chapter 4, "RELAYS"). 4. Operation of signal generator. 	
Reading result	Special is finished when (STOP) softkey changes back to (RUN). Read switching levels and hysteresis from display fields.	Fig. 7.8
Special Internal	<p>The Special reduces the RF level of the signal generator, starting at -80 dBm, in 5-dB increments until the squelch mutes the AF path. Then the level is increased by 15 dB and reduced in 1-dB increments until the squelch again mutes the signal. Now the RF level is increased by 2 dB and reduced in 0.2-dB increments until the squelch switches again. This RF level is the squelch muting figure (RX Mute).</p> <p>Then the Special increases the RF level in increments of 0.2 dB until the squelch unmutes the AF path. This RF level is the squelch unmuting figure (RX Unmute). The difference between the two figures is the squelch hysteresis.</p>	

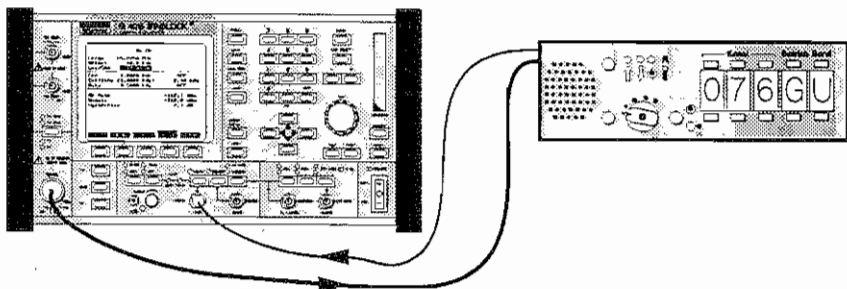
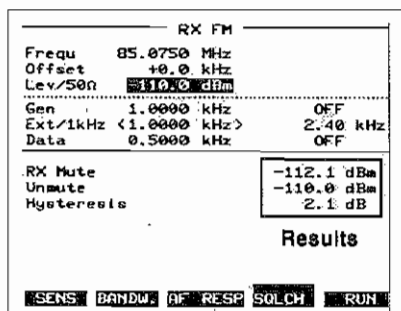

Fig. 7.7: Setup for measuring squelch switching response. Connect antenna terminal of radio to RX/TX socket. Feed AF output signal of radio to AF socket VOLTM of test set.

Fig. 7.8: Mask of RX Special SQLCH. The tested radio cuts out the AF signal at a received RF level of -112.1 dBm and in again at -110.0 dBm (squelch hysteresis: 2.1 dB). The measurement was performed with test modulation of 2.4 kHz. Two menus enable the entry of the units for the measured result and of a delay (after each change of RF level).



TX Special SENS

The SENS Special measures the modulation sensitivity of a transmitter.

Measuring modulation sensitivity		
Getting ready	<ol style="list-style-type: none">1. Connect radio to test set and switch radio to transmit.2. Call up basic TX mask and tune test receiver to transmit frequency of radio.3. Choose Special with (SPECIAL)+(SENS).	Fig. 7.9
Settings	<ol style="list-style-type: none">1. Modulation: enter modulation figure at which sensitivity of modulator is to be measured in Deviation field.2. Starting figure: enter value of modulation sensitivity expected (empirical) in expected field. If Special halts measurement shortly after start, increase starting figure by factor 2 (reason: see "Special internal").3. Delay: if radio has modulation amplifier with AGC (automatic gain control), response times can corrupt measured result. Remedy: enter delay in DELAY menu. This time is waited after each change of AF level before Special measures modulation.4. Test frequency: enter figure for AF test frequency in frequency field of generator GEN.	Fig. 7.10 Fig. 7.10 Fig. 7.10
Starting Special	Strike (RUN) softkey. Special starts to measure. Abort with (STOP) .	
Auto settings	Automatic settings after start of Special: <ol style="list-style-type: none">1. Coupling of RF socket RX/TX and MODGEN socket.2. Coupling of demodulated TX signal to AF signal analyzer.3. Operation of generator GEN.	
Reading result	Special is finished when (STOP) softkey changes back to (RUN) . Read modulation sensitivity from display field.	Fig. 7.10
Special internal	First the Special doubles the starting figure and checks whether the required modulation is obtained or exceeded. If this is <i>not</i> the case, the Special halts and has to be called up again with a higher starting figure. Otherwise the AF level is altered with progressive reduction of the increment until the measured modulation corresponds to what is required. The associated AF level is read out as the result.	

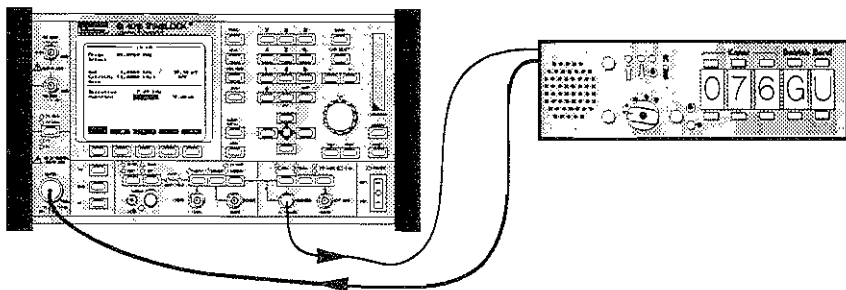
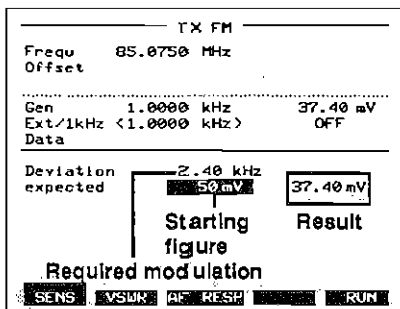

Fig. 7.9: Setup for measuring modulation sensitivity. Connect antenna terminal of radio to RX/TX socket. Feed AF output signal of test set (MODGEN socket) to microphone input of radio.

Fig. 7.10: Mask of TX Special SENS. The radio tested here shows modulation sensitivity of 37.40 mV referred to 2.4 kHz FM deviation. Before starting the Special, modulation sensitivity of 50 mV was expected and entered as the starting figure.



TX Special VSWR

The VSWR Special determines with the aid of a VSWR probe (ordering code: 248 104, see Table) how well an antenna is matched to the output of a radio (ie VSWR: voltage-standing-wave ratio).

Measuring VSWR	
Getting ready	1. Hook up radio, VSWR probe and test set. Make sure that <i>both</i> 10-dB attenuator pads supplied with VSWR probe are connected into signal path to TX SENS socket. 2. Call up basic TX mask and tune test receiver to transmit frequency of radio. 3. Choose Special with (SPECIAL) + (VSWR) . Fig. 7.11
Settings	No further manual settings required.
Starting Special	Strike (RUN) softkey. Special starts to measure as soon as transmitter of radio is switched on. Abort with (STOP) .
Auto settings	Automatic settings after start of Special: 1. Coupling of RF sockets RX/TX and TX SENS.
Reading result	To enable adjustment, Special constantly shows momentary VSWR in VSWR display field (Ideal figure: VSWR = 1). Special must therefore always be terminated with (STOP) softkey. Fig. 7.12
Special internal	<p>The Special first couples the RX/TX socket and delays selective measurement of the forward power until you switch on the transmitter of the test item ($P \geq -23$ dBm). As soon as the Special has measured the forward power, it couples the TX SENS socket and makes a selective measurement of the reflected power.</p> <p>The VSWR is calculated from the forward and reflected power according to the Formula below and displayed (the 20 dB attenuation of the reflected power is allowed for automatically). Then the cycle starts again with measurement of the forward power.</p> <p>You can follow the two measuring processes through the alternate lighting up of the LEDs near the selector for the RF sockets.</p> $VSWR = \frac{1 + \sqrt{P_r / P_f}}{1 - \sqrt{P_r / P_f}}$ <p style="text-align: right;"> P_r = reflected power P_f = forward power </p>

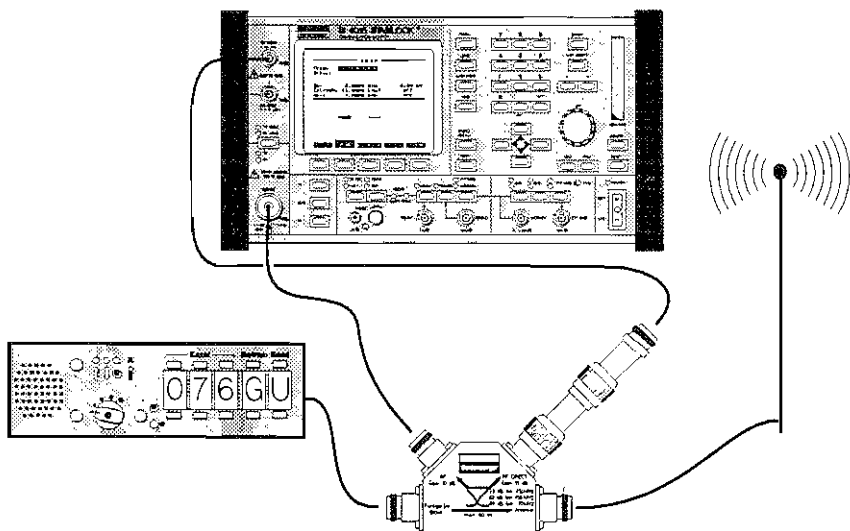
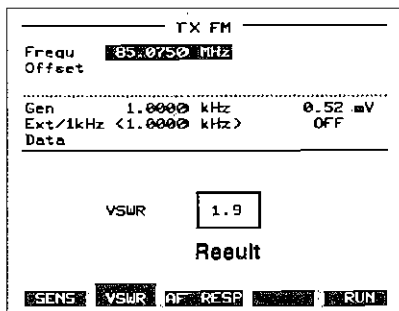
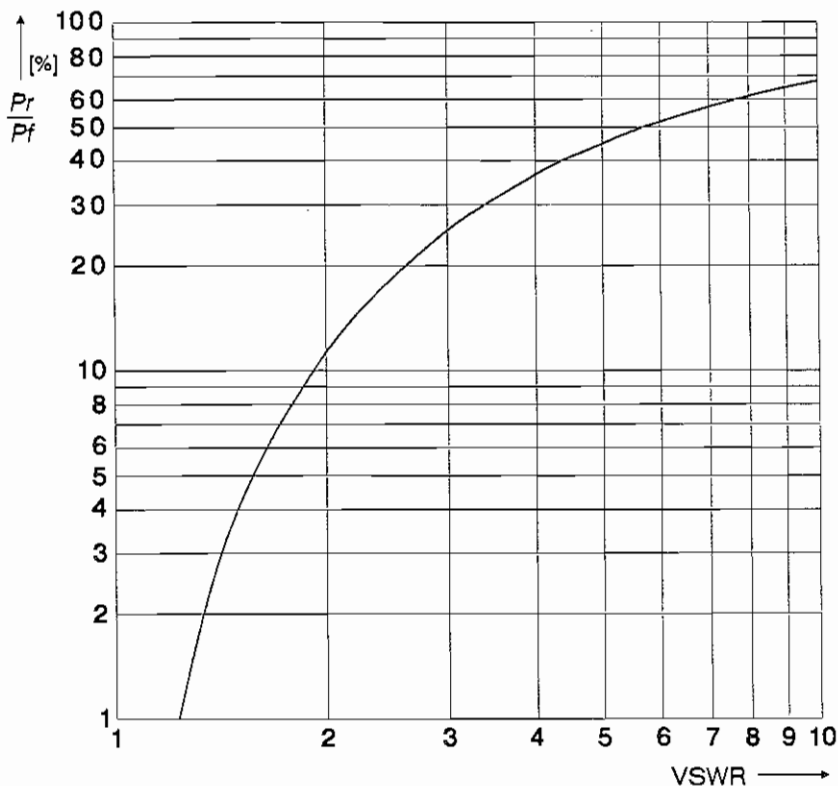

Fig. 7.11: Setup for measuring VSWR with optional VSWR probe. The two 10-dB attenuator pads connected in series in the signal path to the TX SENS socket reduce the reflected power so that there is no measuring error caused by heavy mismatch of the antenna (crosstalk).

Fig. 7.12: Mask of TX Special VSWR. Here a radio/antenna combination was tested exhibiting VSWR of 1.9.



Technical data of VSWR probe 248 104			
Frequency range	25 to 500 MHz	VSWR range	1.07 to 9.99
Characteristic impedance	50 Ω (VSWR ≤ 1.07)	Perm. forward power	1 to 50 W
Connectors	N sockets for radio and antenna	Max. error	$\frac{VSWR - 0.9}{3}$



Judging measured figure

The diagram above will help you to judge measured VSWR figures. It shows, as a function of VSWR, the ratio of reflected power P_r to forward power P_f in percent.

Example: for a VSWR of 2, about 11 % of the forward power is reflected, meaning that 11 % of the transmitted power is lost because of the mismatch of the antenna.

This page is intentionally left blank.

TX Special AF RESP

The AF RESP Special determines the AF frequency response of the modulation section of a radio transmitter.

Measuring transmitter AF response		
Getting ready	<ol style="list-style-type: none"> 1. Connect radio to test set and switch radio to transmit. 2. Call up basic TX mask. Cut out all AF filters (FILTER menu). 3. Tune test receiver to transmit frequency of radio. 4. Alter level entered in level field of generator GEN until modulation meter DEMOD indicates required test modulation (eg 20 % of maximum permissible frequency deviation). 5. Choose Special with (SPECIAL)+(AF RESP). 	Fig. 7.13
Settings	<ol style="list-style-type: none"> 1. Reference frequency: position cursor bar on Ref field and enter figure for reference frequency (standard: 1 kHz). Special determines frequency response referred to AF level which is measured at reference frequency (0-dB reference). 2. Test frequencies: check that seven displayed test frequencies are those required. If necessary, position cursor bar on fields and enter new frequencies (f_{max} is 9.99 kHz). 	Fig. 7.14 Fig. 7.14
Starting Special	Strike (RUN) softkey. Special starts to measure frequency response. Abort with (STOP).	
Auto settings	Automatic settings after start of Special: <ol style="list-style-type: none"> 1. Coupling of RF socket RX/TX and MODGEN socket. 2. Operation of generator GEN. 3. Coupling of demodulated TX signal to AF signal analyzer. 	
Reading result	Special is finished when (STOP) softkey changes back to (RUN). Result is relative attenuation at individual test frequencies referred to 0 dB (reference frequency).	Fig. 7.14
Special Internal	First the Special sets the AF reference frequency and measures the AF level of the demodulated transmit signal. This figure is the 0-dB reference for the following measurements of relative level at the seven test frequencies.	

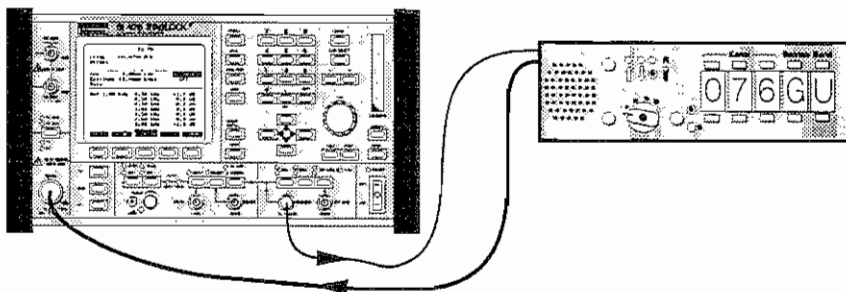
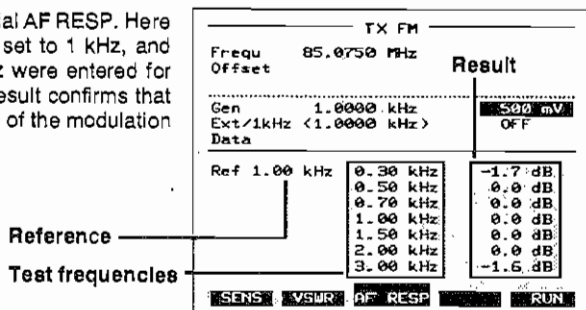

Fig. 7.13: Setup for measuring AF response in modulation section of radio transmitter. Connect antenna terminal of radio to RX/TX socket. Feed AF output signal of test set (MODGEN socket) to microphone input of radio.

Fig. 7.14: Mask of TX Special AF RESP. Here the reference frequency is set to 1 kHz, and figures of 0.3 kHz to 3 kHz were entered for the test frequencies. The result confirms that the AF frequency response of the modulation section is sufficiently linear.



TX Special F-BRST

The Special F-BRST⁵⁾ determines the frequency of RF bursts. This special is intended for measurement of carrier frequency on radio sets that do not transmit continuously (eg Johnson LTR[®] radios).

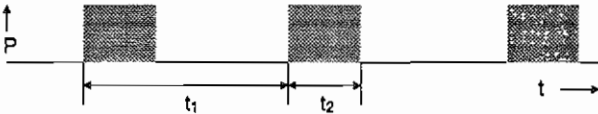
Measuring frequency of RF bursts		
Preparation	1. Connect radio set to RX/TX socket of Communication Monitor. 2. Call up basic TX mask and couple RX/TX socket with selector button (note: the Special is also available for DUPLEX). 3. Select Special with (SPECIAL) + (F-BRST).	Fig. 7.15
Settings	No further manual settings necessary.	
Starting Special	Strike (RUN). Softkey is renamed (STOP) (terminate measurement) and Special awaits arrival of RF bursts (press TX key on radio set approx. 2 s).	
Auto settings	None	
Reading result	The Special is executed when the (STOP) softkey is renamed (RUN) again. This is the case when the Special has been able to evaluate the applied bursts (see Special internal). The Frequ field shows the measured value. The test receiver is thus automatically tuned to the carrier frequency of the examined radio set, so further testing is possible immediately, eg with the "LTR + US Signalling" system program. Note: the result cannot be retrieved in AUTORUN or by a controller.	Fig. 7.16
Special Internal	The Special first makes a broadband measurement of frequency, then identifies the useful signal by a power measurement and finally determines the precise frequency of the bursts by an offset measurement. The bursts must satisfy the following conditions: <div style="text-align: center;">  </div> $t_1 \leq 0.4 \text{ s}$ $t_2 \geq 0.05 \text{ s}$ $P > 0 \text{ dBm}$ $f_{\text{burst}} \geq \text{approx. } 50 \text{ MHz}$ Measurement duration: max. 1.6 s (typ. 0.8 s). The measurement duration is the period during which bursts must appear on the RX/TX socket.	



Bild 7.15: Setup for measuring frequency of RF bursts. Connect the antenna socket of the radio set to the RX/TX socket and couple this socket, otherwise the Special cannot be started.

Bild 7.16: Mask of TX Special F-BRST. The Special enters the measured value (frequency of applied bursts) in the Freq field.

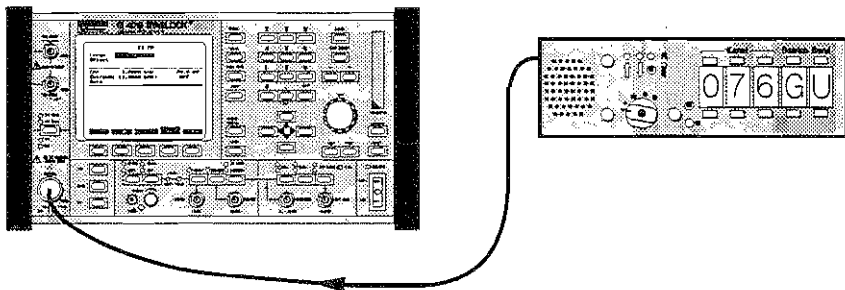
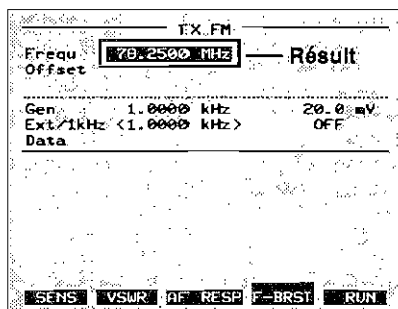

DUPLEX Special DESENS

The DESENS Special measures the desensitization of a duplex radio.

Measuring desensitization		
Getting ready	<ol style="list-style-type: none"> 1. Connect radio to test set. Switch radio to receive and cut out squelch. 2. Call up basic DUPLEX mask and cut weighting filter in or out according to test specification (FILTER menu). 3. Tune signal generator to receive frequency of radio and test receiver to transmit frequency of radio. 4. Choose Special with (SPECIAL)+(DESENS). 	Fig. 7.17
Settings	<ol style="list-style-type: none"> 1. Test method: position cursor bar on entry field SINAD or S/N and strike (UNIT/SELECT). 2. Reference figure: position cursor bar on entry field and enter reference figure for sensitivity measurement (see "Special Internal"). 3. Modulation: enter figure for test modulation in level field of 1-kHz generator. 	Fig. 7.18 Fig. 7.18 Fig. 7.18
Starting Special	Strike (RUN) softkey. Special starts to measure desensitization. If display shows Switch ON Transmitter, switch on transmitter of radio within 20 s. Abort with (STOP).	
Auto settings	Automatic settings after start of Special: <ol style="list-style-type: none"> 1. Coupling of RF socket RX/TX and AF socket VOLTM. 2. Operation of signal generator. 3. Switch-on of 1-kHz generator. 	
Reading result	Special is finished when (STOP) softkey changes back to (RUN). Read desensitization from display field.	Fig. 7.18
Special Internal	<p>First the DESENS Special starts the RX Special SENS and determines receiver sensitivity with the radio transmitter switched off. This result is stored.</p> <p>Then the Special prompts you to switch on the transmitter. If you do not do this within 20 s, the Special is aborted. Otherwise the receiver sensitivity is measured again.</p> <p>The ratio of the two measured figures, read out in dB, is the desensitization.</p>	

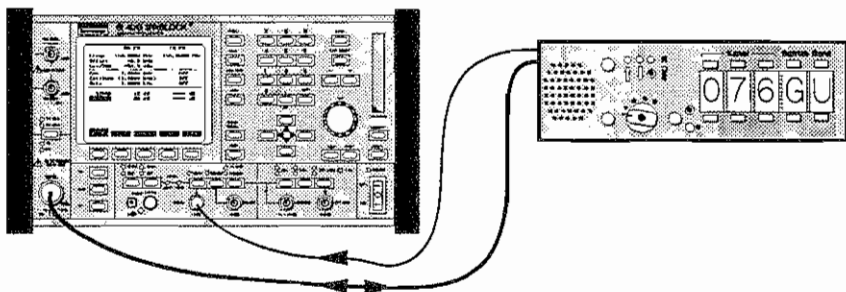
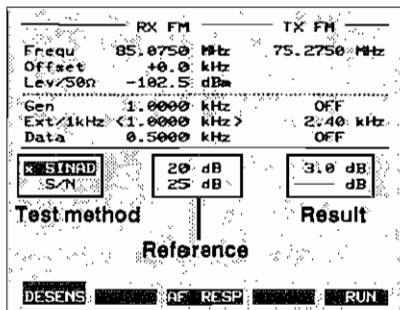

Fig. 7.17: Setup for measuring desensitization of single-port-duplex radio. Connect antenna terminal of radio to RX/TX socket. Feed AF output signal of radio to AF input VOLTM of test set.

Fig. 7.18: Mask of Duplex Special DESENS. The Special was preset for SINAD (test method) and 20 dB (reference). The measured result shows 3 dB desensitization.



Desensitization?

Duplex radios with a single-port output use one and the same antenna for the transmitter and receiver. So an antenna diplexer has to isolate the transmitted signal from the received one. Desensitization is a measure of this isolation. Good isolation is desirable so that as little transmitted power as possible from the radio reaches the receiver input and reduces its sensitivity.

DUPLEX Special AF RESP

The AF RESP Special determines the overall AF frequency response of a frequency transposer, measured on the signal path receiver + transmitter.

Measuring AF response (receiver + transmitter)		
Getting ready	<ol style="list-style-type: none"> 1. Connect transposer to test set. 2. Call up basic DUPLEX mask. Cut out all AF filters (FILTER menu). 3. Tune signal generator to receive frequency of transposer and test receiver to transmit frequency of transposer. 4. Choose Special with (SPECIAL) + (AF RESP). 	Fig. 7.19
Settings	<ol style="list-style-type: none"> 1. Reference frequency: position cursor bar on Ref field and enter figure for reference frequency (standard: 1 kHz). Special determines frequency response referred to AF level which is measured at reference frequency (0-dB reference). 2. Test frequencies: check that seven displayed test frequencies are those required. If necessary, position cursor bar on fields and enter new frequencies (f_{max} is 9.99 kHz). 3. Modulation: enter figure for test modulation in level field of generator GEN. 	Fig. 7.20 Fig. 7.20
Starting Special	Strike (RUN) softkey. Special starts to measure frequency response. Abort with (STOP).	
Auto settings	Automatic settings after start of Special: <ol style="list-style-type: none"> 1. Coupling of RF socket RX/TX; RF level = -60 dBm. 2. Operation of generator GEN. 3. Coupling of demodulated TX signal to AF signal analyzer. 	
Reading result	Special is finished when (STOP) softkey changes back to (RUN). Result is relative attenuation at individual test frequencies referred to 0 dB (reference frequency).	Fig. 7.20
Special Internal	The Special works like the RX and TX Specials of the same name, but with different signal paths. When the signal generator is modulated with a test frequency, the transposer demodulates this receive signal and modulates its transmitter with the resulting AF. This signal feeds the test receiver, which demodulates it and measures the AF level referred to the 0-dB reference. The AF test signal passes through both AF sections of the transposer (demodulator and modulator), so the Special determines the overall AF response.	

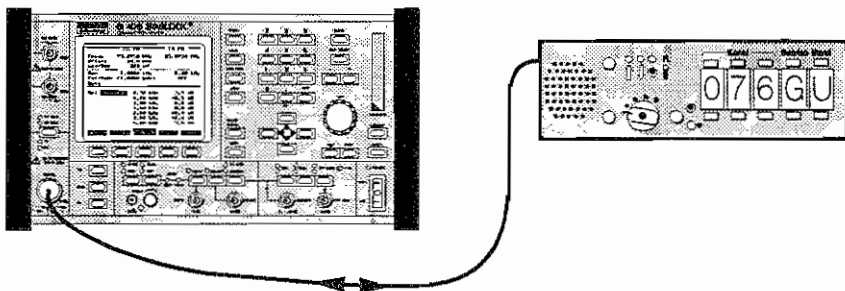
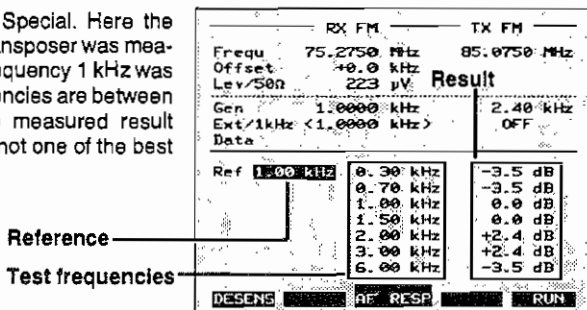

Fig. 7.19: Setup for measuring overall AF response on transposer. Connect antenna terminal of transposer to RX/TX socket. There are no other external connections because the transposer conducts the demodulated receive signal internally to the modulator of the transmitter. If this test is to be made on a conventional duplex radio, connect the loudspeaker output via an attenuator pad to the microphone input.

Fig. 7.20: Mask of RESP Special. Here the overall AF response of a transposer was measured. For the reference frequency 1 kHz was entered, and the test frequencies are between 0.3 kHz and 6 kHz. The measured result shows that the test item is not one of the best of its kind.



DUPLEX Special F-BRST

For this DUPLEX Special ⁵⁾ refer to the details of the TX Special of the same name.

MEMORY

Introduction

Strike the **MEMORY** key and STABLOCK 4015 will display the MEMORY mask. This is the starting point for all work with an external memory card. You have the following functions available:

- **Formatting memory cards.** Memory cards cannot take any data until they have been formatted.
- **Asking directory.** The directory tells you about the contents of a memory card and the programs in the main memory of STABLOCK 4015.
- **Saving and recalling setups.** If the nine setup storage locations of STABLOCK 4015 are not enough (see Chapter 2, "STORE/RECALL Function"), you can store any number of extra setups on memory cards.
- **Saving and printing out masks.** Any of the masks can be stored on memory cards, recalled and printed out.
- **Calling up AUTORUN mode** (see Chapter 9).
- **Saving and loading programs.** This function applies to AUTORUN programs and system programs (only loading).
- **Deleting files.** Deletes files in main memory or on a memory card.
- **Copying memory cards.** This function copies the entire contents of one memory card onto another.
- **Renaming files.** With the exception of system programs, all other files can be renamed as wished.
- **Setting write/delete protection.** Protects important files that must not be overwritten or deleted.



When you switch the Communication Monitor on or off, there should be no memory card in its slot. Just like with the disk drives of a personal computer, in this way you avoid any risk of losing stored data through uncontrollable write access operations.

What are files ?

A file is a data record that is stored on a memory card or in the main memory of the Communication Monitor. A data record of this kind can be an AUTORUN program or a system program (software option). But data records are also the data that produce a mask on the display and the data that determine a certain setting (setup) of the Communication Monitor.

Memory Card

Memory cards contain RAM chips for storing data. Data are preserved by a built-in lithium button cell, whose lifetime depends on the storage capacity of the memory card:

Storage capacity	Battery lifetime	Ordering code
32 Kbytes	4 years	897 050
64 Kbytes	2 years	897 051
128 Kbytes	1 year	897 052

The battery lifetime of a memory card depends on the storage capacity of the card.



When you receive a memory card, enter the date on it for how long the battery is expected to last, ie unless the date has already been entered ex works. The lifetime of a battery starts on the day a memory card is despatched.

Slot for memory cards

When you push a memory card into the MEMCARD slot (front panel), make sure it is the right way round (Fig. 8.1). Do not use force, slight pressure is enough to make the electric contacts engage with the pins of the connector. If the card is the wrong way round, a mechanical block will prevent electrical contact. Observe the handling instructions on the memory card and only use cards with a SCHLUMBERGER label.

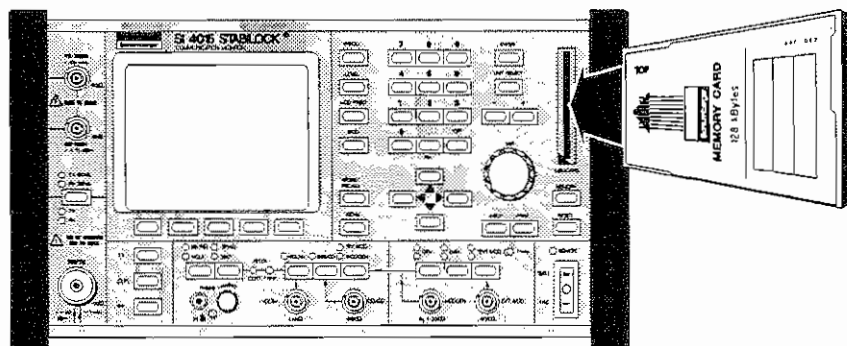

Fig. 8.1: Only if the memory card is this way round will you be able to push it far enough into the slot to produce electrical contact.

Replacing batteries

To prevent any loss of data, you should replace lithium button cells before the final date shown on the memory card (ordering code for new batteries: 859 006).

Procedure for replacing button cell

1. Power up STABILOCK 4015 and push the memory card into the slot. If you want to avoid any risk, make a copy of the memory card (see section "Copying Memory Cards") until you know that the battery has been replaced properly (note: memory cards containing a system program cannot be copied).
2. Undo the Phillips screw at the location shown in **Fig. 8.2**. This screw holds the battery compartment shut, which you can now open.
3. Take out the button cell (note the polarity and the indication on the memory card), insert a new cell with the right polarity and close the battery compartment.
4. Enter the expiry date of the new button cell on the memory card in one of the fields provided for this purpose (see table on page 8-2).

Check

5. Take the memory card out of the slot for at least 10 min and then push it back in again.
6. Call up the MEMORY mask. The directory of the memory card must now show the same entries as before you replaced the button cell. If not, the contents of the memory card have been deleted! In such an event, check that the battery is correctly poled. If you have lost a system program, contact your nearest SCHLUMBERGER office or an authorized representative.

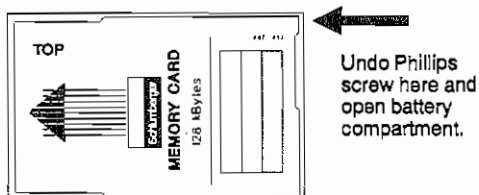

Fig. 8.2: The battery of a memory card has a limited lifetime. So do not forget to replace it in good time.

Proper disposal of used button cells



Do not put lithium batteries in the waste-paper basket. Take them to a point of collection for problem refuse. Schlumberger Technologies GmbH and its sales offices will also take back button cells for correct, ie environment-friendly, disposal.

Write-protect switch

Memory cards have a small slide switch (Fig. 8.3) to prevent memory cards being written on. This protects *all* files on a memory card against being deleted or overwritten. As you will see later in the section "Software Write Protection", it is also possible to protect *individual* files of a memory card with the **PROTECT** softkey.

STABILOCK 4015 recognizes the current setting of the write-protect switch. So a futile attempt to write to a memory card will produce a request on the display to reset the write-protect switch. A memory card cannot be formatted, for example, if the write protection is set. It is best to set the write protection once you are sure that the files on a memory card no longer have to be altered.

On memory cards containing a system program, the write protection should *not* be set. Otherwise STABILOCK 4015 will not be able to store important, current setting parameters on the card (eg channel numbers). The advantage of this is that when you reload the system program, the entry fields are already correctly filled in (no more works settings). These cards leave the factory with a special safeguard against deletion/overwriting, and this is effective even if the switch is set to allow a write access.

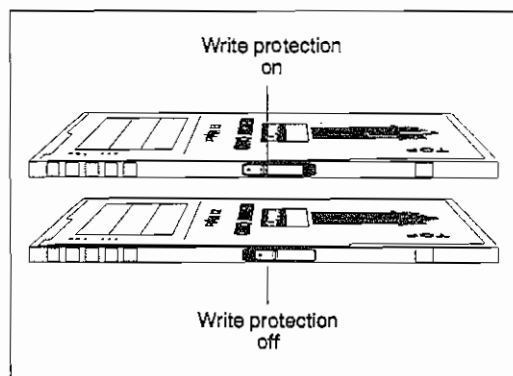

Fig. 8.3: When set to the appropriate position, the slide switch is a reliable means of protection so that the files on a memory card are not accidentally deleted or overwritten.

MEMORY Mask

MEMORY always calls up the MEMORY mask, no matter what the momentary operating status of STABLOCK 4015 is.

If there is a memory card in the slot when the MEMORY mask is called up, the mask will automatically show the directory of this card (see section "Directories").

Using the softkeys of the MEMORY mask, you can call up all the functions listed at the beginning of this chapter. Because there are more than five functions, the MEMORY mask has two softkey levels (Fig. 8.4 and 8.5). Use the **DIR >>** softkey to switch between the two levels.

Softkeys of MEMORY mask

- STORE** Stores setups, AUTORUN programs or masks on a memory card.
- RECALL** Loads setups, stored masks, AUTORUN or system programs from a memory card.
- AUTORUN** Calls up the AUTORUN mode (see Chapter 9).
- RENAME** Starts the renaming of existing files.
- ERASE** Deletes a file in main memory or on a memory card.
- FORMAT** Formats memory cards.
- PROTECT** Sets delete/write protection for files on a memory card.
- COPY** Copies the contents of one memory card onto another.

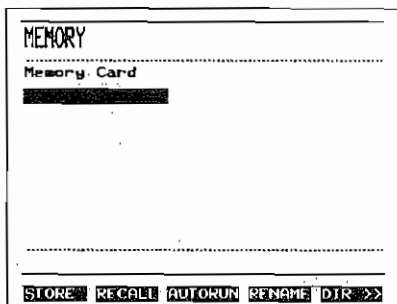

Fig. 8.4: First softkey level of MEMORY mask

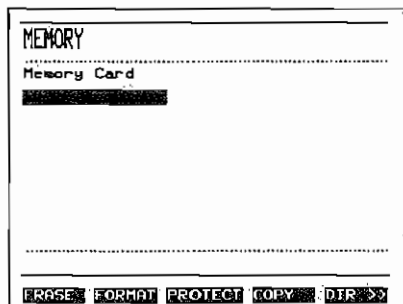

Fig. 8.5: Second softkey level of MEMORY mask

Directories

The MEMORY mask shows two directories: one tells you what programs are in main memory, the other lets you know what files are stored on a memory card in the slot.

Directory of main memory

The main memory of STABILOCK 4015 can hold *one* AUTORUN and *one* system program. This is why the directory of main memory has no more than two entries (Fig. 8.6). AUTORUN programs can be recognized by the extension .AUT and system programs (see Chapter 10) by the extension .SYS. The following sections will tell you what you can do with the programs. Here just a few points: system programs can be deleted from main memory with the (ERASE) softkey. AUTORUN programs can also be saved on a memory card with (STORE) or renamed with (RENAME). Illegal or wrongly started actions will produce an error message ACTION NOT POSSIBLE HERE.

Directory of memory card

If the slot already holds a memory card when the MEMORY mask is called up, it will immediately show the directory of this card (Fig. 8.7). If you push a card into the slot *after* calling up the MEMORY mask, it will not show the directory until you strike (DIR >>). On normal memory cards the directory has up to 20 entries, but on those of the software options there is only one entry (system program). The following sections will again tell you what you can do with the programs in the directory.

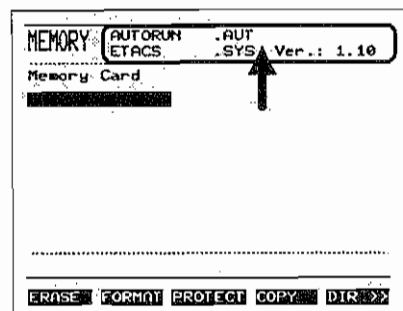

Fig. 8.6: Directory of main memory

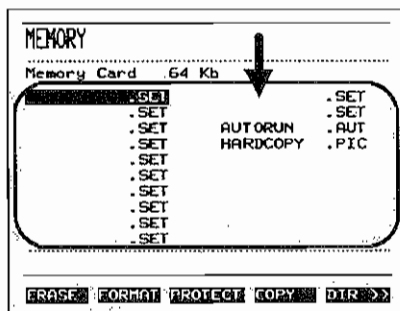
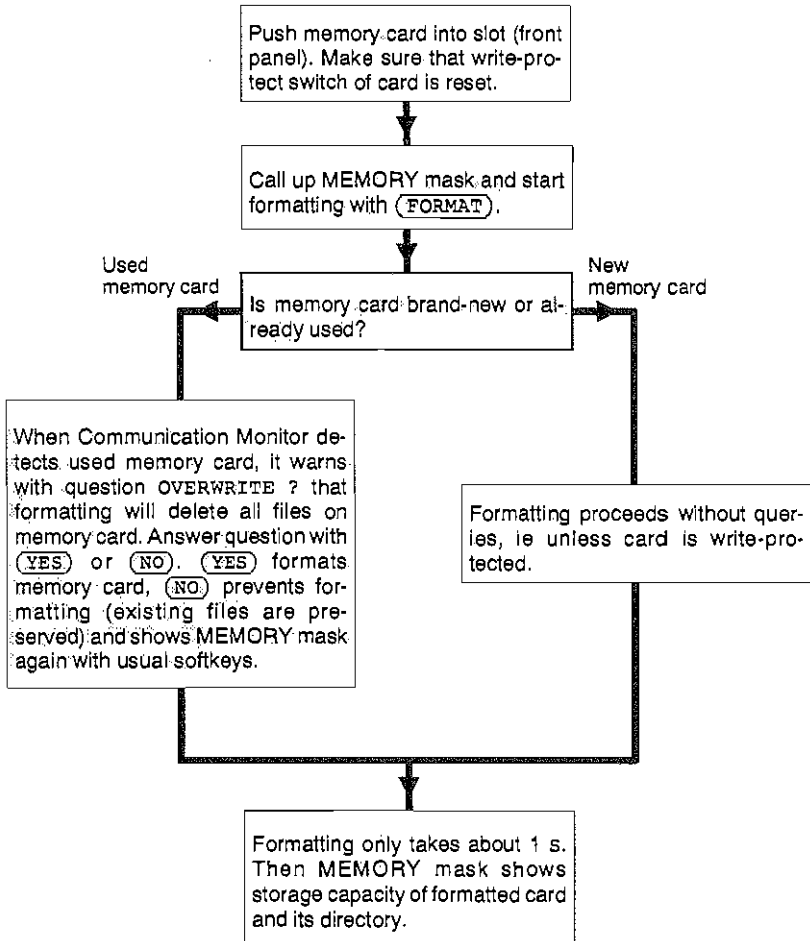

Fig. 8.7: Directory of memory card

Formatting Memory Cards

Before a brand-new memory card can store files, it has to be formatted. In this way storage locations are reserved for files (Fig. 8.9 and 8.10), and later access to stored files is speeded up. The memory cards of the software options have a special write protection to prevent them from being formatted. The steps in formatting are as follows:



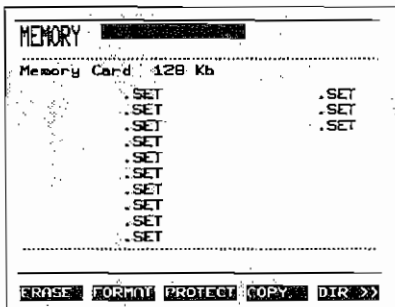

Fig. 8.9: MEMORY mask after formatting 128-Kbyte memory card

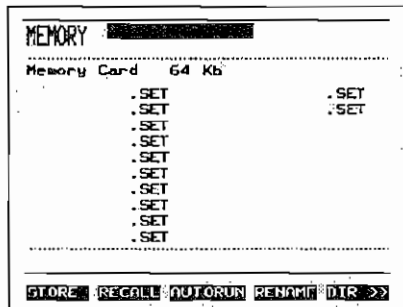

Fig. 8.10: MEMORY mask after formatting 64-Kbyte memory card

Reserved memory locations

After its formatting a memory card has reserved locations for the different types of file. The number of memory locations will depend on the storage capacity of the particular card (see Table).

Storage capacity	File type	Reserved locations
32 Kbytes	Setup	10
	AUTORUN program	1*)
	Mask	
64 Kbytes	Setup	12
	AUTORUN program	3*)
	Mask	
128 Kbytes	Setup	13
	AUTORUN program	7*)
	Mask	

*) The reserved locations can be used only for AUTORUN programs, only for masks or for any combination of the two types of file.

When a memory card is formatted, different numbers of locations are reserved for the different types of file. This is determined by the storage capacity of a card.

Example: A 64-Kbyte card can store twelve setups plus two AUTORUN programs and one mask.

After a card has been formatted, the MEMORY mask will only show the locations reserved for setups (entries with the extension .SET). The other reserved locations initially remain hidden on the display. They are not given a name (that of the file) until an AUTORUN program or a mask is stored.

Copying Memory Cards

COPY transfers the entire contents of one memory card (source card) onto another (destination card). In this process the destination card is formatted automatically. During copying, that part of main memory which normally holds an AUTORUN program serves as a buffer. So, before calling up the copy function, you should check whether the AUTORUN program in main memory may be deleted or must first be saved on a memory card (see Chapter 9, "Saving Program").

Memory cards holding a system program cannot be copied.



When a destination card is formatted automatically, the same number of locations are reserved on it as there are on the source card. In other words, you can copy the contents of a 32-Kbyte source card onto a 128-Kbyte destination card for instance. But for STABLOCK 4015 this destination card then only has capacity of 32 Kbytes, and the remainder is unused. The lost capacity is not restored until you format the card again with **FORMAT**. So it is best if the storage capacity of the source and destination cards is always the same. If you try to use a destination card that does not have enough storage capacity, the copying routine terminates with the error message **DESTINATION CARD TOO SMALL**.

A little bit at a time

For technical reasons, only 16 Kbytes of main memory can be used as interim storage, so the contents of a memory card have to be copied in several blocks of 16 Kbytes. First a block is loaded from the source card into interim storage. Then you insert the destination card and the buffered block is copied onto it. The procedure then starts again, ie you load the second block of 16 Kbytes from the source card into interim storage. This means that the source and destination cards have to be inserted twice to copy a card of 32 Kbytes, and eight times for a card of 128 Kbytes. Accessing interim storage takes about 2 s, which explains the brief pauses during copying for each memory access.

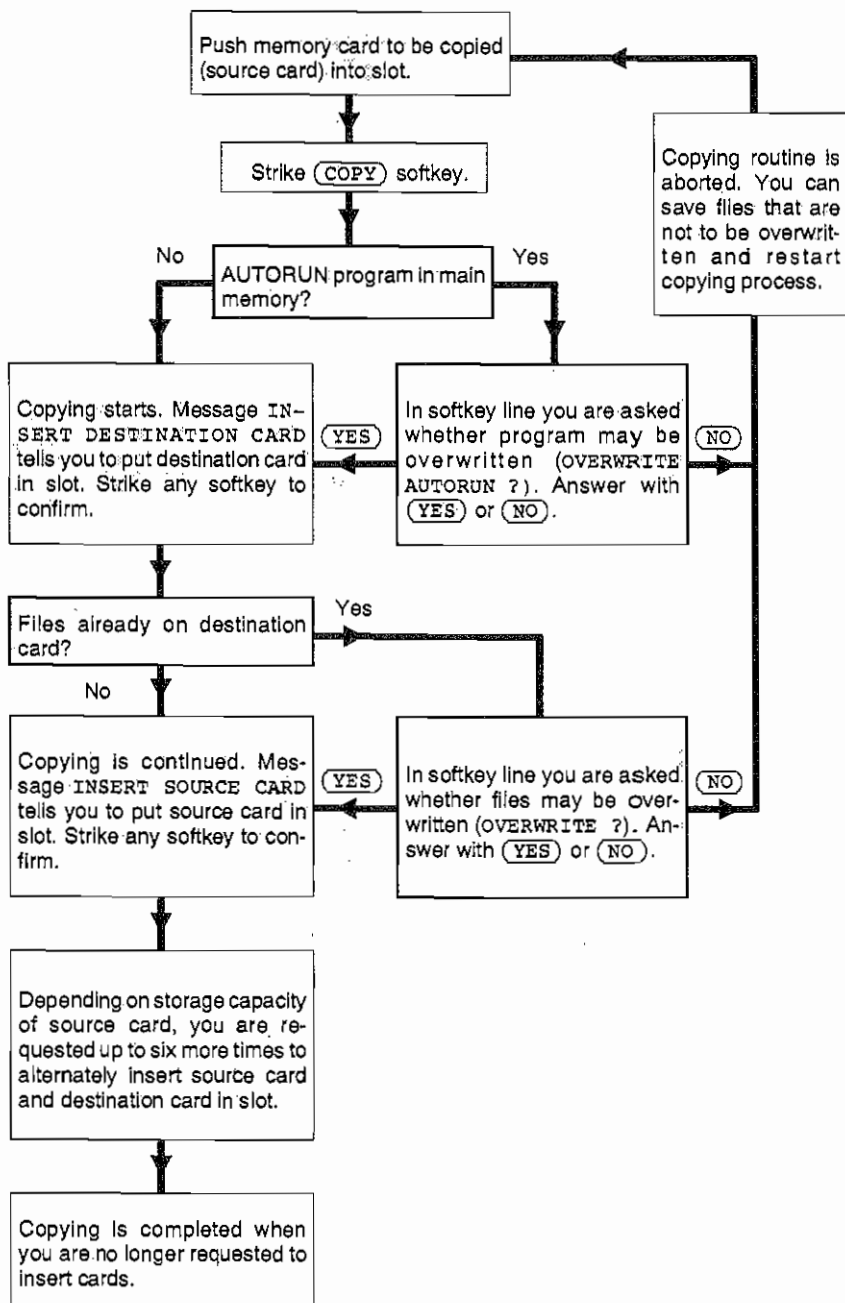

Resetting write protection

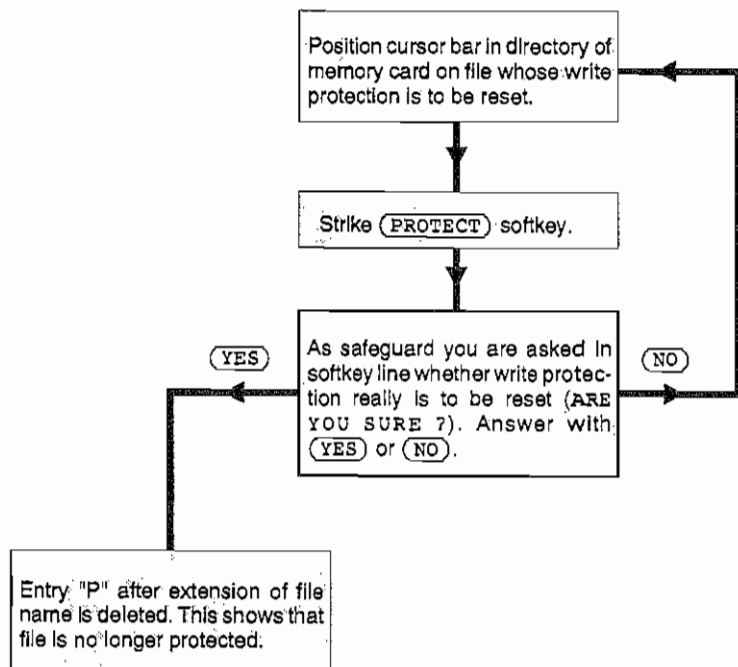

Assigning File Names

The assignment of a file name is not an independent operation but part of the storing of setups, masks and AUTORUN programs. But the process is basically the same in all cases, so it is explained in detail here and just mentioned as part of the storage operation in the later sections "Saving setups" and "Saving masks". This also applies to the special case of altering an existing file name (section "Renaming Files").

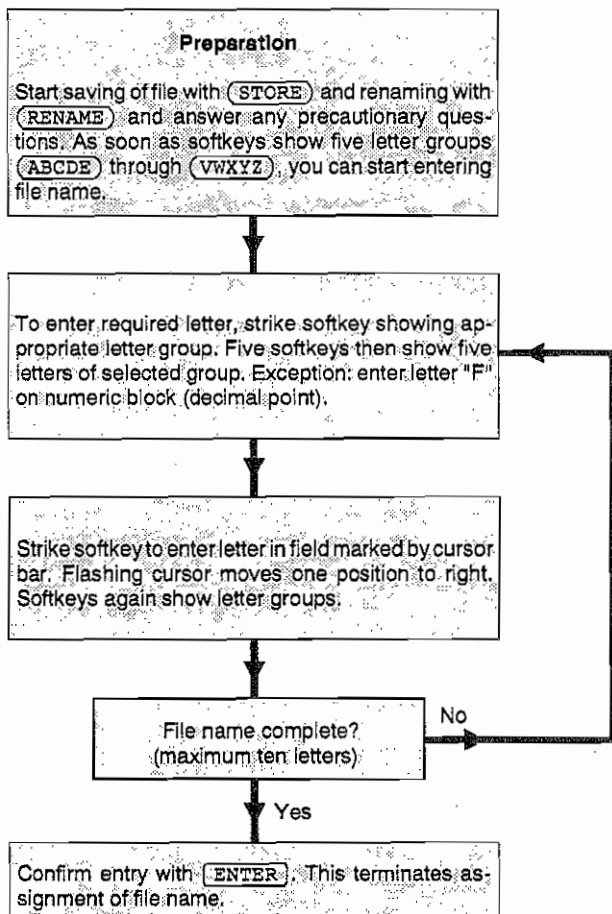

Tips on assigning file names

- MEMORY** Aborts the entry of a file name at any time.
- OFF** Deletes all letters to the right of the flashing cursor when you are overwriting or renaming an existent file name.
- ENTER** STABLOCK 4015 will give the current file a standard name at the press of a key. Prepare for this so that the softkeys show the letter groups **ABCDE** through **VWXYZ**. Do not press a softkey but instead **ENTER**. This assigns the following standard names according to the type of file:
- | | |
|---------------------|---------------------------------------|
| Fx.SET | for setups (x = hex character 0 to C) |
| HARDCOPY.PIC | for masks |
| AUTORUN.AUT | for AUTORUN programs (see Chapter 9) |

Renaming Files

You can use **RENAME** to rename files. Only the name of a file is changed, the contents remain the same. You cannot rename system programs.

Position cursor bar on file to be renamed and then strike **RENAME** softkey.

Softkeys show letters of alphabet in groups of five (**ABCDE**) through (**VWXYZ**).

If necessary, delete old name entirely with **OFF** or move cursor to position from which name is to be altered and then strike **OFF**.

Enter required file name (see section "Assigning File Names").

Confirm file name with **ENTER** to terminate renaming.

Deleting Files

ERASE deletes specific files on a memory card or in the main memory of the Communication Monitor. Exception: system programs can only be deleted in main memory, not on a memory card. If you want to delete all the files on a memory card, **FORMAT** does it faster.

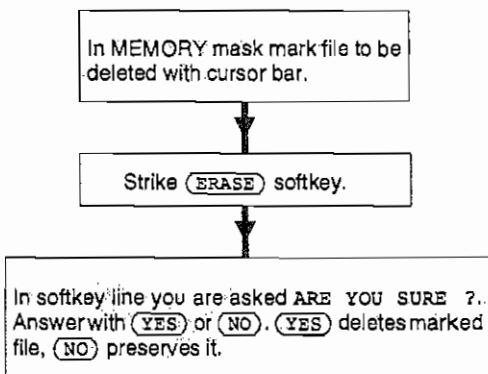

If the deleted file is a program or a mask, its name is removed entirely from the directory. Deletion of a setup leaves only the extension **.SET** for the reserved and now again vacant storage location (Fig. 8.12 and 8.13).

MEMORY		TEST	AUT
Memory Card 64 Kb			
RXTEST	.SET		.SET
F1	.SET		.SET
F2	.SET	SCOPE	.PIC
F3	.SET	AUTORUN	.AUT
	.SET		
	.SET		
	.SET		
	.SET		
	.SET		
	.SET		
	.SET		
ERASE FORMAT PROTECT COPY DIR >>			

Fig. 8.12: MEMORY mask before deleting files TEST.AUT, RXTEST.SET and SCOPE.PIC

MEMORY			
Memory Card 64 Kb			
	.SET		.SET
F1	.SET		.SET
F2	.SET		
F3	.SET	AUTORUN	.AUT
	.SET		
	.SET		
	.SET		
	.SET		
	.SET		
	.SET		
	.SET		
ERASE FORMAT PROTECT COPY DIR >>			

Fig. 8.13: MEMORY mask after deleting files. The extension **.SET** remains from the setup.

Saving and Loading Setups

Setups are user-defined settings of STABILOCK 4015 that are necessary, for instance, to prepare for a certain test application. Setups comprise a complete operating status, from the called-up mask through menu settings to the connection of sockets. When you recall a setup, the Communication Monitor adopts exactly the same operating status as when the setup was saved (see Chapter 2, "STORE/RECALL Function").

If the nine internal storage locations are not enough for saving your setups, you can store any number of extra ones on memory cards (see section "Reserved memory locations").

After a firmware update (see Appendix D) the existing setups may no longer be used (because of incompatibility). So it is advisable to document important setups. Then you can reset and restore them after an update.

Loading setups

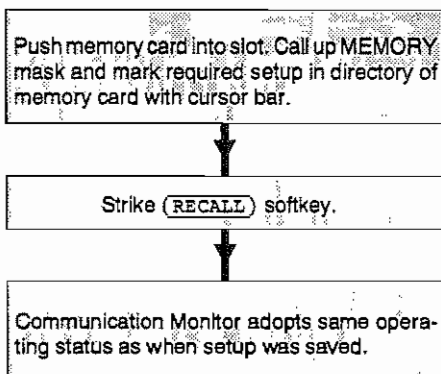

Saving setups

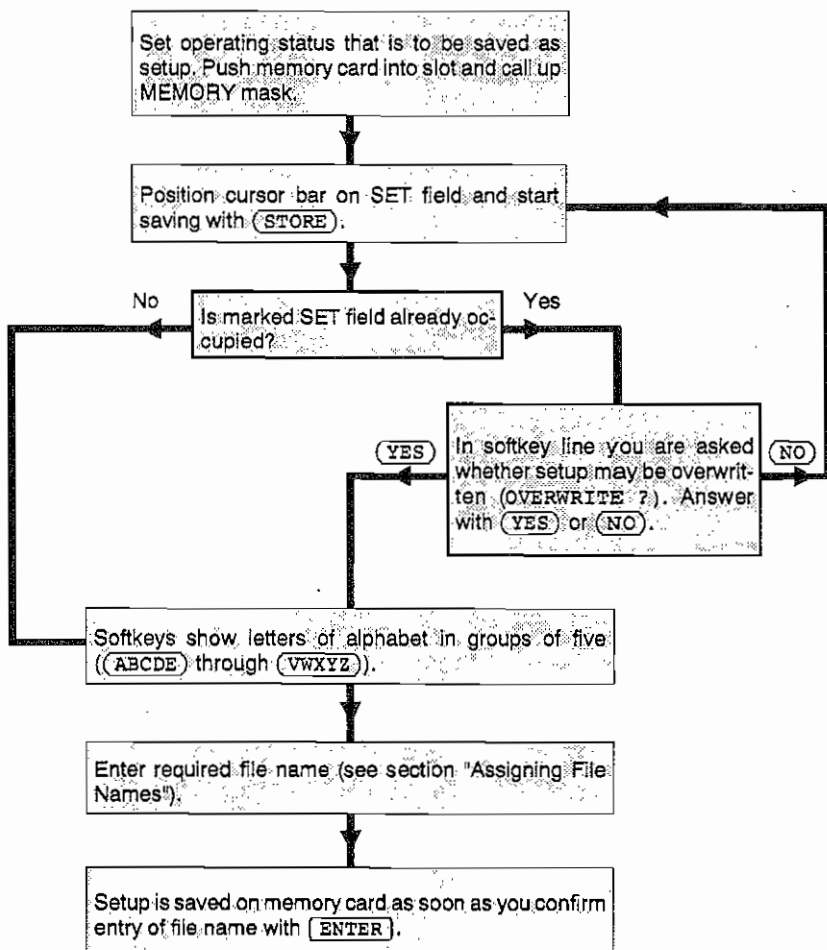

Saving and Loading Masks

Saving a mask is useful if you want to print it out but no printer is connected to the Communication Monitor for the moment. The particular mask, showing a non-reproducible oscilloscope curve for instance, is saved on a memory card. Once a printer becomes available, you can reload the saved mask from the memory card and print it out as often as required (Fig. 8.14).

If you try to save a mask on a fully occupied memory card, you will see the error message `CARD FULL`. If no other card is available, you can overwrite another mask on the card (file with the extension `.PIC`).

Tip: A mask can overwrite other masks on a memory card but not AUTORUN programs. If a card is filled with AUTORUN programs, you do not have to lose one of the programs to save a mask on it. For AUTORUN programs you still have the main memory of STABLOCK 4015 available. If you load one of the AUTORUN programs into main memory (see Chapter 9), you can delete the original file from the card and use the free capacity for a mask. Later of course, when you have deleted the mask file, do not forget to save the AUTORUN program on the card again.

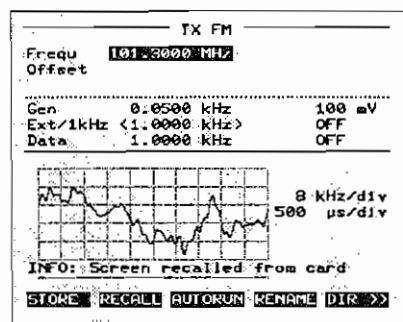
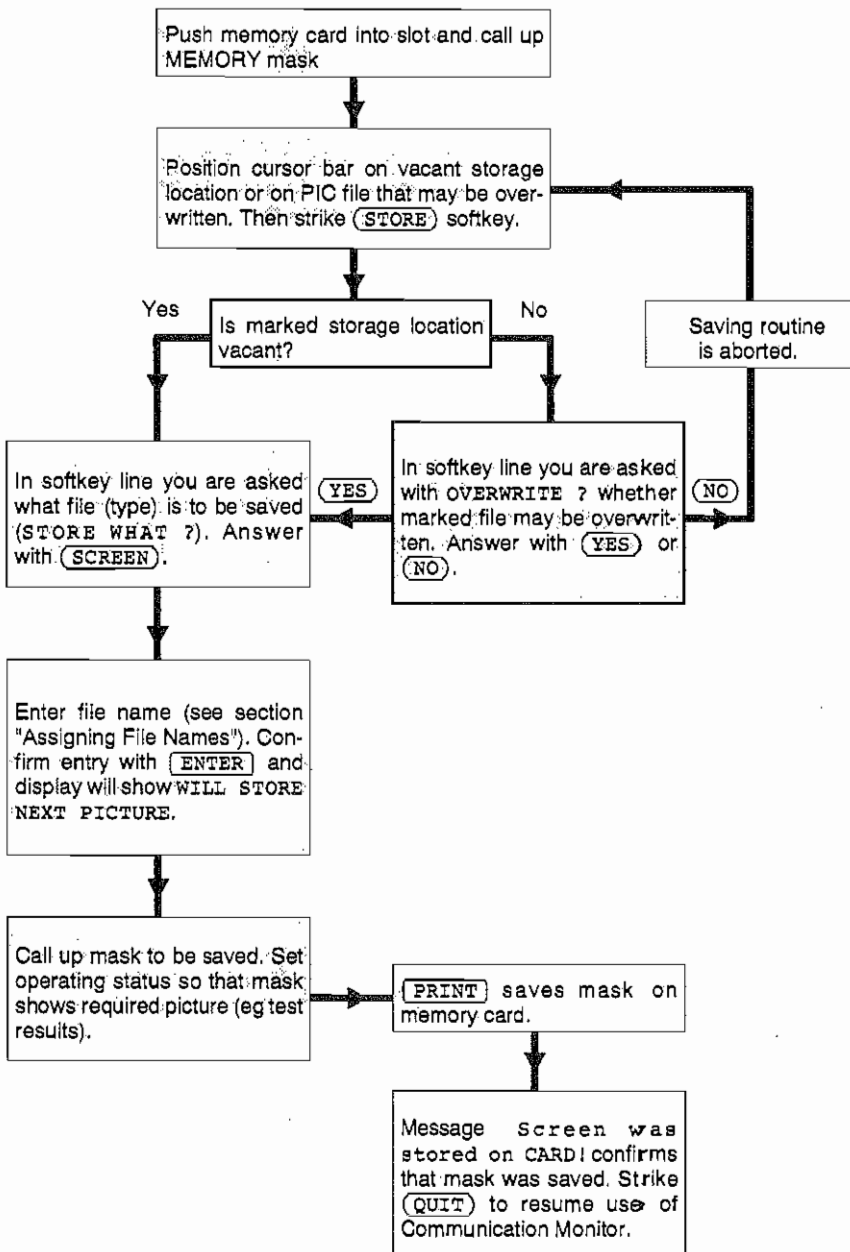
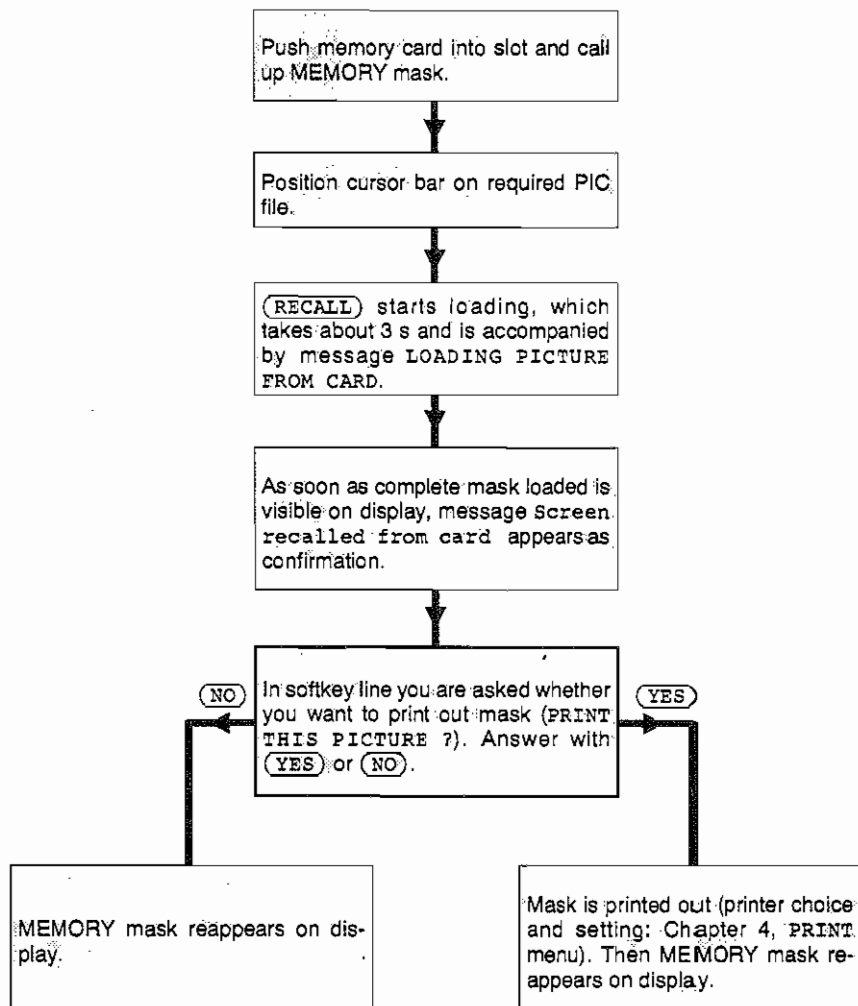

Fig. 8.14: This oscilloscope curve was not printed out directly but saved on a memory card, loaded again later and then printed.

Saving masks



Loading masks



Loading System Program

A system program saved on a memory card can be loaded into the main memory of STABLOCK 4015, executed (see Chapter 10) and then deleted from main memory. The following are not possible however: copying/formatting the memory card, renaming, deleting the system program on the memory card, saving the system program on another memory card.

A total reset (see Chapter 1) deletes the system program in main memory. But it is not deleted when you power the Communication Monitor off or if there is a power outage.

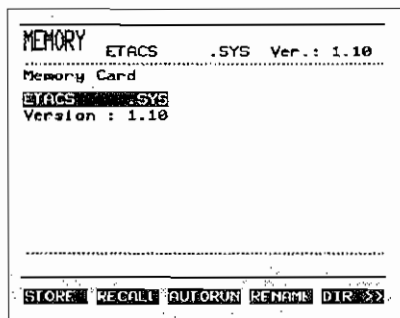

Fig. 8.15: MEMORY mask after loading system program. Once a system program is loaded in main memory, its directory shows the program name.

Push memory card containing required system program into slot and call up MEMORY mask.

Position cursor bar on name of system program (entry with .SYS extension) and strike **RECALL** softkey.

System program is loaded into main memory. Once loading is completed, directory of main memory shows name of system program.

Call up one of basic masks and strike **SYSTEM** softkey. If this does not produce system program, call up SYSTEM menu with **MENU** and select bottom menu item (system program).

Saving and Loading AUTORUN Programs

The MEMORY mask is also the starting point for saving AUTORUN programs on a memory card and loading them to main memory from a memory card. But these two subjects fit better in Chapter 9 (AUTORUN) and are dealt with there in the sections "Saving Programs" and "Loading Programs".

AUTORUN

Introduction

Rationalized testing with AUTORUN programs

AUTORUN programs turn STABLOCK 4015 into a fully automatic radio test set for just about any task. Controlled by an AUTORUN program the set will execute a series of tests without any human intervention, for example, and at the same time produce a report with evaluation of the measured results. It is also possible for an AUTORUN program to stop what it is doing and show you entry or adjustment instructions on the display of STABLOCK 4015. Once you have responded to these, the program will continue with the new entries or adjustments.

AUTORUN programs can automatically reproduce virtually all manual functions of STABLOCK 4015, from connecting the RF sockets through selecting menu items to calling up a special test routine.

AUTORUN programs are a particular advantage if you want to take care of extensive tests - that keep occurring - in a speedy and thorough fashion. Typical examples of these are automatic acceptance tests after repairs or regular routine checks as part of maintenance.

Requirements

- | | |
|--|------------------------|
| 1 x STABLOCK 4015 | |
| 1 x Keyboard (recommended accessory) | Ordering code: 248 192 |
| or AUTORUN Editor ARE (software option) | Ordering code: 897 100 |
| 1 x Interface "Centronics/RS-232/Keyboard" | Ordering code: 236 012 |
| or Interface "IEEE-488/RS-232/Keyboard" | Ordering code: 236 013 |

AUTORUN programs are normally entered into the main memory of STABLOCK 4015 with the keyboard (ASCII). One of the two interfaces is necessary for connecting the keyboard.

```
10 SETTX  
20 MODULATION  
30 FOR I=100 mV TO 1000 mV STEP 20 mV  
40 KEY 1 TO 5, "CONTINUE", GOTO 80  
50 GENAL #I  
60 IF MVOLT > 220 mV GOTO 100  
70 KEY RUN  
80 NEXT I  
90 END
```

Fig. 9.1: Listing of AUTORUN program. BASIC commands make sure your program runs in the required sequence, IEEE commands take care of setting up the equipment and retrieving the measured results.

If you often have to write extensive programs, you are better off with AUTORUN Editor ARE instead of the keyboard. ARE is a powerful, menu-prompted editor for program development on IBM-compatible PCs. By way of an IEEE interface card of the type PC II A (National Instruments) the PC transfers an AUTORUN program to STABLOCK 4015 for execution. For this the test set must be fitted with interface 236 013. Here are some of the features of ARE:

- The block function; this shifts, copies, prints and stores any parts of the program.
- An expandable library holds program modules that are frequently required.
- ARE manages line numbers automatically, even for goto statements.
- AUTORUN programs can also be copied from STABLOCK 4015 to the PC on the IEEE interface. This permits convenient revising of existing AUTORUN programs.

AUTORUN = BASIC + IEEE

AUTORUN programs use two different kinds of commands, which will be looked at more closely later on in the sections "BASIC Commands" and "IEEE Commands":

BASIC commands BASIC commands (BASIC: Beginner's Allpurpose Symbolic Instruction Code) provide for the required program sequence. They also enable the further processing of measured results, the entry of numeric values and character strings (texts) and the formatted output of reports on a printer (for printer connection, see Chapter 4, PRINT menu).

IEEE commands IEEE commands are used for setting STABLOCK 4015 and for retrieving measured results. The effect of these commands can be grasped intuitively. For example, the IEEE commands for calling up the basic TX mask and retrieving the measured RMS value are simply SETTX and MVOLT.

This page is intentionally left blank

AUTORUN Mask

The AUTORUN mask is the basic starting point for all AUTORUN functions:

- Write program
- Edit program
- Execute program

Calling up AUTORUN mask

- Preparation**
- ⇒ Call up the MEMORY mask with **MEMORY** and check that it shows the **AUTORUN** softkey (if not, switch to the next softkey level of the MEMORY mask with **DIR >>**) (Fig. 9.2).
 - ⇒ Check whether the main memory (RAM) of STABLOCK 4015 already contains an AUTORUN program. If so, the MEMORY mask will indicate the name of the program (with **AUT** label) in the directory of main memory.

Callup

Case 1: RAM contains an AUTORUN program.

Striking the **AUTORUN** softkey calls up the AUTORUN mask (Fig. 9.3). The name of the program appears in the mask header. You can now edit the program or start it with **RUN**.

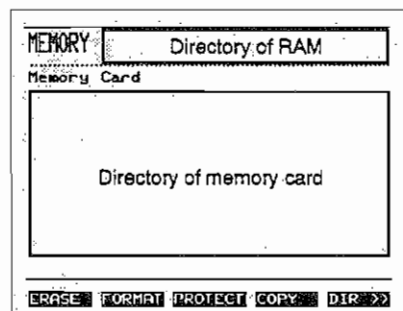

Fig. 9.2: This is what the MEMORY mask looks like when there is no memory card in the slot and main memory is entirely empty. **DIR >>** takes you to the next softkey level.

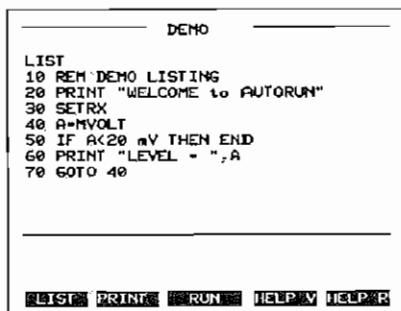

Fig. 9.3: The AUTORUN mask shows a listing of the current program as soon as you call it up. Requirement: the program (here DEMO) must first be filed in main memory.

Callup
(continued)

Case 2: RAM contains no AUTORUN program.

After you strike the (AUTORUN) softkey, STABLOCK 4015 does *not* show the AUTORUN mask but waits for the entry of a program name (see box). Reason: STABLOCK 4015 assumes that a new program is to be written. This requires entry of the program name in advance. Immediately after confirmation of the entry, the display shows the AUTORUN mask (Fig. 9.4). Now you can start writing the new program.

Fig. 9.4: The AUTORUN mask immediately after callup (case 2). The declared program name is AF TEST.

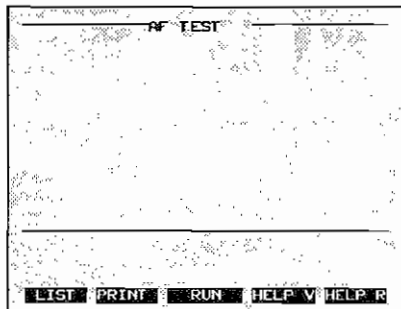

Return

(TX), (DUPL) or (RX) calls up the basic mask. (MEMORY) takes you back to the MEMORY mask. In all cases the loaded AUTORUN program is kept in main memory.

Issuing a new program name

If the RAM contains no AUTORUN program, striking the (AUTORUN) softkey will assign the softkeys of the MEMORY mask the letters of the alphabet, first in groups of five letters each. In the directory of RAM the cursor flashes in the entry field for the program name.

To enter a letter, first strike the softkey whose group contains the required letter (eg softkey (LMNOF) for the letter "M"). This labels the five softkeys with the five letters of the chosen group.

Striking a softkey enters the assigned letter at the position of the cursor in the entry field, and the softkeys again offer you the letter groups for entering the next character.

Exception: enter the letter "F" with the decimal-point key. Always confirm entry of the name with (ENTER).

Tips: If the program may have the standard name AUTORUN, simply strike the (ENTER) key after the (AUTORUN) softkey. To enter spaces, move the cursor on by one position. Incorrect letters are just overwritten. (OFF) deletes all characters to the right of the cursor. Abort an entry with (MEMORY). For changing an existing name, see Chapter 8.

Once the display shows the AUTORUN mask, the keys of STABLOCK 4015 are disabled. Exceptions: all softkeys, keys for returning plus the keys **PRINT**, **HELP** and **RESET**.

The AUTORUN mask is divided up into three areas, each of which has a precisely defined purpose (Fig. 9.5).

Display field

The display field of the AUTORUN mask constantly shows the listing during the *entry* of a program. During the *execution* of a program the PRINT commands produce the output of values or text in the display field (output to a printer is extra).

The display field comprises ten lines of 35 characters each. If a program listing has more than ten lines for example, the listing is automatically "scrolled": each new program line shifts the topmost line out of the display field.

Editing line

Below the display field is the editing line (Fig. 9.6). This is for entering new program lines and so-called direct commands (BASIC commands without a line number that are executed as soon as they are entered: eg PRINT "TEST"). For the subsequent editing of program lines that already exist in the editing line there are editing functions (see section "Editing programs"). The momentary write position is marked by a flashing cursor (after you call up the AUTORUN mask the cursor does not become visible until you first strike a key). The editing line makes up two lines on the display and, including the line number, holds maximally 68 characters; this is also the maximum length of a program line.

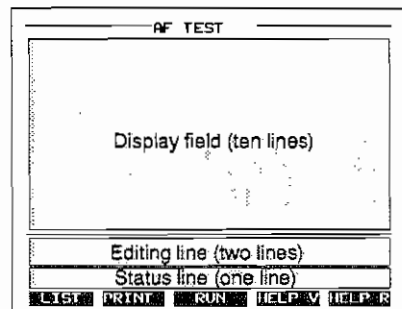

Fig. 9.5: The AUTORUN mask is split into three areas. All of these are relevant when you are developing a program. During the execution of a program the editing line is of no significance.

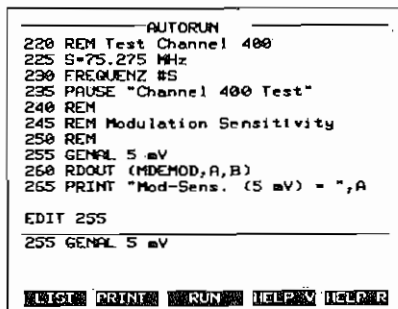

Fig. 9.6: Here the ready program line 255 was fetched back into the editing line with the EDIT command. Program lines can only be modified there.

Entries in the editing line are only possible with the keyboard. Each entry (program line, direct command) must be terminated by pressing the **RCL/RET** key on the keyboard. This transfers the current contents of the editing line to the display field. At the same time the editing line is prepared for the next entry.

Status line

The status line (directly above the softkeys) is reserved exclusively for error messages. Thus, for example, an attempt to execute the wrong direct command `PRONT "Test "` will immediately produce an error message.

Softkeys of AUTORUN mask

LIST Produces a complete list of the AUTORUN program currently in main memory (always starting with the first program line). If the listing is of more than ten lines, it will automatically be scrolled until the last program line appears in the display field. During this listing the **LIST** softkey takes on the **STOP** function (stops the scrolling of the listing). Listing of a specific section of a program is possible with the LIST editing command (see section "Editing commands"). Lines subsequently inserted in a program do not appear at the right place in the listing until after **LIST**.

PRINT This offers the choice of whether or not a printer is to log all entries during editing (printer interfacing: Chapter 4, PRINT menu). Repeated striking of the softkey activates/deactivates this function, accompanied by acknowledgement messages:

```
Edit mode Printing On
Edit mode Printing Off
```

 **PRINT** is only effective when you are editing programs; PRINT commands in programs are not affected by this function.

RUN This starts the AUTORUN program currently in main memory. **OFF** terminates program execution (press the key until termination).

HELP V As long as this softkey is pressed, the display will show the mask that was visible immediately before calling up the MEMORY mask (also applies to masks with opened menus). All *entry fields* of this mask have "identification numbers" assigned to them. You need these to enter new values in the entry fields with the IEEE command WRTVARIABLE.

HELP V also gives you important information when you want to make entries in menu windows with IEEE commands (more about this in the "IEEE Commands" section).

HELP R As long as this softkey is pressed, the display will show the mask that was visible immediately before calling up the MEMORY mask. All *display fields* of this mask have "identification numbers" assigned to them. You need these to query the contents of the display fields with the IEEE command RESULT (measured results).

 Identification numbers: see Quick Reference in Appendix F (Chapter 12).

Editing Programs

You need the keyboard or the AUTORUN editor ARE for editing programs (see under "Requirements"). The AUTORUN editor comes with its own operating instructions. So here we will concentrate on editing with the keyboard.

The keyboard has keys for editing program lines when they are in the editing line. There are also editing commands that affect defined sections of a program (eg deleting whole program blocks or renumeration).

Editing keys

There are keys on the keyboard for six editing functions (Fig. 9.7). The second occupancy of the keys (upper symbol) is valid if you hold one of the two SHIFT keys  depressed and then press the particular editing key.

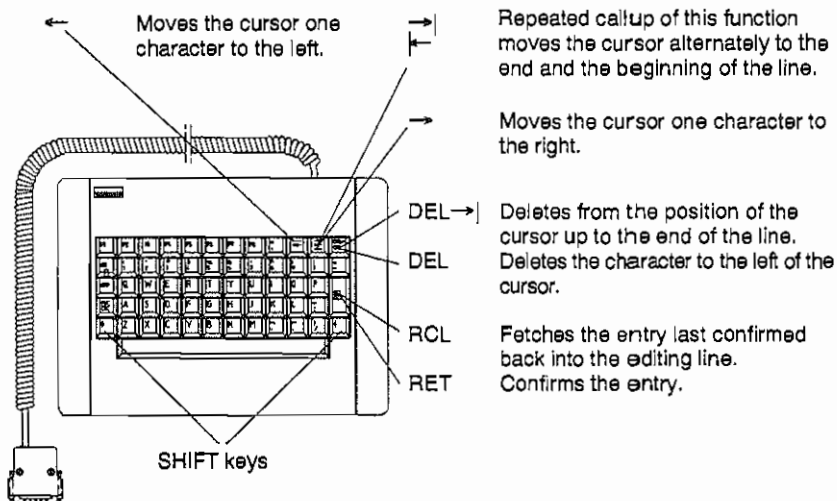

Fig. 9.7: For editing the momentary program line the keyboard offers six editing functions, partly accessed through SHIFT.

Editing commands

The editing commands must be entered letter by letter as direct commands from the keyboard and confirmed with **[RCL/RET]**. Instead of the full name of the command you may also just enter the first three letters (eg DEL instead of DELETE).

AUTO Automatically issues line numbers.

AUTO <i>x,y</i>	<i>x</i> = first line number, <i>y</i> = increment
------------------------	--

If you do not enter parameters *x* and *y*, they both default to 10. If an automatically issued line number is the same as one that already exists, the new program line will replace the previous one. The AUTO function is disabled if you do not enter a program line after a line number but immediately strike **[RCL/RET]**.

Example: AUTO 100,5

After entry of the command, the line number 100 is in the editing line and you can start entering the program line. As soon as this is terminated with **[RCL/RET]**, the next line number (105) appears in the editing line.

DELETE Permits deletion of specific program lines or whole program blocks.

DELETE <i>x</i>	Deletes the program line with line number <i>x</i> .
DELETE <i>x,</i>	Deletes all program lines from line number <i>x</i> onwards.
DELETE <i>x,y</i>	Deletes all program lines from line number <i>x</i> through <i>y</i> .
DELETE <i>,y</i>	Deletes all program lines up to line number <i>y</i> .

As an alternative to the **DELETE** *x* command, a program line will also be deleted if you press the **[RCL/RET]** key immediately after entering the particular line number.

EDIT Fetches a completed program line back into the editing line.

EDIT <i>x</i>	<i>x</i> = number of program line to be edited.
----------------------	---

The program line can be altered in any way and confirmation with **[RCL/RET]** will then put it straight back into the program. But: the altered program line does not appear in the listing until you list the program again with **[LIST]**.

LIST

Offers the function of the softkey of the same name in the AUTORUN mask plus the possibility of listing specific program blocks.

LIST	Lists complete program.
LIST x	Lists program line x.
LIST x,	Lists program from line x to end.
LIST x,y	Lists program from line x through y.
LIST ,y	Lists program from first line through line y.

When the LIST command is used, the **(LIST)** softkey adopts the **(STOP)** function, ie so that you can terminate the listing.

RENUM

Issues new line numbers for an entire program. This command is particularly useful if a program block has to be inserted between two program lines, but there are no longer enough vacant line numbers available. The destinations of GOTO and GOSUB commands are corrected automatically.

RENUM	Renumbers program with increment 10. 1st line number = 10.
RENUM x,y	Renumbers program with increment y. 1st line number = x.

Example: The following program is renumbered first with RENUM, then with RENUM 30,20.

Original numbering of program	Numbering after command RENUM	Numbering after command RENUM 30,20
5 SETRX	10 SETRX	30 SETRX
10 PRINT "RX-TEST"	20 PRINT "RX-TEST"	50 PRINT "RX-TEST"
15 SOFT_SPECIAL	30 SOFT_SPECIAL	70 SOFT_SPECIAL
20 SOFT_SENS	40 SOFT_SENS	90 SOFT_SENS
25 GOTO 5	50 GOTO 10	110 GOTO 30

RUN

Starts the program, like the softkey of the same name, and also permits starting the program onwards from a certain program line.

RUN	Starts program from first program line.
RUN x	Starts program from line x.

Writing Programs

An AUTORUN program is a logical series of commands that are executed in the given sequence after the program is started. The short programs in the sections "BASIC Commands" and "IEEE Commands" give a wealth of examples. We will not be giving you a thorough course in programming here because, firstly, we do not want the manual to become too "heavy" and, secondly, there are a lot of good books on this subject on the market anyway.

Fundamentals

- Program lines**
- ⇒ Permissible line numbers: 1 through 9999
 - ⇒ Maximum line length: 68 characters
 - ⇒ Each completed program line must be transferred from the editing line into the display field of the AUTORUN mask with the **[RCL/RET]** key of the keyboard.
 - ⇒ A program line may include several IEEE and BASIC commands. As delimiters you need a colon *after* BASIC commands and a semicolon *after* IEEE commands.
Example: 10 SETTX;PRINT A:PRINT"DEMO":SETRX
20 LET A=MPOWER:PRINT A
- Program size**
- ⇒ Maximum 16 Kbytes (if this is not enough, you can load "continuations" of a program from memory card with the BASIC command CHAIN).
- Syntax rules**
- ⇒ After line numbers you need not enter a space, although you can for the sake of clarity.
 - ⇒ A BASIC command must be followed by either a non-alphabetic character or (at least) one space (eg PRINT A or PRINT"DEMO"). This does not apply to the commands CLS, END and TRACE.
 - ⇒ For commands you can use upper-case and lower-case notation (eg PRINT=print, SETTX=settx).
 - ⇒ With variables *no* distinction is made between upper-case and lower-case notation.
 - ⇒ BASIC commands and numeric values must not be interrupted by spaces.
 - ⇒ When entering IEEE commands, you can use the short form (first five letters), eg WRTVA instead of WRTVARIABLE.
 - ⇒ When entering BASIC commands, you can use the short form (first three letters), eg PRI A instead of PRINT A.
Exception: The commands ONERROR GOTO and ONERROR GOSUB must *not* be abbreviated.

- Direct commands** ⇨ The BASIC commands BEEP, CLS, LET, PRINT and TRACE can also be executed directly. Thus, for example, you can enter PRINT A (without a line number) if you want to know the current contents of the variable A. IEEE commands *cannot* be executed directly.
- Arithmetic** ⇨ Only the four basic arithmetic operations are permissible (eg PRINT (3*4)/2-3+1).

Syntax check

The syntax check is handled by interpreters. In other words, after the start of the program each line is interpreted one after the other and the appropriate action is initiated. If the BASIC interpreter comes across a command in a program line that it cannot interpret, this command is automatically assumed to be an IEEE command and is handed over to the IEEE interpreter. If this cannot interpret the command either, there must be a syntax error.

-  When a program line is transferred from the editing line to the display field, there is *no* syntax check. This is always made after the start of the program. A detected syntax error causes the program to be aborted and leads to an error message indicating the erroneous program line (exception: branch to an error routine, triggered by the BASIC command ONERROR GOTO or ONERROR GOSUB).

Incorrectly entered direct commands or commands that are not admissible as direct commands will lead to the error message:
0201: FUNCTION ONLY WITH RUN.

Variables and units

Permissible variables The 26 variables A through Z may be used in AUTORUN programs for storing numeric values.

Permissible units A variable may be assigned a numeric value or a numeric value with one of the following units (see example):

f	T	m	R	P	V	Level
MHz	s	%	ohm	W	V	dBm
kHz	ms	rad		mW	mV	dB μ
Hz	μ s	kHz		μ W	μ V	dB
				nW		

```
10 A=5
20 B=5 MHz
30 C=-15dBm
```

Line 10 assigns the numeric value 5 to variable A. A space between the numeric value and the units is permissible but not necessary (line 20). In the units you can use upper-case and lower-case letters (line 30).

Variables in IEEE commands

If variables are used in IEEE commands, the variable must be preceded by a double sharp #. The units of a numeric value can either be declared simultaneously with the variable or stated explicitly in the IEEE command (see example). Missing or impermissible units (eg MODAF 2.5 mA) trigger an error message.

```
10 SETRX
20 MODAF 2.5 kHz
30 F=3.5 kHz
40 MODAF #F
50 F=4.5
60 MODAF #F kHz
```

First the program calls up the RX mask (line 10) and sets AF generator GEN to 2.5 kHz with IEEE command MODAF (line 20). Then GEN is set by a variable assignment with units to 3.5 kHz (line 30 and 40) and finally by a variable assignment without units to 4.5 kHz (line 50 and 60).

String variables

Character strings may consist of a series of characters between inverted commas (the string itself must contain *no* inverted commas). Examples of strings are persons' names, equipment designations, adjustment instructions or any messages. AUTORUN programs can show these strings on the display, print them out or check to see if they correspond to a reference string.

Permissible string variables

STABLOCK 4015 provides the twelve string variables A\$ through L\$ for storing character strings (the 13th string variable M\$ has a special function). Each string variable can hold strings of maximally 70 characters.

```
10 A$="TEST PROGRAM"  The string TEST PROGRAM is first saved in string
20 PRINT A$           variable A$ and then printed out.
```

Internally used string variable M\$



String variable M\$ has a meaning of its own: each IEEE command of the type "test job" automatically files the measured result in string variable M\$. The original contents of M\$ are then irrevocably lost!

```
10 LET A=MVOLT        The IEEE command MVOLT (query of RMS meter)
20 PRINT A            passes the measured result to variable A in line 10.
30 PRINT M$          The result is also automatically contained in string
                    variable M$. So both outputs (lines 20 and 30) lead
                    to the same result!
```

String variables in IEEE commands

Just like with variables, string variables in IEEE commands must also be preceded by a double sharp #.

```
10 A$="TEST "        The IEEE command DISP in line 20 produces display
20 DISP_#A$         of the text TEST. Line 30 displays the text TEST
30 DISP_#A$PROGRAM PROGRAM.
```

Splitting and joining strings

Parts of a string variable can be isolated by stating the start and end position of that part of the string which is to be isolated in brackets after the string variable.

```
1234567890123
```

```
A$="CHANNEL = 142"  
PRINT A$(11,13)
```

The channel number 142 adopts positions 11 through 13 in string A\$. So the PRINT command will only output the channel number.

A number of string variables can be joined with the "+" operator. But the resulting string must not be longer than 70 characters.

```
A$="Serial No. = "  
B$="6788954"  
C$=A$+B$  
PRINT C$
```

The string variables A\$ and B\$ are joined to form string variable C\$. The total string Serial No. = 6788954 is output.

Permissible operands

Many BASIC commands require the entry of so-called operands, different kinds being permissible:

Numeric operands	
Operand	Example
Numeric value without units	4, -2.5
Numeric value with units	5 MHz, 4 V
Variable A to Z	B
IEEE command of type "test job"	MVOLT
BASIC command leading to numeric value	LEN, HEX
String operands	
String	"TEST"
String variable	AS
BASIC command leading to string	CHRS

Permissible operands of BASIC commands

In the explanation of the commands in the "BASIC Commands" section, only the permissible type of operand is stated. You should then use one of the operands listed above.

Joining operands

Numeric operands may be joined with the following operators:

- + Addition (also valid for joining string operands)
- Subtraction
- * Multiplication
- / Division

All operators have the same priority. A superordinate priority is only possible with bracketed expressions.

Examples:

$1+2*3+4=13$ $(1+2)*(3+4)=21$ $2\text{ V}+3\text{ V}=5\text{ V}$ $\text{MVOLT}+2\text{ mV}=\text{eg } 12\text{ mV}$

☞ If numeric operands show units, there are special rules for joining them:

- Operands with different units must not be joined (error message: DIMENSION. Eg MHz and mV ?).
- Operands with and without units may be joined. The result always takes the units of the operand to the *right* of the operator. If this operand has no units, the result will not have any units either.

```
10 A=5
20 B=10 kHz
30 PRINT A+B
40 PRINT B+A
```

Here an operand without units (A) and an operand with units (B) are joined by the operator "+". Line 30 produces as the result 15.0000 kHz, but line 40 only 15 (different number of places: see BASIC command "PRINT").

When memory gets scarce

The main memory of STABLOCK 4015 offers maximally 16 Kbytes for AUTORUN programs. Longer programs are only possible by joining subroutines with the BASIC command CHAIN. Sometimes, however, a program will only be a few bytes too long. In such cases it is better to take another close look at the listing and try to relieve it of "ballast". Basically you can say that each character takes up one byte. There are the following ways of cutting down on program:

1. Use the short forms of the commands all the way through (for BASIC commands only the first three letters, for IEEE commands only the first five letters).
2. Shorten comments in REM lines.
3. Fit several commands into one program line (saves line numbers and control characters CR+LF).
4. Delete spaces in PRINT commands that are only inserted to make the expression look "pretty" (formatting). Eight of these spaces can be replaced by the separator ",", without any loss of clarity (saves seven bytes). Example:
PRINT, "POWER" instead of PRINT " POWER "
5. Delete spaces that are only inserted for the clarity of the listing. These also include spaces between a line number and the first command of the program line.

Executing Programs

- Start** AUTORUN programs are started with the **(RUN)** softkey or with the command RUN x (x = line number). Communication monitor will then begin to execute the program line by line.
- Execution** All setting instructions of an AUTORUN program can be followed on the display. If the basic RX mask is called up with IEEE command SETRX for example, this really will show the RX mask on the display.
- As long as an AUTORUN program is running, the display will show the script **AUTORUN** in the top left corner. This enables a clear distinction between operating states set by the program and those set manually.
- During program execution all keys of STABLOCK 4015 are normally disabled (exceptions: **(RESET)** and **(OFF)**). Commands like KEY and PAUSE will enable the softkeys however; the INPUT command permits extra entries on the numeric keypad.
- End** As soon as a program is ended, the display shows the **AUTORUN** mask. Otherwise the test set retains its last operating state. The display field shows the results of the PRINT commands executed by the program (if a program has a lot of PRINT commands, printed reports are preferable because the display field with its ten lines can only show the last PRINT outputs).
- Abort** **(OFF)** interrupts execution of the program (keep the key pressed until the program aborts).
- Reset** **(RESET)** eliminates a blockade of the internal data processing, but without deleting the program. The **AUTORUN** mask must then be called up again. A total reset (see Chapter 1) clears the program in main memory.

Saving Programs

The RAM of STABILOCK 4015 can only hold a single AUTORUN program. This program is overwritten when you enter a new program or another AUTORUN program is loaded from a memory card. So AUTORUN programs should always be saved on memory cards. The procedure for this is as follows:

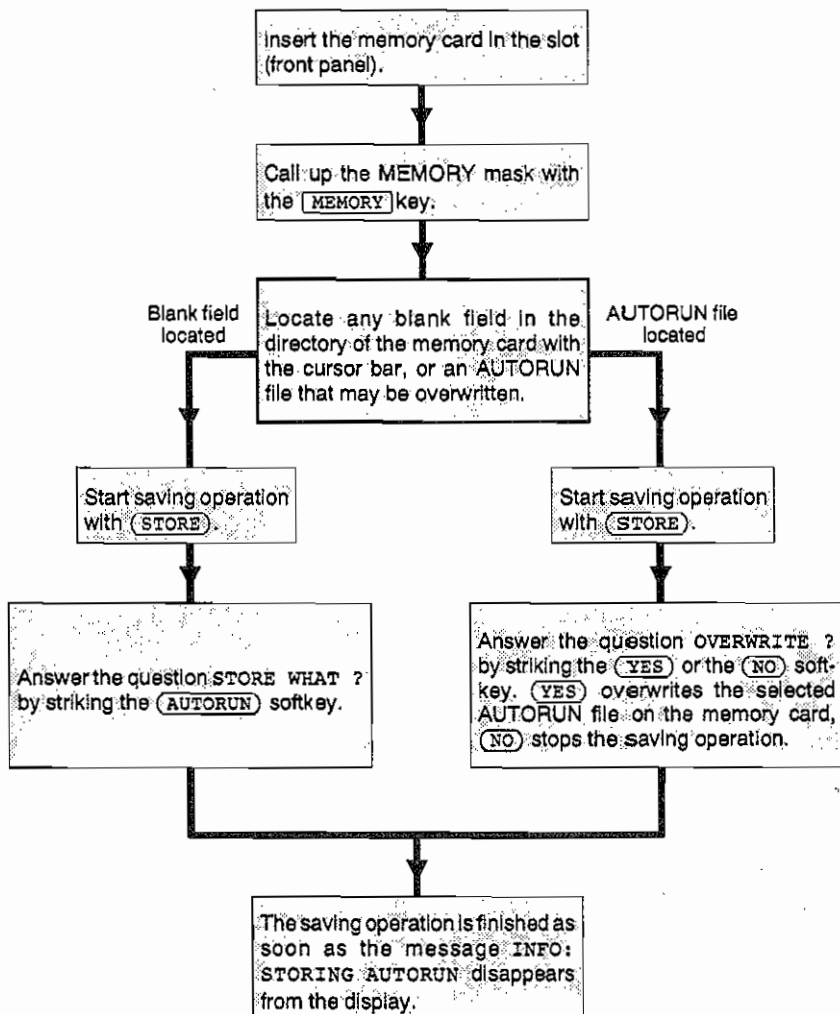

Loading Programs

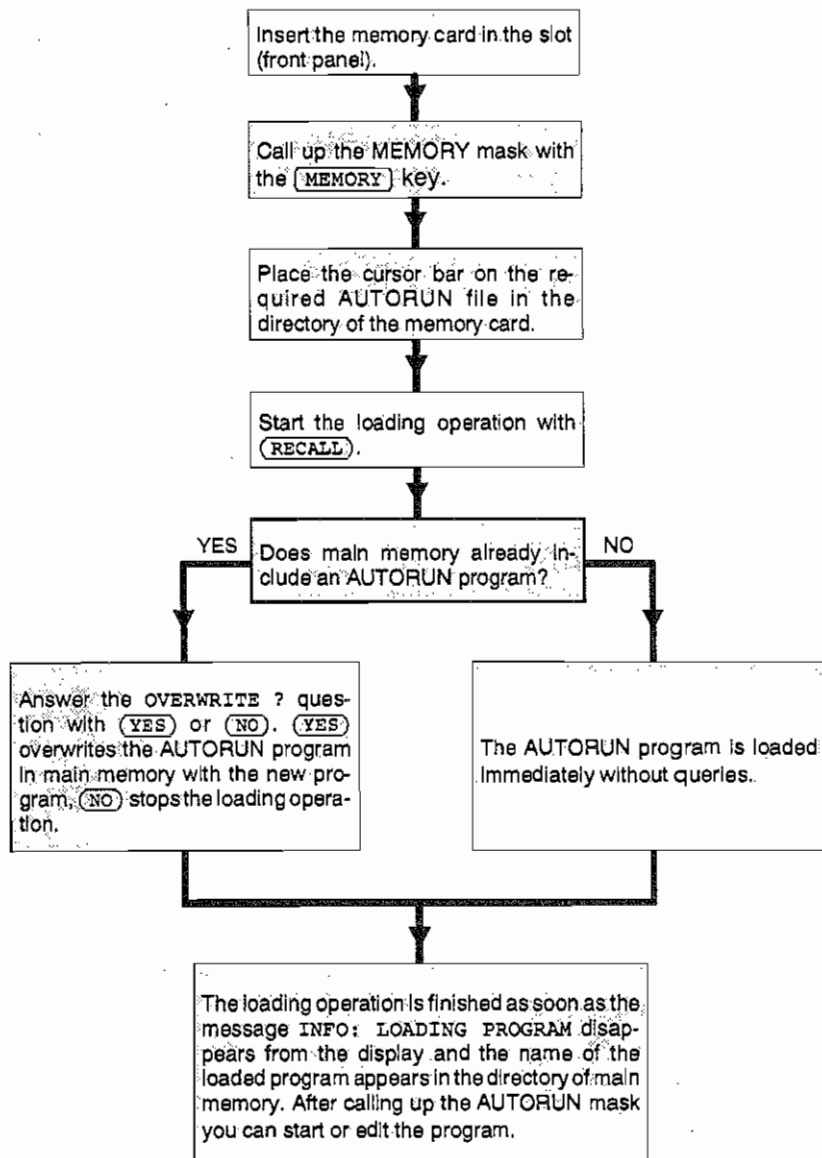

Deleting Program in RAM

Call up the MEMORY mask with the **MEMORY** key.

Place the cursor bar on the AUTORUN file displayed in the directory of main memory.

Start the deleting operation with **ERASE**.

Answer the question ARE YOU SURE ? with **YES** or with **NO**. **YES** deletes the AUTORUN program in main memory, **NO** stops the deleting operation.

BASIC Commands

Command	Purpose
BEEP	Generate alarm tone
CHAIN	Join two or more AUTORUN programs
CHRS	Convert numeric code into ASCII characters
CLS	Clear display contents
END	Terminate program execution
FOR-NEXT	Execute program section several times
GOSUB	Call up subroutine
GOTO	Skip program section
HEX	Convert hexadecimal to decimal
IF-INLIMIT	Relation-dependent program branch
IF-OUTLIMIT	Relation-dependent program branch
IF-THEN	Relation-dependent program branch
INPUT	Request user input
KEY	Softkey-dependent program branch
LEN	Determine length of string
LET	Variable assignment
ONERROR GOTO	Program branch upon error message
ONERROR GOSUB	Program branch upon error message
PAUSE	Interrupt program until user responds
PRINT	Output texts and values (on display and printer)
RDOUT	Transfer measured value to variable
REMARK	Insert remarks in programs
SETUP	Load setup from memory card
TRACE	Troubleshooting in programs
VAL	Convert string to numeric value
VAL\$	Convert numeric value to string
WAIT	Interrupt program for defined period

Brief description of BASIC commands

BEEP

Purpose Generate alarm tone.

Syntax **BEEP**

Effect Each BEEP command generates an alarm tone ($f = 2.8 \text{ kHz}$) lasting 250 ms.

Example 10 BEEP: BEEP: BEEP
 20 WAIT 1000
 30 BEEP: PAUSE "ADJUST SIGNAL"
 40 INPUT A
 50 IF A>20 THEN BEEP

Line 10 triggers the beep three times. Then the program waits 1 s (line 20) before, accompanied by a further beep, reading out the message ADJUST SIGNAL on the display (line 30). In line 40 the program requests the user to enter a numeric value; if the entered value is greater than 20, the entry is acknowledged with a beep (line 50).

CHAIN

Purpose Join two or more AUTORUN programs. If the capacity of main memory (16 Kbytes) is too small for a program for instance, the program can be split up into subroutines of 16 Kbytes each. At the end of one subroutine CHAIN calls up the following one.

Syntax **CHAIN** [file name]

or

CHAIN # [string variable]

[file name]	Name of AUTORUN program stored on memory card
[string variable]	eg A\$, where A\$ must include name of AUTORUN program stored on memory card

Effect CHAIN stops further program execution, loads the specified AUTORUN program from the memory card in the slot and starts this program. The new program clears the original one in main memory!

CHAIN resets the count variable of FOR...NEXT loops to the initial value. The contents of all other variables are preserved, however, and can continue to be used by the new program. If the CHAIN command is in a subroutine (GOSUB), there is no return to the main program.

Example

```
10 INPUT "DATE = ?" ,A$
20 INPUT "UNIT TYPE = ?" ,B$
30 INP "CHOOSE PROGRAM: 1=RX TEST 2=TX TEST" ,A
40 IF A>2 GOTO 30
50 C$="TX TEST"
60 IF A=1 THEN C$="RX TEST"
70 CHAIN #C$
80 PRINT "NO COMMAND AFTER CHAIN"
```

This program (start menu) first requests the user to enter the date (line 10) and the type of equipment (line 20). The entered replies are saved in two string variables (A\$ and B\$). Line 30 offers the user a choice between receiver and transmitter tests. Depending on the entry (variable A), the string variable C\$ in line 50 or 60 is assigned the name of the appropriate AUTORUN program, ie RX TEST or TX TEST (without the .AUT extension). Both programs must (in this example) be on the memory card presently in the slot. The CHAIN command (line 70) loads the required program and starts it automatically. The start menu in main memory is cleared so that line 80 of the start menu can no longer be executed.

The newly loaded AUTORUN program can evaluate the contents of the adopted string variable (A\$, B\$) and print them out in the test report for example.

CHR\$

Purpose Output of control characters to printer.

Syntax **CHR\$** ([list])

[list]	A number (not a variable) or several numbers separated by commas between 0 and 255 (ASCII numeric codes)
--------	--

Effect CHR\$ permits, in particular, the output of control characters that *cannot* be generated directly with the keyboard (characters with the ASCII numeric codes 0 to 32). If characters with the numeric codes 33 to 127 are output, the display field shows the corresponding ASCII characters (standard ASCII characters with a few exceptions). This output on the display is of no significance however.

Normally the CHR\$ command is also responsible for showing special characters on the display. In STABILOCK 4015 this is unnecessary because all special characters (eg Ω) can be generated directly with the keyboard (see box).

Example

```
10 PRINT CHR$(27,38,107,49,83)
20 PRINT "HEADLINE"
30 PRINT CHR$(27,38,107,48,83)
```

The program outputs with the CHR\$ command so-called escape sequences for the HP-2225 printer (accessory). Line 10 doubles the print width, so line 20 prints the word H E A D L I N E with double width. Line 30 switches back to normal print width. You can find out more about escape sequences in the printer manual.

Special characters

To enter special characters, first strike **FNC/ESC** key and release again. Then strike key shown in table.

Key	m	t	u	p	r	d	l	o
Special character	μ	Δ	↑	Φ	→	↓	←	Ω

CLS

Purpose Clear display contents, eg to free the display field for new text after several PRINT commands.

Syntax **CLS**

Effect CLS only clears the contents of the display field; the command has no effect on the program itself.

Example

```
10 PRINT "1. LINE"  
20 PRINT "2. LINE": WAIT 1000  
30 CLS  
40 PRINT "3. LINE"
```

The program shows the texts 1. LINE and 2. LINE for 1 s in the display field. Then the contents of the display are cleared and only the text 3. LINE is shown.

END

Purpose Terminate program execution.

Syntax **END**

Effect END commands can appear anywhere in the program. Thus AUTORUN programs can easily be tested section by section by inserting the command (temporarily) where the next section of a program begins. END always returns to the AUTORUN mask.

Example

```
10 SETTX
20 PRINT "COMMAND before END"
30 WAIT 1000
40 END
50 PRINT "COMMAND after END"
```

The program first calls up the basic TX mask (line 10). Then line 20 enters a text in the display field of the AUTORUN mask. This text is not visible at first however, because the display still shows the basic TX mask for 1 s (line 30). Line 40 terminates the program and returns to the AUTORUN mask, which now shows the text `COMMAND before END`. Line 50 is no longer executed.

This page is intentionally left blank

FOR...NEXT

Purpose Execute certain program section several times, the number of repeats being defined.

Syntax **FOR** [VAR]=[EXP1] **TO** [EXP2] **STEP** [EXP3]
...
program section
...
NEXT [VAR]

[VAR]	Count variable (A to Z)
[EXP1]	Start value (numeric operand)
[EXP2]	End value (numeric operand)
STEP [EXP3]	Step width (numeric operand) optional

Effect If the BASIC interpreter finds a FOR command, count variable VAR is assigned the start value EXP1 and then the following section of the program is executed up to the NEXT command. The NEXT command increments the value of the count variable by the value of the defined step width (if STEP [EXP3] is not stated, the step width is automatically 1). Then the interpreter checks whether the new value of the count variable is greater than the defined end value EXP2.

⇒ If so, the FOR...NEXT loop is ended. The program is continued with the command that follows the NEXT command. The count variable now has a value equivalent to the sum of the value last assigned and the step width!

⇒ If not, the section of the program in the FOR...NEXT loop is executed again.

If the step width EXP3 is negative, this reduces the value of count variable VAR. In this case the end value EXP2 must be smaller than the start value EXP1.



If the capacity of main memory permits it, as many as 26 FOR...NEXT loops can be nested within one another. Each loop must be given a differently worded count variable.

FOR...NEXT loops must not overlap. So a subordinate loop must always be ended with NEXT before the superordinate loop may be ended.

Examples

```
10 FOR K=-4 TO 4
20 BEEP: PRINT K
30 NEXT K
40 PRINT "Actual Value for K = ";K
```

This FOR...NEXT loop is run through nine times; it shows all values of count variable K (-4 to +4) in the display field. The PRINT command in line 40, however, reads out the value of the count variable, last incremented by +1 (step width), as 5.

```
10 FOR I=1kHz TO 3kHz STEP 0.5kHz
20 PRINT I
30 NEXT I
```

The operands of a loop may also include one of the permitted units. The PRINT command adopts the units and here reads out the values 1.0000 kHz to 3.000 kHz.

```
10 A=-5:B=5:C=2.5
20 FOR I=A TO B STEP C
30 PRINT I
40 NEXT I
```

The start and end value as well as the step width of the loop may also be defined with variables.

```
10 FOR K=1 TO 4
20 PRINT "FIRST LOOP K = ";K
30 FOR J=1 TO 3
40 PRINT "SECOND LOOP J = ";J
50 NEXT J
60 NEXT K
```

Here one loop is nested in another. The inner loop (variable J) is executed twelve times (4×3), the outer loop (variable K) four times. What is important is that the inner loop always be ended before the outer loop.

GOSUB...RETURN

Purpose Call up subroutine.

Syntax **GOSUB** [branch destination]

...
start of subroutine

...

RETURN

[branch destination]	Actually existent line number.
----------------------	--------------------------------

Effect When a main program finds a GOSUB command, program execution is continued in the line stated as the branch destination (start of subroutine). When the subroutine reaches the RETURN command, there is a return to the main program. Program execution continues there with the command following the GOSUB command.

Normally subroutines come at the end of a main program. When the main program reaches this point, the first subroutine is executed unintentionally before the interpreter can abort with the error message RETURN WITHOUT GOSUB. An END or GOTO command before the first subroutine prevents this malfunction.

Subroutines may call up further subroutines. Depending on available memory, a maximum of 25 subroutine levels is possible. RDOU commands and open FOR...NEXT loops, ie those not yet completed, reduce this figure. Each subroutine must be terminated with RETURN.

Examples

```
10 PRINT "LINE 10"  
20 GOSUB 50  
30 PRINT "LINE 30"  
40 END  
50 PRINT "LINE 50"  
60 RETURN
```

The main program (lines 10 through 40) calls up in line 20 a subroutine (lines 50 and 60). So the PRINT command in line 50 is executed before the PRINT command in line 30. Line 40 prevents the subroutine from being executed again and causing an error message.

```
10 PRINT "MAIN PROGRAM"  
20 GOSUB 40  
30 END  
40 PRINT "Subroutine 1"  
50 GOSUB 70  
60 RETURN  
70 PRINT "Subroutine 2"  
80 RETURN
```

The main program (lines 10 through 30) calls up in line 20 a subroutine (lines 40 through 60), which in turn calls up subroutine 2 (lines 70 to 80). Line 80 returns to line 60 and this returns to the main program (line 30).

GOTO

Purpose Program continuation from a defined line number.

Syntax **GOTO** [branch destination]

[branch destination]	Actually existent line number.
----------------------	--------------------------------

Effect When the BASIC interpreter finds a GOTO command, execution of the program is continued in the line stated as the branch destination.

GOTO in conjunction with the IF...THEN command, for example, permits a program branch as a function of the value of a measured result.

GOTO should always be the last command in a line.

Examples

```
10 BEEP
20 GOTO 10
```

Once it is started, this program is executed until you halt it with the **OFF** key.

```
10 FOR I=1 TO 10
20 PRINT I
30 IF I=5 THEN GOTO 50
40 NEXT I
50 PRINT "END"
```

The branch to program line 50 is not made until the count variable I of the FOR...NEXT loop becomes 5.

HEX

Purpose Convert hexadecimal to decimal.

Syntax **HEX** ([EXP])

[EXP]	String operand representing a single
-------	--------------------------------------

Effect HEX converts hexadecimal numbers (0 to FFFF) into the corresponding decimal numbers 0 to 65535 (from decimal number 9999 onwards, output of large numbers as exponents, eg 1.2345000E+04 instead of 12345). For hexadecimal numbers of >FFFF the result of conversion is always 0.

Example

```
10 C$="FAF"  
20 B$="STABILOCK "  
30 PRINT B$;HEX(C$)
```

The hexadecimal number FAF is converted by the HEX command of line 30 into the decimal number 4015.

IF...THEN

Purpose Program branch depending on result of relational operation.

Syntax **IF** [EXP1] [relational operator] [EXP2] **THEN** [command]

Compare numeric operands (numeric values)	
[EXP1] and [EXP2]	Numeric operand.
Relational operator	< > <= >= <> =
[command]	BASIC or IEEE command.
Compare string operands (character strings)	
[EXP1] and [EXP2]	String operand.
Relational operator	<> =
[command]	BASIC or IEEE command.

Effect The IF command compares the two operands EXP1 and EXP2 according to the declared relational condition:

⇒ If the relational condition is fulfilled, the command after THEN is executed.

⇒ If the relational condition is not fulfilled, the command after THEN is ignored and the program continues with the next line.

The naming of THEN is optional (entry not necessary).

When string operands are compared, a distinction is also made between upper case and lower case!

☞ If numeric operands with units are compared, you must ensure that both operands have the *same* units. The dimension of the units may be different however (eg IF 500 mV < 3V THEN...).

☞ If an IEEE command of the type "test job" produces no result (----), overflow (>>>>) or underflow (<<<<), these results satisfy every relational condition (command after THEN is executed).

Examples

```
10 FOR K=1 TO 10
20 IF K <= 8 THEN GOTO 60
40 PRINT "K>8"
50 GOTO 70
60 PRINT "K=";K
70 NEXT K
```

As long as the count variable K satisfies the relational condition ≤ 8 (line 20), the PRINT command in line 60 outputs the current value of the count variable. As soon as K is > 8 , the PRINT command in line 40 is valid.

```
10 INPUT "ENTER STATUS: PASS OR FAIL",A$
20 IF A$="PASS" THEN GOTO 40
30 GOTO 10
40 PRINT "TEST FINISHED": END
```

If the input request in line 10 is answered with PASS, then TEST FINISHED is output on the display. Any other entry (even pass) returns you to line 10.

IF OUTLIMIT / IF INLIMIT

Purpose Check whether a measured value is outside or inside a defined range.

Syntax **IF OUTLIMIT** ([READ], [EXP1], [EXP2]) **THEN** [command]
or
IF INLIMIT ([READ], [EXP1], [EXP2]) **THEN** [command]

[READ]	Variable (A to Z) or result of IEEE command of type "test job"
[EXP1]	Lower limit (numeric operand)
[EXP2]	Upper limit (numeric operand)
[command]	BASIC or IEEE command

Effect IF OUTLIMIT and IF INLIMIT are special forms of the IF...THEN command. The commands check whether the value of READ is outside/inside the range defined by the two limits EXP1 and EXP2. Depending on the result of the check, either the command after THEN is executed or it is ignored and the program continues with the next program line.

The following schematic illustrates for both commands what values READ must have so that the command after THEN is executed:

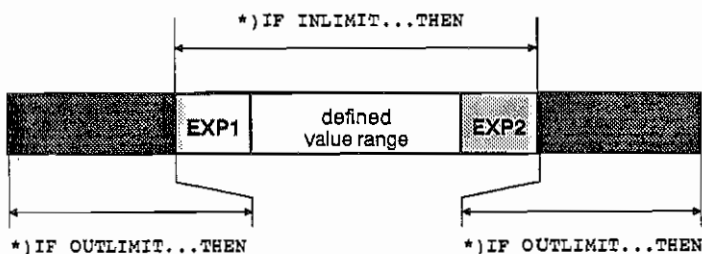

*) Only if READ appears in one of these ranges, is the command after THEN executed. The two limits EXP1 and EXP2 are only part of the defined range for IF INLIMIT.

The naming of THEN is optional (entry not necessary).



If numeric operands with units are compared, you must ensure that both operands have the *same* units.

The dimension of the units may be different however (eg IF INLIMIT (MVOLT, 200 mV, 1.2 V) THEN...).

If an IEEE command of the type "test job" produces no result (----), overflow (>>>>) or underflow (<<<<), these results satisfy every relational condition (command after THEN is executed).

Examples

```
10 FOR A=1 V TO 7 V
20 REM Valid values = 1 V and 5 to 7 V
30 IF OUTLIMIT(A,2V,4V)GOTO 50
40 PRINT "A=";A:GOTO 60
50 PRINT "VALID VALUE = ";A
60 NEXT A
```

The FOR...NEXT loop (lines 10 through 60) assigns the values 1 V to 7 V to variable A. In line 30 the OUTLIMIT command checks whether the condition $2\text{ V} < A < 4\text{ V}$ applies (because OUTLIMIT, without the limits 2 V and 4 V). Only if this is so, is the PRINT command in line 50 executed.

```
10 IF INLIMIT(MVOLT,0.1 V,0.2 V)GOTO 50
20 C$="MEASURED:" + VAL$(MVOLT) + "...ADJUST!"
30 PAUSE C$
40 GOTO 10
50 PRINT "YOU are the GREATEST"
60 END
```

As long as the result of the IEEE test job MVOLT does not fulfil the condition $0.1\text{ V} \leq \text{MVOLT} \leq 0.2\text{ V}$ (because INLIMIT, including the limits 0.1 V and 0.2 V), the current measured value and the request ADJUST! are shown on the display (line 30). The program will not reach line 50 until the AF test signal is within the limits, and then it rewards you for successful adjustment with the message YOU are the GREATEST.

INPUT

Purpose Request user input.

Syntax **INPUT** "[text]" , [VAR]

or

INPUT "[text]" , [S-VAR]

[text]	Message to be shown on display (optional).
[VAR]	Variable (A to Z) for taking numeric value.
[S-VAR]	String variable (A\$ to L\$) for taking text.

Effect INPUT shows the declared message and expects the entry of a numeric value or text in a field shown on the display (entry by keyboard or directly on the test set).

Entry of numeric value: maximum ten places.

⇒ Once the numeric value has been entered, it can be assigned units with **UNIT/SELECT**.

⇒ Incorrect entries can be overwritten until continuation of the program is triggered with the **CONTINUE** softkey.

Entry of text: maximum 30 characters.

⇒ When entering text from the keyboard, open the entry field by striking the **ENTER** key on STABILOCK 4015. As soon as the cursor in the entry field flashes, you can start entry on the keyboard. Always complete an entry with **RCL/RET**. Do *not* touch **DEL** (aborts program).

⇒ When entering text on the test set, strike the **ENTER** key to start. This assigns the softkeys the letters of the alphabet. Text entry is just like issuing program names (see section "Calling up AUTORUN mask"). Always complete an entry with **ENTER**.

⇒ Incorrect entries can be overwritten until continuation of the program is triggered with the **CONTINUE** softkey.

Examples 10 INPUT "SERIAL NO ?",A\$
20 PRINT A\$

Line 10 requires entry of a serial number. The entered numeric value is saved in string variable A\$ and printed out.

10 SETRX
20 INPUT "ENTER FREQUENCY and UNIT",F
30 FREQU #F

Line 20 expects the entry of a frequency including the units (eg 45 MHz). Line 30 enters the value in the RF Frequency field of the RX mask and tunes the signal generator with it.

10 SETTX
20 INPUT "ENTER CORRECTION VALUE",K
30 IF K+MPOWE > 3 W THEN PRINT "FAILURE"
40 PRINT "POWER = ";MPOWE

The entered correction value K (eg 1 W) is added to the measured RF power (MPOWE). If the result is greater than 3 W, the measured value is output with the comment FAILURE.

KEY

Purpose Program branch triggered by softkeys.

Syntax **KEY** [softkey number], "[text]", [command]

...
program section (optional)

...
KEY WAIT or **KEY RUN**

[softkey number]	Number (1 to 5) of required softkey (1 = first softkey from left).
[text]	Softkey designation (max. six characters; only middle softkey max. seven characters).
[command]	BASIC command GOTO, GOSUB or CHAIN.

Effect Initially KEY only assigns the name declared under [text] internally to a softkey. Then the program is continued until the interpreter detects KEY WAIT or KEY RUN:

- ⇒ KEY WAIT stops execution of the program and calls up the AUTORUN mask. Only here does the softkey have the declared label. If PRINT commands were issued in the program section directly before KEY WAIT, the display will show these outputs (eg user notes). If you now strike a softkey, the program will execute the declared BASIC command. At the same time the display again shows the mask that was current before the interruption.
- ⇒ KEY RUN also stops execution of the program, not showing the declared softkeys in the AUTORUN mask however, but in the current mask instead. Interactive user guidance with PRINT commands is not possible in this case. However, an instrument can be observed directly for instance and, depending on the measured value, a program branch can be made by softkey.

KEY 1 TO 5

If six or seven characters are not enough for the required softkey designation, a useful variant of the KEY command can help you out. The KEY 1 TO 5 command comprises all softkeys into a single softkey and assigns this a designation of up to 35 characters. Otherwise this command has the same effect as KEY.

Syntax: **KEY 1 TO 5**, "[text]", [command]



KEY command with GOSUB branch: after the subroutine has been worked, the main program is continued in the program line following the KEY WAIT or KEY RUN command.

Examples

```
10 CLS
20 KEY 3,"ENDLESS", GOTO 10
30 KEY 2,"END", GOTO 60
40 PRINT "PRESS SOFTKEY"
50 KEY WAIT
60 PRINT "END of PROGRAM"
```

The program stays in an endless loop if the user strikes the **ENDLESS** softkey. In this case line 10 prevents the display from gradually being filled with the request PRESS SOFTKEY: the CLS command clears the preceding message so that the next one again appears at the upper edge.

```
10 CLS
20 INPUT "MENU? NO=1 YES=0",A
30 KEY 1,"RXTEST", GOSUB 200
40 KEY 2,"TXTEST", GOSUB 310
50 KEY 3,"SELFCHEK",CHAIN SELFCHECK
60 KEY 4,"SPEC",CHAIN SPECIAL
70 KEY 5,"EXIT",GOTO 120
80 IF A<>0 THEN GOTO 200
90 PRINT "PRESS SOFTKEY to SELECT PROGRAM"
100 KEY WAIT
110 GOTO 10
120 END
200 REM RXTEST
...
300 RETURN
310 REM TXTEST
...
800 RETURN
```

First the program asks whether the "softkey menu" is to be offered (line 20). Entries other than 0 are understood as no (line 80). Only if A=0 will the program reach the PRINT command in line 90 and the following KEY WAIT command. The display now shows the occupancy of the softkeys declared in lines 30 to 70. Softkey 1 calls up the RXTEST subroutine for example. The return from this subroutine takes you to line 110, which causes the main program to start again.

Examples
(continued)

```
10 SETTX  
20 MODULation  
30 FOR I=100 mV TO 1000 mV STEP 20 mV  
40 KEY 1 TO 5, "CONTINUE", GOTO 80  
50 GENAL #I  
60 IF MVOLT > 220 mV GOTO 100  
70 KEY RUN  
80 NEXT I  
90 END  
100 PRINT "V > 220 mV !"
```

Line 10 calls up the basic TX mask, line 20 selects the internal AF generators as the signal source for the RMS instrument (corresponds to striking the RX MOD/MODGEN key). Then a FOR...NEXT loop begins. The purpose of this is to increase the output level of generator GEN in 20-mV increments from 100 mV to 1000 mV (line 50). Each increase in level must be initiated by the user by striking the CONTINUE softkey. If the level measured by the RMS instrument exceeds 220 mV (line 60), the FOR...NEXT loop is aborted by a branch to line 100. The actions of the program are easy to observe in the TX mask (change of level in Gen line, display of RMS instrument).

LEN

Purpose Determine length of string (number of characters).

Syntax **LEN** ([S-EXP])

[S-EXP]	String operand
---------	----------------

Effect The LEN command outputs the length of the examined string as a decimal number.

Examples

```
10 A$ = "STABILOCK 4015"  
20 L = LEN(A$)  
30 PRINT L  
40 PRINT LEN("LONGJOHNS")
```

The number of characters of A\$ (14) are assigned to variable L (line 20) and output (line 30). Line 40 shows that the string operand must not always be a string variable but can also be a string for example.

```
10 INPUT A$  
20 PRINT "String Length",LEN(A$)
```

Line 10 enables the entry of a random string. Its length is determined in line 20 and output.

LET

Purpose Variable assignment (**optional**).

Syntax **LET** [VAR]=[EXP]
or

LET [S-VAR]=[S-EXP]

[VAR]	Variable (A to Z)
[EXP]	Numeric operand
[S-VAR]	String variable (A\$ to M\$)
[S-EXP]	String operand

Effect **LET** is *not* necessary for a variable assignment (assigning a variable an operand). The only benefit of the command is the greater clarity of program listings.

Example

```
10 LET A=5*3
20 PRINT A-5
30 C$="Frequency = "
30 LET B=5 kHz
40 PRINT C$;B
```

Whether this listing does not look very "pretty" because of line 30 is purely a matter of taste. At any rate, **LET** commands have no effect at all on the functionality of programs.

ONERROR GOTO

Purpose Program branch when error messages appear.

Syntax **ONERROR GOTO** [branch destination]

[branch destination]	Actually existent line number.
----------------------	--------------------------------

Effect If the BASIC or IEEE interpreter detects an error during the execution of a program, it will normally be aborted straight away and an error message is output. ONERROR GOTO prevents an abort upon error and causes the program to be continued from the declared branch destination (error routine).

 **Disabling error routine:** If the BASIC interpreter only finds ONERROR GOTO (without entry of a line number!), aborting the program with an error message is permitted again from this program line onwards.

The short form is not permitted for this command.

Example

```
10 ONERROR GOTO 20
20 INPUT "Frequency 250...300 MHz",F
30 IF OUTLIMIT(F,250 MHz,300 MHz) GOTO 20
40 ONERROR GOTO
50 PRINT F
```

Line 20 tells you to enter a frequency value, which line 30 checks. If the wrong units are used in line 20, the program would normally be aborted. The branch in line 10 prevents this and instead repeats the request for entry. Line 40 cuts out the error routine.

ONERROR GOSUB

Purpose Program branch when error messages appear.

Syntax **ONERROR GOSUB** [branch destination]

...
start of error routine (subroutine)

...

RETURN

[branch destination]	Actually existent line number.
----------------------	--------------------------------

Effect Like ONERROR GOTO but branch to a subroutine. The RETURN takes you to the program line following the line in which the error was detected (see example).

 Disabling error routine: if the BASIC interpreter only finds ONERROR (without GOSUB and without entry of a line number!), aborting the program with an error message is permitted again from this program line onwards.

The short form is not permitted for this command.

Example

```
10 ONERROR GOSUB 70
20 INPUT "Frequency 250...300 MHz",F
30 IF INLIMIT(F,250 MHz,300 MHz) GOTO 50
40 GOTO 20
50 ONERROR: PRINT F
60 END
70 PRINT "! INPUT WRONG !"
80 BEEP: WAIT 1000
90 RETURN
```

Line 20 tells you to enter a frequency value, which line 30 checks. If the wrong units are used in line 20, the program would normally be aborted. Line 10 prevents this and instead calls up a subroutine (from line 70). The return from the subroutine goes to line 40, which repeats the request for entry. Line 50 disables the error routine when the entry is correct and outputs the entered value.

PAUSE

Purpose Interrupt program execution and wait for user reaction.

Syntax **PAUSE** [S-EXP1], [S-EXP2], [S-EXP3]

[S-EXPx]	String operand (max. 30 characters each).
----------	---

Effect PAUSE interrupts execution of the program and shows the texts contained in S-EXPx on the display (between zero and three string operands can be declared). Strike the **(CONTINUE)** softkey to continue the program.

Examples

```
10 SETTX
20 IF MPOWE > 0.5 W GOTO 50
30 BEEP:BEEP:PAUSE "TRANSMITTER ON"
40 GOTO 20
50 PRINT MPOWE
```

Line 20 contains an IEEE test job for RF power. If the measured result is less than 0.5 W, the message TRANSMITTER ON accompanied by two beeps tells you to switch on the transmitter of the test item.

```
10 A$="TEST PROGRAM"
20 B$="-----"
30 PAUSE A$,B$,"STABILOCK 4015"
```

This program shows the following three-liner on the display, the PAUSE command automatically inserting the blank lines:

```
TEST PROGRAM

-----

STABILOCK 4015
```

PRINT

Purpose Output numeric values, texts or measured results on display or to printer.

Syntax **PRINT** [output list]

[output list]	Any number of numeric operands and string operands; commas and semicolons are permissible as separators between operands.
---------------	---

Effect PRINT outputs every single item of the output list to the display and simultaneously to a printer. If the display does not show the AUTORUN mask during program execution, the PRINT outputs are not visible on the display until after the program has ended (if there are a lot of PRINT instructions only the last ones, however, because of the limited number of lines on the display).

Output of numeric values: here there are the following variants:

⇒ IEEE test jobs are output as a numeric value with units. If the IEEE test job is directly in the PRINT command (eg PRINT MVOLT), the output will be in the same form as the particular instrument shows the measured result. If you place emphasis on well formatted test reports, it is better to assign the measured result first to a variable and then output its contents (see examples). In this case the output is as described under "Numeric values with units". If a test job does not produce a valid result, the PRINT command will produce "-----" (no test signal), ">>>>" (overflow) or "<<<<" (underflow).

```
PRINT MVOLT          → 123 mV (for example)
```

```
A=MVOLT:PRINT A     → 123.0000 mV
```

⇒ Numeric values without units: values between 0 and 9999 are shown with maximally four places before and after the point (fourth place after the point rounded). Larger numeric values are output in scientific notation with one place before and seven after the decimal point plus a two-place exponent.

```
PRINT 1234.1234567  → 1234.1235
```

```
PRINT 12             → 12
```

```
PRINT 123456         → 1.2345600E+05
```

⇒ Numeric values with units: output with maximally four places before the decimal point and always four following it (fourth place after the point rounded). Leading zeroes are replaced by spaces so that orientation is always on the decimal point. For numeric values greater than 9999.9999 no value is output but instead the overflow symbol (>>>>). Remedy: choose the next biggest dimension.

```
PRINT 1234.1234567 kHz → 1234.1235 kHz
```

```
PRINT 12 kHz          → 12.0000 kHz
```

```
PRINT 1234567 kHz     → >>>>
```

Examples 10 PRINT"LINE A":PRINT:PRINT"LINE B";
(continued) 20 PRINT"LINE C"

Output on display:

LINE A

LINE BLINE C

As a result of the final semicolon in line 10, the PRINT command of line 20 adds the text LINE C immediately onto the text output before (LINE B).

```
10 SETTX
20 PRINT MVOLT
30 FOR A=1 TO 3
40 B=MVOLT
50 PRINT B
60 NEXT A
```

Output on display (assumed values):

```
 3.96 V
3.9600 V
3.5600 V
3.2800 V
```

At the instant of the measurement, the RMS instrument in the basic TX mask showed 3.96 V. So the IEEE test job MVOLT directly in the PRINT command (line 20) produces the same output 3.96 V. Such unforeseeable output formats can be avoided if you assign the result of a test job to a variable and output its contents first (lines 40 and 50). Then all outputs of measured values have a format oriented on the decimal point.

RDOU

Purpose Assign results of IEEE command of type "test job" to variables. The two results of the IEEE test job MDEMOD (sampling of modulation meter), for example, can only be further processed with RDOU.

Syntax **RDOU** ([command]; [VAR])

[command]	IEEE command of type "test job".
[VAR]	Single variable (eg A) or list of variables separated by commas (eg A,B).

Effect RDOU adopts the result(s) of an IEEE test job in the declared variable(s). If there are more measured values than variables, no error message is produced. But if more variables are declared than there are measured values, this will trigger an error message.

The direct variable assignment of IEEE test jobs (eg A=MVOLT or B=RESULT1) makes RDOU dispensable in some cases. But if a measurement produces more than one result and the corresponding display fields have no identification numbers (can be checked with HELP R), you have to work with RDOU.

Examples

```
10 SETRX
20 MODULation
30 RXAFM 4 kHz
40 RDOU(MDEMOd;A,B)
50 PRINT "MOD =" ;A,,B
```

Line 10 calls up the RX mask. Line 20 couples the modulation meter MOD to the modulator. Line 30 causes the carrier signal of the signal generator to be modulated with ± 4 kHz FM deviation. In line 40 MDEMOd (IEEE command) takes over the deviation measurement. The resulting measured values (positive and negative peak deviation) are adopted in variables A and B and then output (line 50).

REMARK

Purpose Insert remarks in program listing.

Syntax **REMARK** [remark]

[remark]	Random character sequence.
----------	----------------------------

Effect Program lines starting with a REM command are not executed but are output in the listing.

GOTO or GOSUB commands may have REM lines as a branch destination. The program is then continued with the program line after the REM line.

Example

```
10 REM *****
20 REM TX-TEST
30 REM *****
40 SETTX
50 FREQUENCY 275.250 MHz: REM Setting
   ...
   ...
```

The REM lines 10 through 30 in the listing make it clear that this program is to take a good look at the transmitter of a radio set. Even "proper" program lines like line 50 may have REMarks at the end (*not* at the beginning).

SETUP

Purpose Call up a setup stored on memory card.

Syntax **SETUP** [file name]

or

SETUP #[S-VAR]

[file name]	Name of required setup.
[S-VAR]	String variable containing name of setup.

Effect The SETUP command calls up stored instrument settings. These must be held as a SET file on the memory card in the slot.

The effect of the SETUP command is the same as in manual callup of a setup.

Example

```
10 REM TX TEST
20 SETUP TX MODE:GOSUB 100
30 REM SPECTRAL TEST
40 A$="ANALYZER"
50 SETUP #A$:GOSUB 800
60 END
```

This program first calls up the "TX MODE.SET" setup file in line 20 and then branches to line 100 (TX test). After this test the "ANALYZER.SET" setup file is called up and the program continues in line 800.

TRACE

Purpose Troubleshooting in programs.

Syntax **TRACE**

Effect The TRACE command outputs to a printer the number of the program line that has just been processed during the execution of a program. The resulting report shows in what sequence the program lines were processed.

If the contents of the display are not cleared with CLS, the TRACE report will also be visible on the display (AUTORUN mask). But there it may be overwritten in part by PRINT commands of the examined program and thus become useless.

TRACE acts like a switch: repeated issuing of the command switches the function alternately on and off (acknowledgement message: Trace On / Trace Off).

TRACE can be used both as a direct command and in programs.

Example

```
10 SETTX;V_RMS;GENA_TX;MODUL
20 FREQUENCY 10 MHz
21 TRACE
30 FOR I=1 TO 5
40 INPUT "ENTER RMS VALUE",V
50 IF V>=5 V GOTO 90
60 PRI "VALUE =";V
70 NEXT I
80 GOTO 100
90 PRI "ERROR"
100 TRACE
101 END
```

The TRACE command in line 21 documents the following branches and loops in the program. Line 100 switches the function off again. Without line 100 the function would remain switched on and would be switched off unintentionally the next time the program is started (line 21).

VAL

Purpose Convert number in string to numeric value.

Syntax VAL ([S-EXP])

[S-EXP]	String operand containing only a number or beginning with one.
---------	--

Effect VAL extracts the number contained in the string operand (end criterion: first character that is no numeral or decimal point). If the string operand starts with a letter, there will be an error message.

If the number in the string operand is assigned units, these will not be separated by VAL.

VAL does the opposite of the VAL\$ command.

Example

```
10 A$="123TEST"
20 B$="1.24TEST"
30 C$="5,6"
40 A=VAL(A$):B=VAL(B$):C=VAL(C$):D=VAL("12 V")
50 PRINT A,B,C,D
60 PRINT A+B
```

Output on display:

```
123      1.24      5      12.0000 V
124.24
```

VAL\$

Purpose Convert numeric value to string.

Syntax VAL\$ ([EXP])

[EXP]	Numeric operand
-------	-----------------

Effect VAL\$ does the opposite of the VAL command.

Example

```
10 A$="STABILOCK "  
20 B$=VAL$(4015)  
30 C$=A$+B$  
40 PRINT C$
```

The numeric value 4015 is converted into a string in line 20. Line 30 chains the strings B\$ and A\$, line 60 outputs the result: STABILOCK 4015.

WAIT

Purpose Stop program execution for a certain time.

Syntax **WAIT** [time]

[time]	Queuing time in milliseconds (1 to 9999 ms).
--------	--

Effect WAIT stops the execution of a program for the duration of the declared queuing time.

Example

```
10 SETX
20 WAIT 5000
30 SETRX
40 WAIT 5000
50 GOSUB 1000
```

The program waits 5 s after the TX mask is called up before calling up the RX mask. This also remains visible for 5 s before the program continues with line 50.

Error Messages

General errors		
No.	Message	Explanation (EXAMPLE)
0201	FUNCTION ONLY WITH RUN.	Function only available during program execution (GOTO 540)
0202	FUNCTION NOT IMPLEMENTED.	Function not available
0203	USER STOP EXECUTED.	Program aborted with OFF key
Editing errors		
No.	Message	Explanation (EXAMPLE)
0210	LINE TOO LONG.	Line longer than 68 characters
0211	BAD LINE NUMBER. 1..9999	Invalid line number (EDIT 10000)
0212	BAD GOTO/GOSUB. Line number ?	GOTO/GOSUB without line number (GOTO 10100)
0213	PROGRAM MEMORY FULL.	Program memory (16 Kbytes) full
0214	CORRUPT PROGRAM. RELOAD.	Program incorrectly loaded. Repeat loading operation
0215	RENUMBER INCREMENT TOO LARGE.	Increment for RENUMBER command too large
0216	RENUMBER UNMATCHED GOTO/GOSUB.	GOTO/GOSUB without line number when executing RENUMBER
Syntax errors		
No.	Message	Explanation (EXAMPLE)
0220	BAD SEPARATOR.	Wrong separator (INPUT A.B)
0221	BAD NUMBER.	Wrong number (WAIT 99999)
0222	BAD STRING. Eg "text" "text" ?	Wrong string delimiter (A\$ = "text")
0223	CONDITION (= <> << >> >=).	Wrong relation (IF A. B THEN GOTO 10)
0224	DELIMITER EXPECTED.	Delimiter missing (KEY 1 to 5 ...)
0225	VARIABLE EXPECTED.	Variable missing
0226	EQUAL CHARACTER EXPECTED.	= or <> expected (IF A\$ > B\$)
0227	TO EXPECTED. Eg for a=1 to 10	"TO" missing (in FOR..NEXT loop)
0228	OUTLIMIT. Eg out(mvolt, lo, hi)	Wrong syntax for OUT command
0229	RDOU. Eg rdout(mmeas; a, b)	Wrong syntax for RDOU command
0230	KEY Eg num, "text", cmd	Wrong digit for KEY command
0231	NO KEYS. Add KEY 1, "text", cmd	Wrong syntax for KEY command
0232	MID SYNTAX. Eg A\$(3, 5) is 345	Wrong syntax for fields
0233	BAD NUMBER. Max 70, start<end	Wrong variable
0234	STRING NOT NUMBER. Eg "12"	String has no numeric format (PRINT HEX("GF"))
0235	STRING. Eg a\$-d\$ "S" ms\$(3, 4)	Wrong string format (A\$=1)

Program errors		
No.	Message	Explanation (EXAMPLE)
0240	RETURN WITHOUT GOSUB.	RETURN without preceding GOSUB
0241	STACK FULL. Too many gosubs?	Memory full (possibly too many GOSUBs)
0242	NO MATCHING FOR STATEMENT.	NEXT without FOR
0243	DIMENSION. Eg MHz and mV?	Dimensions wrong or missing (FOR I=1 to 10V)
0244	MISSING OR EXCESS BRACKETS.	Brackets wrong or missing
0245	MATHS ERROR.	Illegal mathematical operation (PRINT 1/0)
0246	RDOUT VARIABLE NOT USED.	RDOUT command cannot assign value to variable (RDOUT(MPOWE; a, b))
Errors in IEEE commands		
No.	Message	Explanation (EXAMPLE)
0260	BAD #. Eg a=1.2 kHz: modaf #a	Wrong MODAF assignment
0261	IEEE SYNTAX. See APPLICATION.	Syntax error message from IEEE interpreter (A = MBOLT)
0262	COMMAND EXPECTED.	IEEE command not found
0263	MEASUREMENT EXPECTED.	Test job not found
0264	UNKNOWN IEEE KEYWORD.	IEEE command not recognized
0265	FILE NOT FOUND. (.SET .AUT)	Required AUTORUN or setup file not found on memory card

IEEE Commands

So that you can find an IEEE command faster, the following section is divided up as follows:

Actions in masks	Actions on front panel	Actions in menus
Test jobs	Special commands	

All the IEEE commands described here are permissible in AUTORUN programs and for remotely controlling STABLOCK 4015 (see Chapter 11).

Introduction

Only the first five characters are relevant for recognizing an IEEE command (when a command is named, these characters are shown in capitals). To enable better understanding of a program however, any number of characters can be added to a command (eg `SETDUPLEX` instead of `setdu`). No distinction is made between upper-case and lower-case letters.

Many IEEE commands require the entry of parameters. These can be numeric values with and without units, softkey designations or states (on/off). The parameters necessary for a command are stated along with the explanation of the particular command (terms in brackets, eg `[value] [unit]`). If different entries are permissible for a parameter (eg different units), all possible entries are listed and separated by "|".

If a parameter calls for the entry of a defined text (eg softkey designation), the text does not have to be entered in its entirety but only enough for unique identification of the required parameter (short form). If a program is to operate the `(SCOPE)` softkey for instance, you can enter `SOFT_SC` instead of `SOFT_SCOPE`. `SOFT_S` is not permissible because it could lead to confusion with the softkeys `(SPECIAL)` and `(SYSTEM)`. In the details of the different parameters the permissible short form is shown by capitals. For the parameter `[state]`, for example, the following entries are possible: `oN|oFf`. In other words, instead of `oN` you can enter just `N`. But be careful, always enter units in full (no short forms).

Masks called up with IEEE commands differ in one point from those that are called up manually: the instruments are *not* activated. First you must issue a test job before the appropriate instrument is polled and briefly activated. The instrument then shows the result on the display until the next test job, producing a new result.

Actions in masks

Key	IEEE command	Meaning
Select mode		
RX	SETRX	Calls up basic RX mask.
TX	SETTX	Calls up basic TX mask.
DUPL	SETDuplex	Calls up basic DUPLEX mask.
SCOPE	SOFT_Scope	Calls up storage oscilloscope. Start measurement with special command LOCAL.
ANALYZ	SOFT_Analyz	Calls up spectrum analyzer. Start measurement with special command LOCAL.
Operate softkey		
?????	SOFT_[name] SOFT_[name], [state]	Operates declared softkey. Activates/deactivates softkey with toggle function (eg MARKER function in scope modes). Before a softkey can be operated, the mask showing the declared softkey must be called up.
	[name] = designation of softkey [state] = on off	SOFT_FREEZE SOFT_MARKER, OF
Set RF parameter		
FREQU	FREQU [value] [unit] TXFRE [value] [unit] RXFRE [value] [unit]	Sets RF frequency in RX and TX modes (Frequ field). Sets TX frequency in DUPLEX mode (or TX). Sets RX frequency in DUPLEX mode (or RX).
	[value] = frequency (numeric) [unit] = MHz NoL NoU Chn	FREQU 75.234 MHz TXFRE 4 NoL
LEVEL	AMPLI [value] [unit] RFLEvel [state]	Sets RF output level. Switches signal generator on/off.
	[value] = level (numeric) [unit] = dBm dBu uV mV V [state] = on off	Examples AMPLI -60 dBm RFLEV N or RFLEV F

Key	IEEE command	Meaning
Fill in ZOOM masks		
ZOOM	ZOOM_[signal],[C],[R],[T]:[text]	<p>Calls up required ZOOM mask and defines center scale, scale ends plus tolerance zone. To continue program, operate one of softkeys.</p> <p>[signal] = AF Mod/demod RF power Offset (signal source) [C] = center scale (numeric with units) [R] = scale end (numeric) [T] = extension of tolerance zone (numeric); optional [text] = any text (max. 35 characters) to be shown instead of softkeys (this text is optional, if it is missing, CONTINUE is displayed automatically)</p> <p>Example</p> <pre>10 SETTX;TXFREQ 27.205 MHz 20 ZOOM_RF,9.00 W,3.00,0.5:Adjust RF POWER! 30 L=MPOWER:PRINT L</pre> <p>The program calls up the RF power meter PWR with a defined measurement range in full format (line 20). Adjust RF POWER! tells you to adjust the transmitted power to 9 W±0.5 W (tolerance zone = 0.5 W). Operate any softkey after adjustment and the RF power is measured and its value read out (line 30).</p>
PEAK	PEAKHold [value]	<p>Triggers peak-hold measurement if modulation meter DEMOD is polled in ZOOM mode with measurement job MDEMODO.</p> <p>[value] = duration of peak-hold measurement in ms (max. 9999).</p> <p>Example</p> <pre>10 SETTX 20 ZOOM_M,20 kHz,5.00 30 PEAKHold 1000;RDOU(MDEMOd;A,B):PRINT A,B 40 PRINT MDEMO</pre> <p>The program calls up the modulation meter DEMOD (line 20). Operating the CONTINUE softkey triggers peak-hold measurement lasting 1 s, the result of which (pos./neg. peak value) is output (line 30). For the following measurement job (line 40) PEAKH no longer applies.</p>

Key	IEEE command	Meaning
Set modulation (RX or DUPLEX mode)		
MOD	RXAFM [value] kHz	FM modulation with GEN
	RXBFM [value] kHz	FM modulation with DATA
	RXCFM [value] kHz	FM modulation with 1-kHz generator
	RXEFM	FM modulation with external signal
	RXAPM [value] Rad	ΦM modulation with GEN
	RXBPM [value] Rad	ΦM modulation with DATA
	RXCPM [value] Rad	ΦM modulation with 1-kHz generator
	RXEPM	ΦM modulation with external signal
	RXRAM [value] %	AM modulation with GEN
	RXBAM [value] %	AM modulation with DATA
RXCAM [value] %	AM modulation with 1-kHz generator	
RXEAM	AM modulation with external signal	
[value] = modulation (numeric)		RXBFM 2.8 kHz
Set AF frequency		
MODFREQ	MODAF [value] kHz	Set generator GEN frequency.
	MODBF [value] kHz	Set generator DATA frequency.
[value] = frequency (numeric)		MODAF 3.8 kHz
Set AF output level (TX or DUPLEX mode)		
MOD	GENAL [value] [unit]	Level setting GEN
	GENBL [value] [unit]	Level setting DATA (option)
	GENCL [value] [unit]	Level setting 1-kHz generator
	[value] = level (numeric)	Examples
[unit] = mV V dBm	GENAL 120 mV	GENCL -20 dBm

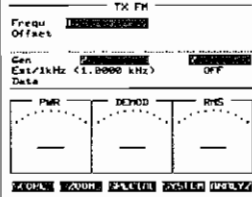
Key	IEEE command	Meaning
Fill in any entry fields		
Numeric block	WRTVA [code], [input]	<p>Enters declared entry [input] in field defined by [code]. Mask must have been called up first that contains required entry field.</p> <p>With the WRTVA command you can fill in all entry fields, also those that are directly accessible with commands like FREQU or AMPLI (fast access).</p>
<p>[code] = identification number of entry field [input] = numeric with/without units or text (depending on entry field).</p>		
 <p>The identification number is found as follows: first call up the mask and immediately afterwards the AUTORUN mask. (HELP V) shows the mask again. The entry fields are now brightened up and show the identification numbers required for the WRTVA command (see Quick Reference in Chapter 12, Appendix F).</p>		
<p>Examples</p>		
<p>WRTVA 1,27.250 MHz Value 27.250 MHz is entered in Freq field of basic TX mask (code = 1, see illustration).</p>		
<p>WRTVA 16,1234E Number 1234E is entered in Call Number field (code = 16) of selective-call test mask.</p>		

Actions on front panel

Key	IEEE command	Meaning
Connect RF sockets		
Selector key	RFSENS [socket]	Connect socket RX/TX, TX SENS or RX HIGH.
		TX mode DUPLEX RX mode
	[socket] = RXTX	RX/TX RX/TX RX/TX
	[socket] = rxHIGH	TX SENS TX+RX HIGH RX HIGH
	[socket] = txSENS	TX SENS TX SENS+RX RX HIGH
	[socket] = BOTH	TX SENS TX SENS+RX HIGH RX HIGH
	Example	RFSEN RXTX
Switch AF generators on/off		
GEN	GENA_[state]	Switch generator GEN on/off.
DATA	GENB_[state]	Switch generator DATA (option) on/off.
EXTMOD	GENC_[state]	Switch 1-kHz generator on/off.
EXTMOD	GENE_[state]	Connect and disconnect signal applied to EXT MOD socket.
	[state] = RX TX off	
	Examples	GENB_OFF GENA_RX
Select AF test signal		
VOLTM	VOLTMeter	Connects VOLTM input socket to AF signal analyzer.
DEMODO	DEMODulation	Connects demodulated received signal to AF signal analyzer.
RXMOD	MODulation	Connects all AF generators switched to RX to internal AF signal analyzer.
MODGEN	MODGEN	Connects all AF generators switched to TX to internal AF signal analyzer.
Call up AF test instruments		
dB REL	DBREL	Calls up relative-level meter.
VOLT	V_RMS	Calls up RMS meter.
SINAD	SINAD	Calls up SINAD meter.
DIST	DISTortion	Calls up distortion-factor meter.

Actions in menus

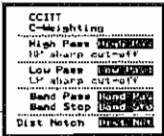
Key	IEEE command	Meaning
Open/close menu window		
MENU	MENU_ [name] MENU_	Opens menu. Closes menu.
	[name] = designation of required menu; appropriate mask must be called up before menu is opened (eg scope menu TRIGGER cannot be opened until scope mask is called up).	
	Example	20 SOFT_SCOPE 30 MENU_TRIGGER
Select/cancel menu items		
UNIT/SELECT	SELECT [item] CANCEL [item]	Crosses menu item. Clears cross in front of menu item.
	[item] = designation of required menu item	
	Examples	SELECT Auto Scope CANCEL CCITT
Fill in fields in menu items		
Numeric block	WRTVA [code], [input]	Makes required entry in field of menu item. Menu must be opened first.
	[code] = coded designation of required menu item [input] = numeric (incl. units) or one of settings offered for menu items that have submenu (eg RS232 Baud in PRINT menu),	
	<p style="text-align: center;">AUTORUN</p>  <p style="text-align: center;">F INH B INH MOD INH FILTER MASKS</p>	The coded designation is found as follows: first open the menu window and immediately afterwards call up the AUTORUN mask. The softkey (HELP V) opens the menu again. The coded designations (text or number) of those menu items with an entry field are now brightened up (see Quick Reference in Chapter 12, Appendix F).
	Examples	
	WRTVA High Pas, 345 Hz	Value 345 Hz is then entered under menu item High Pass (FILTER menu, code = High Pas).
	WRTVA 7, CR	CR is entered under menu item RS232 Baud (PRINT menu) in field of control character (code number = 7).

Key	IEEE command	Meaning
Compressed command		
<div style="border: 1px solid black; padding: 2px; display: inline-block; margin-bottom: 5px;">MENU</div>	MENU_[name],[action]	<p>Opens required menu, executes declared action (eg crossing) and closes menu. Compressed command can replace individual commands for this (see example). Individual commands are an advantage if <i>several</i> actions are to be executed in a menu (eg cross menu item and enter figure in field).</p> <p>[name] = designation of required menu [action] = one of actions SELECT, CANCEL or WRTVA</p> <p>Example: set IF bandwidth to 20 kHz.</p> <pre> 10 MENU_RF-PAR,WRTVA BW TXS,20 kHz 20 MENU_RF-PAR 30 WRTVA BW TXS,20 kHz 40 MENU_ </pre> <p>The compressed command (line 10) does exactly the same as the three single commands in lines 20 through 40.</p> <p>Example: set TTL outputs.</p> <pre> 10 MENU_RELAYS 20 SELECT TTL12..1 30 WRTVA 8,001100110011 40 MENU_ </pre> <p>Here in the RELAYS menu the TTL outputs are set by individual commands alone. In two actions, first the menu item is crossed (line 20) and then the required binary number (line 30) is entered in its field (code number = 8). The compressed command would be of no advantage here because it would automatically close the menu again after the first action.</p>

Test jobs

IEEE test jobs poll the required test instrument and at the same time produce the result. This can be evaluated directly (eg PRINT MPOWER) or assigned to a variable (A=MPOWER).

IEEE command	Measured result
RF frequency	
MTXFreq	<p>Frequency of RF signal applied to RX/TX socket (tuned frequency of test receiver). In RF-PAR menu, item Auto Frequ.Adj must not be crossed, in contrast to manual measurement of RF frequency.</p> <pre>10 SETTX 20 RFSENs RXTX 30 A=MTXFreq 40 PRINT A</pre> <p>After callup of the TX mask, the RX/TX socket is connected, the frequency of the RF signal applied there is measured and the result output.</p>
Frequency offset	
MTXOfset	<p>Offset of actual carrier frequency from tuned frequency of test receiver</p> <pre>10 SETTX 20 TXFRE 27.205 MHz; RFSENs RXTX 30 B=MTXOfset 40 PRINT B</pre> <p>Line 20 tunes the test receiver to 27.205 MHz and connects the RX/TX socket. Then the offset of the RF signal applied there is measured and the result output.</p>
RF power	
MPOWER	<p>Mean value of applied RF power. Before measurement, test receiver must be tuned to test signal.</p> <pre>10 SETTX 20 TXFRE 27.205 MHz 30 C=MPOWER 40 PRINT C</pre> <p>After the test receiver is tuned to the received signal, the measurement job determines the RF power in line 30.</p>

IEEE command	Measured result
Modulation	
MDEMOD	<p>Peak value of modulation, measured with modulation meters DEMOD (TX mode) or MOD (RX mode)</p> <pre> 10 SETTX;TXFRE 27.205 MHz;RFSEnS RXTX 20 MENU_MOD-PAR,SELEct FM 30 D=MDEMOD:PRINT D </pre> <p>First the test receiver is tuned and then FM demodulation is set. After that the peak FM deviation of the RF signal applied to the RX/TX socket is measured and output.</p> <pre> 10 SETRX 20 GENA_RX;MODAF 2 kHz;RXAFM 2.4 kHz 30 MODULation 30 D=MDEMOD:PRINT D </pre> <p>The generator GEN feeds the signal generator with a 2-kHz signal that produces FM deviation of 2.4 kHz. As a deviation check, line 30 connects the modulator to the modulation meter MOD, which is then polled and transfers the result to the variable D.</p>
FM deviation (weighted)	
MRMSDemod	<p>Peak FM deviation freed of superimposed interference (see Chapter 5, "Modulation Meter DEMOD"). Menu item Demod RMS Dev (AF-PAR menu) is crossed automatically. Before continuing measurement with RMS instrument, this cross must be cleared with CANCEL.</p> <pre> 10 SETTX;TXFRE 27.205 MHz;RFSEnS RXTX 20 GENA_TX;MODAF 1 kHz;GENAL 50 mV 30 DEMODulation 40 E=MRMSDemod:PRINT E 50 MENU_AF-PAR,CANCEL Demod RMS Dev 60 PRINT MVOLT </pre> <p>Line 10 tunes the test receiver and selects the RF socket. Line 20 generates the AF signal that feeds the microphone input of the test item. Line 30 connects the demodulated receive signal to the AF signal analyzer. The RMS instrument measures this signal and uses it to calculate the peak deviation, which is transferred to variable E (line 40). Line 50 causes the RMS instrument to resume its normal function in line 60 and measure the voltage of the demodulated receive signal.</p>

IEEE command	Measured result
Voltage (RMS)	
MVOLT	<p>Root-mean-square value of momentarily connected AF signal. Menu item RMS eff (AF-PAR menu) only has to be crossed explicitly if VOLTM socket is connected and AF power measurement or DC voltage measurement was performed beforehand.</p> <pre> 10 SETRX;MODULation 20 GENA_RX;MODAF 2 kHz;RXAFM 2.4 kHz 30 REM MENU_AF-PAR, SELECT RMS eff 40 F=MVOLT:PRINT F </pre> <p>Line 10 calls up the RX mask and connects the AF generators to the AF signal analyzer. Generator GEN feeds the signal generator with an AF signal that produces 2.4 kHz FM deviation. The level of the AF signal is determined by the test job in line 40. If an AF power measurement had been performed beforehand (see MAFFPower), line 30 (without BASIC command REM) would first have to call up the RMS instrument.</p>
Distortion factor	
MDIST	<p>Distortion factor of momentarily connected AF signal</p> <pre> 10 SETTX;TXFRE 27.205 MHz 20 DEMODulation 30 GENA_TX;MODAF 1 kHz;GENAL 10 mV 40 G=MDIST:PRINT G </pre> <p>Here the distortion factor of a demodulated receive signal is measured (line 30 causes the microphone input of the test item to be fed with a defined AF signal).</p>
SINAD	
MSINAd	<p>SINAD value of AF signal applied to VOLTM socket</p> <pre> 10 SETRX;AMPLI -60 dBm;RXFRE 27.205 MHz 20 MODAF 1 kHz;RXAFM 2.4 kHz 30 VOLTM 40 H=MSINAd:PRINT H </pre> <p>Line 10 sets the RF parameters of the signal generator, line 20 defines the modulation parameters. The AF output signal of the test item is applied to the VOLTM socket. For this reason this socket must be connected to the AF signal analyzer (line 30) before the SINAD measurement (line 40).</p>

IEEE command	Measured result
Relative level	
MDBREL	<p>Voltage level referred to AF voltage that is present when dB-REL instrument is called up. Note: to make sure that dB-REL instrument adopts reference level 0 dB, test job MDBREL must be issued after calling up instrument.</p> <pre> 10 SETRX;AMPLI -60 dBm;RXFRE 27.205 MHz 20 MODAF 1 kHz;RXAFM 2.4 kHz 30 VOLTM 40 DBREL 50 MDBREL 60 AMPLI -65 dBm 70 I=MDBREL:PRINT I </pre> <p>First the program sets the RF and modulation parameters for the signal generator. Then the VOLTM socket is connected because this is where the AF output signal of the test item is applied. Line 40 calls up the dB-REL instrument. In contrast to manual measurement, the voltage level on the VOLTM socket now has to be fixed as the reference value 0 dB with a test job (line 50). Line 60 reduces the RF level of the signal generator to -65 dBm. The relative effect of this level reduction on the AF output signal of the test item is measured by line 70.</p>
AF power	
MAFPower	<p>AF power of AF signal applied to VOLTM socket. Measurement is made automatically with dBm units ($R_L = 600 \Omega$) if menu item mW/W (AF-PAR menu) is not crossed at time of test job.</p> <pre> 10 SETTX 20 GENA_TX;GENAL 3 V 30 VOLTM 40 REM MENU_AF-PAR,SELEct mW/W 50 REM MENU_AF-PAR,WRTVA mW/W,200 Ohm 60 J=MAFPower:PRINT J </pre> <p>In the TX mask generator GEN is set to 3 V output voltage and then the VOLTM input socket is connected, which is linked to the generator output socket MODGEN by a BNC cable. Line 60 measures the AF power, initially with dBm units. If the BASIC commands REM are removed in lines 40 and 50, line 60 measures the AF power in mW/W, referred to a 200-Ω load resistance.</p>

Special commands

IEEE command	Meaning
Insert message on display	
DISP_[text]	<p>Stops program execution and shows text [text] on display (see BASIC command PAUSE). Strike (CONTINUE) softkey to continue program.</p> <p>[text] = maximum 60 characters (7-bit ASCII character set, no special national characters)</p> <pre>10 SETTX;RFSENS RXTX 20 DISP_Connect antenna to RX/TX socket 30 TXFREQ 27.205 MHz;A=MPOWER:PRINT A</pre> <p>To enable measurement of RF power, the program tells the user to connect the antenna socket of the mobile to the RX/TX socket of STABLOCK 4015.</p>
LOCAL:[text]	<p>Stops program execution and shows current mask as if it had been called up manually (test Instruments are active). Only exception: text [text] is displayed in line of softkeys (see BASIC command KEY). Strike any softkey to continue program.</p> <p>[text] = maximum 35 characters (7-Bit ASCII character set, no special national characters)</p> <pre>10 SETTX;TXFREQ 27.205 MHz 20 SOFT_ANALYZ;SOFT_MARKER 30 LOCAL:Check Spectrum of RF Signal 40 SETTX</pre> <p>The program tunes the test receiver, calls up the spectrum analyzer and sets the marker. The text in the softkey line tells the user to observe the spectrum of the applied RF signal. Striking any softkey returns you to the TX mask and continues the program.</p>
Read out current display	
HARDCopy	<p>Reads out current contents of display in graphics format of declared printer (see Chapter 4, PRINT menu).</p> <pre>10 SETTX;TXFREQ 27.205 MHz;RFSENS RXTX 20 HARDC 30 A=MPOWER:PRINT A</pre> <p>After tuning the test receiver, the program reads out the data of the TX mask on the interface declared in the PRINT menu (eg to a printer or controller). Then the RF power is determined by a measurement job and this result is also read out.</p>

IEEE command	Meaning
Poll installed options	
OPTION	<p>Reports, in coded form, what options are installed. PRINT OPTION produces 4-digit number whose individual places mean as follows (variable assignment is also permissible, eg A=OPTION):</p> <p>1st place: DUPLEX synthesizer 1 = installed 0 = not installed</p> <p>2nd place: DTMF module 1 = installed 0 = not installed</p> <p>3rd place: DATA module 1 = installed 0 = not installed</p> <p>4th place: Interfaces 0 = no interface installed 1 = reserved 2 = Centronics/RS232/keyboard installed 3 = IEEE bus/RS232/keyboard installed</p> <p>Example: PRINT OPTION produces a result of 1102. This means that the DUPLEX synthesizer, the DTMF module as well as the Centronics/RS232/keyboard interface are installed.</p>
Poll version status of modules	
HARDWARE	<p>Reports, with 22-character string, version status of individual STABILOCK 4015 modules (two places each). Sequence corresponds to that of HW REV menu (see Chapter 4), ie first two digits are version status of Computer module. Immediately after polling, string variable M\$ contains string so that it can also be further processed (eg polling of specific module by isolating relevant part of string).</p> <p>Example: PRINT HARDW produces following string: 010001000001000000---- B\$=M\$(3,4) isolates status of Mod.Gen module.</p>
Poll "Internal Battery" option	
BATTERY	<p>Shows whether internal battery (option) is installed, whether it is being charged and what its voltage is. PRINT BATTERY produces result 0 if battery is not installed. If battery is installed, code digit is first output and then voltage with two places before decimal point and one place after. After polling, the string variable M\$ contains the result so that it can also be further processed.</p> <p>Code digit = 1 = battery is being charged. Code digit = 2 = battery is not being charged.</p> <p>Example: PRINT BATTERY produces result 212.3 V, where the first 2 is the code digit and 12.3 V the voltage reading.</p>

Calibrate**M_CAL**

Permits polling, during execution of program, whether Communication Monitor is to be newly calibrated because of change in internal temperature ($\Delta\theta > 6^\circ\text{C}$, see Chapter 1, "Calibration"). Evaluation either direct with `PRINT M_CAL` or through further processing of polled result.

0 = calibration not necessary
1 = calibration necessary

Example

```
10 SETRX
20 IF M_CAL=1 THEN GOSUB 100
30 END
100 MENU_CALBRT
110 LOCAL:          OK!
120 SELECT Start Calibr
130 RETURN
```

If the program finds that calibration is necessary (line 20), the CALBRT menu is opened. Line 110 stops program execution so that you can read the notes in the menu window. Strike any softkey to start the calibration process.

Poll serial number**SERNR**

Reports serial number of STABLOCK 4015. Number can be read out directly with `PRINT` or evaluated by further processing of string variable `M$`.

Example: `PRINT SERNR` or `PRINT M$` produces display 0389058.

(

(

(

(

Software Options

(

(

(

(

Introduction



Chapter 10 is reserved for the descriptions of the software options. When you order a software option, the appropriate instructions are supplied with it. Insert these instructions in this chapter.

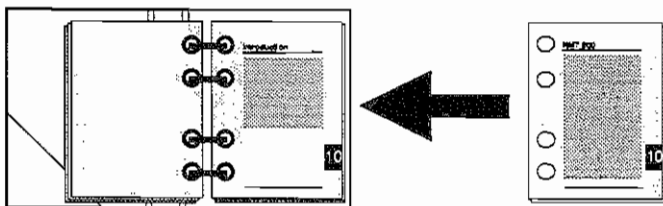

In the list of contents you will find all the available software options under Chapter 10. Cross the appropriate field if you add a description to the operating instructions.

Loading and Starting System Programs

Before you can work with the system program of a software option, you have to load the system program from the memory card into the main memory (RAM) of the Communication Monitor. Only one system program can be stored in RAM at a time (see Chapter 8, "MEMORY Mask"); it remains there until you delete it, load another system program or execute a total reset. When you switch the Communication Monitor off, or if there is a power outage, the system program in RAM is preserved.

System programs can be loaded directly or indirectly. The indirect way is via the MEMORY mask and is therefore explained in Chapter 8, "Loading System Program". For the faster, direct way the steps are as follows:

Load and automatically start system program from memory card	Start system program already loaded
1. Insert memory card in slot.	1. Call up any basic mask and strike (SYSTEM) softkey.
2. Call up any basic mask and strike (SYSTEM) softkey. Communication Monitor starts to load program (message LOADING PROGRAM on display).	2. If no other system tester was worked with before (eg selective-call tester), display immediately shows mask of system program.
3. Once program is loaded, display immediately shows mask of system program.	3. If display does not show required mask, open SYSTEM menu and cross bottom menu item (loaded system program).

System programs automatically put STABLOCK 4015 into the required operating mode. So a program that needs the DUPLEX Synthesizer can be loaded from the basic RX mask for example. Switching to DUPLEX occurs automatically as soon as the display shows the mask of the system program.

System programs access the NoL/U menu and automatically match the values entered there to the requirements. So, before manual tests, you should always check that the entries in this menu are still correct.

Errors in loading

If an error is detected during loading (eg wrong checksum, missing hardware option), the loading operation is aborted. Two signal tones draw your attention to this. Then the system tester crossed in the **SYSTEM** menu is called up. With **(HELP)** you can open an information window to find out about the cause.

Resetting write protection

While you are working with a system program, the memory card should be left in the slot of STABLOCK 4015 and its write protection should be *off* (Fig.). Then any alterations to test parameters that you make will also be saved on the memory card automatically and do not have to be entered again when you reload the system program. If the write protection is effective or there is no memory card in the slot of the Communication Monitor, no parameters can be saved of course.

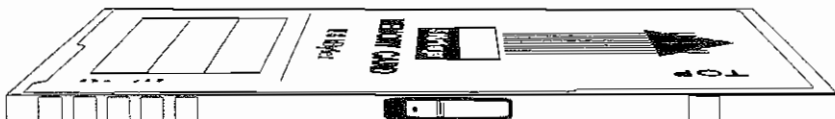

In this switch setting, write protection is off

(

(

(

(

YES

STABILOCK 4015

Software Option 897 933

**Tracking
and
Cable Fault Finder**

Operating Instructions

Doc. Version: 9210-200-A

(

(

(

(

Contents

Contents	10-3
What you need	10-5
Tracking or Cable Fault Finder (CFF)	10-5
Tracking	10-6
Test principle	10-6
Connecting twoport	10-7
Basic settings	10-8
Conducting test	10-13
Evaluating test	10-14
Cable Fault Finder (CFF)	10-15
Requirements	10-15
Connecting cable to be tested	10-15
Basic settings	10-16
Conducting test	10-18
Test example	10-20
Technical data	10-21
Speed Summary	10-22

This page is intentionally left blank.

(

(

(

(

What you need

- The system program requires a firmware version ≥ 1.20 .
- STABLOCK 4015 must be fitted with the "DUPLEX Synthesizer" hardware option.

Tracking or Cable Fault Finder (CFF)

Tracking shows the frequency response of passive and active twoports in graphic form. The CFF traces defects in cables.

To call up Tracking ⇨ Call up the system program.
⇨ Cross Tracking in the MODE menu (default setting).

To call up CFF ⇨ Call up the system program.
⇨ Cross the Cable Fault Finder scroll variable in the MODE menu.

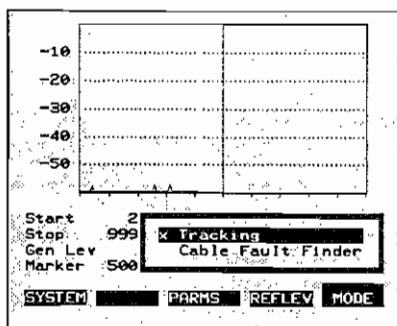

Fig 10.1: In the MODE menu you can choose between frequency-response measurement of twoports and the Cable Fault Finder

Tracking

Test principle

Tracking shows the frequency response of passive and active twoports in graphic form. The frequency band in which the twoport is measured is defined by the start and stop frequency (signal generator). Depending on the resolution you select, the test will be made at 250, 125 or 63 frequency reference points (Fig. 10.2).

After you start the test, the following operations are performed at each of the frequency reference points:

- 1) Signal generator is tuned to frequency reference point.
- 2) Test receiver is tuned to receive frequency (the receive frequency can differ from the transmit frequency by a definable offset).
- 3) Level is measured.
- 4) Result of level measurement is entered in screen window.

Once the test has been performed at all frequency reference points, you can read off the limit frequencies of the twoport, for example, or output the test curve to a printer.

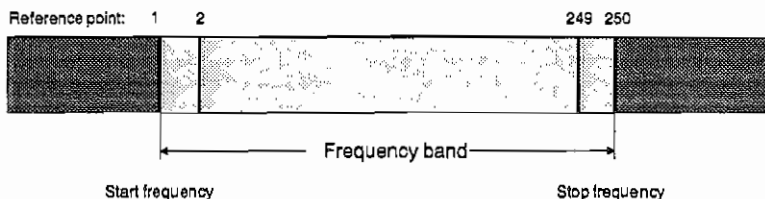

Fig. 10.2: Frequency reference points divide frequency band into equal intervals

Connecting twoport

When you connect the twoport, apart from the required output and input power (see Appendix A, "Technical data"), the following combinations of output and input sockets are possible:

Output socket	Input socket	
	TX SENS	RX/TX
RX/HIGH	x	x
RX/TX	x	

Test setup

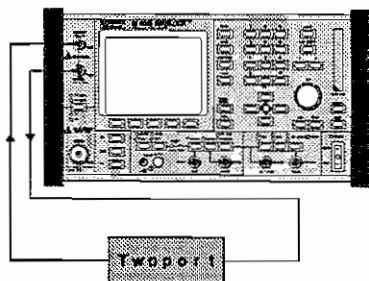

Fig. 10.3: RX/TX selected as output socket and TX SENS as input socket

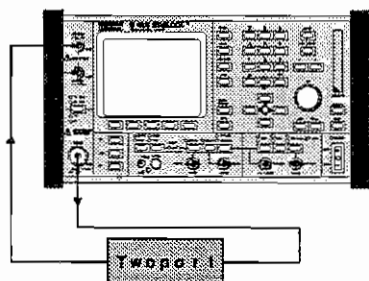

Fig. 10.4: RX HIGH selected as output socket and RX/TX as input socket

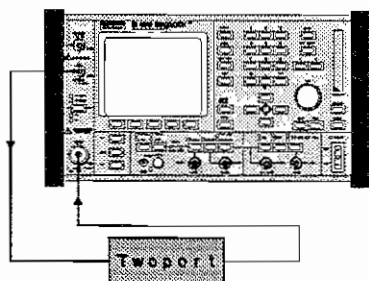

Fig. 10.5: RX HIGH selected as output socket and TX SENS as input socket

Basic settings

Setting frequency band

Entry of the start frequency in the **Start** field and of the stop frequency in the **Stop** field defines the frequency band in which the connected twoport is to be tested (Fig. 10.6).

Entering RF output level

Move the cursor to the **Gen Lev** field and enter the level with the numeric keys. Confirm your entry with **ENTER** (Fig. 10.6).

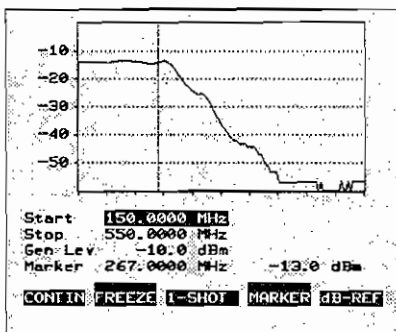

Fig. 10.6: Frequency band and RF output level are defined in the test mask

Setting frequency offset

When you test frequency-converting twoports, eg mixers, the receive frequency differs from the transmit frequency. You enter this frequency offset as follows:

- ⇒ Open PARMs menu with **MENU** + **PARMS** (Fig. 10.7).
- ⇒ Enter offset in **Frequ. Offset** field.
- ⇒ Cross **TX = RX-Offset** or **TX = RX+Offset** to show whether offset is to be subtracted from transmit frequency or added to it.

The display range of the frequency axis is matched to the offset. After subtraction or addition of the offset, the receive frequency must still be in range (see Appendix A, "Technical data").

Example:

Start frequency = 10 MHz
Stop frequency = 100 MHz
Offset = 10 MHz
TX = RX + Offset

After you start the test, the signal generator is tuned to discrete values from 10 to 100 MHz and the test receiver from 20 to 110 MHz. The test curve is shown in the screen window from 20 to 110 MHz.

Selecting resolution and speed

In the PARMs menu you choose the speed or resolution (number of frequency reference points) per test cycle (Fig. 10.7). There are three different speeds or resolutions:

Speed	Resolution (number of frequency points)	Duration of test cycle
Slow	250	approx. 8 s
Std.	125	approx. 4 s
Fast	63	approx. 2 s

The test curve is always displayed with 250 reference points. So, for Std. and Fast speeds, the levels between two points are calculated from the adjacent points.

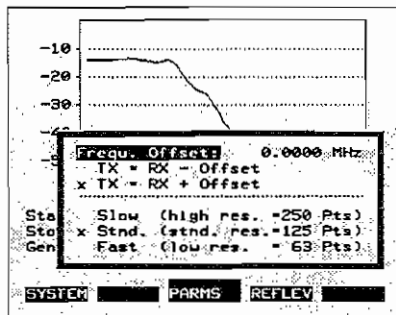

Fig. 10.7: In the PARMs menu you choose the speed or resolution per test cycle

Selecting display range

In the REFLEV menu you can cross to alter the display range of the test curve. Depending on the input socket that is coupled, you have a choice of the following display ranges:

Input socket	Menu item	Display range
RX/TX	+50.0 dBm	+50 to -10 dBm
	+30.0 dBm	+30 to -30 dBm
TX SENS	0.0 dBm	0 to -60 dBm
	-30.0 dBm	-30 to -90 dBm

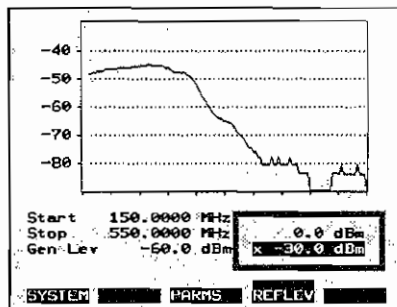

Fig. 10.8: REFLEV menu, input socket is TX SENS

Inserting marker

(MARKER) inserts a marker (vertical line) in the screen window. The frequency and the RF level of the received signal at the position of the marker appear in the Marker field. Strike the softkey again to turn the marker off.

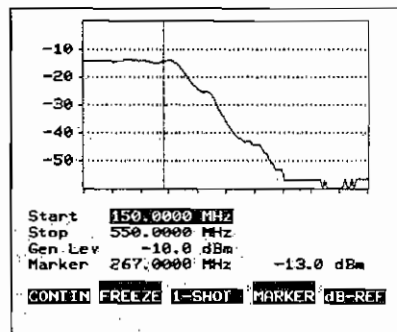

Fig. 10.9: Test mask with marker function activated

Performing reference measurement

A reference measurement is important if the attenuation of the connecting leads to the twoport is to be left out of the measurement. Procedure:

- ⇒ Bypass twoport (Fig. 10.10).
- ⇒ Start reference measurement with **dB-REF** (halt with **STOP**).
- ⇒ Replace bridge by twoport and record test curve.

The **dB-REF** softkey is displayed heightened to show that reference values are entered into the measurement. The attenuation of the connecting leads is allowed for until one of the following parameters is altered: frequency band, frequency offset, transmit level, display range of receive level, resolution or input/ output socket. After one of these parameters has been altered, the reference measurement has to be repeated.

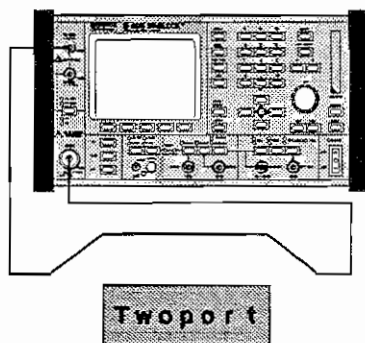

Fig. 10.10: During reference measurement, bypass is connected instead of twoport

Conducting test

Conducting continuous test

Start the test with **(CONTIN)**. To show that a continuous test is set, the softkey is displayed heightened. Test curves are now measured and displayed continuously. With **(FREEZE)** you can interrupt the continuous test and freeze the momentary test curve.

Conducting one-shot test

Start the test with **(1-SHOT)**. Halt the test with **(STOP)**. After a test cycle the display of the curve is frozen and the **(FREEZE)** softkey is displayed heightened.

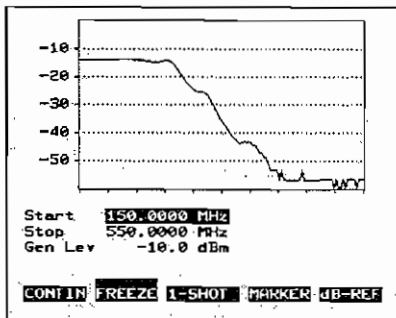

Fig. 10.11: Frozen curve of lowpass filter

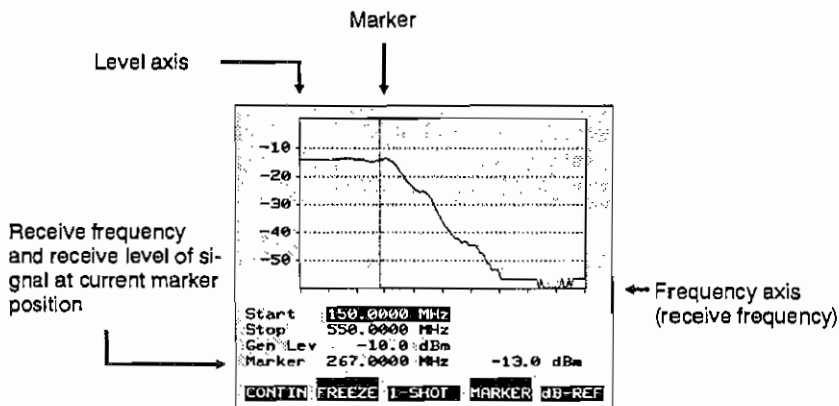

Fig. 10.12: Test mask with curve of lowpass filter

Basic settings:

Start frequency = 150 MHz
 Stop frequency = 550 MHz
 Transmit level = -10 dBm
 Frequency offset = 0
 Connected sockets: RX HIGH and TX SENS

The level axis is divided into 10-dB increments in the display. The division of the frequency axis is calculated from the start frequency (f_{start}) and the stop frequency (f_{stop}) as

$$\text{Frequency/division} = (f_{\text{stop}} - f_{\text{start}})/10$$

In the example this produces a frequency axis of 40 MHz/division.

Evaluation:

The test curve shows the response of a lowpass filter with a 3-dB cutoff frequency at 270 MHz.



Measurement is only made at the frequency reference points. If the frequency response of the twoport alters between two points, this is not shown. Example: bandpass filter with a passband very much smaller than the interval between two frequency reference points.

Cable Fault Finder (CFF)

With the CFF you can locate faults in cables to within 0.1 m.

Requirements

- Z/3 star or T adapter
- Type of cable known or velocity factor or dielectric constant known or at least 1 m of faultless cable of the type tested.

Connecting cable to be tested

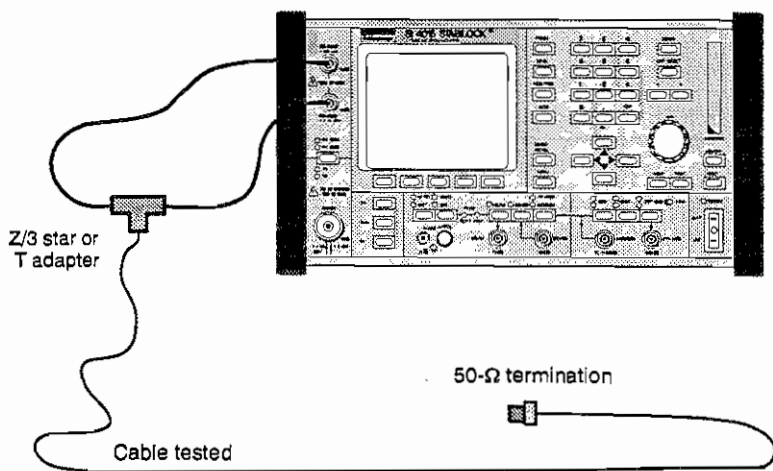

Fig 10-13: Connect the cable to be tested with a Z/3 star to the TX SENS and RX HIGH sockets. Instead of the Z/3 star it also possible to use a T adapter. But then line errors generate reflections at integral multiples of their distance from the T adapter.

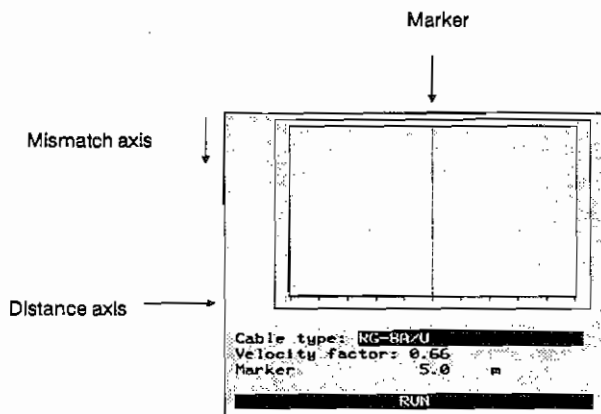

Fig 10.14: Test mask

Setting length of cable tested

Cross the maximum length of the cable tested in the PARMs menu (Bild 15). This automatically defines the display range of the distance axis. The real length of the cable tested must not be more than the length crossed, otherwise there may be measuring errors.

Defining unit of length

Cross either *Meter* or *Feet* in the PARMs menu. Depending on your choice, the units for the maximum length of the cable tested and the units for the distance axis are then meters or feet.

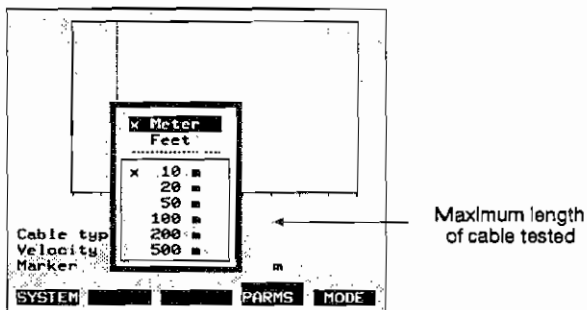

Fig 10.15: In the PARMs menu you define the units for the distance axis and for the maximum length of the cable tested. You also cross the maximum length of the tested cable

Selecting type of cable

The scroll variable in the `Cable type` field selects the type of cable tested. When a type is selected, its velocity factor is automatically entered in the `Velocity factor` field.

If the type of cable tested is unknown or not contained in the list, you can enter the velocity factor yourself with the `User defined` scroll variable or determine it with the `Reference cable` scroll variable (see "Conducting test").

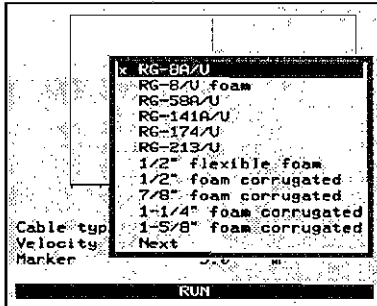

Fig 10.16: The scroll variables of the `Cable type` field produce the velocity factors of the major types of cable

Conducting test

Open Cable type scroll field with **UNIT/SELECT**.

Type of cable tested listed in Cable type scroll field?

yes

Cross type of cable.

Cross maximum length of cable tested in PARMS menu.¹⁾

Connect cable to be tested.

Start measurement with **RUN** (**STOP** halts measurement).

Evaluate measurement.

no

Velocity factor or dielectric constant known?

yes

Cross User defined.

Cross maximum length of cable tested in PARMS menu.¹⁾

Connect cable to be tested.

Enter velocity factor in Velocity factor field.

Dielectric constant → velocity factor conversion:

$$V_r = \frac{1}{\sqrt{\epsilon_r}}$$

V_r = velocity factor
 ϵ_r = dielectric constant

Start measurement with **RUN** (**STOP** halts measurement).

Evaluate measurement.

no

Cross Reference cable.

Enter length of reference line in Cable length field (min. 1 m, max. 9.9 m).

Cross maximum length of cable tested in PARMS menu.¹⁾

Start measurement with **RUN**.

After message Connect Reference Cable connect reference line. Operate reference line open-circuit. Confirm connection with **CONTINUE**.²⁾

After message Connect Cable to Test connect cable to be tested. Confirm connection with **CONTINUE**.

Evaluate measurement.

- 1) After the reference measurement the velocity factor of the reference line is automatically entered in the `Velocity factor` field and the `User defined scroll variable` in the `Cable type` field. Thus the reference measurement is only required once.
- 2) The real length of the cable tested must not be greater than the maximum length crossed in the `PARMS` menu, otherwise the measured results may be corrupted.

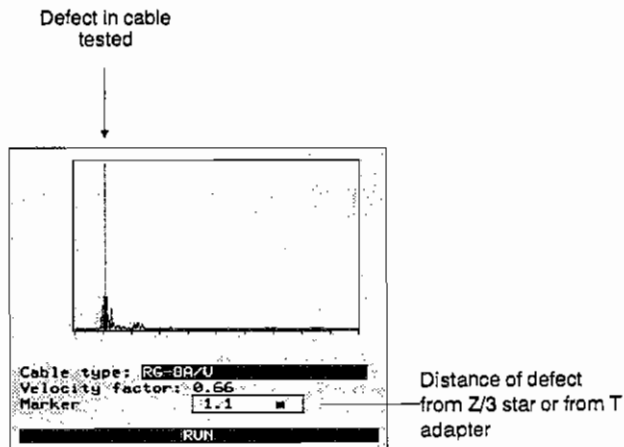

Fig 10.17: Test mask after measuring defective cable

Basic settings

Type of cable tested = RG-8A/U (velocity factor 0.66)
Real length of cable tested = 2.6 m
Maximum length set in PARMs menu = 10 m

Evaluation

Use the spinwheel to position the marker on the point with the largest mismatch. The Marker field shows the distance of the defect from the Z/3 star.

The scale of the mismatch axis is logarithmic. The display of the scale on this axis is not calibrated.

If a T adapter is used instead of the Z/3 star, reflections of the actual defect will appear at integral multiples of the distance from the T adapter. Further defects in the cable may be concealed by these.

Technical data

Tracking

Transmit frequency:	2.0000 to 999.9999 MHz
Receive frequency:	2.0000 to 999.9999 MHz
Frequency offset:	0 to 997.9748 MHz
RF output level:	
RX/TX	-129.9 to -60.0 dBm (in 0.1-dBm increments)
RX HIGH	-69.9 to +13.0 dBm (in 0.1-dBm increments)
Max. receive level:	
RX/TX	+30 or +50 dBm
TX SENS	0 or -30 dBm
Dynamic range:	60 dB
Resolution:	
Horizontal	250 pixels for 250, 125 or 63 frequency reference points
Vertical	150 pixels, 0.4 dB per pixel

Cable Fault Finder

Length of cable tested:	1 to 300 m 30 to 900 ft
Length of reference line:	1 to 9.9 m
Velocity factor:	0.5 to 1
Frequency range:	2.0000 to 999.9999 MHz
Transmitted level:	-10 dBm
Resolution:	max. 0.1 m
Test duration:	approx. 30 s

Speed Summary

Tracking

Entry fields

Start	Start frequency
Stop	Stop frequency
Gen Lev	RF output level of signal generator

Display field:

Marker	Frequency and level of RF receive signal at location of marker. Display field is only visible when marker function is active.
--------	---

Softkeys

(CONTIN)	Curve is continuously updated.
(FREEZE)	Curve last visible on screen is frozen. Start new measurement with (CONTIN) or (1-SHOT).
(1-SHOT)	Measurement is performed once and curve frozen.
(MARKER)	Inserts marker (vertical line) in screen window. Current frequency and related RF receive level appear in Marker display field. Location of test line on frequency axis can be altered with spinwheel. Strike softkey again to cancel marker function.
(dB-REF)	Compensates for attenuation of connecting leads.

PARMS menu

Frequ. Offset	Offset of receive frequency from transmit frequency
TX = RX - Offset	Receive frequency < transmit frequency
TX = RX + Offset	Receive frequency > transmit frequency
Slow	Low speed, high resolution (250 frequency reference points)
Std.	Medium speed, medium resolution (125 frequency reference points)
Fast	High speed, low resolution (63 frequency reference points)

REFLEV.menu

0.0 dBm -30.0 dBm	Set display range for receive level. Input socket TX SENS and output socket RX/TX or RX HIGH are coupled.
+50.0 dBm +30.0 dBm	Set display range for receive level. Input socket TX/RX and output socket RX HIGH are coupled.

Cable Fault Finder

Entry fields	
Cable type	Type of cable tested
Cable length	Length of reference line
Velocity factor	Is either entered automatically upon selection of type of cable tested or must be entered with User defined scroll variable.
Display field	
Marker	Distance of marked defect from Z/3 star or from T adapter
Softkeys	
(RUN)	Starts test.
(STOP)	Halts test.
PARMS menu	
Meter Feet	Length of cable and display in meters/feet
10-500 m 30-1500 ft	Maximum length of cable tested

Remote Control

(

(

(

(

The IEEE-488 Bus

Up to the mid-1960s remotely controllable test equipment featured special-to-company interfaces for external control of its operation. If you wanted to create a test system out of units from different producers, you first had to overcome the incompatibility of these interfaces by using extra interface circuits.

History

In 1965 Hewlett-Packard presented the HP-IB (Hewlett-Packard interface bus) as a company standard. Within a very short time this interface had been accepted worldwide. Ten years later it became an industry standard, the IEEE 488. IEEE 488 defines the electrical, mechanical and functional characteristics of a "bus system". Units fitted with such an interface can be connected to one another directly and be remotely controlled. The IEEE-488 standard is known under different names, like HP-IB or GPIB (general-purpose interface bus). In Europe the interface is standardized as IEC 625, with a slight difference in the definition of the subminiature D connector: IEEE 488 prescribes a 24-way and IEC 625 a 25-way connector. The interface of STABLOCK 4015 is based on the IEEE-488 standard and consequently has a 24-way connector.

REMOTE

As soon as STABLOCK 4015 is remotely controlled on the IEEE-488 bus, the "REMOTE" LED on its front panel lights up. The keys of the Communication Monitor are then disabled. Exceptions: **OFF** switches to manual operation, **RESET** resets the microcomputer of STABLOCK 4015.

Bus structure

The IEEE-488 bus consists of eight data lines (data bus), three control lines for data exchange (handshake bus) and five superordinate control lines (control bus).

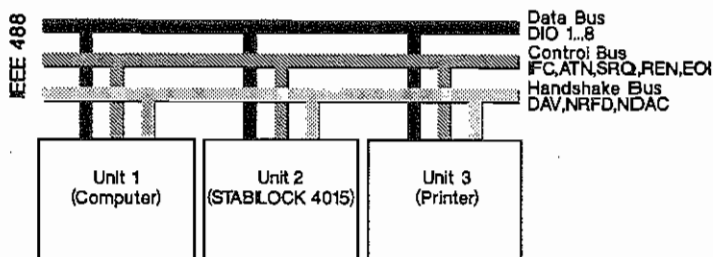

Fig. 11.1:
Structure of
IEEE-488
bus

Units fitted with an IEEE-488 interface always belong to one of the following groups:

Listener: These are units that only "listen", ie only receive data. Typical members of this group are printers, like the ink-jet printer offered as an accessory for STABLOCK 4015.

Talker: These units only "talk" (eg frequency counters or clocks) and have now become fairly rare.

Talker & Listener: These are units that can talk and listen, ie send and receive data. STABLOCK 4015 belongs to this group. The received data are measurement jobs, for example, and the sent data can be the measured results.

Controller: Units that can talk, listen and control are called controllers. In most cases they are computers specially designed for this purpose. Of late more and more personal computers (PCs) with a built-in IEEE interface card are being used. A controller regulates the entire measurement procedure, sending measurement jobs, receiving the measured results, calculating values, keeping statistics and lots more besides.

The exchange of data on the eight data lines of the IEEE bus is usually performed with ASCII-coded characters (ASCII: American standard code for information interchange). Proper data exchange between talkers and listeners is managed by the handshake bus with its three control lines. This ensures correct transfer of every character (data byte) and quite independently of the processing speed of the units connected to a bus: the slowest device that is involved in the *momentary* data exchange determines the rate of data transfer.

Basically the handshake data exchange works as follows. A talker sends a data byte and signals by the **DAV** (data valid) line that there is a data byte ready for collection on the data bus. As soon as a listener has collected the data byte, it signals reception of the character and its readiness to receive further characters by the **NDAC** (not data accepted) line and the **NRF** (not ready for data) line. The procedure is the same when a data byte is intended for several listeners.

The data transmitted on the bus fall into two categories:

- Management messages: these decide, before data exchange for example, which unit is the talker and which unit or units the listener. The resetting of a unit can also be ordered by a management message.
- Device-dependent messages: these include setting commands for individual units for instance, measurement jobs and measured results.

Creating IEEE-488 system

To integrate STABILOCK 4015 into an existing IEEE-488 system, all you need is the hardware option "Interface IEEE-488/RS-232/Keyboard" and an IEEE cable. Two configurations come into mind for a minimal system:

- STABILOCK 4015 and IEEE controller,
- STABILOCK 4015 and IEEE printer.

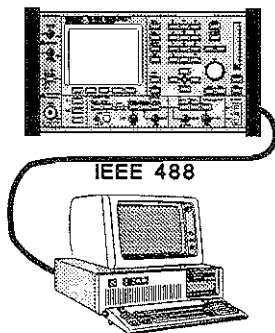

Fig. 11.2: IEEE-488 system consisting of STABILOCK 4015 and controller

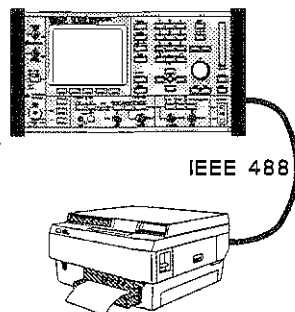

Fig. 11.3: IEEE-488 system consisting of STABILOCK 4015 and printer

What settings are necessary ?

An IEEE-488 system requires harmonization of the following parameters for all units integrated into a system. With STABILOCK 4015 all these parameters can be set in the `PRINT` menu (see Chapter 4).

Address: Just like a specific subscriber can be reached by his telephone number, an IEEE-488 device must also be uniquely identifiable. This is done by means of addresses. STABILOCK 4015 is set to a standard address of 27, but it can be set to any other address between 1 and 31 in the `PRINT` menu.

End of string (EOS): One or two control characters, added by a talker to the end of each message, tell a listener that this is the end of the message. But this will only work if the same control characters are set on the talker and listener. In the course of time the following control characters have become customary for this

purpose: CR (carriage return) and LF (line feed). These control characters are normally used in the combination CR or CR+LF.

End or Identify (EOI): EOI is one of the five superordinate control lines. This line is set by a talker simultaneously to the transmission of the last character of a message. EOI permits the transfer of messages if there are EOS characters contained in the message itself. If STABLOCK 4015 outputs the contents of a display (mask) for instance, these will be binary data which, depending on the display contents, can comprise all possible 255 bit combinations from 00_h to FF_h. If the combinations for CR (0D_h) and LF (0A_h) are also among them, they could be mistaken for genuine EOS characters. But by scanning the EOI line, the listener avoids this error.

Talk & listen: This is the device mode. The "talk & listen" setting should always be chosen if there is a controller in the IEEE-488 system. The "talk only" setting is necessary if there is only a printer connected to STABLOCK 4015. The printer will then be set for "listen always".

When IEEE and when AUTORUN ?

Remote control by IEEE-488 bus is always necessary if more than one device is required for automatically testing an item. AUTORUN (see Chapter 9) also loses out if you want to collect test statistics or a number of test setups want to access a shared database. An example of this would be the alignment of radios at different temperatures (climatic chamber) and on different supply voltages (power-supply unit) with simultaneous measurement of their quality (database). AUTORUN is an advantage if the testing capabilities and possibilities offered by STABLOCK 4015 for further processing of measured data are quite sufficient for your test application. It is the ideal way to handle tests that keep recurring.

How to create an IEEE program

The commands that produce the required running of an IEEE program differ from controller to controller. A controller can initiate output to the data bus with the command WRT or with OUTPUT or with IBWRT. The command for collecting data can be RED or ENTER or IBRD. You can find precise details about this type of command in the manual to your controller.

The IEEE commands for remotely controlling STABLOCK 4015 are quite independent of the controller that is used. These commands – they were devised by SCHLUMBERGER – can be divided into two groups:

Notation

Each IEEE command for remote control consists of at least five characters, further characters may be added but are not evaluated. This possibility of adding characters makes the commands more intelligible, is useful for program documentation and simplifies program housekeeping. The same applies to blanks: they can be inserted but are unnecessary for correct execution of a command. Upper-case or lower-case notation is also optional.

Setting commands: These put STABLOCK 4015 into the operating status required for a particular test.

Test jobs: These tell STABLOCK 4015 to perform a certain test. Test jobs usually produce measured results. In other words, after issuing a test job the controller must first collect the result before it can issue further commands.



Virtually all IEEE remote-control commands are also permissible for AUTORUN programs; this is why Chapter 9 describes the IEEE commands that may be used in AUTORUN programs *and* in IEEE programs. At the end of this chapter you will find a list of the few IEEE commands that you can only use in IEEE programs.

The syntax and performance of IEEE remote-control commands are based on the following needs:

- Use of the terms common in RF test engineering.
- Relationship between manual operation and IEEE programming.
- Commands to enable extension and matching to future demands.

Programming examples

```
Set TX frequency:      OUTPUT 727,"TXFREquency 123.456 MHZ"  
Set RF level:         OUTPUT 727,"AMPLItude -78.9 DBM"  
Call up TX mode:     OUTPUT 727,"SETTX"
```

The above examples apply to controllers from Hewlett-Packard: OUTPUT produces an output, 7xx says that output is on the IEEE interface and 27 is the IEEE address of the recipient of the output (in this case STABILOCK 4015).

Here is the same example, but written for a PC with an IEEE card from National Instruments:

```
TEXT$ = "TXFREquency 123.456 MHZ" CALL IBWRT (STABI%,TEXT$)  
TEXT$ = "AMPLItude -78.9 DBM" CALL IBWRT (STABI%,TEXT$)  
TEXT$ = "SETTX" CALL IBWRT (STABI%,TEXT$)
```

Here STABI% is the device identification including its address.

A number of commands can be comprised into a command string using the character ";" (reduces programming effort):

- **Single commands**

```
OUTPUT 727,"SETRX"  
OUTPUT 727,"RXFRE 123.4567 MHZ"  
OUTPUT 727,"AMPLI -80.0DBM"
```

- **Command string**

```
OUTPUT 727,"SETRX;RXFRE 123.4567 MHZ;AMPLI -80.0 DBM"
```

Tips & tricks

- A command string may only contain *one* measurement job. This measurement job must come at the end of the command string, otherwise the following commands will be ignored.
- The execution of a command starts straight after receipt of the end character EOS or, for a command string, after the semicolon. Depending on the command, more or less time will be required for its complete execution. Incorrect measurements can result if a device has not yet executed a setting command completely and another device already produces a measured result that is dependent on this setting. Errors of this kind are avoided by terminating setting commands with a semicolon. This causes command execution to be brought forward. After execution the EOS character(s) is(are) read and only then is the bus enabled.

Example: The following program is continued immediately after arrival of the setting command for STABLOCK 4015 in case a). The subsequent frequency measurement can therefore produce an incorrect value. In case b) however the measurement is not performed until the Communication Monitor has set the required frequency correctly.

Case a)

```
OUTPUT 727, "FREQU 123.4567 MHZ"  
OUTPUT 703, "Measure_frequency"  
ENTER 703, A$
```

Case b)

```
OUTPUT 727, "FREQU 123.4567 MHZ;"  
OUTPUT 703, "Measure_frequency"  
ENTER 703, A$
```

Output format

Measured results can be presented in normal or technical notation.

Normal presentation

Normal presentation corresponds to the notation that is usual in RF test engineering (sign, value, unit) and applies automatically after each total reset. The data are formatted for easier processing.

Characters 1-9 Measured value right-justified (max. nine places), sign immediately in front of the numeric value, filling of unused places with blanks. Special case: if a measurement does not produce a valid value or there is overranging/under-ranging, four minus signs are output instead of a numeric value.

Characters 10-11 Blanks

Characters 12-14 Units (left-justified)

Characters 15-16 CR+LF

Examples																
Characters	1	2	3	4	5	6	7	8	9	10	11	12	13	14	15	16
Measurement 300.5 mW					3	0	0	.	5			m	W		CR	LF
Invalid result					-	-	-	-				>	>	>	CR	LF

Technical presentation

Technical or exponential presentation offers advantages if the controller can convert this format directly into its internal presentation. In this notation the measured values (sign, value, exponent, unit) are always presented in the basic unit (eg V, W, A).

Character 1 Sign

Characters 2-11 Mantissa

Character 12 "E"

Character 13 Sign

Characters 14-15 Exponent

Characters 16-17 Blanks

Characters 18-20 Units (left-justified)

Characters 21-22 CR+LF

Examples																						
Charact.	1	2	3	4	5	6	7	8	9	10	11	12	13	14	15	16	17	18	19	20	21	22
9 nW	+	0	0	0	0	0	0	0	0	0	9	E	-	0	9			W			CR	LF
5.6 W	+	0	0	0	0	0	0	0	0	5	6	E	-	0	1			W			CR	LF
765 mA	+	0	0	0	0	0	0	0	7	6	5	E	-	0	3			A			CR	LF

Service request

By means of a service request a device connected to the IEEE bus tells the controller that a certain event has occurred (measurement ended, error, paper jam in printer, etc). The SRQ line of the control bus is used for this kind of message to the controller.

Using the SMASK xx command, a controller lets a device know what events it is "interested" in. The characters xx stand for the hexadecimal notation of an 8-bit data value, the so-called SRQ mask. The bits of this mask have certain events firmly assigned to them (see Table below). Whether or not the occurrence of an event is reported to the controller on the SRQ line will depend on the result of the logic AND operation of the SRQ mask and the event bits. Only if the appropriate bit for an event is set to "1" in the SRQ mask, is the service request triggered when the event occurs.

SRQ bit	Meaning
0	Illegal setting on STABLOCK 4015 (warning signal sounds twice) or missing hardware option
1	Error in frequency synthesizer
2	Incorrect IEEE remote-control command (syntax error)
3	SELF-CHECK signals error.
4	Applied RF power too high (REDUCE RF POWER)
5	Illegal setting on STABLOCK 4015 (warning signal sounds once) or SELF-CHECK executed
6	Identification bit. Communication Monitor sets this bit if one of bits 0 through 5 is set. Controller sees from this what device sent SRQ message.
7	Reserved. In SRQ mask this bit should always be set to 0.

IEEE commands only for remote control

The following IEEE commands are only permissible for remotely controlling STABLOCK 4015 with a controller. Further IEEE commands for both applications (remote control *and* AUTORUN) are listed in Chapter 9, section "IEEE Commands".

IEEE command	Effect
Total reset	
ERASE	Triggers a total reset (see Chapter 1) that resets all entry fields of STABLOCK 4015 to ex-works settings.
Service request	
SMASK xx	Defines by the two-digit hexadecimal figure xx those events that may trigger an interrupt (see section "Service request").
Measurement output	
PRSTR	As soon as this command is issued, the output format is in normal presentation (see section "Output format").
PREXP	As soon as this command is issued, the output format is in technical presentation (see section "Output format").

Appendix

(

(

(

(

Appendix A

Technical Data

Synthesizer

Noise	
• Incidental FM, rms, CCITT	≤ 9 Hz rms
Spectral purity	
• Phase noise, 25 kHz carrier offset <125 MHz	≤ -97 dBc/Hz
125 MHz...250 MHz	≤ -112 dBc/Hz
250 MHz...500 MHz	≤ -107 dBc/Hz
500 MHz...1000 MHz	≤ -102 dBc/Hz
• Spurious, 0.2 to 30 kHz offset	≤ -50 dBc
• Harmonics, < 0 dBm unmod.	≤ -20 dBc
Reference oscillator	
• Frequency error, ambient temperature 0 to 45 °C	$\leq \pm 0.5$ ppm
• Buildup time for < 1 ppm error	≤ 2 min
• Aging/year	$\leq \pm 1$ ppm
• External synchronization 10 MHz (Hardware option)	$> 0.2 V_{eff}$ at approx. 200 Ω

Receiver test

Carrier frequency	
• RF frequency range	0.4 to 1000 MHz
• Accuracy	as reference oscillator
• Resolution	100 Hz
Output level	
• N socket RX/TX, (AM 6 dB less)	-130 to -60 dBm
• BNC socket RX HIGH, (AM 6 dB less)	-70 to +13 dBm
• Resolution	0.1 dB
• Level error, unmod., > 2 MHz	
RX/TX, > -120 dBm	≤ 2 dB
RX HIGH, > -60 dBm	≤ 2 dB
• Reflection	
RX/TX	≤ 1.2 VSWR
RX HIGH	≤ 3 VSWR

RX modulation

FM AC modulation	
• Frequency deviation (peak)	0 to ± 30 kHz
• Modulation-frequency range, 1 dB bandwidth	0.03 to 10 kHz min.
• Modulation-frequency setting range	0.03 to 30 kHz

• Resolution	10 Hz
• Setting error, 0.3 - 6 kHz, deviation ≤ 20 kHz	≤ 10 %
• Distortion, 1 kHz, deviation < 6 kHz	≤ 1 %
• External input	1 M Ω
Sensitivity "Fixed" (± 5 % error)	10 kHz/Vp
Sensitivity "Variable"	0.01 to 10 kHz/mVp

FM DC modulation

• Frequency offset, < 1 min after calibration	
0 to 125 MHz	< 500 Hz
125 to 1000 MHz	< 1.3 Hz/MHz

Phase modulation

• Phase deviation (peak), < 20 kHz FM deviation	0 to 6 rad
• Modulation-frequency range, 1 dB bandwidth	0.2 to 6 kHz min.
• Modulation-frequency setting range	0.03 to 30 kHz
• Resolution	0.1 rad
• Setting error, 0.3 - 6 kHz (f x rad ≤ 10 kHz)	≤ 10 %
• Distortion, 1 kHz, ≤ 6 rad	≤ 1 %
• External input	1 M Ω
Sensitivity "Fixed" (± 5 % error)	10 rad/Vp
Sensitivity "Variable"	0.01 to 10 rad/mVp

AM modulation

• RF frequency range useful to	1.5 to 520 MHz . 1000 MHz
• Modulation depth	0 to 90%
• Modulation-frequency range, 1 dB bandwidth	0.03 to 10 kHz min.
• Modulation-frequency setting range	0.03 to 30 kHz
• Resolution	0.1 %
• Setting error, 1.5 to 520 MHz, f_{mod} 0.1 - 6 kHz, $m < 50$ %	≤ 10 %
• Distortion, 1 kHz, $m < 50$ %	≤ 2 %
• External input	1 M Ω
Sensitivity "Fixed" (± 5 % error)	100 %/Vp
Sensitivity "Variable"	0.03 to 33 %/mVp

Transmitter test

Transmitter test, general	
• Automatic tuning on RX/TX socket (Count)	
< 600 MHz	> 1 mW
600 ... 1000 MHz	> 10 mW

- Max. input level:
continuous ≤ 50 W
shortterm ≤ 1 min; ≤ 150 W
Pause > 2 to 5 min,
depending on temperature
Acoustic alarm for \geq limit temperature
- P_{max} on socket RX HIGH
and TX SENS 250 mW
(no power protection!)

Power measurement

- Measurement range:
RX/TX socket 0.01 mW to 150 W
AM peak 150 W max.
TX SENS socket -80 to $+10$ dBm
- Resolution:
for dBm 0.1 dB
for 1 mW to 150 W $< 1\%$
- Measuring error:
Input power < 50 W
RX/TX ± 0.6 dB + 2 digits
TX SENS ± 2 dB + 2 digits
 < 10 min after calibration

Frequency measurement

- RF frequency range 1.45 to 1000 MHz
- Offset frequency range
 $< 0.5 \times$ IF bandwidth $\geq \pm 40/10/5$ kHz
- Resolution
(RF and offset frequency) 10 Hz
- Measuring error (plus
reference-oscillator error) ≤ 20 Hz
- Input sensitivity (offset measurement)
RX/TX socket < -20 dBm
TX SENS socket < -80 dBm

TX modulation measurement

Modulation measurement, general

- Standard IF filter for AM/FM/ Φ M
3 dB bandwidth 80 ± 20 kHz
- Two narrowband channel filters
with high selectivity switch-
selected IF for aural monitoring
of FM/ Φ M modulation
6 dB bandwidth 20/9 kHz min.
- Input level w/o extra
measuring error:
RX/TX socket 0.1 mW to 150 W
TX SENS socket -60 to $+13$ dBm
- Squelch, disconnectible.
Response threshold adjustable

FM measurement

- Measurement range 0 to 30 kHz
- Resolution:
deviation < 10 kHz 10 Hz
deviation ≥ 10 kHz 100 Hz
- Measuring error,
deviation < 10 kHz,
0.3 to 6 kHz $\leq 8\% + 1$ digit
 < 10 min after calibration

- Distortion, deviation < 10 kHz $< 1\%$
- Demodulation output 600 Ω
- Sensitivity approx. 0.2 V_{pp}/kHz
3 dB bandwidth 0 to approx. 14 kHz
- Sensitivity on TX SENS socket:
10 dB SINAD, CCITT,
3 kHz deviation ≤ 2 μ V
- Φ M measurement
- Measurement range,
(rad $\times f_{mod} \leq 30$ kHz) 0 to 10 rad
- Resolution 0.01 rad
- Measuring error, 0.3 to 6 kHz,
rad $\times f \leq 10$ kHz $\leq 6\% + 1$ digit
 < 10 min after calibration
- Distortion, deviation < 10 kHz $< 1\%$
- Demodulation output 600 Ω
- Sensitivity approx. 0.2 V_{pp}/rad
3 dB bandwidth approx. 0.12 to 14 kHz
- Sensitivity on TX SENS socket:
10 dB SINAD, CCITT,
3 rad deviation ≤ 2 μ V

AM measurement

- Measurement range 0 to 100 %
- Resolution 0.1 %
- Measuring error, $m < 50\%$,
0.3 to 6 kHz $\leq 8\% + 1$ digit
- Distortion, $m < 50\%$ $< 1\%$
- Demodulation output 600 Ω
- Sensitivity dependent on RF level
3 dB bandwidth 0 to approx. 14 kHz

Spurious-modulation measurement

- Measurement range,
for max. measuring error 2 dB,
referred to 3 kHz FM,
3 rad, 30 % AM
CCITT filter, rms < 500 MHz 0 to -50 dB
CCITT filter, rms ≥ 500 MHz 0 to -45 dB

AF generators

Variable-modulation generator A

- Frequency range 0.03 to 30 kHz
- Frequency resolution < 10 kHz 0.1 Hz
 ≥ 10 kHz 1 Hz
- Frequency error $\leq 0.02\%$
- Level range, EMF 0 to 3.6 V_{rms}
- Level resolution < 10 mV 0.01 mV
 < 38 mV 0.1 mV
 ≥ 38 mV 1 mV
- Level error 300 Hz to 3 kHz $\leq 2\% + 2$ digits
50 Hz to 10 kHz $\leq 5\% + 2$ digits
- Distortion 30 Hz to 30 kHz
(BW: 100 kHz) $\leq 0.6\%$
- Load Impedance ≥ 200 Ω
- Output Impedance unbal.
0.3 to 3 kHz 4.8 ± 0.4 Ω

1 kHz modulation generator C

- Distortion
(test bandwidth: 100 kHz) $\leq 0.4\%$
(all other data like gen. A)
Beat-frequency oscillator
- Sum level for modulation beating
gen. A + B + C/Ext $\leq 15 V_{pp}$
(for gen. B see internal options, data module)

AF analyzer

AF voltmeter

- Frequency range
(1 dB bandwidth) DC/AC 0/0.03 to 6 kHz min.
- AC measurement range 0 to 20 V
- DC measurement range 0 to ± 30 V
- Resolution ≥ 10 V 100 mV
- < 10 V 10 mV
- < 1 V 1 mV
- < 0.1 V 0.1 mV
- Measuring error at 1 kHz, DC $\leq 2.5\% + 1$ digit
- Measuring error 0.1 to 3 kHz $\leq 5\% + 1$ digit
- DC offset, after calibration ≤ 2 mV
- Input impedance unbal. 1 M Ω , 20 pF
- CCITT filter to CCITT P53 standard
- C-weighting filter
- Highpass/lowpass/bandpass filters programmable

AF counter

- Frequency range 0.03 to 30 kHz
- Resolution < 300 Hz 0.1 Hz
- ≥ 300 Hz 1 Hz
- Measuring error ≤ 2 digits
- Input level 0.1 to 3 kHz ≥ 10 mV
- 0.05 to 10 kHz ≥ 20 mV
- Min. FM deviation for transmitter test 500 Hz

Distortion & SINAD meter

- Test frequency
(1 kHz for SINAD) 0.2 to 2 kHz
- Measurement range
for distortion 0 to > 50 %
for SINAD 0 to > 45 dB
- Resolution for distortion measurement 0.1 %
for SINAD 0.1 dB
- Measuring error
for distortion < 10 % $\pm 0.5\%$ absolute
for SINAD 6 to 20 dB ± 0.5 dB
- Input level > 100 mV
- Min. FM deviation for transmitter test 500 Hz

Scope & analyzer

Digital storage oscilloscope

- Modes one shot,
continuous,
freeze,
time measurement
- Frequency range, AC, DC like AF voltmeter
- Measuring error like AF voltmeter
- Input switching like AF voltmeter
- Trigger settings autotrigger
variable positive/negative
- Trigger signals voltmeter
TX power
RX level
external TTL
- Horizontal deflection, timebase 0.1 to 500 ms/div
- Vertical deflection, (setting manually or automatically)
level scale 2 mV to 10 V/div

Spectrum analyzer

Modes

- "Analyzer" = analog spectrum analyzer
- "Marker" = analyzer with frequency markers, optionally with automatic tuning of frequency marker
- "Freeze" = display stored, simultaneously demodulation (and aural monitoring) of marker frequency

Frequency

- (zero down-conversion) image-free
- Frequency range 1.5 to 1000 MHz
- Sweep width selectable 0.25 to 10 MHz
- Evaluation bandwidth corr. to sweep width max. 20 kHz
- Sweep time ≤ 2.5 s

Level

- Dynamic range, total -100 to +50 dBm
- P_{ref} , n x 10 dB switchover
RX/TX socket +10/+20 to +50 dBm
TX SENS socket -50/-40 to 0 dBm
- Display range ($P_{ref} = 0$ dBrel) 0 to -60 dBrel
- Measuring error at
0 to -40 dBrel absolute ≤ 3 dB
relative, Diff < 20 MHz ≤ 1 dB
- Inherent noise ≤ -45 dBrel
- Intermodulation products
- $P_{max} \leq +20$ dBm ≤ -40 dBrel
- Signal/image ratio

Options

HARDWARE OPTIONS

Duplex synthesis

- For simultaneous RX and TX functions.
- All data as for RX and TX above.
- Min. TX frequency 1.5032 MHz
- Duplex spacing selectable > 2 MHz

Data module

Digital encoder and decoder for radio-data systems

- Coding:
 - NRZ ≤ 10 kBaud
 - FFSK ≤ 5 kBaud
 - FSK ≤ 2 kBaud
 - Manchester ≤ 10 kBaud
- Encoder:
 - additional level setting error ≤ 4 %
 - overshoot on squarewave ≤ 5 %
- Decoder:
 - FM deviation range 1 to 10 kHz

Variable modulation-generator B

- Additional level error ≤ 2 %
- Distortion 0,03 to 30 kHz (test bandwidth 100 kHz) ≤ 1 %
- (all other data like gen. A)

DTMF module

- Encoder and decoder, selectable duration and pause.

Interface IEEE bus/RS-232-C/keyboard

IEEE bus interface

- Standard IEEE-488 GPIB
- Connector Amphenol socket, 24-way
- Application printer driver, computer control
- Functions AH1, SH1, L2, T1, SR1, RL1, DC1

Keyboard interface

for keyboard ordering code 248 192

- Connector submin D socket, 15-way
- Application entries in autotest programming

RS-232-C interface

- Standard RS-232-C
- Connector submin D plug, 9-way
- Application printer driver

Interface Centronics/RS-232-C/keyboard

Centronics interface

- Standard Centronics interface

- Connector Amphenol socket, 36-way
- Application printer driver

Keyboard interface

for keyboard ordering code 248 192

- Connector submin D socket, 15-way
- Application entries in autotest programming

RS-232-C interface

- Standard RS-232-C
- Connector submin D plug, 9-way
- Application printer driver

Internal battery

- Operating time, battery fully charged > 1 h
- Internal charge, automatically controlled approx. 14 h (start when connected to line, stop upon limit temperature)
- Battery-voltage indication on display typ. 12 V
- Battery operation for line outage automatic switchover

External synchronization (10 MHz)

- Application Frequency synchronization with ext. 10 MHz reference
- Synchron. indicator LED
- Input BNC socket, approx. 200 Ω
- Ref. signal 10 MHz, > 0,2V_{eff}

SOFTWARE OPTIONS

Tests of mobile telephones and radio-data systems require appropriate software options on memory cards (see check list).

General data

Power supply

- AC line 220/115 V ± 20 %
47 to 450 Hz
- External DC supply (minus on ground) +10 to 32 V
Upon line outage automatic switchover to internal or external battery
- Power consumption approx. 80 W (see options for internal battery)

Control interface

- Connector submin D socket 25-way
- 4 control relays, each with 1 contact = 2 lines freely programmable or as automatic switch for RX/TX, squelch.
- TTL control:
 - outputs 12
 - inputs 1

- Auxiliary power supply:
3 voltages +15 Vdc, -15 Vdc, +5 Vdc
current limiting approx. 30 mA

Dimensions and weight

- Weight w/o options approx. 9,5 kg
- with all options
- Incl. battery \leq 13 kg
- Dimensions W/H/D 338 / 176 / 350 mm

Environment

- Operating temperature 0 to 50 °C
- Storage temperature -40 to +70 °C
- Full specifications after 15 min
- Mechanical strength to DIN 40046
- Shock 30 g
- Vibration 5 Hz to 60 Hz, excursion 10 mm
10 Hz to 60 Hz, 2 g const.
- Security VDE 0411/IEC 348

Radiated interference

- RF tightness, measured with coil, 2 turns,
25 mm diameter on 50 Ω at 25 mm distance
- > 60 MHz \leq 1 μ V
- < 60 MHz \leq 3 μ V
- Radiated interference
to VDE 0871 \leq "limit value B"

Ordering data

- **STABILOCK 4015** 108901
- **Hardware options**
- Duplex synthesis 229038
- Data module 236016
- Interface Centronics/RS-232/keyboard 236012
- Interface IEEE-488/RS-232/keyboard 236013
- Internal battery 205006
- DTMF module 248171
- External Synchronization (10 MHz) 214026
- **Software options**
- NMT 450/900 Scandinavia 897974
- NMT 450 897967
- NMT 900 897980
- NMT 450 universal 897975
- C-Net Austria 897976
- NMT Benelux 897977
- NMT France 897978
- Natel-C Switzerland 897979
- ETACS UK 897971
- TACS Japan (J-TACS) 897973
- EAMPS 897972
- RC 2000 897966

- POCSAG (NRZ) 897981
- POCSAG (FFSK) 897982
- Trunking MPT 1327 697983
- Cityruf 897932
- US Signaling 897984
- LTR + US Signaling 897966
- Microcell 897931
- ARE AUTORUN-Editor 897100

ACCESSOIRES

- **Accessories supplied** 249025
- Set of miniature fuses 849036/849064
- Power cable standard or 880604
- Power cable USA or 880620
- Power cable UK 880621
- 50 Ω BNC termination (2 x) 874009
- Panel cover (2 x) 501370
- Headphones jack 884123
- Battery-cable socket 884015
- 1 memory card (blank, 32 Kbytes) 897050
- User manual 290089

Recommended extras

- IEEE-488 Interface PCIIA 860182
- Microphone 248147
- Telescopic antenna 248148
- Test-adaptor kit 248138
- Symm.-AF-Transformer 248194
- VSWR measuring head 248104
- Battery pack, external,
with connecting cable 248185
- Keyboard 248192
- Submin D connector set, 25-way
for control interface 300641
- Submin D connector set,
9-way for RS-232-C 300758
- Cable set 300690
- Transport case 300750
- Protective Edges 248146
- Carrying bag 378268
- Centronics cable 860180
- Service manual 291089
- RF probe 860108
- 1 M Ω probe 860148
- Ink-jet printer 896092
- Spare cartridge 860133
- Printer paper 2500 sheets 860134
- Memory card 32 Kbytes 897050
- Memory card 64 Kbytes 897051
- Memory card 128 Kbytes 897052

Subject to changes without notice

(

(

(

(

Appendix B

Working with channel numbers

Entering channel numbers is much more practical in many applications than entering "awkward" frequencies. So STABLOCK 4015 supports working with channel numbers in all operating statuses that show the entry field `Frequ` on the display (tuning signal generator and/or test receiver).

To work with channel numbers, you must always follow the steps below, the first two being for preparation and only necessary once:

1. Enter conversion parameters in `NoL/U` menu.
2. Set required operating status on Communication Monitor.
3. Enter required channel number in `Frequ` field.

Steps 1. and 3. are explained more fully below.

Entering conversion parameters

Using the conversion parameters entered in the `NoL/U` menu, the Communication Monitor derives from a channel number the appropriate tuning frequency for the signal generator and test receiver.

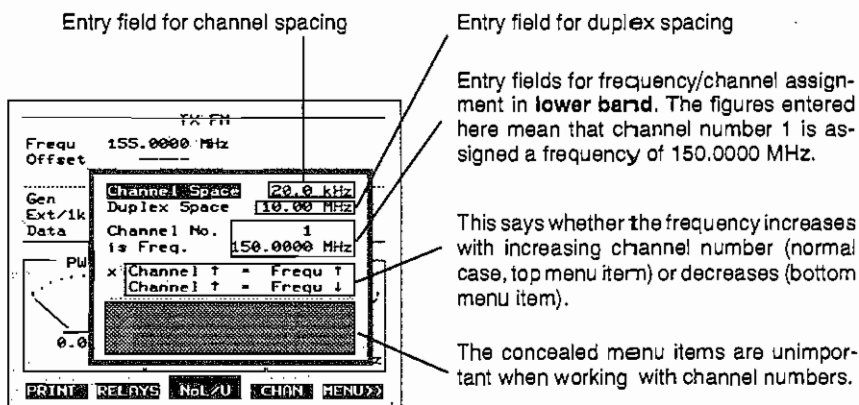

Fig. B.1: NoL/U menu

Example: What frequency corresponds to channel number 23 for the conversion parameters entered in Fig. B.1?

SIMPLEX $f_1 = 150.0000 \text{ MHz} + 22 \times 20.0 \text{ kHz} = 150.4400 \text{ MHz}$

The duplex spacing is unimportant here. If the duplex spacing is set to 0 in the NoL/U menu, you no longer have to bother about the upper band and lower band when working with channel numbers (NoL = NoU).

DUPLEX In duplex mode the spacing (10 MHz) is relevant. This means that in addition to $f_1 = 150.4400 \text{ MHz}$ there is a second frequency f_2 . You can decide – as shown later – which frequency is to be in the upper band and which in the lower band. If f_1 is assigned to the lower band, f_2 will be in the upper band:

$f_1 = 150.4400 \text{ MHz}$ $f_2 = f_1 + 10 \text{ MHz} = 160.4400 \text{ MHz}$

If f_1 is assigned to the upper band, f_2 will be in the lower band:

$f_1 = 150.4400 \text{ MHz}$ $f_2 = f_1 - 10 \text{ MHz} = 140.4400 \text{ MHz}$

☞ System programs automatically alter entries in the NoL/U menu, so you should always check, before working with channel numbers, that the required conversion parameters (those last entered manually) are still present.

Entering channel numbers

If the conversion parameters are entered in the NoL/U menu, you can work with channel numbers. If the FreqU field still shows frequencies, the field must be prepared first for the entry of channel numbers. The steps for doing this are as follows:

Preparation

1. Position cursor bar on entry field FreqU.
2. Enter required channel number, but do *not* yet confirm entry with **ENTER**.
3. Strike **UNIT/SELECT**. This opens a small menu window (Fig. B.2) that offers, among other things, the menu items NoU and NoL. These enable assignment of the entered channel number to the upper band (NoU, U = Upper) or to the lower band (NoL, L = Lower). Which of the two menu items is now to be selected depends on whether simplex or duplex radios are tested.

Fig. B.2: The small menu window permits the assignment of a channel number to the upper band (NoU) or lower band (NoL). If you no longer want to work with channel numbers and return to frequencies, you must cross menu item MHz. Menu item Chn is irrelevant when working with channel numbers (see Chapter 4, "CHAN").

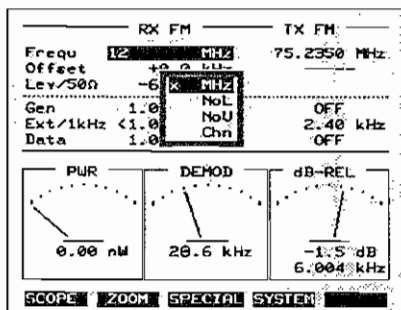

- 3a. **Simplex:** If the duplex spacing has been set to 0 in the NoL/U menu, it is irrelevant which of the two menu items you cross (upper-band channel = lower-band channel). If the duplex spacing is $\neq 0$, you must cross menu item NoL (the channel/frequency assignment made in the NoL/U menu applies to the lower band).

- 3b. **Duplex:** When testing duplex radios, you must know in which band the test item transmits or in which it receives. If the test item transmits in the upper band for example, the Communication Monitor receives in the upper band and transmits in the lower band. If the channel number was entered in the Frequ field of the signal generator in step 2, for example (Fig. B.2), menu item NoL must be crossed so that the signal generator transmits in the lower band on the required channel. You no longer have to worry about setting the test receiver to the same channel in the upper band: as soon as a channel is assigned to a band manually, the Communication Monitor automatically assigns the same channel to the other band.

After this preparation you can enter channel numbers in the Frequ field without any other steps. You can enter a channel number on the numeric block or by turning the spinwheel (see Chapter 2, "Continuously altering entries"). In duplex mode it is enough to set either the signal generator or the test receiver to a new channel in order to tune both correctly (automatic offset by the duplex spacing entered in the NoL/U menu).

Exchanging upper band and lower band

On some duplex radios the band assignment to transmitter and receiver can be changed with a switch. On the Communication Monitor you must open the menu window (**Fig. B.2**) and then simply cross NoU instead of NoL for example.

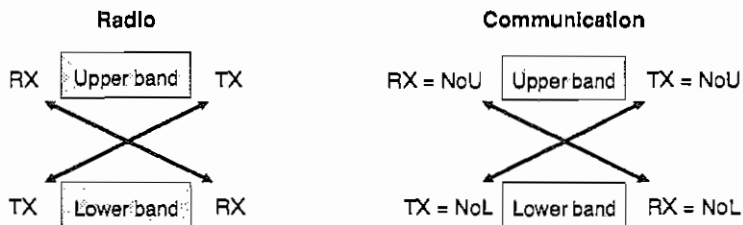

Returning to frequency entry

When you want to work with frequencies again, position the cursor bar on the Freq. field, open the menu window with **UNIT/SELECT** and select menu item MHz.

Appendix C

Version status

Some passages in the text of the manual are marked with number indexes. This is to indicate that the particular passage is not universally valid but depends on the software/hardware version of STABILOCK 4015. What the restrictions are can be seen from the explanations to the number indexes below.

- 1) IF bandwidth 9 kHz not available until revision status 01 of the Demodulator stage (see HW REV menu).
- 2) If the HW REV menu shows a revision status of < 02 for the RF Unit, the TX SENS RF input socket has to be terminated with a 50- Ω resistor before starting the calibration procedure. The calibration menu windows draw your attention to this by showing Connect 50 Ω terminator to TX Sens socket.
- 3) If the STATUS menu says you have a software version of <1.20, the Communication Monitor will *not* offer temperature-regulated calibration. So, if your Communication Monitor is subjected to use that can cause its interior temperature to alter (alternating use in a test shop and mobile service, application of powerful RF signals), you should carry out specific calibration at regular intervals (in any case before precise measurements, see Chapter1).
- 4) From serial number 0289000 onwards there is no longer a filter mat in front of the fan opening but a filter grid. If you operate the Communication Monitor in dusty surroundings, an extra filter can be used: up to serial number 0489999 filter mat 770 221, from serial number 0589000 fine filter 788 221. All filters should be cleaned at regular intervals (see Chapter 3, "Rear Panel").
- 5) If the STATUS menu indicates a software version of < 1.30, the Communication Monitor will *not* offer you the TX/DUPLEX Special F-BRST.

Appendix D

Executing firmware update

Updating the STABILOCK 4015 firmware calls for the replacement of two EPROMs on the computer board. When handling the ICs, remember the usual protective measures for electronic devices, especially as regards electrostatic discharge.

Recording instrument settings



The update means that the Communication Monitor loses all instrument settings specified by the user, ie setups stored in RAM, declared user tone sequences and many declarations made in the menus. Setups stored on memory cards are also no longer usable after a firmware update. So, before the update, check what user-specific setups will still be required and record them on paper. After the update you will then be able to set and store them again.

Replacing EPROMs

- 1) Switch STABILOCK 4015 off and remove all leads including the power cable. If sockets Bu 27 and Bu 26 are still covered with plastic caps, they can be left in place. If there is an interface (hardware option) attached to the rear, this will have to be removed.
- 2) Undo all screws on the rear panel that are inserted in the black strips.
- 3) Remove the rear panel by a short tug on the screws A and B (Fig. D.1).

Fig. D.1: After undoing the screws on the black strips, the rear panel can be removed by a short tug on screws A and B.

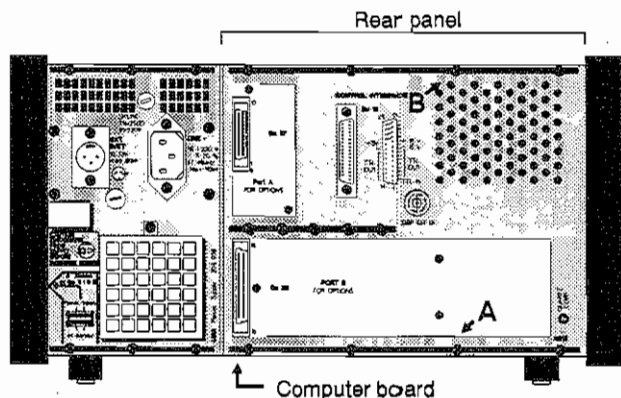

- 4) The board right next to the power supply is the computer board of STABILOCK 4015. Use the metal piece between the two connector strips as a grip and carefully pull out the computer board. Caution: *Never* pull out the computer board while the set is switched on!
- 5) On the computer board you will find EPROMs P3 and P4 (Fig. D.2). Remove them from their sockets - best done with a chip extractor - and put them to one side (make sure you do not get the old and new EPROMs mixed up).
- 6) Are the pin rows of the two new EPROMs at right angles to the IC packages? If not, carefully bend them to the correct angle with a clamp or on a flat surface.
- 7) Insert the new EPROM P3 in socket P3 (Fig. D.2) and P4 in socket P4 (observe the markings on the package).
- 8) Put the computer board back into the slot next to the power supply on its guide rails. The component side must be facing away from the power supply (direction of insertion: see Fig. D.2). Do not use force: the computer board must easily slot into its connector.
- 9) Put the rear panel back in place, leading with the lefthand edge. Apply pressure to the righthand edge and the rear panel will engage with the chassis and can be screwed in place (tighten *all* screws on the black strips, otherwise any interface attached to the rear panel will not make proper contact). If no interface is connected to port A/port B, sockets Bu 27 and Bu 26 should be left covered by their metalized plastic caps (to shield radiated interference).

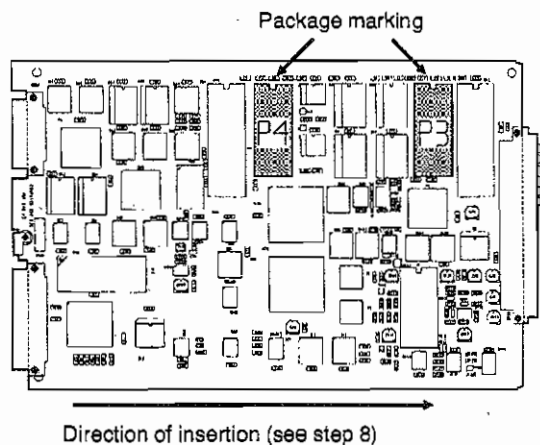

Fig. D.2: Computer board of STABILOCK 4015 with two EPROMs P3 and P4

- 10) Reconnect STABLOCK 4015 to its power source and switch it on. A total reset is necessary for initializing the new software. Press the **[OFF]** key, keep it depressed and briefly strike the **[RESET]** key. As soon as you release the **[OFF]** key, there is a brief pause after which you are requested to calibrate, and then the **STATUS** menu appears, showing the version number and checksum of the new firmware. Strike the **[MENU]** key and STABLOCK 4015 is ready for operation again; all entry fields and menu items are reset as they were ex works. The "Lifeline" in Appendix C tells you what the important modifications are between the previous and the new firmware.
- 11) Return the removed EPROMs directly to the SCHLUMBERGER service station from which you received the new EPROMs. Use the special package that the new EPROMs were supplied in.

(

(

(

(

Appendix E

Functional description of STABLOCK 4015

The functional description refers to the block diagram at the end of this section. Circuit diagrams, component layouts, parts lists and a detailed description of all stages are contained in the Service Manual (ordering code: 291 089; when ordering, state the serial number of your unit).

SYNTHESIS

Frequency synthesizer: The 100-Hz decade and the 5-MHz decade are combined in the adder PLL (phase-locked loop) to produce an output frequency between 500 and 1000 MHz. Frequency dividers extend this range to between 125 and 1000 MHz. Down-conversion with 410 MHz in the RF Unit produces output frequencies from 125 MHz down to 0.4 MHz.

Duplex synthesizer (option): The duplex stage only produces the local-oscillator (LO) frequency for transmitter tests if the synthesizer for receiver tests is required at the same time. The duplex circuit differs from the other synthesizer through the extended frequency divider at the output and the lack of FM modulation and the sweep function.

20-MHz crystal reference: The temperature-compensated crystal oscillator (TCXO) in the RF Unit requires no warmup after powering on. This is the frequency reference for the synthesizer, duplex, 1-kHz generator and computer (modulation generator A and the Data Module have a separate reference frequency).

Acting as a calibration generator it produces a substitute TX signal for calibration and selfcheck.

In the external synchronization (option) the internal 20-MHz crystal frequency is synchronized with an external 10-MHz reference by a very slow PLL.

Synthesized sweep for spectrum analyzer: The sweep generator drives the unsynchronized oscillator of the 100-Hz decade, whose divided output frequency is counted by the computer. At the end of the sweep range the computer triggers a new sweep with "Up/Down". The sweep rate depends on the set sweep width and the synthesizer frequency divider at the output. It is controlled by the DC voltage on "RXAM".

RECEIVER TESTS

Output level: The rectified RX level is controlled over a dynamic range of at least 16 dB according to the rectified AM modulator signal. The 10-dB-graded attenuator damps the RX signal by 0 to 50 dB. This electronic attenuator also switches fast enough for squelch measurements.

For the RX/TX socket there is extra fixed attenuation to reduce the output level by 60 dB to between -60 and -130 dBm.

On the RXhigh socket there is - in part amplified - an output level of -70 to +13 dBm.

AM modulation: An (AM) AC voltage is superimposed on the (RX level) DC voltage. This sum signal is attenuated by a D/A converter in the modulation generator as a function of the level setting and fed to the output-level control.

FM modulation: The FM modulator in the synthesizer consists of a tunable crystal oscillator that is synchronized by a very slow PLL for FM-AC. For FM-DC the synchronization is disabled.

The FM modulation signal is produced by the modulation generator. Before the FM modulator the amplitude is increased by a factor of x1, x2 or x4 to compensate for the FM reduction in the frequency divider on the synthesizer output. The polarity is switched for the down-conversion range of <125 MHz.

In the 5-MHz decade the FM deviation is divided differently in each 5-MHz band. The corresponding alteration of the FM deviation is compensated automatically in the level of the modulation generator.

Φ M modulation: The preemphasis alters the FM signal amplitude as a function of modulation frequency. At twice the modulation frequency the amplitude is halved. At 1 kHz the level is the same for FM and Φ M. Below 300 Hz the level is reduced by a highpass filter.

TRANSMITTER TESTS

Signal path: In transmitter tests the 4015 works as a test receiver. High TX levels on the RX/TX socket or small TX levels on the TX SENS socket are applied via fixed attenuators or amplifiers to the RF input of the TX mixer. The LO signal from the synthesizer or duplex stage mixes the TX signal down to IF frequency. The IF level is matched to the following demodulators, etc by $n \times 10$ dB amplifiers or attenuators.

Frequency measurement: If the level on the RX/TX socket is high enough, the computer can count independently of the test receiver via frequency dividers. This means that automatic frequency tuning is possible. At low levels the transmitter frequency is calculated from the counted IF frequency and the set synthesizer or duplex frequency.

FM demodulation: Depending on the FM modulation spectrum that is to be measured, one of three different IF filters can be connected ahead of the FM demodulator.

Φ M demodulation: The deemphasis alters the amplitude of the FM demodulation as a function of the modulation frequency. If the modulation frequency is doubled, the amplitude is also doubled. At 1 kHz the level is the same for FM and Φ M.

AM demodulation: A linear peak-responding IF rectifier works as the AM demodulator. The measured value – even for distorted modulation through appropriate evaluation – corresponds to the AM definition ($m = A-B/A+B$). The demodulated AM signal is also used for measuring power. For this reason the test receiver is linear throughout, from the RF signal through the IF and AM demodulation to the A/D converter.

Spectrum analyzer: After the TX mixer the signal path is different from that of normal transmitter testing. The IF is no longer 450 kHz but approx. 0 to 10 kHz instead. Level measurement is as in AF decoding. The "IF bandwidth" corresponds to double the bandwidth of the programmable lowpass filter of 1 to 10 kHz. This is matched to the set sweep width (for sweep, see Synthesizer).

AF GENERATORS

There are five different signal sources:

1. Variable modulation generator A
2. Data Module (option) for digital data modulation, or as modulation generator B
3. DTMF Coder (option) only in place of the Data Module
4. 1-kHz modulation generator C
5. External modulation input only in place of the 1-kHz modulation generator

A maximum of three signals can be superimposed as an internal or external modulation signal. In duplex mode internal and external modulation signals are

available simultaneously, in as much as it is practical for an application, DC coupling is possible.

AF DECODING

Signal path: According to the application, every signal that is to be measured is applied to the A/D converter via switches, multiplexer, AC/DC switchover, filters and switch-selected amplifiers in a continuously repeated test sequence. Only one signal can be measured at a time.

On the front panel there are also AF output attenuators and input amplifiers to prevent interference on the longer internal lines. The extra circuit paths on the modulation-generator board are only necessary for calibration.

Digital signal processing: The fast signal sampling in the A/D converter digitizes the test signal, which is evaluated by the digital signal-processing software of the computer. Thus, for example, no hardware notch filter is necessary for distortion measurement to suppress the fundamental because this fundamental is "calculated out" by the digital signal processing. Other traditional hardware functions like AF filter, rms rectifier, peak-responding rectifier are also managed by the digital signal processing. To keep testing time short, the CCITT filter and a selectable lowpass filter are in the form of hardware.

Incoming DTMF signals are decoded by the DTMF option largely independently of the computer. The digital modulation signals for cellular and other radio networks are decoded in the Data Module (and also generated). Generation and decoding for sequential calling systems are performed independently of the Data Module in modulation generator A and frequency counters in the computer.

POWER SUPPLY, BATTERY

Depending on the line voltage that is applied, the switch-mode power supply automatically selects the appropriate voltage range. The secondary side is fed either from the primary side or from the internal or external battery. It produces the three internal supply voltages, the voltage of +15 V also being available with low load current as a reference voltage and without voltage losses in the entire set.

The charging of the internal battery works fully automatically even when the set is powered off but still connected to the line. Upon warming up of the internal battery at the end of charging with approx. 0.7 A, the power supply automatically switches to a trickle charge of approx. 0.07 A. The speed of the fan is controlled by the RF Unit as a function of the internal temperature.

COMPUTER CONTROL

The computer includes a 68000 microprocessor with the necessary peripherals and memory. An extra multiplier accelerates DSP computations. Front-panel operations are detected by the keyboard encoder. The LEDs on the front panel are driven by LED drivers. The display driver drives the electroluminescent display. The control of the Data Module is by way of the serial ACIA interface.

The bidirectional system bus for controlling all boards consists of two PIAs (peripheral interface adapters).

A timer generates a frequency that determines the cutoff frequency of the programmable 1 to 10 kHz lowpass filter.

External interface options are controlled directly by the computer bus. In this way printers, radio sets, etc can be controlled on different interfaces. An external keyboard can be connected to generate AUTORUN programs.

CALIBRATION

Measuring accuracy is substantially improved by software correction and calibration. A distinction is made between once stored correction data and calibration that can be repeated at any time. EEPROM correction: RF frequency-response flatness and level errors of the RF Unit are measured before equipment is shipped and stored in a nonvolatile memory (EEPROM) in the RF Unit. This means that the unit can be exchanged without sacrificing accuracy.

AF calibration: Level errors of the internal AF circuits are avoided by measurement and allowance for level deviations. For this purpose there are special internal test circuits (AF CAL).

TX/IF calibration: IF level, modulation and demodulation can be checked very precisely at any time with the 20-MHz calibration signal (CAL Gen). In this way, even at extreme temperatures and when boards are exchanged, high measuring accuracy is achieved, eg for selective measurement of transmitter power, after the automatically run calibration procedure.

SELF CHECK

Automatically run selfchecks can test just about every internal function without external aids. In this way a defective board can be uniquely localized. A number of extra circuits, like the test generator on the IF input and the selfcheck lines of level and frequency controls, enhance these possibilities further.

Explanation of numbers: see Chapter 3

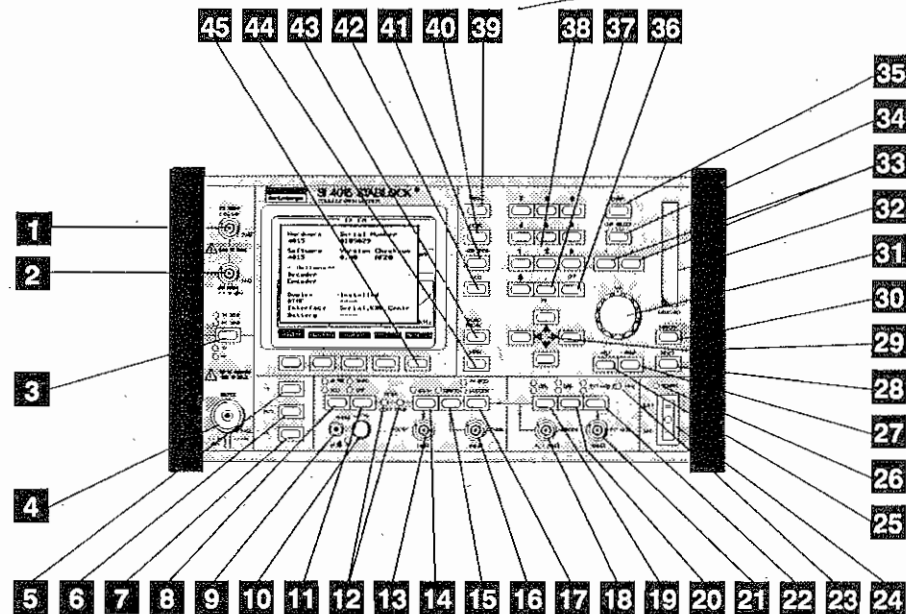

STABILOCK 4015 block diagram

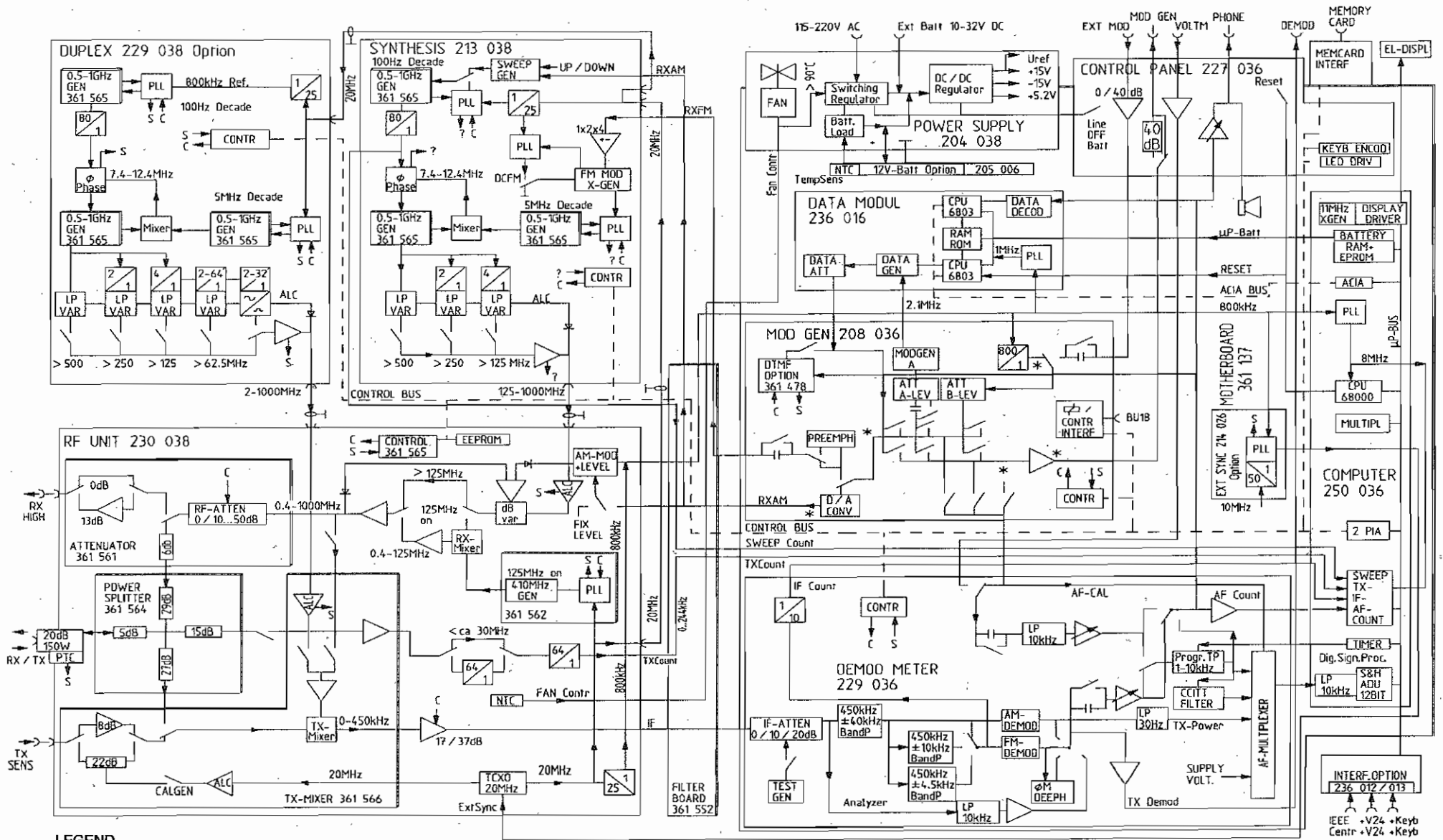

LEGEND

- C = Control lines
- S = Selfcheck lines
- * = Calibrate measurements

Quick Reference

The Quick Reference shows for all standard masks and menus the identification numbers and codes that are required for the IEEE commands WRTVA, SELECT, CANCEL and RESULT (see Chapter 9). This reference saves you having to page through the masks/menus with (HELP V) and (HELP R). Figures with the remark RESULT show the numbers of display fields, all other masks and menus show the numbers/codes of entry fields.

RX FM

Frequ 1
Offset 2
Lev/50n 3

Gen 5
Ext/1kHz <1.0000 kHz> 7
Data 6 15 11

RMS

SCOPE ZOOM SPECIAL SYSTEM

TX FM

Frequ 1
Offset 2

Gen 2
Ext/1kHz <1.0000 kHz> 7
Data 3 15 11

PWR DEMOD RMS

SCOPE ZOOM SPECIAL SYSTEM ANALYZ

RX FM TX FM

Frequ 1 2
Offset 3 4
Lev/50n 5 6

Gen 5 8
Ext/1kHz <1.0000 kHz> 7 16
Data 7 12

RX mode

PWR DEMOD dB-REL

SCOPE ZOOM SPECIAL SYSTEM

RX FM TX FM

Frequ 1 2
Offset 3 4
Lev/50n 5 6

Gen 6 11
Ext/1kHz <1.0000 kHz> 7 19
Data 8 15

TX mode

PWR DEMOD dB-REL

SCOPE ZOOM SPECIAL SYSTEM

AUTORUN

x RMS eff
mW/W mW/W
dBm(500n) dBm(500n)
DC Volt

Demod RMS Dev

Demod Rangehold

AF-PAR RF-PAR MOD-PAR FILTER MENU>>

AUTORUN

Auto Freq.Adj.

x mW/W
dBm
Peak

x 50n
EMF

Preatt Preatt

Squelch
RX/TX RX/TX
TXSens TXSens

BW TXSens BW TXS

AF-PAR RF-PAR MOD-PAR FILTER MENU>>

AUTORUN

x FM
FM
Cross Demod FM

1 kHz Mod

x Ext AC
Ext DC-FM

x Ext FIX
Ext VAR
Mic <25aV

AF-PAR RF-PAR MOD-PAR FILTER MENU>>

AUTORUN

CCITT
C-Weighting

x High Pass High Pas
HP sharp cut-off

x Low Pass Low Pas
LP sharp cut-off

Band Pass Band Pas
Band Stop Band Sto

Dist Notch Dist Not

AF-PAR RF-PAR MOD-PAR FILTER MENU>>

AUTORUN

HP 2225
x Epson FX80

IEEE
x Serial
Parallel

RS232 Baud 9600

IEEE Address 10
Talk-Only
EOI
13

PRINT RELAYS NoL/U CHAN MENU>>

AUTORUN

Auto rx/tx
RLY 1 Closed

Auto squelch
RLY 2 Closed

RLY 3 Closed
RLY 4 Closed

Hex Chan
BCD Chan

x TTL12..1 11

PRINT RELAYS NoL/U CHAN MENU>>

AUTORUN

Channel Space Channel
Duplex Space Duplex Spa

Channel No. Chan
is Freq. is Freq.

x Channel ↑ = Freq ↑
Channel ↓ = Freq ↓

RX and TX independent

x TX = RX + Duplex
RX = TX + Duplex

PRINT RELAYS NoL/U CHAN MENU>>

AUTORUN

Chan	RX (MHz)	TX
1	1	11
2	2	12
3	3	13
4	4	14
5	5	15
6	6	16
7	7	17
8	8	18
9	9	19
10	10	20

PRINT RELAYS NoL/U CHAN MENU>>

Basic masks

Menus of basic masks

SCOPE

AUTORUN

200 Hz/div
 400 Hz/div
 800 Hz/div
 2 kHz/div
 4 kHz/div
 x 8 kHz/div

AMPLI TIME TRIGGER SOURCE

AUTORUN

100 ps/div
 200 ps/div
 500 ps/div
 x 1 ms/div
 2 ms/div
 5 ms/div
 10 ms/div
 20 ms/div
 50 ms/div
 100 ms/div
 200 ms/div
 500 ms/div

AMPLI TIME TRIGGER SOURCE

AUTORUN

Auto Scope
 Var Scope
 x Ext TTL
 RX Level
 TX Power

 x Pos
 Neg

AMPLI TIME TRIGGER SOURCE

AUTORUN

x Voltm/Demod/Mod
 TX Power (DC)
 DC Coupled
 x AC Coupled

AMPLI TIME TRIGGER SOURCE

ZOOM

RMS

AUTO RANGE FIXED RANGE

RMS

Center	+/-	t/-
Center	Tol	Tol

AUTO RANGE FIXED RANGE

AUTORUN

x AF
 Mod/Demod
 RF Power
 Offset

SIGNAL SMOOTH

AUTORUN

Damping 1

SIGNAL SMOOTH

ANALYZER

Ref. Lev -50.0 dBm Span 2.50 MHz

Center 1

CONTIN FREEZE 1-SHOT MARKER

AUTORUN

0.0 dBm
 -10.0 dBm
 -20.0 dBm
 -30.0 dBm
 -40.0 dBm
 x -50.0 dBm

LEVEL SPAN

AUTORUN

0.25 MHz
 1.00 MHz
 x 2.50 MHz
 10.00 MHz

LEVEL SPAN

SENS BANDW. NF RESP SOLCH RUN

Ref 23

24	dB
25	dB
26	dB
27	dB
28	dB
29	dB
30	dB

Gen 5
Ext/1kHz <1.0000 kHz> OFF

Data 6

Lev/500 2
Offset +0.0 kHz

Frequ 1
Offset 150.0000 MHz

RX FM

SENS BANDW. NF RESP SOLCH RUN

21	dB
20	dB

Gen 5
Ext/1kHz <1.0000 kHz> OFF

Data 6

Lev/500 2
Offset +0.0 kHz

Frequ 1
Offset 150.0000 MHz

RX FM

SENS BANDW. NF RESP SOLCH RUN

10	dB
11	dB
12	dB
13	dB
14	dB
15	dB
16	dB
17	dB
18	dB
19	dB

Ref 1.00 kHz

Gen 5
Ext/1kHz <1.0000 kHz> OFF

Data 6

Lev/500 2
Offset +0.0 kHz

Frequ 1
Offset 150.0000 MHz

RX FM

SENS BANDW. NF RESP SOLCH RUN

12	dB
20	dB

Gen 5
Ext/1kHz <1.0000 kHz> OFF

Data 6

Lev/500 2
Offset +0.0 kHz

Frequ 1
Offset 150.0000 MHz

RX FM

SENS BANDW. NF RESP SOLCH RUN

RX Mute

Unmute

Hysteresis

Gen 5
Ext/1kHz <1.0000 kHz> OFF

Data 6

Lev/500 2
Offset +0.0 kHz

Frequ 1
Offset 150.0000 MHz

RX FM

SENS BANDW. NF RESP SOLCH RUN

22	kHz
----	-----

Gen 5
Ext/1kHz <1.0000 kHz> OFF

Data 6

Lev/500 2
Offset +0.0 kHz

Frequ 1
Offset 150.0000 MHz

RX FM

SENS BANDW. NF RESP SOLCH RUN

RESULT

RX Mute

Unmute

Hysteresis

Gen 5
Ext/1kHz <1.0000 kHz> OFF

Data 6

Lev/500 2
Offset +0.0 kHz

Frequ 1
Offset 150.0000 MHz

RX FM

SENS BANDW. NF RESP SOLCH RUN

RESULT

3	dB
4	dB

Gen 5
Ext/1kHz <1.0000 kHz> OFF

Data 6

Lev/500 2
Offset +0.0 kHz

Frequ 1
Offset 150.0000 MHz

RX FM

TX FM

Frequ 1 ██████████
 Offset ██████████

Gen 2 ██████████ 7 ██████████
 Ext/1kHz <1.0000 kHz> OFF
 Data 8 ██████████ OFF

Deviation expected 16 ██████████ 19 ██████████ ---- mV

SENS VSWR AF RESP ██████████ RUN

TX FM

Frequ 1 ██████████
 Offset ██████████

Gen 2 ██████████ 7 ██████████
 Ext/1kHz <1.0000 kHz> OFF
 Data 8 ██████████ OFF

Ref <u>20</u> ██████████	<u>21</u> ██████████	---- dB
	<u>22</u> ██████████	---- dB
	<u>23</u> ██████████	---- dB
	<u>24</u> ██████████	---- dB
	<u>25</u> ██████████	---- dB
	<u>26</u> ██████████	---- dB
	<u>27</u> ██████████	---- dB

SENS VSWR AF RESP ██████████ RUN

TX FM

Frequ 150.0000 MHz
 Offset

Gen 1.0000 kHz 20.0 mV
 Ext/1kHz <1.0000 kHz> OFF
 Data 0.1538 kHz OFF

Deviation expected 2.40 kHz
 5 mV 1 ██████████

SENS VSWR AF RESP ██████████ RUN

RESULT

TX FM

Frequ 150.0000 MHz
 Offset

Gen 1.0000 kHz 20.0 mV
 Ext/1kHz <1.0000 kHz> OFF
 Data 0.1538 kHz OFF

Ref 1.00 kHz	0.15 kHz	<u>8</u> ██████████
	0.30 kHz	<u>4</u> ██████████
	0.40 kHz	<u>6</u> ██████████
	1.00 kHz	<u>6</u> ██████████
	1.25 kHz	<u>7</u> ██████████
	3.00 kHz	<u>8</u> ██████████
	6.00 kHz	<u>9</u> ██████████

SENS VSWR AF RESP ██████████ RUN

RESULT

TX FM

Frequ 1 ██████████
 Offset ██████████

Gen 2 ██████████ 7 ██████████
 Ext/1kHz <1.0000 kHz> OFF
 Data 8 ██████████ OFF

VSWR ----

SENS VSWR AF RESP ██████████ RUN

TX FM

Frequ 150.0000 MHz
 Offset

Gen 1.0000 kHz 20.0 mV
 Ext/1kHz <1.0000 kHz> OFF
 Data 0.1538 kHz OFF

Ref 1.00 kHz	0.15 kHz	<u>8</u> ██████████
	0.30 kHz	<u>4</u> ██████████
	0.40 kHz	<u>6</u> ██████████
	1.00 kHz	<u>6</u> ██████████
	1.25 kHz	<u>7</u> ██████████
	3.00 kHz	<u>8</u> ██████████
	6.00 kHz	<u>9</u> ██████████

SENS VSWR AF RESP ██████████ RUN

RESULT

TX FM

Frequ 150.0000 MHz
 Offset

Gen 1.0000 kHz 20.0 mV
 Ext/1kHz <1.0000 kHz> OFF
 Data 0.1538 kHz OFF

VSWR 2 ██████████

SENS VSWR AF RESP ██████████ RUN

TX FM

Frequ 150.0000 MHz
 Offset

Gen 1.0000 kHz 20.0 mV
 Ext/1kHz <1.0000 kHz> OFF
 Data 0.1538 kHz OFF

Ref 1.00 kHz	0.15 kHz	<u>8</u> ██████████
	0.30 kHz	<u>4</u> ██████████
	0.40 kHz	<u>6</u> ██████████
	1.00 kHz	<u>6</u> ██████████
	1.25 kHz	<u>7</u> ██████████
	3.00 kHz	<u>8</u> ██████████
	6.00 kHz	<u>9</u> ██████████

SENS VSWR AF RESP ██████████ RUN

RESULT

RX FM TX FM

Frequ 1 ██████████ 2 ██████████
 Offset 3 ██████████ 4 ██████████
 Lev/50p 4 ██████████

Gen 5 ██████████ OFF
 Ext/1kHz <1.0000 kHz> 15 ██████████
 Data 7 ██████████ OFF

x S1NAD 22 ██████████ ---- dB
 S/N 21 ██████████ ---- dB

DESENS ██████████ AF RESP ██████████ RUN

RX FM TX FM

Frequ 150.0000 MHz 150.0000 MHz
 Offset +0.0 kHz
 Lev/50p -66.0 dBm

Gen 1.0000 kHz OFF
 Ext/1kHz <1.0000 kHz> 2.40 kHz
 Data 0.1538 kHz OFF

x S1NAD 12 dB 1 ██████████
 S/N 20 dB 2 ██████████

DESENS ██████████ AF RESP ██████████ RUN

RESULT

RX FM TX FM

Frequ 1 ██████████ 2 ██████████
 Offset 3 ██████████ 4 ██████████
 Lev/50p 4 ██████████

Gen 5 ██████████ 8 ██████████
 Ext/1kHz <1.0000 kHz> OFF
 Data 7 ██████████ OFF

Ref <u>23</u> ██████████	<u>24</u> ██████████	---- dB
	<u>25</u> ██████████	---- dB
	<u>26</u> ██████████	---- dB
	<u>27</u> ██████████	---- dB
	<u>28</u> ██████████	---- dB
	<u>29</u> ██████████	---- dB
	<u>30</u> ██████████	---- dB

DESENS ██████████ AF RESP ██████████ RUN

RESULT

RX FM TX FM

Frequ 150.0000 MHz 150.0000 MHz
 Offset +0.0 kHz
 Lev/50p -66.0 dBm

Gen 1.0000 kHz 2.40 kHz
 Ext/1kHz <1.0000 kHz> OFF
 Data 0.1538 kHz OFF

Ref 1.00 kHz	0.15 kHz	<u>8</u> ██████████
	0.30 kHz	<u>4</u> ██████████
	0.40 kHz	<u>6</u> ██████████
	1.00 kHz	<u>6</u> ██████████
	1.25 kHz	<u>7</u> ██████████
	3.00 kHz	<u>8</u> ██████████
	6.00 kHz	<u>9</u> ██████████

DESENS ██████████ AF RESP ██████████ RUN

RESULT

AUTORUN

SYSTEM STND PARMS FREQ TIME

Sequential
PL/DPL
A/B Tone
DTMF
Memcard

AUTORUN

SYSTEM STND PARMS FREQ TIME

* ZVEI 1
* ZVEI 2
EURA
CCIR
EER
EIA
VDEW
CCITT
MATEL
S/G TONE
USER

AUTORUN

SYSTEM STND PARMS FREQ TIME

* CALL + DECODE
DECODE ONLY
CALL ONLY
CALL Delay
RX Lev On Delay
Tolerance
Bandwidth

AUTORUN

SYSTEM STND PARMS FREQ TIME

Frequency (Hz) ZVEI 1

0	8
1	9
2	10
3	11
4	12
5	13
6	14
7	15
8	16

Repeat Tone 17

Store to User Norm

TX FM

Frequ 1

Offset

Gen 2

Ext/1kHz < 1.000 kHz > OFF

Data 3

EIA

CALL + DECODE

Call Number 16

Decode Tones 17

Timeout 18

Decoded Tones

Response Time

RESULT

TX FM

Frequ 101.3000 MHz

Offset

Gen 1.0000 kHz

Ext/1kHz < 1.0000 kHz > OFF

Data 0.1538 kHz

20.0 mV

EIA

CALL + DECODE

Call Number 123456

Decode Tones 5

Timeout 1000 ms

Decoded Tones 1

Response Time 2

RESULT

Sequential Results 1.10

1	41	50	10
2	42	49	9
3	43	48	8
4	44	47	7
5	45	46	6
6	46	45	5
7	47	44	4
8	48	43	3
9	49	42	2
10	50	41	1

1-SHOT CONTIN 1.10 SYSTEM

Sequential Results 11.20

11	61	70	90
12	62	69	89
13	63	68	88
14	64	67	87
15	65	66	86
16	66	65	85
17	67	64	84
18	68	63	83
19	69	62	82
20	70	61	81

1-SHOT CONTIN 11.20 SYSTEM

AUTORUN

SYSTEM STND PARMS FREQ TIME

Duration, Pause (ms) EIA

1st	16	7	30
2nd	17	6	29
3rd	18	5	28
4th	19	4	27
5th	20	3	26
6th	21	2	25
7th	22	1	24
8th	23	0	23
9th	24	0	22
10th	25	0	21
11th	26	0	20
12th	27	0	19
13th	28	0	18
14th	29	0	17
15th	30	0	16

All Durations 30

All Pauses 34

Store to User Norm

AUTORUN

SYSTEM STND PARMS FREQ TIME

Frequency (Hz) ZVEI 1

0	8
1	9
2	10
3	11
4	12
5	13
6	14
7	15
8	16

Repeat Tone 17

Store to User Norm

PL/DPL

RX FM TX FM
 Frequ 1 2
 Offset
 Lev/500
 Gen 5 8
 Ext/1kHz <1.0000 kHz> OFF
 Data 7 OFF
 PL Common Tones 22
 x Free defined 23
 Deviation 20

DECODE SEND CLEAR PL DPL

RX FM TX FM
 Frequ 1 2
 Offset
 Lev/500
 Gen 6 8
 Ext/1kHz <1.0000 kHz> OFF
 Data 7 OFF
 DPL Encode 21
 Decoded
 Deviation 20

DECODE SEND CLEAR PL DPL

RX FM TX FM
 Frequ 150.0000 MHz 160.0000 MHz
 Offset +0.0 kHz
 Lev/500 -66.0 dBm
 Gen 1.0000 kHz 2.40 kHz
 Ext/1kHz <1.0000 kHz> OFF
 Data 0.1538 kHz OFF
 DPL Encode 071
 Decoded 1
 Deviation 4.00 kHz

DECODE SEND CLEAR PL DPL

RESULT

A/B TONE

RX FM
 Frequ 1
 Offset
 Lev/500
 Gen 5 OFF
 Ext/1kHz <1.0000 kHz> 15
 Data 6 OFF
 A/B Tone Encode
 A 19 B 20

x TONE	A	DLY	B	DLY
TN&VCE	0.40	0.00	0.20	1.00
USER	21	22	23	24

 I-SHOT CONTIN

DTMF

DTMF
 DTMF Generator
 Call Number 7
 Deviation 3
 Time 1
 Pause 2
 DTMF Analyzer
 Decode Tones 1
 Timeout 9
 Decoded Tones :
 SEND DECODE SINGLE

DTMF
 DTMF Generator
 Call Number 12345
 Deviation 2.4 kHz
 Time 35 ms
 Pause 0 ms
 DTMF Analyzer
 Decode Tones 5
 Timeout 1000 ms
 Decoded Tones : 1
 SEND DECODE SINGLE

RESULT

- A**
- A/B tone tester 5-82
 - AF frequency counter 5-43
 - AF generators 5-59 - 5-66
 - 1 kHz generator 4-8, 5-62
 - Block diagram 5-59
 - Generator GEN 5-60
 - AF measuring devices, available 5-41
 - AF power meter AF-Pwr 5-50 - 5-51
 - AF signal analysis 5-40 - 5-42
 - Block diagram 5-40
 - Connecting test signal 5-41
 - AF-PAR, menu 4-2 - 4-3
 - AF-PWR meter 4-2
 - Alr filter 3-6
 - Rinse 3-6
 - Automatic range switching 4-3
 - Automatic tuning 4-4
 - AUTORUN
 - Deleting program 9-23
 - Loading program 9-22
 - Mask callup 9-4
 - Programs 9-13
 - Saving program 9-21
 - Stopping 9-8
- B**
- Bandpass/bandstop, activation 4-12
 - Battery (option) Chapter 6
 - Bypassing power failure 1-17
 - Display of voltage 4-29
 - Power 1-16
 - Battery/line parallel powering 1-17
 - Block diagram E-8
 - Boards, internal 4-30
 - Burst frequency measurement 7-18
 - Bus structure (IEEE 488) 11-1
- C**
- C weighting filter 4-10
 - CALBRT, menu 4-31 - 4-36
 - CALIBRATION 1-19 - 1-22
 - Error message 1-22
 - Forced 1-22
 - Menu 1-17
 - Specific 1-21
 - Temperature-regulated 1-20
 - CCITT filter, activation 4-10
 - Centronics port 4-16
 - CHAN, menu 4-27
 - Channel numbers
 - Coding 4-22
 - Entering B-2
 - Hex/BCD coding 4-23
 - Saving 4-27
 - Channel setting, remote control 4-22
 - Channel spacing, definition 4-24
 - Character strings 8-15
- Control interface** 3-8
- Copying** 8-10
- D**
- Data module (option) Chapter 6
 - Data retention 1-18
 - DC voltmeter DC-VOLT 5-67
 - DC-VOLT meter 4-2
 - Declarations 1-2
 - DEMODO, output voltage 3-2
 - Direct command 9-6
 - Directories 8-6
 - Display field 9-6
 - Distortion factor meter DIST 5-48 - 5-49
 - Distortion meter DIST 4-13
 - DTMF module (option) Chapter 6
 - Duplex space, definition 4-24
 - Duplex synthesizer (option) Chapter 6
- E**
- Editing commands 9-10 - 9-11
 - Editing line 9-6
 - EMF/50 ohms switch 4-5
 - Entry
 - Correcting 2-7
 - Impermissible 2-7
 - Entry fields 2-5 - 2-11
 - EOI, control line 4-17, 11-4
 - EOS, control character 4-18, 11-3
 - Equipment 1-10
 - External modulation signal 4-8
 - External preattenuation, compensation 4-5
- F**
- File
 - Assigning name 8-14
 - Deleting 8-17
 - Renaming 8-15
 - Filter, in general 4-14
 - FILTER, menu 4-10 - 4-14
 - Formatting 8-3
 - Frequency deviation, weighted 4-3
 - Frequency measurement RF 5-22
 - Frequency measurement AF 5-43
 - Frequency measurement on RF bursts 7-18
 - Front panel
 - Declaration 3-1
 - Front panel foldout E-7
- H**
- HELP, function 2-15 - 2-16
 - Highpass filter, activation 4-11
 - Highpass/lowpass filters, combination 4-12
 - HW REV, menu 4-30
- I**
- IEEE-488
 - Bus 11-1
 - Commands 9-64 - 9-80, 11-10
 - Interface 4-17
- Output format** 11-8
- Settings** 11-3
- Test jobs** 9-72
- IF bandwidth, selection 4-6
- Interface, selection 4-15
- Interface IEEE/RS-232/keyboard (option) Chapter 6
- Interface Centronics/RS-232/keyboard (option) Chapter 6
- K**
- Keyboard, special characters 9-28
- L**
- LEDs
 - CCITT and LP/HP 4-14
 - Meaning 2-4
 - Line power 1-15
 - Line/battery parallel powering 1-17
 - Lowpass filter, activation 4-11
- M**
- Mask
 - Callup 2-2 - 2-4
 - Definition 1-3
 - Saving/loading 8-20
 - Memory card 8-2
 - Battery lifetime 8-2
 - Battery replacement 8-3
 - Copying 8-10
 - Formatting 8-8
 - Write protection 8-12
 - Memory locations on memory card 8-9
 - MEMORY mask 8-5
 - Menus
 - Definition 1-5
 - Examples for practice 1-8
 - Menu items 1-6
 - Microphone, external 4-9
 - MOD-PAR, menu 4-7 - 4-9
 - Modulation meter DEMODO 5-28 - 5-31
 - Elimination of superimposed noise 5-30
 - Peak-hold measurement 5-29
 - Modulation meter MOD 5-26 - 5-27
 - Modulation sensitivity 4-9, 5-63
 - Modulation signal
 - External 5-63
 - Overlaid signal 5-65
 - Modulation/demodulation, selection 4-7
 - Monitoring receiver 5-38 - 5-39
- N**
- NoL and NoU, meaning B-2
 - NoLU, menu 4-24 - 4-26
 - Notebook 2-24
- O**
- Offset measurement 5-20 - 5-21
 - Operands 9-17
 - Operator 9-17
- Options, installed 4-28
- Oscilloscope 5-52 - 5-58
- P**
- Parallel port 4-16
 - Pointer damping, setting 2-18
 - Port A 3-7
 - Port B 3-7
 - Power failure, bypassing 1-17
 - Power meter
 - AF 4-2
 - RF 4-4
 - Power supply 3-6
 - Print
 - Selecting printer 4-15
 - PRINT, menu 4-15 - 4-19
 - Printing 4-18
- Q**
- Quartz, correction 3-9
- R**
- Rear panel, Description 3-6 - 3-10
 - REDUCE RF POWER 1-13
 - Reference oscillator, adjustment 3-9
 - Relative level meter dB-REL 5-44 - 5-45
 - Relays, internal
 - Pinning 3-8
 - Setting/resetting 4-20
 - RELAYS, menu 4-20 - 4-23
 - Reset 3-3
 - RF frequency counter 5-22 - 5-23
 - RF input power, permissible 1-13 - 1-14
 - RF measuring devices, available 5-3 - 5-39
 - RF OFFSET counter 5-20 - 5-21
 - RF power meter 4-4, 5-24 - 5-25
 - RF socket, selection 3-1
 - RF-PAR, menu 4-4 - 4-6
 - RMS meter, callup 4-2
 - RS-232 parameter setup 4-16
 - RX standard measurements 5-18
 - RX/TX combination of frequencies 4-25
 - RX/TX switch, automatically 4-20
- S**
- Safety notes 1-11 - 1-12
 - Scope 5-52 - 5-58
 - Screen contents, saving 8-20
 - Selective-call tester 5-68 - 5-81
 - Callup 5-68
 - Carrier keying, continuous tone 5-77
 - Choosing mode 5-69
 - Connecting test item 5-70
 - Processing results 5-81
 - Results 5-80
 - Starting test cycle 5-78
 - Test parameters 5-71
 - Self-check 4-31
 - Serial number 4-28
 - Serial port (RS-232 C) 4-16

Index

Service check list	4-33
Service request	11-9
Setup	
Saving/loading	8-18
Store/recall	2-23
Signal generator	5-12 - 5-19
Compensation of preattenuation	5-15
Connecting RF output socket	5-16
Deactivation	5-12
Entries	5-13
Modulation parameters	5-14
Modulation test	5-17
Signal tone	2-7
SINAD meter	5-46 - 5-47
Softkeys	2-2
Software update	D-1
Software version	4-28
Special characters, keyboard	8-28
Spectrum analyzer	5-32 - 5-37
Spinwheel VAR	2-8
Squelch	4-6
Remote control (tested device)	4-21
RX special	4-21
Standard accessories	1-10
Station memory	5-38
Status line	8-7
STATUS, menu	4-28 - 4-29
STORE/RECALL, function	2-23
String	8-15
Operand	8-17
Variables	8-15
Symbols	1-2
System program, loading	8-23, 10-2
T	
Talk & listen, talk only	4-17
Test Instruments, available	2-12
Test jobs	8-72
Test receiver	5-4 - 5-11
Automatic tuning	5-6
Connecting RF input socket	5-8
Setting IF bandwidth	5-5
Setting squelch	5-5
Test setup	
Standard	5-2
typical examples	2-13
Total reset	1-18
TTL inputs/outputs	
Pinning	3-8
Setting/resetting outputs	4-22
Tuning frequency	5-4
TX standard measurements	5-10
U	
Unit	
Assigning values	2-9
Conversion	2-11
Upper indexes	1-2
V	
Variables in IEEE commands	9-14
Version status	4-30
Voltmeter RMS	5-43
W	
Weighting filter, activation	4-10
Write protection	8-12
Write-protect switch	8-4
Z	
ZOOM, function	2-17 - 2-22