

hp-3465A

OPERATING AND SERVICE MANUAL

MULTIMETER

3465A



hp-3465A

SECTION I

GENERAL INFORMATION

1-1. INTRODUCTION.

1-2. This section contains general information concerning the -hp- Model 3465A Multimeter. Included is an instrument description, specifications, information about instrument and manual identification, option and accessory information and safety considerations.

1-3. DESCRIPTION.

1-4. The -hp- Model 3465A Multimeter is a 4-1/2 digit, five function digital multimeter. The five functions are dc volts, ac volts, dc current, ac current and ohms. Measurements can be made to four significant digits with a sample rate of 2-1/2 readings per second. Throughout this manual, the 3465A Multimeter will be referred to as Multimeter.

1-5. SPECIFICATIONS.

1-6. Instrument specifications are listed in Table 1-1. These specifications are the performance standards or limits against which the instrument is tested. Any change in the specifications due to manufacturing, design or traceability to the U.S. National Bureau of Standards will be covered by revised pages to this manual. Additional information describing the operating characteristics are not specifications but are supplemental information for the user.

1-7. INSTRUMENT AND MANUAL IDENTIFICATION.

1-8. Hewlett-Packard uses a two-section serial number. The first section (prefix) identifies a series of instruments. The last section (suffix) identifies a particular instrument within the series. If a letter is included with the serial number, it identifies the country where the instrument was manufactured. This manual is kept up-to-date with the instrument at all times by revision. If the serial prefix of your instrument differs from the one on the title page of this manual, refer to Section VIII for backdating information that will adapt this manual to your instrument. All correspondence with Hewlett-Packard should include the complete serial number.

1-9. OPTIONS.

1-10. Multimeter options are available to provide alternate methods of powering the instrument. The standard instrument is powered by rechargeable NiCad batteries or can be powered from an ac source of 86 to 127 V or 172 to 254V, 48 to 66 Hz.

1-11. Option 001.

1-12. Option 001 allows ac line operation only. Power is derived from an ac source of 86 to 127 V or 172 to 254 V, 48 to 66 Hz. Two NiCad Battery Packs can be installed at any time to allow portable operation of the Multimeter.

1-13. Option 002.

1-14. Option 002 is powered by four "D" type dry cell batteries (U2 in Europe). Alternate power can be derived from most Hewlett-Packard hand-held calculator battery chargers such as the Model 82002A Battery Charger/AC Adapter through a special rear panel input connector.

1-15. Option 910.

1-16. The Option 910 is an additional Operating and Service Manual.

1-17. Warranty Exceptions.

1-18. Batteries are warranted for 90 days. "D" cell batteries are not warranted.

1-19. ACCESSORIES.

1-20. The following accessories are available to extend the usefulness of your Multimeter:

1. Model 11096A RF Probe, 100 kHz to 500 MHz (down 3 dB at 10 kHz and 700 MHz), for use on the 20 V and 200 V ranges in the DCV function only.
2. Model 11002A Test leads, dual banana to dual alligator.
3. Model 11003A test leads, dual banana to probe and alligator.
4. Submodule front handle, -hp- Part No. 5061-2001.
5. Model 11173A Handle Kit (Rack).
6. Rack adapter kit (includes 1/2 module filler), -hp- Part No. 5061-0054.
7. Nickel Cadmium Battery Pack (2 required) -hp- Part No. 00035-60024.
8. Model 82002A Battery Charger/AC Adapter, alternate power (battery elimination) for the Option 002 Multimeter.
9. 11129A Binding Post Kit.
10. Model 34111A HV Probe, 40 kV dc
11. Model 34112A Touch - Hold Input Probe

1-21. SAFETY CONSIDERATIONS.



1-22. This operating and service manual contains cautions and warnings alerting the user to hazardous operating and maintenance conditions. This information is flagged by a caution or warning heading and/or the symbol . The  symbol appears on the front panel and is an international symbol meaning "refer to the Operating and Service Manual". This symbol flags important operating instructions located in Section III. To ensure the safety of the operating and maintenance personnel and retain the operating condition of the instrument, these instructions must be adhered to.

Table 1-1. Specifications.

<p>DC VOLTMETER Ranges: 20 mV, 200 mV, 2 V, 20 V, 200 V, 1,000 V Maximum Input: 1,000 V (DC + Peak AC) Accuracy (1 year + 23°C ± 5°C):</p> <table border="1"> <thead> <tr> <th>Range</th> <th>Specification</th> </tr> </thead> <tbody> <tr> <td>20 mV</td> <td>± (0.03% of reading + 2 counts)</td> </tr> <tr> <td>200 mV through 200 V</td> <td>± (0.02% of reading + 1 count)</td> </tr> <tr> <td>1000 V</td> <td>± (0.025% of reading + 1 count)</td> </tr> </tbody> </table> <p>Temperature Coefficient (0°C to 50°C): ± 0.003% of Reading/°C Effective Common-Mode Rejection (with 1 kΩ imbalance in either lead): AC: > 120 dB at 50/60 Hz ± 0.1% AC Normal-Mode Rejection: > 60 dB at 50/60 Hz ± 0.1% Input Resistance: 20 mV through 2 V ranges: (80% R.H.) ≥ 10¹⁰ Ω 20 V through 1,000 V ranges: 10 MΩ ± 1%</p> <p>AC VOLTMETER Ranges: 200 mV, 2 V, 20 V, 200 V, 500 V (500 V Max) Overrange: The maximum reading decreases linearly from 19,999 at 10 kHz to 10,000 at 20 kHz. Accuracy: 1 year + 23°C ± 5°C)</p> <p>Temperature Coefficient (0°C to 50°C): ± (0.005% of Reading + .2 counts)/°C Input Impedance: 1 M ± 1% shunted by < 100 pF</p> <p>DC AMMETER Ranges: 200 μA, 2 mA, 20 mA, 200 mA, 2,000 mA Maximum Input: 2 A from < 250 V source Protection: 2 A/250 V fuse (normal blow) Voltage Burden:</p> <table border="1"> <thead> <tr> <th>Range</th> <th>Max Burden at Full Scale</th> </tr> </thead> <tbody> <tr> <td>200 μA — 200 mA</td> <td>< 250 mV</td> </tr> <tr> <td>2,000 mA</td> <td>< 700 mV</td> </tr> </tbody> </table>	Range	Specification	20 mV	± (0.03% of reading + 2 counts)	200 mV through 200 V	± (0.02% of reading + 1 count)	1000 V	± (0.025% of reading + 1 count)	Range	Max Burden at Full Scale	200 μA — 200 mA	< 250 mV	2,000 mA	< 700 mV	<p>Accuracy: 1 year + 23°C ± 5°C)</p> <table border="1"> <thead> <tr> <th>Range</th> <th>Specification</th> </tr> </thead> <tbody> <tr> <td>200 μA, 2 mA</td> <td>± (0.07% of reading + 1 count)</td> </tr> <tr> <td>20 mA</td> <td>± (0.11% of reading + 1 count)</td> </tr> <tr> <td>200 mA, 2000 mA</td> <td>± (0.6% of reading + 1 count)</td> </tr> </tbody> </table> <p>Temperature Coefficient (0°C to 50°C):</p> <table border="1"> <thead> <tr> <th>Range</th> <th>Specification ± (% of Reading)/°C</th> </tr> </thead> <tbody> <tr> <td>200 μA</td> <td>± 0.006%</td> </tr> <tr> <td>2 mA, 20 mA</td> <td>± 0.004%</td> </tr> <tr> <td>200 mA, 2,000 mA</td> <td>± 0.01%</td> </tr> </tbody> </table> <p>AC AMMETER Ranges: 200 μA, 2 mA, 20 mA, 200 mA, 2,000 mA Overrange: The maximum reading decreases linearly from 19,999 at 10 kHz to 10,000 at 20 kHz. Accuracy: (1 year, + 23°C ± 5°C)</p> <p>Temperature Coefficient (0°C to 50°C): ± 0.01% of Reading/°C. Protection: 2A/250 V fuse (normal blow) Voltage Burden:</p> <table border="1"> <thead> <tr> <th>Range</th> <th>Max Burden at Full Scale</th> </tr> </thead> <tbody> <tr> <td>200 μA — 200 mA</td> <td>< 250 mV</td> </tr> <tr> <td>2,000 mA</td> <td>< 700 mV</td> </tr> </tbody> </table> <p>OHMMETER Ranges: 200 Ω, 2 kΩ, 20 kΩ, 200 kΩ, 2,000 kΩ, 20 MΩ Accuracy: (1 year + 23°C ± 5°C)</p> <table border="1"> <thead> <tr> <th>Range</th> <th>Specification</th> </tr> </thead> <tbody> <tr> <td>200 Ω</td> <td>± (0.02% of reading + 2 counts)</td> </tr> <tr> <td>2 kΩ through 2 MΩ</td> <td>± (0.02% of reading + 1 count)</td> </tr> <tr> <td>20 MΩ</td> <td>± (.1% of reading + 1 count)</td> </tr> </tbody> </table> <p>Temperature Coefficient (0°C to 50°C):</p> <table border="1"> <thead> <tr> <th>Range</th> <th>Specification ± (% of Reading)/°C</th> </tr> </thead> <tbody> <tr> <td>200 Ω through 2 MΩ</td> <td>± 0.0015%</td> </tr> <tr> <td>20 MΩ</td> <td>± 0.004%</td> </tr> </tbody> </table>	Range	Specification	200 μA, 2 mA	± (0.07% of reading + 1 count)	20 mA	± (0.11% of reading + 1 count)	200 mA, 2000 mA	± (0.6% of reading + 1 count)	Range	Specification ± (% of Reading)/°C	200 μA	± 0.006%	2 mA, 20 mA	± 0.004%	200 mA, 2,000 mA	± 0.01%	Range	Max Burden at Full Scale	200 μA — 200 mA	< 250 mV	2,000 mA	< 700 mV	Range	Specification	200 Ω	± (0.02% of reading + 2 counts)	2 kΩ through 2 MΩ	± (0.02% of reading + 1 count)	20 MΩ	± (.1% of reading + 1 count)	Range	Specification ± (% of Reading)/°C	200 Ω through 2 MΩ	± 0.0015%	20 MΩ	± 0.004%
Range	Specification																																																		
20 mV	± (0.03% of reading + 2 counts)																																																		
200 mV through 200 V	± (0.02% of reading + 1 count)																																																		
1000 V	± (0.025% of reading + 1 count)																																																		
Range	Max Burden at Full Scale																																																		
200 μA — 200 mA	< 250 mV																																																		
2,000 mA	< 700 mV																																																		
Range	Specification																																																		
200 μA, 2 mA	± (0.07% of reading + 1 count)																																																		
20 mA	± (0.11% of reading + 1 count)																																																		
200 mA, 2000 mA	± (0.6% of reading + 1 count)																																																		
Range	Specification ± (% of Reading)/°C																																																		
200 μA	± 0.006%																																																		
2 mA, 20 mA	± 0.004%																																																		
200 mA, 2,000 mA	± 0.01%																																																		
Range	Max Burden at Full Scale																																																		
200 μA — 200 mA	< 250 mV																																																		
2,000 mA	< 700 mV																																																		
Range	Specification																																																		
200 Ω	± (0.02% of reading + 2 counts)																																																		
2 kΩ through 2 MΩ	± (0.02% of reading + 1 count)																																																		
20 MΩ	± (.1% of reading + 1 count)																																																		
Range	Specification ± (% of Reading)/°C																																																		
200 Ω through 2 MΩ	± 0.0015%																																																		
20 MΩ	± 0.004%																																																		

Table 1-2. General Information.

Maximum Input Voltages:		Nominal current through unknown resistance:	
Between Input HIGH (V, Ω) and COM:		RANGE	CURRENT
FUNCTION	MAX VOLTAGE	200 Ω	1 mA
DC Volts	1000 V (dc + peak ac)	2 K Ω	1 mA
AC Volts	600 V dc; 500 V ac rms; 800 V peak ac	20 K Ω	10 μ A
Ohms	350 V (dc + peak ac)	200 K Ω	10 μ A
		2000 K Ω	1 μ A
		20 M Ω	0.1 μ A
Between COM terminal and earth ground (\perp):		Power Requirements:	
\pm 500 V (dc + peak ac)		Standard	ac source: 86 to 127 V; 48 to 66 Hz 172 to 254 V; 48 to 66 Hz
Between AMPS (A) and COM terminals:			batteries: 2 rechargeable NiCad battery packs
\pm 350 V (dc + peak ac)		Option 001	ac source: 86 to 127 V; 48 to 66 Hz 172 to 254 V; 48 to 66 Hz
Amps Voltage Burden (nominal at full-scale):		Option 002	batteries: 4 "D" type dry cells (U-2 cells in Europe)
2000 m range: < 250 mV			battery elimination: Most Hewlett-Packard hand-held calculator chargers such as the Model 82002A Battery Charger/AC Adapter
All other ranges: < 125 mV		Option 910	An additional Operating and Service Manual.
Reading Rate: 2.5 samples per second		Environmental Considerations:	
Overload Indication: Display Blanks except for overrange "1" and decimal point (also polarity sign on DCV or DCA FUNC- TIONS).		Operating temperature: 0 $^{\circ}$ C to 55 $^{\circ}$ C (32 $^{\circ}$ F to 131 $^{\circ}$ F)	
Ohms Terminal Characteristics:		Humidity range: 95% at 40 $^{\circ}$ C	
Configuration: 2 wire		Storage temperature: -40 $^{\circ}$ C to +75 $^{\circ}$ C (-40 $^{\circ}$ F to 167 $^{\circ}$ F)	
Open-circuit voltage: < 5 V max.			
Overload protection: 350 V (dc + peak ac)			

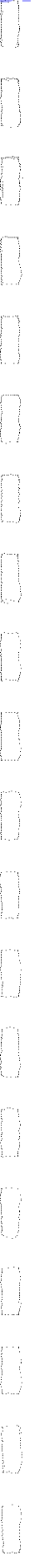

SECTION II

INSTALLATION

2-1. INTRODUCTION.

2-2. This section contains information and instructions for the installation and shipping of the Multimeter. Included are initial inspection procedures, power and grounding requirements, environmental information and instructions for repackaging for shipment.

2-3. INITIAL INSPECTION.

2-4. This instrument was carefully inspected both mechanically and electrically before shipment. It should be free of marks or scratches and in perfect electrical order upon receipt. To confirm this, the instrument should be inspected for physical damage in transit, and the electrical performance should be tested using the performance tests outlined in Section V. If there is damage or deficiency, see the warranty inside the front of this manual.

2-5. POWER REQUIREMENTS.

2-6. The Standard and Option 002 Multimeters have an internal battery source. In addition, either Standard or Option 002 instruments can be operated from any ac source of 86 V to 127 V or 172 V to 254 V at 48 Hz to 66 Hz. The Option 002 instrument requires the use of a Hewlett-Packard hand-held calculator Battery Charger/AC Adapter Model 82002A for instrument operation from the ac source.



Verify that the 110 V/220 V Line Voltage Selection switch, located on the rear panel of the Standard, Option 001 Multimeter or the Model 82002A Battery Charger/AC Adapter, is set to the ac source voltage to be used before inserting the power cord and turning the instrument on.

2-7. GROUNDING REQUIREMENTS.

2-8. To protect operating personnel, the National Electrical Manufacturers' Association (NEMA) recommends that the instrument panel and cabinet be grounded. The Standard and Option 001 Multimeters are equipped with a three-conductor power cable which, when plugged into an appropriate receptacle, grounds the instrument. The offset pin on the power cable is the ground wire.

2-9 ENVIRONMENTAL REQUIREMENTS.

2-10. The Multimeter should not be operated outside the ambient temperature range of 0°C to 55°C (32°F to 131°F) or stored outside the ambient temperature range of -40°C to +75°C (-40°F to 167°F).

WARNING

To prevent potential electrical or fire hazard, do not expose equipment to rain or moisture.

2-11. REPACKAGING FOR SHIPMENT.

2-12. The following paragraphs contain a general guide for repackaging the instrument for shipment. Refer to Paragraph 2-14 if the original container is to be used; 2-15 if it is not. If you have any questions, contact your nearest -hp- Sales and Service Office (see back of Manual for office locations).

NOTE

If the instrument is to be shipped to Hewlett-Packard for service or repair, attach a tag to the instrument identifying the owner and indicating the service or repair to be accomplished. Include the model number and full serial number of the instrument. In any correspondence, identify the instrument by model number and full serial number.

2-13. Place instrument in original container with appropriate packing material and seal well with strong tape or metal bands. If original container is not available, one can be purchased from your nearest -hp- Sales and Service Office.

2-14. If original container is not to be used, proceed as follows:

a. Wrap instrument in heavy paper or plastic before placing in an inner container.

b. Place packing material around all sides of instrument and protect panel face with cardboard strips.

c. Place instrument and inner container in a heavy carton or wooden box and seal with strong tape or metal bands.

2-15. POWER CORDS AND RECEPTACLES.

2-16. Figure 2-1 illustrates the standard power receptacle (wall outlet) configurations that are used throughout the United States and in other countries. The -hp- part number shown directly above each receptacle drawing is the part number for a Standard or Option 001 Multimeter power cord equipped with the appropriate mating plug for that receptacle. If the appropriate power cord is not included with the instrument, notify the nearest -hp- Sales and Service Office and a replacement cord will be provided. The Multimeter power cord, power input receptacle and mating connectors meet the safety standards set forth by the International Electrotechnical Commission (IEC).

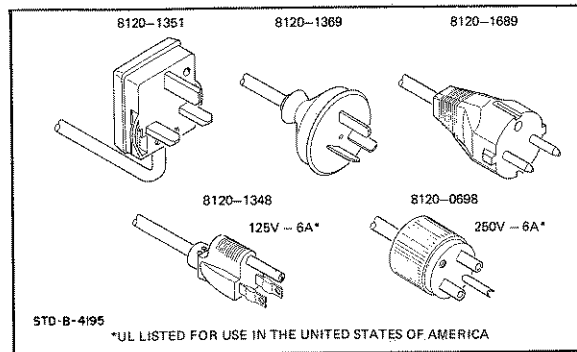
**Figure 2-1. Power Receptacles.**

SECTION III

OPERATING INSTRUCTIONS

3-1. INTRODUCTION.

3-2. This section contains instructions for using the Multimeter for making dc voltage, ac voltage, dc current, ac current and ohms measurements. The section also contains a description of the front and rear panel features.

WARNING

To prevent potential electrical or fire hazard, do not expose the Multimeter or its accessories to rain or moisture.

3-3. Front and Rear Panel Features.

3-4. An illustration and description of the front and rear panels is provided in Figure 3-1. All controls and connectors are identified and briefly described. Some rear panel features are available with certain options only and are identified in the description.

3-5. Turn-on and Warm-up.

3-6. For specified measurement accuracy, allow the instrument to warm-up for at least 10 minutes.

CAUTION

Before operating from an ac source, verify that the 110/220 V line voltage selection switch, located on the rear panel of the Standard and Option 001 Multimeter or the Model 82002A Battery Charger/AC Adapter, is set to the ac source voltage to be used.

3-7. Internal Battery Voltage Measurement and Recharging.

3-8. The Multimeter contains a feature allowing the user to check battery strength to determine the need for battery replacement or recharging. By setting the Multimeter to dc V Function and the 20 megohm range, the battery voltage is numerically represented on the Multimeter display. The decimal point must be moved one place to the right to derive the actual voltage level from the display (.370 = 3.70 V dc). If the battery voltage drops below a display of .300 (3 V), the Multimeter will automatically shut down. A fully charged standard Multimeter will display approximately .380. Fresh batteries in an Option 002 Multimeter will display approximately .600. Recharging of the NiCad batteries is performed by operating the Multimeter on an ac

source (verify line voltage selection switch is in correct position for source voltage used). Measurements can be made with the Multimeter operated from the ac source during the recharging period.

NOTE

After 14 hours, a completely discharged battery will be fully charged. Shorter charge periods will allow reduced battery operating time. There is no danger of overcharge. For convenience, overnight charging is recommended.

3-9. Low Battery Voltage Detection.

3-10. The Standard and Option 002 Multimeters contain an internal battery source (Standard contains rechargeable NiCads; Option 002 contains "D" cell or "U2" batteries). A battery source safety feature of the Multimeter is a low battery voltage detection circuit which turns the instrument off when battery voltage reaches a low level. This protects against cell reversal of the NiCad batteries. If during operation the display disappears or immediately after turn-on the display appears and disappears after several seconds, low battery voltage is indicated. To verify low battery voltage, the procedure described in the preceding paragraph can be used or verify by placing the OFF/ON switch to OFF and to ON again. The display will appear and again disappear. Operation from an ac line source and recharging of the NiCad batteries is required in a Standard instrument. Replacement of "D" cell or "U2" batteries is required in an Option 002 instrument.

NOTE

In protecting batteries and circuitry, the low battery voltage detection circuit may shut down the instrument if:

1. *the power switch is momentarily turned off then back on, or*
2. *if a live line power cord is attached to the instrument while it is operating in the battery mode.*

To restore normal operation, the instrument must be turned off with the front panel power switch for a minimum of 10 seconds.

3-11 Overload Indication.

3-12. The Multimeter is capable of displaying 19999 for all functions and ranges. There are maximum voltage limitations in DCV and ACV, however (see ac and dc voltage measurement paragraphs). In an overload condition where the input exceeds 19999, the last four digits blank and the

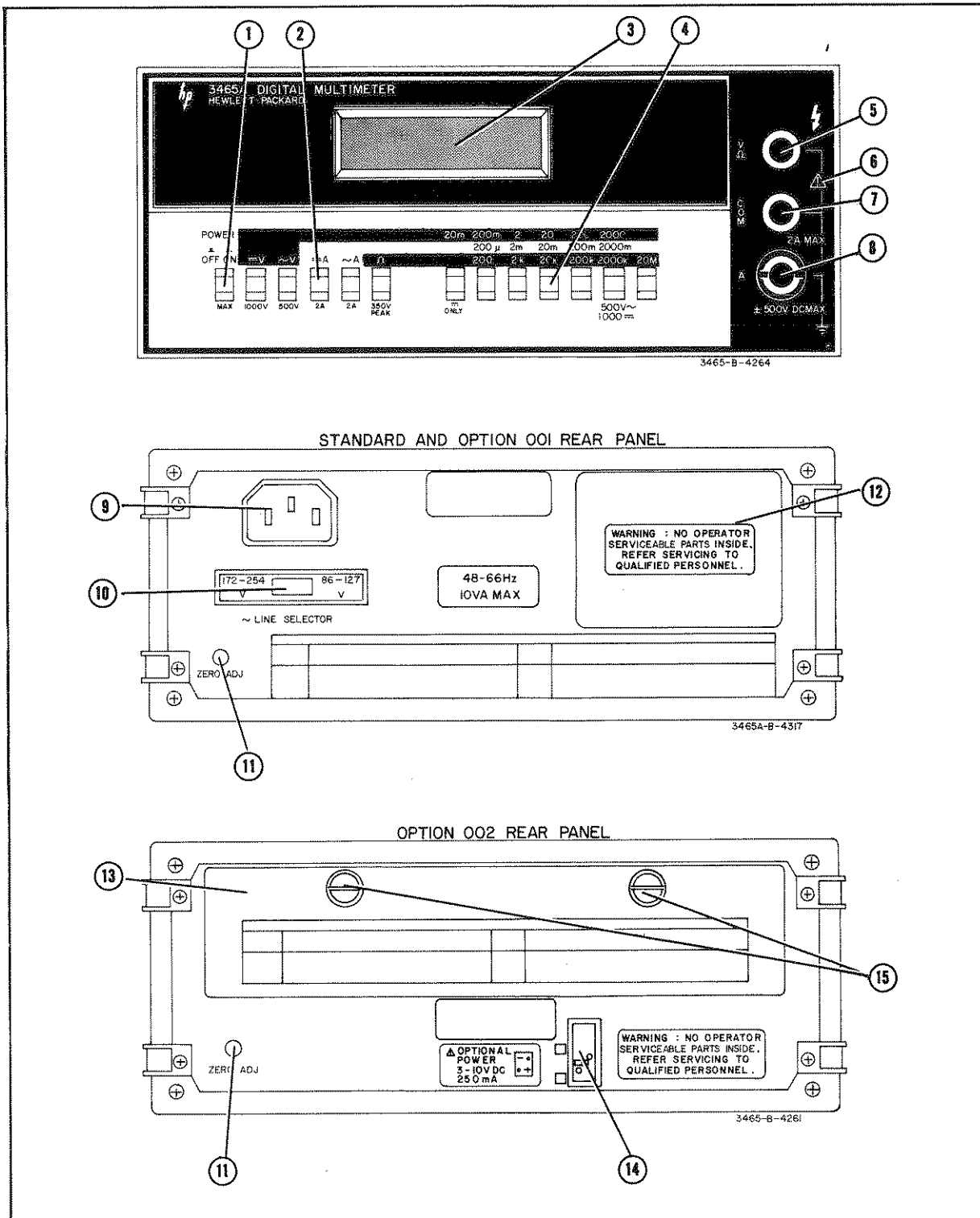

Figure 3-1. Front and Rear Panel Features.

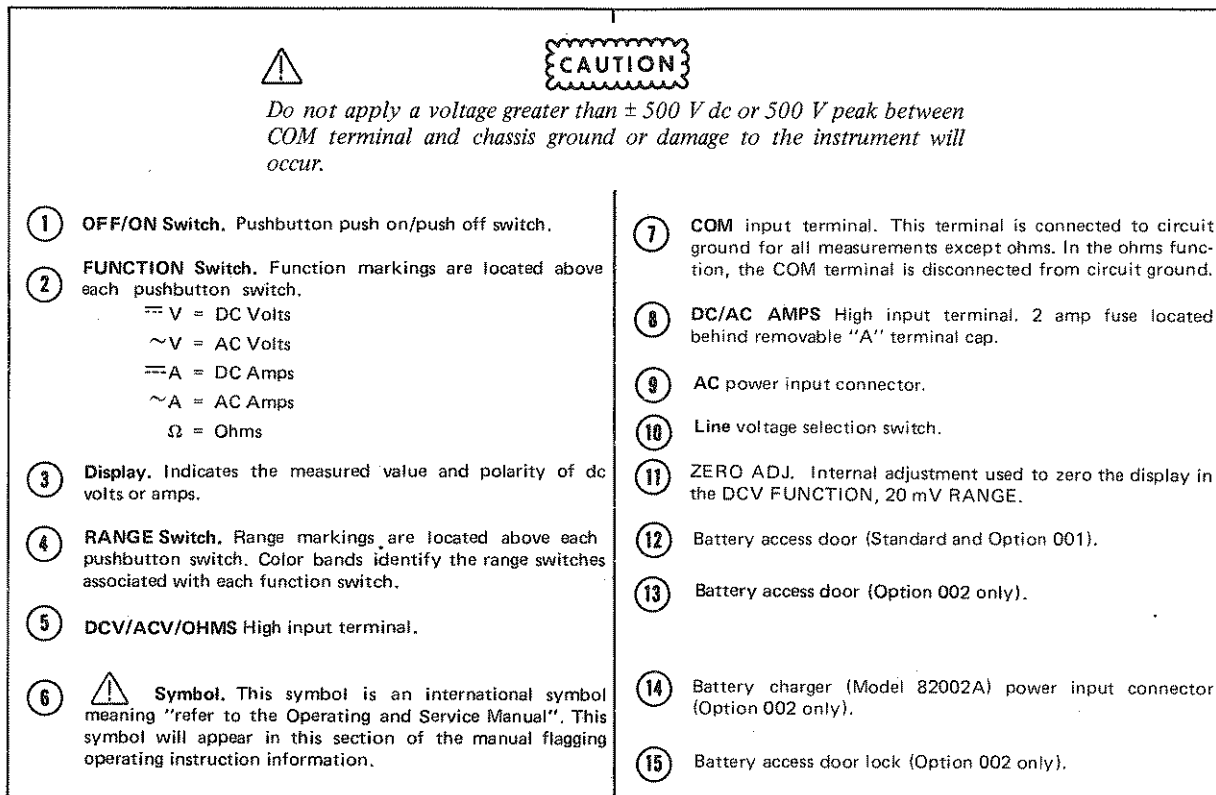

Figure 3-1. Front and Rear Panel Features (cont'd).

overrange "1" and decimal point will be displayed. The polarity sign is also displayed in the dc volts and dc current functions in the overload condition.

3-13. AC VOLTAGE MEASUREMENTS.



Maximum input voltage in the ACV FUNCTION is 500 V rms, 800 V peak and 600 V dc. Do not exceed these voltages or damage to the instrument will occur.

3-14. AC VOLTAGE Ranges.

3-15. The ACV FUNCTION has five ranges from 200 mV to 500 V. Each range has a maximum display reading of 19999. However, the 500 V range is limited to a maximum ac input voltage of 500 V.

3-16. DC VOLTAGE MEASUREMENTS.

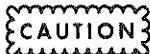

Do not exceed a maximum input voltage of 1000 V (dc + peak ac) on the 1000 V range or damage to the instrument will occur. There is no overrange capability on the 1000 V range.

3-17. 20 mV Range Zero Adjust.

3-18. When using the Multimeter on the 20 mV range in DC volts, short the input terminals and zero the Multimeter display with the rear panel ZERO ADJ control (see Figure 3-1). The display should indicate 0.000 before proceeding with measurements.

3-19. DC Voltage Ranges.

3-20. DC Voltage measurements can be made from 20 mV to 1000 V full-range. Each range has a maximum display reading of 19999. However, the 2000 V range is limited to maximum input of 1000 V dc and peak ac (see DC Voltage measurements caution in Paragraph 3-16).

3-21. CURRENT MEASUREMENTS.



Do not exceed a maximum input voltage of 350 V dc and peak ac or a maximum dc or ac rms input current of 2 A or the amps fuse, located directly behind the "A" terminal, will open. See the following paragraph for replacement instructions.

3-22. The Multimeter is protected from the application of excessive current by a 2 A fuse located directly behind the front panel "A" terminal. If it is necessary to replace this fuse, use the side slots on the "A" terminal to rotate the terminal. The terminal and fuse will protrude from the front panel. Remove the terminal and fuse, replace fuse with a 2 A rated fuse as listed in Table 6-3 Miscellaneous Parts General, and designated F1.

3-23. AC Current Ranges.

3-24. AC current measurements are specified over a frequency range of 40 Hz to 20 kHz. There are five current ranges from 200 μ A to 2000 mA. See current measurements Caution in Paragraph 3-21.

3-25. DC Current Ranges.

3-26. DC Current measurements can be made on five current ranges from 200 μ A to 2000 mA. See current measurements caution in Paragraph 3-21.

3-27. OHMS MEASUREMENTS.



CAUTION

Do not apply voltage greater than ± 350 V dc +

Peak AC between the ohms and common input terminals in the ohms function or damage to the instrument will occur.

3-28. Ohmmeter Ranges.

3-29. Resistance measurements can be made on six ranges from 200 ohms to 20 megohms. Both input terminals (Ω and COM) are floating with respect to circuit ground.

3-30. Ohmmeter Reference Current.

3-31. The ohmmeter reference current through the unknown resistance for each range is shown in Table 3-1.

Table 3-1. Ohmmeter Current Through Unknown.

Range	Current Through Unknown
200 Ω	1 mA
2 k Ω	1 mA
20 k Ω	10 μ A
200 k Ω	10 μ A
2000 k Ω	1 μ A
20 M Ω	0.1 μ A

Maximum open-circuit voltage at the ohms input terminals is less than 5 V.