

5180A Waveform Recorder

General Information
Installation
Operation and Programming

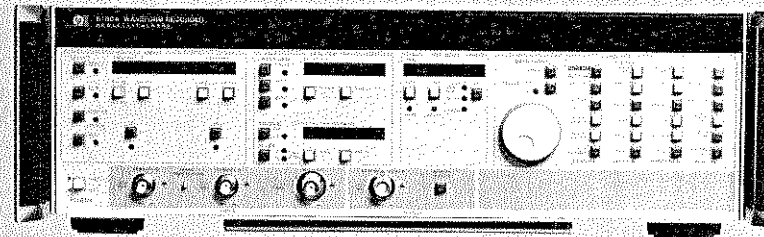

OPERATING AND PROGRAMMING MANUAL

CERTIFICATION

Hewlett-Packard Company certifies that this product met its published specifications at the time of shipment from the factory. Hewlett-Packard further certifies that its calibration measurements are traceable to the United States National Bureau of Standards, to the extent allowed by the Bureau's calibration facility, and to the calibration facilities of other International Standards Organization members.

WARRANTY

This Hewlett-Packard instrument product is warranted against defects in material and workmanship for a period of one year from date of shipment. During the warranty period, Hewlett-Packard Company will, at its option, either repair or replace products which prove to be defective.

For warranty service or repair, this product must be returned to a service facility designated by HP. Buyer shall prepay shipping charges to HP and HP shall pay shipping charges to return the product to Buyer. However, Buyer shall pay all shipping charges, duties, and taxes for products returned to HP from another country.

HP warrants that its software and firmware designated by HP for use with an instrument will execute its programming instructions when properly installed on that instrument. HP does not warrant that the operation of the instrument, or software, or firmware will be uninterrupted or error free.

LIMITATION OF WARRANTY

The foregoing warranty shall not apply to defects resulting from improper or inadequate maintenance by Buyer, Buyer-supplied software or interfacing, unauthorized modification or misuse, operation outside of the environmental specifications for the product, or improper site preparation or maintenance.

NO OTHER WARRANTY IS EXPRESSED OR IMPLIED. HP SPECIFICALLY DISCLAIMS THE IMPLIED WARRANTIES OF MERCHANTABILITY AND FITNESS FOR A PARTICULAR PURPOSE.

EXCLUSIVE REMEDIES

THE REMEDIES PROVIDED HEREIN ARE BUYER'S SOLE AND EXCLUSIVE REMEDIES. HP SHALL NOT BE LIABLE FOR ANY DIRECT, INDIRECT, SPECIAL, INCIDENTAL, OR CONSEQUENTIAL DAMAGES, WHETHER BASED ON CONTRACT, TORT, OR ANY OTHER LEGAL THEORY.

ASSISTANCE

Product maintenance agreements and other customer assistance agreements are available for Hewlett-Packard products.

For any assistance, contact your nearest Hewlett-Packard Sales and Service Office. Addresses are provided at the back of this manual.

MANUAL CHANGES

CHANGE DATE: February 23, 1984

This change supersedes all earlier dated changes.

*** Make all corrections listed under ERRATA before making other changes.

*** Check following table for your instrument's serial prefix or series number and make listed change(s) to manual.

```

* * * * *
* INSTRUMENT:      HP 5180A
*                   Operating and
*                   Programming Manual
*
* SERIAL PREFIX:  2210A
*
* DATE PRINTED:   JAN 1982
* HP PART NO:     05180-90001
* * * * *

```

INDICATES NEW OR REVISED ITEM

> INDICATES ACTION TO BE TAKEN

SERIAL PREFIX OR SERIES NUMBER	MANUAL CHANGE(S)	SERIAL PREFIX OR SERIES NUMBER	MANUAL CHANGE(S)
2210A	1		
2220A	1,2		
2222A	1 - 7		
2224A	1 - 8		
2224A	1 - 9		
2230A	1 - 10		
2232A	1 - 11		
2238A	1 - 12		
2240A	1 - 13		
2250A	1 - 14		
2250A00531	1 - 15		
2311A00541	1-8, 10-16		
2318A	1 - 17		
2324A00671	1 - 18		
2327A	1 - 19		
2329A	1 - 20		
#2404A	1 - 21		

Information for any optional circuit boards described in this manual agrees with the series numbers on the circuit board(s) for the option, which may not be the same as the Serial Prefix Number on the rear of the instrument.

- (C5180AOP) 1=13665, 13633/2=14180/3=14202/4=13444/5=14227/6=13589/7=13632
- 8=14416/9=14416/10=13630, 13467/11=14427/12=14567/13=14552/14=14579, 13867, 14892,
- 14875/15=14555/16=14880, 14902/17=13631, 15025, 15041, 15055/18=14874, 14878/
- 19=15330/20=14603, 14908, 15069/21=15752, 15774, 15700



ENHANCEMENTS SUMMARY

1. FAST SWEEP/OUTPUT MODE (FSO)-High Speed DMA Mode (See Pages 11 thru 14 for details)
A new Direct Memory Access (DMA) process is added to the 5180A that is faster than the standard 5180A DMA process (FAST O). This process is the Fast Sweep Output (FSO). The FSO DMA operates in the output mode only. In this mode of operation the FSO continuously alternates the sweep of digitized waveforms with output through the DMA port to a controlling device at 5180A's fastest repetition rate. The FSO mode is controlled by the use of HP-IB commands, not by front panel controls. By sending the command FM1 over the HP-IB before initiating Direct Memory Access the 5180A will repeatedly measure and DMA with less than 3.5 ms (DMA plus dead time- for 1K Record Length) between measurements.
2. Auto Advance Continuous (See Pages 14 thru 15 for details)
AUTO ADVANCE CONTINUOUS differs from the current "regular" AUTO ADVANCE only in that the AUTO ADVANCE CONTINUOUS will keep sequencing measurements through memory records until there is an external command to terminate. Hence, this new front panel command allows capturing the last sweep in a number of measurements where it is not known when the last event will occur.
3. Sweep-Plot Combinations (HP-GL Paging Plotters) (See Pages 15 thru 17 for details)
Four combinations of Sweep followed by Plot are added to the 5180A. All four combinations require a HP-GL paging plotter such as the HP 7245A and the HP 9872S. Each of the four new functions are accessed by a different setting of the HP-IB Address Switch on the rear panel of the 5180A.
4. Sweep-Plot Combinations (Strip Chart Recorders) (See Pages 17 thru 19 for details)
New front panel commands are available to produce strip chart plots directly. To provide for continuous plotting of the data recorded by the 5180A onto a strip chart recorder, five combinations of sweep and plot functions identical to those available for HP-GL plotters are implemented.
5. Additional HP-IB Input/Output Commands (See Pages 19 thru 22 for details)
Eight additional HP-IB Input /Output commands were added to conform to new IEEE Standard 728-1982. Four commands provide full range binary format data input and output. Four others provide two's complement data I/O.
6. HP-IB Identification Commands (See Page 22 for details)
Two commands are being added that will output information to identify that a 5180A is attached to the HP-IB.



ERRATA

Page 1-2, Table 1-1, Model 5180A Specifications:

#>Delete "(20 Degrees C to 30 Degrees C)" reference in the title of the two tables labeled "Dynamic Performance3..." "

>Change the Arm Delay specification to read as follows -
Arm Delay: Selectable 0.18 s, 0.25 s to 99 seconds in 0.25 second increments.
An arm delay of 7 ms is available in Auto Advance only. Controls time between measurements.

Page 1-3, Table 1-1, Model 5180A Specifications (Continued)

TIMEBASE: External timebase in (rear panel): in second line.

>Change ratios of 1 to 1-6 to 1 to 10-6.

HIGH SPEED INPUT/OUTPUT (DMA rear panel connector):

>Add "When transferring data from the controller into the 5180A over DMA, an even number of samples is required."

Page 1-4, Table 1-1, Model 5180A Specifications:

Under "Power Requirements"

>Change "Max power dissipation 400 watts" to read "Max power consumption is 500 VA"

Page 2-1, Paragraph 2-11:

>Change "...less than 400 volt amperes" to read "no more than 500 volt amperes".

Page 2-3, Figure 2-2, Setup Switches, Normal Positions:

>Replace the A11 Timebase Option Switch Setup with the following figure:

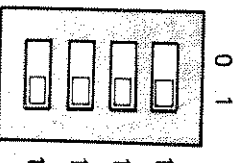

A11 TIMEBASE OPTION
SWITCH SETUP

Page 2-6, Figure 2-3, 10873 Rack Mount Contents:

>Change part number of Item #8 from 2570-0194 to 2510-0194.

Page 3-9, Paragraph 3-39.

>Change the last sentence to read as follows:
"... is variable from 7 ms to 99 seconds."

Page 3-21, Paragraph entitled "Arm Delay":

>Change in line 6: ARM DELAY values range from 7 ms.

>Change in line 11: IN AUTO ADVANCE, minimum time is 7 ms.

>Add after the NOTE -

When the 5180A front panel indicates an arm delay of 5 ms, the actual arm delay is 180 ms. When in Auto Advance, the actual arm delay is 7 ms.

ERRATA (Cont'd)Page 3-30, Paragraph AUTO ADVANCE:

>Change in line 15: ARM DELAY is zero to ARM DELAY is 7 ms.

>Change in line 16: ARM DELAY is non zero to ARM DELAY is >7 ms.

Page 3-37, REAR PANEL CONTROLS AND CONNECTORS (Cont'd):

Under **Level**, right-hand side of page:

>Change -1 volt to -1.2 volt.

>Change +1.8 volt to +1.3 volt.

Page 3-56, Paragraph 3-169:

>Change the AD<f>n definition to read as follows:

Set the ARM DELAY in seconds. ARM DELAY is selectable to .18 s and .25 s to 99 seconds in .25 second increments, 7 ms available in AUTO ADVANCE mode.

>Change Minimum Value to: 0.18 s. In AUTO ADVANCE 7 ms.

Page 3-63, Table 3-15, Summary of HP-IB Commands

>Change the ARM DELAY to read as follows:

Select Arm Delay for	AD<f>n	180 ms, 0.25 to 99 seconds
Sweep Mode		(Increment = 0.25 s)
		7 ms available in AUTO ADVANCE

CHANGES 1 thru 4 and 6,7.

NOTE - These changes do not affect the operating and programming manual or the operation of the 5180A Waveform Recorder. See Service Manual.

CHANGES 5

Page 1-2, Table 1-1. Model 5180A Specifications CHANNEL A AND B INPUTS:

>Change Amplifier Bandwidth to (-3dB NOMINAL)

>Change Input Impedance 1M ohm II <35pF (all other ranges) to
1M ohm II 40pF (all other ranges).

CHANGE 8

***** THE SOFTWARE REVISION CHANGES FROM 1.2 TO 1.3 *****

X-Y SPEED changes from a minimum value of 100 ms to 50 ms, affecting the following pages of the Operating and Programming Manual:

Page 2-7, Paragraph 2-39.

>Change "100" to "50"

Page 3-31, Paragraph entitled X-Y SPEED:

>Change "100" to "50".

Page 3-59, Paragraph entitled SP<<f>n>:

>change "100" to "50".

Page 3-34. The CLD annunciator on the front panel is deactivated.

>Delete paragraph entitled CLD.

Page 3-29, Paragraph entitled TR1-TR2 add the following:

The TR1-TR2 (analysis) mode can be used for trace records made during CHOP A,B mode only when TR1 equals TR2 (both point to the same CHOP record). An attempt to activate TR1-TR2 when TR1 is not equal to TR2 will result in error code display Er15.00.

In TR1-TR2 (analysis) mode, to point from one CHOP record to another, in either local or remote control, change TR1 TRACE LOCATION. The TR2 TRACE LOCATION will track automatically and error 15.00 should not occur.

Page 3-40, Table 3-2. Error Messages:

>Add Er15.00 TR1 not equal TR2 in CHOP records, TR1-TR2 mode.

Page 1-3, Table 1-1. TIMEBASE Sample Interval:

>Add Sample Interval Accuracy:

Internal Reference Accuracy X Number of Samples X Sample Time.

Page 1-4, Table 1-1, Paragraph entitled Available Display Cursors:

>Add Cursor Accuracy:

Single Timebase: Equal to Sample Interval Accuracy.

Page 3-7, Paragraph 3-33. At the end of the second sentence ...50ns precision:
>Add (see specifications under Cursor Accuracy in Table 1-1).

CHANGE 8 (Cont'd)

Page 3-25, Paragraph entitled TOGGLE:

>Change first two sentences to read: TOGGLE differs from MIXED only when position is negative. In this mode, the MAIN timebase is used until the trigger occurs.

>Change the next to last sentence to read: The double-trigger cursor will also be visible when in MIXED or **TOGGLE** with a positive trigger position.

Page 3-30, Paragraph entitled AUTO ADVANCE:

>Add the following:

The AUTO ADVANCE key is a toggle function that sets the AUTO ADVANCE "on" (enable) or "off" (disable). When the key is pressed to the disable position, the main display will be:

AAXOFF (where x=blank)

The above display indicates AUTO ADVANCE "off" (disabled). When AUTO ADVANCE is disabled as a result of aborting a measurement, the main display will be:

AAXAbt (where x=blank)

The above display indicates AUTO ADVANCE abort.

If AUTO ADVANCE is "off" (disabled) and the 5180A is making a sweep (a long sweep or waiting for a trigger) and the AUTO ADVANCE key is pressed to the "on" position (enabled) the following occurs:

- a. The sweep is terminated.
- b. TRIGGER SWEEP ARM mode is set to SINGLE.
- c. AUTO ADVANCE mode is enabled and the main display will be:

AUTO(n) (where=n=current RECORD LOCATION)

Page 3-22, TRIGGER SECTION (Cont'd)

>Insert the following NOTE between the paragraphs entitled %FS and %HYS.:

NOTE

The %FS range for the trigger is a function of both input channel (CHA, CHB) range and INT/EXT trigger source. Always select both the input and the INT/EXT trigger source before setting the trigger level or hysteresis.

MANUALS FOR THE INSTRUMENTS WITH THE FOLLOWING SERIAL NUMBERS HAVE CHANGE 8

2044A00102	2220A00282	222A00304
00103	00287	00305
00106	00288	00306
00116	00294	00307
00119	00296	00308
00122		00309
		00310

CHANGE 9

Page 1-4, Table 1-1, Paragraph entitled Available Display Cursors:
>Add Cursor Accuracy:

Mixed Timebase: For cursor measurements made across timebases with MAIN or DELAY TIMEBASE set to 50 ns, the measurement error is based upon the slower of the MAIN or DELAY sample time as follows:

(Single Timebase) + or - (Slower Sample Time + 100 ns)

CHANGE 10

>Change the instrument serial prefix in your manual to 2230A.
This change affects only the Service manual.

CHANGE 11

>Change the instrument serial prefix in your manual to 2238A.
This change affects only the Service manual.

CHANGE 12

>Change the instrument serial prefix in your manual to 2238A.
This change affects only the service manual.

CHANGE 13

>Change the instrument serial prefix in your manual to 2240A.
This change affects only the service manual.

CHANGE 14 and 15

>Change the instrument serial prefix in your manual to 2250A.
This change affects only the service manual.

CHANGE 16

>Change the instrument serial prefix in your manual to 2311A.
This change affects only the service manual.

CHANGE 17

>Change the instrument serial prefix in your manual to 2318A.
This change affects only the service manual.

CHANGE 18

THESE ARE CHANGES AND ADDED FEATURES THAT WERE BROUGHT ABOUT BY FIRMWARE REVISION 1.4 .

Page 1-2, Table 1-1. Model 5180A Specifications:

- >Change Input Impedance (NOMINAL) specifications to read as shown below:
1M ohm II 40 pF (10V range). 1M ohm II 35 pF (all other ranges).

- >Add double asterisks (**) in the Dynamic Performance (20 degrees to 30 degrees) table, as shown below:

Test	RANGE	Nominal Sine Wave Amplitude	1 MHz Test Frequency	Nominal Frequency 10 MHz
DFT-spurious 4	+1V	2V p-p	< -52 dBc **	< - 48 dBc **
		0.2V p-p	< -60 dBc	< - 60 dBc

- > Add footnote at the bottom page 1-2 as shown below:

** DFT spurious relative to 2V peak to peak test sine wave carrier.

- >Change Arm Delay specification to read as follows:

Arm Delay: Selectable 7 ms, 0.18 s, 0.25 s to 99 seconds in 0.25 second increments. Controls the time between measurements.

Page 1-3, Table 1-1. Model 5180A Specifications (Continued):

- >Change, under TIMEBASE, Sample Interval Accuracy "Sample Time" to "Sample Rate".
- >Change in two places, under ANALOG OUTPUT MODES, "XY Recorder" to read "Strip Chart and XY Recorders".
- >Add, under HEWLETT-PACKARD INTERFACE BUS, in Special Functions specification ", continuous plot." to the first sentence.

Page 1-4, Table 1-1. Model 5180A Specifications:

- >Add to end of Paragraph describing Available Display Cursors the following sentence:
Cursor accuracy is equal to sample interval accuracy.

- >Add, in paragraph entitled Auto Advance, to the first sentence the following as shown below:
and halts at highest record location.

- >Add, between Auto Advance and Trigger Time, the following:

Continuous Auto Advance: Cycles Auto Advance until operator halts procedure.

Page 1-5, Paragraph 1-25:

- >Add "strip chart recorder" to the first sentence.

CHANGE 18 (Cont'd)

Page 1-6, Paragraph 1-33:

>Add, between paragraphs 1-33 and 1-34, the following paragraph as shown below:

The 10875A (4.8 metres, 15.8 feet) and the 10875B (1 metres, 3.28 feet) are identical DMA cables (except for length) that provide an interface between the 5180A and 9826 controllers.

Page 2-7, Paragraph 2-37:

>Change in the last sentence "(Addresses 50-52)" to "(Addresses 50-56)".
>Add four address settings as shown below:

Address 53: HP-GL output that enables plot and page after each Sweep.
Used with 7245A and 9872S paging plotters.

Address 54: HP-GL output that enables plot and page in sequence all the record locations from current to last. Used with 7245A and 9872S paging plotters.

Address 55: HP-GL output that enables plot and page after each sweep in the Auto Advance mode. Used with 7245A and 9872S paging plotters.

Address 56: HP-GL output that enables plot and page in sequence after an Auto Advance all the record locations filled by the Auto Advance Mode. Used with 7245A and 9872S paging plotters.

Page 2-7, Paragraph 2-39:

>Change the first sentence to read "When the CRT/PLOT switch is set for PLOT, addresses 52 through 56 will operate Strip Chart recorders. Any other valid addresses will operate XY recorders."
>Change "100" to "150".
>Change "400" to "700".

Page 3-7, Paragraph 3-33.

>Add, at the end of the second sentence, "(See specifications under Cursor Accuracy in Table 1-1.)."

Page 3-12, Paragraph 3-56:

>Change, in the example program, statement "MP50e-9" to "MM 50e-9".
>Change in NOTE "(MP)" to "(MM)".

Page 3-21, Paragraph entitled ARM DELAY:

>Delete the last sentence "In AUTO ADVANCE, minimum time is 7ms".
>Add the sentence "Arm Delay of 7 ms prompts a special CRT display "Ad 7ms" in place of measurement data.

Page 3-21, Paragraph entitled POSITION:

>Change in last sentence "5" to "7".

Page 3-28, Paragraph CAL/UNCAL:

>Add to the end of the fifth sentence "(while in SWEEP ARM, Single)."

CHANGE 18 (Continued)

Page 3-30, Paragraph AUTO ADVANCE:

>Add the following paragraphs as shown below:

The AUTO ADVANCE key is a toggle function that sets the AUTO ADVANCE "on" (enable) when pressed the first time. The second time it is pressed AUTO ADVANCE CONTINUOUS is enabled, the SWEEP ARM is forced to SINGLE, and the message "AAc n" is displayed. When the AUTO ADVANCE key is pressed a third time the AUTO ADVANCE modes are disabled; and, the main display will be:

AAxOFF (where x=blank)

The above display indicates AUTO ADVANCE "off" (disabled). When AUTO ADVANCE disabled as a result of aborting a measurement, the main display will be:

AAxAbt (where x=blank)

The above display indicates AUTO ADVANCE abort.

AUTO ADVANCE CONTINUOUS. AUTO ADVANCE CONTINUOUS differs from regular AUTO ADVANCE only in that AUTO ADVANCE CONTINUOUS will keep sequencing measurements through memory records until there is an external command to terminate.

Page 3-31, Paragraph entitled X-Y SPEED:

>Change "100" to "150"; and "400 to "700".

Page 3-35:

>Add to the Messages and Meaning listing the following as shown:

Message	Meaning
AA Abt	The AUTO ADV function is aborted.
AA OFF	The AUTO ADV function is disabled.
AAc n	The AUTO ADV CONTINUOUS function is in progress. (n represent number of record location)
FSo	The Fast Sweep/Output (DMA) is in progress.
nREc	Waiting for the next record' measurement in sweep plot.
Strip	The Strip Chart output is in progress.

NOTE

The operand 'n' represents the number of the record location.

CHANGE 18 (Continued)

Page 3-39, Paragraph 3-100:

>Add discriptions to the following Error Categories, as shown below:

11	Fast Sweep Output error
12	Shift-Auto Advance pushed and HP-IB address not 55 or 56

Page 3-40, Table 3-2, Error Messages:

>Add the following as shown below:

DISPLAY	SPECIFIC ERROR CONDITIONS
Er11.01	"FM1" received in Auto Advance mode
Er11.02	Return to local-FSO Aborted
Er12.yy	Shift-Auto Advance pushed and HP-IB address not 55 or 56

Page 3-47, Paragraph 3-129:

>Add Automatic advance continuous to the list of MEMORY CAPABILITIES as shown below:

c. Automatic advance continuous.
d. Trigger time recording.

Page 3-48, Paragraph 3-135:

>Add the following two sentences as show below:

Pressing SET ZERO will give negative trigger time until a valid trigger occurs. The negative time represents the time from the previous trigger to when SET ZERO is pressed.

Page 3-53, Table 3-14, Address Selection:

>Change, in SELECTED ADDRESS column, "52" to "52-56".

>Change, under NOTE, the last sentence to read "PLOT would generate outputs for either X-Y or Strip Chart recorders."

Page 3-56, Paragraph 3-170:

>Change the AD<fnp> definition to read as follows:

Set the ARM DELAY in seconds. ARM DELAY is selectable to .7 ms, .18 s, and .25 s to 99 seconds in .25 second increments.

>Change Minimum value to 7ms.

Page 3-58, after AA1:

>Add the following HP-IB Memory Command and description as shown below:

AA2 Set Auto Advance Continuous. Cycles Auto Advance until operator halts procedure.

Page 3-59, Paragraph 3-179:

>Change, in description of SP<fnp>, "100" to "150"; and "400" to "700".

Page 3-60:

CHANGE 18 (Continued)Page 3-60:

>Change, in paragraph entitled OT<fpn>, the example output to read as shown below:

sa2,pt-25.6E-06,ad180.0E-03,se0,s10,lv 000.0E-03,hv160.0E-03,

>Change "OX" to "OX<fpn>".

>Delete the second and third sentences in paragraph describing OX.

>Add, in paragraph entitled OM, after the last sentence the following two sentences as shown below:

No record location specification is necessary. This outputs current information.

Page 3-61, Paragraph entitled OA<fpn>:

>Change "ad 190.E-03" to ad 180.E-03"; "s10" to "s10"; and

"lv 000.0E-03" to "lv 000.0E-03".

Page 3-62:

>Add the following HP-IB Input/Output and Identification Commands:

LB<block no.>

Two's complement binary format. Send a complete block of data from the controller to the 5180A. The block is sent to the 5180A as a parameter. Data is sent as 16-bits, two's complement integers.

LS<block no.>,<addr>,<num>

Two's complement binary format. Send less than one block of data from the controller to the 5180A. The parameters to be sent specify a selective address and the number of words.

KB<block no.>

Full range binary format. Send one block of data in full range (i.e., 0 < range < 1023) from the controller to the 5180A.

KS<block no.>,<addr>,<num>

Full range binary format. Send a partial block of data (i. e., 0 < range < 1023) from the controller to the 5180A. The parameters specify the block number, the selective address and the number of words.

SB<block no.>

Two's complement binary format. Transfer a selective block of data from the 5180A to the controller. Data is sent as 16-bit, two's complement integers.

SS<block no.>,<addr>,<num>

Two's complement binary format. Transfer a selected block of data from the 5180A to the controller. The parameters specify the block number, the selective address and the number of words.

CHANGE 18 (Continued)

Page 3-62:

UB<block no.>

Full range binary format. Transfer a full block of data in the full range (i.e., 0 < range < 1023) from the 5180A to the controller.

US<block no.>,<addr>,<num>

Full range binary format. Transfer a partial block of data in the full range (i.e., 0 < range < 1023) from the 5180A to the controller. The parameters to be specified are the block number, the selective address and the number of words.

HP-IB Identification Commands

ID

The ID command provides an ASCII string consisting of the Model Number, followed by the ROM revision code, and ending with carriage return/linefeed.

Example: 5180A, ROM 1.4 <cr><lf>

IE

The IE command provides a single binary byte output equal to binary code for decimal 80:
01010000

HP-IB DMA Control Commands

FM1

Initiate Fast Sweep and DMA Output (FSO)

FMO

Disable Fast Sweep and DMA Output (FSO)

Page 3-63 and 3-65, Table 3-15. Summary of HP-IB Commands:

>Change "5ms" to "7ms"

>Change "100" to "150"; and "400" to "700".

Page 3-66, Paragraph 3-189:

>Change in the second sentence "(addresses 50-52)" to read "(addresses 50-56)".

>Add four address settings as shown below:

Address 53: HP-GL output that enables plot and page after each Sweep. Used with 7245A and 9872S paging plotters.

Address 54: HP-GL output that enables plot and page in sequence all the record locations from current to last. Used with 7245A and 9872S paging plotters.

Address 55: HP-GL output that enables plot and page after each sweep in the Auto Advance mode. Used with 7245A and 9872S paging plotters.

Address 56: HP-GL output that enables plot and page in sequence after an Auto Advance all the record locations filled by the Auto Advance Mode. Used with 7245A and 9872S paging Plotters

CHANGE 18 (Continued)

Page 3-66, Paragraph 3-190:

- >Change in first sentence "X-Y recorders" to read "X-Y and Strip Chart recorders".
- >Change in last sentence "100" to "150"; and "400" to "700".
- >Attached the following text to your 5180A O/P Manual:

DETAILED DESCRIPTION of the SIX NEW ENHANCEMENTSFAST SWEEP/OUTPUT MODE

The Fast Sweep/Output (FSO) mode is a Direct Memory Access (DMA) process that is faster than the standard 5180A DMA process (FAST 0). The FSO DMA operates in the output mode only. In this mode of operation the FSO continuously alternate the sweep of digitized waveforms with output through the DMA port to a controlling device at 5180A's fastest repetition rate. The FSO mode is controlled by the use of HP-IB commands, not by front panel controls.

The FSO mode is enabled or disabled by HP-IB commands, whereas the standard DMA is controlled by a transfer request signal from the DMA device. The sequence of DMA control and data transfer is the same for each process.

10872A and 10875A/B Interface Cables

The 10872A Interface cable consists of a 90832A I/O interface with a special cable and is used with controllers such as the 9825. The 10875A or 10875B DMA cable is designed to connect the 5180A to controllers such as the 9826. The two cables (10875A and B) are identical except that the length of the 10875A is 4.8 metres (15.8 feet) and the 10875B is 1 metre (3.28 feet).

Control

The FSO mode is controlled by a DMA device that incorporates both HP-IB and DMA circuits. The basic sequence of operation is as follows:

1. Send code "FM1" on the HP-IB to enable FSO.
2. Read the desired number of waveforms via 5180A DMA port.
3. Send code "FM0" on the HP-IB to disable FSO.

Front Panel Display

During FSO operation, the front panel main display on the 5180A will be FSO (For standard DMA operation, the display will be FAST I during input, and FAST O during output.) The ARM, TRG, and all other annunciators will function during FSO as usual.

Record Location

The currently active RECORD LOCATION will be used repeatedly for all waveforms digitized during FSO mode. No record advance will occur (as in AUTO ADVANCE mode).

CHANGE 18- FSO (Continued)

FSO is usually interrupted and terminated by the "FM0" HP-IB command while in the process of making a sweep. The XYZ display will show part of the interrupted sweep and part of the previous complete sweep after "FM0" is received by the 5180A.

XYZ Control

For sweep times less than 1 second, the XYZ output is disabled. For sweep times greater than or equal to 1 second, the XYZ output is not disabled. UPDATE mode will be active unless the user has sent "EN0" via HP-IB. Normal XYZ output resumes at the conclusion of FSO mode, by executing "EN1" from within the 5180A when "FM0" is received. This means that any "EN0" the user had in effect is cancelled when "FM0" is sent via HP-IB. If "EN0" is used, the user should wait until the HP-IB status byte indicates a change from "busy" to "ready". This ensures the 5180A has executed the XYZ image update task to process the "EN0" request. The HP 9825/9826 HPL code for this is:

```
wrt 704, "SA1,EN0"
if bit ("1xxxx",rds (704)); gto + 0
```

NOTE

"SA1" is required or the 5180A will remain busy continuously. The controller can reinstate "SA2" or "SA3" at the conclusion of the test, if required.

Auto Advance

If the AUTO ADVANCE mode is in effect when the 5180A receives the "FM1" code on the HP-IB, the AUTO ADVANCE mode will be terminated. FSO mode will not be initiated. The error code 11.01 will be displayed in the main display.

Sweep Arm

All sweep arm modes are allowed (SINGLE, AUTO, NORM). The SINGLE mode will function the same as the NORM mode. This is consistent with the nature of the FSO process which, in effect, keeps the measurement (sweep) process continuously active. Thus, the SINGLE mode acts as if the SINGLE key was pressed once each sweep/DMA cycle. As with the NORM mode, there must be a trigger from the input signal to have a sweep.

Arm Delay

The ARM DELAY function is allowed with some modifications. In the FSO process, ARM DELAY applies to the SINGLE sweep arm mode as well as to NORM and AUTO. Also, the ARM DELAY values of 7 ms and 180 ms are not used (treated as 0) by FSO. These two values each have special meaning in regular sweep process, but the nature of the FSO process is such that these special meanings do not apply. The ARM DELAY values are interpreted as including the FSO cycle (loop) time, but trigger level wait, sweep, TRFQ wait and DMA transfer times are additive.

CHANGE 18- FSO (Continued)

Data Entry Control Knob (Rotary Pulse Generator)

The DATA ENTRY control (RPG) is deactivated by HP-IB code "FM1". This prevents interrupts associated with the RPG.

HP-IB Status Byte

The RECORDING status bit is set on (1) immediately prior to trigger enable, and off (0) at end of sweep. The MEASUREMENT COMPLETE status bit is set on (1) at end of sweep and off (0) after the controller activates TRFQ in the 5180A (e.g. "eir 2, 1"). This allows the controller to handshake with the 5180A if desired. The HP 9825/9826 HPL code to accomplish this handshake is as follows:

```
0->Y
oni 7,"srq"
eir 7
    "h-shake":if Y=0;gto +0
    "h-shake2":0->Y
    "start DMA xfer":rdi 4->A
eir 2,1
tfr 2,"adc",1024
    "srq":rds (704)->A
    if bit(2,A)=1;1>Y
eir 7;iret
```

Front Panel Operation

If the UNLOCK/LOCAL key on the front panel is used to return the 5180A to the LOCAL state, the FSO mode will terminate ("FM0" is simulated). Error code 11.02 will be displayed. This occurs also if the HP-IB is used to place the 5180A in the LOCAL state (e.g., "lcl 704"). The check for a panel status change to LOCAL occurs just after ARM DELAY is complete and before the sweep. The check is made once each sweep/DMA cycle.

Error Codes

Error codes that will be displayed during FSO mode are as follows:

Code	Error
11.01	AUTO ADVANCE mode in effect when HP-IB code FM1 is received by the 5180A.
11.02	5180A front panel placed in LOCAL state.

CHANGE 18- FSO (Continued)

The following HP 9825/9826 HPL program sequence can be used to capture error information via HP-IB:

```
dim A$[180]
0->X
oni 7,"srq"
eir 7
wrt 704,"SR1"    enable error SRQ interrupts
.
.
wto 2,0
wtl 7,0          end of DMA input sequence
"DMAdone":gsb "ckerr"
if X->0;gto "end"
```

NOTE

The "srq" routine should not perform the sending of OE and the reading of A\$, because the possibility exists that the srq interrupt occurred prior to label "DMAdone", while the controller and the 5180A are still in the DMA sequence. The 5180A is not available for HP-IB processing until the DMA sequence is complete.

```
.
.
"end":end
```

AUTO ADVANCE CONTINUOUS

AUTO ADVANCE CONTINUOUS differs from the current "regular" AUTO ADVANCE only in that the AUTO ADVANCE CONTINUOUS will keep sequencing measurements through memory records until there is an external command to terminate. Hence, this new front panel command allows capturing the last sweep in a number of measurements where it is not known when the last event will occur.

To engage AUTO ADVANCE CONTINUOUS, the AUTO ADVANCE push button will be used. The first time pushed, regular AUTO ADVANCE is enabled (as before). The second time it is pushed AUTO ADVANCE CONTINUOUS is enabled, the SWEEP ARM is forced to SINGLE, and the message "AAc n" is displayed. As in regular AUTO ADVANCE, 'n' represents the number of the first RECORD LOCATION that will be used for the first measurement. If the button is pushed a third time all AUTO ADVANCE modes are turned off.

From HP-IB, the command "AA2" will be used to activate AUTO ADVANCE CONTINUOUS.

AUTO ADVANCE CONTINUOUS measurements will take place as in regular AUTO ADVANCE whereby measurements are sequenced from a given location to the next higher location, but when the last location is reached, the sequence will restart at record location 1 and continue to cycle indefinitely.

CHANGE 18- AUTO ADV CONTINUOUS (Continued)

During the measurement, the front panel displays the message "AAc n" where n' is the current measurement record location. When ARM DELAY is set to 7 msec only "AAc" will be displayed during the measurements. The word "LAST" will never be displayed.

Several front panel keys or HP-IB commands will abort AUTO ADVANCE CONTINUOUS mode. Abortion is indicated by the message "AA Abt" or by some new display replacing the "AAc n" message.

HPGL or STRIP CHART outputs (SHIFT, AUTO ADVANCE) will work with regular AUTO ADVANCE only. There is no output available with AUTO ADVANCE CONTINUOUS.

SWEEP-PLOT COMBINATION (HP-GL PAGING Plotters)

Four combinations of Sweep followed by Plot are added to the 5180A functions. All four combinations require an HP-GL paging plotter such as the HP 7245A or HP 9872S. Each of the four new functions is activated by a selected setting of the HP-IB ADDRESS switch on the rear panel of the 5180A.

The four new functions are as follows:

1. Sweep followed by plot. In this function, the 5180A will plot and page after each sweep.
2. Plot all record locations in sequence. In this function, the 5180A will plot and page, in sequence, all the record locations from current to last.
3. Auto advance with plot and page mode. In this function, the 5180A performs a plot and page after each sweep in the Auto Advance mode.
4. Auto advance followed by plot records in sequence. In this function, the 5180A performs plot and page in sequence, after an Auto Advance, all record locations filled by the Auto Advance mode.

These four new functions do not modify the basic sweep or plot capability of the 5180A. The functions merely link the sweep and plot processes together in four different ways.

Sweep Followed by Plot

Set the HP-IB ADDRESS switch on the rear panel to 53, and press the OUTPUT key on the front panel to activate this mode. The 5180A will take a sweep, plot it and page the plotter. The sequence of sweep, then plot is repeated until the UNLOCK/LOCAL key is pressed. The user has control over the content of the first plot record because a new sweep is taken after the OUTPUT key is pressed.

CHANGE 18- SWEEP- PLOT (HP-GL Paging plotters) (Continued)

If the TRIGGER SWEEP ARM is set to SINGLE or NORM, the 5180A main display will show "nrEc" (wait next record) before each sweep, and will show "OutPut" during plotting. If the TRIGGER SWEEP ARM is set to AUTO, then only "OutPut" will be displayed. During the time that "nrEc" is displayed, the front panel is unlocked, and sweep setup changes such as RANGE, DELAY, etc., may be made before initiating the sweep with SINGLE, MANUAL TRIGGER, etc. While "OutPut" is displayed the front panel is locked. The content and format of the plot is identical to that obtained with a setting of 52 of the HP-IB ADDRESS switch. This mode may be aborted during plot or sweep activity by pressing UNLOCK/LOCAL.

If a trigger is not available when OUTPUT is pressed and the 5180A is in NORM SWEEP ARM TRIGGER mode, a trigger will be required. This trigger is required to allow the sweep measurement routine to complete its task before the Sweep Followed by Plot mode will be initiated. When it is, the cycle starts with a sweep.

Plot All Record Locations in Sequence

Set the HP-IB ADDRESS switch on the rear panel to 54 and press the OUTPUT key on the front panel to activate this mode. The 5180A will then plot and page each record in sequence, starting with current TRACE 1 LOCATION through the last TRACE 1 LOCATION. The content and format of the plot is identical to that obtained with a setting of 52 for the HP-IB ADDRESS switch. When the OUTPUT key is pressed, the TRIGGER SWEEP ARM mode is forced to SINGLE. Otherwise, the last record location may be overwritten with new sweep data at conclusion of the last record plot. This mode may be aborted during plot activity by pressing the UNLOCK/LOCAL key.

Auto Advance With Plot and Page Mode

Set the HP-IB ADDRESS switch on the rear panel to 55 and press SHIFT-AUTO ADVANCE. The 5180A will then perform the Auto Advance function in a normal manner, with a plot after each sweep. During Auto Advance activity, "Auto n" appears in the main display and the PANEL LOCK light is off. During plot activity, "OutPut" appears in the main display, and the PANEL LOCK light is on. At the conclusion of the last plot, "LAST" appears in the main display. The content and format of the plot is identical to that obtained with a setting of 52 for the HP-IB ADDRESS switch. This mode may be aborted during plot or Auto (sweep) activity by pressing the UNLOCK/LOCAL key. When SHIFT-AUTO ADVANCE is pressed, bit 1 of the SRQ status byte is set (Enable SRQ on OUTPUT key). If the HP-IB ADDRESS switch does not read 55 or 56 when SHIFT-AUTO ADVANCE is pressed, the main display will show Er 12.XX. The xx will be the value obtained from the HP-IB ADDRESS switch. As with other error conditions, the SHIFT key must be pressed to allow the 5180A to continue. If the TRIGGER ARM DELAY is set to 5 ms, when SHIFT-AUTO ADVANCE is pressed, the entire sequence of records is taken in the Auto Advance mode before plotting starts. In this case, only the last RECORD LOCATION is plotted.

CHANGE 18 SWEEP-PLOT (HP-GL Paging Plotters) (Continued)

Auto Advance Followed by Plot Records in Sequence

Set the HP-IB ADDRESS switch on the rear panel to 56 and press SHIFT-AUTO ADVANCE. The 5180A will then perform the Auto Advance function in a normal manner with the front panel PANEL LOCK light off. The main display shows the normal Auto Advance sequence of "Auto n", "Auto n+1", etc. Then the PANEL LOCK light comes on, "OutPut" appears in the main display, and all records taken in during the Auto Sequence activity are plotted in sequence on the paging plotter. The first record location plotted is the first one recorded by the Auto Advance activity. At the conclusion of plot activity, "LAST" appears in the main display. This mode may be aborted during plot or AUTO (sweep) activity by pressing the UNLOCK/LOCAL key. When SHIFT-AUTO ADVANCE is pressed, bit 1 of the SRQ status byte is set (Enable SRQ on OUTPUT key). If the ADDRESS switch does not read 55 or 56 when SHIFT-AUTO ADVANCE is pressed, the main display will show Er 12.xx. The xx will be the value obtained from the HP-IB ADDRESS switch setting. Press the SHIFT key to release the error condition.

Error Code Summary

If SHIFT-AUTO ADVANCE is pressed and the HP-IB ADDRESS switch is not set to 55 or 56, the error code 12.xx will show in the main display. The xx will be the value obtained from the HP-IB ADDRESS switch setting.

SWEEP-PLOT COMBINATIONS (Strip Chart Recorders)

To provide for continuous plotting of the data recorded by the 5180A onto a strip chart recorder, five combinations of sweep and plot functions identical to those available for the HP-GL plotters are implemented. The data will have the same vertical gain and offset as what the CRT displays.

Chop mode will be displayed as two consecutive plots with Channel A followed by Channel B. DUAL TRACE displays will only plot trace 1. However, by setting HP-IB address to 54, multiple records can be plotted. Record separation is by a gap at the end of each record.

To engage the strip chart mode of output, the PLOT/CRT switch at the back of the 5180A must be set to PLOT. The HP-IB ADDRESS switch at the rear panel must be set to the appropriate address, (52, 53, 54, 55, or 56) depending on the combination of sweep and plot desired. The 5180A will acknowledge the strip chart recording request by displaying "Strip". If an output plot is requested, but the HP-IB address is not any of the strip chart codes, then the 5180A will display "rCdr" and do a single xy-recorder plot.

The following combinations of sweep and strip chart plot are available:

1. Strip Chart Plot Once
When the HP-IB address switch on 5180A rear panel is set to 52, and the CRT/PLOT switch is set to PLOT, the Sweep-Plot once mode is

CHANGE 18 -SWEEP-PLOT (Strip Chart Recorders) (Continued)

enabled. To activate this mode, simply press OUTPUT. The 5180A will take previously recorded data and plot it onto the strip chart recorder.

2. Sweep Followed by Strip Chart Plot

When the HP-IB address switch on the 5180A rear panel is set to address 53 and the CRT/PLOT switch is set to PLOT, the sweep-strip chart record mode is enabled. To activate this mode, simply press the OUTPUT key. The 5180A will take a sweep, do a strip chart record sequentially until the UNLOCK/LOCAL button is pressed. A new sweep is taken after the OUTPUT key is pressed. This provides the user with control over the content of the first record. If the Trigger Sweep Arm mode is set to SINGLE or NORM, 5180A's main display will show "nrEc" (wait next record) before each sweep, and "Strip" during plotting. If the Trigger Sweep Arm mode is set to AUTO, then only "Strip" will be displayed. During the time that "nrEc" is on display, the 5180A front panel is unlocked, and sweep setup changes such as range, delay, etc., may be before initiating the sweep with SINGLE, MANUAL TRIGGER, etc. While "Strip" is displayed, the front panel is locked.

If the OUTPUT key is pressed when the 5180A is in the NORM Trigger Sweep Arm mode and no trigger is available, a trigger is required to allow the sweep measurement routine to complete its task before the sweep followed by plot' mode will be initiated. When it is, the cycle starts with a sweep.

3. Plot All Record Locations in Sequence

When the HP-IB ADDRESS switch on the 5180A rear panel is set to address 54, and the CRT/PLOT switch is set to PLOT, the plot-in-sequence mode is enabled, starting with the current TRACE 1 LOCATION. This mode is activated by pressing the OUTPUT key. The 5180A will then plot each record in sequence through the last TRACE LOCATION. When the OUTPUT key is pressed, the Trigger Sweep Arm mode is forced to SINGLE. Otherwise, one record location may be overwritten with new sweep data at the conclusion of the last record plot.

4. Auto Advance with Plot Mode

When the HP-IB ADDRESS switch on the 5180A rear panel is set to address 55, the CRT/PLOT switch is set to PLOT, the Auto Advance with Plot and Page mode is enabled. To activate this mode, press SHIFT-AUTO ADVANCE. The 5180A performs the Auto Advance function in a normal manner with a plot after each sweep. During Auto Advance activity, "Auto n" appears in the main display, and the PANEL LOCK light is off. During Plot activity, Strip' appears in the main display, and PANEL LOCK light is on. At the conclusion of the last plot, LAST' appears in the main display. When SHIFT-AUTO ADVANCE is pressed, bit 1 of the SRQ status byte is set (Enable SRQ

CHANGE 18 -SWEEP-PLOT (Strip Chart Recorders) (Continued)

on OUTPUT key). If the HP-IB ADDRESS switch does not read 55 or 56 when SHIFT-AUTO ADVANCE is pressed, the main display will show "Er 12.xx" until the UNLOCK/LOCAL key is pressed. The 'xx' will be the value obtained from the HP-IB ADDRESS switch. If TRIGGER ARM DELAY is set to 7 ms, when SHIFT-AUTO ADVANCE is pressed, the entire sequence of records is taken in the AUTO ADVANCE mode before plotting begins. In this case, only the last TRACE LOCATION is plotted.

5. Auto Advance Followed by Plot Records in Sequence

When the HP-IB ADDRESS switch on the 5180A rear panel is set to address 56, and the CRT/PLOT is set to PLOT, the Auto Advance Followed by Plot in Sequence mode is enabled. To initiate this mode, press SHIFT-AUTO ADVANCE. The 5180A performs the Auto Advance activity in normal fashion with the 5180A front panel PANEL LOCK light off. The large display shows the normal Auto Advance sequence of "Auto n", "Auto n+1", etc. Then the PANEL LOCK light is turned on, "Strip" appears in the large display, and all records taken in during the Auto Sequence activity are plotted in sequence. The first RECORD LOCATION plotted is the first one recorded by the Auto Advance activity. At the conclusion of Plot activity, "LAST" appears in the main display. This mode is abortable during Plot or AUTO (sweep) activity by pressing the UNLOCK/LOCAL key. When SHIFT-AUTO ADVANCE is pressed, bit 1 of SRQ status byte is set (Enable SRQ on OUTPUT key). If the HP-IB address switch does not read 55 or 56 when SHIFT-AUTO ADVANCE is pressed, the large display will show "Er 12.xx" until the UNLOCK/LOCAL key is pressed. The 'xx' will be the value obtained from the HP-IB ADDRESS switch.

ADDITIONAL HP-IB INPUT/OUTPUT COMMANDS

In order to conform with the IEEE Standard 728-1982, eight input/output HP-IB commands have been added to the program code set of the 5180A. Two of the input commands and two of the output commands are in two's complement binary format, and the same number of commands are in full binary format. Data are sent over the HP-IB in the following format:

#I[...data in bytes.....]

where the last byte of data is sent with an EOI.

In two's complement binary format, a 10-bit word is sent as follows:

First Byte: [S S S S S S D9 D8]

Second Byte: [D7 D6 D5 D4 D3 D2 D1 D0]

where S=extended sign
1=negative sign
0=positive sign

CHANGE 18- HP-IB I/O COMMANDS (Continued)

In full range binary format, a 10-Bit word is sent in two sequential bytes as follows:

First Byte: [0 0 0 0 0 0 D9 D8]

Second Byte: [D7 D6 D5 D4 D3 D2 D1 D0]

Input Commands

The following are additional input commands:

LB<block no.>

Two's complement binary format. Send a complete block of data from the controller to the 5180A. The block is sent to the 5180A as a parameter. Data is sent as 16-bits, two's complement integers.

LS<block no.>,<addr>,<num>

Two's complement binary format. Send less than one block of data from the controller to the 5180A. The parameters to be sent specify a selective address and the number of words.

KB<block no.>

Full range binary format. Send one block of data in full range (i.e., 0 < range < 1023) from the controller to the 5180A.

KS<block no.>,<addr>,<num>

Full range binary format. Send a partial block of data (i.e., 0 < range < 1023) from the controller to the 5180A. The parameters specify the block number, the selective address and the number of words.

An example of a line to transfer data from the 9825 to the 5180A:

wtb 704, "kb1," or wtb 704, "ks1,1,512,"

using the comma or semicolon as the delimiter. This is because the controller usually sends both the carriage return and linefeed following an ASCII write to the 5180A. The carriage return will be interpreted as the delimiter, and the linefeed will be interpreted as the first byte of data. Thus, at least one byte of data at the end of the block will be lost.

Partial block transfer is made possible by using selective commands. Two parameters must be specified in addition to the block number. They are the starting address (addr) and the number of points (num).

CHANGE 18- HP-IB I/O COMMANDS (Continued)Output Commands

The following are additional output commands:

SB<block no.> Two's complement binary format. Transfer a selective block of data from the 5180A to the controller. Data is sent as 16-bit, two's complement integers.

SS<block no.>,<addr>,<num> Two's complement binary format. Transfer a selected block of data from the 5180A to the controller. The parameters specify the block number, the selective address and the number of words.

UB<block no.> Full range binary format. Transfer a full block of data in the full range (i.e., 0 < range < 1023) from the 5180A to the controller.

US<block no.>,<addr>,<num> Full range binary format. Transfer a partial block of data in the full range (i.e., 0 < range < 1023) from the 5180A to the controller. The parameters to be specified are the block number, the selective address and the number of words.

An example of a line to transfer the 5180A to the controller:

```
wtb 704, "ub1," or wtb 704, "us1,1,512,"
```

using the delimiter as described under the input commands example.

PROGRAMMING EXAMPLES

The following are a few 9825 programs to illustrate possible applications using the new input and output commands.

Input Commands examples:

```
Example #1
11: dsp "full range binary IEEE block input"
12: dim A[1024]; fxd 0
13: for I=1 to 1024
14:   int(I)->A[I]
15: next I
16: wtb 704, "kb1,"
17: wtb 704, "#I"
18: for I=1 to 1024
19:   dsp "full range binary write to 5180"
20:   wtb 704, int(A[I]/256)
21:   wtb 704, int(A[I])
22: next I

- WRITE A RAMP
- FOR 2S COMP INPUT, USE "1b1,"
```

CHANGE 18 -ADDITIONAL HP-IB I/O COMMANDS (Continued)

Example #2

```

11: dsp "full range binary IEEE selective input"
12: dim A[1024]; fxd 0
13: for I=1 to 1024
14: int(I)->A[I]
15: next I
16: wtb 704, "ks1, 512, 512," - FOR 2'S COMP, USE "1s..."
17: wtb 704, "#I"
18: for I=1 to 512
19: wtb 704,int(A[I]/256)
20: wtb 704,int(A[I])
21: next I
    
```

Output Commands examples:

Example #1

```

11: dsp "full range binary IEEE block output"
12: wrt 704,"ub1," - FOR 2'S COMP, USE "sb1.."
13: rdb(704)->A;prt char(A) - READ "#" FROM 5180
14: rdb(704)->A;prt char(A) - READ "I" FROM 5180
15: for I=1 to 1024
16: rdb(704)*256+rdb(704)->A
17: dsp "ub",I,A
18: next I
    
```

Example #2

```

11: dsp "full range binary IEEE selective output"
12: wrt 704,"us1,256," - FOR 2'S COMP, USE "ss..."
13: rdb(704)->A;prt char(A) - READ "#" FROM 5180
14: rdb(704)->A;prt char(A) - READ "I" FROM 5180
15: for I=1 to 256
16: rdb(704)*256+rdb(704)->A
17: dsp "us",I,A
18: next I
    
```

HP-IB IDENTIFICATION COMMANDS

Two commands are added that will output information to identify that a 5180A is attached to the HP-IB.

The ID command will provide an ASCII string consisting of the Model Number, followed by the ROM revision code, and ending with carriage return/linefeed.

Example: 5180A, ROM 1.4 <CR>LF

The IE command will provide a single binary byte output equal to binary code for decimal 80:

01010000

CHANGE 19

>Change the instrument serial prefix in your manual to 2327.
This change affects only the Service Manual.

CHANGE 20

>Change the instrument serial prefix in your manual to 2329.
This change affects only the Service Manual.

#CHANGE 21

>Change the instrument serial prefix in your manual to 2404.
This change affects only the Service Manual.

Postage
Will be Paid
by
Addressee

No
Postage Stamp
Necessary
If Mailed in the
United States

BUSINESS REPLY MAIL

FIRST CLASS PERMIT NO. 506 SANTA CLARA, CALIFORNIA

HEWLETT-PACKARD COMPANY

SANTA CLARA DIVISION

5301 Stevens Creek Boulevard

Santa Clara, California 95050

United States of America

ATTENTION:
Publications Services Dept.



OPERATING AND PROGRAMMING MANUAL

5180A WAVEFORM RECORDER

SERIAL PREFIX: 2210A

This manual applies to Serial Prefix 2210A, unless accompanied by a Manual Change Sheet indicating otherwise.

First Edition — January 1982

©Copyright 1982
by
HEWLETT-PACKARD COMPANY
5301 Stevens Creek Boulevard
Santa Clara, California 95050

MANUAL PART NUMBER 05180-90001
Microfiche Part Number 05180-90002

SAFETY CONSIDERATIONS

GENERAL

This product and related documentation must be reviewed for familiarization with safety markings and instructions before operation.

This product is a Safety Class I instrument (provided with a protective earth terminal).

BEFORE APPLYING POWER

Verify that the product is set to match the available line voltage and the correct fuse is installed. Refer to Section II, Installation.

SAFETY EARTH GROUND

An uninterruptible safety earth ground must be provided from the main power source to the product input wiring terminals, power cord, or supplied power cord set.

SAFETY SYMBOLS



Instruction manual symbol: the product will be marked with this symbol when it is necessary for the user to refer to the instruction manual.



Indicates hazardous voltages.



Indicates earth (ground) terminal.

WARNING

The **WARNING** sign denotes a hazard. It calls attention to a procedure, practice, or the like, which, if not correctly performed or adhered to, could result in personal injury. Do not proceed beyond a **WARNING** sign until the indicated conditions are fully understood and met.

CAUTION

The **CAUTION** sign denotes a hazard. It calls attention to an operating procedure, practice, or the like, which, if not correctly performed or adhered to, could result in damage to or destruction of part or all of the product. Do not proceed beyond a **CAUTION** sign until the indicated conditions are fully understood and met.

WARNING

Any interruption of the protective (grounding) conductor (inside or outside the instrument) or disconnecting the protective earth terminal will cause a potential shock hazard that could result in personal injury. (Grounding one conductor or a two conductor outlet is not sufficient protection.)

Whenever it is likely that the protection has been impaired, the instrument must be made inoperative and be secured against any unintended operation.

If this instrument is to be energized via an autotransformer (for voltage reduction) make sure the common terminal is connected to the earth terminal of the power source.

Servicing instructions are for use by service-trained personnel only. To avoid dangerous electric shock, do not perform any servicing unless qualified to do so.

Adjustments described in the manual are performed with power supplied to the instrument while protective covers are removed. Energy available at many points may, if contacted, result in personal injury.

Capacitors inside the instrument may still be charged even if the instrument has been disconnected from its source of supply.

For continued protection against fire hazard, replace the line fuse(s) only with 250V fuse(s) of the same current rating and type (for example, normal blow, time delay, etc.). Do not use repaired fuses or short circuited fuseholders.

TABLE OF CONTENTS

Section	Title	Page	Section	Title	Page
I	GENERAL INFORMATION	1-1			
	1-1. Introduction	1-1	2-45.	5180A Listen/Talk Address	2-8
	1-5. Specifications	1-1	2-47.	HP-IB Descriptions	2-8
	1-7. Safety Considerations	1-1	2-49.	Installation Checkout	2-8
	1-9. Instrument Identification	1-1	2-51.	Storage and Shipment	2-9
	1-11. Description	1-5	2-52.	Environment	2-9
	1-20. Options	1-5	2-55.	Packaging	2-9
	1-22. Accessories Supplied	1-5	III	OPERATION AND PROGRAMMING	3-1
	1-24. Equipment Required But Not Supplied	1-5	3-1.	Introduction	3-1
	1-27. Equipment Available	1-6	3-3.	Operating Characteristics	3-1
	1-28. Service Accessories	1-6	3-6.	Basic Circuits and Measurements	3-1
	1-30. Rack Mount Accessories	1-6	3-8.	Overall Performance	3-2
	1-32. Interface Accessory 10872A	1-6	3-10.	Precision Time and Voltage Measurements Using Zoom, Gain, Cursor, and Cursor Δ	3-2
	1-34. Recommended Test Equipment	1-6	3-17.	Trigger Features	3-4
II	INSTALLATION	2-1	3-19.	Pre- and Post-Triggering	3-4
	2-1. Introduction	2-1	3-24.	Trigger Position Control	3-6
	2-3. Initial Inspection	2-1	3-26.	Selectable Trigger Hysteresis	3-6
	2-5. Preparation for Use	2-1	3-29.	Two Time Bases	3-7
	2-6. Operating Environment	2-1	3-34.	Memory Segmentation	3-8
	2-10. Power Requirements	2-1	3-36.	Dual Mode	3-8
	2-12. Line Voltage and Fuse Selection	2-1	3-38.	Auto Advance Mode	3-9
	2-16. Power Cable	2-2	3-40.	Trace 1 Minus Trace 2 Function	3-9
	2-18. Installation of Accessories	2-2	3-42.	Two Channel Recording	3-10
	2-21. Rack Mounting Accessory Kits	2-2	3-44.	Five Output Data Formats	3-10
	2-24. Front Panel Controlled Output	2-3	3-46.	N Channel Recording	3-10
	2-25. HP-GL Output for Plotters	2-3	3-48.	Save and Recall Functions	3-11
	2-27. XYZ Display Output	2-3	3-50.	Trigger Time Feature	3-11
	2-29. Front Panel Lockout	2-3	3-53.	Systems Adapability	3-11
	2-31. Lock, Unlock, and Hold Function	2-3	3-57.	Summary of Operating Characteristics	3-12
	2-34. HP-IB Controlled Output	2-7	3-59.	Power Turn-On Checks	3-12
	2-36. Digital Output Format	2-7	3-61.	Error Indications	3-13
	2-38. Analog Output Format	2-7	3-66.	Front Panel Controls, Indicators, and Connectors	3-16
	2-40. Selecting Bus Address and Output	2-8	3-68.	Input Section	3-18
	2-42. HP-IB Interconnections	2-8	3-69.	Channel A Controls	3-18
			3-70.	Channel B Controls	3-19

TABLE OF CONTENTS (Continued)

Section	Title	Page	Section	Title	Page
3-71.	Trigger Section	3-20	3-134.	Trigger Timer	3-48
3-72.	Sweep Arm Controls	3-20	3-136.	Display Features	3-48
3-73.	Position Controls	3-20	3-137.	Single or Dual Trace Display	3-48
3-74.	Trigger Controls	3-21	3-139.	Zoom, Gain, Position, Offset, and Line Mode	3-48
3-76.	Time Base Controls	3-24	3-141.	Zoom	3-49
3-78.	Control Section	3-26	3-144.	Vertical Gain	3-50
3-80.	Front Panel Connectors	3-33	3-146.	Horizontal Position and Vertical Offset	3-50
3-82.	Front Panel Annunciators	3-34	3-149.	Line Display Mode	3-50
3-84.	Rear Panel Controls and Connectors	3-36	3-151.	Cursors, Voltage and Time Measurements ..	3-50
3-86.	Operating Features	3-38	3-154.	Programming	3-51
3-88.	Self-Test	3-38	3-157.	Interface Function	3-51
3-90.	Selection of Front Panel Functions	3-38	3-160.	Bus Messages	3-51
3-92.	Overall Control of Front Panel	3-39	3-162.	Address Selection	3-53
3-94.	Error Indications	3-39	3-165.	HP-IB Commands	3-54
3-96.	Hardware Failures	3-39	3-168.	Channel Select Commands	3-55
3-98.	Operation Errors	3-39	3-169.	Sweep Arming Commands	3-56
3-101.	Operating Procedures	3-40	3-170.	Trigger Position Commands	3-56
3-103.	Connection and Calibration of External XYZ Display	3-40	3-171.	Trigger Level and Source Commands	3-56
3-105.	Preset, Autoset, Save/Recall	3-42	3-172.	Timebase Control Commands	3-57
3-108.	Channel Selection, Range, and Offset Selection	3-43	3-173.	Data Entry Commands	3-57
3-112.	Triggering	3-44	3-174.	Set-Up Commands	3-58
3-114.	Internal or External Triggering	3-44	3-175.	Memory Commands	3-58
3-116.	Precise Trigger Level Selection	3-46	3-176.	Vertical Commands	3-58
3-118.	Pre- and Post-Trigger Recording	3-46	3-177.	Horizontal Commands	3-58
3-120.	Time Bases	3-46	3-178.	Measure Commands	3-58
3-122.	Main Only	3-46	3-179.	Miscellaneous Display Commands	3-58
3-124.	Mixed Time Base Mode	3-47	3-180.	HP-IB Control Commands	3-59
3-126.	Toggle Time Base Mode	3-47	3-181.	Input/Output Control Commands	3-59
3-128.	Memory Capabilities	3-47	3-185.	Service Request Function	3-66
3-130.	Memory Segmentation	3-48	3-187.	Additional HP-IB Features	3-66
3-132.	Auto Advance	3-48	3-191.	HP-IB Examples	3-66

LIST OF TABLES

Table	Title	Page	Table	Title	Page
1-1.	Model 5180A Specifications	1-2	3-7.	Operating the Time Base Section	3-46
1-2.	Recommended Test Equipment	1-6	3-8.	Using Memory Capabilities	3-47
2-1.	AC Power Cables Available	2-4	3-9.	Using Single or Dual Trace Display	3-48
3-1.	Summary of Operating Characteristics	3-14	3-10.	Using Zoom, Gain, Position, Offset, and Line Mode	3-49
3-2.	Error Messages	3-40	3-11.	Using Cursors, Voltage, and Time Measurements	3-50
3-3.	Using Preset and Autoset Function Values	3-42	3-12.	5180A HP-IB Interface Capability	3-51
3-4.	Using Preset, Autoset, Save/Recall	3-43	3-13.	Bus Messages	3-52
3-5.	Using Channel Selection, Range, and Offset Selection	3-44	3-14.	Address Selection	3-53
3-6.	Operating the Trigger Section	3-45	3-15.	Summary of HP-IB Commands	3-63
			3-16.	Service Request Events	3-66

LIST OF FIGURES

Figure	Title	Page	Figure	Title	Page
1-1.	Model 5180A Waveform Recorder	1-0	3-10.	Selectable Hysteresis	3-7
2-1.	Voltage Selection with Power Module PC Board	2-2	3-11.	Fast Rise, Slow Decay, Combined in Mixed Mode	3-8
2-2.	Setup Switches, Normal Positions	2-3	3-12.	Dual Trace Mode	3-8
2-3.	Installation of Rack Mount Kits	2-6	3-13.	Auto Advance Records	3-9
2-4.	Setup for Direct Output from 5180A	2-7	3-14.	TR1-TR2 Function	3-9
2-5.	Rear Panel Switch Settings	2-7	3-15.	Channel A,B Chop Mode	3-10
2-6.	Hewlett-Packard Interface Bus Connections	2-10	3-16.	N Channel Recording	3-11
3-1.	5180A Simplified Block Diagram	3-2	3-17.	Typical System Setup	3-12
3-2.	Turn-On Transient for Signal Generator	3-3	3-18.	Power-Up Test Pattern on External Display	3-13
3-3.	Peak-to-Peak Voltage of Transient	3-3	3-19.	Front Panel Controls, Indicators, and Connectors	3-17
3-4.	Positioning Cursor for Zooming	3-3	3-20.	Rear Panel Controls and Connectors	3-36
3-5.	Zoom Display	3-4	3-21.	Digital Samples Converted to Analog Form for XYZ Drive	3-41
3-6.	Display of Transient Using -20% Pre-Trigger	3-4	3-22.	Connections for 1311A Display and 1725A Oscilloscope (without Option 101)	3-41
3-7.	Display of Post-Triggering Recorded Data	3-5	3-23.	Switch Settings on 5180A Rear Panel for Display Oscilloscope	3-41
3-8.	Digitized Samples Compared with Selected Trigger Level	3-5	3-24.	5180A Calibration Pattern	3-41
3-9.	Trigger Position Selection of Record Data	3-6			

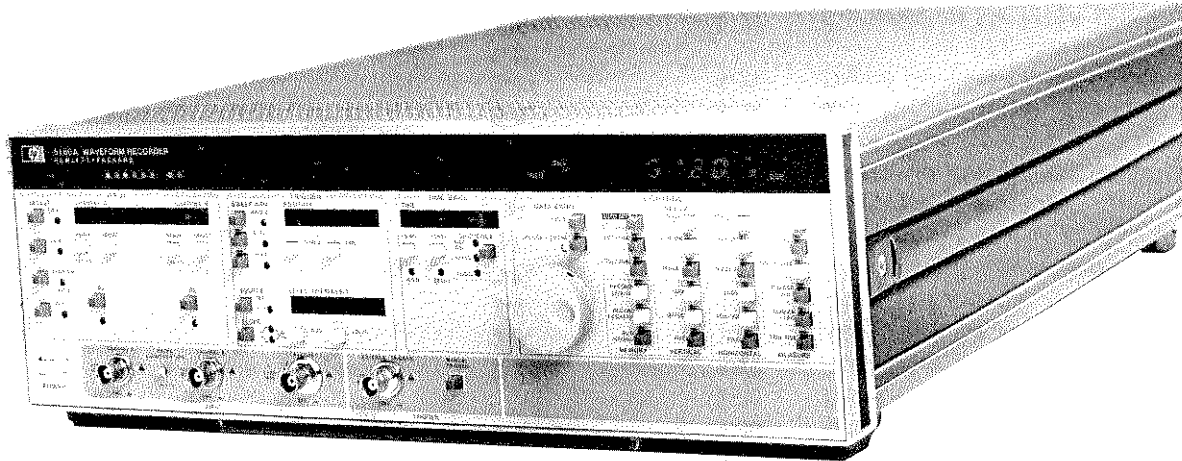

HP 5180A WAVEFORM RECORDER

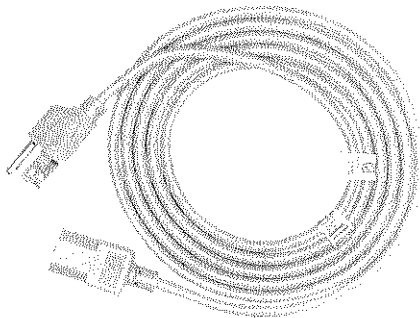

HP 8120-1378
POWER CABLE

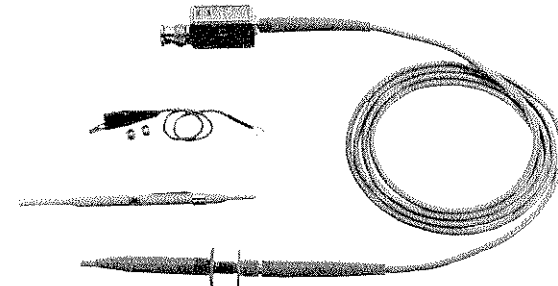

HP 10013A
10:1 DIVIDER PROBE
(2)

Figure 1-1. Model 5180A Waveform Recorder

SECTION I GENERAL INFORMATION

1-1. INTRODUCTION

1-2. This Operating and Programming Manual together with the Service Manual form a two manual set which contains information required to install, operate and program, test, adjust, and service the Hewlett-Packard Model 5180A Waveform Recorder, which is shown in *Figure 1-1* with all supplied accessories.

1-3. The information contained in both the Operating and Service Manuals is described below. Sections I through III are contained in this Operating Manual; Sections IV through VIII are contained in the Service Manual.

Section I, GENERAL INFORMATION: describes the instrument documented by this manual and covers instrument description, options, accessories, specifications, and other basic information.

Section II, INSTALLATION: provides information about initial inspection, preparation for use (including address selection for remote operation), and storage and shipment.

Section III, OPERATION AND PROGRAMMING: provides information about panel features, and includes operating characteristics and operating instructions for local operation and programming instructions for remote operation.

Section IV, PERFORMANCE TESTS: provides the information required to check performance of the instrument against the critical specifications in *Table 1-1*.

Section V, ADJUSTMENTS: provides the information required to properly adjust the instrument.

Section VI, REPLACEABLE PARTS: provides ordering information for all replaceable parts and assemblies.

Section VII, MANUAL CHANGES: provides manual change information necessary to document all serial prefixes (for older instruments).

Section VIII, SERVICE: provides the information required to service and repair the instrument.

1-4. Additional copies of this Manual and of the Service Manual can be ordered separately through your nearest Hewlett-Packard office. The part numbers are listed on the title page of this manual. Also, on the title page below the Manual Part Number, is a Microfiche Part Number. This number may be used to order 100 × 150 mm (4 × 6-inch) microfilm transparencies of either manual. Each microfiche contains up to 96 photo-duplicates of the manual pages. The microfiche package also includes the latest Manual Changes supplements.

1-5. SPECIFICATIONS

1-6. Instrument specifications are listed in *Table 1-1*. These are the performance standards, or limits against which the instrument may be tested in addition to typical characteristics included as additional information for the user.

1-7. SAFETY CONSIDERATIONS

1-8. This product is a Safety Class I instrument (provided with a protective earth terminal). Safety information pertinent to the operation and servicing of this instrument is included in the front matter and in appropriate sections of this manual.

1-9. INSTRUMENT IDENTIFICATION

1-10. Hewlett-Packard instruments have a 2-section, 10-character serial number (0000A00000), which is located on the rear panel. The four-digit serial prefix identifies instrument changes. If the serial prefix of your instrument differs from that listed on the title page of this manual, there are differences between this manual and your instrument. Instruments having higher serial prefixes are covered with a "Manual Changes" sheet included with this manual. If the change sheet is missing, contact the nearest Hewlett-Packard Sales and Service Office listed at the back of this manual. Instruments having a lower serial prefix than that listed on the title page, are covered in Section VII, of the Service Manual.

Table 1-1. Model 5180A Specifications

CHANNEL A AND B INPUTS:

Input Voltage Range: ± 100 mV to ± 10 V full scale in a 1-2-5 sequence.
 Input Offset: \pm selected voltage range in 1% increments; accuracy: $\pm 3\%$.
 Amplifier Bandwidth¹ (-3 dB): dc to 40 MHz (dc coupling).
 10 Hz to 40 MHz (ac coupling).
 Input Impedance (NOMINAL): 1 M Ω || <30 pF (10V range).
 1 M Ω || <35 pF (all other ranges).
 Input Coupling: AC or DC, switch selectable.
 Damage Level: ± 25 V (DC + peak AC) to 1 kHz, ± 12 V above 1 kHz.
 Cross Talk²: CHAN A or B Mode: ≤ 60 dB
 CHOP A,B Mode: ≤ 38 dB
 Calibration Signals: 0V ground and 100 mV dc reference may be applied to either channel. Accuracy (0°C to 55°C): $\pm 0.4\%$.
 Probe Compensation: Square wave: ± 1 V, 1 kHz NOMINAL.
 Damage Level: ± 25 V (DC + peak AC) to 1 kHz.

Dynamic Performance³ (20°C to 30°C):

TEST	RANGE	NOMINAL SINE WAVE AMPLITUDE	NOMINAL TEST FREQUENCY	
			1 MHz	10 MHz
DFT-spurious ⁴	± 1 V	2V p-p	≤ -50 dBc	≤ -46 dBc
Differential Nonlinearity ⁵	± 1 V	2.2V p-p	≤ 3 LSB	≤ 4 LSB
Missing Codes ⁶	± 1 V	2.2V p-p	NONE	NONE
Sine Wave Curve Fit ⁷	± 1 V	2V p-p	≥ 7.8 bits	≥ 7.5 bits
S/N Ratio ⁸	± 1 V	2V p-p	≥ 48.6 dB	≥ 46.8 dB

DC Performance:

Number of bits: 10
 Relative Accuracy⁹: ± 2 LSB
 Absolute Accuracy¹⁰: 0°C to 20°C: $\pm 5\%$ of range
 20°C to 30°C: $\pm 3\%$ of range
 30°C to 55°C: $\pm 5\%$ of range

AUXILIARY INPUT:

Input Voltage Range: ± 1 V
 Amplifier Bandwidth¹ (-3 dB): dc to 70 MHz
 Input Impedance (NOMINAL): 50 Ω
 Input Coupling: DC
 Damage Level: ± 1.5 V (DC + peak AC), fuse protected.

AUXILIARY INPUT (Continued)

Dynamic Performance³ (20°C to 30°C):

TEST	NOMINAL SINE WAVE AMPLITUDE	NOMINAL TEST FREQUENCY	
		≤ 1 MHz	10 MHz
DFT-Spurious ⁴	2V p-p	≤ -52 dBc	≤ -48 dBc
Differential Nonlinearity ⁵	2.2V p-p	≤ 3 LSB	≤ 4 LSB
Missing Codes ⁶	2.2V p-p	NONE	NONE
Sine Wave Curve Fit ⁷	2V p-p 0.2V p-p	≥ 8.0 bits ≥ 8.0 bits	≥ 7.7 bits ≥ 8.0 bits
S/N Ratio ⁸	2V p-p	≥ 49.8 dB	≥ 48.0 dB

DC Performance:

Number of bits: 10
 Relative Accuracy⁹: ± 1 LSB
 Absolute Accuracy¹⁰: 0°C to 20°C: $\pm 2\%$ of range
 20°C to 30°C: $\pm 1\%$ of range
 30°C to 55°C: $\pm 2\%$ of range

TRIGGER CHARACTERISTICS

Internal Trigger:

Slope: +, -, Bi-Trigger
 Level: Digital triggering. Level may be entered in 1% increments over full scale range (FSR) or in absolute volts.
 Hysteresis: Digitally selectable from 0% to 100% of full scale in 1% increments or as an absolute value.
 Bi-Trigger: Triggers when input signal passes through either the more positive or more negative level. Bi-Trigger mode levels are set by hysteresis control and are centered about the selected trigger level.

External Trigger:

Slope: + or -
 Level: Selectable over ± 2.5 V range; nominal increments of 20 mV.
 Hysteresis: 100 mV NOMINAL, centered on selected trigger level.
 Width: ≥ 30 ns
 Input Impedance: 10K ohms NOMINAL
 Coupling: DC
 Maximum Input: ± 25 V

Sweep Arm Characteristics:

Single: Pushbutton arms 5180A for single sweep after trigger.
 Auto: Pushbutton arms 5180A for continuous freerun measurements. If no trigger occurs during a sweep, then a trigger is forced.
 Norm: Pushbutton arms 5180A for continuous retriggered sweeps, one sweep after each trigger. If no trigger occurs, then there will be no sweep.
 Arm Delay: Selectable 5 ms, 0.18 s, 0.25 s to 99 seconds in 0.25 second increments. Controls the time between measurements.

Table 1-1. Model 5180A Specifications (Continued)

Trigger Position:

Range: -100% of memory to +9999% of memory in 1% increments. Also settable in absolute time with maximum delay equal to one million sample intervals or 9,999 seconds.

TIMEBASE:**Sample Interval:**

Internal: 50 ns to 50 ms in a 1-2-5 sequence. In Chop A,B mode, available sample intervals (each channel) are: 200 ns, 1 μ s, 2 μ s, ... to 50 ms in a 1-2-5 sequence. In Chop A,B mode, Channel B follows Channel A by 100 ns for all sample rates.

External timebase in (rear panel): Allowable frequency range is 1 MHz to 20 MHz. Divide ratios of 1 to 1-6 available in a 1-2-4 sequence. (Time measurements using cursors assume 20 MHz timebase; scaling required if frequency is less than 20 MHz.) Input impedance is 50 Ω NOMINAL. Timebase level switch selects thresholds of -0.3V (HP-EECL), and 0V (sine wave). With 1 K Ω series resistor (HP P/N 10871-60101), switch also selects thresholds for ECL and TTL.

Modes:

Main, Mixed, Toggle.

Internal Reference:

Aging Rate: $\pm 3 \times 10^{-6}$ per year.

Temperature: $\pm 2 \times 10^{-5}$ 0°C to 55°C.

Timebase Out: 20 MHz, 0 to -0.6 volt levels into 50 Ω .

MEMORY:

Size: 16384 words

Bits: 10

Segmentation: Memory may be segmented in 1, 2, 4, 8, 16, or 32 equal blocks.

Recording: Data may be recorded in any memory block.

ANALOG OUTPUT MODES**XYZ CRT Monitor Outputs:**

(These outputs are compatible with most HP oscilloscopes and CRT displays.)

XY Deflection Voltage: NOMINAL -1 to 0V full scale into 50 ohms; requires 5 MHz bandwidth input (Y); 1 MHz (X).

Z Voltage: NOMINAL 0 to 2V into 1 K Ω (0 to 1V, 50 Ω); selectable as a positive or negative going blanking pulse. 1.25 MHz bandwidth input required.

XY Recorder Control Outputs:

(These outputs are compatible with most HP XY recorders.)

XY Deflection Voltage: NOMINAL -1 to 0V full scale into 50 ohms.

Pen Lift Voltage: NOMINAL 0 to 5V output. Capable of operating a 45V solenoid. Will sink 1A, peak; 200 mA, continuous.

Time/Point Plotted: Selectable with front panel SPEED control.

HEWLETT-PACKARD INTERFACE BUS:

Programmable Controls: All front panel controls and functions except power on/stby switch.

Special Functions: "Talk only" to HPGL plotters, with and without page advance. "Talk only" to printers and other tabular outputs.

Input and output of entire records or discrete data points in ASCII or Binary Learn Mode Commands.

HP-IB Commands: Trigger, Clear, Remote, Local, Local Lockout, Clear Lockout and Local, Require Service, Status Byte, Abort.

Data Output Rate: 3K byte/second maximum, depending on controller.

HIGH SPEED INPUT/OUTPUT (DMA rear panel connector):

10 Data Lines

6 HP-IB Address Indicator Lines

Controls Lines: Transfer Request* (Start/Stop data) Read/Write*

Data Transfer Type: 2 Line Handshake* or Single Line Strobe*

Data Transfer Mode (selectable by internal switch):

Automatic: Transferred data defined by 5180A record location and length.

Manual: Location of transferred data defined by 5180A record location;

Length of data string defined by Transfer request control line.

Data Input/Output Rate: 1M word/second maximum, depending on controller.

SERVICE AIDS:

Power-Up Test: Verifies high speed memory and microprocessor operation.

Service Interval Timer: Displays total operational time in seconds since last service calibration. Displayed at end of self-test.

Signature Analysis: Internal switches select from among 7 signature analysis routines. HP 5005A recommended for troubleshooting.

Service Loops: Internal switches select from among 6 microprocessor controlled service loop routines for troubleshooting.

Front Panel Troubleshooting: With HP-IB address switch set to 99, troubleshooting routines may be accessed from the front panel for fault isolation.

GENERAL

Front Panel Memory: Four complete front panel setups may be saved and recalled. Current setup is also saved in location 5 when a PRESET or AUTOSET is executed. Settings are stored for 4 days with no power.

Front Panel Lockout: Panel Lock key locks out front panel control: Unlock/Local key returns front panel control.

Calibrate: The CAL key places a known pattern on the external XYZ outputs for adjusting external display gains and offsets.

Dot/Line: Dot mode displays collected data via the XYZ outputs; Line mode displays the same points connected by curved lines generated by analog interpolation.

Self-Test: Initiates internal test of all RAM and ROM in the 5180A. Exercises internal displays and XYZ outputs. Performs input amplifier calibration check.

*TTL Logic levels — Positive/negative logic selectable by internal switch.

Table 1-1. Model 5180A Specifications (Continued)

Available Display Cursors: Trigger point cursor (intensified dot); Cursor (box shaped cursor; 5180A displays absolute volts or time from trigger point); Delta Cursor (cross shaped cursor; 5180A displays delta volts, delta time from cursor); trigger level and hysteresis cursors; timebase change cursor.

Display Zoom and Position: Zoom controls the horizontal spread of data displayed on the XYZ display. When zoomed out, the 5180A displays complete memory block selected, skipping points as necessary to reduce the total of 1024 points. Display may be zoomed in until points displayed correspond one for one with data in memory. Further zooming reduces number of displayed points to 256. Zoom value displayed is the number of data points in chosen record spanned by the display. The POSITION function controls the horizontal offset of the displayed portion of memory.

Display Gain and Offset: GAIN controls the vertical spread of the data displayed on the XYZ display. The GAIN value displayed is the full scale voltage range on the CRT display. The OFFSET function controls the vertical offset of the displayed data.

Single/Dual Display: Any two records may be simultaneously displayed. GAIN, OFFSET, ZOOM, POSITION may be specified independently for each trace.

TR1-TR2: Record defined as Trace 2 is subtracted point-by-point from record defined as Trace 1; content of original records remain unchanged.

Auto Advance: 5180A automatically advances to the next record of memory after each measurement. Arm delay determines time between measurements.

Trigger Time: Displays time of trigger, relative to set zero command, for selected memory record.

Bus Address: HP-IB address setting is displayed on 5180A display when Bus Address key is pressed.

Trigger Output (rear panel): Positive going signal from -0.6V to 0V into 50 Ω used to synchronize triggering on multiple 5180A's.

N Chan Sync Input (rear panel): Synchronizes multiple 5180A timebase divide chains.

Armed Output (rear panel): TTL levels. Indicates 5180A is ready to be triggered.

Operating Temperature: 0°C to 55°C.

Power Requirements: 100/120/220/240 volts +5%, -10%; 48 to 66 Hz -5% to 60 Hz +10%. Max power dissipation 400 watts.

Weight: Net, 22 kg (48 lbs.). Shipping, 24 kg (53 lb.).

Dimensions: 142mm H \times 426 mm W \times 574 mm D. (5 $\frac{5}{8}$ " H \times 16 $\frac{3}{4}$ " W \times 23" D) Excluding bottom feet and removable front handles.

¹Amplifier bandwidth is the bandwidth of the amplifier prior to the sample/hold. It is measured using a full scale sine wave in a beat frequency test. The amplifier bandwidth is found by determining the frequency of an input sine wave which causes the amplitude of the measured beat signal to decrease by 3 dB relative to the input signal amplitude.

²Cross talk is the worst case ratio (in dB) between the rms signal level of a full scale sine wave input applied to either channel and the rms signal level which shows up in the alternate channel which has been terminated in 50 Ω .

³Dynamic Performance is specified only while using the internal timebase. The test signal is passed through 5-pole low pass filters (HP P/N 10871-60002) with cut off frequencies of 1 and 10 MHz.

⁴The DFT-spurious specification for the 5180A specifies the maximum level of spurious signal (spurious means all unwanted signals, including harmonics of the input signal), relative to the test signal and is computed from DFT data at specified sine wave frequencies and amplitudes. Actual test frequencies are 0.95 MHz and 9.85 MHz. See Product Note 5180A-2 for details.

⁵Differential nonlinearity is the maximum difference between the actual ADC transfer function step size and the ideal step size. Differential nonlinearity is computed from histogram data at specified sine wave frequencies and slightly greater than full scale amplitude. It is expressed in LSB (least significant bits) which equals full scale range/1024.

⁶Missing codes specifies the number of codes in the ADC transfer function which do not occur as a function of input sine wave frequency. It is measured using histogram measurement techniques.

⁷Sine wave curve fit — a full scale sine wave of specified frequency is digitized by the 5180A. An idealized sine wave of the form $A \sin(2\pi ft + \theta) + DC$ is fit to the data using a least squares fit and selecting A, f, θ , and DC to minimize the squared error. The idealized sine wave, $A_0 \sin(2\pi f_0 t + \theta_0) + DC_0$, is quantized in software by an ideal 10-bit ADC. The rms error (actual) between the actual data and the best fit sine wave is computed. The rms error between the idealized data (generated by an ideal 10-bit ADC) and the best fit sine wave is also computed. Then, the effective number of bits is computed as:

$$\text{effective bits} = 10 - \log_2 \frac{\text{rms error (actual)}}{\text{rms error (ideal)}}$$

The effective number of bits, then, is the number of bits in an ideal A-to-D whose quantization error would equal the rms error produced by the A-to-D under test. Actual test frequencies are 0.95 MHz and 9.85 MHz. The test record length is 1024 points. See Product Note 5180A-2 for details.

⁸S/N Ratio — the ratio of rms signal to rms noise for a full scale input sine wave of specified frequency is specified. Computed from the sine wave curve fit test.

⁹Relative accuracy is the maximum deviation of the ADC transfer function from a best fit straight line.

¹⁰Absolute accuracy is the maximum deviation of the ADC transfer function from the ideal transfer function where the definition of the threshold levels is given in terms of absolute units as maintained by the National Bureau of Standards.

1-11. DESCRIPTION

1-12. The 5180A Waveform Recorder is a waveform capture and analysis instrument that provides high performance measurements of analog signals. The 5180A is basically an Analog-to-Digital Converter (ADC) with memory.

1-13. The ADC samples the input signal at rates (selectable) up to 20 MHz. The resulting 10-bit digital code is stored in an 16K random access memory. The stored digital codes represent the instantaneous voltage of the input analog waveform at each sample point.

1-14. Real-time conversion of up to 20 million samples-per-second, coupled with high-speed data storage, enables the 5180A to capture and analyze single-shot or repetitive waveforms with frequency components to 10 MHz. After being stored in memory, the captured waveform may be output in either analog or digital formats. Analog XYZ drive circuits (using D/A converters) convert the digitized waveform into repetitive playback signals for flicker-free display on oscilloscopes, large-screen displays, or XY recorders. Digital outputs using HP-IB (IEEE 488-1978) and all parallel (DMA) formats permit computer analysis of waveforms in addition to permanent storage of waveforms on magnetic tape and disk. The fully programmable 5180A can be used as an integral part of a programmable signal processing system.

1-15. Two of the input connectors on the front panel (CHANNEL A and CHANNEL B) provide variable range oscilloscope-type high impedance input channels for one and two channel recording applications. The Channel A and B input amplifiers provide signal conditioning features which match a variety of input signals to the nominal plus/minus 1.0-volt range of the 5180A's Analog-to-Digital Converter (ADC). Independent range selection on the front panel allows you to choose full-scale range from ± 100 mV to ± 10 V in a 1-2-5 sequence. Digitally controlled offset may be added to the input channel. For a unipolar input, the offset may be used to take advantage of the full range of the ADC. Input dc or ac coupling is selectable for each channel and two point calibration of the input amplifier is possible using the built-in zero and 100 mV reference voltage.

1-16. A precision 50-ohm input (Channel AUX) has a fixed ± 1.0 -volt range to provide an auxiliary input (without signal conditioning).

1-17. When used with an external CRT display or an oscilloscope, the 5180A output provides for dual cursors with voltage and time readout. This ensures precise measurement of voltage, voltage differences, and time intervals. The displayed waveform can be expanded for detailed viewing by use of zoom and gain controls.

1-18. Front panel controls are completely programmable for use in data acquisition/waveform analysis systems. Data records may be input or output via the Hewlett-Packard Interface Bus (HP-IB) or via the high-speed Direct Memory Access (DMA) interface at rates to one megaword/second.

1-19. Operating features, characteristics, functions of controls and indicators, local operation and remote programming are described in detail in Section III, Operation and Programming.

1-20. OPTIONS

1-21. The 5180A does not have standard options.

1-22. ACCESSORIES SUPPLIED

1-23. The 5180A is supplied with a power cable and two oscilloscope divider probes, as shown in *Figure 1-1*. The type of power cable depends upon the country of destination, as described in Section II of this manual.

1-24. EQUIPMENT REQUIRED BUT NOT SUPPLIED

1-25. The XYZ output of the 5180A requires an external oscilloscope, CRT display, or XY recorder. Digital outputs using HP-IB (IEEE 488-1978) and all parallel (DMA) formats permit computer analysis of waveforms in addition to permanent storage of waveforms on magnetic tape and disk.

1-26. To use the HP-IB capabilities of the 5180A (as described in Section III) a computing controller such as the HP 9825 Desktop Computer is required.

1-27. EQUIPMENT AVAILABLE**1-28. Service Accessories**

1-29. A Service Accessory Kit (Model No. 10871A) that contains all service tools required for test, repair, and calibration is available.

1-30. Rack Mount Accessories

1-31. The following rack mount accessory kits (see *Figure 2-3*) are available:

- a. Rack Mount Kit (10873A). This kit prepares the 5180A for rack mounting (with or without front handles installed) in a standard rack of 482.5 mm (19 inches).
- b. Rack Mount Kit (10874A). This kit contains rack mounting slides and prepares the 5180A for slide rack mounting in a standard rack of 482.5 mm (19 inches).

1-32. Interface Accessory 10872A

1-33. A 98032 16-line parallel interface cable is available, fitted with a special connector to match the 5180A rear panel DMA connector. This 10872A cable provides an interface to 9825/35/45 controllers.

1-34. RECOMMENDED TEST EQUIPMENT

1-35. The test equipment listed in *Table 1-2* is recommended for use in Operational Verification (OV), Performance Testing (P), Calibration (C), and Troubleshooting (T). In addition, the performance test will require the Low Pass Filter (10871-60002). Calibration and Troubleshooting procedures will require Service Accessory Kit 10871A. Substitute equivalent equipment may be used unless otherwise indicated.

Table 1-2. Recommended Test Equipment

TEST EQUIPMENT	LIMITING CHARACTERISTICS	USE	RECOMMENDED HP MODEL
Oscilloscope	250 MHz, XYZ inputs.	OV,P,C,T	1725A
CRT Display	XYZ single-ended inputs to display 5180A data.	OV,P,C,T	1340A
Frequency Synthesizer	20 MHz sine, programmable amplitude (no substitute recommended).	OV,P,C,T	3335A
Signature Analyzer	TTL/ECL trigger levels for start, stop, clock, data, and qualifier. Must have a qualifier input.	T	5005A
DVM	20V range, $\pm 0.02\%$, 6½ digits, HP-IB.	P,C,T	3455A
HP-IB Controller	No substitute recommended.	OV,P,C,T	9825B
Plotter	Listen Only (HP-IB). Capable of checking 5180A plot function.	P	9872C

SECTION II INSTALLATION

2-1. INTRODUCTION

2-2. This section includes information on initial inspection, preparation for use, installation, storage and shipment, and checkout procedures for the HP Model 5180A Waveform Analyzer.

2-3. INITIAL INSPECTION

2-4. Inspect the shipping containers for damage. If the shipping containers or cushioning material is damaged, it should be kept until the contents of the shipment have been checked for completeness and the instrument has been checked mechanically and electrically. The contents of the shipment should be as shown in *Figure 1-1*. If the contents are incomplete, or if there is mechanical damage or defect, notify the nearest Hewlett-Packard office. If either shipping container is damaged or the cushioning material shows signs of stress, notify the carrier as well as the Hewlett-Packard office. Keep the shipping materials for carrier's inspection. The HP office will arrange for repair or replacement without waiting for claim settlement.

2-5. PREPARATION FOR USE

2-6. Operating Environment

2-7. TEMPERATURE. The instrument may be operated in temperatures from 0°C to +55°C.

2-8. HUMIDITY. The instrument may be operated in environments with humidity from 5% to 95% at 0°C to 40°C. However, the instrument should be protected from temperature extremes which might cause condensation within the instrument.

2-9. ALTITUDE. The instrument may be operated at altitudes up to 4,572 metres (15,000 feet).

2-10. Power Requirements

2-11. The Model 5180A requires a power source of 100-, 120-, 220-, or 240-volt ac +5% -10%, 50-60 Hz. Power consumption for the instrument is less than 400 volt amperes.

2-12. Line Voltage and Fuse Selection

WARNING

BEFORE THIS INSTRUMENT IS SWITCHED ON, ITS PROTECTIVE EARTH TERMINALS MUST BE CONNECTED THROUGH THE PROTECTIVE CONDUCTORS OF THE AC CABLES TO SOCKET OUTLETS PROVIDED WITH PROTECTIVE EARTH CONTACTS. DO NOT NEGATE THE EARTH-GROUNDING PROTECTION BY USING EXTENSION CABLES, POWER CABLES, OR AUTOTRANSFORMERS WITHOUT PROTECTIVE GROUND CONDUCTORS. FAILURE TO GROUND THE INSTRUMENT CAN RESULT IN PERSONAL INJURY. REFER TO PARAGRAPH 2-16.

CAUTION

BEFORE SWITCHING ON THIS INSTRUMENT, make sure it is adapted to the voltage of the ac power source. You must set the voltage selector card correctly to adapt the 5180A to the power source as described in paragraph 2-13. Failure to set the ac power input of the instrument for the correct voltage level could cause damage to the instrument when plugged in.

2-13. **LINE VOLTAGE REQUIREMENTS.** The 5180A is equipped with a power module (on the rear panel) that contains a printed-circuit line voltage selector to select 100-, 120-, 220-, or 240-volt ac operation as shown in *Figure 2-1*. Before applying power, the pc selector must be set to the correct position and correct fuse must be installed as described below.

2-14. Power line connections are selected by the position of the plug-in circuit card in the module. When the card is plugged into the module, the only visible markings on the card indicate the line voltage to be used. The correct value of line fuse, with a 250-volt rating, must be installed after the card is inserted. This instrument uses a 4A fuse (HP Part Number 2110-0055) for 110/120-volt operation; a 2A fuse (HP Part Number 2110-0002) for 220/240-volt operation.

2-15. To convert from one line voltage to another, the power cord must be disconnected from the power module before the sliding window covering the fuse and card compartment can be moved to expose the fuse and circuit card. See *Figure 2-1*.

2-16. Power Cable

2-17. The 5180A is shipped with a three-wire power cable. When the cable is connected to an appropriate ac power source, this cable connects the chassis to earth ground. The type of power cable plug shipped with each instrument depends on the country of destination. Refer to *Table 2-1* for the part numbers of the power cable and plug configurations available.

2-18. INSTALLATION OF ACCESSORIES

2-19. Installation of rack mounting kits is described in paragraph 2-21. Prior to rack mounting, ensure all setup switches (top of instrument boards) are set to normal positions shown in *Figure 2-2*.

2-20. Installation of the 10872A DMA interface requires only the connecting of the interface cable from the 5180A to the DMA device.

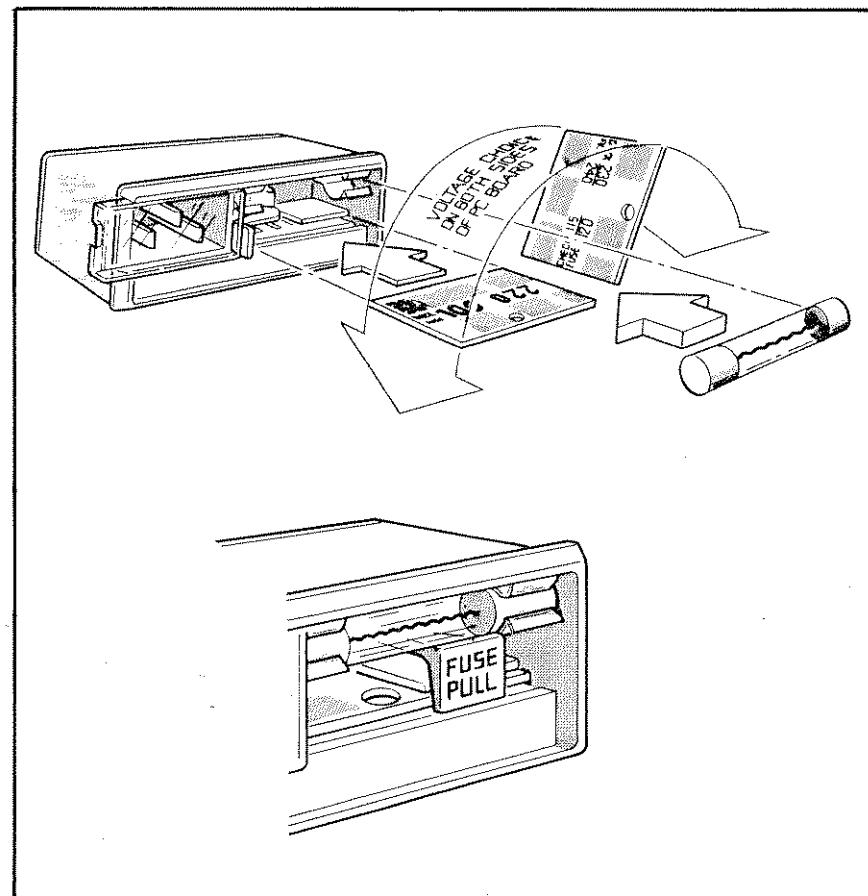

Figure 2-1. Voltage Selection with Power Module PC Board

2-21. Rack Mounting Accessory Kits

2-22. The rack mount kit (Model 10873A) prepares the 5180A for mounting in a standard rack. The rack slide mount kit (Model 10874A) prepares the 5180A for slide mounting in a standard rack.

2-23. Rack mounting information is provided with the rack mounting kits. If a kit was not ordered with the instrument, it can be ordered through the nearest HP Sales and Service Office. Installation information is shown in *Figure 2-3*.

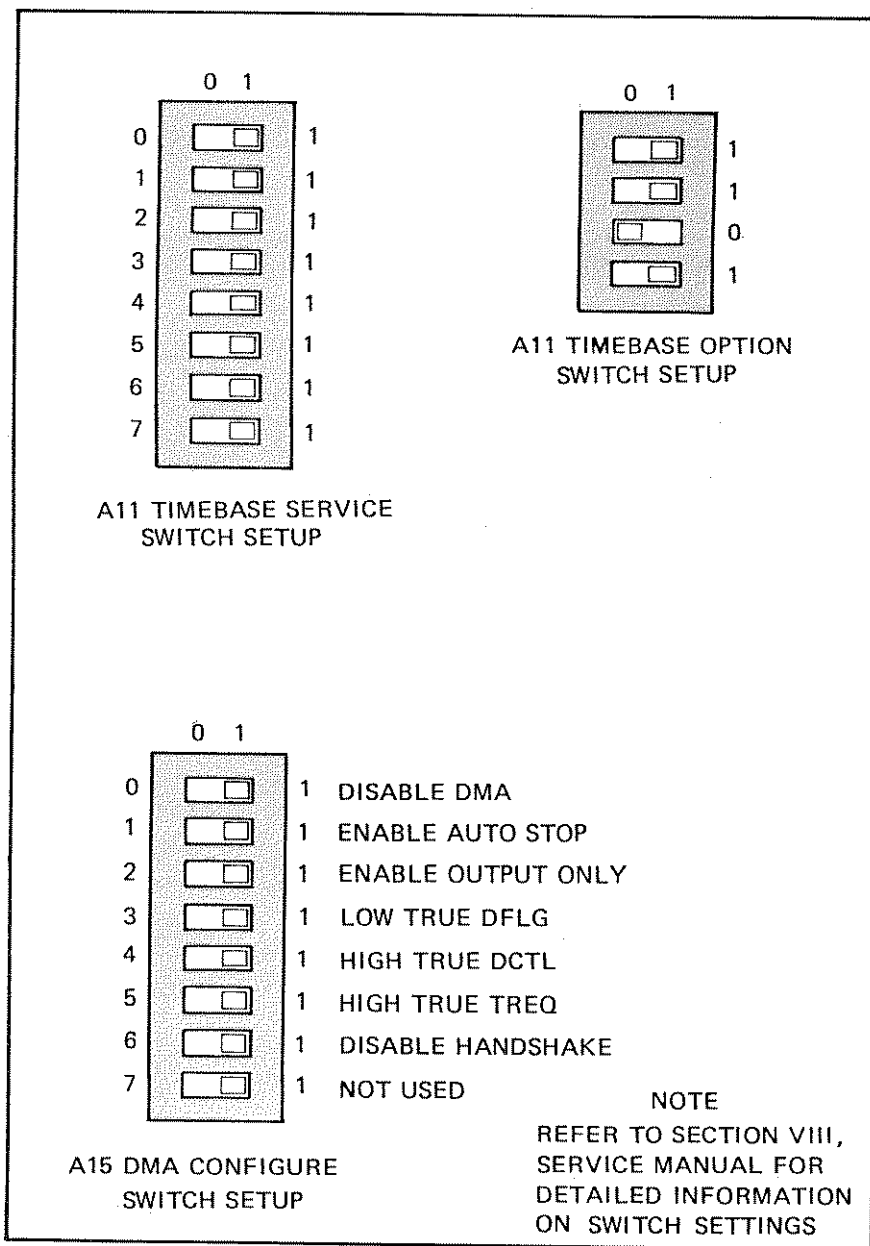

Figure 2-2. Setup Switches, Normal Positions

2-24. FRONT PANEL CONTROLLED OUTPUT

2-25. HP-GL Output for Plotters

2-26. To use the 5180A's front-panel controlled output with an HP-GL plotter, connect an HP-IB cable between the 5180A and the output device as shown in Figure 2-4. Be sure the CRT/PLOT switch on the rear panel is set to "CRT" for digital output, and set the plotter to LISTEN ONLY. Set the HP-IB ADDRESS switch on the rear panel to 50 or 52 (see Figure 2-5 and paragraph 2-34). Press SHIFT key then BUS ADDR Key (on front panel) to assign the new address to the 5180A. Finally, press SHIFT key then OUTPUT key to begin output from the 5180A.

2-27. XYZ Display Output

2-28. To use an external CRT display, the XYZ outputs of the 5180A must be connected to a display or oscilloscope. Refer to paragraph 3-103 for detailed descriptions.

2-29. Front Panel Lockout

2-30. When the 5180A is operating unattended, the front panel keys may be disabled, to avoid accidentally pressing keys and changing function values. The only key which remains functional is the unlock key, which may be pressed to activate all keys as described in the following paragraph.

2-31. Lock, Unlock, and Hold Function

2-32. To lock the front panel keys, press SHIFT then PANEL LOCK. An LED next to this key will light when the front panel keys are disabled. To unlock the front panel keys, or to return from remote (HP-IB) to local operation, press the UNLOCK/LOCAL key.

2-33. When no further changes are needed in front panel function values, the DATA ENTRY knob may be disconnected from front panel functions without locking the front panel keys. This is done by pressing the HOLD key.

Table 2-1. AC Power Cables Available

PLUG TYPE	CABLE HP PART NO.	C D	PLUG DESCRIPTION	CABLE LENGTH (INCHES)	CABLE COLOR	FOR USE IN COUNTRY
250V 	8120-1351 8120-1703	0 6	Straight *BS1363A 90°	90 90	Mint Gray Mint Gray	United Kingdom, Cyprus, Nigeria, Rhodesia, Singapore
250V 	8120-1369 8120-0696	0 4	Straight *NZSS198/ASC 90°	79 87	Gray Gray	Australia, New Zealand
250V 	8120-1689 8120-1692	7 2	Straight *CEE7-Y11 90°	79 79	Mint Gray Mint Gray	East and West Europe, Saudi Arabia, Egypt, So Africa, India (Unpolarized in many nations)
125V 	8120-1348 8120-1398 8120-1754 8120-1378 8120-1521 8120-1676	5 5 7 1 6 2	Straight *NEMA5-15P 90° Straight *NEMA5-15P Straight *NEMA5-15P 90° Straight *NEMA5-15P	80 80 36 80 80 36	Black Black Black Jade Gray Jade Gray Jade Gray	United States, Canada, Japan (100V or 200V), Mexico, Philippines, Taiwan
<p>*Part number shown for plug is industry identifier for plug only. Number shown for cable is HP Part Number for complete cable including plug.</p> <p>E = Earth Ground L = Line N = Neutral</p>						

Table 2-1. AC Power Cables Available (Continued)

PLUG TYPE	CABLE HP PART NO.	C D	PLUG DESCRIPTION	CABLE LENGTH (INCHES)	CABLE COLOR	FOR USE IN COUNTRY
250V 	8120-2104	3	Straight *SEV1011 1959-24507 Type 12	79	Gray	Switzerland
250V 	8120-0698	6	Straight *NEMA6-15P			United States, Canada
220V 	8120-1957 8120-2956	2 3	Straight *DHCK 107 90°	79 79	Gray Gray	Denmark
250 V 	8120-1860	6	Straight *CEE22-VI (Systems Cabinet use)			
<p>*Part number shown for plug is industry identifier for plug only. Number shown for cable is HP Part Number for complete cable including plug.</p> <p>E = Earth Ground L = Line N = Neutral</p>						

10873A RACK MOUNT

CONTENTS

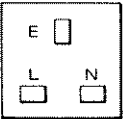
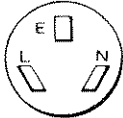
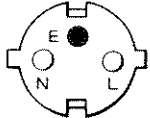
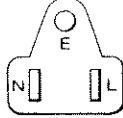
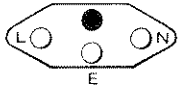
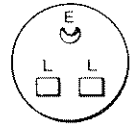
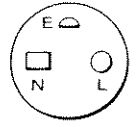
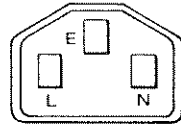
ITEM#	QTY	DESCRIPTION	PART#
1	1	PANEL BLANK-FRONT	12680-01002
2	1	DRESS PANEL-BOTTOM	05180-00027
3	2	RACK MOUNT FLANGE (WITH HANDLES)	5020-8874
4	2	RACK MOUNT FLANGE (WITHOUT HANDLES)	5020-8882
5	2	RAIL-INSTRUMENT SUPPORT	12679-20001
6	4	#8-32x5/8 F.H. SCREW	2680-0119
7	4	WASHER-FINISH	3050-0248
8	4	WASHER-CUPPED	3050-0007
9	4	#8-32x5/8 SCREW	2570-0194
10	4	#8-32x3/8 SCREW	2510-0193
11	4	1/4-20 CHANNEL NUT	0590-0789
		1/4-20x1 BOLT	0570-0068
		1/4 WASHER	2190-0023

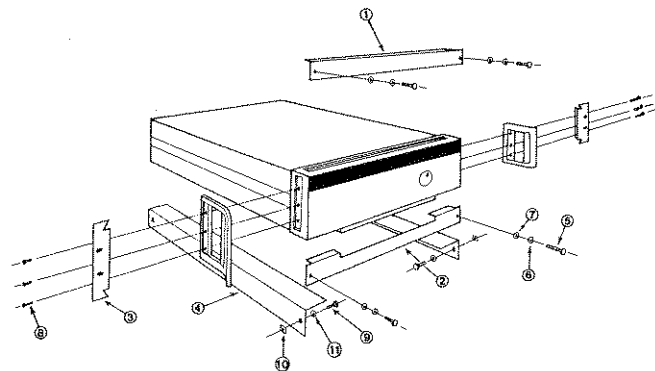

INSTRUCTIONS

1. REMOVE SIDE TRIM STRIPS COVERING HANDLE ASS'Y SCREWS AND DISCARD.
2. REMOVE 3 SCREWS FROM EACH HANDLE ASS'Y AND DISCARD.
3. ATTACH RACK MOUNT FLANGES WITH HANDLES USING 5/8" SCREWS OR WITHOUT HANDLES USING 3/8" SCREWS.
4. INSTALL INSTRUMENT SUPPORT RAILS INCLUDING SPACE FOR DRESS PANELS (ITEMS 1 & 2).
5. REMOVE FEET AND TILT STANDS BEFORE RACK MOUNTING.

10874A SLIDE RACK MOUNT

CONTENTS

ITEM#	QTY	DESCRIPTION	PART#
1	1	STANDARD SLIDE KIT	1494-0017
2	1	PANEL BLANK-FRONT	12680-01002
3	1	DRESS PANEL-BOTTOM	05180-00027
4	2	RACK MOUNT FLANGE (WITH HANDLES)	5020-8874
5	2	RACK MOUNT FLANGE (WITHOUT HANDLES)	5020-8862
6	4	WASHER-FINISH	3050-0248
7	4	WASHER-CUPPED	3050-0007
8	4	#8-32x5/8 F.H. SCREW	2680-0119
6	6	#8-32x5/8 SCREW	2510-0194
6	6	#8-32x3/8 SCREW	2510-0193

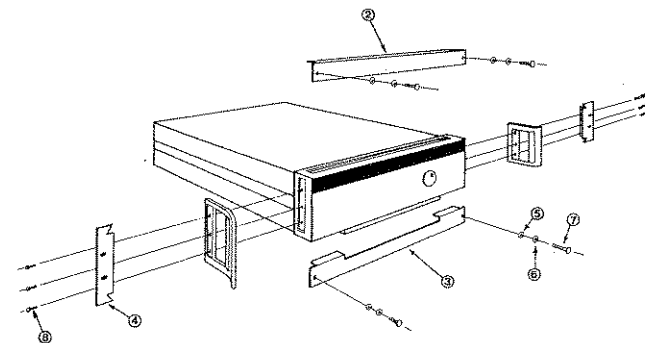

INSTRUCTIONS

1. REMOVE SIDE TRIM STRIPS COVERING HANDLE ASS'Y SCREWS AND DISCARD.
2. REMOVE SIDE 3 SCREWS FROM EACH HANDLE ASS'Y AND DISCARD.
3. ATTACH RACK MOUNT FLANGES WITH HANDLES USING 5/8" SCREWS OR WITHOUT HANDLES USING 3/8" SCREWS.
4. REMOVE FEET AND TILT STANDS BEFORE RACK MOUNTING.
5. INSTALL SLIDES AS PER 1494-0017 SLIDE KIT.
6. INSTALL 5180 INTO RACK WITH DRESS PANELS IN PLACE (ITEMS 2 & 3). THIS SPACE REQUIRED FOR AIRFLOW!

Figure 2-3. Installation of Rack Mount Kits

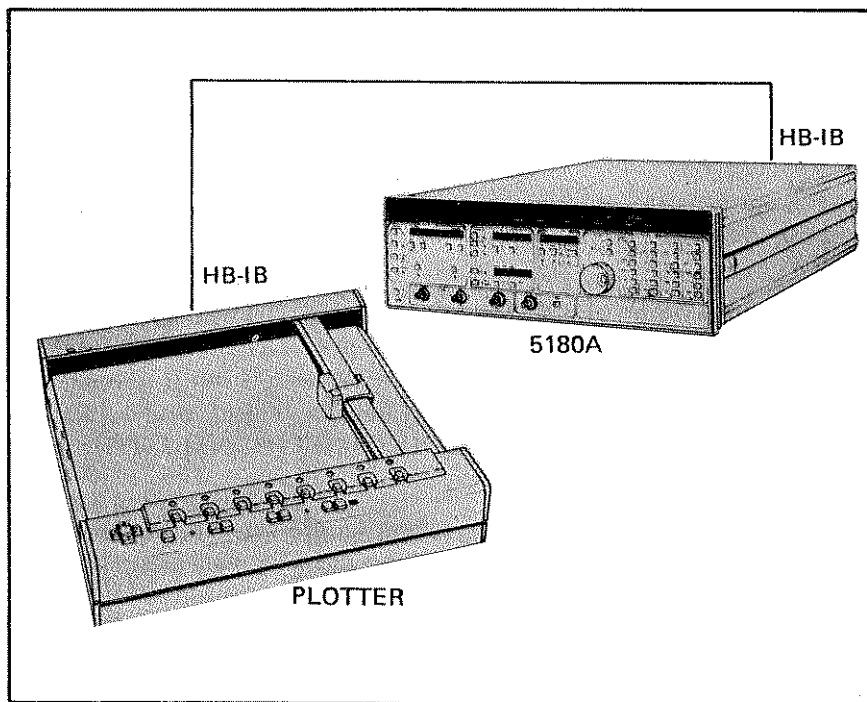

Figure 2-4. Setup for Direct Output from 5180A

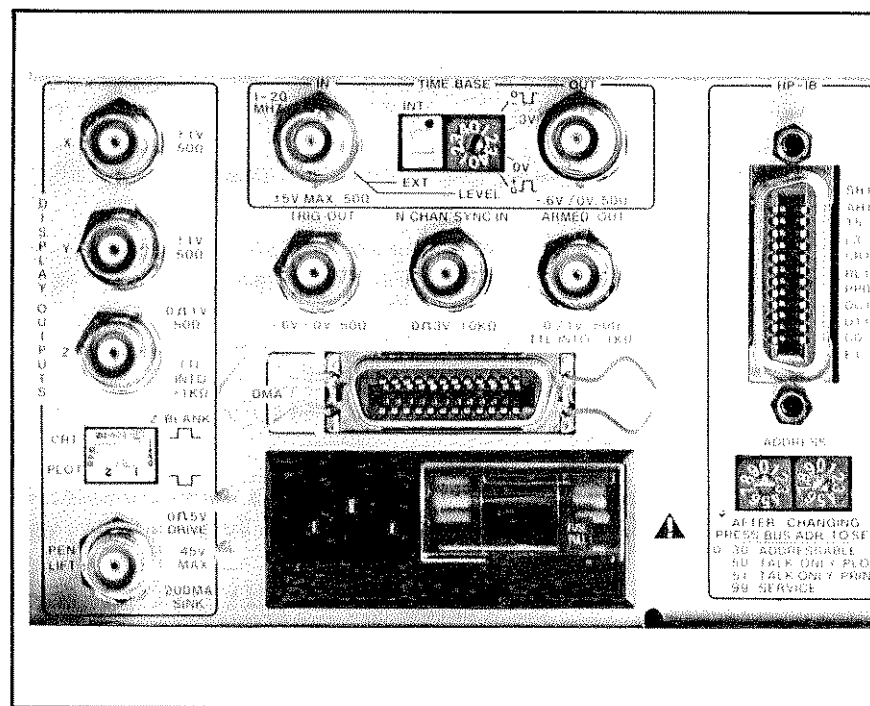

Figure 2-5. Rear Panel Switch Settings

2-34. HP-IB CONTROLLED OUTPUT

2-35. The 5180A provides digital and analog outputs, display of the bus address, and selection of output as described in the following paragraphs. Refer to Programming, Section III, for details on HP-IB operation.

2-36. Digital Output Format

2-37. Several HP-IB output modes may be controlled from the front panel of the 5180A, depending on the instrument's current HP-IB address and the setting of the CRT/PLOT switch on the rear panel, Figure 2-5. If the CRT/PLOT switch is set for CRT and the 5180A is assigned a TALK ONLY HP-IB address (Addresses 50-52), the 5180A provides digital output formats as follows (digital plotter must be in LISTEN ONLY):

- Address 50: HP-GL output to 7225A, 9872B plotters without page advance capability.
- Address 51: Digital output to printers and other tabular output devices, such as 2631A.
- Address 52: HP-GL output to 7245A, 9872 plotters with page advance capability.

2-38. Analog Output Format

2-39. When the CRT/PLOT switch is set for PLOT, and the 5180A's HP-IB address is 50, 51, or 52, the 5180A provides an analog output format suitable for XY recorders. Since these recorders often do not operate at high speeds, the 5180A's maximum output speed may be controlled from the instrument's front panel. The user may specify a minimum time delay between plotting of two sample points, from 100 to 400 ms, in 50 ms increments.

2-40. Selecting Bus Address and Output

2-41. To obtain a display of the 5180A's HP-IB address, press SHIFT key then BUS ADDR. Output via HP-IB is initiated by pressing SHIFT, then OUTPUT. If OUTPUT is pressed when the 5180A is not assigned a TALK ONLY HP-IB address (addresses 50-52), the 5180A can initiate a service request indicating it is ready to output a plot. When an XY recorder is used, a minimum time delay between plotting of sample points may be selected by pressing the SHIFT key, then the SPEED key, and turning the DATA ENTRY knob.

2-42. HP-IB Interconnections

2-43. HEWLETT-PACKARD INTERFACE BUS. Interconnection data concerning the rear panel HP-IB connector is provided in *Figure 2-6*. This connector is compatible with the HP 10833A/B/C/D HP-IB cables. The HP-IB system allows interconnection of up to 15 (including the controller) HP-IB compatible instruments. The HP-IB cables have identical "piggy-back" connectors on both ends so that several cables can be connected to a single source without special adapters or switch boxes. System components and devices may be connected in virtually any configuration desired. There must, of course, be a path from the calculator (or other controller) to every device operating on the bus. As a practical matter, avoid stacking more than three or four cables on any one connector. If the stack gets too large, the force on the stack produces great leverage which can damage the connector mounting. Be sure each connector is firmly (finger tight) screwed in place to keep it from working loose during use.

2-44. CABLE LENGTH RESTRICTIONS. To achieve design performance with the HP-IB, proper voltage levels and timing relationship must be maintained. If the system cable is too long, the lines cannot be driven properly and the system will fail to perform properly. Therefore, when interconnecting an HP-IB system, it is important to observe the following rules:

- a. The total cable length for the system must be equal to or less than 2 metres (6.6 feet) times the total number of devices connected to the bus.
- b. The total cable length for the system must be less than or equal to 20 metres (65 feet).
- c. The total number of instruments connected to the bus must not exceed 15.

2-45. 5180A Listen/Talk Address

2-46. The 5180A contains a rear panel HP-IB instrument address selection switch. The ADDRESS switch is shown in *Figure 2-5*. Instructions for setting and changing the address are provided in Section III of this manual along with programming codes.

2-47. HP-IB Descriptions

2-48. A description of the HP-IB features of the 5180A is provided in Section III of this manual. A study of this information is necessary if the user is to operate the 5180A on the interface bus. Additional information concerning the design criteria and operation of the bus is available in IEEE Standard 488-1978, titled "*IEEE Standard Digital Interface for Programmable Instrumentation*".

2-49. INSTALLATION CHECKOUT

- 2-50. After installing the 5180A, an operational check should be performed to ensure the unit is operating properly. Perform the following steps:
- a. Before applying power set the service and DMA switches to normal position. Normal position is labeled on the internal top cover and shown in *Figure 2-2*.
 - b. Power-up test. Refer to paragraph 3-59 for power turn-on and paragraph 3-94 for error indications.
 - c. Self Test. Refer to paragraph 3-88 for self test procedures.
 - d. If the self test does not result in the display of a failure message, refer to Performance Tests, Section IV, of the Service Manual. If a failure message is displayed, refer to the Troubleshooting Procedures, Section VIII, of the Service Manual.

2-51. STORAGE AND SHIPMENT

2-52. Environment

2-53. The instrument may be stored or shipped in environments within the following limits:

TEMPERATURE	-40°C to +75°C
HUMIDITY	Up to 95%
ALTITUDE	7,620 metres (25,000 feet)

2-54. The instrument should also be protected from temperature extremes which cause condensation within the instrument.

2-55. Packaging

2-56. ORIGINAL PACKAGING. Containers and materials identical to those used in factory packaging are available through Hewlett-Packard for servicing, attach a tag indicating the type of service required, return address, model number, and full serial number. Also, mark the container FRAGILE to ensure careful handling. In any correspondence, refer to the instrument by model number and full serial number.

2-57. OTHER PACKAGING. The following general instructions should be used for repacking with commercially available materials:

- a. Wrap instrument in heavy paper or plastic. (If shipping to Hewlett-Packard office or service center, attach tag indicating type of service required, return address, model number, and full serial number.)
- b. Use strong shipping container. A double-wall carton made of 2.4 MPa (350 psi) test material is adequate.
- c. Use a layer of shock-absorbing material 70 to 100 mm (3- to 4-inch) thick around all sides of the instrument to provide firm cushioning and prevent movement inside container. Protect control panel with cardboard.
- d. Seal shipping container securely.
- e. Mark shipping container FRAGILE to ensure careful handling.
- f. In any correspondence, refer to instrument by model number and full serial number.

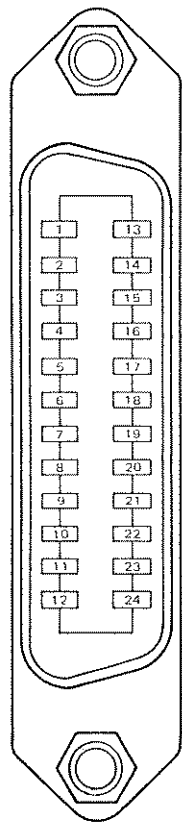

PIN	LINE	
1	DIO1	
2	DIO2	
3	DIO3	
4	DOI4	
13	DIO5	
14	DIO6	
15	DIO7	
16	DIO8	
5	EOI	
17	REN	
6	DAV	
7	NRFD	
8	NDAC	
9	IFC	
10	SRQ	
11	ATN	
12	SHIELD-CHASSIS GROUND	} THESE PINS ARE INTERNALLY GROUNDED
18	P/O TWISTED PAIR WITH PIN 6	
19	P/O TWISTED PAIR WITH PIN 7	
20	P/O TWISTED PAIR WITH PIN 8	
21	P/O TWISTED PAIR WITH PIN 9	
22	P/O TWISTED PAIR WITH PIN 10	
23	P/O TWISTED PAIR WITH PIN 11	
24	ISOLATED DIGITAL GROUND	

CAUTION

The 5180A contains metric threaded HP-IB cable mounting studs as opposed to English threads. Metric threaded HP 10631A, B, C, or D HP-IB cable lock screws must be used to secure the cable to the instrument. Identification of the two types of mounting studs and lock screws is made by their color. English threaded fasteners are colored silver and metric threaded fasteners are colored black. DO NOT mate silver and black fasteners to each other or the threads of either or both will be destroyed. Metric threaded HP-IB cable hardware illustrations and part numbers follow.

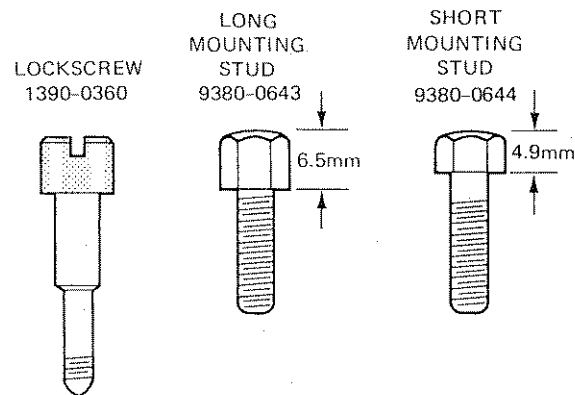

LOGIC LEVELS

The Hewlett-Packard Interface Bus logic levels are TTL compatible, i.e., the true (1) state is 0.0V dc to 0.4V dc and the false (0) state is +2.5V dc to +4.0V dc.

PROGRAMMING

Refer to Section III, Operation and Programming.

MATING CONNECTOR

HP 1251-0293; Amphenol 57-30240.

MATING CABLES AVAILABLE

- HP 10833A, 1 metre (3.28 ft.).
- HP 10833B, 2 metres (6.56 ft.).
- HP 10833C, 4 metres (13.12 ft.).
- HP 10833D, 0.5 metre (1.64 ft.).

CABLING RESTRICTIONS FOR STANDARD SYSTEM

1. A Hewlett-Packard Interface Bus System may contain no more than 2 metres (6.6 ft.) of connecting cable per instrument.
2. The maximum accumulative length of connecting cable for any Hewlett-Packard Interface Bus System is 20.0 metres (65.6 ft.).

Figure 2-6. Hewlett-Packard Interface Bus Connections

SECTION III

OPERATION AND PROGRAMMING

3-1. INTRODUCTION

3-2. This section contains a detailed description of the following:

- a. Operating Characteristics, paragraph 3-3.
- b. Power Turn-On Checks, paragraph 3-60.
- c. Front Panel Controls, Indicators, and Connectors, paragraph 3-66.
- d. Front Panel Annunciators, paragraph 3-82.
- e. Rear Panel Controls and Connectors, paragraph 3-84.
- f. Operating Features, paragraph 3-86.
- g. Error Indications, paragraph 3-94.
- h. Operating Procedures, paragraph 3-101.
- i. Programming, paragraph 3-154.
- j. HP-IB Commands, paragraph 3-165.
- k. Programming Examples, paragraph 3-191.

3-3. OPERATING CHARACTERISTICS

3-4. The 5180A is generally described as an analog-to-digital converter with memory. The A/D converter samples the input signal at selectable rates (up to 20 MHz) and stores the resulting 10-bit digital codes in the 16K memory. The stored digital codes represent the instantaneous voltage of the input analog waveform at each sample point.

3-5. Real-time conversion of 20 million samples-per-second coupled with high-speed data storage enable the 5180A to capture and analyze single-shot or repetitive waveforms with frequency components to 10 MHz. After being stored in memory, the captured waveform may be output in both analog and digital formats. Analog XYZ drive circuitry, using D/A converters, converts the digitized waveform into repetitive playback signals for flicker-free display on oscilloscopes, large screen displays, or XY recorders. Digital outputs using HP-IB (IEEE 488-1978) and all parallel (DMA) formats permit computer analysis of waveforms in addition to permanent storage of waveforms on magnetic tape and disk. The 5180A waveform recorder is a fully programmable instru-

ment that operates as an integral part of a programmable signal processing system.

3-6. Basic Circuits and Measurements

3-7. The 5180A has three inputs, Channels A, B, and AUX (auxiliary). The circuits are shown in simplified form in *Figure 3-1*, and are described as follows:

- a. Channel A and B Input Amplifiers provide oscilloscope-type high impedance input channels with full scale range variable from ± 100 mV to ± 10 V in a 1-2-5 sequence. In dual Channel A/B mode, sampling is alternated between Channel A and B for two-channel recording at a maximum rate of 5 MHz per channel.
- b. AUX Channel is a 50-ohm input impedance connected directly to the Analog-to-Digital (ADC) circuit without attenuation or ac coupling.
- c. As shown in *Figure 3-1*, the ADC in the 5180A is 10 bits wide. This means that 1024 different codes can be generated, 0-1023. The output of the ADC is offset 512, meaning that the code 512 corresponds to 0 volts, and the codes 0 and 1023 correspond to minus full scale and full scale, respectively.
- d. Two terms are used to separate the ideas of "full scale range" and "attenuation setting". We will call the total voltage measurable the "full scale range". The nominal voltage range (the attenuator setting) will be called simply the "range".
- e. The AUX channel input goes directly into the ADC. Its full scale range is from -1.024 to $+1.022$ volts. Since there are 1024 codes, each code differs from the previous one by .002 volts. When using either the A or B Channels, this full scale range is multiplied by the "range" (attenuation setting) to get the new full scale range. The AUX channel "range" is always 1.
- f. All measurements within the 5180A take the current full scale range into account. Thus, when making cursor measurements, or setting trigger levels, the range of numbers is (-1.024) (range) to $(+1.022)$ (range). The step from code to code is also multiplied by the same factor. HP-IB data comes out of the 5180A as codes from 0 to 1023.

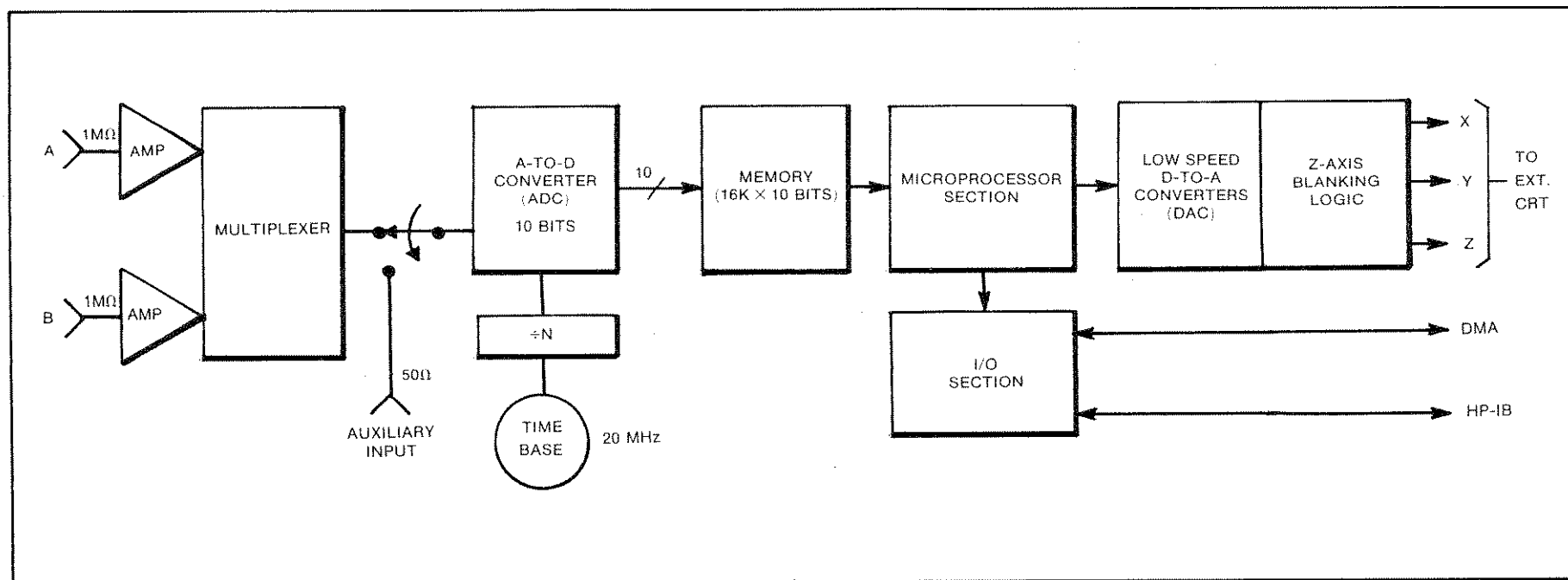

Figure 3-1. 5180A Simplified Block Diagram

3-8. Overall Performance

3-9. To specify the performance of a waveform recorder for static inputs is of little value when trying to evaluate an actual measurement on high slew-rate signals, especially since the performance of an ADC may degrade significantly with increasing slew rate. To ensure meaningful specifications, a variety of testing techniques is used to test the dynamic performance (see Section IV). These techniques and other applications for the 5180A are described in detail in application notes which are available from your nearest HP Sales and Service Office, listed at the back of this manual. The main features of the 5180A are explained in the following paragraphs.

3-10. Precision Time and Voltage Measurements Using Zoom, Gain, Cursor and Cursor Δ

3-11. The 5180's zoom and cursor features allow quantitative time and voltage measurements, as described in the examples in paragraphs 3-12 through 3-17.

3-12. TURN-ON TRANSIENT FOR SIGNAL GENERATOR. *Figure 3-2* shows the turn-on transient, where the dot shows the trigger point. Since the 5180A was set for -20% trigger position, 20% of the memory contains data that occurred before the trigger and 80% of memory occurred after the trigger (see paragraph 3-23 for triggering descriptions).

3-13. DURATION OF TURN-ON TRANSIENT. The position of the cursors is controlled by the data entry knob. Position Cursor at the start of the transient and position Cursor Δ at the end of the transient. In cursor time mode, the 5180A displays the time interval between the Cursors. In this case, it's the duration of the turn-on transient, also shown in *Figure 3-2*.

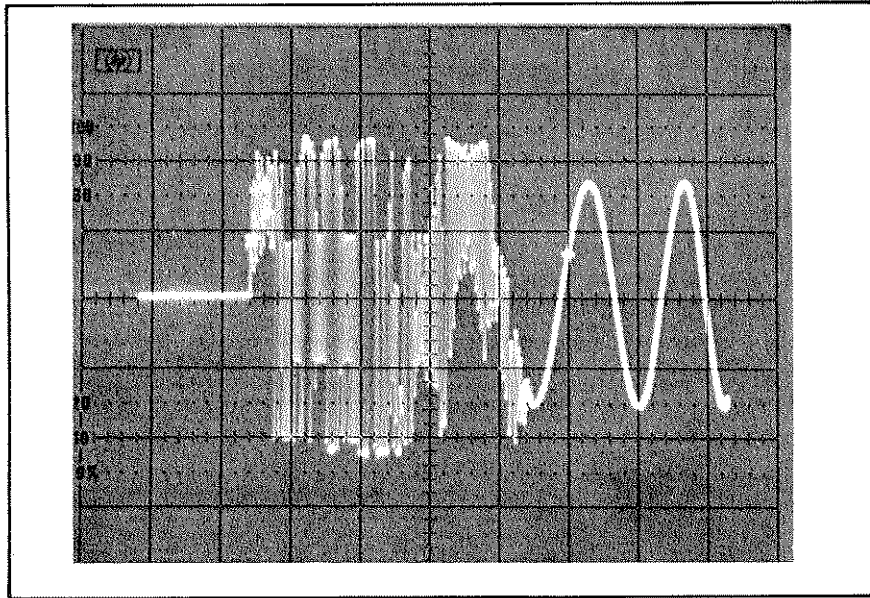

Figure 3-2. Turn-On Transient for Signal Generator

3-14. PEAK-TO-PEAK VOLTAGE OF TRANSIENT. As shown in *Figure 3-3*, position the cursors at the minimum and maximum points, place the 5180A in Cursor Volts mode, and read the peak-to-peak voltage of the transient. To find the absolute voltage of any point on the waveform, use only one cursor.

3-15. POSITIONING CURSOR FOR ZOOMING. By positioning the cursor at a point of interest, the GAIN OFFSET, ZOOM, and POSITION controls may be used to get more detail. The vertical and horizontal scale expands about the cursor as you select the expansion factor with the data entry knob. See *Figure 3-4*.

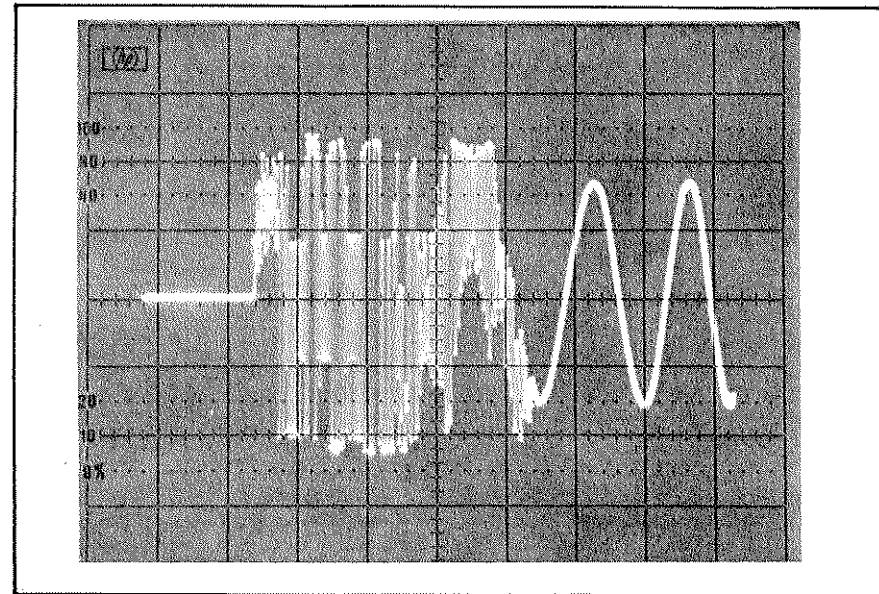

Figure 3-3. Peak-to-Peak Voltage of Transient

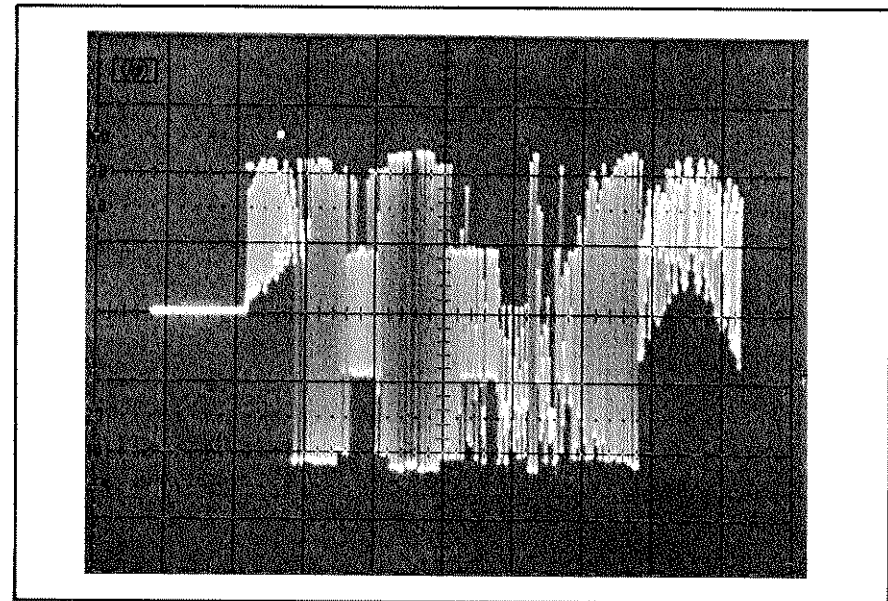

Figure 3-4. Positioning Cursor for Zooming

3-16. ZOOM DISPLAY. With the scale expanded so that $\frac{1}{16}$ th of the original record fills the display, the cursors can be used to measure the period of the oscillation in the transient. See *Figure 3-5*.

3-17. Trigger Features

3-18. Triggering may be based on the incoming signal waveform (internal triggering), or on an external trigger signal (external or manual triggering). The trigger level may be precisely specified by the user, and samples of the incoming waveform or external trigger signal are compared to the selected value. The slope of the signal which produces a trigger is also user-selectable, and may be rising slope, falling slope, or bidirectional.

3-19. Pre- and Post-Triggering

3-20. Storing a digitized signal beginning before or some time after the trigger point is possible using the 5180A's pre- and post-trigger recording features. Pre-trigger recording allows information to be recorded before the trigger point, which aids the user in determining the cause of the trigger. Post-trigger recording inserts a precise, user-selectable delay between the trigger point and the beginning of recording into memory. This feature is important if the portion of the incoming waveform containing useful information occurs a specific length of time after trigger conditions are met.

3-21. PRE-TRIGGER. When the 5180A is armed for triggering, new data is continually recorded into memory, replacing previously stored data. If pre-trigger mode is selected, part or all of the data stored in memory at the time of the trigger is saved. Trigger position settings for pre-trigger mode range from -1% to -100%. This means that between 1% and 100% of the memory may be filled before the trigger point. For example, using internal triggering, a turn-on transient may be used to generate a trigger as shown in *Figure 3-6*. Setting the trigger position for -20% will store data into 20% of the memory before the trigger occurs, and fill 80% of the memory with data after the trigger. Thus, information recorded before the trigger point may be used to measure the rise time and duration of the transient.

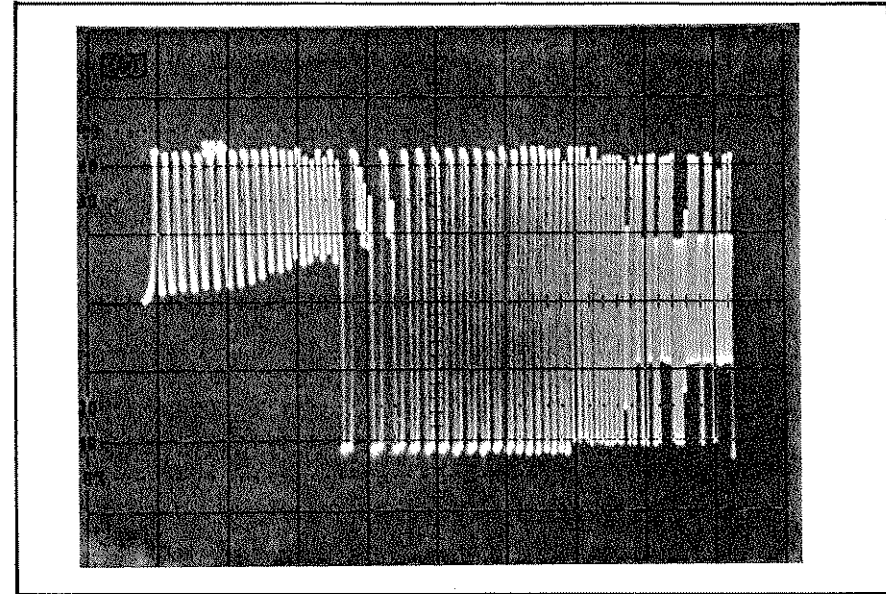

Figure 3-5. Zoom Display

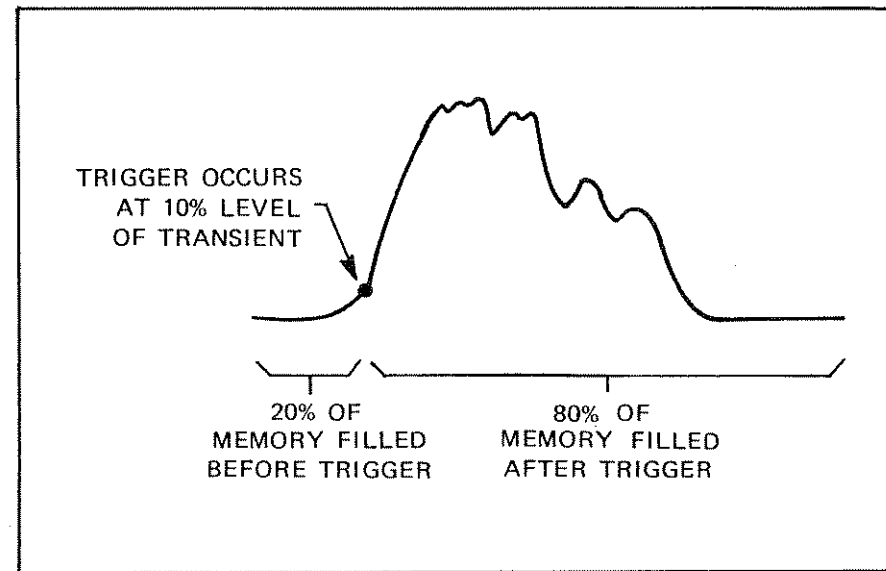

Figure 3-6. Display of Transient Using -20% Pre-Trigger

3-22. **POST-TRIGGER.** If a waveform to be recorded occurs some time after the trigger point, storage of data may be postponed using the 5180A's post-trigger recording feature. This feature allows the memory to be filled beginning as long as 1 million sample times after the trigger point. Trigger settings for post-trigger mode may be specified in terms of time or percentage of memory. (If an amount larger than 9999% is desired, however, the trigger position must be given in terms of time.) Thus, recording begins after a post-trigger delay of the selected time. For example, an external trigger signal may be available 256 μ s before the beginning of the signal to be recorded. If the sampling rate is 1 μ s/sample point and the memory record length is 1024, then the post-trigger position may be specified as either 256 μ s or 25% of memory as shown in Figure 3-7.

3-23. **INTERNAL TRIGGERING.** When triggering is based on the incoming waveform (internal triggering), the 5180A employs a precise digital trigger. After the user specifies the trigger level, the 5180A converts this value into a 10-bit digital word, which is compared with the output of the A/D converter each time a sample of the incoming waveform is digitized. The trigger point is the first sample which meets the user-selected triggering conditions (see Figure 3-8).

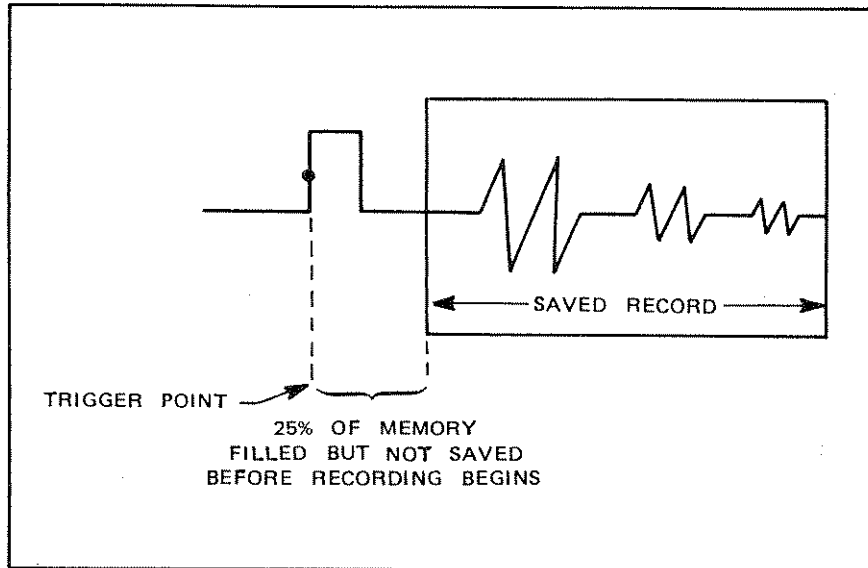

Figure 3-7. Display of Post-Trigger Recorded Data

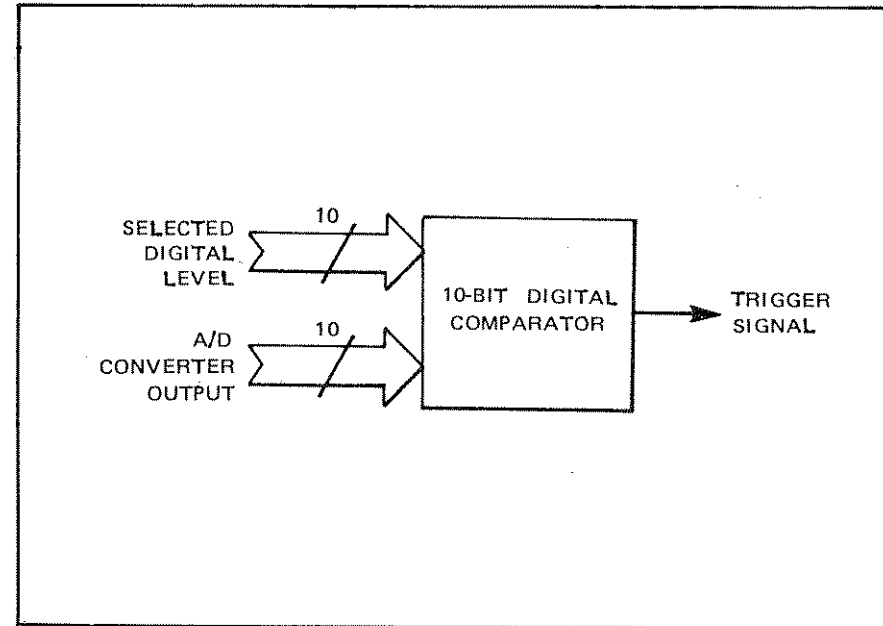

Figure 3-8. Digitized Samples Compared with Selected Trigger Level

3-24. Trigger Position Control

3-25. Figure 3-9 shows the 5180's memory as a time window that is positioned anywhere along the input signal. The width of this time window is equal to the record length multiplied by the sample rate (e.g., for a 16K record length and 50 ns sampling the time window is 0.8 millisecond). The trigger position feature allows sliding this time window along the signal waveform as shown in Figure 3-9. With -100% trigger position, 100% of memory is filled before the trigger point. Pre-trigger recording of this nature makes it possible to characterize rise and fall times, decay times, and fault analysis. When the trigger position is positive, a delay is inserted between the trigger and the start of recording. This is useful in cases where the portion of the signal of primary importance occurs sometime after the trigger. The range of post-trigger delay extends from 0 to 9999% of memory. Trigger position may be selected in absolute time values as well as percent of memory. The window may be positioned anywhere from -100% recording (trigger point is last location in memory; 100% of memory is filled before the trigger) to +9999% recording (a time delay of $99.99 \times \text{record length} \times \text{sample rate}$ occurs before the start of the recorded data).

3-26. Selectable Trigger Hysteresis

3-27. Trigger hysteresis is selectable to allow you to match sensitivity to your input waveform, for reliable triggering. Hysteresis, like trigger level, may be selected as a percent of full scale or absolute volts. For positive slope triggering, the 5180A produces a trigger when a digital sample of the input waveform becomes equal to or greater than the selected trigger level. For negative slope, triggering occurs when a digital sample reaches a value equal to or less than the selected trigger level. The hysteresis region is offset from the trigger level, if either rising or falling slope triggering is selected (see Figure 3-10). When triggering is on a rising slope, the hysteresis region is below the selected trigger level, and the incoming signal must fall below the hysteresis level before another trigger can occur. Conversely, when triggering occurs on a falling slope, the hysteresis region is above the trigger level, and the signal must exceed the hysteresis level before another trigger can occur.

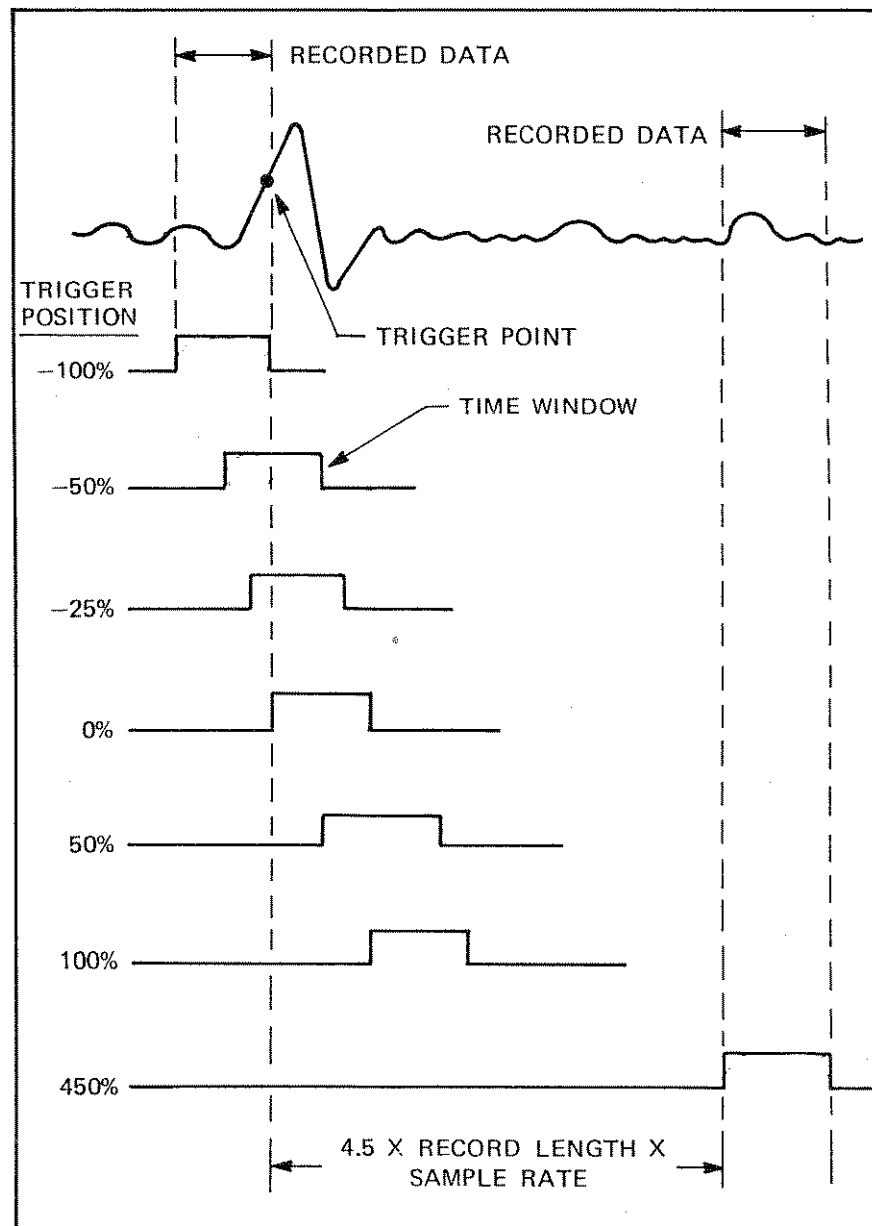

Figure 3-9. Trigger Position Selection of Recorded Data

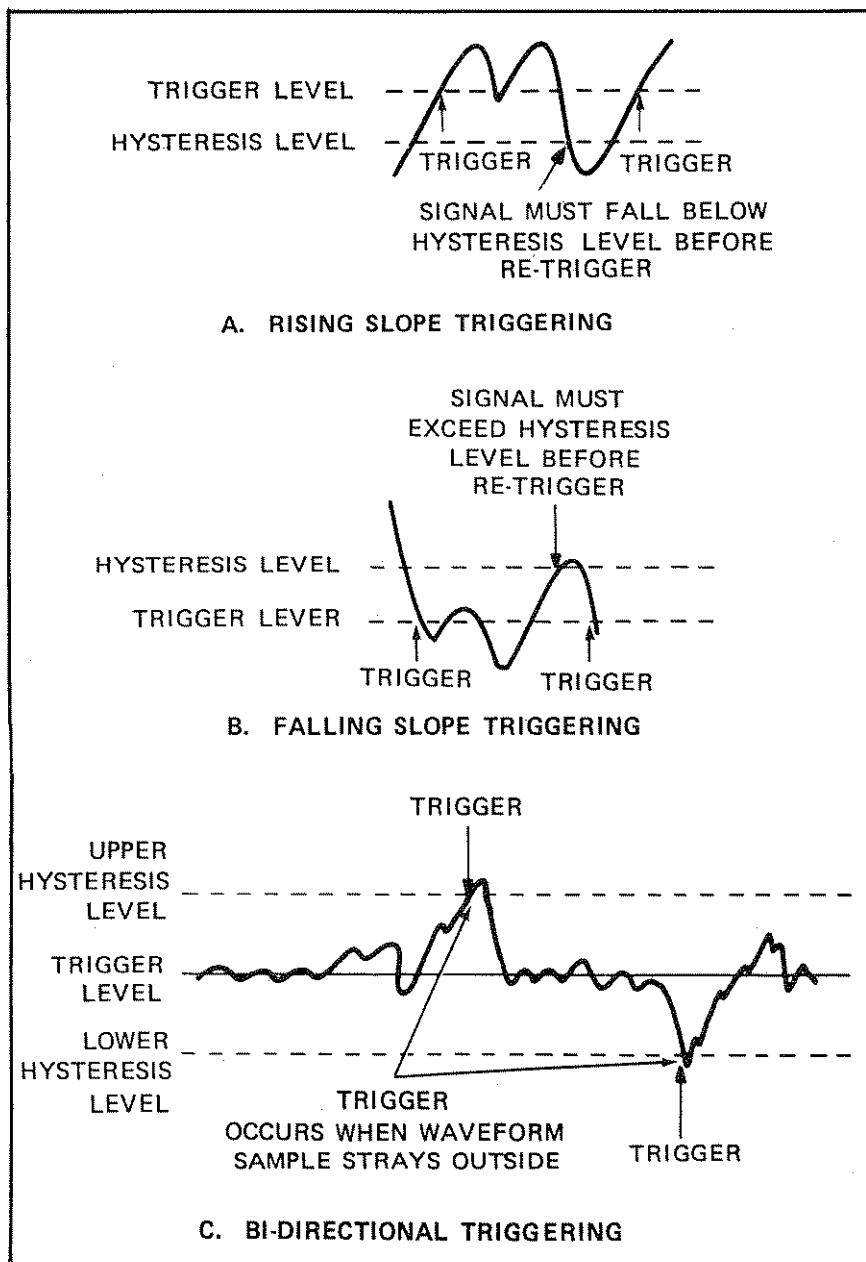

Figure 3-10. Selectable Hysteresis

3-28. If bidirectional slope triggering is selected, the trigger level and hysteresis features are redefined. In this case, the selected hysteresis region is centered about the trigger level, and triggering occurs when a digitized waveform sample strays outside the hysteresis region in either direction (see Figure 3-10). This feature is useful, for example, in monitoring a regulated power supply; if the voltage exceeds the upper hysteresis level or drops below the lower hysteresis level, the 5180A will trigger and record the waveform.

3-29. Two Timebases

3-30. You can select from two independent timebases and three timebase modes to optimize sampling rate, waveform rate of change and record length. The 5180A has two independent timebases, main and delayed. Both timebases may be set independently to provide sample intervals from 50 nanoseconds to 50 milliseconds per point.

3-31. The mixed mode of operation switches from the main to the delayed timebase, providing timing information across the boundary. In mixed mode, the timebase changes from main to delayed as specified by the TRIGGER POSITION control. This mode is very useful when recording signals which are characterized by predictable differences in waveform slew rate. For example, by recording the fast rise time of a signal at a high sample rate and then switching to a low sample rate to record the slow decay, record length and signal observation time may be optimized.

3-32. The transient recorded in (A), (B), and (C) in Figure 3-11 is characterized by a fast rise time and a slower exponential decay. In (A) a fast sample rate adequately captures the rise time but misses the decay time. In (B), a slower sample rate captures the decay time but is too slow to adequately characterize the rise time. In (C), the mixed mode switches between timebases, allowing both rise and fall to be characterized. Synchronous switching between timebases ensures valid timing measurements between data points on opposite sides of the timebase change point.

3-33. In toggle mode, the sampling process is governed by the main timebase, then the delayed timebase, and back to the main timebase. This is useful in measuring a relatively long time interval with 50 ns precision. For example, the handshake time between a CPU and a peripheral or time between a sonar pulse and the echo may be properly measured in toggle mode.

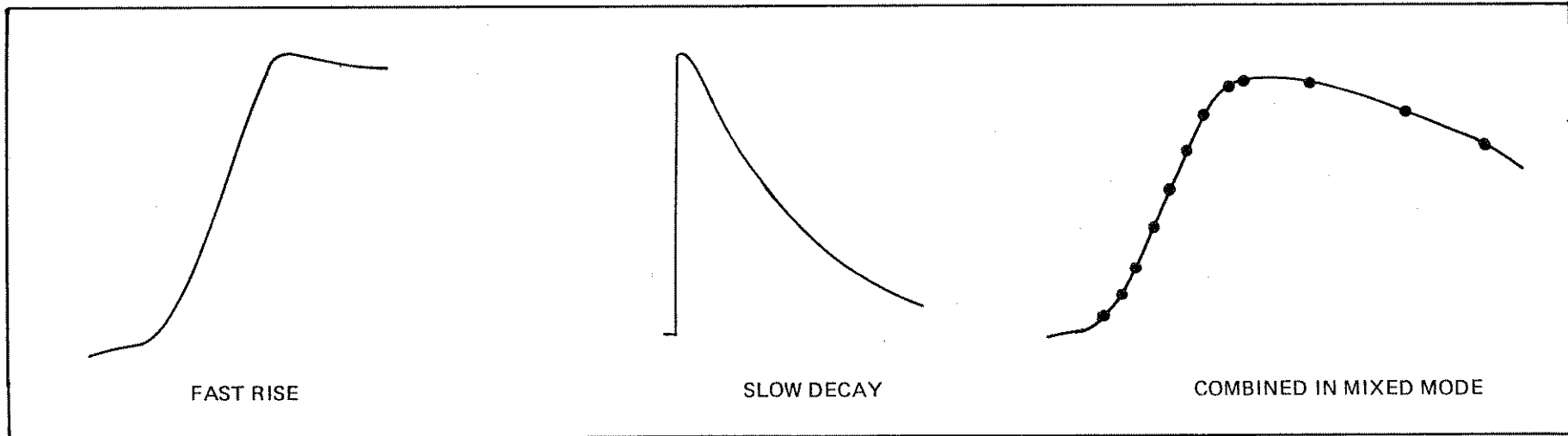

Figure 3-11. Fast Rise, Slow Decay, Combined in Mixed Mode

3-34. Memory Segmentation

3-35. You may store up to 32 different waveforms using memory segmentation. The 5180A's memory may be segmented into as many as 32 equal length records. Record lengths may be selected from 512 words each up to 16K. This means that you can allocate the entire memory to one record for recording highly complex waveforms at maximum sample rates.

3-36. Dual Mode

3-37. Any two of the stored records may be simultaneously displayed in the dual display mode. This means that you can visually make comparisons between a "reference" waveform and actual waveforms stored in other locations. The "reference" waveform can be output over the HP-IB to a mass memory device for indefinite storage and can likewise be read back into a particular memory location for use as the reference. The stored and "live" waveforms can be viewed simultaneously. This makes it easy to see, for example, the result of device adjustments while they are being made, as

shown in *Figure 3-12*. The photo shows two power supply turn-on transients. The upper trace shows a large overshoot which could damage sensitive components. The lower trace shows the turn-on transient for the same power supply but modified with a zener clamp diode on the output.

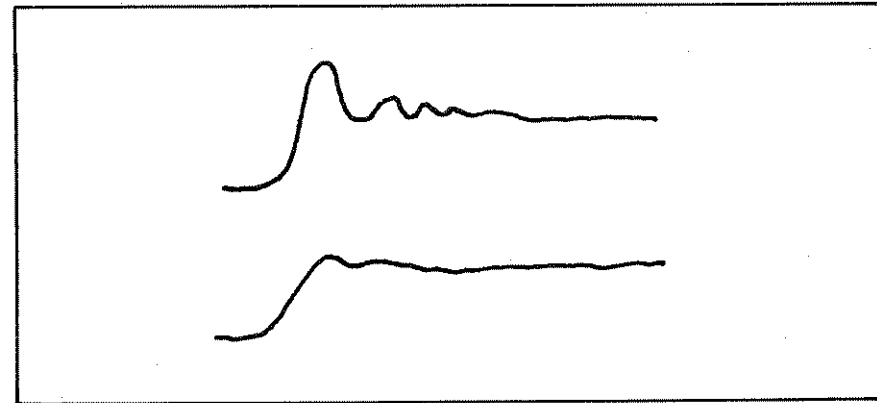

Figure 3-12. Dual Trace Mode

3-38. Auto Advance Mode

3-39. You can capture fast, successive events using auto advance mode. This mode automatically increments record location after each record so that successive triggers cause recording in successive memory locations until all memory is filled. At the conclusion of recording, up to 32 "snapshots" of the input signal will be stored in memory. The dead time between the end of the Nth record and the start of the (N+1)th record is variable from 5 ms to over 99 seconds. See *Figure 3-13*.

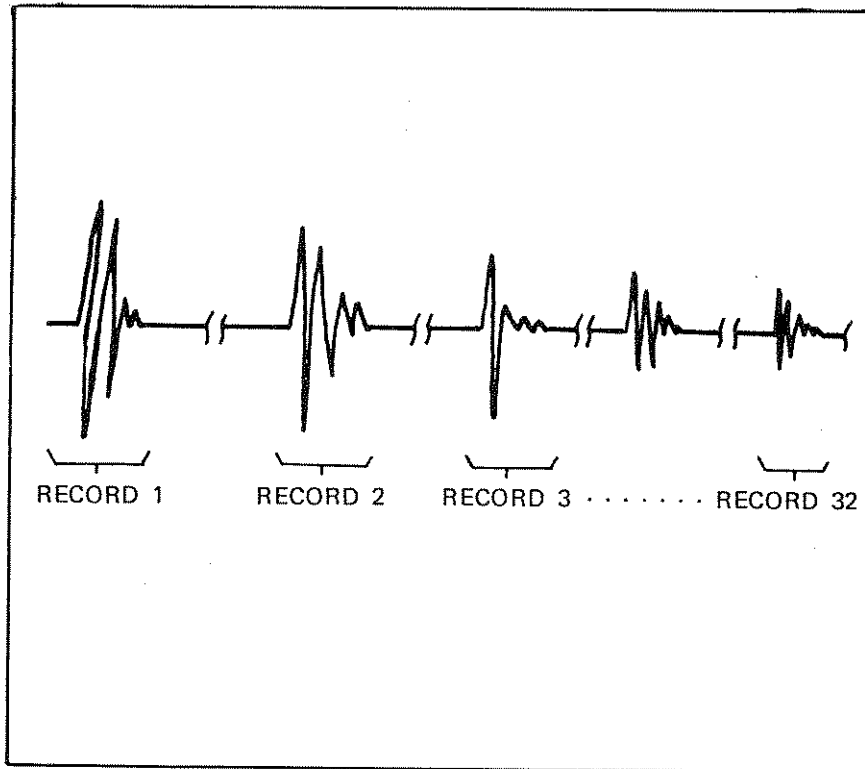

Figure 3-13. Auto Advance Records

3-40. Trace 1 Minus Trace 2 Function

3-41. You can see the differences between any two records by using the Trace 1 minus Trace 2 function. Pressing the TR1-TR2 key causes the record defined as Trace 2 to be subtracted from the record defined as Trace 1 on a point-by-point basis. The difference is displayed on the CRT (or other output device). This is extremely useful in determining the magnitude of small differences between waveforms or when it's desired to subtract out measurement system systematic errors from the measurement results. In *Figure 3-14* the improvement resulting from incorporating a zener diode clamp in the power supply output is obvious when TR1-TR2 is pressed. The 5180A displays the voltage difference between the cursors, which indicates the improvement.

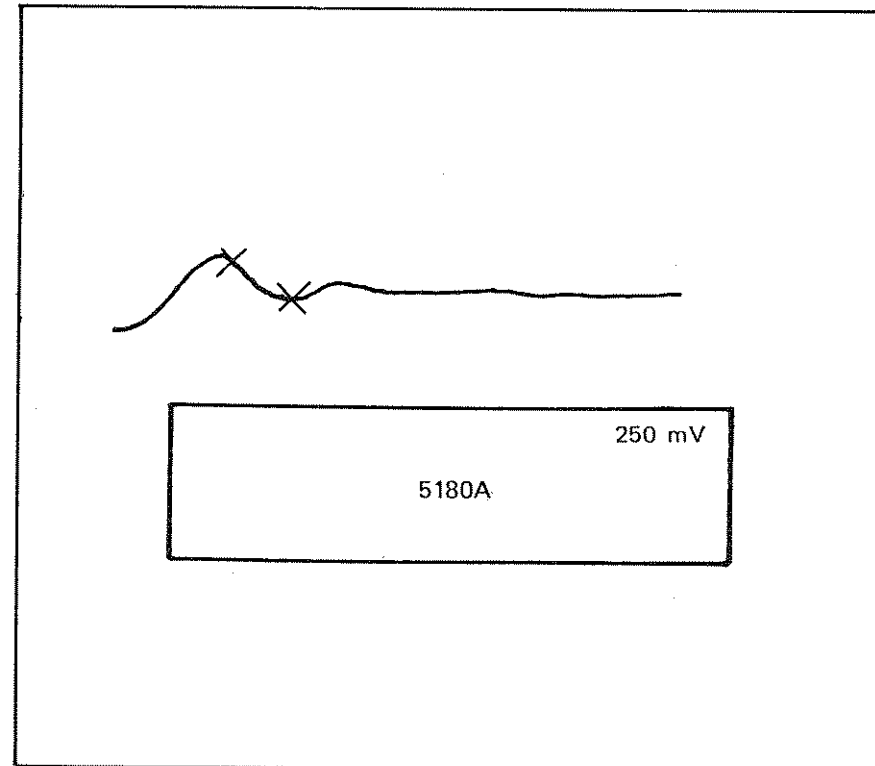

Figure 3-14. TR1-TR2 Function

3-42. Two Channel Recording

3-43. The 5180A provides a precision 50-ohm auxiliary input, Channel AUX. This input has a -1.024 to $+1.023$ -volt full-scale range. If your measurements require different full scale ranges or two channel recording, the Channel A, B Input Amplifiers provide these capabilities. The full-scale range of both Channel A and Channel B may be varied from ± 100 mV to ± 10 V in a 1-2-5 sequence. In Chop A,B mode sampling is alternated between Channel A and B. Two channel recording can take place at up to 5 million samples per second for each channel. Other features are: Offsets (controlled by an 8-bit DAC for HP-IB programmability), DC or AC coupling, and two point calibration using the built-in zero and 100 mV reference voltage. For low sample rates, this means that the sample points are virtually simultaneous. For example, you may wish to measure the transient power handled by the switching transistor in a switching regulator power supply at turn-on. By capturing both the current transient and voltage transient and multiplying the two records, transient power is easily obtained. In *Figure 3-15* the upper trace shows the transient current waveform in a switching regulator power supply. The lower trace shows the transient voltage across the switching transistor. These waveforms were captured simultaneously using the Channel A,B chop mode with a sample rate of 1 MHz per channel.

3-44. Five Output Data Formats

3-45. The following output data formats are provided:

- a. XYZ analog drive for an external CRT. This allows you to display the captured waveform on a flicker-free display along with trigger point marker and two cursors.
- b. XYZ analog drive to an analog XY recorder for hard-copy recording.
- c. HP-IB Talk Only output which outputs a completely annotated plot to HPGL (HP Graphics Language) compatible digital plotters such as the HP 9872B, HP 7225A, and HP 7245A.
- d. HP-IB Input/Output for IEEE 488-1978 systems compatibility.
- e. High-speed DMA Input/Output using a 16-bit parallel data bus. Word rates to 1 megaword/second can be achieved.

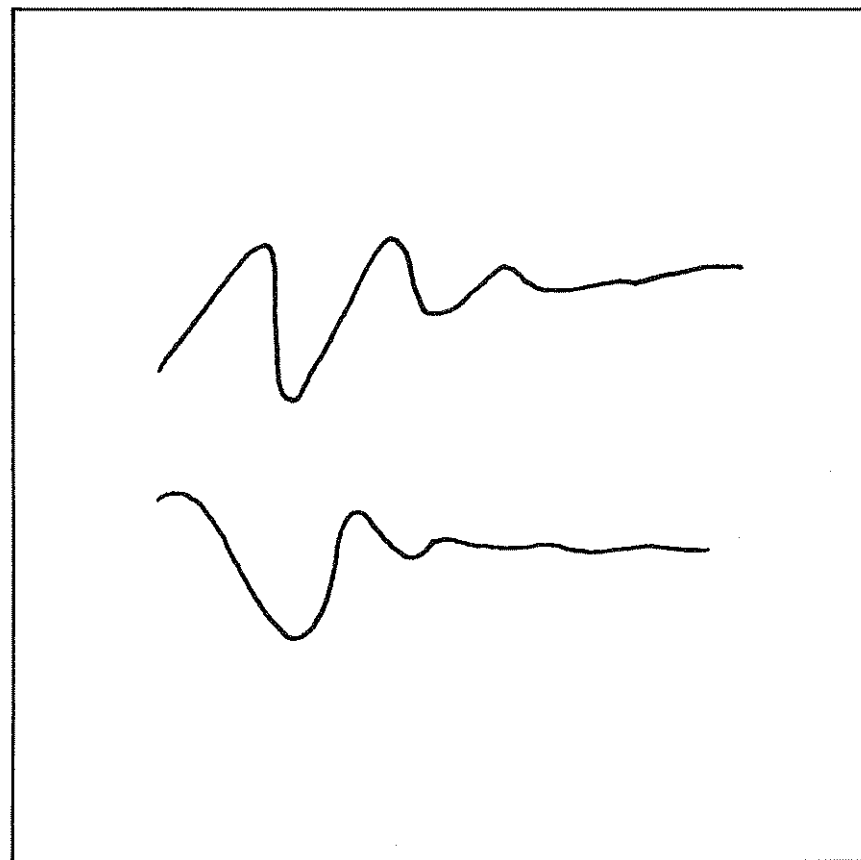

Figure 3-15. Channel A,B Chop Mode

3-46. N Channel Recording

3-47. Several 5180's may be connected together, as shown in *Figure 3-16*, for N channel recording. This setup provides synchronous sampling on N channels and also simultaneous triggering on all N channels. TRIG OUT, N CHAN SYNC IN, and TIMEBASE IN/OUT are rear panel signals which permit multiple 5180A's to operate synchronously.

3-48. SAVE and RECALL Functions

3-49. The SAVE and RECALL functions allow you to store (and recall later) up to four complete front panel configurations. The CMOS memory which stores the front panel information is maintained by an internal battery, so the settings are remembered even when the power is off. In addition, whenever the power is removed, the current state of the front panel is automatically stored in a fifth memory location and is automatically recalled upon power-up. This feature will save you time and prevent measurement errors due to incorrect set-ups.

3-50. Trigger Time Feature

3-51. For every record stored in memory, the time of occurrence of the trigger which caused that record is also stored. The time stored is the time interval from when the 5180A was powered up (or from the last "Set Zero" command) to the time of the trigger. This time is recorded with 50 millisecond resolution.

3-52. A special trigger timer in the 5180A records the time with respect to a preselected zero point at which the trigger for each memory record occurs. The zero point is the turn-on time of the 5180A, unless the timer is later set to zero by the user. Thus, if the time at which a waveform was recorded is needed, it is available as the trigger time of the memory record with respect to the zero point of the timer.

3-53. Systems Adaptability

3-54. The 5180A is a fully programmable systems instrument around which data acquisition/waveform analysis signal processing systems may be built. Program control of all front panel functions is easily implemented by any HP-IB compatible controller. Control is simplified by many built in automatic features and "learn" mode capabilities which simplify programming by inputting and outputting all control settings in single code blocks. The 5181A Waveform Data Recording System is a stand-alone addition to the 5180A. The 5181A displays recorded data on a built-in CRT and it records data from the 5180A onto a tape cartridge to provide hardcopy. The 5181A together with the 5180A, form the 5180T Waveform Recording System.

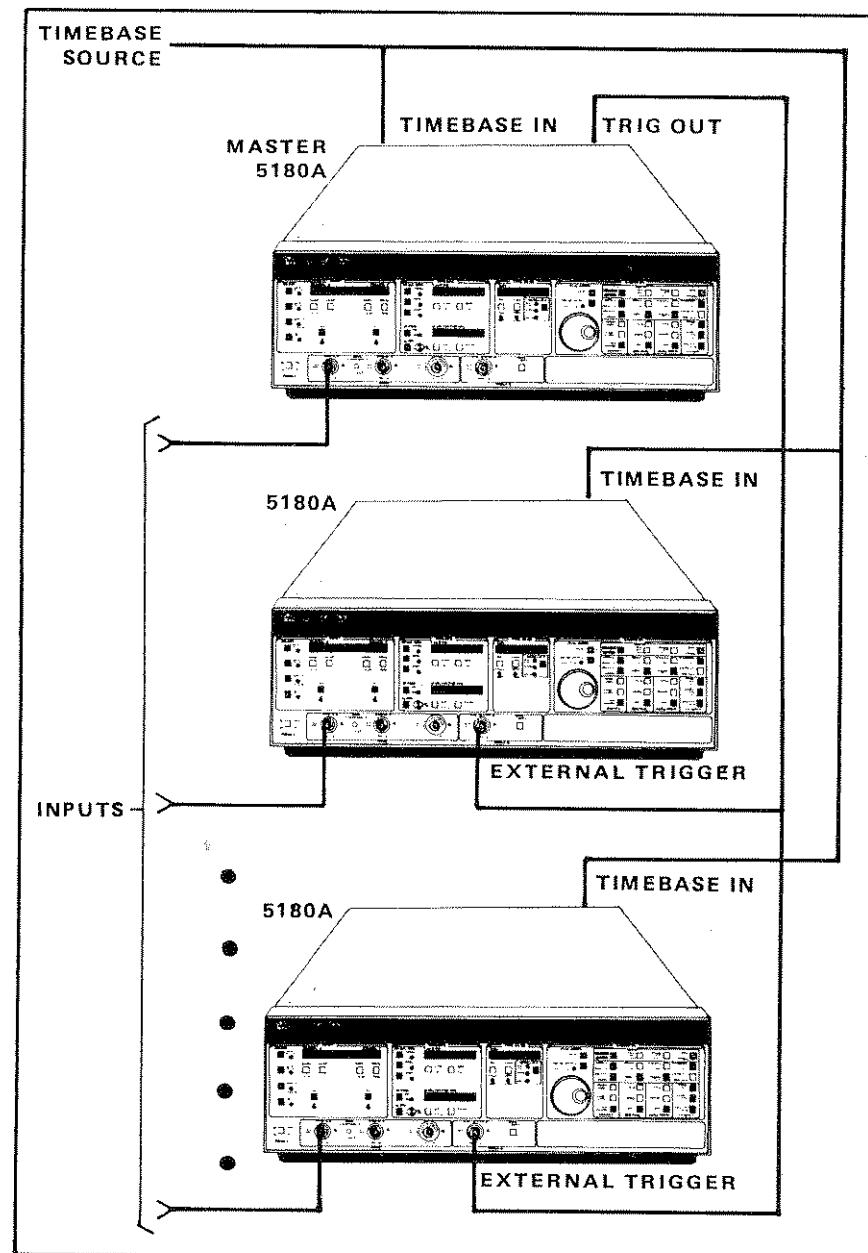

Figure 3-16. N Channel Recording

3-55. TYPICAL SYSTEMS SETUP. Figure 3-17 shows a typical systems setup which includes the 9825S Computing Controller and the 7245B Plotter/Printer. For faster measurement data I/O the 10872A (a 98032 16-bit I/O card with mating connector for the 5180A) can be used. HP-IB compatible instrumentation, such as synthesizers, switches, or the 9885M Option 025 Flexible Disc Drive may be added to the setup. For complete verification of the 5180A's dynamic specifications, the HP-3335A Frequency Synthesizer is recommended. Refer to Service Manual, Section IV, Performance Tests.

3-56. PROGRAMMABLE CONTROLS. Each front panel control may be programmed using a two-character code logically related to a front panel key. For example:

3: wrt "5180A", "LV-1.248, MP50e-9, CU249"

NOTE

In the above example, the 5180A's trigger level (LV) is set to -1.248 volts, the main time base is set to 50 ns per point (MP), and the cursor position is set to the 249th memory location (CU). For detailed programming information, refer to paragraph 3-154.

3-57. Summary of Operating Characteristics

3-58. Table 3-1 provides a summary of the 5180A's operating characteristics with a brief description of the capabilities and use of each characteristic.

3-59. POWER TURN-ON CHECKS

3-60. When power is applied to the 5180A, several self-checks occur automatically to verify proper operation of the microprocessor section, as follows:

- a. ROM checksum.
- b. RAM test.
- c. CMOS RAM checksum.
- d. XYZ test.
- e. High speed RAM test.
- f. Internal timer test.

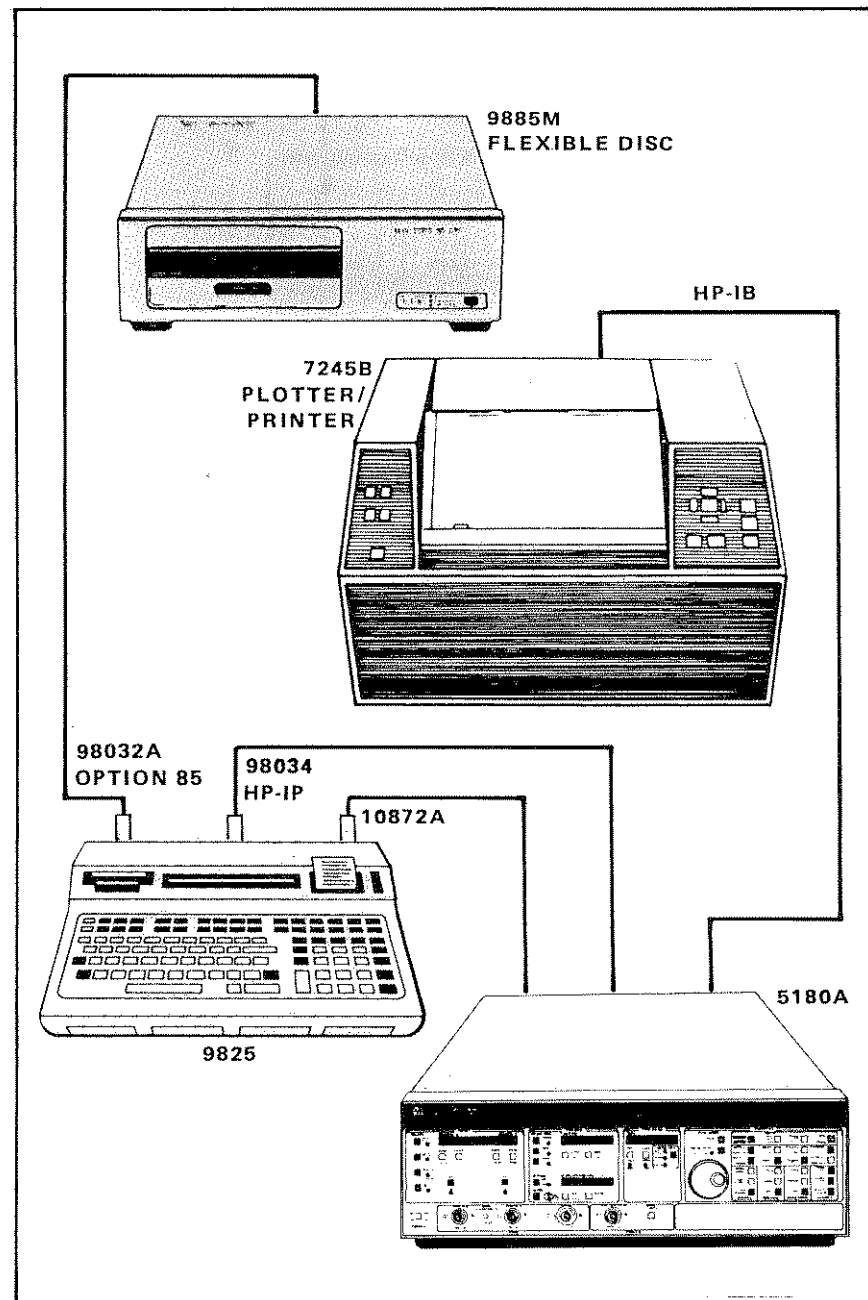

Figure 3-17. Typical System Setup

3-61. Error Indications

3-62. If any errors occur during the self-check, they are shown in the main display. The occurrence of an error indicates a need for service, with the following two exceptions:

- a. HP-IB address switch error. Error 2.XXX will occur, where XXX shows the illegal code. Simply turn off the 5180A, set the address switches to the correct position and turn back on. If XXX is greater than 99, a hardware problem is indicated in the address switches or rear panel connector.
- b. Error 14.00 indicates the CMOS RAM battery has been discharged. Allow the power to remain connected for a few minutes, then turn power off and back on.

3-63. All other errors indicate a hardware problem and the 5180A requires service. Hardware failures result in an FAnn.nn message. Refer to paragraph 3-94 for details on error indications.

3-64. LAMP TEST AND TEST PATTERN. In addition to lamp test that occurs on the front panel, a test pattern is written in an external XYZ display. When power is applied to the 5180A, there will be a 1 to a 1½ second pause while the microprocessor resets, when the test pattern will occur on an external display. The test pattern is shown in *Figure 3-18*. This is the same pattern as the calibration pattern described in paragraph 3-104, which describes connection and calibration of an external display.

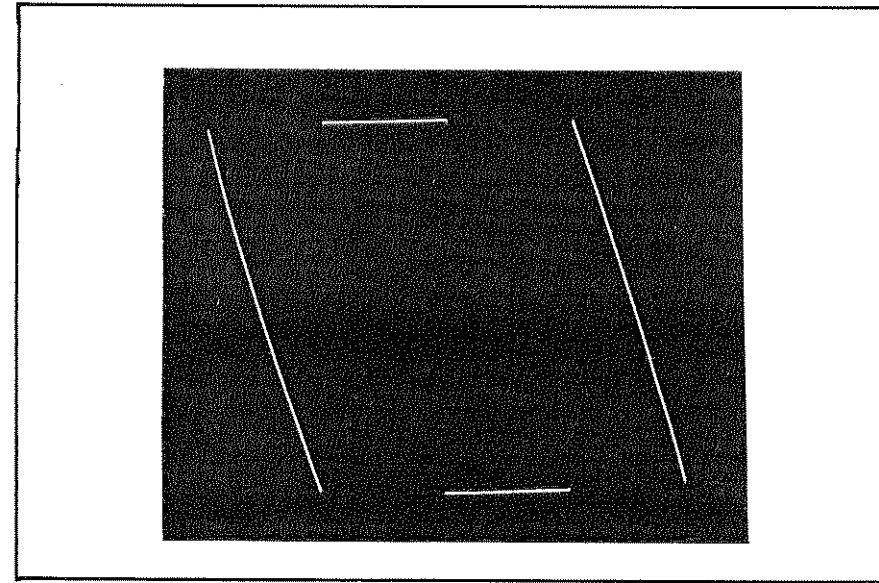

Figure 3-18. Power-Up Test Pattern on External Display

3-65. CMOS MEMORY. The 5180A contains a CMOS memory powered by a NICAD battery to save the settings of the front panel when the instrument is turned off. In addition to the current settings of the front panel, it is also possible to save four other settings as stored by the user. Every control that can be set from the front panel is saved in the CMOS memory. Consequently, when the instrument is powered up the next time, the 5180A will begin operating in the state it was in when last used. If the default operating condition is desired, the user must press the PRESET key. The battery is intended to keep the CMOS memory alive for a period of 3 to 4 days.

Table 3-1. Summary of Operating Characteristics

CHARACTERISTIC	CAPABILITY	CHARACTERISTIC	CAPABILITY
I. TRIGGERING		II. STORAGE (Cont'd)	
Internal Digital Trigger	No drift. Better settability and resolution than analog trigger.	Auto Advance	Auto advance automatically sets up the next block in memory for recording data. Signals occurring in quick succession may be captured confidently and conveniently.
External Trigger	Synchronize capture with another event.	III. MICROPROCESSOR CONTROL	
Selectable Hysteresis	Settable hysteresis allows you to match the trigger to input signals. Narrow hysteresis for clean signals, wide hysteresis for noisy signals.	Soft Keyboard	Front panel setups (up to 4) may be stored and later recalled even with the power turned off.
Pre-Trigger	Pre-trigger allows you to record up to 100% of memory before the trigger occurs. Observe baseline and leading edge information. Investigate cause/effect relationships by triggering on effect and recording the cause.	Front Panel Lockout	When enabled, this feature disables all front panel keys. Prevents inadvertent changing of set-up parameters.
Post-Trigger	Post-trigger allows you to delay up to 99.99 times the sweep time (memory length) after the trigger, before recording begins. Trigger on cause, examine the effect.	Programming	All front panel functions are easily controlled remotely via HP-IB for systems operation.
II. STORAGE		Preset	Places 5180A in known state for measurement.
Digital Storage	Digital storage prevents fading or blooming. Stored waveforms can be transferred to calculator cassette tape and may be retained indefinitely.	Autoset	Automatically selects time base, gain, etc., to get good display on repetitive signals.
Dual Trace	Stored and "live" waveforms can be displayed simultaneously to look for similarities and to observe the effects of changing component values. No flicker or dimming due to low rep rate signals.	IV. TIMEBASE MODES	
Memory Segmentation (Dual Trace)	Memory can be segmented for recording or display into as many as 32 equal length blocks and any 2 may be simultaneously displayed. Recall stored waveforms at a later time for comparison.	Mixed	Main timebase and delay timebase are settable over the range of 50 ns/pt to 50 ms/pt. Sample at slower rate on slowly varying waveform up to the trigger, then sample at a higher rate for good resolution on transient. Conserves memory.
		Toggle	MAIN, DELAY, then back to MAIN timebase for greater flexibility.
		Long Sweep Times (50 ms) 2K = 100 Seconds	Observe very low frequency phenomena on flicker-free display. With external 1 MHz oscillator, you can have 1 s/pt sampling.

CONTROL SECTION

HOLD	Disconnects Data Entry knob from currently selected function.	GAIN	Controls the vertical gain of the displayed waveform. Numbers displayed are the full scale voltage range.
UNLOCK/LOCAL	Unlocks panel or returns instrument to local from HP-IB.	OFFSET	Controls the vertical offset of the display waveform.
DOT/LINE	Alternates XYZ display between dot and line mode.	ZOOM	Controls the horizontal zoom of the displayed waveform.
SELF-TEST	Performs RAM, ROM, and high-speed RAM tests. Also creates test patterns for display and XYZ display.	POSITION	Controls the horizontal position of the displayed waveform.
SGL/DUAL	Selects single or dual trace display.	CAL/UNCAL	Places a calibration signal on the XYZ display. Useful for setting gain and offset of the display device.
TR1-TR2	Selects a display mode where the trace selected by Trace 2 location is subtracted from that selected by Trace 1 trace location.	OUTPUT	Issues an output command to plot the data on XY recorder or digital plotter.
RECORD LENGTH	Selects the length of the memory block used to record: 512 to 16,384.	X-Y SPEED	(Shift cursor volts) selects analog plotter speed per point.
RECORD LOCATION	Selects the block number where recording will take place: 1 to 32.	TRACE LOC	Selects the memory block of either Trace 1 or Trace 2.
AUTO ADVANCE	Selects AUTO ADVANCE mode. Places 5180A in SINGLE. When armed again will automatically advance from current Record Location to the next record.	BUS ADDR	Displays the currently selected HP-IB address.
SAVE LOC	Selects location to save the state of the controls of the 5180A (1 to 4). To save the state press SHIFT, SAVE.	CURSOR VOLT	Commands the display to show the voltage value of the cursors.
RECALL LOC	Selects location to recall the state of the 5180A controls (1 to 5). The 5th location recalls the state of the controls preceding a PRESET or AUTOSET.	CURSOR TIME	Commands the display to show the time value of the cursors.
TRACE 1	Selects Trace 1 to operate on for the following controls: GAIN, OFFSET, ZOOM, POSITION, TRACE LOC, CURSOR, and DELTA CURSOR.	SCROLL	Displays additional measurement resolution in the large digital display, when possible.
TRACE 2	Selects Trace 2 to operate on.	TRIG TIME	Displays the time of the occurrence of the trigger of the measurement.
		(SET ZERO)	Sets the trigger time clock to zero.
		AUTOSET	Automatically searches for and acquires a signal starting with the currently selected channel.
		PRESET	(Shift AUTOSET) Selects most commonly used measurement conditions.

CAUTION

CHANNEL A AND B. Do not exceed +25V peak as this could result in damage. (Maximum input voltage without overload is $\pm 10V \pm$ offset range.)
CHANNEL AUXILIARY. Do not exceed $\pm 1.5V$ peak. Input is fuse protected from some types of damage. 5180A must be RECALIBRATED after fuse replacement for maximum dc accuracy. Refer to Section V, Service Manual. **EXTERNAL TRIGGER.** Adjustable over 2.5V range. Sensitivity: 50 mV p-p.

Figure 3-19. Front Panel Controls, Indicators, and Connectors

3-68. INPUT SECTION



SELECT Controls (Figure 3-19)



CHA. Select Channel A. This key (switch) connects the input Channel A to the ADC. Channel A attenuator and associated controls are in effect. CHA LED will light to indicate the channel is selected.

GND A. (Press SHIFT key in the CONTROL section to activate. Main display should show Shift condition.) GND A key connects CHA to the ADC. In addition, it disconnects the channel from the input and connects it to ground. This can be used to calibrate offset errors in the input amplifier. The internal RANGE and OFFSET controls are still operational in this mode. When GND A is selected, the adjacent LED will flash repeatedly. (There is one exception to this, as the LED may stop flashing during the time that memory data is being transferred over HP-IB or DMA.)



CHB. Select Channel B. Operates same as CHA described above.

GND B. Operates the same as GND A described above.



CHOP A,B. Select Channel A and B. This key connects both A and B channels in a chopped mode. CHOP A,B uses channel A to obtain the trigger information if internal trigger is selected. The LED will light to indicate the channels are selected.

.1 VA. (PRESS SHIFT switch in the CONTROL section to activate). The .1 VA switch connects CHA to the ADC and connects it to a 100 mV dc calibration source. It is used to calibrate the gain of the input channel. The LED next to the key will flash when this mode has been selected. The flashing LED differentiates this function from the normal function.



AUX. Select auxiliary channel. This key (switch) connects the auxiliary channel input to the ADC. **To activate, press AUX, then press UNLOCK, then press AUX again.** This is the 50-ohm input without modification by attenuators or AC coupling. The auxiliary channel range is -1.024 to $+1.022$ volts. The AUX LED will light to indicate the channel is selected.

.1 VB. Operates the same as .1 VA described above.

3-69. Channel A Controls

NOTE

The RANGE and OFFSET keys (described below) select values that are displayed above the keys and are controlled by the DATA ENTRY control knob (as are all keys of the same color as the control knob).



RANGE. This key selects attenuation and amplification. It is similar to the attenuator control of an oscilloscope. Units displayed are in \pm volts. The LED display (above the range switch) displays the range when the RNG annunciator light is on. If the RANGE key is pressed, the trigger level is set to %FS. This occurs so that if the range is changed, the 5180A will react like a normal analog scope with an analog trigger circuit. Settable ranges are 10, 5, 2, 1, .5, .2, and .1 volts. These correspond to the normal ADC range of -1.024 to $+1.022$ volts when multiplied by the attenuator settings of 10, 5, 2, 1, .5, .2, and .1.

INPUT SECTION (Cont'd)



OFFSET. This key adds an analog offset to the signal in Channel A. An 8-bit DAC is used to control this feature so it may be programmable on HP-IB. The offset control is placed just before the input amplifier's output driver so that the amount of offset remains stationary regardless of the attenuator setting. The value displayed reflects the overall effect on the input signal. For example, if the input is attenuated by a factor of 10, a 1-volt change in the offset setting would look like a 10-volt change in input dc level and is shown as a 10-volt offset on the display. An offset of 0 volts is no offset and sets the DAC to provide a 0-volt dc level. Offset is settable within the range selected.

ZERO. Press SHIFT key in CONTROL section to activate. The ZERO key first sets the OFFSET to zero, then connects the DATA ENTRY control to Channel A OFFSET.



DC/AC. This key selects AC or DC control coupling to the input amplifier. The AC LED will light to indicate capacitive coupling.

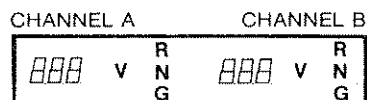

CHANNEL A AND CHANNEL B. The Channel A and Channel B displays are identical. The display shows both the range (attenuation) and offset applied to the input signal.

The DATA ENTRY control knob is connected to the display when either the RANGE or OFFSET key is pressed. The RNG or OFS annunciator will light and remain lit. The decimal points of the display will blink until the DATA ENTRY control is disconnected from the display. However, the information will still be displayed, so that the last programmed information is visible. Possible range values are 10V, 5V, 2V, 1V, .5V, .2V, and .1V. Offset values have 1% accuracy, giving two-digit resolution plus sign. Values like +10V, 1.2V, .10V, 15 mV, and their negatives are possible.

3-70. Channel B Controls



RANGE. This key selects attenuation and amplification. It is similar to the attenuator control of an oscilloscope. Units displayed are in \pm volts. The LED display (above the range switch) displays the range when the RNG annunciator light is on. If the RANGE key is pressed, the trigger level is set to %FS. This occurs so that if the range is changed, the 5180A will react like a normal analog scope with an analog trigger circuit. Settable ranges are 10, 5, 2, 1, .5, .2, and .1 volts. These correspond to the normal ADC range of -1.024 to $+1.022$ volts when multiplied by the attenuator settings of 10, 5, 2, 1, .5, .2, and .1.



OFFSET. This key adds an analog offset to the signal in Channel B. An 8-bit DAC is used to control this feature so it may be programmable on HP-IB. The offset control is placed just before the input amplifier's output driver so that the amount of offset remains stationary regardless of the attenuator setting. The value displayed should reflect the overall effect on the input signal. For example, if the input is attenuated by a factor of 10, a 1-volt change in the offset setting would look like a 10-volt change in input dc level and should be shown as a 10-volt offset on the display. An offset of 0 volts is no offset and set the DAC to provide a 0-volt dc level.

ZERO. Press SHIFT key in CONTROL section to activate. The ZERO key first sets the OFFSET to zero, then connects the DATA ENTRY control to Channel B OFFSET.



DC/AC. This key selects AC or DC control coupling to the input amplifier. The AC LED will light to indicate capacitive coupling.

3-71. TRIGGER SECTION**3-72. Sweep Arm Controls** (Figure 3-19)

SINGLE. Selects single sweep mode. The SINGLE key has two functions. It selects the single sweep mode, and each time it is pressed, it arms the 5180A for a new sweep. The SINGLE LED will light when single sweep is selected. In addition, the ARM annunciator in the top window will light if the 5180A is armed and waiting for a trigger.



AUTO. Selects the automatic sweep mode to provide continuous measurements. If there is no trigger signal within the length of time of one sweep, then a trigger will be forced so that a measurement can be seen. The AUTO LED will light to indicate that AUTO is selected.



NORM. Selects the normal sweep mode for continuous sweep, however, if there is no trigger, there will be no sweep. The NORM LED will light to indicate that NORM is selected. In addition, the ARM annunciator in the top window will light if the 5180A is armed and waiting for a trigger.

NOTE

Once a measurement is started, it will abort if certain keys are pressed. This is because the XYZ or cursor measurements need updating, and both need data from the high-speed memory. Aborted measurements may contain random data.

3-73. POSITION Controls**NOTE**

The POSITION control keys (described below) select values that are displayed above the keys and are controlled by the DATA ENTRY control knob (as are all keys of the same color as the control knob.)

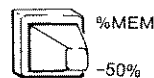

%MEM. Selects the position to be entered and displayed as a percentage of the current memory block length. If the position is positive, the post-trigger mode is selected. That is, there will be a delay added between the occurrence of the trigger and the start of the data recorded. If the position is negative, then the pre-trigger mode is selected. In this case, the trigger is visible on the display. For example, if the trigger point is to be at the midpoint of the displayed memory, a position of -50% may be selected. Negative positions of up to -100% may be specified. This places the trigger point at the end of the block of data recorded. Positive positions longer than the current block length may be specified by selecting a percentage larger than 100%. The largest percentage that may be set is 9999%. Larger delay settings are available, however the setting must be done using the TIME key. Delay settings larger than 9999% are displayed as lower case zeros "0000", in upper segments.

NOTE

The position may also be entered in absolute number of memory locations over the HP-IB. When the position is entered as an absolute number, it should be positive to indicate a post-trigger and negative to indicate pre-trigger. The front panel display will continue to indicate the result in whichever mode was sent last (%MEM or TIME).

-50%. Press SHIFT switch in CONTROL section to activate. The -50% key sets the trigger position to 50% and then connects the DATA ENTRY control to %MEM.

TRIGGER SECTION (Cont'd)



TIME. Selects the position to be entered and displayed in terms of seconds. The time is computed to the nearest integer number of time base clock cycles. As with the %MEM key, a positive number indicates post-trigger and a negative number indicates pre-trigger.

The range of settings allowed is: $-(\text{current record length} - 3) \cdot (\text{main time-per-point})$ to $(2^{20} - 1 \text{ current record length} - 3) \cdot (\text{main time-per-point})$.

ARM DELAY. (Press SHIFT key in CONTROL section to activate.) The ARM DELAY key controls the delay time between measurements. This is effectively a measurement rate control. The ARM DELAY is displayed as seconds. It is added after the finish of the last measurement before the 5180A is armed for the next measurement. The ARM DELAY is intended to be a display rate control, not a pacer function. ARM DELAY values range from 5 ms to 99 seconds in .25 second increments. The numbers displayed are correct for 1024 point blocks, with zoom = 1024. If the SINGLE key is pressed while delaying, SINGLE will be set, but no arm will occur. This allows you to halt the 5180A to review a measurement already taken. In AUTO ADVANCE, minimum time is 5 ms.

NOTE

When using an external time base (TIMEBASE IN on rear panel) the ARM DELAY specified assumes an external time-base input of 20 MHz. For other timebase frequencies, the displayed value must be divided by the ratio of 20 MHz/time base frequency in MHz.

POSITION

EEEE nμms %

POSITION. The POSITION display shows the trigger position (delay) in 4 digits. There are two displays selectable from the keyboard (%MEM, TIME). The DATA ENTRY control knob is connected to the display by pressing either the %MEM

or TIME keys. While the DATA ENTRY control is connected to the display, the decimal points will blink. When the DATA ENTRY control is disconnected, the display will remain with the last selected value and format. In terms of %MEM, the range is -100% to 9999% or the maximum allowable delay count (depends on record size). The range in time depends on the timebase selected. This display will be updated whenever the TIMEBASE or RECORD LENGTH controls are changed. The %MEM and TIME are always floating point (nonexponential) numbers. When ARM DELAY has been pressed, the display will show Ad nn, where nn is a number from 5 ms to 99 seconds.

3-74. Trigger Controls

3-75. The 5180A has a normal analog trigger circuit for external trigger. For internal trigger, however, the instrument uses a digital trigger on the incoming digital data. In addition, the internal trigger circuitry contains a settable digital hysteresis. The hysteresis makes it possible to trigger on waveforms that a scope would not ordinarily catch. To facilitate the setting of the trigger level and the hysteresis, a trigger display is activated any time one of the trigger or hysteresis setting controls is pressed. The left side of the XYZ display will show both the lower and upper hysteresis levels. When in positive slope, the trigger level set will be shown by the upper of the two hysteresis level bars on the XYZ. The lower bar is the range of the hysteresis. In negative slope, the opposite situation occurs. The lower bar is the trigger level set, and the upper bar is the hysteresis range. Trigger levels are set without regard to the input amplifier offset. Internal trigger is always set with respect to the data that the ADC is measuring. The trigger level bars can be read in such a way that the slope information becomes obvious. The hysteresis bar is always leftmost and the trigger level bar always rightmost. Reading from left to right, the slope is the direction of travel from hysteresis bar to trigger level bar.

TRIGGER SECTION (Cont'd)**SOURCE**

SOURCE (INT or EXT). Selects the trigger source as INT or EXT. The external trigger is an 8-bit DAC connected to a comparator. The internal trigger is a 10-bit comparator that looks at the ADC data. The EXT LED will light when the external source slope is selected.

NOTE

The BI-TRG function (described below) allows the 5180A to trigger on either the positive or negative slope. Thus, when searching for transients where the actual slope is unknown, but the magnitude is known, it is possible to set up a trigger condition that triggers whenever the waveform exceeds the positive or negative limits set. In BI-TRG, the trigger level and hysteresis numbers are redefined slightly. The trigger level is used to set the center point of the waveform. If the transient is centered around ground, then the trigger level is set to 0V. The hysteresis level is used to set the trigger band. For example, if it is desired to capture the transient when it exceeds 0.5V in the positive direction or -0.5V in the negative direction, then the hysteresis level should be set for 0.5V.

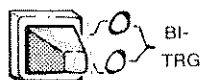
SLOPE

SLOPE. Selects the edge of the trigger waveform to use. In EXT trigger, there are two allowable slope settings, + and -. In INT trigger, there are three settings, +, -, and Bi-Trigger (BI-TRG). The SLOPE control selects from these choices in sequence from +

to - and then to BI-TRG. The positive slope LED will light when the leading edge trigger slope is selected. The negative slope LED will light when the trailing edge trigger slope is selected. Both slope LED's will be lit in BI-TRG. Refer to paragraph 3-26 for details.

NOTE

The LEVEL/HYSTERESIS control keys (described below) select values that are displayed above the keys and are controlled by the DATA ENTRY control knob (as are all keys of the same color as the control knob).

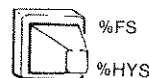

%FS. Selects the trigger level to be entered and displayed as a percentage of the full scale input. For EXT, the full scale value is +2.54/-2.56 volts. For INT, the full scale value is the value selected for the input channel. Channel AUX full scale is always +1.022/-1.024 volts. Channel A and B full scale are selected using the range control. 0% is always 0 volts. -99% is always minus full scale (-1.024•range setting). 99% is always plus full scale (+1.022•range setting). There are two trigger level bars that are displayed at the left side of the XYZ display whenever any of the trigger level or hysteresis functions are enabled. These bars indicate the upper and lower limits of the trigger level as set (includes hysteresis).

%HYS. Press SHIFT key in CONTROL section to activate. %HYS selects the trigger hysteresis to be entered as a percentage of full scale. This function is only applicable in internal trigger. The actual hysteresis value is variable from 0 to 100% of full scale. Settable hysteresis is not available in EXT trigger. This is fixed at 100 mV nominal. In external, attempting to set hysteresis will result in Er6.01, DATA ENTRY control knob will not be connected.

TRIGGER SECTION (Cont'd)VOLTS
VHYS

VOLTS. Selects the trigger level to be entered and displayed as an absolute voltage. The voltage must be within the full-scale range of the input channel selected (+2.54/-2.56 volts for the EXT input).

VHYS. Press the SHIFT key in the CONTROL section to activate. Selects the trigger level hysteresis to be entered in absolute volts. This feature is only available in internal trigger. It is settable from 0 volts to 1.022 volts assuming the selected input has a range of 1 volt FS. When either CHA or CHB is selected, the allowable values of hysteresis must be scaled by the RANGE setting. The following table gives the allowed values for each of the RANGE settings:

RANGE	MIN-MAX	RESOLUTION
100 mV	0-102 mV	.2 mV
200 mV	0-205 mV	.4 mV
500 mV	0-511 mV	1 mV
1V	0-1.022V	2 mV
2V	0-2.048V	4 mV
5V	0-5.11V	10 mV
10V	0-10.22V	20 mV

In external, the hysteresis display will be fixed at 100 mV, and Er6.01 will be generated (see paragraph 3-94) if any attempt is made to try to set the hysteresis.

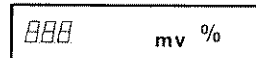
LEVEL/HYSTERESIS

LEVEL/HYSTERESIS. The level display shows both the internal and external trigger levels in 3 digits. As with the other displays, the DATA ENTRY control knob is connected to the display by pressing either the %FS or the VOLTS key. The display shows blinking decimal points while the DATA ENTRY control is connected, and leaves the last selected display and format in the display. In %FS the possible range is +99% to -99%. 0% is the midpoint equal to 0 volts. In external trigger, the full scale range is +2.54, -2.56 volts. In internal, the range is affected by the RANGE control. Note also that the offset is added to the signal before the ADC sees it. The trigger voltage is in terms of the signal seen at the ADC. If the LEVEL DISPLAY contains an HYS annunciator, then the value displayed is the trigger hysteresis.

3-76. TIME BASE CONTROLS

3-77. The timebase controls, *Figure 3-19*, are used to set the rate at which data is captured. Unlike a normal oscilloscope, the rates may be set in either time-per-sample or time-per-sweep (instead of time-per-division). *Time-per-sample* refers to the time between samples of the ADC. *Time-per-sweep* is the total time of the measurement. Depending on the sample rate selected, and the length of the memory block, the measurement time can vary from 25.6 microseconds to 819.2 seconds. For the longer measurements, it is difficult to tell what the 5180A is doing, so feedback is provided. Two methods are used. First, anytime that the DATA ENTRY control is turned (changing one of the measurement parameters) the measurement will be aborted. This provides instant feedback of the parameter that was changed. This includes changing the cursor position or changing any XYZ display parameter. Second, on any measurement longer than one second, the instrument will initiate Update Mode. Update Mode causes the XYZ display to update the recorded points “live” during the measurement. This means that as the points are collected, they will be displayed on the XYZ output. The form assumes a fixed vertical gain and horizontal zoom. This implies that as points are captured, the most significant 8 bits of each point are packed from left to right on the XYZ, independent of ZOOM or GAIN controls, or RECORD LENGTH. When the measurement completes, the screen is updated with the desired information at the selected gain and zoom. In CHOP A,B mode, some special constraints exist. First, because of a limitation on the rate at which the input amplifiers can chop, the timebase setting is limited to 200 ns per point. This means that each channel is captured at 200 ns per point in an alternating fashion. At slower rates, the two channels are sampled 100 ns apart, and then the timebase waits the rest of the time for the particular timebase set. For example, if the timebase is set to 1-microsecond, the A Channel is sampled, then 100 ns later the B Channel is sampled. Then there is a pause of 900 ns before the A Channel is sampled again. Note that CHA and CHB must always be sampled at the same rate. During MIXED or TOGGLE timebase, the timebase change always occurs following the sampling of CHB. The 500 ns per point position is not available in CHOP A,B mode. The allowable positions are 200 ns, 1 μ s, 2 μ s, 5 μ s, etc.

NOTE

The TIME control keys (described below) select values that are displayed above the keys and are controlled by the DATA ENTRY control knob (as are all keys of the same color as the control knob).



MAIN/SMPL. Selects the main timebase value to be entered and displayed in seconds per sample captured. The value is always rounded to the nearest allowable setting. Timebase settings are available from 50 ns to 50 ms as follows: 50 ns, 100 ns, 200 ns, 500 ns, 1 μ s, 2 μ s, 5 μ s, 10 μ s, 20 μ s, 50 μ s, 100 μ s, 200 μ s, 500 μ s, 1 ms, 2 ms, 5 ms, 10 ms, 20 ms, 50 ms. In external timebase, the divide chain may still be used. The display reflects the divide ratio selected. Values may be: 1, 2, 4, 10, 20, 40, 1E6.

NOTE

When external timebase is used, all displays that reflect timing information will assume that a 20 MHz input has been applied. If any other frequency is used, it will be necessary to scale the time values displayed.

MAIN/SWEEP. Selects the main timebase value to be entered and displayed in seconds-per-sweep. If the instrument is in MAIN ONLY mode, then this number is the total time for the measurement. If the instrument is in MIXED or TOGGLE mode, then the time displayed is the total time spent in MAIN TIMEBASE. The range of values of the timebase is computed from the time per sample values using the memory size selected:

MAIN ONLY:

$$\text{MAIN/SWEEP} = \text{MAIN/SAMPLE} \times \text{RECORD LENGTH}$$

MIXED and TOGGLE:

$$\text{MAIN/SWEEP} = \text{MAIN/SAMPLE} \times (\text{Samples in MAIN TIMEBASE})$$

TIME BASE SECTION (Cont'd)

/SAMPLE



/SWEEP



DELAY

DELAY/SAMPLE. Selects the delayed timebase value to be entered and displayed in seconds-per-sample. The entry and allowable values are the same as the MAIN/SAMPLE. The delayed timebase value is unused when in MAIN ONLY.

DELAY/SWEEP. Selects the delayed timebase value to be entered in seconds-per-sweep. This key acts for the delayed timebase as the MAIN/SWEEP key acts for the main timebase.

SEQUENCE

MAIN ONLY



MIXED



SEQUENCE. Selects whether a single or dual timebase will be used. The adjacent LEDs indicate which function is selected.

TOGGLE



MAIN ONLY. When in MAIN ONLY, the main timebase is used. The DELAY timebase is ignored.

MIXED. When MIXED is selected, the position controls are used to determine when the change from MAIN to DELAY timebase occurs. When position is positive, the trigger starts the recording, and the position selected determines when the timebase will change. When position is negative, the trigger changes the timebase rate, and the position selects where the trigger is on the screen.

TOGGLE. If TOGGLE mode is selected, the timebase changes twice. The MAIN timebase is used until the trigger occurs. The DELAY timebase is used until the delay selected by the position control is reached. Then, the MAIN timebase is used until the measurement is complete. The DELAY timebase portion of the measurement is centered in the record. When the trigger changes the timebase, the point of change is made visible by the trigger cursor. In order to make the second change visible, there will be two adjacent trigger-like cursors placed in the XYZ. The first will be the last point of the DELAY timebase, and the next will be the first point of the MAIN timebase. The double-trigger cursors will also be visible when in MIXED with a positive

trigger position. In this case, the trigger is at the left of the screen, and the trigger position control is being used to control when the timebase change occurs.

Each time the timebase changes, it takes a certain number of timebase cycles to make the change. Thus, for each timebase change, this time is lost. The cursor measurements account for this loss when time related answers are displayed.

TIME

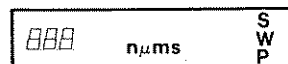

TIME Display. This display is used to show the speeds of the two internal timebases, and the divide ratios of the external timebases. When the values of the internal timebase are displayed as TIME/SWEEP, the values displayed are dependent

on the memory length. When the values of the internal timebases are displayed as TIME/SAMPLE, the range of values is in engineering notation in a 1, 2, 5 sequence from 50 ns per point to 20 ms per point. (Engineering notation has exponents in multiples of three.) The main timebase is always the timebase used first in mixed or toggle mode. In external timebase, the incoming clock must be between 1 and 20 MHz. To obtain record rates slower, it is possible to divide the timebase by a 1, 2, 4 sequence from 1 to 10⁻⁶. The display format is of the form 1E0 to 1E6. Remember, however, that any time values displayed by the 5180A, when measuring cursors, must be scaled if any external timebase other than 20 MHz is used.

3-78. CONTROL SECTION

3-79. The CONTROL section contains the DATA ENTRY controls and the general controls for the 5180A, as described below. See Figure 3-19.

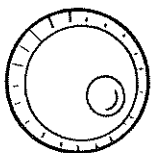
DATA ENTRY

Control knob used to control the numeric functions of the instrument. This control is connected to a particular display by pressing one of the grey keys (same color as the control knob). It remains connected to that display until either the PANEL LOCK key, the HOLD key, or another grey key is pressed. The rate at which numbers are changed with the

DATA ENTRY control is dependent on the speed at which it is rotated, and the display chosen. The connected display is indicated by flashing decimal points in that display. In all cases, the DATA ENTRY control will control the number in the display.

HOLD



HOLD. Disconnects the DATA ENTRY control knob from any of the displays.

UNLOCK/LOCAL

PANEL LOCK



UNLOCK/LOCAL. Generates the rtl message for HP-IB use. If the 5180A is in REMOTE, but is not in LOCAL LOCKOUT, the UNLOCK/LOCAL key will return the 5180A to the LOCAL state. The UNLOCK/LOCAL key is also used to unlock the panel

(keys) once it has been locked using the PANEL LOCK function.

PANEL LOCK. Press the SHIFT key in the control section to activate this function. Locks the front panel controls and disconnects the DATA ENTRY control. This prevents undesired changes in front panel settings. The PANEL LOCK light is lit when the panel is locked by the PANEL LOCK key or when the instrument is in the REMOTE mode.

CONTROLS**SETUP CONTROLS****NOTE**

All keys of the same color as the DATA ENTRY control knob are controlled by it. All keys that have two labels (functions) require pressing the SHIFT key to activate the lower blue-labeled function.



AUTOSET. The AUTOSET key sets the 5180A to make a measurement on a repetitive signal. When the AUTOSET key is pressed, the 5180A begins a set of routines to scan for input signals, and sets various controls accordingly. The steps performed by auto setup are as follows:

1. Remember the input channel currently selected.
2. Preset the 5180A except for the input channel selection.
3. Scan for a signal in the current channel, noting the minimum and maximum values measured. If there is no signal, continue with the other input channel. If all inputs are inactive, indicate an error.
4. Once a channel has been selected, adjust attenuation (if it is adjustable), hysteresis, and trigger levels.
5. Adjust time base to give 2 to 6 complete cycles of the measured waveform.

CONTROL SECTION (Cont'd)

AUTOSET
PRESET 

PRESET. Press SHIFT key to activate. This key is used to place the 5180A in a known state, as follows:

1. Channel A.
2. Auto sweep.
3. Position -50%.
4. Trigger internal.
5. Trigger slope positive.
6. Trigger level 0%.
7. Trigger hysteresis 2%.
8. Main time base 50 ns/sample.
9. Main only.
10. Record length 1024.
11. Record location 1.
12. Line mode.
13. Single trace.
14. Trace 1.
15. Trace location 1.
16. XYZ horizontal and vertical are fixed.
17. Arm Delay, second minimum position, 190 ms. (Equivalent to fastest measurement with an update of XYZ display.)
(PRESET is also in effect following a CMOS RAM error 14.00. See paragraph 3-100.)

SAVE
LOC
SAVE 

SAVE LOC. Selects which of the 5180A setup registers will be used to store the setup of the instrument. The DATA ENTRY control is used to set a number between 1 and 4. Subsequent use of the SAVE key will store the complete setup of the instrument into this location. The display of the SAV LOC will contain "SL", i.e., SL4.

SAVE. Press SHIFT key to activate. Executes a store of the complete instrument setup into the location selected by SAVE LOC. This occurs only if SAVE LOC was the last key pressed, to prevent accidental saves.

RECALL
LOC
RECALL 

RECALL LOC. Selects which of the 5180A setup registers will be used to recall the setup of the instrument. The DATA ENTRY control is used to set a number between 1 and 5. Register 5 is used to recall the setup of the 5180A prior to execution of a PRESET or AUTOSET. The display of the RECALL LOC will contain "rL", i.e., rL4.

RECALL. Press SHIFT key to activate. Executes a recall of the complete instrument setup from the location selected by RECALL LOC. This occurs only if RECALL LOC was the last key pressed, to prevent accidental recalls.

SHIFT
UNSHIFT 

SHIFT/UNSHIFT. Selects all control functions labeled in blue. Pressing the SHIFT key will put "ShiFt" in the large display, and activate the shift function for the next key pressed. If SHIFT is pressed by mistake, pressing it again will return the display to its previous state, and cancel the shift function.

DISPLAY Controls

DOT/LINE
SELF-TEST 

DOT/LINE. A toggle function that selects the method used to display the collected data. In the DOT mode, 1024 points of collected data are displayed as dots on the XYZ display. In the LINE mode, the same 1024 points are smoothed automatically to connect the dots with a smooth curve. At fewer than 8 points per cycle, sine wave displays will begin to roll off in amplitude when in LINE mode.

CONTROL SECTION (Cont'd)

SELF-TEST. Press SHIFT key to activate. Initiates a complete self-test of the 5180A. The tests include:

1. Scratch pad RAM test.
2. ROM checksum.
3. CMOS RAM test.
4. High-speed memory test.
5. Display pattern generation.
6. XYZ output RAM and DAC test.
7. NMOS RAM test.
8. Internal timer test.
9. Input amplifier gain and offset tests.

Self-test will erase any previously recorded data in the high-speed RAM. It will not, however, cause the front panel settings or any of the SAVE/RECALL locations 1-4 to be destroyed. Locations 1-4 will be moved for safe-keeping while the CMOS RAM is being tested. Following the self-test, the unit will indicate the length of time it has been operated since last service. RECALL location 5 is changed because the self-test performs a preset. The instrument goes to SINGLE sweep mode at the end of SELF-TEST.



CURSOR. Enables a box-shaped cursor on the XYZ display, and connects its position to the DATA ENTRY control knob. The X or Y value of the cursor is put in the large display depending on which of the controls, CURSOR TIME or CURSOR VOLTS, was last selected. The cursor is

moved between Trace 1 and Trace 2 depending on whether the Trace 1 or Trace 2 key was pressed last.

OFF. Press SHIFT key to activate. Turns off the cursor. It also turns off the CURSOR Δ if it is on. CURSOR value displays are disabled. When the CURSOR is turned off, its position is left unchanged. Thus, when it is turned back on, it is in the same place.



CURSOR Δ . Enables a cross-shaped cursor on the XYZ display, and connects its position to the DATA ENTRY KNOB. When CURSOR Δ is enabled, the values of CURSOR TIME and CURSOR VOLTS are differences between the CURSOR and the CURSOR Δ . When the

CURSOR Δ is above or to the right of the CURSOR, the displayed values are positive. Negative values are displayed if the CURSOR Δ is below or to the left of the CURSOR.

OFF. Press SHIFT key to activate. Turns off the CURSOR Δ . It has no effect on the CURSOR. Displayed values return to absolute indications of TIME and VOLTS. When the CURSOR Δ is turned off, its position is left unchanged.



CAL/UNCAL. Used to place a known pattern on the XYZ display. See *Figure 3-24* for an example. This pattern allows the display gains and offsets to be adjusted so the image fills the screen. When the XYZ is connected to an oscilloscope, the calibrate pattern remains until the key is pressed again. When the XYZ is connected to an XY recorder, the pen goes to the lower left point when the key is pressed, and the upper right point when the key is pressed again. It is necessary to press the OUTPUT key to get a plotted output. During the time that the XYZ display is in CAL mode, the word CAL appears in the large display.

OUTPUT. Press the SHIFT key to activate. The OUTPUT key has three modes, depending upon the setting of the HP-IB address switch and the CRT/PLOT switch (see paragraph 3-84) as follows:

1. Normal HP-IB. When the instrument is addressable, pressing the OUTPUT key may be set to cause a service request on the bus (assuming the SRQ mask is set for this function). This mode is used to tell a calculator or computer that the instrument is set and ready to output a plot.
2. Talk Only Plot Output. This HPGL format (HP Graphics Language) will drive a 9872B/C/S, 7245, or 7225 plotter. The plot will be a duplication of the data shown on the XYZ display. It will include scales and labeling information.

CONTROL SECTION (Cont'd)

3. Talk Only Tabular Output. A tabular output of the memory contents suitable for a data logging device or printer. The output file will contain the data from TRACE LOCATION 1, in tabular form followed by the teach/learn strings. Refer to paragraph 3-184 for a description of teach/learn outputs. If the data is for a record that contains Chop mode data, then CHA data is output first, followed by CHB data. During the output of the plot or tabular data, the panel is locked. To stop an unwanted output, simply press the UNLOCK/LOCAL key.
4. If the CRT/PLOT switch is set to PLOT, pressing the OUTPUT key will result in a plot on the XY recorder.

NOTE

If a plotter or a printer is not connected to the HP-IB connector on the 5180A, then pressing this key will generate an Er1.00. To clear the error, press UNLOCK/LOCAL to abort the plot, connect the plotter, and try again. The XY recorder output may be terminated in the same way as the HPGL. Simply unlock the panel by pressing UNLOCK/LOCAL again. This will abort the output. During the time of the HPGL output, the large display of the 5180A will show "Plot". When the XY recorder output is in progress, the display will show "rcdr".

SGL/DUAL
TR1-TR2



SGL/DUAL. Selects either SINGLE or DUAL trace mode on the display. In SINGLE trace mode with no zoom, 1024 points from the location pointed to by the TRACE LOCATION key will be displayed on the XYZ display. In DUAL trace mode, 512 points from each of two traces will be displayed. Each trace is displayed with trigger point and timebase change cursors (except CHB in CHOP mode). The main and delta cursors may be placed on either or both traces. The message, "tr=", is displayed if Trace 1 location is equal to Trace 2 location. Note that in SINGLE, the trace location referred to is always TRACE 1. Controls may be used to set up TRACE

2 data, but the effects will not be seen until DUAL trace is enabled. Also, even though it is possible to set TRACE 2 controls, selecting a TRACE 2 cursor will result in an answer for TRACE 1. This is because the answer displayed would be for TRACE 2 and would be very misleading. As soon as DUAL TRACE is selected, the cursor will go to the desired trace and display the correct answer.

TR1-TR2. Press SHIFT key to activate. Selects a display mode that subtracts the data of Trace 2 from the data of Trace 1 before displaying it. Trace 1 and Trace 2 are selected with the TRACE LOCATION key. To differentiate between normal SINGLE trace display, the ANL annunciator will be turned on to indicate that the 5180A is doing analysis on the data. The message, "tr=", is displayed if this mode is selected with Trace 1 location equal to Trace 2 location. Push SINGLE/DUAL to exit TR1-TR2 mode.

NOTE

The math applied to the data in TR1-TR2 is as follows: First, the data from the two traces is converted to bipolar format, +511/-512. Then the two traces are subtracted. The result of the subtraction is reconverted to absolute format 0-1024, and the TRACE 1 GAIN, OFFSET, ZOOM, and POSITION are applied. Thus, the data is always subtracted first, and the XYZ display controls only affect the display of the data. It is not possible to scale each channel individually.

TRACE 1



TRACE 1. Selects TR1 as the target for the display and cursor controls.

TRACE 2



TRACE 2. Selects TR2 as the target for the display and cursor controls.

CONTROL SECTION (Cont'd)TRACE LOC
BUS ADDR 

TRACE LOC. Once TR1 or TR2 has been selected, the TRACE LOCATION key selects the block in memory to display in that trace. If the TRACE LOCATION matches the RECORD LOC, the display will be live when the instrument is in AUTO or NORM sweep. Other locations may be selected to view previously recorded data. TRACE LOCATION for TRACE 1 will always be updated when RECORD LOC is changed. This insures that the instrument will always appear live when the RECORD LOC is changed. TRACE LOCATION for TRACE 1 will also be changed whenever a DMA input or a full-block HP-IB input is done.

BUS ADDR. Press SHIFT key to activate. The ADDRESS switch settings are read by the microprocessor and set into memory. Allows viewing the HP-IB address switch settings on the main display, momentarily. The display will continue to show the address as long as the key is held in. This key must be used to change the address.

NOTE

The HP-IB interface is disabled during the address reading and setting procedure. Do not attempt to operate remotely while pressing BUS ADDR key.

MEMORYRECORD LENGTH 

RECORD LENGTH. Selects the block length of the memory. 32 blocks of 512 points per block are available. The block length is global, there may be only one block length selected at a time. When the RECORD LENGTH key is pressed, any measurements are disabled. The instrument is set to SINGLE sweep, and is left unarmed. In addition, the RECORD LOCATION is set to 1.

RECORD LOCATION 

RECORD LOCATION. Selects the block number of the memory to record ADC data. When RECORD LOCATION is pressed, the instrument is set to SINGLE sweep and unarmed in order to avoid writing into undesired locations as the DATA ENTRY control is rotated. The maximum value of RECORD LOCATION is 32. There are 32 different pockets that the high-speed memory may be divided into. RECORD LOCATION always updates the trace location of TRACE 1 to point to the new location selected.

AUTO ADVANCE 

AUTO ADVANCE. Selects a measurement mode where the 5180A automatically advances through successive blocks of memory after each measurement. This allows quick capturing of repeating single-shot events, along with their trigger time. This mode is useful for evaluating the repeatability of transients, and for looking for random events. First, the user sets the RECORD LOCATION. When the AUTO ADVANCE key is pressed, the instrument is set to SINGLE sweep and unarmed. This prepares the 5180A to make a series of measurements. The user then presses one of the SWEEP ARMING controls. The 5180A will then make a measurement and advance the memory to the next location. If the unit is in SINGLE, it will be necessary to rearm for each measurement. If AUTO or NORM is selected, the 5180A will make repeated measurements until the last location is reached. The ARM DELAY function is in operation during AUTO ADV so that it may be used to control the speed of the measurements. If the ARM DELAY is zero, measurements are made at the maximum rate. If the ARM DELAY is nonzero, then the XYZ display and the main display are updated after each measurement. The AUTO ADVANCE mode is terminated when the last block is recorded into, or when any key affecting the main display is pressed.

VERTICALGAIN 

GAIN. Allows the DATA ENTRY knob to control the vertical gain of the data displayed on the XYZ display. The GAIN control acts independently on TR1 and TR2. The vertical gain value displayed is the full scale voltage range. If the gain is doubled, the full scale range is halved. Thus, if the input channel range is ± 1 volt, then the vertical gain displays 1 volt for a no-gain situation. If the image is enlarged by a factor of 2, the displayed value will be .5 volt, indicating that the XYZ now covers $\pm .5$ volt.

CONTROL SECTION (Cont'd)



OFFSET. Allows the DATA ENTRY knob to control the vertical offset of the data displayed on the XYZ display. The OFFSET control acts independently on TR1 and TR2. The value displayed is the voltage offset from nominal center.



FIXED. FIXED key (located below GAIN and OFFSET keys) selects a gain equal to full scale and no offset for the trace selected.

HORIZONTAL



ZOOM. Allows the DATA ENTRY knob to control the horizontal spread of the data displayed on the XYZ display. When zoomed out, the instrument shows the complete memory block selected, skipping points as necessary to reduce the total to 1024. When zooming in, increasingly finer resolution is used until the points displayed correspond, one-for-one, with those in a part of the memory. If zoomed in farther, the display reduces the number of points on the screen to a minimum of 256. The zoom value displayed is the total number of recorded points covered by the display from the left side of the screen to the right side. When in CH AB mode, the picture will appear to expand by a factor of two. This is because although the record length may call for a 1024 point record, there will be only 512 points for each channel (A and B).



POSITION. Allows the DATA ENTRY knob to control a horizontal offset of the memory displayed. When zoomed out, this control does nothing because the entire record is visible. When zoomed in, the POSITION control allows the area viewed to be moved back and forth over the memory record. The position value displayed is the number of the point on the left side of the screen relative to the start of the record.



FIXED. FIXED key (located below ZOOM and POSITION keys) selects the fully zoomed out, no-position values of the two controls for the trace selection. The original values are lost.

MEASURE

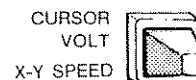

CURSOR VOLT. Connects the main display to the vertical value of the cursor position. The answer is in volts. If the CURSOR Δ mode is enabled, the CURSOR VOLT key displays the difference in vertical position between the two cursors. If the delta cursor is higher than the main one, the answer will be positive. If the delta cursor is lower than the main one, the answer will be negative.

X-Y SPEED. Press SHIFT key to activate. The X-Y SPEED key controls the speed of the XY recorder mode of output. The value displayed is the time delay between the plotting of two points. The minimum value is 100 ms, and the maximum is 400 ms with 50 ms increments. Pen-up and pen-down delays are fixed at 50 ms each, and included in the speed setting.



CURSOR TIME. Connects the main display to the horizontal value of the cursor measured from the trigger time. If the CURSOR Δ mode is enabled, the CURSOR TIME key displays the difference between the horizontal positions of the two cursors. Positive answers are given if the delta cursor is to the right of the main one. Negative answers are given if the delta cursor is to the left of the main one.

SCROLL. Press SHIFT key to activate. Used to display more digits for CURSOR TIME and TRIGGER TIME. Once the selected number is seen, press the SCROLL key and the display will move over three digits. The left-most digit of the display area will contain the lazy T character ($\text{—} \text{I}$) to indicate that there is information to the left.

CONTROL SECTION (Cont'd)TRIG TIME
(SET ZERO)

TRIG TIME. Displays the time for the trigger of the trace selected. This time is total seconds since the last TRIGGER TIME RESET command from the HP-IB or the front panel. The resolution of the trigger time is .05 seconds. It is displayed in scientific notation, so that as the time gets large, resolution is lost. The largest value of trigger time is 2.14748 billion seconds, or approximately 68 years.

(SET ZERO). Press SHIFT key to activate. Resets the trigger time to zero. Once reset, the trigger time clock begins counting by 0.05 second from zero. Note that on previously recorded waveforms, the trigger time will now display as a negative value. This is the number of seconds from the measurement to when the SET ZERO key was pushed. For example, if you make a measurement in SINGLE, wait 5 seconds, and press SET ZERO, the answer displayed will be -5s. Any measurement made after the SET ZERO is pushed will be positive.

3-80. FRONT PANEL CONNECTORS



3-81. The front panel input and trigger connectors are shown in Figure 3-19 and described in the following paragraphs.

CAUTION

Do not exceed the voltage level shown adjacent to each front panel BNC input. Damage to the input circuit may occur.



CHANNEL A. This BNC input is a high-impedance input similar to that used on an oscilloscope.

CAUTION

Damage level is 25V peak.



CHANNEL B. Same type of input as Channel A.

CAUTION

Damage level is 25V peak.

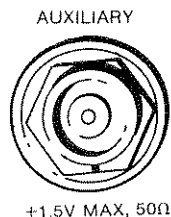

AUXILIARY. This BNC input is a direct, 50-ohm input to the ADC. There are no offset or gain controls. Input range is -1.024 to +1.022 volts.

CAUTION

Do not exceed +1.5V peak.

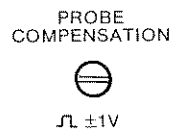

PROBE COMPENSATION. Connection for scope probe compensation. Provides a 1 kHz, 1-volt square wave with which to adjust the compensation control of standard scope probes.

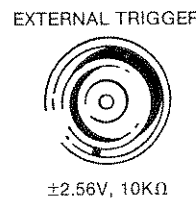

EXTERNAL TRIGGER. This BNC input is a 10 K-ohm input with a range of +2.54 to -2.56 volts. The trigger level at this input is selectable in 20 mV steps over the full range. Hysteresis is nominally 100 mV.



MANUAL TRIGGER. This key acts like a signal placed in the external trigger input. When the key is pressed, a trigger is generated, and the measurement continues as though a real trigger had occurred.

NOTE

It is possible to press this key too early in a long measurement. Time for the pre-trigger is required before pressing.

3-82. FRONT PANEL ANNUNCIATORS



3-83. The front panel annunciators (in front window) are described in the following paragraphs.

ADC Monitor

OVFL **UNFL** These 10 LEDs, plus OVFL and UNFL appear in the left side of the window. The LEDs monitor the activity at the output of the ADC (of the signal seen by the ADC).

ARM **ARM.** THE ARM light indicates that the 5180A is storing data in memory. The ARM light comes on when the 5180A is measuring. It goes off when the measurement is complete.

TRG **TRG.** The TRG light indicates that the 5180A has received a trigger. It remains on until the measurement is completed. The appearance of an ARM, but not a TRG may indicate an improperly set trigger level.

XTB **XTB.** The XTB light indicates that the internal timebase is disabled, and that the external timebase is being used. The timebase digits will show a display of the form 1E0, which indicates the divide ratio.

ANL **ANL.** The ANL light indicates that the 5180A is performing an analysis function on the data displayed. Thus, the waveform displayed may not be that being recorded. This light is on when the TR1-TR2 function is selected.

RMT **RMT.** The RMT light indicates the remote/local state of the 5180A on the HP-IB. (REMS+RWLS). Refer to paragraph 3-154.

TLK **TLK.** The TLK light is an HP-IB status indicator showing that the 5180A is addressed to talk or is in Talk Only (TADS+TACS+SPAS).

LSN **LSN.** The LSN light is an HP-IB status indicator showing that the 5180A is addressed to listen (LADS+LACS).

SRQ **SRQ.** The SRQ light shows that the 5180A has generated a request for service on the HP-IB. Specifically, it indicates the RQS message (SRQS).

HOT

HOT. The HOT light is a malfunction indicator that comes on if a thermal cutout has been activated. If this light comes on, the power supplies will shut off, until the instrument cools. The HOT light is also on when the thermal switches are bypassed by the SERVICE/NORMAL test switch on the power supply motherboard in SERVICE position. In this case, the instrument will be on regardless of the position of the POWER switch. The following table indicates the state of the switches and the HOT light:

POWER SWITCH	TEST SWITCH	THERMAL CUTOUTS	HOT LIGHT
Off	Off	X	Out
X	On	X	On
On	Off	Open	On
On	Off	Closed	Out

Note: X = Don't care

CLD

CLD. The CLD light indicates that the instrument temperature may not have stabilized. CLD is actuated by time from turn on (not temperature) so it is possible to turn the instrument off and back on, and have the light turn on. The CLD light remains on for 10 minutes after the 5180A is turned on.

TR1

TR1. The TR1 light indicates that the information displayed in the digits display refers to Trace 1.

TR2

TR2. The TR2 light indicates that the information displayed in the digits display refers to Trace 2.

LEN

LEN. The LEN light indicates that the information in the digits display is the length of block.

CSR

CSR. The CSR light indicates that the voltages or times being displayed are the values of the cursor (or differences between cursors).

SEC
V

SEC. The SEC light is a units indicator for seconds.

V. The V light is a units indicator for volts.

LOC

LOC. The LOC light indicates that the information in the digits display is the location of the block. This annunciator is lit alone for the RECORD LOCATION and with TR1 or TR2 for TRACE 1 LOCATION or TRACE 2 LOCATION.

FRONT PANEL ANNUNCIATORS (Cont'd)

DSP **DSP.** Indicates when GAIN, OFFSET, ZOOM, and POSITION digits are shown in main display.

DISPLAY **DISPLAY.** This general purpose display (main display) is used to display digits or word messages for general 5180A functions. The formats will vary according to the type of information displayed. The following table summarizes the display and annunciators:

Function	Display
SAV LOC	SL n
RECALL LOC	rL n
CURSORS	CSR nnnnnn SEC, V
CURSOR Δ	CSR nnnnnn SEC, V
TRACE LOC	TR1, TR2 nn LOC
RECORD LOC	nn LOC
RECORD LENGTH	nn LEN
GAIN	TR1, TR2 nn DSP
OFFSET	TR1, TR2 nnnnnn DSP
ZOOM	TR1, TR2 nnnn DSP
POSITION	TR1, TR2 nnnnnn DSP
TRIG TIME	nnnnnn SEC

In addition to the display of functions, the main display provides error messages and output messages. When a hardware failure or operator error is detected, the error message is shown on this display (see paragraph 3-94). When an output mode is selected, the display will show an output message for as long as the output is in progress (as shown above under DISPLAY). The following table lists other messages that may be displayed.

Message	Meaning
OUtPUt	HP-IB output is in progress.
FASt 1	DMA input is in progress. No other functions will operate until this function is complete.
FASt 0	DMA output is in progress. No other functions will operate until this function is complete.
CAL	XYZ display is in CAL mode. Press CAL again to exit.
AUtoSE	The AUTOSET function is in progress.
AUto n	The AUTO ADV function is in progress or has been selected.
LASt	The AUTO ADV function has finished.
SHIFt	The SHIFT key has been pressed.
SELF t	The SELF TEST function is in progress.
Crt	During SELF TEST, the XYZ display pattern test is being performed.
InPut	HP-IB input is in progress.
Plot	HPGL output is in progress.
rcdr	XY recorder output is in progress.
tr=	TRACE 1 = TRACE 2 in dual trace or TR1-TR2 modes.
Adc	ADC and Input amplifier test in progress during SELF-TEST.
CArE	AUX key has been pressed.

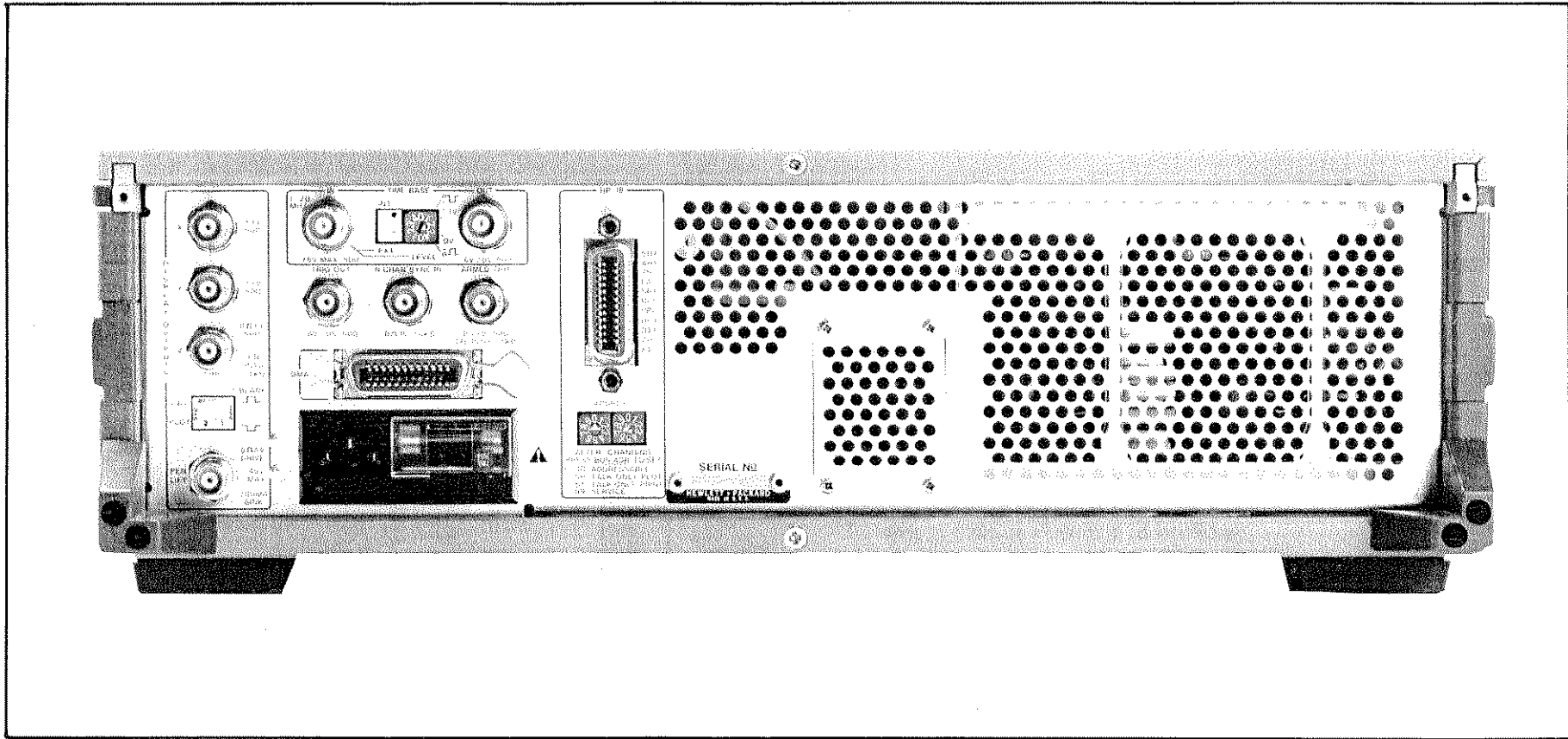

Figure 3-20. Rear Panel Controls and Connectors

3-84. REAR PANEL CONTROLS AND CONNECTORS

3-85. The rear panel contains the output controls, connectors for the XYZ display, the DMA connector, the HP-IB connector, external time base connectors, and trigger connectors as shown in Figure 3-20 and described in the following paragraphs.

DISPLAY OUTPUTS



X. The X-output drives the X-axis of an external CRT or XY recorder. The output is 0V to -1V into 50 ohms. The bandwidth necessary on the X-axis channel is 5 MHz (point-to-point 800 ns).

REAR PANEL CONTROLS AND CONNECTORS (Cont'd)



Y. The Y-output drives the Y-axis of an external CRT or XY recorder. The output is 0V to -1V into 50 ohms. The bandwidth necessary on the Y-axis channel is 5 MHz (point-to-point 800 ns).



Z. The Z-output drives the Z-axis (blanking input) of an external CRT. The output is 0 volts to 1 volt into 50 ohms. In the normal mode (\square), a 0-volt level implies that the beam is on. In the inverted mode (\sqcup), a 2-volt level implies that the beam is on. The bandwidth necessary on the Z-axis channel is 1.25 MHz (must blank within 265 ns of receiving blank signal level).

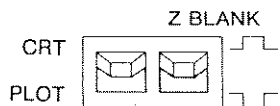

CRT/PLOT. This switch controls whether the X, Y, Z, and PEN LIFT outputs are connected to a CRT or connected to an XY recorder. When the switch is in the CRT position, the outputs will refresh the CRT continuously. When the switch is in the PLOT

position, the outputs will be dormant until after the OUTPUT key is pressed. The speed of the XY recorder output is controlled by the SPEED key on the front panel.

Z BLANK. This switch controls the polarity of the Z-axis output.



PEN LIFT. The PEN LIFT output is an open collector output intended to be used as a ground closure to operate the pen lift solenoid of an XY recorder. It will sink 1 amp peak, 200 mA continuously to 45 volts. The output is TTL compatible into a high impedance.

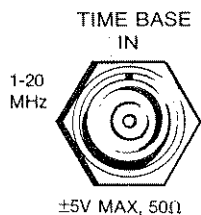

TIME BASE IN. This connector provides an external means of synchronizing the timebase signal to the ADC. It is terminated in 50 ohms to ground. To use this input with other logic families, a 1K series resistor (HP Part Number 10871-60101) must be used. The input accepts 5V peak-to-peak maximum, 1V peak-to-peak minimum.

TIME BASE
OUT



TIME BASE OUT. This output is a buffered version of the timebase signal being sent to the ADC. It is a 0V to -0.5V square wave when 5180A is operated in internal timebase.

NOTE

Measurement answers displayed on the front panel assume a 20 MHz input. Frequencies as low as 1 MHz may be used, but the measurement answer displayed on the front panel must be scaled (divided) by the ratio of 20 MHz/timebase frequency in MHz.

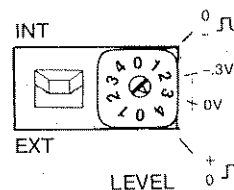

INT/EXT. This switch selects the internal or external timebase signal. In EXT, a 1 to 20 MHz external signal may be input.

LEVEL. This switch selects one of four threshold levels for the timebase signal: -1 volt, -0.3 volts, 0 volts, and +1.8 volts, into 50 ohms. These levels are set for ECL levels, HP-EECL levels, sine waves, and TTL levels.

TRIG OUT



TRIG OUT. This connector provides the internal trigger out. It is used to synchronize the triggering of several units. TRIG OUT is a positive going signal from -0.6 volts to 0 volts into 50 ohms. TRIG OUT goes low when the measurement has been completed.

N CHAN SYNC IN



N CHAN SYNC IN. This input is used to synchronize the timebase divide chains in multiple 5180A's. To sync multiple units, a pulse at least 10 times the timebase period wide, TTL level, should be injected. This input is sensitive to both edges of the input, and the timebase count chain will reset on both the leading and trailing edges of the pulse. The input should always be left low.

REAR PANEL CONTROLS AND CONNECTORS (Cont'd)**ARMED OUT**

0-5V, 50Ω
TTL INTO ≥ 1KΩ

ARMED OUT. This TTL 50-ohm output (0-5V into high impedance, 0-1V into 50 ohms) shows that the 5180A is making a measurement. ARMED goes high when the 5180A is armed and waiting for a trigger. This signal is similar to the ARM annunciator, however it may occur after the ARM light is lit. ARMED waits for the memory to cycle into the proper position for a trigger. In pre-trigger mode, it is necessary to “pre-charge” the memory before allowing a trigger. ARMED waits for the pre-charge time and can be used to initiate stimulus hardware. ARMED goes low when the measurement has been completed.

DMA

DMA. This connector provides high-speed data from the memory. The output/input rate is 1-megaword/second, maximum. There are 10 data lines, 6 address indicator lines, 2 handshake lines, and 2 control lines.

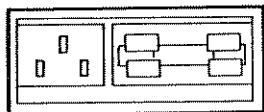
POWER LINE INPUT

POWER LINE INPUT. AC Power Module, 100/240 volt, 50/60 Hz operation. Consists of an IEC approved connector, a fuse, and a printed circuit card line-voltage selector. Refer to paragraph 2-12 for details.

HP-IB BUS CONNECTOR

HP-IB BUS CONNECTOR. Connects the 5180A to the Hewlett-Packard Interface Bus for remote operation. Refer to paragraph 3-154 for details on programming.

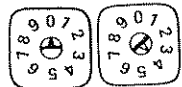
ADDRESS SWITCHES

ADDRESS SWITCHES. The HP-IB address switches are used to select the HP-IB talk or listen address (0-30). In addition, ADDRESS 50 selects TALK ONLY with a format suitable for an HP 9872B/C/S, 7245, or 7225 plotter. (See OUTPUT key description, paragraph 3-79.) ADDRESS 51 selects TALK ONLY with a format suitable for a printer or mag tape. ADDRESS 52 may be used on any plotter that will respond to a page advance command. The plotter will be told to advance following the output

of the plot. ADDRESS 90-99 is used to select SERVICE mode. In the SERVICE mode, diagnostic routines may be selected to help in troubleshooting. Refer to Table 3-14 for address switch settings and ASCII codes.

3-86. OPERATING FEATURES

3-87. Operating features of the 5180A are described below:

- a. Self-Test.
- b. Selection of front panel functions.
- c. Overall control of front panel.

3-88. Self-Test

3-89. On power-up, the 5180A runs a self-test as described in paragraph 3-60. If an error occurs during this test, an error message is displayed as described in paragraph 3-94. For a more complete self-test, which includes a check of the ADC calibration and XYZ display in addition to the power-up test, press SHIFT, then SELF-TEST on the front panel. Any recorded data is lost when this test runs, but the front panel settings and save locations are not affected. If no errors are detected, the time since the 5180A was last serviced is displayed at the end of the test.

3-90. Selection of Front Panel Functions

3-91. Front panel functions are selected by pressing the pushbutton keys. The color of the key or the key label determines how the key is used:

- a. Dark grey keys: Select the function merely by pressing the key. (If a key has two functions, an LED or display will indicate the active function.)
- b. Light grey keys (same color as DATA ENTRY knob): Press key, then turn DATA ENTRY knob and observe value displayed. The function selected is indicated by flashing decimal points in its display.
- c. Blue-lettered keys: Select function by pressing SHIFT, then press key.

3-92. Overall Control of Front Panel

3-93. Some of the keys are used to control the overall use of the front panel functions. If it is desired to allow the 5180A to operate in its current state, without being disturbed, the following controls may be used:

- a. HOLD. Pressing HOLD disconnects all front panel functions from the DATA ENTRY knob.
- b. PANEL LOCK. Pressing SHIFT, then PANEL LOCK causes all front panel settings to be locked out of operation.
- c. UNLOCK/LOCAL. To unlock the front panel settings or return from remote (HP-IB) operation, press UNLOCK/LOCAL.

3-94. ERROR INDICATIONS

3-95. Two types of error indications are displayed in the main display of the 5180A when problems occur during operation. One type of error is called "hardware failure" and the other type is called "operation error." These indications are described in the following paragraphs and are listed in *Table 3-2*.

3-96. Hardware Failures

3-97. Hardware failures require servicing or repair of the instrument and are displayed as FAxx.yy, where:

FA = Hardware failure

xx = Assembly number (A__) of board that failed

yy = IC reference designator (U__) of the first failure detected on that board.

For example: FA13.3 displayed indicates failure of U3 EPROM on the A13 Processor board.

3-98. Operation Errors

3-99. Operation errors are caused when the user has requested an operation that the 5180A does not understand or cannot perform. These errors are displayed as Erxx.yy, where:

Er = Operation error

xx = Error category as defined in paragraph 3-100

yy = Specific error condition as defined in *Table 3-2*.

3-100. ERROR CATEGORIES. The category of the error indicates the general type of the operation error or the general location of the hardware error and is shown by the most significant one or two digits displayed as shown below.

Category Displayed	Description
1	HP-IB input error
2	HP-IB address switch error
3	ADC calibration failure
4	AUTOSET error
5	Key not allowed (option switch set incorrectly)
6	Key function not allowed under present conditions
7	Key not allowed
8	
9	A9 Memory board failure
10	A10 Memory Controller board failure
11	
12	
13	A13 Processor board failure
14	A14 ROM/CMOS RAM board failure
15	
16	A16 XYZ Driver board failure
17	A17 ROM XYZ Clock board failure
18	A18 Front Panel/Display Interface board failure
19	
20	
21	
22	
23	
24	
25	

Table 3-2. Error Messages

DISPLAY	SPECIFIC ERROR CONDITIONS
Er1.00	HP-IB transmission error (no listener when addressed to talk)
Er1.10	HP-IB input error (must be a digit 0-9)
Er1.20	HP-IB input error (illegal command)
Er1.30	HP-IB input error (alpha character expected)
Er1.40	HP-IB input error (subfunction out of limits)
Er1.50	HP-IB input error (floating point number not expected)
Er1.60	HP-IB input error (too many minus signs in mantissa)
Er1.61	HP-IB input error (two decimal points in mantissa, or decimal point exponent)
Er1.62	HP-IB input error (more than one "E" or "e")
Er1.63	HP-IB input error (too many minus signs in exponent)
Er1.64	HP-IB input error (too many digits in exponent)
Er1.65	HP-IB input error (floating point input expected)
Er1.70	HP-IB input error (mantissa out of range, >8000000)
Er1.71	HP-IB input error (floating point number too large)
Er1.72	HP-IB input error (floating point number too small)
*Er2.yyy	HP-IB address switch error (yyy => illegal address)
FA3.00	Fail input amplifier test Channel A ground 1V range.
FA3.01	Fail input amplifier test Channel B ground 1V range.
FA3.02	Fail input amplifier test Channel A .1V 1V range.
FA3.03	Fail input amplifier test Channel B .1V 1V range.
FA3.04	Fail input amplifier offset test Channel A +1/2 FS 1V range.
FA3.05	Fail input amplifier offset test Channel B -1/2 FS 1V range.
Er4.00	AUTOSET can't find a signal.
FA5.00	Key/Command not allowed.
Er6.01	Can't set hysteresis in EXT TRIG.
Er6.02	BI-TRG not allowed in EXT. TRIG.
FA7.00	Key/Command not allowed.
FA8.yy	2147 RAM failure on A8 (yy => IC reference designator).
FA9.yy	2147 RAM failure on A9 (yy => IC reference designator).
FA10.23	Failure on A10U23.
FA13.yy	If yy = 5, 8, 10, M6810 RAM failure on A13. If yy = 3, 2532 EPROM failure on A13.
FA14.yy	If yy = 1, 2, 3, MASKED ROM failure on A14. If yy = 4, 5, 2114 NMOS RAM failure on A14. If yy = 6, 7, 8, 9, 5101 CMOS RAM failure on A14.
*Er14.00	CMOS battery discharged on A14.
FA14.99	Missing ROM.
FA16.yy	2114 XYZ refresh RAM failure (yy => IC reference designator) on A16.
FA17.yy	2532 EPROM failure on A17 (yy => IC reference designator).
FA18.yy	Illegal keycode received (yy => illegal code).

*Note: Cleared with SHIFT key.

3-101. OPERATING PROCEDURES

3-102. To operate the 5180A, refer to the following information in this section:

- a. A general overall description of front panel controls and functions, *Figure 3-19*.
- b. A detailed description of each front panel control and indicator, paragraphs 3-66 through 3-83.
- c. A detailed description of rear panel controls and connectors, paragraph 3-84 and *Figure 3-20*.
- d. Operating features, paragraph 3-86.
- e. Front panel operation, paragraphs 3-103 through 3-153 and *Tables 3-3 through 3-11*.
- f. Programming features, paragraph 3-154.
- g. HP-IB commands, paragraph 3-165 through 3-180.

NOTE

Detailed basic operating information is also available in Product Note 5180A-1, Understanding the 5180A Waveform Recorder. Order from your nearest HP Sales and Service Office, listed in the back of this manual.

3-103. Connection and Calibration of External XYZ Display

3-104. The 5180A provides analog XYZ output, so that data stored in memory may be displayed on an external CRT. Digitized samples are taken from memory and converted by a low-speed D/A converter to analog signals, which drive the XYZ outputs of the 5180A (see *Figure 3-21*). To use an external CRT, the XYZ outputs of the 5180A must be connected to a CRT display or an oscilloscope, as shown in *Figure 3-22*. Also, two switches on the rear panel must be set to indicate to the 5180A the type of display being used (see *Figure 3-23*). When the display is connected to the 5180A, it may be calibrated using a special front panel-controlled calibration feature. Press CAL/UNCAL to output a test display, which may be used in adjusting GAIN, OFFSET, etc., on the external display (see *Figure 3-24*). After calibration, erase the pattern by pressing CAL/UNCAL again.

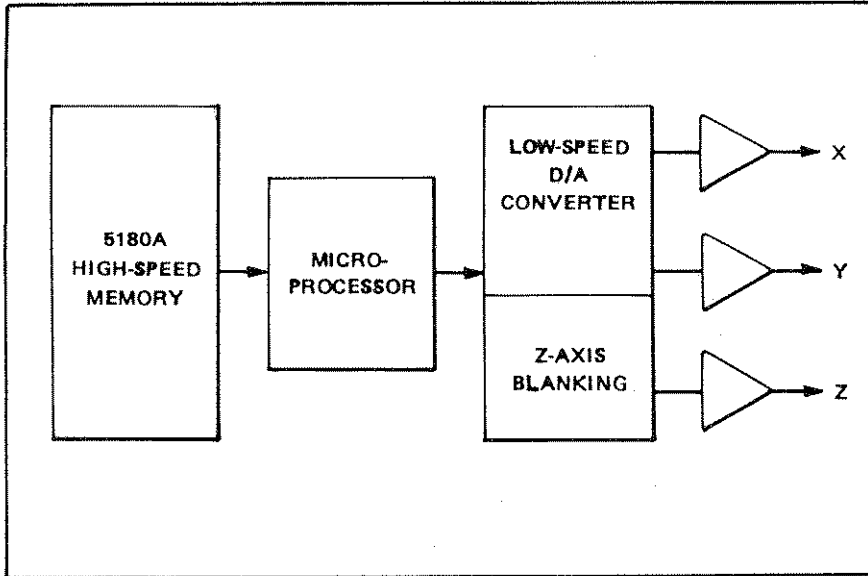

Figure 3-21. Digital Samples Converted to Analog Form for XYZ Drive

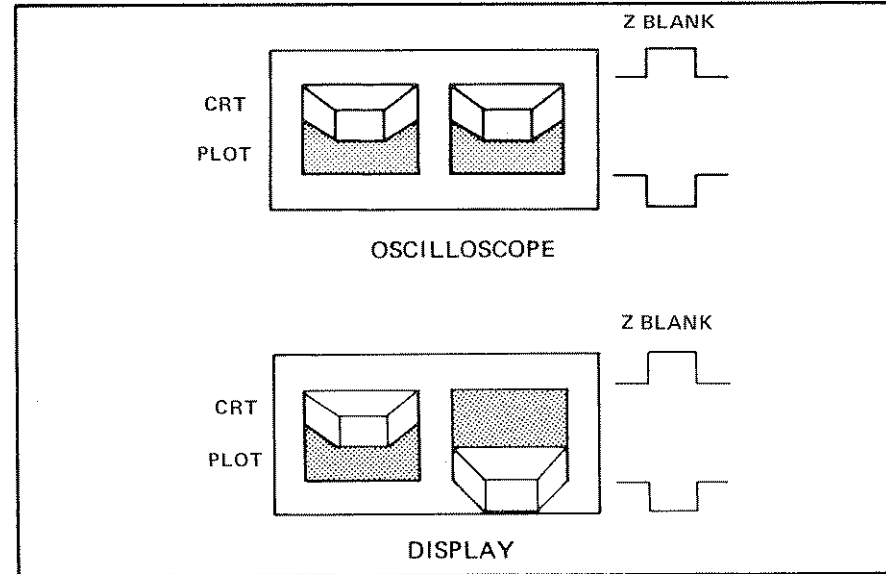

Figure 3-23. Switch Settings on 5180A Rear Panel for Display Oscilloscope

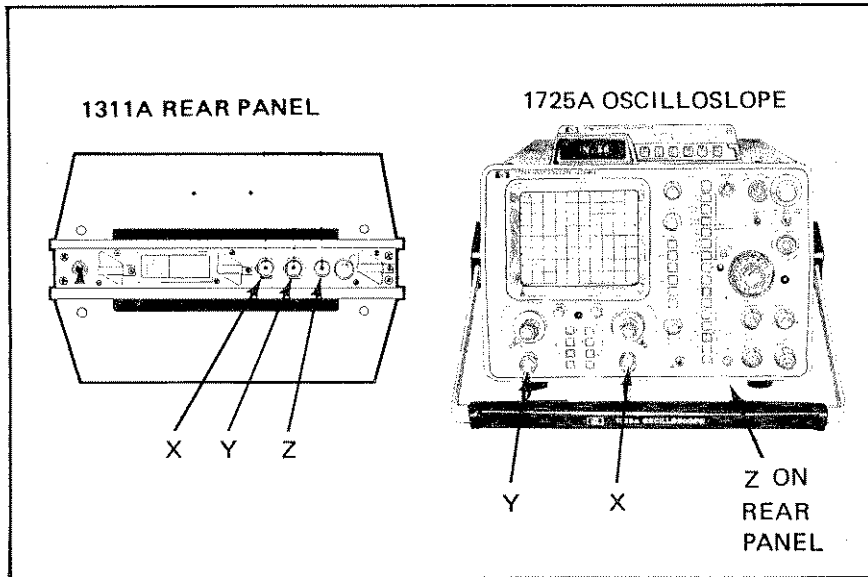

Figure 3-22. Connections for 1311A Display and 1725A Oscilloscope (Without Option 101)

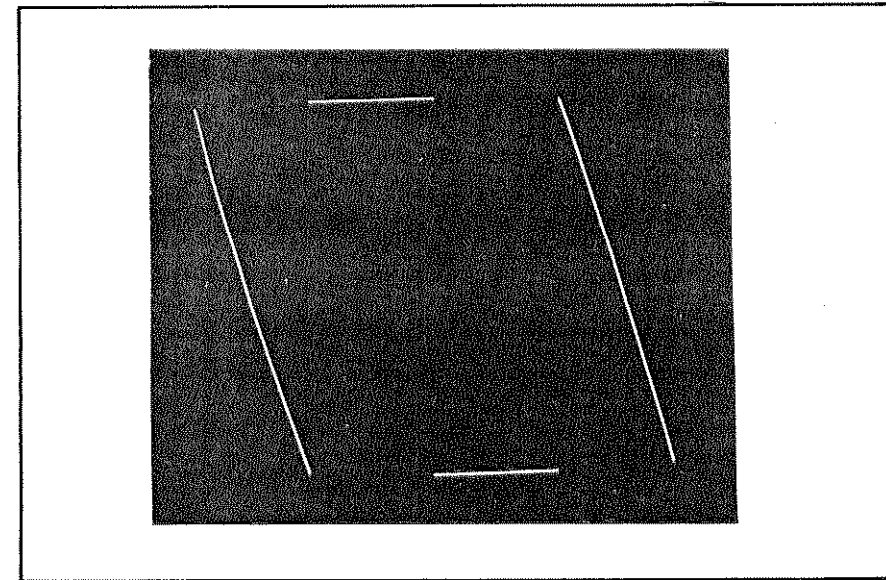

Figure 3-24. 5180A Calibration Pattern

3-105. Preset, Autoset, Save/Recall

3-106. The front panel provides features for automatic selection of function values. Methods of initializing front panel function setups are as follows:

- a. PRESET. (Places known values into front panel functions.)
- b. AUTOSET. (Selects front panel function values based on input waveform.)
- c. SAVE LOCations. (Stores selected front panel function values.)

NOTE

Pressing PRESET initializes the front panel functions to known values which are permanently stored in the 5180A memory. Pressing AUTOSET sets the front panel functions to optimum values for a repetitive input waveform. Values selected by PRESET and AUTOSET are given in *Table 3-3*.

3-107. Pressing SAVE LOC stores the front panel function value setup in a "save location" for future use. The third method of automatically setting front panel function values involves recalling a front panel setup from one of these locations. The 5180A is capable of saving and later recalling as many as four selected complete front panel setups. A fifth save location stores the last front panel function values whenever a PRESET or AUTOSET is executed. With power off, a battery in the 5180A will save these stored setups for as many as three or four days. Front panel setups may be quickly saved and easily recalled from storage in the save locations. Operating procedures are given in *Table 3-4*.

Table 3-3. Using Preset and Autoset Function Values

FUNCTION	PRESET	AUTOSET
	Pressing PRESET places known values into front panel functions.	Pressing AUTOSET selects values that are based on the input waveform.
Channel	A	Scans for signal, starting at currently selected channel.
Range or Offset	10V range. No offset.	Adjusted to signal.
Coupling	DC	AC
Sweep Mode	Auto	Auto
Trigger Position	-50%	-50%
Trigger Source	Internal	Internal
Trigger Slope	Positive	Positive
Trigger Level	0%	Middle of waveform.
Hysteresis Level	2%	25% of p-p voltage in waveform.
Main Time Base	50 ns/sample	2-6 cycles of waveform
Time Base Mode	Main only	Main only
Record Length	1024	1024
Record Location	1	1
Dot or Line Display Mode	Line	Line
Single or Dual Traces	Single	Single
Selected Trace	Trace 1	Trace 1
Trace Location	Location 1	Location 1
Arm Delay	190 ms	190 ms

Table 3-4. Using Preset, Autoset, Save/Recall

FUNCTION	ACTION	INDICATION
PRESET		
Preset the front panel functions to known values.	Press SHIFT, then PRESET.	Front panel functions initialized to PRESET as shown in Table 3-3.
AUTOSET		
Select the front panel functions based on input waveform.	Press AUTOSET.	Front panel functions optimized for AUTOSET as shown in Table 3-3.
SAVE/RECALL		
Store a complete front panel setup (in one of four locations).	Press SAVE LOCATION, then turn the DATA ENTRY knob to select a save location between one and four. Press SHIFT, then SAVE.	Number of the selected save location shown on display.
Recall a stored front panel setup.	Press RECALL LOCATION, then turn DATA ENTRY knob to select the location (between 1 and 5) to be recalled. Press SHIFT, then RECALL. (Location 5 stores the last front panel functions whenever PRESET or AUTOSET is executed, or when power is turned off.)	Recalled front panel functions activated.

3-108. Channel Selection, Range, and Offset Selection

3-109. The 5180A has one 50-ohm input channel, Channel AUX (auxiliary) and a dual-channel input which provides two high-impedance inputs, Channels A and B. Available inputs are as follows:

- a. Channel A only (high-impedance).
- b. Channel B only (high-impedance).
- c. Channels A and B, Chopped mode (alternate sampling).
- d. Channel AUX only (50-ohm).

3-110. The maximum possible sampling rate for any of the channels used alone is 20 MHz. In the chopped mode, Channels A and B alternate samples and the maximum sampling rate for each channel decreases to 5 MHz. When alternately recording samples of dual inputs, a sample of one input is followed 100 ns later by a sample of the other input. If internal triggering is used when sampling in the chopped mode, triggering will be based on the waveform input to Channel A.

3-111. The input voltage range for the auxiliary (AUX) channel is -1.024 to $+1.022$ volts. Channels A and B offer independently selectable input ranges and voltage offsets for additional versatility. These two channels may have input voltage ranges as small as -100 mV to $+100$ mV or as large as -10 to $+10$ volts, in a 1, 2, 5 sequence. Voltage offset may be selected for each channel as any value in that channel's input voltage range. In addition, AC or DC coupling may be selected for Channels A and B independently. Operating procedures are given in Table 3-5. Channels A and B each have two functions for calibration purposes. Either channel may be grounded in order to measure offset error from the input amplifier, or 100 mV may be placed at either input to calibrate the gain of the channel.

Table 3-5. Using Channel Selection, Range, and Offset Selection

FUNCTION	ACTION	INDICATION
NOTE		
For detailed descriptions of key functions, refer to paragraph 3-68.		
CHANNEL SELECTION		
Channel A	Press CH A	CH A LED lights
Channel B	Press CH B	CH B LED lights
Channels A and B (Chopped)	Press CH AB	CH AB LED lights
Auxiliary Channel	Press AUX then UNLOCK, then AUX again	AUX LED lights
To calibrate offset errors in either input amplifier.	Press SHIFT, then GND A. Press SHIFT, then GND B.	GND A LED flashes GND B LED flashes
Calibrate the gain of the input channel.	Press SHIFT, then .1V A Press SHIFT, then .1V B	.1V A LED flashes .1V B LED flashes
RANGE AND OFFSET SELECTION		
Select RANGE		
CHANNEL A	Press CHANNEL A RANGE, then turn DATA ENTRY knob.	Select value displayed above activated RANGE key as the maximum positive voltage.
CHANNEL B	Press CHANNEL B RANGE, then turn DATA ENTRY knob.	
OFFSET SELECTION (Add an analog offset to the incoming signal)		
CHANNEL A	Press OFFSET, then turn the DATA ENTRY knob.	Added offset varies with knob setting.
CHANNEL B	Press OFFSET, then turn the DATA ENTRY knob.	
Zero either channel offset.	Press SHIFT, then ZERO for channel desired.	OFFSET set to zero. DATA ENTRY knob connected to Channel A OFFSET.
Select AC or DC coupling to the input amplifier for either channel.	Press AC for channel desired. Press DC for channel desired.	AC LED lights to indicate capacitive coupling. AC LED goes off.

3-112. TRIGGERING

3-113. Accurate triggering is important because the location of the trigger determines the point at which the incoming waveform will begin to be stored in memory. Refer to paragraph 3-24 for detailed descriptions. Special features of the 5180A trigger capabilities are briefly described below and operating procedures are given in *Table 3-6*.

- a. Internal or external triggering.
- b. Precise trigger level selection.
- c. Pre- and post-trigger recording.
- d. Single-shot or repetitive triggering.

3-114. Internal or External Triggering

3-115. Internal or external triggering is selected at the front panel as described in *Table 3-6*. Internal triggering is based on the incoming waveform and uses an internal digital trigger circuit that provides settable digital hysteresis as described in paragraph 3-74. External triggering is provided by an external source via an analog circuit and is independent of the incoming waveform. The MANUAL TRIGGER key on the front panel provides a single external trigger pulse.

Table 3-6. Operating the Trigger Section

FUNCTION	ACTION	INDICATION
NOTE For a detailed description of each key function in the trigger section, refer to paragraph 3-71.		
SOURCE		
Select internal or external triggering.	Press SOURCE.	EXT LED lights if external trigger selected.
For single manual trigger.	Select EXT, press and release MANUAL.	EXT LED lights.
SLOPE		
Select positive or negative slope or both (BI-TRG).	Press SLOPE for LED indication.	One LED lights to indicate slope selected. Both LEDs light to indicate BI-TRG.
TRIGGER LEVEL		
Specify trigger level as a percent of full-scale voltage range (2.56V for external, 1.024V for auxiliary channel internal. User selected for Channels A and B).	Press and release % FS and turn DATA ENTRY knob.	LEVEL display shows level specified.
Specify trigger level in volts	Press and release VOLTS and turn DATA ENTRY knob.	
HYSTERESIS (Internal Triggering only)		
Specify hysteresis as a percent of maximum positive voltage (between 0 and 100%).	Press SHIFT, % HYS and turn DATA ENTRY knob.	HYSTERESIS display shows level specified.
Specify hysteresis in volts (between 0 and half the full-scale input voltage range).	Press SHIFT, V HYS and turn DATA ENTRY knob.	

FUNCTION	ACTION	INDICATION
PRE- and POST-TRIGGERING		
Specify pre- or post-triggering in terms of percent of memory.	Press % MEM and turn DATA ENTRY knob. Select a percentage between -100 and -1 for pre-triggering, or between 0 and 9999 for post-triggering. Press SHIFT, then press -50% to preset trigger position to -50% and allow further changes in trigger position.	POSITION display shows percent or specified.
Specify pre- or post-triggering in terms of time. (Pre-triggering specified in negative time, post-triggering specified in positive time.)	Press TIME and turn DATA ENTRY knob.	POSITION display shows time specified.
SWEEP ARM		
Select single-sweep trigger arming.	Press SINGLE to arm for a single trigger. To re-arm for another trigger, press SINGLE again.	SINGLE LED lights.
Select automatic trigger arming.	Press AUTO.	AUTO LED lights.
Select normal trigger arming.	Press NORM.	NORM LED lights.
NOTE		
For detailed descriptions of Sweep Arming modes, refer to paragraph 3-72.		
Specify the arm delay.	Press SHIFT, then ARM DELAY and turn DATA ENTRY knob to select desired delay time.	POSITION display shows delay time.

3-116. Precise Trigger Level Selection

3-117. The trigger level may be precisely selected by using the DATA ENTRY knob and the LEVEL display. Samples of the incoming waveform (or of the external trigger signal) are compared to this selected value. The slope of the signal is also selectable at the front panel.

3-118. Pre- and Post-Trigger Recording

3-119. A digitized signal may be stored before or after the trigger occurs by using pre- or post-trigger recording. Pre-triggering allows information to be recorded before the trigger point, which aids the user in determining the cause of the trigger. Post-triggering allows the 5180A to wait until enough samples have been taken of the signal to fill the memory as many as ten times before recording actually begins.

3-120. TIME BASES

3-121. Two independent time bases and three time base modes are provided to optimize sampling rate, waveform rate of change and record length, as described in paragraph 3-29. Two time bases allow selection of two different sampling rates for the best possible fit to the incoming waveform. This allows a higher sampling rate to be used where more information is needed and a lower sampling rate where less memory is needed, to conserve memory space. Flexible sampling rate configurations are provided by three time base modes as described in the following paragraphs. Operating procedures are given in *Table 3-7*.

- a. Main only.
- b. Mixed.
- c. Toggle.

3-122. Main Only

3-123. The MAIN ONLY mode should be used to record an entire sweep at the sampling rate of the main timebase. The user selects the starting point of the memory record by selecting the trigger position. Pre-triggering is specified by negative positions and permits up to 100% of the memory to be filled before the trigger occurs. Post-triggering is specified by positive positions and allows permanent storage of data to begin after digitized samples have filled the memory almost 100 times (9999%) after the trigger.

Table 3-7. Operating the Time Base Section

FUNCTION	ACTION	INDICATION
NOTE		
For a detailed description of each key function in the TIME BASE section, refer to paragraph 3-76.		
TIME BASE		
Specify main timebase in time/sample.	Press MAIN/SMPL and turn DATA ENTRY knob.	MAIN LED lights. TIME display shows specified timebase in SMPL mode, with a range from 50 ns to 50 ms in a 1-2-5 sequence.
Specify delay timebase rate in time/sample.	Press DELAY/SMPL and turn DATA ENTRY knob.	DELAY LED lights.
Specify main timebase rate in time/sweep.	Press SHIFT, then press MAIN/SWEEP and turn DATA ENTRY knob.	TIME BASE display shows specified time base in SWP mode.
Specify delay timebase rate in time/sweep.	Press SHIFT, then press DELAY/SWEEP and turn DATA ENTRY knob.	
NOTE		
An external timebase connected to the rear panel TIME BASE IN (1 to 20 MHz) may be used to provide a slower sampling rate than 50 ms/sample. Refer to paragraph 3-84 for detailed description of TIME BASE IN.		
TIMEBASE MODES		
Select		
MAIN ONLY	Selected on power up.	MAIN ONLY LED lights.
MIXED	Press SEQUENCE.	MIXED LED lights.
TOGGLE	Press SEQUENCE again.	TOGGLE LED lights.

3-124. Mixed Timebase Mode

3-125. The MIXED timebase mode may be used to record data at a higher rate when more detail is needed at either end of the waveform, and to use a lower sampling rate for the rest of the waveform. Thus, memory is conserved. This mode begins sampling at the rate of the main timebase and switches to the delayed timebase sampling rate during the sweep. When the mixed timebase mode is used, the trigger position determines at what point the transition from main to delay timebase occurs. For a positive trigger position, storage of data begins at the trigger, and the selected position is the location at which the timebase changes. If the trigger position is negative, the timebase changes when the trigger occurs, and the position determines how many data samples should be recorded prior to the trigger point.

3-126. Toggle Timebase Mode

3-127. The TOGGLE timebase mode changes the timebase twice during a sweep, so greater detail is recorded only in the middle of the sweep, or at both ends. The trigger position must be negative in the toggle mode because the 5180A goes to mixed mode if a positive position is selected. The main timebase sampling rate is used until the trigger occurs, then the amount of memory specified by the trigger position is filled at the delay sampling rate. Finally, the main sampling rate is used for the remainder of the sweep, such that the portion of memory filled using the delay sampling rate is centered in the memory record. Both timebase changes in the toggle mode are indicated by bright dots on the external display.

3-128. MEMORY CAPABILITIES

3-129. Digital storage in the memory allows recorded waveforms to be saved indefinitely and provides flicker-free display on external displays via analog XYZ drive circuits. Additional features of the memory are described in the following paragraphs. Operating procedures are given in *Table 3-8*.

- a. Memory segmentation.
- b. Automatic advance.
- c. Trigger time recording.

Table 3-8. Using Memory Capabilities

FUNCTION	ACTION	INDICATION
NOTE		
For a detailed description of memory segmentation, refer to paragraph 3-34 and for key functions, refer to paragraph 3-78.		
MEMORY SEGMENTATION		
Segment the memory by selecting the desired record length.	Press RECORD LENGTH and turn the DATA ENTRY knob.	Display shows record length. Single sweep arming mode selected and record location preset to 1.
Select record number to be used for storing incoming data.	Press RECORD LOCATION and turn DATA ENTRY knob.	The new record location is placed into Trace 1 on the 5180A display so latest recorded data will be sent to XYZ display. Selects single sweep arming mode.
AUTO ADVANCE		
Select auto advance to automatically move to the next record each time record is filled.	Press ARM DELAY to control speed of measurements. Press AUTO ADVANCE.	Display shows Auto 1. SWEEP ARM SINGLE LED lights.
Select single recorded measurements.	Measurement made and memory advances to next location. Press SINGLE to re-arm before each measurement.	Display increments after each measurement until location is reached.
Select AUTO or NORM to make automatic repeated measurements until last location is reached.	Press AUTO or NORM	Display increments automatically with each measurement until last location is reached, then AUTO ADVANCE mode is terminated.
TRIGGER TIME		
Check time of recording.	Press TRIG TIME. For more resolution, press SHIFT, then SCROLL. Repeat if necessary. To reset timer to zero, press SHIFT, then SET ZERO.	Display shows total number of seconds between turn-on (or when trigger timer was reset to zero) and trigger of the memory location.

3-130. Memory Segmentation

3-131. The memory may be divided into segments. This allows more than one waveform to be stored before an output data transfer. For example, the memory may be divided into 16 segments of 1K words or 32 segments of 512 words. The maximum number of segments (or records) that the memory may be divided into is 32. The minimum length of a record is 512 words.

3-132. Auto Advance

3-133. The AUTO ADVANCE feature (when activated as described in *Table 3-8*) automatically moves to the next successive record in memory each time a record is filled. This feature is useful during unattended operation, because it allows triggering on a specific signal, recording data, and then waiting for the signal to occur again. For example, a power line can be monitored automatically, and record up to 32 glitches. Refer to paragraph 3-52.

3-134. Trigger Timer

3-135. A special trigger timer records the time at which the trigger occurs with respect to a preselected zero point. If the exact time a waveform was recorded is needed, it is available in terms of the trigger time of the memory record and the zero point of the timer.

3-136. DISPLAY FEATURES**3-137. Single or Dual Trace Display**

3-138. A single waveform stored in memory may be displayed by placing it into the first of two traces (Trace 1). Any two recorded waveforms may be simultaneously displayed by placing one stored waveform into each of the display traces, (Trace 1 and Trace 2). Alternatively, one of these displayed traces may be "live" if it displays the memory segment which is currently

being recorded into. When using dual input chop mode, synchronous or nonsynchronous waveforms may be displayed simultaneously as they are recorded into a single memory record (live) or from a stored record. Operating procedures are given in *Table 3-9*.

Table 3-9. Using Single or Dual Trace Display

FUNCTION	ACTION	INDICATION
NOTE		
For a description of the dual mode, refer to paragraph 3-36 and for key functions, refer to paragraph 3-78.		
Specify the record in memory to be displayed in Trace 1.	Press TRACE 1, then TRACE LOC and turn the DATA ENTRY knob.	Trace 1 displayed on external XYZ display.
Specify the record in memory to be displayed in Trace 2.	Press TRACE 2, then TRACE LOC and turn the DATA ENTRY knob.	Trace 2 displayed on external XYZ display.
Change from single to dual, or from dual to single trace display.	Press SGL/DUAL.	Trace on external XYZ display changes from single to dual or dual to single.

3-139. Zoom, Gain, Position, Offset, and Line Mode

3-140. A portion of a waveform may be selected (using a cursor) and zoomed in, to see more detail. Horizontal expansion may be obtained using the 5180A's ZOOM feature. Vertical expansion is selected by the GAIN feature. Horizontal POSITION and vertical OFFSET are also selectable. These key functions are described in paragraph 3-78. Operating procedures are given in *Table 3-10*.

Table 3-10. Using Zoom, Gain, Position, Offset, and Line Mode

FUNCTION	ACTION	INDICATION
NOTE		
Refer to paragraph 3-78 for a detailed description of key functions.		
Select the center of zoom region on a waveform displayed on external display.	Press TRACE 1 or TRACE 2. Press CURSOR, then turn DATA ENTRY knob to position cursor on any sample point.	Zoom window centered around selected point.
Begin zooming.	Press ZOOM, then turn the DATA ENTRY knob.	
Select the gain of either trace.	Press GAIN and turn the DATA ENTRY knob.	Maximum positive voltage currently available in selected trace is displayed.
Move along the zoomed-in displayed waveform.	Press POSITION, then turn DATA ENTRY knob.	Position selected as the leftmost memory location in zoom window displayed by 5180A.
Select vertical offset of the displayed waveform.	Press OFFSET and turn the DATA ENTRY knob.	Voltage offset varies on trace display.
After zooming, return waveform to show entire memory.	Press HORIZONTAL FIXED.	Return to normal.
Set vertical gain and offset to normal.	Press VERTICAL FIXED. Press DOT/LINE.	
Change display from dot mode to line mode or from line mode to dot mode.		Display changes from dots (showing selected data points, to a smooth curve (that connects the points), and vice versa.

3-141. Zoom

3-142. The horizontal expansion depends upon the size of the memory segments being used. The larger the size of the recorded segments, the more zoom available in the display. When a single waveform is recorded into an entire 16K memory, the zoomed-out display shows one of every 16 sample points, or 1024 points, which is the maximum number that can be displayed by the 5180A. The zoomed-in display shows every seven, six, five, etc., sample points as the display is zoomed in, to bring the waveform closer into view. The amount of zoom is expressed in terms of the zoom window, or the number of memory locations covered by the display. When the zoom is 4096, for example, a 4K-word zoom window is displayed, with one of four points in memory shown on the display. When the number of memory locations shown by the display is 1024 or less, the 5180A displays all sample points in this zoom window. If the zoom window contains only 512 or 256 words, the 5180A spreads them out to cover the entire width of the display. The available zoom settings and the size of the zoom window displayed by each, is shown below:

AVAILABLE ZOOM SETTINGS

Zoom Selected (No. of Samples)	Actually Displayed	Zoom Selected (No. of Samples)	Actually Displayed
256	ALL	9216	1 OF 9
512	ALL	10240	1 OF 10
1024	ALL	11264	1 OF 11
2048	1 OF 2	12288	1 OF 12
3072	1 OF 3	13312	1 OF 13
4096	1 OF 4	14336	1 OF 14
5120	1 OF 5	15360	1 OF 15
6144	1 OF 6	16384	1 OF 16
7168	1 OF 7		
8192	1 OF 8		

3-143. When Channel A/B is selected, the chopped mode alternates recording samples from input Channels A and B and the zoom window contains only half the selected number of samples for each input channel. For example, a 1K-word zoom window recorded in the chop mode contains 512 samples from each waveform.

3-144. Vertical Gain

3-145. Vertical gain is adjustable in a manner similar to horizontal zoom. The amount of gain selected is given as the maximum acceptable positive voltage. For the auxiliary input, the input voltage range is from -1.024 to $+1.022$ volts. For a gain of one, the gain setting should be 1.024 volts. To increase the gain by 2, 4, or 8 times the maximum voltage must be decreased accordingly to 0.512, 0.256 and 0.128 volts, respectively. Conversely, the gain may be decreased by one-half by selecting a maximum voltage of 2.048 volts. Channels A and B offer the same gain factors (0.5, 1, 2, 4, 8) but the gain settings used to obtain these factors depend on the input voltage range selected for the input channel. For example, if the A channel is set for a 10-volt input range, and a gain of 2 is desired, the gain setting must be 5.12 volts. When the display is operated in the dual mode so that two traces are shown, the gain may be selected for each displayed trace independently. The ability to reduce the gain by one-half is particularly useful with dual traces, because both traces can be made easily visible on the display.

3-146. Horizontal Position and Vertical Offset

3-147. In addition to the zoom and gain adjustments for optimum display of a waveform, the horizontal position and vertical offset are also adjustable. The horizontal position is given as the leftmost point in memory to be included in the zoom window. Position settings range from location 0 to the location given by subtracting the size of the zoom window from the size of the memory record. For example, if the memory is segmented into 2K-word records and the zoom window is 512 words, the maximum position setting is $2048 - 512 = 1536$.

3-148. Vertical offset is specified as the voltage offset from the center of the display, and is selectable to 1% of the full-scale voltage range. This offset may be assigned independently for each of the two displayed traces whenever dual mode is used. This feature may be combined with reducing gain to one-half (gain setting = 2.048 volts for auxiliary channel) to completely separate two displayed traces for easy visibility.

3-149. Line Display Mode

3-150. A special feature of the 5180A that helps to make waveforms more visible is called the "line mode." This function connects sample points into a smooth curve for display. Occasionally, the extreme points, (which have

much lower or higher voltage than the other points), may not be reached by the connected curve, due to smoothing.

3-151. Cursors, Voltage, and Time Measurements

3-152. The 5180A will calculate voltage and time differences between displayed points on a single waveform or on two different waveforms. Placing a single cursor on a displayed waveform allows measurement of voltage at the cursor, or time between the cursor and the trigger point of the displayed memory record. A second cursor, CURSOR Δ , may be used when time and voltage measurements are needed between two selected points. Refer to paragraph 3-11 for examples and Table 3-11 for operating procedures.

Table 3-11. Using Cursors, Voltage, and Time Measurements

FUNCTION	ACTION	INDICATION
NOTE		
Refer to the detailed descriptions of key functions, paragraph 3-78.		
Provide a square cursor on the externally displayed waveform.	Press TRACE 1 or TRACE 2. Press CURSOR and turn DATA ENTRY knob.	Square cursor moves along displayed waveform.
Provide a cross-shaped cursor on the externally displayed waveform.	Press TRACE 1 or TRACE 2. Press CURSOR Δ , then turn the DATA ENTRY knob.	Cross-shaped cursor moves along displayed waveform.
Find voltage level of single cursor, or voltage difference between two cursors.	Press CURSOR VOLT.	Voltage shown on 5180A display.
Find elapsed time between trigger and cursor or between two cursors.	Press CURSOR TIME. For more resolution, press SHIFT and SCROLL.	Time shown on 5180A display. Three more digits added.
Turn off cursor.	Press SHIFT, then press CURSOR or CURSOR Δ .	Cursor off.

3-153. If the cursor has not been enabled, the 5180A treats the trigger point as the selected cursor location. When the trigger point is not on the display, the cursor position is assigned to halfway across the display. The cursor position is associated with its location on the display. Once this position has been selected, it does not "move" with the waveform. If a new zoom window is desired, the position of the waveform must be changed.

3-154. PROGRAMMING

3-155. The 5180A is fully compatible with the Hewlett-Packard Interface Bus (HP-IB). This capability allows the instrument to respond to remote control instructions and output the results to external devices. The 5180A can be set in the TALK ONLY mode to furnish an output format suitable for a plotter or for a printer as described in paragraph 3-85 under ADDRESS switches. A desktop controller, such as the HP 9825 can be used to remotely program the front panel functions of the 5180A for output to an external display.

NOTE

HP-IB is Hewlett-Packard's implementation of IEEE Standard 488-1978, "Standard Digital Interface for Programmable Instrumentation."

3-156. The programming capabilities of the 5180A are described in this section. The operator must be familiar with the controller selected, e.g., the 9825A, 9826A, 9830A, or 9835A/45A calculators, and with the capabilities of the HP-IB. The following HP manuals provide useful background information:

Programming Note. Introductory Operating Guide for the 5180A Waveform Recorder with the 9825 Desktop Computer.
HP Part No. 02-5952-7630.

Programming Note. Introductory Operating Guide for the 5180A Waveform Recorder with the HP 85 Personal Computer.
HP Part No. 02-5952-7633.

Condensed Description of the Hewlett-Packard Interface Bus
(59401-90030)

Abbreviated Description of the Hewlett-Packard Interface Bus
(5955-2903)

Model 5180A
Operation and Programming

Tutorial Description of the Hewlett-Packard Interface Bus
(59300-90007)
HP-IB Quick Reference (5955-2902)

3-157. Interface Function

3-158. The capability of an instrument connected to the HP-IB is specified by its interface functions. Using the terminology of the IEEE 488-1978 standard, the 5180A functions are listed in *Table 3-12*. The subset identifiers are also listed adjacent to the HP-IB connector on the rear panel (*Figure 3-28*).

Table 3-12. 5180A HP-IB Interface Capability

Interface Function Subset Identifier	Interface Function Description
SH1	Complete source handshake capability.
AH1	Complete acceptor handshake capability.
T5	Talker (basic talker, serial poll, talk only mode, will unaddress talk if addressed to listen).
L3	Listener (basic listener, has listen only mode, will unaddress listen if addressed to talk).
SR1	Service request capability.
RL1	Complete remote/local capability.
PP0	No parallel poll capability.
DC1	Device clear capability.
DT1	Device trigger capability.
C0	No controller capability.
E1	One unit load on bus, open collector drivers.

3-159. The number following the interface function code in *Table 3-12* indicates the particular capability of that function as listed in Appendix C of IEEE Standard 488-1978, and described briefly in *Table 3-12*.

3-160. Bus Messages

3-161. Messages are the means by which devices exchange control and measurement information. There are 12 basic messages which can be sent over the interface bus. *Table 3-13* lists each bus message, a description of 5180A usage, and examples of 9825A implementation.

Table 3-13. Bus Messages

MESSAGES	DESCRIPTION	9825 EXAMPLE (5180A SET TO ADDRESS 04)	MESSAGES	DESCRIPTION	9825 EXAMPLE (5180A SET TO ADDRESS 04)
Data	Sends measurement data. Refer to HP-IB command descriptions, paragraph 3-165.	red 704, A wrt 704, "SA1"	Status Byte	The status byte message summarizes the state of the 5180A. The bits are defined as follows: NOTE All references to the HP-IB bits are coded B1 through B8. All other bit references internal to the 5180A are coded B0 through B7 as is normal. B1 = Error. Read error code by sending "0E": 1 = Error condition. Set when error occurs. 0 = No error. Set when "0E" command received. B2 = Output key has been pressed: 1 = Output pending. Set when key pressed and not in XY recorder mode. 0 = No output pending. Set when "0P" command is received. B3 = Measurement complete: 1 = Measurement complete. Set at end of measurement. 0 = Measurement not complete. Set when output scheduled or when new measurement started. B4 = Measuring: 1 = Measurement in progress. 0 = No measurement in progress. B5 = Busy/Ready: 1 = Busy. Set when measurement is in progress or when HP-IB command received. 0 = Ready. Set when measurement is complete and no other commands are pending. B6 = Abnormal: 1 = Abnormal condition. Set when error pending. 0 = Normal. B7 = Service requested: 1 = 5180A caused SRQ. Set when B1 thru B4 are set and the corresponding mask bit is set or B5 changes from 1 to 0 and mask is set. 0 = No Service requested. Set when status byte has been read. B8 = Reserved for service. Not normally set.	
Trigger	Causes the 5180A to arm. Same as SA4 command.	trg 704	Status Bit	No response.	
Clear	Causes an abort of the current measurement and a reset of some internal functions. CLEAR causes the DATA ENTRY knob to be disconnected as if the HOLD key was pressed. It flushes any input buffers, so that any partially decoded HP-IB commands are cleared. CLEAR also causes any HP-IB output to stop and the output buffer to be cleared. CLEAR sets the number-of-errors register to zero.	clr 704	Pass Control	Not generated.	
Remote	Causes the 5180A to disable all front panel keys except the UNLOCK/LOCAL key (which is used to return to the local state). The current state of the instrument is preserved, however, any changes to the current state must be made using the remote programming commands.	rem 704	Abort	Clears all interface functions. No other effect.	cli 7
Local	Causes the 5180A to re-enable the front panel control. The state of the instrument is preserved.	lcl 704			
Local Lockout	Disables the LOCAL key on the front panel. Thus, if the instrument is placed in the remote state, the LOCAL key will not operate to re-enable the front panel.	llo 7			
Clear Lockout/Local	Combines the response to the LOCAL command with the re-enabling of the LOCAL key.	lcl 7			
Require Service	Used to indicate that an event has occurred within the 5180A that requires the attention of the controller. The events that cause the REQUIRE SERVICE messages to be sent are controllable with the SR command. The following bits are defined in the SR mask: B1=Enable SRQ on error B2=Enable SRQ on output key B3=Enable SRQ on measurement complete B4=Enable SRQ on measurement in progress B5=0 B6=0 B7=0	wrt 704, "SR31" (enables all causes of SRQ) wrt 704, "SR0" (disables all causes of SRQ)			

3-162. Address Selection

3-163. To use the 5180A on the HP-IB, set the rear panel ADDRESS switches as shown in *Table 3-14*. The ADDRESSABLE mode is used whenever a calculator or other controller is used with the system. The TALK ONLY mode is used when the 5180A is operating under its own control (no controller on bus) and outputs its results to another device on the bus, such as a plotter (50) or a printer (51). In TALK ONLY, the receiving device must have LISTEN ONLY capability.

3-164. After setting the ADDRESS switches to one of the ADDRESSABLE positions, cycle the power (LINE) switch or press BUS ADDR key on the front panel CONTROL section to set the address. This action is required whenever the switch setting is changed. The switch setting will be displayed momentarily on the main display, read by the microprocessor and set into memory.

Table 3-14. Address Selection

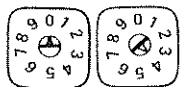
ADDRESS (Rear Panel)  (Shown to select Address 04)			
SELECTED ADDRESS	ASCII CODE CHARACTER		ADDRESS USAGE MODE
	LISTEN	TALK	
00	SP	@	ADDRESSABLE
01	!	A	ADDRESSABLE
02	"	B	ADDRESSABLE
03	#	C	ADDRESSABLE
04	\$	D	ADDRESSABLE
05	%	E	ADDRESSABLE
06	&	F	ADDRESSABLE
07	'	G	ADDRESSABLE
08	(H	ADDRESSABLE
09)	I	ADDRESSABLE
10	*	J	ADDRESSABLE
11	+	K	ADDRESSABLE
12	,	L	ADDRESSABLE
13	-	M	ADDRESSABLE
14	.	N	ADDRESSABLE
15	/	O	ADDRESSABLE
16	0	P	ADDRESSABLE
17	1	Q	ADDRESSABLE
18	2	R	ADDRESSABLE
19	3	S	ADDRESSABLE
20	4	T	ADDRESSABLE
21	5	U	ADDRESSABLE
22	6	V	ADDRESSABLE
23	7	W	ADDRESSABLE
24	8	X	ADDRESSABLE
25	9	Y	ADDRESSABLE
26	:	Z	ADDRESSABLE
27	;		ADDRESSABLE
28	<	/	ADDRESSABLE
29	=	}	ADDRESSABLE
30	>	~	ADDRESSABLE
†50	N/A	Talk only:	7225A, 7245A, 9872B/S plotters; no paging.
†51	N/A	Talk only:	Printers and other tabular outputs, e.g., 2631A
†52	N/A	Talk only:	7245A, 9872S plotters with paging
90-99	N/A	Service Mode	

NOTE
 †Note: Assumes the CRT/PLOT switch on 5180A rear panel is set for CRT. Otherwise, all three addresses attempt output to XY plotter.

3-165. HP-IB COMMANDS

3-166. HP-IB commands are described in detail in paragraph 3-168 through 3-180. Abbreviated descriptions are shown in *Table 3-15* for quick reference. There are three general types of HP-IB commands, as follows:

- a. AAd COMMANDS. This type of command controls the selection of "one of N" type functions. An example of a "one of N" function is the channel selection as shown in paragraph 3-168. This type of command has the form AAd (two letters followed by a digit).
- b. AA COMMANDS. This type of command is an immediate execute command. It has the form, AA (simply two letters).
- c. AA<fpn> COMMANDS. This type of command is used to set any of the numeric registers in the 5180A. It has the form, AA<fpn> (two letters followed by a floating point number). The floating point number syntax is very broad and is as follows:

1. Mantissa:

<blanks> <sign> <blanks> <zeros> <digits>
<extra digits> <blanks>

where:

<blanks> = spaces: all spaces are ignored

<sign> = +, blank, or omitted for positive, - for negative

<zeros> = leading zeros: leading zeros between sign and first nonzero character <or decimal point> are ignored.

NOTE

A zero without a sign makes the number positive.

<digits> = 0-9: up to 7 digits will be accepted (maximum number 7999999).

<extradigits> = 0-9: all digits after seventh received are ignored.

<. > = decimal point: only one decimal point is allowed, imbedded or in front or back of number.

2. Exponent:

E <blanks> <sign> <zeros> <digits> <blanks>

where: first letter must be "E" or "e"

<sign>: same as Mantissa

<blanks>: same as Mantissa

<zeros>: zeros between sign and first nonzero digit are ignored.

NOTE

First zero without sign makes sign plus.

<digits> = 0-9: only one or two digits allowed.

3. Delimiter: all floating point numbers must be followed by a delimiter. Acceptable delimiters are: comma, semicolon, carriage return, and linefeed.

3-167. Each time a floating point number is sent to the 5180A, its corresponding mnemonic must precede it. The following are a few examples of HP-IB commands using the 9825A calculator. (The 5180A will accept its commands in either upper or lower case letters.):

wrt "5180", "prsa1" Preset 5180A and set SINGLE
wrt "5180", "lp50" Set trigger level to +50%
wrt "5180", "lp50, pp-50" Set trigger level to +50% and position to -50%.

NOTE

Comma is needed if more than one number is needed per line. Normally the <CRLF> at the end of the line is sufficient.

wrt "5180", "lp", T Another way to set trigger level. Uses T as a variable containing the desired level.

wrt "5180", "lp", T, "pp", P Another way to set trigger. Where T is a variable containing trigger level and P is a variable containing trigger position. (Note that the comma before PP is a delimiter for the trigger level. The delimiter for position is the <CRLF> at the end of the line.)

<fixed>. The number format required for the input of data to the high speed memory is a little more restrictive. The formatter for high-speed number input will only recognize the fixed point input. (See paragraph 3-184, commands JB and JS.) It will not handle exponential notation. The syntax for fixed point number input is:

<blanks> <sign> <digits> <.> <ignored characters> <delimiter>

where,

The input range is 0 to 1023.

<blanks> leading blanks are ignored.

<sign> plus signs are ignored, minus signs force zero result.

<digits> all digits up to the decimal point or delimiter are used. Any overflow is treated modulo 1024.

<.> decimal point is optional.

<ignored characters> all characters after decimal point are ignored.

<delimiter> comma, semi-colon, **<carriage return>** and **<linefeed>** are valid delimiters.

NOTE

HP-IB commands are described in detail in the following paragraphs. For a quick reference to abbreviated code set descriptions of these commands, refer to *Table 3-14*. The order of listing program commands is important. Some functions depend upon the settings of other functions. For example, RECORD LENGTH will affect the trigger position percentage, so it should be set first. The following command list is in order of front panel controls, left to right. The OA command example, paragraph 3-184, shows the proper order of commands.

3-168. Channel Select Commands

CH1 Select Channel A (automatically set with preset command).

CH2 Select Channel B.

CH3 Select Channel A,B.

CH4 Select AUX (auxiliary).

CH5 Select Channel A and ground the input.

CH6 Select Channel B and ground the input.

CH7 Select Channel A and connect the input to 100 mV.

CH8 Select Channel B and connect the input to 100 mV.

AR<f>n> Select Channel A range. This command is used to set the Channel A range from .1-volt to 10-volt full scale (in a 1-2-5 sequence). The number will be rounded to the nearest allowable value. (AR10 is set automatically using the preset command).

NOTE

The voltages are specified as nominal full scale and not as per division.

User Units: Volts

Minimum value: .1 Volt

Maximum value: 10 Volts

Examples: ar10.0 (Channel A 10 Volts range)

ar1e-1 (Channel A .1 Volts range)

ar.1 (Channel A .1 Volts range)

AO<f>n> Select Channel A offset. This command is used to set the offset to the range of \pm full scale. (AO0 is set automatically using the preset command). The offset is specified in volts, and has a resolution of $\pm 1\%$.

User Units: Volts

Minimum Value: -full scale Volts

Maximum Value: +full scale Volts

Example: ao0 (0.0 Volts Offset — No Offset)

ao1.5 (1.5 Volts Offset)

ao-.5 (-.5 Volts Offset)

AC0 Select Channel A coupling. AC0 selects DC coupling. (AC0 is set automatically using the preset command).

AC1 Select Channel A coupling. AC1 selects AC coupling.

BR<f>n> Select Channel B range. (Same as Channel A)

BO<f>n> Select Channel B offset. (Same as Channel A)

BC0 Select Channel B coupling to DC.

BC1 Select Channel B coupling to AC.

3-169. Sweep Arming Commands

SA1 Select Single Sweep. Unlike the SINGLE pushbutton, this command does not arm the 5180A. To arm the instrument, the SA4 or the Group Execute Trigger (GET) command should be used.

SA2 Select Auto Sweep. SA2 is set automatically using the preset command.

SA3 Select Normal Sweep.

SA4 Arm the 5180A. Same as the GET addressed command.

3-170. Trigger Position Commands

PP<fpn> Set position as a percentage of memory. This number is converted to an integer number of memory clock cycles. If the value is positive then the data captured will be X% of the current block length past the trigger. If the value is negative, then the trigger is X% of the current block length past the start of the data. Percentage is computed in terms of integral number of samples using main and delayed time-per-sample.

User Units: % of current memory block length
Minimum value: -100% (trigger at right edge of XYZ display)
Maximum value: 9999% or % equivalent to maximum time defined in the following step, whichever is smaller.

PA<fpn> Set position in absolute memory locations. The trigger position is specified as the number of memory clock cycles that will be before or after the trigger. If the value is positive, then X clock cycles will elapse before storage data begins. If the value is negative, then there will be X clock cycles between the start of stored data and the trigger.

User Units: internal units (clock cycles)
Minimum value: - (current block length in words -3)
Maximum value: 2^{20} - (current block length) -3

PT<fpn> Set position in number of seconds. The value specified is quantized to an integral multiple of the current sample rate (TIME/SAMPLE). This ensures that there will be an integral number of memory clock cycles specified. If the value is positive, then the 5180A will wait the specified time following the trigger, before the data is captured. If the

value is negative, then the data will start the specified time before the trigger.

User Units: Seconds
Minimum value: - (current block length -3) * (main time per point)
Maximum value: 9999 seconds or $[2^{20} - (\text{current block length} - 3) * (\text{main time per point})]$, whichever is smaller.

AD<fpn> Set the ARM DELAY in seconds. ARM DELAY is variable in 250 ms steps from 0.005 to 99 seconds.

User Units: Seconds
Minimum value: 5 ms, 0.18 s, 0.25 s
Maximum value: 99

3-171. Trigger Level and Source Commands

SE0 Set trigger source to internal. SE0 is set automatically by PRESET command.

SE1 Set trigger source to external.

LP<fpn> Set trigger level as a percentage of full scale. The internal trigger uses a digital comparator connected to the ADC output. The external trigger uses an 8-bit DAC and an analog comparator connected to the external trigger input. The full scale value used for percentage depends on the channel selected. Channels A and B vary from 0.1 volt to 10 volts, times -1.024, 1.022 full scale depending upon the range selection. Channel AUX (auxiliary) is always -1.024, 1.022 full scale. The external trigger range is -2.56, +2.54 volts, full scale.

User Units: % full scale
Minimum value: -99%
Maximum value: +99%

LV<fpn> Set trigger level as a voltage. The allowed voltage range varies depending on the channel selection. Minimum and maximum values are specified in the table below:

User Units: Volts	Channel A and B	Auxiliary	External
Minimum value: (-RANGE setting)	-1.024	-1.024	-2.56
Maximum value: (+RANGE setting)	+1.022V	+1.022V	+2.54V

LA<fpn> Set trigger level as absolute. When using internal trigger, the range of values is that of the ADC, 0-1023 (512 = 0 volts). When using external trigger, only the most significant 8 bits are used, since the external trigger has only an 8-bit DAC. Thus, the legal codes are: 0, 4, 8, 12, 16, etc., with 512 = 0 volts.

User Units: Internal units, 10-bit integer
 Minimum value: 0
 Maximum value: 1023

SL0 Set trigger slope so that the instrument responds to a rising edge. (SL0 is set automatically by the PRESET command).

SL1 Set trigger slope so that the instrument responds to a falling edge.

SL2 Set trigger slope so that the instrument responds to either a rising or a falling edge (Bi-Trigger). This command is only legal in internal trigger. In external trigger the operation of the command will be like SL0.

MT Cause a manual trigger (immediate execute).

HP<fpn> Set trigger hysteresis as a percentage of full scale. Trigger hysteresis is programmable for internal trigger only. External trigger has a fixed hysteresis of 100 mV. The hysteresis is set up so that the trigger level specified is the actual point where the triggering will occur. This means that the hysteresis area is below the trigger point when the slope is positive.

User Units: % full scale
 Minimum value: 0
 Maximum value: 100%

HV<fpn> Set trigger hysteresis as a voltage. Trigger hysteresis is programmable for internal trigger only. External trigger has a fixed hysteresis of 100 mV, nominal.

User Units: Volts
 Minimum value: 0 (no hysteresis)
 Maximum value: full scale volts

HA<fpn> Set trigger hysteresis as absolute (0-511 counts).

User Units: Internal units 0-511
 Minimum value: 0
 Maximum value: 511

3-172. Timebase Control Commands

MM<fpn> Set (m)ain timebase in seconds per sa(m)ple. The timebase sampling rates are quantized in a 1-2-5 sequence. The 5180A will choose the actual sample rate nearest the value programmed from the HP-IB. If the 5180A is in EXTERNAL TIME BASE, then the divide ratio for that external timebase may be programmed by assuming the external frequency to be 20 MHz.

User Units: seconds (per sample)
 Minimum value: 50e-9 (50ns)
 Maximum value: 50e-3 (50ms)

MW<fpn> Set main timebase in seconds per s(w)eep.

User Units: seconds (per sweep)
 Minimum value: (50e-9)* (current block length)
 Maximum value: (50e-3)* (current block length)

DM<fpn> Set delayed timebase in seconds per sa(m)ple. Minimum and maximum values are the same as the main timebase.

DW<fpn> Set delayed timebase in seconds per s(w)eep. The minimum and maximum values are the same as the main timebase.

TB1 Set timebase to MAIN ONLY. TB1 is set automatically by the PRESET command.

TB2 Set timebase to mixed.

TB3 Set timebase to toggle.

TE0 Select internal 20 MHz timebase.

TE1 Select external 1-20 MHz timebase.

3-173. Data Entry Commands

HO Hold. Disconnect DATA ENTRY knob from display.

3-174. Set-Up Commands**AU** AUTOSET.**PR** PRESET.**SW<fpn>** Set the 5180A to save the state of the instrument into the SAVE LOCATION represented by <fpn>.**SX** Save the state of the instrument in the previously specified SAVE LOCATION.**RW<fpn>** Set the 5180A to recall the state of the instrument from the RECALL LOCATION represented by <fpn>.**RX** Recall the state of the instrument from the previously specified RECALL LOCATION.**3-175. Memory Commands****LE<fpn>** Set memory block length. LE1024 is set automatically by the PRESET command. The block length must be an integral power of two. Changing the block length may destroy pointers to previously recorded data in the high-speed memory. This would make it impossible to accurately reconstruct data for cursor measurements. It is not possible to have different size blocks of data stored in the memory at the same time. The minimum size block is dependent on the maximum allowable number of blocks (32). Also see block location (LO) for interaction between memory block length and the number of blocks available.

User Units: Number of samples

Minimum value: 512.

Maximum value: 16384.

LO<fpn> Set memory block location. LO1 is set automatically by the PRESET command. The block location specifies which block of memory is to be recorded into when the 5180A is next armed. The 5180A is automatically set to SINGLE sweep and NOT ARMED when the record block location command is received.

User Units: Record block location

Minimum value: 1

Maximum value: 32 (determined by block size)

AA0 Set no auto advance. AA0 is set automatically by the PRESET command.**AA1** Set auto advance. When next armed, the 5180A will advance to end of memory.**3-176. Vertical Commands****GA<fpn>** Set vertical gain.**OF<fpn>** Set vertical offset.**VF** Set vertical display to fixed.**3-177. Horizontal Commands****ZO<fpn>** Set horizontal zoom.**PO<fpn>** Set horizontal position.**HF** Set horizontal display to fixed.**3-178. Measure Commands****CT0** Disable cursor time (or volts) display.**CT1** Display cursor time.**CV0** Disable cursor volts (or time) display.**CV1** Display cursor volts.**TT0** Disable trigger time display.**TT1** Enable trigger time display.**TT2** Reset trigger time to 0.

3-179. Miscellaneous Display Commands**DO** DOT mode.**LN** LINE mode.**ST** SELF TEST.**SI** Single trace display.**DU** Dual trace display.**AN1** Analysis mode display (TR1-TR2).**TR1** Select trace 1.**TR2** Select trace 2.**CD<fpn>** Set cursor Δ position 0-1023.**CU<fpn>** Set cursor position 0-1023.**MC0** Turn cursor off.**MC1** Turn cursor on.**DC0** Turn cursor Δ off.**DC1** Turn cursor Δ on.**CL0** Disable calibrate of CRT.**CL1** Calibrate CRT.

TL<fpn> Set trace location for XYZ. TL1 is set automatically by the PRESET command. The trace location command has the same restrictions as the record location. It is used to set the display to view a particular memory block.

NOTE

The TRACE LOCATION for Trace 1 is changed to correspond to the RECORD LOCATION anytime the RECORD LOCATION is changed. In addition, if TRACE LOC 1 points to a chop mode record, then the 5180A assumes dual trace and chop mode.

SP<fpn> Set speed for XY recorder output, 100 ms to 400 ms in 50 ms increments.

EN1 Enable the XYZ display.

***EN0** Disable the XYZ display.

*This command allows minimum arm delay to be selected as 10ms, without using AUTO ADVANCE mode.

3-180. HP-IB Control Commands

SR<fpn> Service request enable mask. The mask is an 8-bit quantity with mask bits to select the Service Request function to respond to certain events. An SR0 command disables the Service Request function. Valid numbers for the SR command are in the range of 0 to 31, as follows:

B0=Enable SRQ on error codes

B1=Enable SRQ on output key pressed (signals to controller that the user wants to output).

B2=Enable SRQ on measurement complete.

B3=Enable SRQ on measurement in progress.

B4=Enable SRQ on change from BUSY to READY.

B5=0

B6=0

B7=0

3-181. Input/Output Control Commands

3-182. Data blocks can be written from a 9825A Desktop Computer or other controller into the 5180A data memory. The data can be formatted ASCII or binary. Only one record block may be written into at any one time. The block number is specified as part of the HP-IB command. The block number used in the command does not have to match the current 5180A record block number or trace block number. Once the 5180A receives the data input command, it expects to receive enough data to fill up the current record block length, or the number of points specified in the partial block command.

3-183. Data blocks can be read from the 5180A into a 9825A or other controller in either binary or formatted ASCII. The block number is specified as part of the HP-IB command. Again, the block number in the command does not have to match the current 5180A record block number or trace block number. Once the 5180A receives the data output command, it tries to output all of the samples in the specified block.

Model 5180A
Operation and Programming

3-184. The following commands are used for input/output control:

OB<block no.> Output a block. The 5180A is set to output a block of data. OB has one parameter, the record location of the required data. The 5180A will output a number of points equal to the current RECORD LENGTH.

OS<block no.>, <addr>, <num> Output selective address and number of words. This command sets the 5180A to output a selective number of words starting in the record location selected, offset by ADDR. NUM specifies the number of 10-bit words to be transferred using 4-byte ASCII numbers followed by a <CRLF>.

Example: wtb "5180", "OS1, 512, 1" will output one point at address 512 in location 1.

```
ADDR + NUM <= current RECORD LENGTH
0 <= ADDR < RECORD LENGTH
= 1 <= NUM <= RECORD LENGTH
```

OP Output a plot. Causes the strings necessary to output a plot to an HP 9872B, 7245, or 7225 plotter to be sent. The plot terminates using the EIO message. In this way, the controller may check that the plot is complete. The plot generated is a duplicate of that shown on the XYZ display. The last 4 records output are:

```
1b5180A WAVEFORM RECORDER <crLf>
pa2355, 812 <crLf>
df <crLf>
sp0 <crLf> <with EOI>
```

TEACH/LEARN COMMANDS

The following commands (OI, OT, OX, OM, OC, and OA) are teach/learn outputs that allow a controller to learn the programming setups of the 5180A. These output the current settings of the 5180A in ASCII form. This is the same form that is used to program the 5180A. Thus, these strings may be read from the 5180A into a string variable, and then turned around and sent to the 5180A to program it. Some of these strings are more than 80 characters long. The long strings send only one <CRLF> at the end of the string. This is different than the format seen in "talk only" tabular output, where a <CRLF> is sent at the end of each line.

The order of sending these strings is important. The OM string should be sent to the 5180A first, followed by the OX string, followed by OI, OT, and OC. **The OE and OG are for information only and contain no programming information.** The OA command outputs all programming information in one string. The order it outputs information is the same as that required for programming. The OI, OT, OX, and OA commands require one parameter. The parameter is the record location of the data wanted. In this case, if the data desired is associated with recorded data, use that record location. If the current setup is desired, use zero as the parameter.

OI<fpn> Output the input amplifier settings for record location specified. This is one of many learn mode commands. This causes the 5180A to send its current or recorded front end configuration commands to the listener. An example output is:

```
ch1, ar10.0E00, ao000.0E-03, ac0, br10.0E00, bo000.0E-03, bc0
```

OT<fpn> Output the sweep, trigger position, and trigger level settings. This is the second of the learn mode commands. An example of the output is:

```
sa2, pt-25.6E-06, ad190.0E-03, se0, s10000.0E-03, hv160.0E-03,
```

OX Output the time base settings. The third of the learn mode commands. No record location specification is necessary. This outputs current information. An example of the output is:

```
mm 50.00E-09, dm50.00E-09, tb1, te0
```

OM Output the memory settings. The fourth of the learn mode commands. It causes the memory block length and location to be output. An example of the output is:

```
lo, 1, le1024
```

OG Output the general display. The fifth of the learn mode commands. This causes the contents of the large display to be sent. This is the command used to retrieve miscellaneous measurement data. An example of the output is:

```
d1 000.000E-03, d2000.00E-03, d3 000.000E-03, d4000.00E, d5 2.77670E 03,
d6000.000E-03,
```

where:

```
d1 = Cursor Time
d2 = Cursor Volts
d3 = Delta Cursor Time
d4 = Delta Cursor Volts
d5 = Trigger Time TRACE 1
d6 = Trigger Time TRACE 2
```

OC Output the XYZ settings. This is the sixth learn mode command. Includes cursors. No record specification is necessary. An example of the output is:

```
In,si,cd 512, dc0, cu 1512,mc0,tr2, tl 2,ga10.24E 00,of 000.0E-03,zo1024,
po 0,tr1,tl 1,ga10.24E-00,of 000.0E-03,zo1024,po 0,
(si can be replaced by du-- for dual trace, or an1- for tr1-tr2).
```

OE Output the error code. The last error code is output in the format "ERROR xx.yy", where xx represents the major error type, and yy represents the suberror (usually the U-number of a bad IC). If there is no error, then xx and yy will both be zero. Following the error code is the number of errors received since the last OE or device clear command. An example of the output is:

```
Er00.00, 0 ERRORS
```

OA<fpn> Output all settings. This is the last mode command. It is a combination of the previous learn mode commands. All output here is acceptable as programming input, but the OG and OE commands are not included. Only one <CRLF> is sent at the end of the string. Allow a maximum of 325 characters.

```
1e 1024,lo 1,ch1,ar10.03 00,ao 000.0E-03, ac0, br10.0E 00,bo000.E-03,bc0,
mm 50.0E-09,dm 50.0E-09,tb1, te0,sa2, pt-25.6E-06,ad 190.E-03,se0,s10,
1v 000.0E-03,hv160.0E-03, ln,si,cd 512,dc0,cu 512,mc0,tr2, tl 2,ga10.24E 00,
of 000.0E-03,zo 1024,po 0,tr1,tl 1,ga10.24E 00,of 000.0E-03,zo 1024, po 0
```

BB<block no.> Binary output of block. Send a complete block of data back in binary using two bytes per 10-bit word. The format of the two bytes are as follows:

```
First byte: [0 0 0 D9 D8 D7 D6 D5]
Second byte: [D4 D3 D2 D1 0 0 0 ]
```

BS<block no.>, <addr>, <num> Binary output of selective address and number of words. This is a binary version of the OS command.

NOTE

Data input commands are in two forms. The first form inputs the entire memory block. The second form inputs only a portion of the block. There is one major difference between the two types of commands. The commands that input the entire block also copy the current measurement parameters into the memory. This allows a user to input setup information first, and then data into the memory. This is the technique used when restoring data to the 5180A that was previously recorded. You write the teach/learn strings followed by the data. If this is sent back to the 5180A, then the 5180A will be in the same state as when the data was recorded. The cursors will show the correct data.

The partial input commands do not effect the measurement parameters. This allows the user to modify a few points in a record without effecting anything else.

IB<block no.> Input binary block. Transfer one block of data, specified by BLOCK, from the controller to the 5180A. The BLOCK is sent to the 5180A as a floating point number <fpn>. Data sent to the 5180A is in binary form with the 10 bits in two bytes. See the example given for the BB command.

When using this command, make sure that no extraneous <CRLF>'s are sent. For example, use wtb "5180", "IB1," using the comma or semicolon delimiter. This is because the controller usually sends both carriage return and linefeed following a normal ASCII write. The carriage return would be interpreted as the delimiter, and the linefeed would be interpreted as the first byte of data. The number of input data words must be equal to the current RECORD LENGTH. EOI may be used as an end of record flag. If it is used, it must be sent with the last data byte.

IS<block no.>, <addr>, <num> Input binary selective. Transfer less than one block from the controller to the 5180A. This command works like the IB command except that it is used to send partial blocks of data. Again, the comma or semicolon must be used for the last delimiter. An example command is as follows:

wtb "5180", "IS1,5,500,"

ADDR - NUM <= current RECORD LENGTH

0 <= ADDR < RECORD LENGTH-1

1 <= NUM <= RECORD LENGTH

EOI may be used the same way as in the IB command.

JB<block no.> Input block in ASCII. Transfer ASCII records from the controller to the 5180A. All ASCII data must meet the syntax requirements for <fixed>. See paragraph 3-166. The number of data entries sent must match the current RECORD LENGTH.

JS<block no.>, <addr>, <num> Input selective ASCII. Transfer ASCII records from the controller to the 5180A. ASCII data must meet syntax requirements for <fixed>. JS is used to enter a selective number of words into the high-speed memory starting at the RECORD LOCATION selected by BLOCK, offset by ADDR. NUM specifies the number of entries to be sent.

ADDR + NUM <= current RECORD LENGTH

0 <= ADDR < RECORD LENGTH-1

1 <= NUM <= RECORD LENGTH

Table 3-15. Summary of HP-IB Commands

FUNCTION	COMMAND	RANGE OF FUNCTION VALUES
CHANNEL SELECT		
Channel A	CH1	
Channel B	CH2	
Channel AB Chop Mode	CH3	
Auxiliary Channel	CH4	
Channel A Input Grounded	GH5	
Channel B Input Grounded	CH6	
Channel A with 100 mV Calibration Signal	CH7	
Channel B with 100 mV Calibration Signal	CH8	
RANGE, OFFSET, AND COUPLING SELECT (For Channels A and B)		
Select Channel A Range	AR<fpn>	.1 to 10 (1-2-5 intervals)
Select Channel B Range	BR<fpn>	.1 to 10 (1-2-5 intervals)
Select Channel A Offset	AO<fpn>	± Full Scale Volts (Increment = .1% of FSR)
Select Channel B Offset	BO<fpn>	± Full Scale Volts (Increment = .1% of FSR)
Select Channel A Coupling DC	AC0	
Select Channel A Coupling AC	AC1	
Select Channel B Coupling DC	BC0	
Select Channel B Coupling AC	BC1	
SWEEP ARMING FOR TRIGGER		
*Select Single Sweep Mode	SA1	
Select Automatic Sweep Mode	SA2	
Select Normal Sweep Mode	SA3	
Arm 5180A for Triggering	SA4	

*Does Not Arm 5180A Sweep for Triggering.

Model 5180A
Operation and Programming

FUNCTION	COMMAND	RANGE OF FUNCTION VALUES
ARM DELAY		
Select Arm Delay for Sweep Mode	AD<fpn>	5 ms, 180 ms, 0.25 to 99 seconds (Increment = 250 ms)
TRIGGER POSITION SELECT		
Specify Trigger Position as Percentage of Memory	PP<fpn>	-100% to 9999%
Specify Position as Absolute Memory Location	PA<fpn>	- (record length - 3) (2 ²⁰ - record length)
Specify Position in Seconds	PT<fpn>	- (record length) (time/sample) to (2 ²⁰ - record length - 3) (time/sample)
TRIGGER SOURCE SELECT		
Internal Triggering	SE0	
External Triggering	SE1	
TRIGGER SLOPE SELECT		
Trigger on Rising Slope	SL0	
Trigger on Falling Slope	SL1	
Bidirectional Triggering	SL2	
TRIGGER LEVEL SELECT		
Specify Trigger Level as Percentage of Full-Scale Voltage	LP<fpn>	-99% to 99% (Increment = 1%)
Specify Trigger Level as Voltage	LV<fpn>	± Full Scale Voltage (Increment = .1% of FSR)
Specify Absolute Trigger Level	LA<fpn>	0 to 1023
TRIGGER HYSTERESIS SELECT		
Specify Hysteresis as Percentage of Full-Scale Voltage	HP<fpn>	0% to 100% (Increment = 1%)
Specify Hysteresis as Voltage	HV<fpn>	0 to + Full-Scale (Increment = .2% Maximum Voltage)
Specify Absolute Hysteresis	HA<fpn>	0 to 511

Table 3-15. Summary of HP-IB Commands (Continued)

FUNCTION	COMMAND	RANGE OF FUNCTION VALUES	FUNCTION	COMMAND	RANGE OF FUNCTION VALUES
MANUAL TRIGGER			DISPLAY CONTROLS		
TIME BASE SELECT			Specify Memory Location Placed into Trace	TL<fpn>	1 to 32
Set Main Time Base in Seconds/Sample Point	MM<fpn>	50 ns to 50 ms	Select Trace 1	TR1	
Set Main Time Base in Seconds/Portion of Sweep	MW<fpn>	(50 ns) (record length) to (50 ms) (record length)	Select Trace 2	TR2	
Set Delay Time Base in Seconds/Sample Point	DM<fpn>	50 ns to 50 ms	Single Trace Display (Trace 1 only)	SI	
Set Delay Time Base in Seconds/Portion of Sweep	DW<fpn>	(50 ns) (record length) to (50 ms) (record length)	Dual Trace Display	DU	
TIME BASE MODE SELECT			TR1-TR2	AN1	
Select Main Only Time Base Mode	TB1		Display in Line Mode	LN	
Select Mixed Time Base Mode	TB2		Display in Dot Mode	DO	
Select Toggle Time Base Mode	TB3		Set Vertical Display to Fixed	VF	
INTERNAL OR EXTERNAL TIME BASE			Set Horizontal Display to Fixed	HF	
Select Internal 20 MHz Time Base	TE0		Select Vertical Offset	OF<fpn>	Vertical Voltage Offset from Center
Select External Time Base (between 1 and 20 MHz)	TE1		Select Horizontal Position	PO<fpn>	Number of Sample Points Between Beginning of Memory Record and Left Edge of Display.
MEMORY SEGMENTATION/AUTO ADVANCE			Select Vertical Gain	GA<fpn>	Half of Voltage Range Displayed
Specify Memory Record Length	LE<dpn>	256 to 8192 for 8K Memory (512 to 16384 for 16K Memory)	Select Horizontal Zoom	ZO<fpn>	Total Sample Points Across Display
Specify Memory Record Location Number	LO<fpn>	1 to 32	CURSORS		
Auto Advance ON	AA1		Select Cursor Position	CU<fpn>	0 to 1023
Auto Advance OFF	AA0		Select Cursor Δ Position	CD<fpn>	0 to 1023
			Display Cursor Volts	CV1	
			Disable Cursor Volts Display	CV0	
			Display Cursor Time	CT1	
			Disable Cursor Time Display	CT0	

Table 3-15. Summary of HP-IB Commands (Continued)

FUNCTION	COMMAND	RANGE OF FUNCTION VALUES	FUNCTION	COMMAND	RANGE OF FUNCTION VALUES
PRESET, AUTOSET, RECALL SETUP			INPUT CONTROL		
Preset	PR		Input ASCII Record	JB<fpn>	Record Number
Autoset	AU		Input ASCII, Select Start Address and Number of Words	JS<fpn> <fpn> <fpn>	Record Number Address Number of Words
Select Save Location for Front Panel Setup	SW<fpn>	Location 1 to 4	Input Binary Record	IB	Record Number
Save 5180A Setup	SX		Input Binary, Select Start Address and Number of Words	IS<fpn> <fpn> <fpn>	Record Number Address Number of Words
Select Recall Location for Front Panel Setup	RW<fpn>	Location 1 to 5	LEARN MODE COMMANDS		
Recall 5180A Setup	RX				Approximate No. of Bytes
GENERAL CONTROLS			Send Input Amplifier Settings	OI<fpn>	80
Disconnect Data Entry Knob (DEK) from Display (HOLD)	HO		Send Sweep, Trigger Position and Level Settings	OT<fpn>	80
Self-Test 5180A	ST		Send Time Base Settings	OX<fpn>	80
Calibrate CRT	CL1		Send Memory Block Length and Location	OM<fpn>	40
Finish Calibrate of CRT	CL0		Send Contents of Display	OG	80
Enable Trigger Time Display	TT1		Send XYZ Settings, Including Cursors	OC	80
Disable Trigger Time Display	TT0		Send Last Error Code	OE	80
Reset Trigger Time to Zero	TT2		Send All Settings	OA<fpn>	325
OUTPUT CONTROL					
Output ASCII Record	OB<fpn>	Record Number			
Output ASCII, Select Start Address and Number of Words	OS<fpn> <fpn> <fpn>	Record Number Address Number of Words			
Output Binary Record	BB<fpn>	Record Number			
Output Binary, Select Start Address and Number of Words	BS<fpn> <fpn> <fpn>	Record Number Address Number of Words			
Output Plot	OP				
Speed Control for XY Recorder Output	SP<fpn>	100 to 400 ms (Increment = 50 ms)			

3-185. Service Request Function

3-186. Events which may be selected to initiate a 5180A Service Request are shown in *Table 3-16*. The service request mask is a 3-bit quantity, and may have any value between 0 and 31. Thus, one or more of the events listed in the table may be selected simultaneously, by summing the bit values, and the occurrence of any selected event will initiate a service request. For example, to obtain a service request when either an error occurs or a measurement is completed, the bit values 1 and 4 should be summed. In this case, the service request command should be "SR5". The command "SR0" disables the service request function.

Table 3-16. Service Request Events

Bit Enabled	Events
B0	Enable SRQ on Error (Bit Value = 1)
B1	Enable SRQ on Output Key (Bit Value = 2)
B2	Enable SRQ on Measurement Complete (Bit Value = 4)
B3	Enable SRQ on Measurement in Progress
B4	Enable SRQ on Change from Busy to Ready

3-187. Additional HP-IB Features

3-188. The 5180A provides several functions to increase user convenience during HP-IB operation. One of these features is a display of the instrument's current HP-IB address, which may be obtained by pressing front panel key BUS ADDR.

3-189. Several HP-IB output modes may be controlled from the front panel of the 5180A, depending on the instrument's current HP-IB address and the setting of the CRT/PLOT switch on the rear panel. If the CRT/PLOT switch is set for CRT and the 5180A is assigned a TALK ONLY HP-IB address (addresses 50-52), the 5180A provides digital output format as follows:

Address 50: HPGL output to 7225A, 9872B plotters without page advance capability.

Address 51: Digital output to printers and other tabular output devices, such as 2631A.

Address 52: HPGL output to 7245A, 9872 plotters with page advance capability.

3-190. When the CRT/PLOT switch is set for PLOT, the 5180A provides an analog output format suitable for X-Y recorders. Since these recorders often do not operate at high speeds, the 5180A's maximum output speed may be controlled from the instrument's front panel. The user may specify a minimum time delay between plotting of two sample points, from 100 to 400 ms, in 50 ms increments.

3-191. HP-IB EXAMPLES

3-192. The following are a few short 9825A program examples using the HP-IB data input and output. These are typical examples showing possible ways of communicating with the 5180A:

EXAMPLES

PROGRAM 1: REMOTE, PRESET, LOCAL LOCKOUT, AND LOCAL

```

0: rem 704;dsp "REMOTE";stp
1: wrt 704,"PR";dsp "PRESET";stp
2: llo 7;dsp "LOCAL LOCKOUT";stp
3: lcl 704;dsp "LOCAL";stp
4: lcl 7;dsp "LOCAL KEY ENABLED";stp
5: rem 704;stp
*6376

```

PROGRAM 2: SELECT CHANNEL AND RANGE

```

0: din X#[10]
1: ent "Select CH A,B,AB,orAU?",X#;cap(>#)+X#
2: if X#="A";wrt 704,"CH1";eto 6
3: if X#="B";wrt 704,"CH2";eto 8
4: if X#="AU";wrt 704,"CH4";dsp "CH AU, Range=1v";stp
5: if X#="AB";wrt 704,"CH3"
6: ent "CH A Range=? .1,.2,..5,1,2,5,or10v",A
7: wrt 704,"AR",A;if X#="A";stp
8: ent "CH B Range=? .1,.2,..5,1,2,5,or10v",B
9: wrt 704,"BR",B;stp
*14451

```

PROGRAM 3: SELECT RECORD LENGTH

```

0: wrt 704,"PR";dsp "Record Length=1024 words";stp
1: wrt 704,"LE8192"
2: dsp "Record Length=8192 words";stp
3: 16384+R;ent "Record Length=?";R
4: wrt 704,"LE";R
5: int(log(R)/log(2))+N;2↑N+S;if R>=2↑(N-1)+2↑N;2↑(N+1)+S
6: dsp "Record Length=",S," words";stp
*16314

```

PROGRAM 4: SELECT TRIGGER POSITION

```

0: dim A#[10]
1: ent "Trigger Position? Percent, Absolute, or Time",A#;cap(A#)+A#
2: if A#[1,1]="P";goto 6
3: if A#[1,1]="A";goto 8
4: if A#[1,1]="T";goto 10
5: dsp "Error in Selecting Trigger Position";beep;goto 1;stp
6: ent "What is trigger position in percent?";X
7: wrt 704,"PP",X;stp
8: ent "What is trigger position in absolute locations?";Y
9: wrt 704,"PA",Y;stp
10: ent "What is trigger position in time(sec)?";Z
11: fmt 1,e
12: wrt 704,1,"PT",Z;stp
*32481

```

PROGRAM 5: USE OF CURSORS, GAIN, AND OFFSET

```

0: wrt 704,"PR,AR1"
1: wrt 704,"MM1e-6"
2: ent "Set cursor position:0 to 1023";C
3: wrt 704,"CU",C
4: ent "Set delta cursor position:0 to 1023";D
5: wrt 704,"CD",D
6: wrt 704,"CV1"
7: dsp "5180A displays cursor voltage difference";stp
8: wrt 704,"CT1"
9: dsp "5180A displays cursor time difference";stp
10: ent "Set vertical gain";G
11: wrt 704,"GA",G
12: ent "Set vertical offset";F
13: wrt 704,"OF",F;stp
*10473

```

PROGRAM 6a: USING SERVICE REQUESTS AND STATUS BYTE

```

0: dim A#[80];0+X
1: cli 7
2: clr 704
3: wrt 704,"PR,SA1"
4: oni 7,"SRQ"
5: eir 7
6: wrt 704,"XX"
7: if X=0;dsp "waiting for SRQ";ato +0
8: end
9: "SRQ":rds(704)+A;prt A
10: if bit(6,A)=1;prt "5180A requests service";ato +2
11: prt "5180A did not cause SRQ";ato +4
12: if bit(0,A)=1;prt "Error condition";wrt 704,"OE";red 704,A;prt A#
13: if bit(2,A)=1;prt "Meas. complete"
14: 1+X;eir 7;iret
*7593

```

PROGRAM 6b: USE OF SERVICE REQUEST MASK

```

0: cli 7
1: clr 704
2: oni 7,"SRQ"
3: eir 7
4: wrt 704,"PR,MM5e-6,AR2,SA1"
5: wrt 704,"SR4"
6: wrt 704,"SA4"
7: 0+X
8: dsp "Input a signal at channel A"
9: if X=0;ato -1
10: prt "SRQ received"
11: end
12: "SRQ":rds(704)+B;prt B
13: if bit("1XX",B);prt "Measurement complete"
14: 1+X
15: eir 7;iret
*19853

```

PROGRAM 7a: WRITING DATA INTO THE 5180A

```
0: fxd 0:rad
1: 2*pi*9.766e-4+F
2: dev "5180",704
3: wrt "5180","PR,SA1"
4: wrt "5180","JB1"
5: for J=0 to 1023
6: (sin(F*J)+1.024)/.002+V
7: wrt "5180",V
8: dsp "Writing data",J,V
9: next J
10: beep:dsp "End of writing data to 5180A"
11: end
*22812
```

PROGRAM 7b: READING DATA FROM THE 5180A

```
0: fxd 0:dim D[0:1023]
1: dev "5180",704
2: wrt "5180","OB1"
3: for J=0 to 1023
4: red "5180",D[J]
5: dsp "Reading data",J,D[J]
6: next J
7: beep:dsp "End of reading data from 5180A"
8: end
*23201
```

85-19-04

MANUAL UPDATING CHANGES

CHANGE DATE: November 8, 1984

```

* * * * * MANUAL IDENTIFICATION * * * * *
* * * * *
* * * * * MANUAL UPDATING COVERAGE * * * * *
* * * * *
* * * * * This supplement adapts your manual * * * * *
* * * * * to instruments with serial numbers * * * * *
* * * * * prefixed through 2442. * * * * *
* * * * *
* * * * * Manual Part No: 05180-90001 * * * * *
* * * * * Manual Microfiche: * * * * *
* * * * * Manual Print Date: January 1982 * * * * *

```

ABOUT THIS SUPPLEMENT

The information in this supplement is provided to correct manual errors and to adapt the manual to instruments containing changes after the manual print date.

Change and correction information in this supplement is itemized by page numbers corresponding to the original manual pages. The pages in this supplement are organized in numerical order by manual page number.

Manual updating supplements are revised as often as necessary to keep manuals as accurate as possible. Hewlett-Packard recommends that you periodically request the latest edition of this supplement. Free copies are available from all HP offices. When requesting copies quote the model number, print date, and part number listed at the top of this page.

HOW TO USE THIS SUPPLEMENT

- Insert this title page in front of the title page in your manual.
- Perform all changes specified for "All Serials", and all changes through the Series Prefix of your instrument or board.
- Insert any complete replacement pages provided into your manual in the proper location.

If your manual has been updated according to the last edition of this supplement, you need only perform those changes pertaining to the new series prefix. See List of Effective Pages on the reverse side of this page. New information affecting "All Serials" will be indicated by a "#" in front of the page number.



LIST OF EFFECTIVE PAGES

 * SERIAL PREFIX OR PAGES
 * SERIAL NUMBER *****

All Serials
 1-2, 1-3, 1-4, 2-1, 2-3, 2-6, 3-9, 3-21
 3-30, 3-37, 3-56, 3-63

2210A Does not affect Operating & Program Manual

2220A

2222A 1-2

2224A Firmware Revision changes from 1.2 to 1.3.
 X-Y speed changes from a minimum value of
 100 ms to 50 ms, affecting the following:
 1-3, 1-4, 2-7, 3-7, 3-22, 3-25, 3-29, 3-30
 3-31, 3-34, 3-40, 3-59

Instruments with the following serial
 numbers also have changes indicated for
 Series 2224.

2044A00102	2220A00282	2222A00304
00103	00287	00305
00106	00288	00306
00116	00294	00307
00119	00296	00308
00122		00309
		00310

Changes for Series 2230A thru 2318A do not
 affect the Operating & Programming Manual.

2230A
 2232A
 2238A
 2240A
 2250A
 2311A
 2318A

Serial Numbers 2324A00671 and above have six
 major new features that affect the operation
 of the 5180A. Some of the 5180A specific
 cations have changed, and the firmware
 revision changes from 1.3 to 1.4.

1-2, 1-3, 1-4, 1-5, 1-6, 2-3a/d, 2-7, 3-7
 3-9a, 3-12, 3-21, 3-28, 3-30, 3-31, 3-35,
 3-39, 3-40, 3-47, 3-48, 3-53, 3-56, 3-58,
 3-59, 3-59a/c, 3-60, 3-61, 3-61, 3-62a/b,
 3-63, 3-65, 3-66

2327A - 2442A
 Changes for Series 2327A thru 2434A do not
 affect the Operating & Programming Manual.

(51800PR) 2210A=13665, 13633/2220A=14180/2222A=14202, 13444, 15227, 13589, 13632/
 2224A=14416/2230A=13630, 13467/2232A=14427/2238A=14567/2240A=14552/2250A=
 14579, 13867, 14892, 14875/2250A=14555/2311A=14880, 14902/2318A=13631, 15025, 15041,
 15055/2324A=14873, 14878/2327A=15330/2329A=14603, 14908, 15069/2404=15752, 15774,
 15700/2408=15971/2414=15971/2426=16329/2434=16527

SERIAL PREFIX OR
SERIES NUMBER

CHANGES

Page 1-2, Table 1-1. Model 5180A Specifications:

All Serials >Delete "(20 Degrees C to 30 Degrees C)" reference in the title of the two tables labeled "Dynamic Performance3."

>Change the Arm Delay specification to read as follows:
Arm Delay: Selectable 0.18 s, 0.25 s to 99 seconds in 0.25 second increments. An arm delay of 7 ms is available in Auto Advance only. Controls time between measurements.

2222A

CHANNEL A AND B INPUTS:

>Change Amplifier Bandwidth to (-3dB NOMINAL).
>Change Input Impedance 1M ohm II <35pF (all other ranges) to 1M ohm 40pF (all other ranges).

2324A

>Change Input Impedance (NOMINAL) specifications to read as shown below:

1M ohm II 40 pF (10V range). 1M ohm II 35 pF (all other ranges).

>Add double asterisks (**) in the Dynamic Performance (20 degrees to 30 degrees) table, as shown below:

TEST	RANGE	Nominal Sine Wave Amplitude	Nominal Test Frequency 10 MHz
		2V p-p	<-52 dBc
DFT-spurious ⁴	+1V	0.2V p-p	<-60 dBc **
			<-48 dBc
			<-60 dBc

>Add footnote at the bottom page 1-2 as shown below:

**DFT spurious relative to 2V peak-to-peak test sine wave carrier.

>Change Arm Delay specifications to read as follows:
Arm Delay: Selectable 7 ms, 0.18 s, 0.25 s to 99 second increments. Controls the time between measurements.

SERIAL PREFIX OR
SERIES NUMBER

CHANGES

Page 1-3, Table 1-1. Model 5180A Specifications (Continued):

All Serials TIMEBASE: External timebase in (rear panel) second line:
>Change ratios of 1 to 1-6 to 1 to 10-6.

HIGH SPEED INPUT/OUTPUT (DMA rear panel connector):
>Add "When transferring data from the controller into the
5180A over DMA, an even number of samples is required."

22224A TIMEBASE: Sample Interval:
>Add Sample Interval Accuracy:
 Internal Reference Accuracy X Number of Samples X
 Sample Time.

2324A >Change in two places, under ANALOG OUTPUT MODES, "XY
Recorder" to read "Strip Chart and XY Recorders".
>Add under HEWLETT-PACKARD INTERFACE BUS, in Special
Functions specification", continuous plot." to the
first sentence.

Page 1-4, Table 1-1. Model 5180A Specifications:

All Serials **Power Requirements:**
>Change "Max Power dissipation 400 watts" to read "Max power
consumption is 500 VA".

2224A Available Display Cursors:
>Add Cursor Accuracy:
 Single Timebase: Equal to Sample Interval Accuracy.
 Mixed Timebase: For cursor measurements made across time-
 bases with MAIN or DELAY TIMEBASE set to
 50 ns, the measurement error is based upon
 the slower of the MAIN or DELAY sample
 time as follows:

(Single Timebase) + or - (Slower Sample Time +100 ns)
2324A >Add to end of paragraph describing Available Display
 Cursors, the following sentence:
 Cursor accuracy is equal to sample interval accuracy.

>Add the following to the first sentence in paragraph
entitled Auto Advance:
 " and halts a highest record location".
>Add, between Auto Advance and Trigger Time, the following:
 "Continuous Auto Advance: Cycles Auto Advance until
 operator halts procedure."

SERIAL PREFIX OR
SERIES NUMBER

CHANGES

Page 1-5. General Information:

- 2324A Paragraph 1-25:
- >Add "strip chart recorder" to the first sentence.

Page 1-6. General Information:

- 2324A >Add the following paragraph between paragraphs 1-33 and 1-34:

The 10875A (4.8 metres, 15.8 feet) and the 10875B (1 metre, 3.28 feet) are identical DMA cables (except for length) that provide an interface between the 5180A and 9826 controllers.

Page 2-1. Installation:

- All Serials Paragraph 2-11:
>Change "...less than 400 volt amperes" to read "no more than 500 volt amperes".

Page 2-3, Figure 2-2. Setup Switches, Normal Positions:

- All Serials >Replace the A11 Timebase Option Switch Setup with the following figure:
0 1

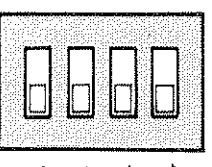

A11 TIMEBASE OPTION
SWITCH SETUP

- 2324A >Add pages 2-3a, 2-3b, 2-3c, 2-3d supplied in these manual changes.
- >Add after paragraph 2-26:

NOTE
Refer to pages 2-3a through 2-3d for SERIES 2324 Sweep-Plot Enhancements.



The following information is provided for your reference only. It is not intended to be used as a substitute for the original document. The information is provided as a service to our customers and is subject to change without notice.



This document is a reproduction of the original document. It is not intended to be used as a substitute for the original document. The information is provided as a service to our customers and is subject to change without notice.



Part of SERIES 2324 Enhancements

SWEEP-PLOT COMBINATION (HP-GL Paging Plotters)

Four combinations of Sweep followed by Plot are added to the 5180A functions. All four combinations require an HP-GL paging plotter such as the HP 7245A or HP 9872S. Each of the four new functions is activated by a selected setting of the HP-IB ADDRESS switch on the rear panel of the 5180A.

The four new functions are as follows:

1. Sweep followed by plot. In this function, the 5180A will plot and page after each sweep.
2. Plot all record locations in sequence. In this function, the 5180A will plot and page, in sequence, all the record locations from current to last.
3. Auto advance with plot and page mode. In this function, the 5180A performs a plot and page after each sweep in the Auto Advance mode.
4. Auto advance followed by plot records in sequence. In this function, the 5180A performs plot and page in sequence, after an Auto Advance, all record locations filled by the Auto Advance mode.

These four new functions do not modify the basic sweep or plot capability of the 5180A. The functions merely link the sweep and plot processes together in four different ways.

Sweep Followed by Plot

Set the HP-IB ADDRESS switch on the rear panel to 53, and press the OUTPUT key on the front panel to activate this mode. The 5180A will take a sweep, plot it and page the plotter. The sequence of sweep, then plot is repeated until the UNLOCK/LOCAL key is pressed. The user has control over the content of the

first plot record because a new sweep is taken after the OUTPUT key is pressed.

If the TRIGGER SWEEP ARM is set to SINGLE or NORM, the 5180A main display will show "nrEc" (wait next record) before each sweep, and will show "OutPut" during plotting. If the TRIGGER SWEEP ARM is set to AUTO, then only "OutPut" will be displayed. During the time that "nrEc" is displayed, the front panel is unlocked, and sweep setup changes such as RANGE, DELAY, etc., may be made before initiating the sweep with SINGLE, MANUAL TRIGGER, etc. While "OutPut" is displayed the front panel is locked. The content and format of the plot is identical to that obtained with a setting of 52 of the HP-IB ADDRESS switch. This mode may be aborted during plot or sweep activity by pressing UNLOCK/LOCAL.

If a trigger is not available when OUTPUT is pressed and the 5180A is in NORM SWEEP ARM TRIGGER mode, a trigger will be required. This trigger is required to allow the sweep measurement routine to complete its task before the Sweep Followed by Plot mode will be initiated. When it is, the cycle starts with a sweep.

Plot All Record Locations in Sequence

Set the HP-IB ADDRESS switch on the rear panel to 54 and press the OUTPUT key on the front panel to activate this mode. The 5180A will then plot and page each record in sequence, starting with current TRACE 1 LOCATION through the last TRACE 1 LOCATION. The content and format of the plot is identical to that obtained with a setting of 52 for the HP-IB ADDRESS switch. When the OUTPUT key is pressed, the TRIGGER SWEEP ARM mode is forced to SINGLE. Otherwise, the last record location may be overwritten with new sweep data at conclusion of the last record plot.

Plot All Records In Sequence (Cont'd)

This mode may be aborted during plot activity by pressing the UNLOCK/LOCAL key.

Auto Advance with Plot and Page Mode

Set the HP-IB ADDRESS switch on the rear panel to 55 and press SHIFT-AUTO ADVANCE. The 5180A will then perform the Auto Advance function in a normal manner, with a plot after each sweep. During Auto Advance activity, "Auto n" appears in the main display and the PANEL LOCK light is off. During plot activity, "Output" appears in the main display, and the PANEL LOCK light is on. At the conclusion of the last plot, "LAST" appears in the main display. The content and format of the plot is identical to that obtained with a setting of 52 for the HP-IB ADDRESS switch. This mode may be aborted during plot or Auto (sweep) activity by pressing the UNLOCK/LOCAL key. When SHIFT-AUTO ADVANCE is pressed, bit 1 of the SRQ status byte is set (Enable SRQ on OUTPUT key). If the HP-IB ADDRESS switch does not read 55 or 56 when SHIFT-AUTO ADVANCE is pressed, the main display will show Er 12.XX. The xx will be the value obtained from the HP-IB ADDRESS switch. As with other error conditions the SHIFT key must be pressed to allow the 5180A to continue. If the TRIGGER ARM DELAY is set to 5 ms, when SHIFT-AUTO ADVANCE is pressed, the entire sequence of records is taken in the Auto Advance mode before plotting starts. In this case, only the last RECORD LOCATION is plotted.

Auto Advance Followed by Plot Records in Sequence

Set the HP-IB ADDRESS switch on the rear panel to 56 and press SHIFT-AUTO ADVANCE. The 5180A will then perform the Auto Advance function in a normal manner with the front panel PANEL LOCK light off. The main display shows the normal Auto Advance sequence of "Auto n", "Auto n+1", etc. Then the PANEL LOCK light comes on, "Output" appears in the main display, and all records taken in during the Auto Sequence acti-

vity are plotted in sequence on the paging plotter. The first record location plotted is the first one recorded by the Auto Advance activity. At the conclusion of plot activity, "LAST" appears in the main display. This mode may be aborted during plot or AUTO (sweep) activity by pressing the UNLOCK/LOCAL key. When SHIFT-AUTO ADVANCE is pressed, bit 1 of the SRQ status byte is set (Enable SRQ on OUTPUT key). If the ADDRESS switch does not read 55 or 56 when SHIFT-AUTO ADVANCE is pressed, the main display will show Er 12.xx. The xx will be the value obtained from the HP-IB ADDRESS switch setting. Press the SHIFT key to release the error condition.

Error Code Summary

If SHIFT-AUTO ADVANCE is pressed and the HP-IB ADDRESS switch is not set to 55 or 56, the error code 12.xx will show in the main display. The xx will be the value obtained from the HP-IB ADDRESS switch setting.

SWEEP-PLOT COMBINATIONS (Strip Chart Recorders)

To provide for continuous plotting of the data recorded by the 5180A onto a strip chart recorder, five combinations of sweep and plot functions identical to those available for the HP-GL plotters are implemented. The data will have the same vertical gain and offset as what the CRT displays.

Chop mode will be displayed as two consecutive plots with Channel A followed by Channel B. DUAL TRACE displays will only plot trace 1. However, by setting HP-IB address to 54, multiple records can be plotted. Record separation is by a gap at the end of each record.

To engage the strip chart mode of output, the PLOT/CRT switch at the back of the 5180A must be set to PLOT. The HP-IB ADDRESS switch at the rear panel

SWEEP-PLOT COMBINATIONS (Strip Chart Recorders)

must be to set the appropriate address, (52, 53, 54, 55, or 56) depending on the combination of sweep and plot desired. The 5180A will acknowledge the strip chart recording request by displaying "StrIP". If an output plot is requested, but the HP-IB address is not any of the strip chart codes, then the 5180A will display "rCdr" and do a single xy-recorder plot.

The following combinations of sweep and strip chart plot are available:

1. Strip Chart Plot Once

When the HP-IB address switch on 5180A rear panel is set to 52, and the CRT/PLOT switch is set to PLOT, the Sweep-Plot once mode is enabled. To activate this mode, simply press OUTPUT. The 5180A will take previously recorded data and plot it onto the strip chart recorder.

2. Sweep Followed by Strip Chart Plot

When the HP-IB address switch on the 5180A rear panel is set to address 53 and the CRT/PLOT switch is set to PLOT, the sweep-strip chart record mode is enabled. To activate this mode, simply press the OUTPUT key. The 5180A will take a sweep, do a strip chart record sequentially until the UNLOCK/LOCAL button is pressed. This provides the user with control over the content of the first record. If the Trigger Sweep Arm mode is set to AUTO, then only "StrIP" will be displayed. During the time that "nrEc" is on display, the 5180A front panel is unlocked, and sweep setup changes such as range, delay, etc. may be before initiating the sweep with SINGLE, MANUAL TRIGGER, etc. While "StrIP" is displayed, the front panel is locked.

If the OUTPUT key is pressed when the 5180A is in the NORM Trigger Sweep Arm mode and no trigger is

available, a trigger is required to allow the sweep measurement routine to complete its task before the sweep followed by plot' mode will be initiated. When it is, the cycle starts with a sweep.

3. Plot all Record Locations in Sequence

When the HP-IB ADDRESS switch on the 5180A rear panel is set to address 54, and the CRT/PLOT switch is set to PLOT, the plot-in-sequence mode is enabled, starting with the current TRACE 1 LOCATION. This mode is activated by pressing the OUTPUT key. The 5180A will then plot each record in sequence through the last TRACE LOCATION. When the OUTPUT key is pressed, the Trigger Sweep Arm mode is forced to SINGLE. Otherwise, one record location may be overwritten with new sweep data at the conclusion of the last record plot.

4. Auto Advance with Plot Mode

When the HP-IB ADDRESS switch on the 5180A rear panel is set to address 55, the CRT/PLOT switch is set to PLOT, the Auto Advance with Plot and Page mode is enabled. To activate this mode, press SHIFT-AUTO ADVANCE. The 5180A performs the Auto Advance function in a normal manner with a plot after each sweep. During Auto Advance activity, "Auto n" appears in the main display, and the PANEL LOCK light is off. During Plot activity, StrIP' appears in the main display, and PANEL LOCK light is on. At the conclusion of the last plot, LAST' appears in the main display. When SHIFT-AUTO ADVANCE is pressed, bit 1 of the SRQ status byte is set (Enable SRQ on OUTPUT key). If the HP-IB ADDRESS switch does not read 55 or 56 when SHIFT-AUTO ADVANCE is pressed, the main display will show "Er 12.xx" until the UNLOCK/LOCAL key is pressed. the xx' will be the value obtained from the HP-IB ADDRESS switch. If

4. Auto Advance With Plot Mode (Cont'd):

Trigger ARM DELAY is set to 7 ms, when SHIFT-AUTO ADVANCE is pressed, the entire sequence of records is taken in the AUTO ADVANCE mode before plotting begins. In this case, only the last TRACE LOCATION is plotted.

5. Auto Advance Followed by Plot Records in Sequence

When the HP-IB ADDRESS switch on the 5180A rear panel is set to address 56, and the CRT/PLOT is set to PLOT, the Auto Advance followed by Plot in Sequence mode is enabled. To initiate this mode, press SHIFT-AUTO ADVANCE. The 5180A performs the Auto Advance activity in normal fashion with the 5180A front panel PANEL LOCK light off. The large display shows the normal Auto Advance sequence of "Auto n", "Auto n+1", etc. Then the PANEL LOCK light is turned on, "Strip" appears in the large display, and all records taken in during the Auto Sequence activity are plotted in sequence. The first RECORD LOCATION plotted is the first one recorded by the Auto Advance activity. At the conclusion of Plot activity, "LAST" appears in the main display. This mode is abortable during Plot or AUTO (sweep) activity by pressing the UNLOCK/LOCAL key. When SHIFT-AUTO ADVANCE is pressed, bit 1 of SRQ status byte is set (enable SRQ on OUTPUT key). If the HP-IB address switch does not read 55 or 56 when SHIFT-AUTO ADVANCE is pressed, the large display will show "Er 12.xx" until the UNLOCK/LOCAL key is pressed. The xx' will be the value obtained from the HP-IB ADDRESS switch.

SERIAL PREFIX OR
SERIES NUMBER

CHANGES

Page 2-6, Figure 2-3. 10873 Rack Mount Contents:

All Serials >Change part number of Item #8 from 2570-0194 to
2510-0194.

Page 2-7. Installation:

2224 Paragraph 2-39:
>Change "100" to "50".

2324 Paragraph 2-37:
>Change the last sentence from "(Addresses 50-52)" to
"(Addresses 50-56)".

>Add four address settings as shown below:

Address 53: HP-GL output that enables plot and page
after each Sweep. Used with 7245A and 9872S
paging plotters.

Address 54: HP-GL output that enables plot and page in
sequence all the record locations from
current to last. Used with 7245A and 9872S
paging plotters.

Address 55: HP-GL output that enables plot and page after
each sweep in the Auto Advance mode. Used
with 7245A and 9872S paging plotters.

Address 56: HP-GL output that enables plot and page in
sequence after an Auto Advance all the record
locations filled by the Auto Advance Mode.
Used with 7245A and 9872S paging plotters.

Paragraph 2-39:
>Change the first sentence to read "When the CRT/PLOT switch
is set for PLOT, addresses 52 thru 56 will operate Strip
Chart recorders. Any other valid addresses will operate
XY recorders."

>Change "100" to "150".
>Change "400" to "700".

Page 3-7. Operation and Programming:

2224A Paragraph 3-33:
>Add at the end of second sentence "...50 ns precision":
(see specifications under Cursor Accuracy in Table 1-1).

SERIAL PREFIX OR
SERIES NUMBER

CHANGES

Page 3-9. Auto Advance Mode:

All Serials >Change the last sentence to read as follows:
"... is variable from 7 ms to 99 seconds."

2324A

>Add page 3-9a.
>Add after paragraph 3-39:

NOTE

Refer to page 3-9a for SERIES 2324 Auto Advance Enhance.

Page 3-12. Operating and Programming:

2324

>Change, in the example program, statement "MP50e-9" to "MM 50e-9".
>Change in NOTE "(MP)" to "(MM)".

Page 3-21. Trigger Section:

All Serials

Arm Delay:

>Change in line 6, ARM DELAY values range from 7 ms.
>Change in line 11, IN AUTO ADVANCE, minimum time is 7 ms.
>Add after the NOTE:
When the 5180A front panel indicates an arm delay of 5 ms, the actual arm delay is 180 ms. When in Auto Advance, the actual arm delay is 7 ms.

2324

Arm Delay:

>Delete the last sentence "In AUTO ADVANCE, minimum time is 7ms".
>Add the sentence "Arm Delay of 7 ms prompts a special CRT display "Ad 7ms" in place of measurement data.

POSITION:

>Change "5" to "7" in last sentence.

Part of Series 2324 Enhancements

Auto Advance Continuous

AUTO ADVANCE CONTINUOUS differs from the current "regular" AUTO ADVANCE only in that the AUTO ADVANCE CONTINUOUS will keep sequencing measurements through memory records until there is an external command to terminate. Hence, this new front panel command allows capturing the last sweep in a number of measurements where it is not known when the last event will occur.

To engage AUTO ADVANCE CONTINUOUS, the AUTO ADVANCE pushbutton will be used. The first time pushed, regular AUTO ADVANCE is enabled (as before). The second time it is pushed AUTO ADVANCE CONTINUOUS is enabled, the SWEEP ARM is forced to SINGLE, and the message "AAc n" is displayed. As in regular AUTO ADVANCE, 'n' represents the number of the first RECORD LOCATION that will be used for the first measurement. If the button is pushed a third time all AUTO ADVANCE modes are turned off.

From HP-IB, the command "AA2" will be used to activate AUTO ADVANCE CONTINUOUS.

AUTO ADVANCE CONTINUOUS measurements will take place as in regular AUTO ADVANCE whereby measurements are sequenced from a given location to the next higher location, but when the last location is reached, the sequence will restart at record location 1 and continue to cycle indefinitely. During the measurement, the front panel displays the message "AAc n" where 'n' is the current measurement record location. When ARM DELAY is set to 7 msec only "AAc" will be displayed during the measurements. The word "LAST" will never be displayed.

Several front panel keys or HP-IB commands will abort AUTO ADVANCE CONTINUOUS mode. Abortion is indicated by the message "AA Abt" or by some new display replacing the "AAc n" message.

HPGL or STRIP CHART outputs (SHIFT, AUTO ADVANCE) will work with regular AUTO ADVANCE only. There is no output available with AUTO ADVANCE CONTINUOUS.

SERIAL PREFIX OR
SERIES NUMBER

CHANGES

Page 3-22. Trigger Section (Cont'd):

2224A >Insert the following NOTE between the paragraphs entitled
%FS and %HYS:

NOTE

The %FS range for the trigger is a function of both
input channel (CHA,CHB) range and INT/EXT trigger
source before setting the trigger level or hysteresis.

Page 3-25. Time Base Section:

2224A

TOGGLE:

>Change the first two sentences to read:

TOGGLE differs from MIXED only when position is negative.
In this mode, the MAIN timebase is used until the trigger
occurs.

>Change the next to last sentence to read:

The double-trigger cursor will also be visible when in
MIXED or TOGGLE with a positive trigger position.

Page 3-28. CAL/UNCAL:

2324

>Add to the end of the fifth sentence "(while in SWEEP ARM,
Single)."

Page 3-29. Control Section:

2224A

TR1-TR2.

>Add:

The TR1-TR2 (analysis) mode can be used for trace records
made during CHOP A,B mode only when TR1 equals TR2 (both
point to the same CHOP record). An attempt to activate
TR1-TR2 when TR1 is not equal to TR2 will result in
error code display Er15.00.

In TR1-TR2 (analysis) mode, to point from one CHOP to
another, in either local or remote control, change TR1
TRACE LOCATION. The TR2 TRACE LOCATION will track auto-
matically and error 15.00 should not occur.

SERIAL PREFIX OR
SERIES NUMBER

CHANGES

Page 3-30. Control Section:

All Serials

Auto Advance:

- >Change ARM DELAY is zero, to ARM DELAY is 7 ms, in line 15.
- >Change ARM DELAY is non-zero to ARM DELAY is >7 ms, in line 16.

2224A

Auto Advance:

>Add the following:

The AUTO ADVANCE key is a toggle function that sets the AUTO ADVANCE "on" (enable) or "off" (disable). When the key is pressed to the disable position, the main display will be:

AAXOFF (where x=blank)

The above display indicates AUTO ADVANCE "off" disabled. When AUTO ADVANCE is disabled as a result of aborting a measurement, the main display will be:

AAXAbt (where x=blank)

The above display indicates AUTO ADVANCE abort.

Page 3-30. Control Section

If AUTO ADVANCE is "off" (disabled) and the 5180A is making a sweep (a long sweep or waiting for a trigger) and the AUTO ADVANCE key is pressed to the "on" position (enabled) the following occurs:

- a. The sweep is terminated.
- b. TRIGGER SWEEP ARM mode is set to SINGLE.
- c. AUTO ADVANCE mode is enabled and the main display will be:

AUTO(n) (where=n=current RECORD LOCATION)

SERIAL PREFIX OR
SERIES NUMBER

CHANGES

Page 3-30. AUTO ADVANCE:

2324 >Add the following paragraphs as shown below:

The AUTO ADVANCE key is a toggle function that sets the AUTO ADVANCE "on" (enable) when pressed the first time. The second time it is pressed AUTO ADVANCE CONTINUOUS is enabled, the SWEEP ARM is forced to SINGLE, and the message "AAc n" is displayed. When the AUTO ADVANCE key is pressed a third time the AUTO ADVANCE modes are disabled; and, the main display will be:

AAxOFF (where x=blank)

The above display indicates AUTO ADVANCE "off" (disabled). When AUTO ADVANCE disabled as a result of aborting a measurement, the main display will be:

AAxAbt (where x=blank)

The above display indicates AUTO ADVANCE abort.

AUTO ADVANCE CONTINUOUS. AUTO ADVANCE CONTINUOUS Differs from regular AUTO ADVANCE only in that AUTO ADVANCE CONTINUOUS will keep sequencing measurements through memory records until there is an external command to terminate.

Page 3-31. X-Y SPEED:

2224 Paragraph entitled X-Y Speed:

>Change "100" to "50".

2324 >Change "100" to "150" and "400" to "700".

Page 3-34. Front Panel Annunciators.

All Serials >Delete paragraph entitled "CLD"; the CLD annunciator on the front panel is deactivated.

SERIAL PREFIX OR
SERIES NUMBER

CHANGES

Page 3-35. Front Panel Annunciators:

2324 Add to the Messages and Meaning listing the following:

Message	Meaning
AA Abt	The AUTO ADV function is aborted.
AA OFF	The AUTO ADV function is disabled.
AAC n	The AUTO ADV CONTINUOUS function is in progress (n represent number of record location).
FSO	The Fast Sweep/Output (DMA) is in progress.
nRE	Waiting for the next record's measurement in sweep plot.
Strip	The Strip Chart output is in progress.

NOTE

The operand 'n' represents the number of the record location.

Page 3-37. Rear Panel Controls and Connectors (cont'd):

All Serials

Level:

- >Change -1 volt to -1.2 volt.
- >Change +1.8 volt to +1.3 volt.

Page 3-39, Paragraph 3-100:

2324 Add descriptions to the following Error Categories, as shown below:

- 11 Fast Sweep Output Error
- 12 Shift-Auto Advance pushed and HP-IB address not 55 or 56.

SERIAL PREFIX OR
SERIES NUMBER

CHANGES

Page 3-40, Table 3-2. Error Messages:

2224A >Add Er15.00 TR1 not equal TR2 in CHOP records, TR1-TR2 mode.

2324 >Add the following as shown below:

DISPLAY	SPECIFIC ERROR CONDITIONS
Er11.01	"FM1" received in Auto Advance mode.
Er11.02	Return to local-FSO Aborted.
Er12.yy	Shift-Auto Advance pushed and HP-IB address not 55 or 56.

Page 3-47, Paragraph 3-129:

2324 >Add to the list of MEMORY CAPABILITIES:
d. Automatic advance continuous.
e. Trigger time recording.

Page 3-48, Paragraph 3-135:

2324 >Add the following two sentences as shown below:
Pressing SET ZERO will give negative trigger time until a valid trigger occurs. The negative time represents the time from the previous trigger to when SET ZERO is pressed.

Page 3-53. Table 3-14. Address Selection:

2324 >Change, in SELECTED ADDRESS column, "52" to "52-56".
>Change, under NOTE, the last sentence to read "PLOT would generate outputs for either X-Y or Strip Chart recorders."

SERIAL PREFIX OR
SERIES NUMBER

CHANGES

Page 3-56. Paragraph 3-169 Sweep Arming Commands:

All Serials

>Change AD<fpn> definition to read as follows:

Set the ARM DELAY in seconds. ARM DELAY is selectable to 1.8 s and .25 s to 99 seconds in .25 second increments. 7 ms available in AUTO ADVANCE mode.

>Change AD<fpn> Minimum value to:
0.18 s. In AUTO ADVANCE 7 ms.

2324

Paragraph 3-170:

>Change the AD<fpn> definition to read as follows:

Set the ARM DELAY in seconds. ARM DELAY is selectable to .7 ms, .18 s, and .25 s to 99 seconds in .25 second increments.

>Change Minimum value to 7ms.

Page 3-58. Paragraph 3-175:

2324

>Add the following HP-IB Memory Command and description as shown below:

AA2 Set Auto Advance Continuous. Cycles Auto Advance until operator halts procedure.

Page 3-59. Operation and Programming.

All Serials

SP<fpn>:

>Change "100" to "50".

2324 >Change, in description of SP<fpn>, "100" to "150"; and
"400" to "700".

>Add pages 3-59a, 3-59b, 3-59c.

>Add note after paragraph 3-183:

NOTE

Refer to pages 3-59a through 3-59c for SERIES 2324 enhancements.

Part of Series 2324 Enhancements

FAST SWEEP/OUTPUT MODE

The Fast Sweep/Output (FSO) mode is a Direct Memory Access (DMA) process that is faster than the standard 5180A DMA process (FAST 0). The FSO DMA operates in the output mode only. In this mode of operation the FSO continuously alternates the sweep of digitized waveforms with output through the DMA port to a controlling device at 5180A's fastest repetition rate. The FSO mode is controlled by the use of HP-IB commands, not by front panel controls.

The FSO mode is enabled or disabled by HP-IB commands whereas the standard DMA is controlled by a transfer request signal from the DMA device. The sequence of DMA control and data transfer is the same for each process.

10872A and 10875A/B Interface Cables

The 10872A Interface cable consists of a 90832A I/O interface with a special cable and is used with controllers such as the 9825. The 10875A or 10875B DMA cable is designed to connect the 5180A to controllers such as the 9826. The two cables (10875A and B) are identical except that the length of the 10875A is 4.8 metres (15.8 feet) and the 10875B is 1 metre (3.28 feet).

Control

The FSO mode is controlled by a DMA device that incorporates both HP-IB and DMA circuits. The basic sequence of operation is as follows:

1. Send Code "FM1" on the HP-IB to enable FSO.
2. Read the desired number of waveforms via 5180A DMA port.
3. Send code "FMO" on the HP-IB to disable FSO.

Front Panel Display

During FSO operation, the front panel main display on the 5180A will be FSO (For standard DMA operation, the display will be FAST I during input, and FAST 0 during output.) The ARM, TRG, and all other annunciators will function during FSO as usual.

Record Location

The currently active RECORD LOCATION will be used repeatedly for all waveforms digitized during FSO mode. No record advance will occur (as in AUTO ADVANCE mode).

FSO is usually interrupted and terminated by the "FMO" HP-IB command while in the process of making a sweep. The XYZ display will show part of the interrupted sweep and part of the previous complete sweep after "FMO" is received by the 5180A.

XYZ Control

For sweep times less than 1 second, the XYZ output is disabled. For sweep times greater than or equal to 1 second, the XYZ output is not disabled. UPDATE mode will be active unless the user has sent "ENO" via HP-IB. Normal XYZ output resumes at the conclusion of FSO mode, by executing "EN1" from within the 5180A when "FMO" is received. This means that any "ENO" the user had in effect is cancelled when "FMO" is sent via HP-IB. IF "ENO" is used, the user should wait until the HP-IB status byte indicates a change from "busy" to "ready". This ensures the 5180A has executed the XYZ image update task to process the "ENO" request. The HP 9825/9826 HPL code for this is:

```
wrt 704, "SA1,ENO"
if bit ("1xxxx",rds (704)); gto + 0
```

NOTE

"SA1" is required or the 5180A will remain busy continuously. The controller can reinstate "SA2" or "SA3" at the conclusion of the test, if required.

Auto Advance

If the AUTO ADVANCE mode is in effect when the 5180A receives the "FM1" code on the HP-IB, the AUTO ADVANCE mode will be terminated. FSO mode will not be initiated. The error code 11.01 will be displayed in the main display.

Sweep Arm

All sweep arm modes are allowed (SINGLE, AUTO, NORM). The SINGLE mode will function the same as the NORM mode. This is consistent with the nature of the FSO process which, in effect, keeps the measurement (sweep) process continuously active. Thus, the SINGLE mode acts as if the SINGLE key was pressed once each sweep/DMA cycle. As with the NORM mode, there must be a trigger from the input signal to have a sweep.

Arm Delay

The ARM DELAY function is allowed with some modifications. In the FSO process, ARM DELAY applies to the SINGLE sweep arm mode as well as to NORM and AUTO. Also, the ARM DELAY values of 7ms and 180ms are not used (treated as 0) by FSO. These two values each have special meaning in regular sweep process, but the nature of the FSO process is such that these special meanings do not apply. The ARM DELAY values are interpreted as including the FSO cycle (loop) time, but trigger level wait, sweep, TREQ wait, and DMA transfer times are additive.

Data Entry Control Knob (Rotary Pulse Generator)

The DATA ENTRY control (RPG) is deactivated by HP-IB code "FM1". This prevents interrupts associated with the RPG.

HP-IB Status Byte

The RECORDING status bit is set on (1) immediately prior to trigger enable, and off (0) at end of sweep. The MEASUREMENT COMPLETE status bit is set on (1) at end of sweep and off (0) after the controller activates TREQ in the 5180A (e.g. "eir 2,1"). This allows the controller to handshake with the 5180A if desired. The HP 9825/9826 HPL code to accomplish this handshake is as follows:

```

0->Y
oni 7,"srq"
eir 7
.
.
"h-shake":if Y=0;gto +0
"h-shake"2":0->Y
"start DMA xfer":rdi 4->A
eir 2,1
tfr 2,"adc",1024
.
.
"srq":rds (704)->A
if bit(2,A)=1;1>Y
eir 7;iret

```

Front Panel Operation

If the UNLOCK/LOCAL key on the front panel is used to return the 5180A to the LOCAL state, the FSO mode will terminate ("FMO" is simulated). Error code 11.02 will be displayed. This occurs also if the HP-IB is used to place the 5180A in the LOCAL state (e.g., "lcl 704"). The check for a panel status change to LOCAL occurs just after ARM DELAY is complete and before the sweep. The check is made once each sweep/DMA cycle.

Error Codes

Error codes that will be displayed during FSO mode are as follows:

Code	Error
11.01	AUTO ADVANCE mode in effect the HP-IB code FM1 is received by the 5180A.
11.02	5180A front panel placed in LOCAL state.

The following HP 9825/9826 HPL program sequence can be used to capture error information via HP-IB:

```

dim A$[80]
0->X
oni 7,"srq"
eir 7
wrt 704,"SR1"      enable error SRQ interrupts
.
.
wtc 2,0
wti 7,0            end of DMA input sequence
"DMAdone":gsb "ckerr"
if X->0;gto "end"
.
.
"srq":rds (704)->A
if bit (0,A)=1;1->X
eir 7;iret
.
.
"ckerr":if X=0;ret
wrt 704,"OE";red 704,A$
dsp A$;wait 3000;ret
.
.
"end";end

```

NOTE

The "srq" routine should not perform the sending of the OE and the reading of A\$, because the possibility exists that the srq interrupt occurred prior to label "DMAdone", while the controller and the 5180A are still in the DMA sequence. The 5180A is not available for HP-IB processing until the DMA sequence is complete.

ADDITIONAL HP-IB INPUT/OUTPUT COMMANDS

In order to conform with the IEEE Standard 728-1982, eight input/output HP-IB commands have been added to the program code set of the 5180A. Two of the input commands and two of the output commands are in two's complement binary format, and the same number of commands are in full binary format. Data are sent over the HP-IB in the following format:

```
#I[....data in bytes.....]
```

where the last byte of data is sent with an EOI.

In two's complement binary format, a 10-bit word is sent as follows:

```
First Byte: [ S S S S S S D9 D8 ]
```

```
Second Byte: [ D7 D6 D5 D4 D3 D2 D1 D0 ]
```

where S=extended sign
1=negative sign
0=positive sign

In full range binary format, a 10-bit word is sent in two sequential bytes as follows:

```
First Byte: [ 0 0 0 0 0 0 D9 D8 ]
```

```
Second Byte: [ D7 D6 D5 D4 D3 D2 D1 D0 ]
```



MANUAL CHANGES MODEL 5180A (05180-90001)

SERIAL PREFIX OR
SERIES NUMBER

CHANGES

Page 3-60. Operation and Programming:

2324 Paragraph OT<fnp>:
>Change the example output to read as follows:

sa2,pt-25.6E-06,ad180.0E-03,se0,s10,lv 000.0E-03,
hv160.0E-03,

>Change "OX" to "OX<fnp>".
>Delete the second and third sentences in paragraph
describing OX.

Paragraph OM:

>Add after the last sentence:

No record location specification is necessary. This
outputs current information.

Page 3-61. Operation and Programming:

2324

Paragraph OA<fnp>:
>Change "ad 190.E-03" to ad 180.E-03"; "s10" to "s10"; and
"lv 000.0E-03" to "lv 000.0E-03".

Page 3-62. Operation and Programming:

2324

>Add pages 3-62a and 3-62b.
>Add following paragraph 3-184:

NOTE
Refer to pages 3-62a and 3-62b for SERIES 2324
enhancements.

Page 3-63, Table 3-15. Summary of HP-IB Commands:

All Serials >Change the ARM DELAY to read as follows:

Select Arm Delay for AD<fnp> 180 ms, 0.25 to 99 seconds
Sweep Mode (Increment = 0.25 s)
7 ms available in AUTO
ADVANCE

2324

ARM DELAY:
>Change "5ms" to "7ms".



Part of Series 2324 Enhancements

An example of a line to transfer data from the 5180A:

```
wtb 704, "kb1," or wtb 704, "ks1,1,512,"
```

using the comma or semicolon as the delimiter. This is because the controller usually sends both the carriage return and linefeed following an ASCII write to the 5180A. The carriage return will be interpreted as the delimiter, and the linefeed will be interpreted as the first byte of data. Thus, at least one byte of data at the end of the block will be lost.

Partial block transfer is made possible by using selective commands. Two parameters must be specified in addition to the block number. They are the starting address (addr) and the number of points (num).

OUTPUT COMMANDS

The following are additional output commands:

SB<block no.> Two's complement binary format. Transfer a selective block of data from the 5180A to the controller. Data is sent as 16-bit, two's complement integers.

SS<block no.>,<addr>,<num> Two's complement binary format. Transfer a selected block of data from the 5180A to the controller. The parameters specify the block number, the selected address and the number of words.

UB<block no.> Full range binary format. Transfer a full block of data in the full range (i.e., $0 \leq \text{range} \leq 1023$) from the 5180A to the controller.

US<block no.>,<addr>,<num> Full range binary format. Transfer a partial block of data in the full range (i.e., $0 \leq \text{range} \leq 1023$) from the 5180A to the controller. The parameters to be specified are the block number, the selective address and the number of words.

An example of a line to transfer the 5180A to the controller:

```
wtb 704, "ub1," or wtb 704, "us1,1,512,"
```

using the delimiter as described under the input commands example.

PROGRAMMING EXAMPLES

The following are a few 9825 programs to illustrate possible applications using the new input and output commands.

Input Command Examples

Example #1

```
11: dsp "full range binary IEEE block input"
12: dim A[1024]; fxd 0
13: for I=1 to 1024
14: int(I)->A[I]      - WRITE A RAMP
15: next I
16: wtb 704,"kb1,"    -FOR 25 COMP INPUT, USE
                       "lb1,"
17: wtb 704,"#I"
18: for I=1 to 1024
19: dsp "full range binary write to 5180"
20: wtb 704, int(A[I]/256)
21: wtb 704, int(A[I])
22: next I
```

Example #2

```

11: dsp "full range binary IEEE selective
    input"
12: dim A[1024];fxd 0
13: for I=1 to 1024
14: int(I)->A[I]
15: next I
16: wtb 704, "ks1, 512, 512," -FOR 2'S COMP,
    USE "ls..."
17: wtb 704, "#I"
18: for I=1 to 512
19: wtb 704,int(A[I]/256
20: wtb 704,int(A[I])
21: next I

```

Output Command Examples

Example #1

```

11: dsp "full range binary IEEE block output"
12: wrt 704,"ub1," -FOR 2'S COMP, USE
    "sb1.."
13: rdb(704)->A;prt char(A) -READ "#" From 5180
14: rdb(704)->A;prt char(A) -READ "I" from 5180
15: for I=1 to 1024
16: rdb(704)*256+rdb(704)->A
17: dsp "ub",I,A
18: next I

```

Example #2

```

11: dsp "full range binary IEEE selective
    output"
12: wrt 704,"us1,256," -FOR TWO'S COMP, USE
    "ss..."
13: rdb(704)->A;prt char(A) -READ "#" FROM 5180
14: rdb(704)->A;prt char(A) -READ "I" FROM 5180
15: for I=1 TO 256
16: rdb(704)*256+rdb(704)->A
17: dsp "us",I,A
18: next I

```

HP-IB IDENTIFICATION COMMANDS

Two commands are added that will output information to identify that a 5180A is attached to the HP-IB.

The ID command will provide an ASCII string consisting of the Model Number, followed by the ROM revision code, and ending with carriage return/linefeed.

Example: 5180A ROM 1.4 <cr><lf>

The IE command will provide a single binary byte output equal to binary code for decimal 80:

01010000

INPUT COMMANDS

The following are additional input commands:

LB<block no.> Two's complement binary format. Send a complete block of data from the controller to the 5180A. The block is sent to the 5180A as a parameter. Data is sent as 16-bits, two's complement integers.

LS<block no.>,<addr>,<num> Two's complement binary format. Send less than one block of data from the controller to the 5180A. The parameters to be sent specify a selective address and the number of words.

KB<block no.> Full range binary format. Send one block of data in full range (i.e., $0 < \text{range} \leq 1023$) from the controller to the 5180A.

KS<block no.>,<addr>,<num> Full range binary format. Send a partial block of data (i.e., $0 < \text{range} \leq 1023$) from the controller to the 5180A. the parameters specify the block number, the selective address and the number of words.

SERIAL PREFIX OR
SERIES NUMBER

CHANGES

Page 3-65, Table 3-15. Summary of HP-IB Commands:

2324 OUTPUT CONTROL, Speed Control for XY Recorder Output:
>Change "100" to "150" and "400" to "700".

Page 3-66. Operation and Programming:

2324 Paragraph 3-189:
>Change "(addresses 50-52)" to read "(addresses 50-56)"
 in second sentence.
>Add four address settings as shown below:

Address 53: HPGL output that enables plot and page
after each sweep. Used with 7245A and 9872A
paging plotters.

Address 54: HPGL output that enables plot and page in
sequence all the record locations from current
to last. Used with 7245A and 9872S paging
plotters.

Address 55: HPGL output that enables plot and page
after each sweep in the Auto Advance mode. Used
with 7245A and 9872S paging plotters.

Address 56: HPGL output that enables plot and page in
sequence after an Auto Advance all the record
locations filled by the Auto Advance mode. Used
with 7245A and 9872S paging plotters.

Paragraph 3-190:
>Change "X-Y recorders" to read "X-Y and Strip Chart
Recorders" in the first sentence.
>Change "100" to "150" and "400" to "700" in the last
sentence.



The following information is provided for your reference only. It is not intended to be used as a substitute for the original document. The information is provided as a service to our customers and is subject to change without notice.

This document is a technical manual for the [Product Name]. It contains detailed information about the product's features, specifications, and operation. It is intended for use by qualified personnel only.

The information in this document is provided for your reference only. It is not intended to be used as a substitute for the original document. The information is provided as a service to our customers and is subject to change without notice.

This document is a technical manual for the [Product Name]. It contains detailed information about the product's features, specifications, and operation. It is intended for use by qualified personnel only.

The information in this document is provided for your reference only. It is not intended to be used as a substitute for the original document. The information is provided as a service to our customers and is subject to change without notice.

PARTIAL LISTING OF HEWLETT-PACKARD SALES AND SUPPORT OFFICES

United States of America. Please contact the sales office nearest you. The Regional Offices listed below will advise you of the address if you are uncertain.

EAST	WEST	MIDWEST	SOUTH
Hewlett-Packard Co. W120 Century Road PARAMUS, NJ 07652 Tel: (201) 265-5000	Hewlett-Packard Co. 5400 W. Rosecrans Boulevard LOS ANGELES, CA 90260 Tel: (213) 970-7500	Hewlett-Packard Co. 5201 Tollview Drive ROLLING MEADOWS, IL 60008 Tel: (312) 255-9800	Hewlett-Packard Co. P.O. Box 105005 2000 South Park Place ATLANTA, GA 30339 Tel: (404) 955-1500 Telex: 810-766-4890

Europe. If your country is not in the partial listing below, please contact our European Headquarters.

EUROPEAN AREAS NOT LISTED, CONTACT

Hewlett-Packard S.A.
7 Rue du Bois-du-Lan
CH-1217 MEYRIN 2, Switzerland
Tel: (022) 83-81-11
Telex: 27835 hpse
Cable: HEWPACKSA Geneve

DENMARK

Hewlett-Packard A/S
Datavej 52
DK-3460 BIRKEROD
Tel: (02) 81-66-40
Telex: 37409 hpas dk

FINLAND

Hewlett-Packard Oy
Revontulentie 7
SF-02100 ESPOO 10
Tel: (90) 455-0211
Telex: 121563 hewpa sf

FRANCE

Hewlett-Packard France
Zone d'activités de Courlaboeuf
Avenue des Tropiques
Boite Postale 6
F-91401 ORSAY Cédex
Tel: (1) 907-78-25
Telex: 600048F

GERMAN FEDERAL REPUBLIC

Hewlett-Packard GmbH
Vertriebszentrale Frankfurt
Berner Strasse 117
Postfach 560 140
D-6000 FRANKFURT 56
Tel: (0611) 50-04-1
Telex: 04 13249 hpffm d

GREAT BRITAIN

Hewlett-Packard Ltd.
King Street Lane
WINNERSH, Wokingham
Berkshire RG11 5AR
Tel: (0734) 784774
Telex: 847178

GREECE

Kostas Karayannis
8 Omirou Street
ATHENS 133
Tel: 32-30-303, 32-37-371
Telex: 21 59 62 RKAR GR
"Plaiso"

ITALY

Hewlett-Packard Italiana S.p.A.
Via G. Di Vittorio 9
I-20063 CERNUSCO SUL NAVLIGLIO
Tel: (2) 903691
Telex: 334632

NETHERLANDS

Hewlett-Packard Nederland B.V.
Van Heuven Goedhartlaan 121
NL 1181KK AMSTELVEEN
P.O. Box 667
NL 1080 AR AMSTELVEEN
Tel: (20) 47-20-21
Telex: 13 216

NORWAY

Hewlett-Packard Norge A/S
Oestendalen 18
P.O. Box 34
N-1345 OESTERAAS
Tel: (02) 17-11-80
Telex: 16621 hpnas n

SPAIN

Hewlett-Packard Española S.A.
Calle Jerez 3
E-MADRID 16
Tel: 458-2600
Telex: 23515 hpe

SWEDEN

Hewlett-Packard Sverige AB
Enighetsvägen 3, Fack
P.O. Box 20502
S-16120 BROMMA
Tel: (08) 730-0550
Telex: (854) 10721 MESSAGES
Cable: MEASUREMENTS
STOCKHOLM

In Other Countries. If your country is not in the partial listing given below, the address of the nearest office can be obtained from whichever of these three sources is most convenient to you: (1) The closest of the offices listed below. (2) European Headquarters listed above. (3) U.S. Headquarters listed below.

ARGENTINA

Hewlett-Packard Argentina S.A.
Avenida Santa Fe 2035
Martinez 1640 BUENOS AIRES
Tel: 798-5735, 792-1293
Telex: 122443 AR GIGY
Cable: HEWPACKARG

AUSTRALIA

Melbourne, Victoria Office
Hewlett-Packard Australia Pty.Ltd.
31-41 Joseph Street
BLACKBURN, Victoria 3130
Tel: 89-6351
Telex: 31-024
Cable: HEWPAKD Melbourne

BRAZIL

Hewlett-Packard do Brasil I.e.C.
Ltda.
Alameda Rio Negro, 750
ALPHAVILLE 06400 Barueri SP
Tel: 421-1311
Telex: 011 23602 HPBR-BR
Cable: HEWPACK Sao Paulo

CANADA

Hewlett-Packard (Canada) Ltd.
6877 Goreway Drive
MISSISSAUGA, Ontario L4V 1M8
Tel: (416) 678-9430
Telex: 610-492-4246

HONG KONG

Hewlett-Packard Hong Kong, Ltd.
G.P.O. Box 795
5th Floor, Sun Hung Kai Centre
30 Harbour Road
HONG KONG
Tel: 5-8323211
Telex: 66678 HEWPA HX
Cable: HP ASIA LTD Hong Kong

JAPAN

Yokogawa-Hewlett-Packard Ltd.
29-21 Takaido-Higashi 3-chome
Suginami-ku TOKYO 168
Tel: (03) 331-6111
Telex: 232-2024 YHPTOK

MEXICO

Hewlett-Packard Mexicana, S.A. de
C.V.
Avenida Periferico Sur No. 6501
Tepepan, Xochimilco
MEXICO CITY 23, D.F.
Tel: (905) 676-4600
Telex: 017-74-507

SINGAPORE

Hewlett-Packard Singapore (Ply.)
Ltd.
P.O. Box 58 Alexandra Post Office
SINGAPORE, 9115
6th Floor, Inchcape House
450-452 Alexandra Road
SINGAPORE 0511
Tel: 631788
Telex: HPSGSO RS 34209
Cable: HEWPACK, Singapore

U.S. Headquarters:

Hewlett-Packard Company, 1507 Page Mill Road, Palo Alto, California 94304, U.S.A.

Telephone: (415) 857-1501 • Telex: 910-373-1267 • Cable: HEWPACK

SOUTH AFRICA

Hewlett-Packard South Africa (Pty.)
Ltd.
Daphny Street
Private Bag Wendywood
SANDTON 2144
Tel: 802-5111, 802-5125
Telex: 89-84782
Cable: HEWPACK Johannesburg

TAIWAN

Hewlett-Packard Far East Ltd.
Taiwan Branch
5th Floor
205 Tun Hwa North Road
TAIPEI
Tel: (02) 751-0404
Cable: HEWPACK Taipei

VENEZUELA

Hewlett-Packard de Venezuela C.A.
Apartado 50933
3A Transversal Los Ruices Norte
Edificio Segre 2Y3
CARACAS 1071
Tel: 239-4133, 239-4777,
239-4244
Telex: 25146 HEWPACK
Cable: HEWPACK Caracas

