

T1 Tester

OPERATING AND CALIBRATION MANUAL

SERIAL NUMBERS

This manual applies directly to instruments with serial numbers prefixed 3126U and/or with firmware revision number 3127.

To check the firmware revision number of your instrument, press **AUX** and select **OPTIONS**.

© Copyright (1991), Hewlett-Packard Company.



HP Part No. 37701-90006
Microfiche Part No. 37701-90031
Printed in U.K. June 1991

WARNING

READ THE FOLLOWING NOTES BEFORE INSTALLING OR SERVICING ANY INSTRUMENT.

1. IF THIS INSTRUMENT IS TO BE ENERGIZED VIA AN AUTO-TRANSFORMER MAKE SURE THAT THE COMMON TERMINAL OF THE AUTO-TRANSFORMER IS CONNECTED TO THE NEUTRAL POLE OF THE POWER SOURCE.
2. THE INSTRUMENT MUST ONLY BE USED WITH THE MAINS CABLE PROVIDED. IF THIS IS NOT SUITABLE, CONTACT YOUR NEAREST HP SERVICE OFFICE. THE MAINS PLUG SHALL ONLY BE INSERTED IN A SOCKET OUTLET PROVIDED WITH A PROTECTIVE EARTH CONTACT. THE PROTECTIVE ACTION MUST NOT BE NEGATED BY THE USE OF AN EXTENSION CORD (POWER CABLE) WITHOUT A PROTECTIVE CONDUCTOR (GROUNDING). * BEFORE SWITCHING ON THIS INSTRUMENT:
 - a. Make sure the instrument input voltage selector is set to the voltage of the power source.
 - b. Ensure that all devices connected to this instrument are connected to the protective (earth) ground.
 - c. Ensure that the line power (mains) plug is connected to a three-conductor line power outlet that has a protective (earth) ground. (Grounding one conductor of a two-conductor outlet is not sufficient).
 - d. Check correct type and rating of the instrument fuse(s).

CERTIFICATION

Hewlett-Packard Company certifies that this product met its published specifications at the time of shipment from the factory. Hewlett-Packard further certifies that its calibration measurements are traceable to the United States National Bureau of Standards, to the extent allowed by the Bureau's calibration facility and to the calibration facilities or other International Standards Organization members.

ASSISTANCE

Product maintenance agreements and other customer assistance agreements are available for Hewlett-Packard products.

For any assistance, contact your Hewlett-Packard Sales and Service Office. Addresses are provided at the back of this manual.

NOTICE

The information contained in this document is subject to change without notice.

Hewlett-Packard shall not be liable for errors contained herein or for incidental or consequential damages in connection with the furnishing, performance or use of this material.

This document contains proprietary information which is protected by copyright. All rights are reserved. No part of this document may be photocopied or reproduced without the prior written consent of the Hewlett-Packard Ltd.

EMC COMPLIANCE

This product has been tested and complies with FTZ 1046 when used with the following cables:

Cable	HP Part Number
Weco 310	15513A E01
15 pin D	15707A E01
RS-232/V.24	15714A E01

PRINTING HISTORY

The Printing History shown below lists all Editions and Updates of this manual and the printing date(s). The first printing of this manual is Edition 1. The Edition number increments by 1 whenever the manual is revised. Updates, which are issued between Editions, contain replacement pages to correct the current Edition of the manual. Updates are numbered sequentially starting with Update 1. When a new Edition is created, it contains all the Update information for the previous Edition. Each new Edition or Update also includes a revised copy of this printing history page. Many product updates or revisions do not require manual changes and, conversely, manual corrections may be done without accompanying product changes. Therefore, do not expect a one-to-one correspondence between product updates and manual updates.

Edition 1 (37701-90000)	December 1990
Update 1 (37701-90002)	February 1991
Edition 2 (37701-90006)	June 1991

WARNINGS

WARNING: Risk of electric shock

Ensure repeater power is switched off before connecting or disconnecting connectors. Voltages up to ± 130 V dc may be present on telephone lines.

AVERTISSEMENT : Risque de choc électrique

Toujours couper l'alimentation du répéteur avant de brancher ou de débrancher des connecteurs. La tension de la ligne téléphonique peut atteindre ± 130 V cc.

WARNING

The instrument must be connected to the protective ground via the power cord or the ground terminal provided at any time that there is a connection to the instrument front panel.

WARRANTY

This Hewlett-Packard product is warranted against defects in materials and workmanship for a period of one year from date of shipment. During the warranty period, Hewlett-Packard Company will, at its option, either repair or replace products which prove to be defective.

For warranty service or repair, this product must be returned to a service facility designated by HP. Buyer shall prepay shipping charges to HP and HP shall pay shipping charges to return the product to Buyer. However, Buyer shall pay all shipping charges, duties, and taxes for products returned to HP from another country.

HP warrants that its software and firmware designated by HP for use with an instrument will execute its programming instructions when properly installed on that instrument. HP does not warrant that the operation of the instrument, or software, or firmware will be uninterrupted or error free.

LIMITATION OF WARRANTY

The foregoing warranty shall not apply to defects resulting from improper or inadequate maintenance by Buyer, Buyer-supplied software or interfacing, unauthorized modification or misuse, operation outside of the environment specifications for the products, or improper site preparation or maintenance.

NO OTHER WARRANTY IS EXPRESSED OR IMPLIED. HP SPECIFICALLY DISCLAIMS THE IMPLIED WARRANTIES OF MERCHANTABILITY AND FITNESS FOR A PARTICULAR PURPOSE.

EXCLUSIVE REMEDIES

THE REMEDIES PROVIDED HEREIN ARE BUYER'S SOLE AND EXCLUSIVE REMEDIES. HP SHALL NOT BE LIABLE FOR ANY DIRECT, INDIRECT, SPECIAL INCIDENTAL, OR CONSEQUENTIAL DAMAGES, WHETHER BASED ON CONTRACT, TORT, OR ANY OTHER LEGAL THEORY.

Contents

1. Getting Started	
Before Getting Started	1-1
Getting Started	1-2
Switch On	1-2
To Set the T1 Tester to a Known State	1-3
To Return to the Basic Measurement Display	1-5
To Set Up the Measurement	1-5
To Loop Transmit/Receive and Make a Measurement	1-6
To See Alarm Indicator Operation	1-7
To See an Alarm Record	1-8
To See More Results	1-9
To Add Transmit Errors at a Fixed Rate	1-10
To See Received Signal Details	1-11
To See a Time Related Alarm Record	1-12
To See All Error Types on One Display	1-13
To send Line (CSU) Loopcodes	1-15
After Getting Started	1-16
2. Getting Ready For T1 Testing	
To Select T1 on Combined T1/Datacom Test Sets	2-1
Fast Set Up	2-1
To Automatically Set Frame, Code and Pattern To The Incoming Signal	2-2
To Recall a Stored Set-Up	2-2
To Set Up For Storage of Results	2-4
To Set Up Long User Words	2-5
To Set the Date and Time	2-6
To Start the Clock at the Selected Time	2-8
To Store Test Set-Ups	2-9
To Indicate Stored Set-Up Content	2-11

3. T1 Testing	
How to Find Set-Up Examples	3-1
How a T1 System is Shown in This Manual	3-2
Out Of Service Testing	3-3
To Set the Terminated (TERM) T1 Line Interface	3-4
To Connect the T1 Tester to the T1 Line	3-4
To Set The Transmit Timing	3-5
To Use As A Portable CSU / Network Interface	3-5
To Loop the T1 Tester Manually	3-5
To Set the T1 Tester to Respond to a Loopcode (In-Band)	3-7
To Set the T1 Tester to Respond to a Loopcode (Out-of-Band)	3-9
To Make Fractional T1 ($n \times 56 / n \times 64$ kBit/s) Tests	3-11
To Transmit Errors and Alarms	3-12
To Transmit Errors	3-12
To Choose the Type of Error	3-13
To Choose the Error Rate	3-13
To Add Errors Singly	3-14
To Add Errors at a Fixed Rate of $1E - 3$	3-14
To Select an Error Rate	3-14
To Transmit Alarms	3-16
To Transmit and Monitor Signaling Bits	3-17
To Make Out-of-Service Tests at the Customer Premises	3-19
Level (for LBO setting), Current, Frequency and Pulse Shape	3-19
To Measure Round Trip Delay with Higher Resolution	3-22
To Monitor Errors at the Customer Premises.	3-23
Local loop Tests	3-23
Out of Service Tests From the Central Office	3-24
End-to-End and Round Trip Loopback Tests	3-24
To Loop the CSU, Network Interface, or T1 Tester at the Customer Premises using an In-Band Loopcode	3-25
To Loop the CSU, Network Interface, or T1 Tester at the Customer Premises using an Out-of-Band Loopcode	3-27
To Set-Up the T1 Tester for a Looped 15 Minute, QRSS, Logic Error Test	3-29
To Run the Test	3-29
In-Service Testing	3-30
To Set the Monitor Interface	3-31

To Connect the T1 Tester for In-service Testing	3-31
To Use the T1 Tester for Line Identification	3-32
To Make In-Service Tests	3-33
To Monitor Circuit Performance	3-33
Level, Frequency and Pulse Shape	3-33
To Set-Up the T1 Tester to Monitor Errors	3-35
Example, to Measure All Errors With Real Time Display of ESF CRC Errors.	3-35
To Monitor Timeslot Map/Content	3-36
Full Measurement List.	3-38
Auxiliary Functions	3-40

4. Displaying Test Results

To Display Alarms	4-2
To See the Current Alarm Conditions.	4-2
To See the Alarm History	4-3
To See the Record of Total Alarm Durations.	4-3
To Display Errors	4-4
To Select One of the Error Displays	4-5
To Display the Error Count of Each Error Type	4-5
To Display Details of One Error Type	4-6
For a Display of Basic Errors in Large Characters	4-7
For a More Detailed Display of One Type Of Error	4-7
For a G821 Analysis Display of One Type Of Error	4-8
To Display Alarm and Error Graphs	4-8
To Select One of the Graphic Displays	4-9
To Select the Time “Window” and Resolution of the Graphic Display	4-10
To Return to the Normal Measurement Display	4-11
To Display Stored Results	4-12
To Display One of the Stored Results.	4-12
Graphic Display - to Select Error Type or Alarms	4-14
Numeric Display - to Select Error Type, Alarms or Slips/Wander	4-14
To Return to the Normal Measurement Display	4-14
To Display Pattern Slips, Clock Slips and Wander	4-15
To Select One of the Slips/wander Displays	4-15
For T1 Testers with the Clock Slips/Wander Facility.	4-16

To Display Signal Results	4-16
To Display Pulse Shape	4-17
To Change the Pulse Mask	4-17
To Return to the Normal Measurement Display	4-17
5. Preparing To Print Results.	
To Select a Printer Output.	5-2
To Select an Output Suitable for a Hewlett - Packard 80 Column Printer.	5-2
Example Set-Up Using a Hewlett-Packard Thinkjet Printer, Model 2225D.	5-3
To Select an Output Suitable for an Alternative Printer.	5-4
6. Printing Results	
To Print Only the Occurrence of Major Alarms.	6-2
To Suppress Printing After 10 Consecutive Seconds with Major Alarms.	6-3
To Print Only Alarms and Error Count	6-4
To Automatically Trigger a Print of Alarms and Error Count.	6-4
To Suppress Printing After 10 Consecutive Seconds with EVENT Results	6-5
To Print Graphs of Alarms and Error Count.	6-6
To Print Signal Details	6-9
To Print Full Results	6-10
To Automatically Trigger a Print of Full Results.	6-10
To Print Full Results On Demand	6-11
To Print the Stored Results of a Previous Test	6-12
To Print the Pulse Shape	6-15
To Print the Full T1 Tester Settings.	6-16
7. General Information	
Introduction	7-1
Specification	7-1
Safety Considerations	7-1
Options Available	7-2
To See a Display of Options Fitted to your T1 Tester.	7-2
Accessories Supplied	7-2
Accessories Available	7-3

Specification	7-3
Specifications	7-4
TRANSMITTER	7-5
Transmitter timing	7-5
Internal Tx Clock	7-5
Tx Error Add	7-5
Tx Alarms	7-6
Tx loopback codes (in-band)	7-6
Tx loopback codes (out-of band)	7-6
Idle code	7-7
Output	7-7
RECEIVER	7-7
DSX-MON	7-7
TERMINATED	7-7
BRIDGE	7-8
Jitter Tolerance	7-8
Alarm LEDs (red)	7-8
Signal Indication	7-9
Frame Sync Criteria	7-9
Frame Loss Criteria	7-10
Pattern sync	7-10
Test Period	7-10
CSU EMULATION	7-10
Status Messages	7-10
Autoreponse Mode	7-10
Loopcode Detection	7-11
Line Loopback	7-12
MEASUREMENTS	7-13
Recovered Clock Frequency Measurement	7-13
Pattern Slip Measurements	7-13
Simplex Current Measurement	7-13
Signal Level Measurement	7-14
Round Trip Delay Measurement	7-14
CHANNEL ACCESS	7-15
VF Output	7-15
RESULTS	7-16
Error Results	7-16
Error Count	7-16

Error Seconds	7-16
Error Count and Error Second	7-16
Ave. Error Ratio	7-16
Cur. Error Ratio	7-16
Error Ratio Format	7-16
Error Free Seconds	7-16
% Error-free Secs	7-16
Percentage format	7-16
SEF Count	7-16
OOE Count	7-17
LOF Count	7-17
Frame Loss Seconds	7-17
Alarm Seconds	7-17
Trouble Scan	7-17
Pattern slips	7-17
Time-of-day Clock	7-17
DATA LOGGING	7-17
Logging to external printer	7-17
Printout types	7-17
PRINTER and REMOTE CONTROL PORT	7-18
Printer output	7-18
Remote control	7-18
Modem operation	7-19
General	7-20
Instrument settings storage	7-20
Connectors	7-20
OPTIONS	7-21
Pulse Shape	7-21
Measurements	7-21
Clock slips measurement	7-21
Measurements	7-21
Timing Reference DSX Input	7-22
Wander Measurement	7-22
Internal electronic result storage	7-22
Stored End-of-Period Results	7-23
Stored End-of-period G.821 analysis	7-23
Stored End-of-Period Alarm Seconds	7-23
Graphic result presentation	7-23

Error Sources	7-23
Display Format	7-23
G.821 error results during measurement	7-23
8. Installation	
Introduction	8-1
Initial Inspection	8-1
Preparation for Use	8-2
Power Requirements	8-2
Line Fuses	8-2
Power Cable	8-3
Battery (Option 002)	8-4
To Charge the Batteries (Option 002)	8-4
To Change the Batteries	8-5
Battery Fuses	8-6
To Change a Blown Fuse	8-6
Mating Connectors (Front Panel)	8-6
T1 Tester Selection When Using a T1/DATACOM TEST SET	8-7
ACCESSORY Port - for Datacom Module Connection	8-7
RS-232 Port - for Printer or Remote Control Connection	8-7
Modem Connection	8-9
Rack Mounting	8-10
Operating Environment	8-11
Storage and Shipment	8-11
Environment	8-11
Packaging	8-12
9. T1 Tester Performance Tests	
Introduction	9-1
Calibration Cycle	9-1
Recommended Test Equipment	9-2
Operational Verification	9-4
Default Settings	9-5
T1 Tester Self Test	9-6
T1 Self Tests, Order and Fail Codes	9-8
Auto Configure	9-9
Pulse Mask (Option 001)	9-10
Voice Frequency Output	9-11

Recovered Loop Timing	9-13
Internal Transmitter Clock	9-15
Alarm Leds (red)	9-16
Performance Tests	9-18
T1 Tester Self Test	9-19
T1 Self Tests, Order and Fail Codes	9-21
Internal Transmitter Clock	9-22
Transmitter Pattern Generation	9-23
Transmitter Line Coding	9-26
Transmitter Frame Pattern	9-28
Transmitter Error Add	9-31
Transmitter Output	9-33
Recovered Clock Frequency Measurement	9-36
Receiver Equalization, Gain and Level Measurement	9-38
Wander/Slips Measurement (Option 001)	9-42
Simplex Current Measurement	9-46
Alarm Leds (red)	9-48

10. Remote Control

Command History	10-1
Preparation for Remote Control	10-2
To Connect to Telephone Lines via Modems	10-3
To Connect for Direct Operation	10-3
To Set the Tester for Operation from a Terminal	10-4
To Set the Tester for Operation from a Computer	10-5
Remote Operation	10-6
Terminal Control	10-7
Prompting and Input Editing	10-8
The Prompt	10-8
Input Editing	10-8
Error Reporting	10-8
Mnemonic Responses	10-9
Programming Tips	10-11
Reading of Status Registers	10-11
Determining Start and Stop	10-11
Start/Stop operation timing	10-12
Restarting with the STR command or with START/STOP	10-12

Stopping with the STP command, with START/STOP or after a timed measurement	10-12
The Delay in the Execution of Some Commands	10-13
THE COMMANDS	10-14
COMMON CAPABILITY MESSAGES	10-14
Reset	10-14
Remote	10-14
Local	10-14
Clear	10-15
Device Clear	10-15
Key Query	10-15
Request Service Mask	10-16
Instrument Identification	10-18
Instrument Identification Query	10-18
Revision Date Query	10-18
Serial Number Query	10-18
Error Code Query	10-19
Ready Code Query	10-19
Status/Events Query	10-19
Status Query	10-19
Options Query	10-20
CONFIGURATION COMMANDS	10-21
Instrument Configuration	10-21
Framing Type	10-21
Pulse Mask Polarity Query	10-22
Pulse Truncated Query	10-22
Pulse Mask Selection	10-22
Application Type	10-22
Receiver Timeslot Selection	10-23
Transmitter Multiple Timeslot Selection	10-23
Receiver Multiple Timeslot Selection	10-23
Pattern Type	10-24
Special Pattern / Test Type	10-24
Long User Word	10-25
Long User Word Length	10-25
Long User Word Select	10-25
Long User Word Sync Mode	10-26
Long User Word Sync Length	10-26

Long User Word Left Hand Bit	10-26
Coding Type	10-27
User Defined Pattern	10-27
User Defined Pattern (Fractional T1)	10-27
Send Signaling Bits	10-28
Send Background Signaling Bits	10-28
Send Signaling Bits in Channel	10-28
High Resolution Round Trip Delay Transmit Timeslot Selection	10-29
High Res Round Trip Delay Rx Timeslot Select	10-29
High Res Round Trip Delay Rx From Select	10-29
VF Channel Select	10-30
Send Tone in Channel	10-30
VF Channel Audio Select	10-30
VF Channel Mapping	10-30
VF Timeslot Query	10-31
Test Period	10-31
Test Duration	10-31
CSU Auto Mode	10-32
Loopback Band	10-32
CSU Manual Mode	10-33
Alarm Generation Type	10-34
Loopback Type	10-34
User Defined Loopdown	10-35
User Defined Loopup Code	10-35
Loopup	10-35
Loopdown	10-36
Loopup (In-Band) status Query Command	10-36
Loopback Code Framing	10-36
Printer Squelch	10-36
Printer Demand	10-37
Printer Auto Trigger	10-37
Interface Type	10-37
Line Build Out	10-38
Transmit Timing	10-38
Signaling Bit Display Type Select	10-38
Signaling Bit Display Channel Select	10-39
Timeslot Map Display Type Select	10-39

Stored Power Fail Alarm Seconds Result Query	10-73
Stored Yellow Alarm Seconds Result Query	10-73
Stored Excess Zeros Alarm Seconds Result Query	10-74
Stored Pattern Loss Seconds Result Query	10-74
Stored Frame Loss Alarm Seconds Result Query	10-74
Stored Signal Loss Alarm Seconds Result Query	10-75
Stored All Ones AIS Alarm Seconds Result Query	10-75
Stored Uncontrolled Slips Result Query	10-76
Stored Controlled Slips Result Query	10-76
Stored Bit Slips Result Query	10-76
Stored Estimated Frame Slips Result Query	10-77
Stored Framing Type Query	10-77
Stored Coding Type Query	10-77
Stored Pattern Type Query	10-78
Stored Interface Type Query	10-78
Stored Test Time Query	10-78
Stored Elapsed Time Result Query	10-78
Stored Test Duration (user defined) Query	10-79
Stored User Defined Pattern Query	10-79
Stored Application Query	10-79
Stored Receiver Timeslot Selection Query	10-80
Stored Long User Word Selection Query	10-80
Stored Special Pattern/Test Query	10-80
Stored Transmitter Multiple Timeslot Query	10-80
Stored Receiver Multiple Timeslot Query	10-81
Stored User Defined Pattern (Fractional T1) Query	10-81
Pulse Mask and Data Plot Query	10-81
Pulse Sample Trigger Mask	10-82
Pulse Sample Trigger Reset	10-83
Pattern Loss Count Criterion	10-84
SELF TEST COMMANDS	10-85
Number Of Tests	10-85
Number of Sub-tests in a Test	10-85
Self-test	10-86
Default Conditions	10-87
Status Registers	10-90
STATUS REGISTER A	10-90
STATUS REGISTER B	10-92

READY REGISTER	10-93
ALARM REGISTER	10-94
PULSE SAMPLE MASK REGISTER	10-96
Error Codes	10-97
Parse Time Errors (Error codes -100 to -200)	10-97
Execution Time Errors (Error codes -200 to -349)	10-98
Option or Capability Errors (Error codes -350 to -370)	10-99
Error Codes for Stored Measurement Results and Graphics	10-99
Self-Test Errors (Error codes 1 to 1599)	10-100
Restart Causing Commands	10-105

Index

Timeslot Map Display Timeslot Select Command	10-39
MISCELLANEOUS COMMANDS	10-40
Autoconfigure	10-40
Stored Panel Lock	10-40
Beep Command	10-40
Volume Command	10-40
Save Panel Command	10-41
Panel Descriptor Query	10-41
Recall Panel Command	10-41
Start Measurement	10-41
Stop Measurement	10-42
T1/Datacom Mode	10-42
RS232C Printer Interface	10-43
Date Set-Up	10-43
Time Set-Up	10-44
Display	10-44
ALM Query	10-45
Alarm change Query	10-45
Alarm Mask	10-46
History Query	10-46
History Reset	10-47
ERROR INSERT COMMANDS	10-48
Error Insert Rate	10-48
Error Insert Type	10-48
User Defined Error Insert Ratio	10-48
Single Error Insert	10-49
RESULT QUERY COMMANDS	10-50
Wander Lock Query	10-50
Logic Error Result Query	10-50
Logic Analysis Result Query	10-51
BPV Error Result Query	10-52
Frame Error Result Query	10-52
Frame Analysis Result Query	10-53
CRC Error Result Query	10-54
CRC Analysis Result Query	10-54
Receiver Level Result Query	10-55
Wander Results Query	10-55
Signaling Bits Result Query	10-56

Channel Monitor All Signalling Bits Query Command . . .	10-56
Channel Monitor single signaling bits Query Command . .	10-57
Simplex Current Result Query	10-57
Signal Frequency Result Query	10-58
Signal Frequency Offset Result Query	10-58
Signal Round Trip Delay Query	10-58
Power Fail Alarm Seconds Result Query	10-59
Yellow Alarm Seconds Result Query	10-59
Excess Zeros Alarm Seconds Result Query	10-59
Pattern Loss Seconds Result Query	10-59
Frame Loss Alarm Seconds Result Query	10-60
Signal Loss Alarm Seconds Result Query	10-60
All Ones AIS Alarm Seconds Result Query	10-60
Uncontrolled Slips Result Query	10-60
Controlled Slips Result Query	10-61
Bit Slips Result Query	10-61
Estimated Frame Slips Result Query	10-61
Pulse Mask Result Query	10-62
Pulse Mask Plot Query	10-62
Elapsed Time Result Query	10-63
Timeslot Monitor Query Command	10-63
TX Timeslot bandwidth query	10-63
Timeslot Swap Result Query Command	10-63
Round Trip Delay in Timeslot Query Command	10-64
STORED RESULTS COMMANDS	10-65
Get store size and usage	10-65
Get store use information	10-65
Get store data	10-66
Get store data in compressed form	10-67
Storage Lock	10-68
Stored Logic Error Result Query	10-68
Stored Logic Analysis Result Query	10-69
Stored BPV Error Result Query	10-69
Stored Frame Error Result Query	10-70
Stored Frame Analysis Result Query	10-71
Stored CRC Error Result Query	10-71
Stored CRC Analysis Result Query	10-72
Stored Wander Results Query	10-72

What the T1 Tester Gives You

- Comprehensive measurements and interfaces to connect at all T1 points - only one box to buy, carry and learn
- Graphic on-screen presentation - at-a-glance interpretation of long-term tests and no need to use a printer
- "Trouble scan" - saves running several tests or stepping through results to find out what's wrong
- Graphic, on screen presentation of T1 pulse shape - rapid distinction of marginal pulse failures from gross failures, and simple detection of badly set equipment
- Built-in VF channel access allowing listening, signaling bit display and connection of a TIMS - easy circuit identification, checking if channels are idle and channel performance measurements
- Automatic internal results storage, allowing results to be viewed or printed later - no need to buy and carry field printers to record test results
- High resolution clock slips measurement with graphic presentation - faster and more positive identification of timing problems on T1 networks
- Upgradability - lasting value and protection of your investment in test equipment

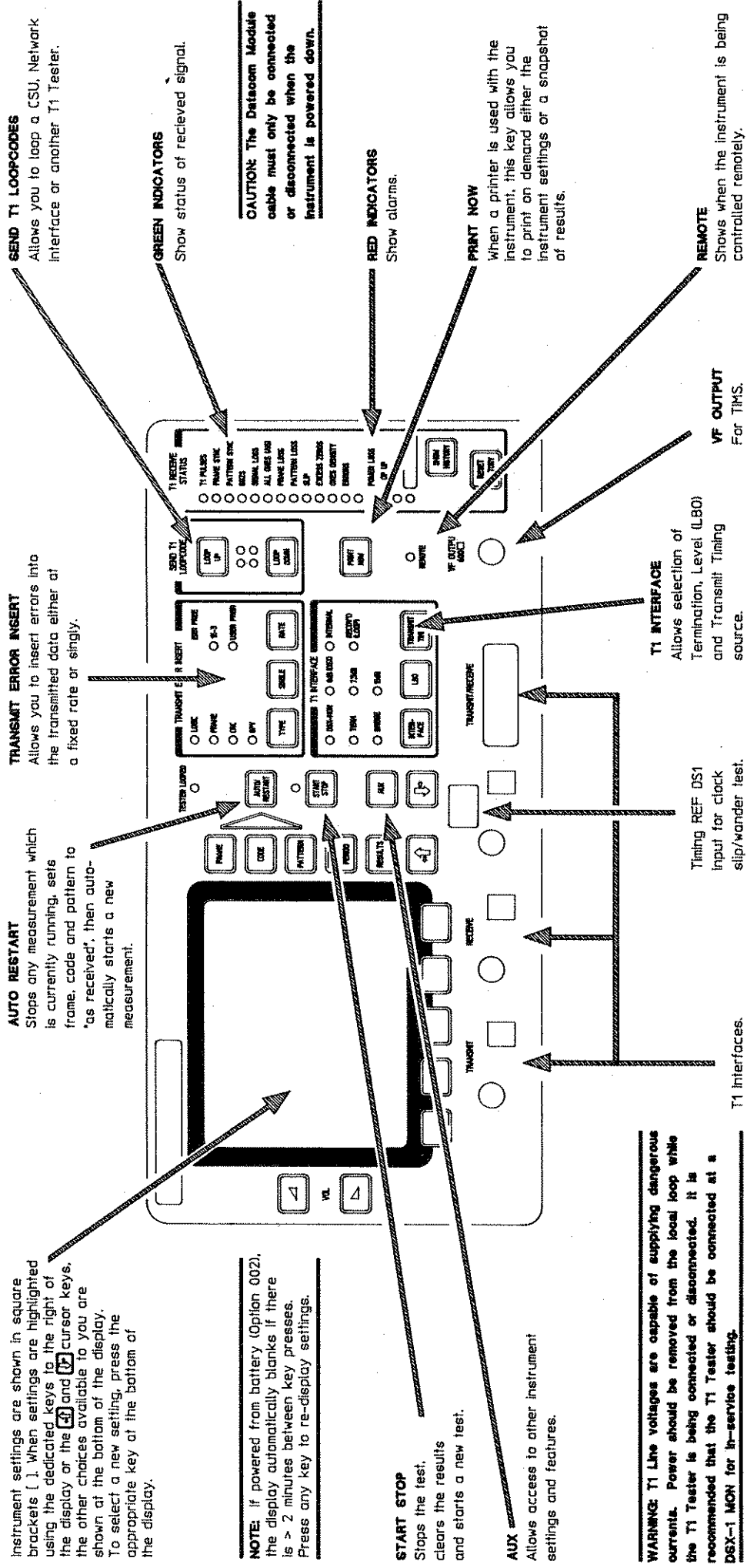

FRONT PANEL FEATURES

1

Getting Started

This chapter tells you about the basic features of the instrument and shows you how to use them. The items covered are:

- Switching on
- Setting the T1 Tester to a known state
- Returning to the basic measurement display
- Setting up a measurement
- Making a measurement
- Adding transmit errors
- Observing alarm indications
- Displaying an alarm record
- Displaying basic results and full results
- Adding transmit errors at a fixed rate
- Displaying received signal details
- Displaying a time related alarm record
- Sending line (CSU) loopcodes
- Displaying all error types together

Before Getting Started

Ensure that there are no cables connected to the instrument front panel. Connect the instrument to a power supply of between 85 V ac and 264 V ac. If in doubt see “Installation” in chapter 7.

Getting Started

Switch On

Switch on.

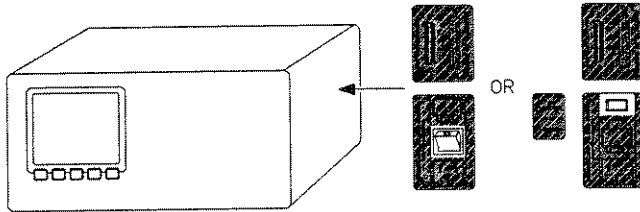

You should see.

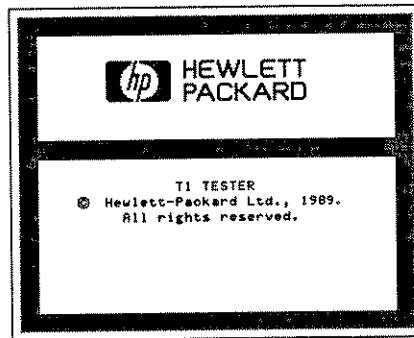

Followed by.

If the T1 Tester is part of a combined T1/Datacom Test Set, set the Datacom module TEST SELECT to T1.

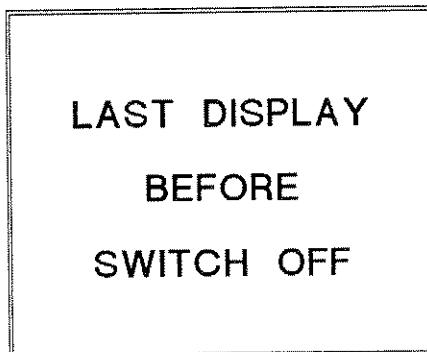

To Set the T1 Tester to a Known State

The T1 Tester can store 1 fixed and 5 user selectable test set-ups. You are going to recall the fixed set-up. Press **AUX**

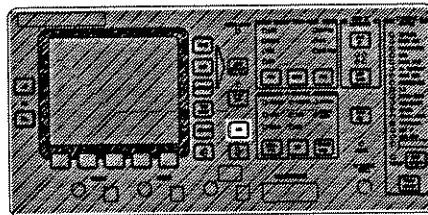

You should see one of the AUX FUNCTION displays with **AUX FUNCTION** highlighted.

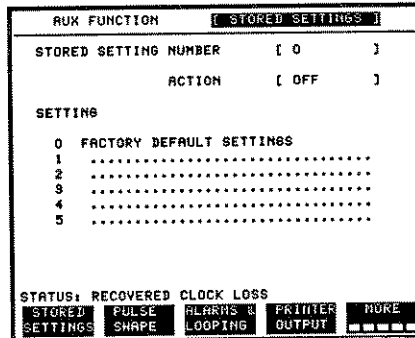

Select **STORED SETTINGS**

NOTE :
The instrument starts up in the "last used" state. Some of the settings in this procedure may already be selected.

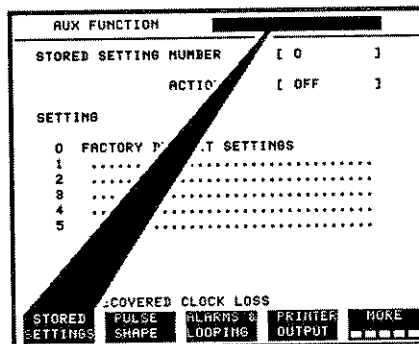

Use **[←]** and **[→]** to highlight
STORED SETTING NUMBER [0]

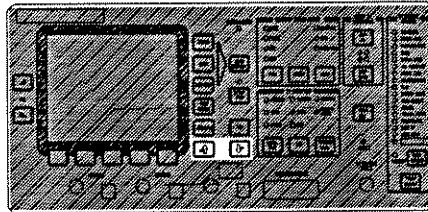

Select **0**.

0 is the fixed stored setting.

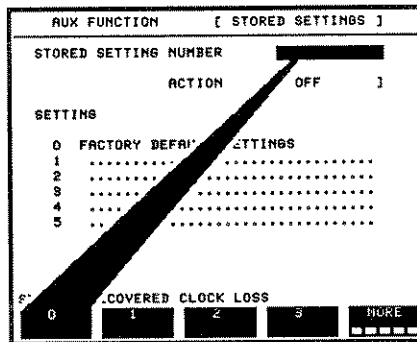

Highlight **ACTION [OFF]**.

Select **RECALL**.

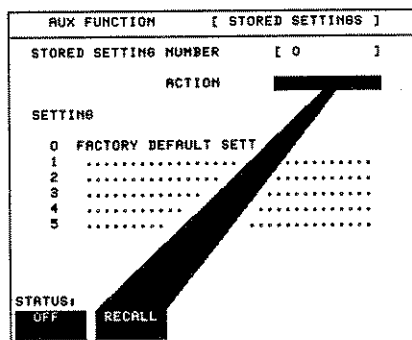

To Return to the Basic Measurement Display

Any measurement set-up key will get you to the basic measurement display. In this case, Press **RESULTS**.

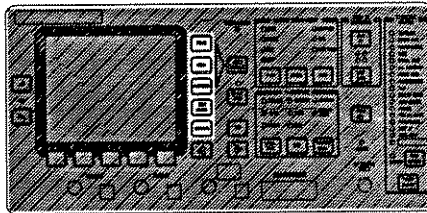

You should see.

```

FRAME [ D4 ] CODE [ B825 ]
PATTERN [ QRSS ]

TEST PERIOD [ CONTINUOUS ]

DISPLAY [ ERROR RESULTS ] [ LOGIC ]
    
```

To Set Up the Measurement

Set the display to:

```

DISPLAY
[ ERROR RESULTS ] [ LOGIC ]
[ BASIC RESULTS ] [ STORE OFF ]
    
```

```

FRAME [ D4 ] CODE [ B825 ]
PATTERN [ QRSS ]

TEST PERIOD [ CONTINUOUS ]

DISPLAY [ ERROR RESULTS ] [ LOGIC ]
        [ BASIC RESULTS ] [ STORE OFF ]

ES .....
%EFS .....%
ERRORS .....
AVERAGE ER .....

STATUS: RECOVERED CLOCK LOSS
ELAPSED TIME 00d 00h 00m 00s
ANALYSIS
RESULTS RESULTS
    
```

To Loop Transmit/Receive and Make a Measurement

Connect

TRANSMIT to RECEIVE with a WECO 310 cable. Check that received data is correct (green indicators on).

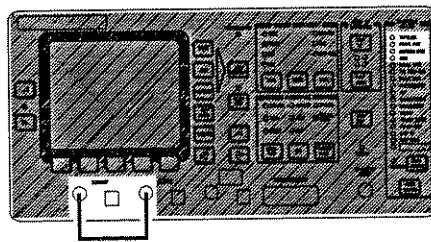

Watch the ERRORS indicator flash and the results display accumulate errors when you press TRANSMIT ERROR. INSERT **SINGLE** a few times.

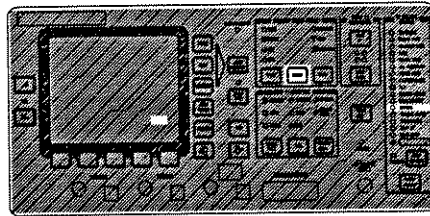

To See Alarm Indicator Operation

Break the signal path.

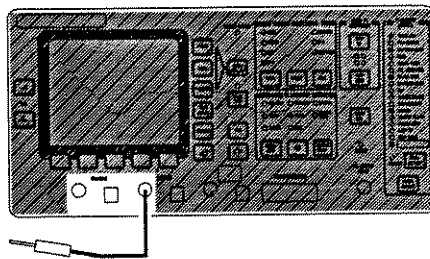

You should see the alarm indication for the current situation.

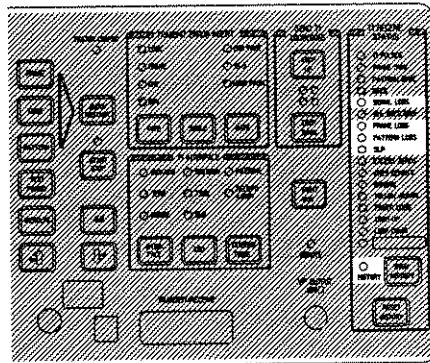

To See an Alarm Record

Reconnect the signal path.

As alarms have occurred in the current test, you should see the HISTORY indicator on.

Press **SHOW HISTORY** to see what they were.

You can use this to check for the occurrence of alarms on unattended tests.

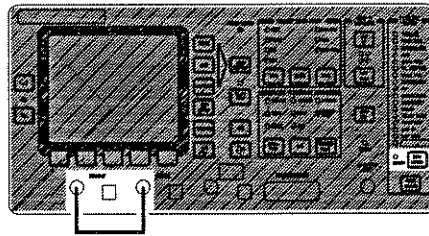

The display is frozen but the test is still running.

Press **SHOW HISTORY** again to unfreeze the display.

Press **RESET HISTORY**.

You should see the HISTORY indicator go off.

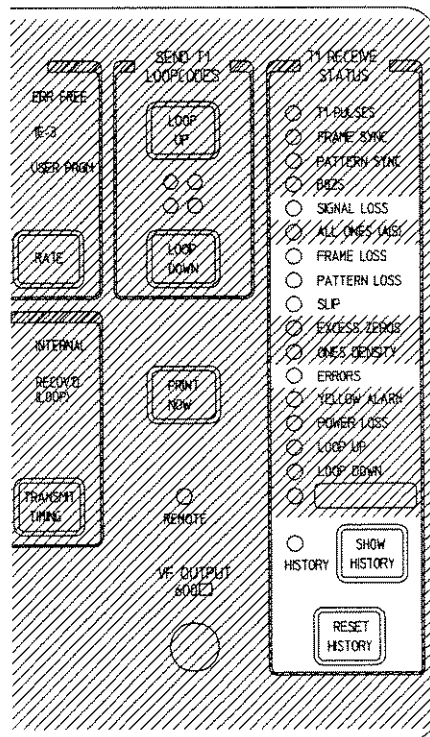

To See More Results

Highlight

[ERROR RESULTS] [LOGIC]

BASIC RESULTS

Select ALL RESULTS

FRAME [D4]	CODE [B8ZS]
PATTERN [QRSS]	
TEST PERIOD [CONTINUOUS]	
DISPLAY [ERROR RESULTS]	[LOGIC]
	[STORAGE OFF]
ES
SYNCHRONOUS ES
EFS
%EFS %
ERRORS
AVERAGE ER
CURRENT ER
	PSED TIME ..d..h..m..s
STATUS:	
BASIC RESULTS	ALL RESULTS ANALYSIS

You should see.

[FULL-Y1]	FRAME [D4]	CODE [B8ZS]
PATTERN [QRSS]		
TEST PERIOD [CONTINUOUS]		
DISPLAY [ERROR RESULTS]	[LOGIC]	
	ALL RESULTS	[STORE OFF]
ES		8
EFS		472
%EFS		99.968%
ERRORS		152923
AVERAGE ER		2.1E-04
CURRENT ER		0
	ELAPSED TIME	00d 00h 07m 55s
STATUS:		
BASIC RESULTS	ALL RESULTS	ANALYSIS

To Add Transmit Errors at a Fixed Rate

Use **RATE** to set TRANSMIT ERROR
INSERT to 1E-3.

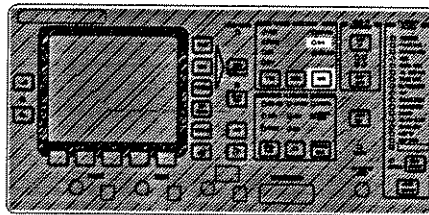

You should see
CURRENT ER ... 1.0E - 0.3.

FRAME	[B4]	CODE	[B82S]
PATTERN	[QRSS]		
TEST PERIOD [CONTINUOUS]			
DISPLAY	[ERROR RESULTS]	[LOGIC]	
	ALL RESULTS	[STORAGE OFF]	
ES		320	
SYNCHRONOUS ES		318	
EFS		1900	
%EFS		85.586 %	
ERRORS		3.364E+07	
AVERAGE ER		9.9E-09	
CURRENT ER		1.0E-08	
ELAPSED TIME		00d 00h 37m 00s	
STATUS:			
BASIC	ALL	ANALYSIS	
RESULTS	RESULTS		

Use **RATE** to set TRANSMIT ERROR INSERT to ERR FREE.

To See Received Signal Details

Press **RESULTS**.

Select **SIGNAL RESULTS**.

FRAME	[B4]	CODE	[B029]
PATTERN	[QRSS]		
TEST PERIOD [CONTINUOUS]			
DISPLAY	[ALL]	[LOGIC]	[STORAGE OFF]
ES			711
SYNCHRONOUS ES			709
EFS			1900
XEFS			72.769 %
ERRORS			24E+07
AVERAGE ER			5E-03
CURRENT ER			7E-03
STATUS: ELA E 00d 00h 43m 31s			
ERROR RESULTS	TROUBLE SCAN	SIGNAL RESULTS	GRAPHICS MORE

Watch the RECEIVER LEVEL change as you change the transmit level with **LBO** (Line Build Out).

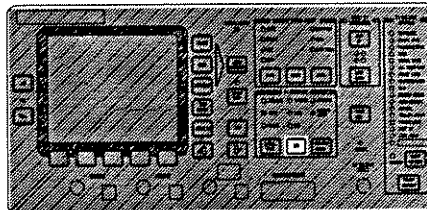

To See a Time Related Alarm Record

Highlight DISPLAY [**ALARM SECONDS**].

Use **MORE** to change the selections available.

Select **ALARM SECONDS**.

FRAME	[D4]	CODE	[B8ZS]
PATTERN	[QRSS]		
TEST PERIOD [CONTINUOUS]			
DISPLAY		[STORAGE OFF]	
SIGNAL LOSS		
ALL ONES (AIS)		
FRAME LOSS		
PATTERN LOSS		
YELLOW ALARM		
POWER LOSS		
EXCESS ZEROS		
STATUS:		ELAPSED TIME ..d ..h ..M ..s	
<input checked="" type="checkbox"/> SLIPS/ <input type="checkbox"/> MANDER	<input checked="" type="checkbox"/> ALARM <input type="checkbox"/> SECONDS	<input type="checkbox"/> MORE	

You should see the alarm durations caused by breaking the signal path

FRAME	[D4]	CODE	[B8ZS]
PATTERN	[QRSS]		
TEST PERIOD [CONTINUOUS]			
DISPLAY		[STORAGE OFF]	
SIGNAL LOSS			8
ALL ONES (AIS)			0
FRAME LOSS			8
PATTERN LOSS			8
YELLOW ALARM			0
POWER LOSS			0
EXCESS ZEROS			0
STATUS:		ELAPSED TIME 00d 00h 25m 34s	
<input checked="" type="checkbox"/> SLIPS/ <input type="checkbox"/> MANDER	<input checked="" type="checkbox"/> ALARM <input type="checkbox"/> SECONDS	<input type="checkbox"/> MORE	

To See All Error Types on One Display

Highlight DISPLAY [].

Select **TRouble SCAN**.

Press **START/STOP** to start a new test.

```

FRAME [ D4 ] CODE [ B82S ]
PATTERN [ QRSS ]

TEST PERIOD [ CONTINUOUS ]

DISPLAY [    ] [ STORAGE OFF ]

SIGNAL LOSS 0
ALL ONES (AIS) 0
FRAME LOSS 0
PATTERN LOSS 0
YELLOW ALARM 0
POWER LOSS 0
EXCESS ZERO 0

PSEED TIME 00d 00h 02m 35s

STATUS:
ERROR TRouble SIGNAL GRAPHICS MORE
RESULTS SCAN RESULTS      
    
```

You should see.

```

FRAME [ D4 ] CODE [ B82S ]
PATTERN [ QRSS ]

TEST PERIOD [ CONTINUOUS ]

DISPLAY [ TRouble SCAN ] [ STORAGE OFF ]

NO TROUBLE

ELAPSED TIME 00d 00h 02m 11s

STATUS:
ERROR TRouble SIGNAL GRAPHICS MORE
RESULTS SCAN RESULTS      
    
```

Press TRANSMIT ERROR INSERT **(SINGLE)** a few times.

You should see.

```

FRAME [ D4 ] CODE [ B82S ]
PATTERN [ QRSS ]

TEST PERIOD [ CONTINUOUS ]

DISPLAY [ TRouble SCAN ] [ STORAGE OFF ]

LOGIC EC 8

ELAPSED TIME 00d 00h 05m 27s

STATUS:
ERROR TRouble SIGNAL GRAPHICS MORE
RESULTS SCAN RESULTS      
    
```

Use TRANSMIT ERROR INSERT
TYPE To select FRAME.

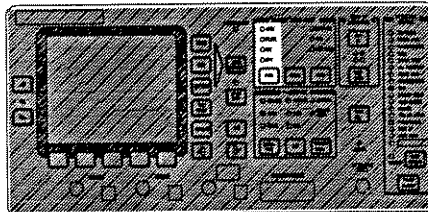

Press TRANSMIT ERROR INSERT
SINGLE a few times.

You should see.

FRAME	[D4]	CODE	[B02S]
PATTERN	[QRSS]		
TEST PERIOD [CONTINUOUS]			
DISPLAY	[TRUBLE SCAN]	[STORAGE OFF]	
LOGIC EC			9
FRAME EC			12
ELAPSED TIME 00d 00h 09m 08s			
STATUS:			
ERROR RESULTS	TRUBLE SCAN	SIGNAL RESULTS	GRAPHICS MORE

Use TRANSMIT ERROR INSERT
TYPE To select BPV.

Press TRANSMIT ERROR INSERT
SINGLE a few times.

You should see.

FRAME	[D4]	CODE	[B02S]
PATTERN	[QRSS]		
TEST PERIOD [CONTINUOUS]			
DISPLAY	[TRUBLE SCAN]	[STORAGE OFF]	
LOGIC EC			9
BPV EC			6
FRAME EC			13
ELAPSED TIME 00d 00h 31m 49s			
STATUS:			
ERROR RESULTS	TRUBLE SCAN	SIGNAL RESULTS	GRAPHICS MORE

Press **START STOP** to reset the display
and start a new test.

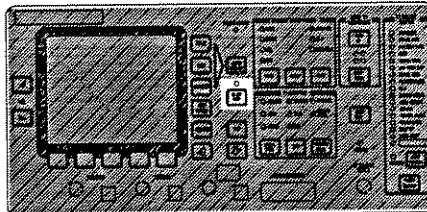

To send Line (CSU) Loopcodes

Watch the LOOP UP indicator come on briefly when you press **LOOP UP**, then, watch the LOOP DOWN indicator come on for 8 seconds when you press **LOOP DOWN**.

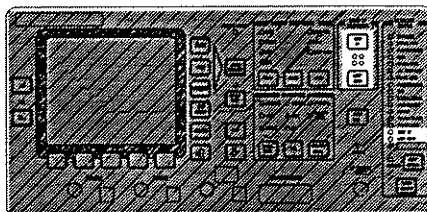

After Getting Started

Now that you are familiar with the operation of the instrument and are able to make the basic measurements, it's time to explore.

Press **AUX** and have a look at some of the other things that you can do.

Select the printer/remote control set-up display **PRINTER/REM CTL**. RS 232 MODE lets you select the function of the RS 232 connector.

Select **PRINTER OUTPUT** and set up an AUTO TRIGGERED PRINT.

Select **VF ACCESS** and switch the AUDIO MONITOR **ON** and **OFF**.

Select **ALARMS & LOOPING**. You can change the USER PROGRAM ERROR RATE and set the T1 tester to transmit an alarm here. You can also select LOOPCODES, set the T1 tester to respond to that loopcode, or force the T1 tester to loop up or down.

Select **PULSE SHAPE** if you have the T1 tester with the pulse shape display option. You will need to press **AUX** again to get back to the other AUXILIARY selections, press a test set-up key to get back to the set-up display or press **RESULTS** to get back to the results display.

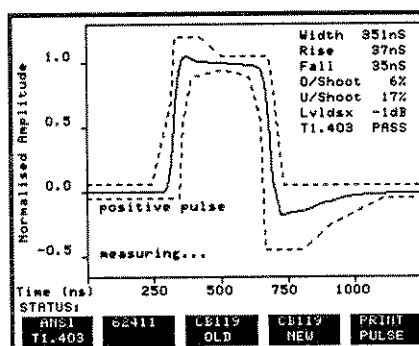

2

Getting Ready For T1 Testing

This chapter tells you how to set features which apply to all T1 tests. Check to see if you want to do any of the things in the following list. If not go on to Chapter 3 T1 Testing.

- Selecting T1 on combined T1/Datacom Test Sets.
- Fast Set up.
- Recalling stored set-ups.
- Storing results.
- Setting long user words.
- Setting the date and time.
- Storing test set-ups.

To Select T1 on Combined T1/Datacom Test Sets

If the T1 Tester is part of a combined T1/Datacom Test Set, set the Datacom module TEST SELECT to T1.

Fast Set Up

There are five ways to set up the T1 tester :

1. Automatically setting Frame, Code and Pattern to the incoming signal.
2. Recalling stored set-ups.
3. Recalling stored set-ups and modifying them.
4. Manually from the front panel (see Chapter 3 T1 Testing).
5. Over an RS 232 link (see Chapter 10 Remote Control).

To Automatically Set Frame, Code and Pattern To The Incoming Signal

Press **AUTO RESTART**

This will also start a new test.

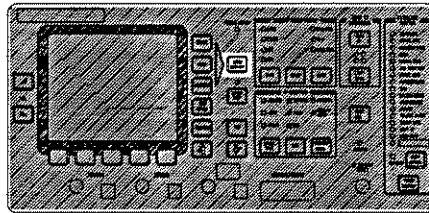

To Recall a Stored Set-Up

Press **AUX**.

Select **STORED SETTINGS**.

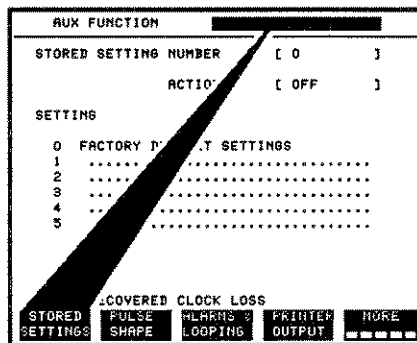

Highlight STORED SETTING NUMBER
[]

and select the set-up you want.

AUX FUNCTION		[STORED SETTINGS]	
STORED SETTING NUMBER	[]	ACTION	[OFF]
SETTINGS			
0	FACTORY DEFAULT SETTINGS		
1		
2		
3		
4		
5		
STATUS: RECOVERED CLOCK LOSS			
0	1	2	3
			PURE

Highlight ACTION []

Select **RECALL**.

AUX FUNCTION		[STORED SETTINGS]	
STORED SETTING NUMBER	[0]	ACTION	[]
SETTINGS			
0	FACTORY DEFAULT SETT		
1		
2		
3		
4		
5		
STATUS: OFF			
			RECALL

To Set Up For Storage of Results

To see the storage space available before overwriting occurs.

Use **RESULTS**, **GRAPH RESULTS**,
TEXT RESULTS **STORE STATUS**

100% = 32 hours at 1 minute resolution.
20 days at 15 minute resolution.
80 days at 1 hour resolution.

STORE	START DATE	START TIME	TEST DURATION	STORE USE
-9				
-8D	29-MAR-1989	03:09	00d 00h 01m	<1%
-7T	29-MAR-1989	06:00	00d 00h 04m	<1%
-6T	29-MAR-1989	06:15	00d 00h 01m	<1%
-5D	29-MAR-1989	06:15	00d 00h 15m	<1%
-4T	29-MAR-1989	06:17	00d 00h 01m	<1%
-3T	29-MAR-1989	06:22	00d 00h 06m	<1%
-2T	29-MAR-1989	06:27	00d 00h 01m	<1%
-1T	29-MAR-1989	06:15	00d 00h 15m	<1%
LAST	2-APR-1989	03:46	00d 00h 01m	<1%
02d 19h 59m STORE FREE			TOTAL USED	<1%
AT CURRENT 1 MINUTE			FREE	99%
SAMPLE PERIOD.				
STATUS:				
GRAPH RESULTS	TEXT RESULTS	DELETE STORE	DELETE ALL	

Press **RESULTS**.

Set up the test.

Highlight **[STORE]**.

Start the test by selecting the storage resolution you want.

[FULL-T1]	FRAME [D4]	CODE [B8ZS]
PATTERN [QRSS]		
TEST PERIOD [CONTINUOUS]		
DISPLAY [ERROR RESULTS]	[LOGIC]	
[ALL RESULTS]	[STORE OFF]	
ES	0	
EFS	143	
XEFS	100.000%	
ERRORS	0	
AVERAGE ER	0	
CURRENT ER	0	
ELAPSED TIME 00d 00h 02m 23s		
STATUS:		
STORAGE OFF	STORAGE 1 MIN	STORAGE 15 MIN
		STORAGE 1 HOUR

To Set Up Long User Words

You may select and store up to four words of up to 128 bytes. For high error conditions you may select sync on any number of bytes.

Press **AUX**.

Select **LONG USER WORD**.

```

AUX FUNCTION      [ STORED SETTINGS ]
-----
STORED SETTING NUMBER [ 0 ]
ACTION              [ OFF ]

SETTING
0  FACTORY DEFAULT SETTINGS
1  .....
2  .....
3  .....
4  .....
5  .....

STATUS:
STORED SETTINGS  PULSE SHAPE  ALARMS & LOOPING  LONG USER WORD  MORE

```

Highlight **BYTE LENGTH** [] and select the number of bytes you want in the pattern.

Highlight **SYNC ON** [] and select the number of error free bytes you want the T1 Tester to sync on.

Highlight **LEFT HAND BIT SENT** [] and select **FIRST** to transmit bits as shown at the bottom of the display, or **LAST** to transmit bits in the reverse order.

```

AUX FUNCTION      [ LONG USER WORD ]
-----
USER WORD [1] BYTE LENGTH [128] IS NOT ACTIVE
SYNC ON [VARIABLE LENGTH] [118] BYTES

LEFT HAND BIT SENT [FIRST]
1-16  [8080C080808000808080808080C08080]
17-32 [8080E080808080RAAAAAAAAA55555580]
33-48 [8080808080FFFFFFFFF0180018001]
49-64 [8001800180018088FFFFFFFFFFFFFF]
-----
65-80 [555555555555557777777777777777]
81-96 [EEEEEEEEEEEEEEEE66666666666666]
97-112 [999999999999994444444444444444]
113-128 [FFFFFFFFFFFFFFFFFFFFFFFFFFFFFF]

STATUS:
FIRST  LAST

```

To change a byte

Highlight each of the two hexadecimal characters for that byte and select the byte you want. The binary value is shown at the bottom of the display.

Select **SET-UP**.

```

AUX FUNCTION      [ LONG USER WORD ]
-----
USER WORD [1] BYTE LENGTH [128] IS NOT ACTIVE
SYNC ON [VARIABLE LENGTH] [118] BYTES

LEFT HAND BIT SENT [FIRST]
1-16  [8080C080808000808080808080C08080]
17-32 [8080E080808080RAAAAAAAAA55555580]
33-48 [8080808080FFFFFFFFF0180018001]
49-64 [8001800180018088FFFFFFFFFFFFFF]
-----
65-80 [555555555555557777777777777777]
81-96 [EEEEEEEEEEEEEEEE66666666666666]
97-112 [999999999999994444444444444444]
113-128 [FFFFFFFFFFFFFFFFFFFFFFFFFFFFFF]

CURSOR AT BYTE 105 BYTE = 01000100

STATUS:
DECREASE DIGIT  INCREASE DIGIT  ←  →

```

To Set the Date and Time

Press **AUX**.

Select **TIME & DATE**.

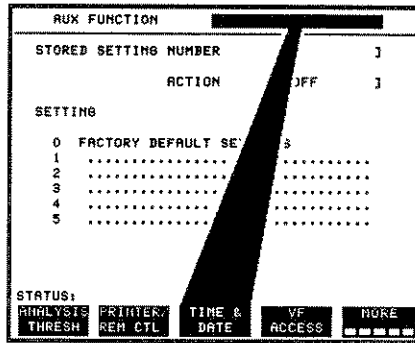

Highlight **CLOCK MODE** []

Select **SET-UP**.

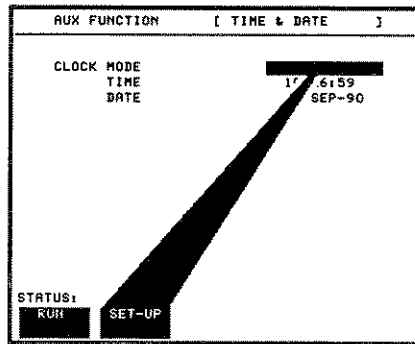

Highlight DATE [**1**].

Use ← and →,

INCREASE DIGIT / **DECREASE DIGIT** and
PREVIOUS MONTH / **NEXT MONTH**
to set the date.

AUX FUNCTION		[TIME & DATE]
CLOCK MODE		[SET-UP]
TIME		[10:32:07]
DATE		[1 -SEP-90]

STATUS:
DECREASE DIGIT INCREASE DIGIT ← →

Highlight TIME [**1**].

Use ← and →, and **INCREASE DIGIT**
/ **DECREASE DIGIT**, to set the time.

AUX FUNCTION		[TIME & DATE]
CLOCK MODE		[SET-UP]
TIME		[1 :50: 0]
DATE		[11-SEP-90]

STATUS:
DECREASE DIGIT INCREASE DIGIT ← →

To Start the Clock at the Selected Time

Highlight **CLOCK MODE** [**0**].

Select **RUN**.

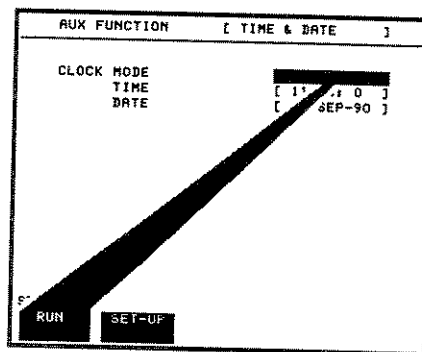

To Indicate Stored Set-Up Content

The display area beside the setting number may be used to give the set-up a title or to leave a message for a future user. The title / message may be set remotely using a terminal connected to the RS 232 connector (see the “Remote Operation” chapter) or manually as follows :

Highlight LOCK [**L**].

Select **OFF**.

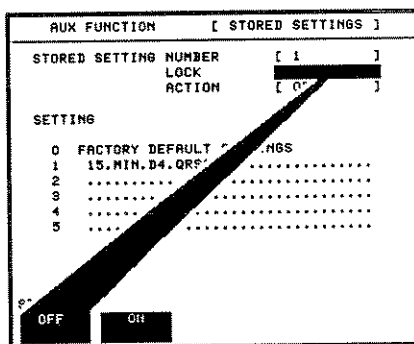

Highlight the SETTING description line N [**1**].

Use **JUMP PREVIOUS CHAR NEXT CHAR** and **←** and **→** to select characters.

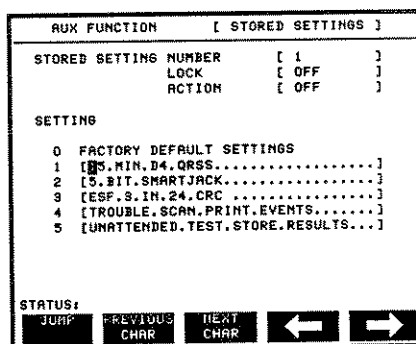

To prevent overwriting without changing LOCK.

Highlight LOCK [**L**].

Select **ON**.

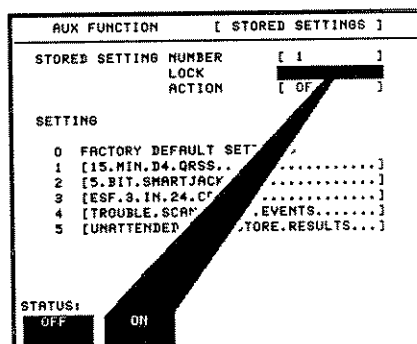



T1 Testing

How to Find Set-Up Examples

The diagram below shows the organization of the information in this chapter. The page numbers lead you to set-up examples.

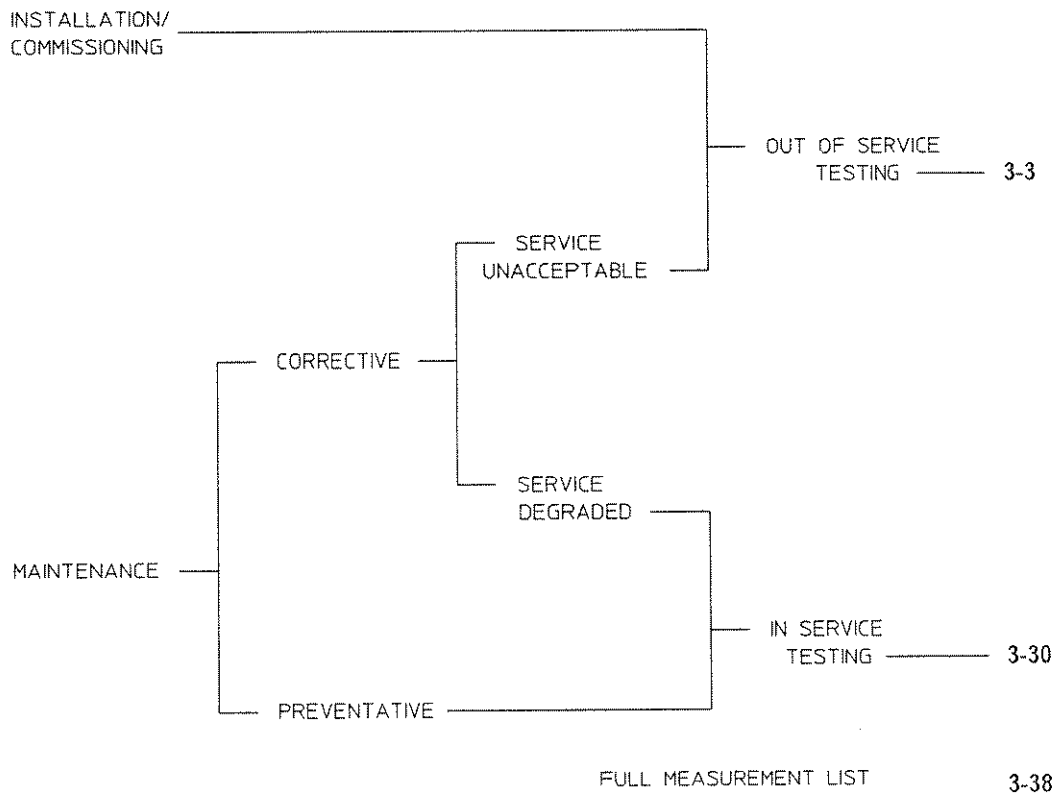

How a T1 System is Shown in This Manual

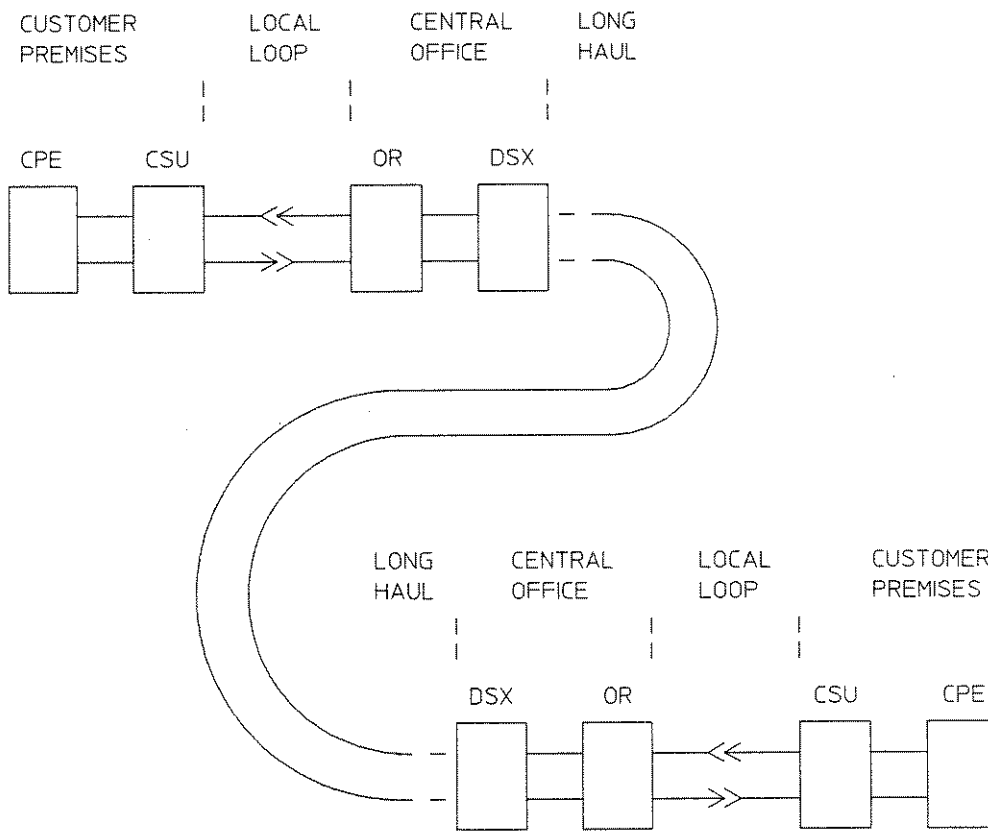

Key

- CPE = Customer Premises Equipment
- CSU = Channel Service Unit
- << = Repeated, metallic, local loop showing direction of path
- OR = Office Repeater
- DSX = Cross Connect

3-2 T1 Testing

Out Of Service Testing

- 1 Here you can :
- Use the instrument as a CSU
 - Measure : Frequency
 - Simplex Current
 - Level (to set LBO)
 - Errors (part of loop from generating Tester)
 - Alarms
 - Pulse shape

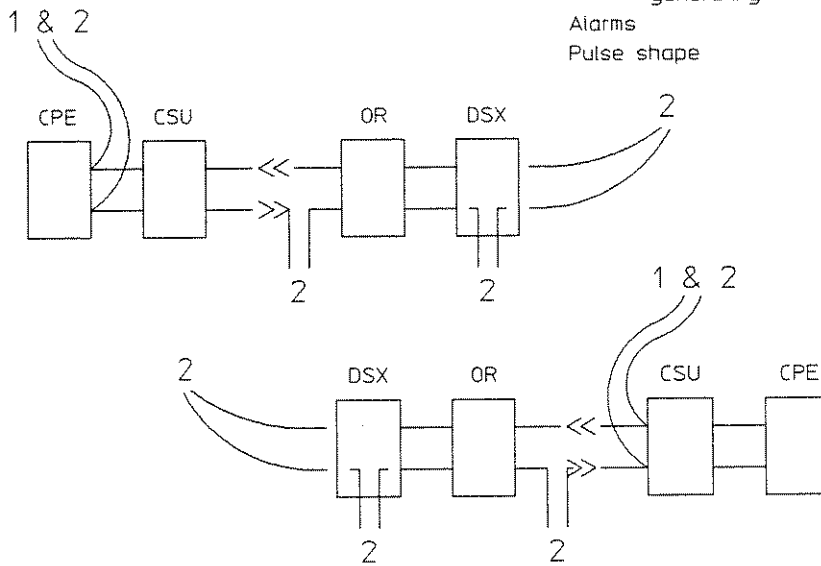

- 2 Here you can :
- Loop up remote CSUs
 - Generate the test pattern
 - Measure : Errors (both paths)
 - Delay (round loop)
 - Alarms
 - Pulse shape
 - Loop down remote CSUs

To Set the Terminated (TERM) T1 Line Interface

Out-of-service tests, including use as a portable CSU, usually require the T1 tester to terminate the T1 line. The TERM interface provides a 100Ω termination at the receiver input. The **Loopback** facility may be used to complete the signal path if required.

Warning



T1 Line voltages are capable of supplying dangerous currents. Power should be removed from the local loop while the T1 tester is being connected or disconnected.

Use **INTERFACE** to set T1 INTERFACE to **TERM**

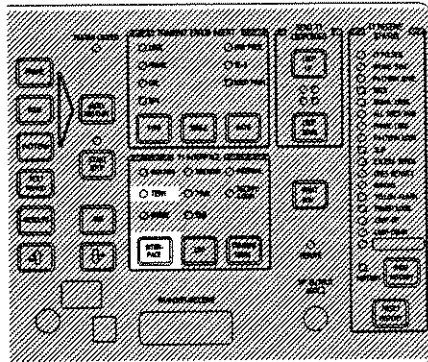

To Connect the T1 Tester to the T1 Line

Have the line power disconnected,
Connect the T1 tester to the T1 interface
and have the power reconnected.

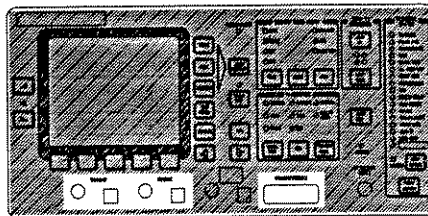

To Set The Transmit Timing

Use T1 INTERFACE **TRANSMIT TIMING**

To select the transmit timing.

If you have to be the source of timing select INTERNAL, otherwise select RECOV'D (LOOP).

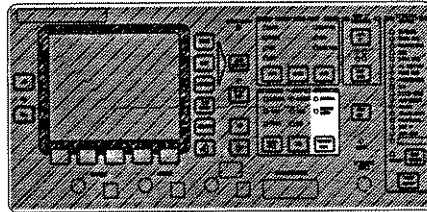

To Use As A Portable CSU / Network Interface

You can make tests on the received data while you are using the T1 tester as a CSU / network interface.

You can loop the T1 tester manually OR set it to loop when it receives a loopcode.

To Loop the T1 Tester Manually

Press **AUX**.

Select **ALARMS & LOOPING**.

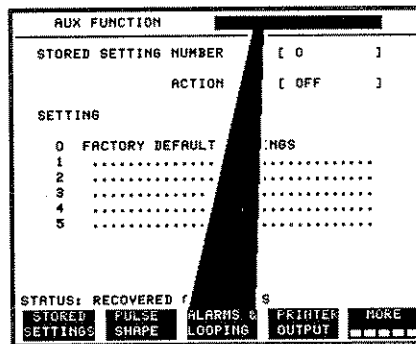

Highlight TESTER LOOPED [].
Select **UP**.

AUX FUNCTION		[ALARMS & LOOPING]
USER PROGRAM ERROR RATE	[1E-3]	
ALARM GENERATION	[OFF]	
<u>LOOPCODES</u>	TYPE (IN-BAND)[LINE (CSU)]	
	LOOP UP	10000
	LOOP DOWN	100
	FRAMING	[INSERTED]
	AUTO RESPONSE	[OFF]
	TESTER LOOPED	<input checked="" type="checkbox"/> UP
STATUS:		
<input type="checkbox"/> DOWN	<input type="checkbox"/> UP	

To Set the T1 Tester to Respond to a Loopcode (In-Band)

Press **AUX**.

Select **ALARMS & LOOPING**.

AUX FUNCTION	
STORED SETTING NUMBER	[0]
ACTION	[OFF]
SETTING	
0	FACTORY DEFAULT
1
2
3
4
5
STATUS: RECOVERED	
STOKER SETTINGS	FALSE SHAPE
ALARMS & LOOPING	PRINTER OUTPUT
	NULL

Highlight **LOOPCODES TYPE []**, then select what you want the T1 Tester to respond to.

If ESF framing is being used, then ensure **[IN-BAND]** is selected.

AUX FUNCTION [ALARMS & LOOPING]	
USER PROGRAM ERROR RATE	[1E-9]
ALARM GENERATION	[OFF]
LOOPCODES	TYPE (IN-BAND) [LINE (CSU)]
	LOOP UP 10000
	LOOP DOWN 100
FRAMING	[INSERTED]
AUTO RESPONSE	[OFF]
TESTER LOOPED	[DOWN]
STATUS:	
LINE (CSU)	4-BIT SMARTJACK
	8-BIT SMARTJACK
	USER PROGRAM

Highlight AUTO RESPONSE [**ON**].
Select **ON**.

AUX FUNCTION		[ALARMS & LOOPING]	
USER PROGRAM ERROR RATE	[1E-3]		
ALARM GENERATION	[OFF]		
<u>LOOPCODES</u>	TYPE (IN-BAND) [LINE (CSU)]		
	LOOP UP	10000	
	LOOP DOWN	100	
FRAMING	[INSERTED]		
AUTO RESPONSE	[ON]		
TESTER LOOPED	[DOWN]		
STATUS:			
	OFF	ON	

Highlight TESTER LOOPED [**DOWN**].
Select **DOWN**.

AUX FUNCTION		[ALARMS & LOOPING]	
USER PROGRAM ERROR RATE	[1E-3]		
ALARM GENERATION	[OFF]		
<u>LOOPCODES</u>	TYPE (IN-BAND) [LINE (CSU)]		
	LOOP UP	10000	
	LOOP DOWN	100	
FRAMING	[INSERTED]		
AUTO RESPONSE	[OFF]		
TESTER LOOPED	[DOWN]		
STATUS:			
	DOWN	UP	

To Set the T1 Tester to Respond to a Loopcode (Out-of-Band)

Out-of-band loopcodes are only available with ESF framing.

Press **AUX**.

Select **ALARMS & LOOPING**.

```
AUX FUNCTION
-----
STORED SETTING NUMBER [ 0 ]
ACTION [ OFF ]

SETTING
0 FACTORY DEFAULT SETTINGS
1 .....
2 .....
3 .....
4 .....
5 .....

STATUS: RECOVERED FROM LOSS OF SIGNAL
STORED SETTINGS  PULSE ALARMS & LOOPING  PRINTER MORE
SETTINGS SHAPE LOOPING OUTPUT
```

Highlight **LOOPCODES TYPE []**,
then select **[OUT-BAND]**.

```
AUX FUNCTION [ALARMS & LOOPING]
-----
USER PROGRAM ERROR RATE [ 1E-9 ]
ALARM GENERATION [ OFF ]

LOOPCODES TYPE [OUT-BAND] [ LINE (CSU) ]
LOOP UP 00001110 11111111
LOOP DOWN 00111000 11111111

AUTO RESPONSE [ OFF ]

TESTER LINE LOOPED [ DOWN ]
TESTER PAYLOAD LOOPED [ DOWN ]

STATUS:
IN-BAND OUT-OF-BAND
```

Select the code you want the T1 Tester to respond to: **[LINE (CSU)]**, **[PAYLOAD (CSU)]** or **[SMARTJACK]**.

```

AUX FUNCTION      [ALARMS & LOOPING ]
-----
USER PROGRAM ERROR RATE [ 1E-9      ]
ALARM GENERATION    [ OFF          ]
-----
LOOPCODES  TYPE  [OUT-BAND][LINE (CSU)]
LOOP UP    00001110 11111111
LOOP DOWN  00111000 11111111

AUTO RESPONSE [ OFF      ]

TESTER LINE LOOPED [ DOWN ]
TESTER PAYLOAD LOOPED [ DOWN ]

STATUS:
LINE (CSU)  PAYLOAD (CSU)  SMART-
           JACK
  
```

Highlight **AUTO RESPONSE []**.
Select **ON**.

```

AUX FUNCTION      [ALARMS & LOOPING ]
-----
USER PROGRAM ERROR RATE [ 1E-9      ]
ALARM GENERATION    [ OFF          ]
-----
LOOPCODES  TYPE  [OUT-BAND][LINE (CSU)]
LOOP UP    00001110 11111111
LOOP DOWN  00111000 11111111

AUTO RESPONSE [ ON      ]

TESTER LINE LOOPED [ DOWN ]
TESTER PAYLOAD LOOPED [ DOWN ]

STATUS:
OFF  ON
  
```

Highlight **TESTER LINE LOOPED []** and **TESTER PAYLOAD LOOPED []**.
Select **DOWN** for each.

```

AUX FUNCTION      [ALARMS & LOOPING ]
-----
USER PROGRAM ERROR RATE [ 1E-9      ]
ALARM GENERATION    [ OFF          ]
-----
LOOPCODES  TYPE  [OUT-BAND][LINE (CSU)]
LOOP UP    00001110 11111111
LOOP DOWN  00111000 11111111

AUTO RESPONSE [ ON      ]

TESTER LINE LOOPED [ DOWN ]
TESTER PAYLOAD LOOPED [ DOWN ]

STATUS:
DOWN UP
  
```

To Make Fractional T1 (n × 56 / n × 64 kBit/s) Tests

A T1 Tester with the optional Fractional T1 capability is required.

Press **RESULTS**.

Highlight the fractional or full T1 selection

Select **N × 56k** or **N × 64k**.

RESULTS	FRAME [D4]	CODE [B82S]
PATTERN [QRSS]		
TEST PERIOD [CONTINUOUS]		
DISPLAY [ERROR RESULTS]	[LOGIC]	
[ALL RESULTS]	[STORE OFF]	
ES		2
EFS		6675
%EFS		99.970%
ERRORS		2
AVERAGE ER		2.0E-10
CURRENT ER		0
ELAPSED TIME 00d 01h 51m 17s		
STATUS:		
FULL-T1	Nx56k	Nx64k

Select the frame,code and pattern you want.

Highlight TRANSMIT [**2¹⁵-1**], and select the timeslots you want to spread the selected pattern over.

The example shows a 2¹⁵-1 PRBS transmitted in a 192kBit/s Intermediate Bit Rate (IBR) in timeslots 1, 2, and 3.

[Nx64k]	FRAME [D4]	CODE [B82S]
PATTERN [2¹⁵-1]		
TRANSMIT [***]	TS04	
TEST PERIOD [CONTINUOUS]		
DISPLAY [ERROR RESULTS]	[LOGIC]	
[ALL RESULTS]	[STORE OFF]	
[AS TRANSMITTER]		
ES		0
EFS		75
%EFS		100.000%
ERRORS		1
AVERAGE ER		0
CURRENT ER		0
ELAPSED TIME 00d 00h 01m 20s		
STATUS:		
DESELECT	SELECT	RESELECT
	←	→

To set the receive timeslots for 1:1 mapping select **AS TRANSMIT**.

To define your own receive timeslots select **RECEIVE**.

```

[ N*64k ] FRAME [ D4 ] CODE [ BQZS ]
PATTERN [ 2*15-1 ]
TRANSMIT [ ***..... ] 192kb/s
TEST PERIOD [ CONTINUOUS ]

DISPLAY [ ERROR RESULTS ] [ LOGIC ]
[ ALL RESULTS ] [ STORE OFF ]
[ AS TRANSMIT ]

ES          0
EFS         51
XEPS       100.000%
ERRORS      0
AVERAGE ER 0
CURRENT ER  0

STATUS: ELAPSED TIME 00d 00h 00m 51s
[ AS TRANSMIT ]
  
```

Highlight **RECEIVE** [**RECEIVE**], and select the timeslots that contain the incoming IBR.

The example shows the selection of timeslots 13, 14, and 15.

If results storage or graphs of results are required, start the test by selecting the storage resolution.

```

[ N*64k ] FRAME [ D4 ] CODE [ BQZS ]
PATTERN [ 2*15-1 ]
TRANSMIT [ ***..... ] 192kb/s
TEST PERIOD [ CONTINUOUS ]

DISPLAY [ ERROR RESULTS ] [ LOGIC ]
[ ALL RESULTS ] [ STORE OFF ]
[ RECEIVE ] [ .....***..... ]

ES          ****
EFS         ****
XEPS       ****%
ERRORS      ****
AVERAGE ER ****
CURRENT ER  ****

STATUS: ELAPSED TIME 00d 00h 01m 20s
[ DESELECT ] [ SELECT ] [ DESELECT ]
[ ..... ] [ * ] [ ALL ] [ ← ] [ → ]
  
```

To Transmit Errors and Alarms

You may insert errors by introducing changes into the transmitted pattern.

You may introduce the yellow alarm into the transmitted pattern.

You may replace the transmitted pattern with unframed all 1's.

To Transmit Errors

You may chose the type of error and the error rate.

To Choose the Type of Error

Use **TYPE** to set the type of error you want to introduce.

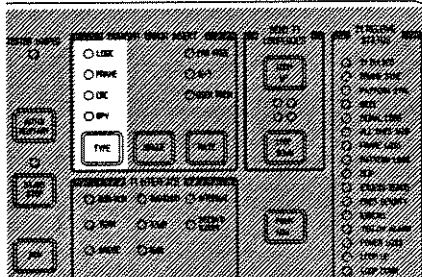

To Choose the Error Rate

You may choose:
To add errors singly .
To add errors at a fixed rate of $1E - 3$.
To select the error rate.

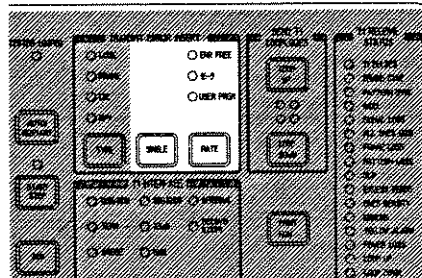

To Add Errors Singly

Use **RATE** to select ERR FREE.

Press **SINGLE** to insert an error.

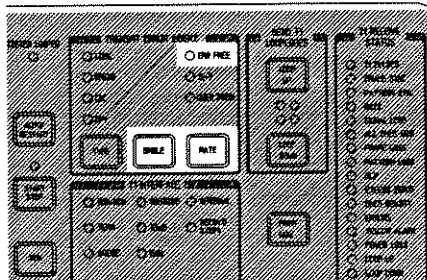

To Add Errors at a Fixed Rate of 1E - 3

Use **RATE** to select 1E - 3.

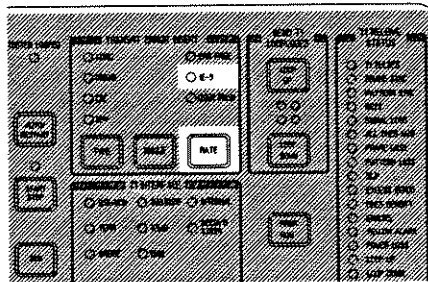

To Select an Error Rate

Use **RATE** to select USER PRGM.

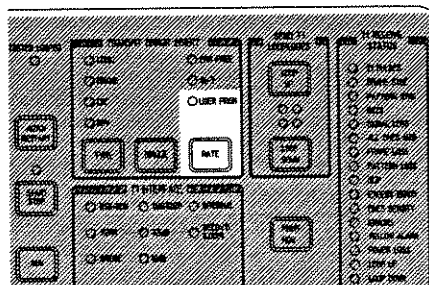

Press **AUX**.
 Select **ALARMS & LOOPING**.

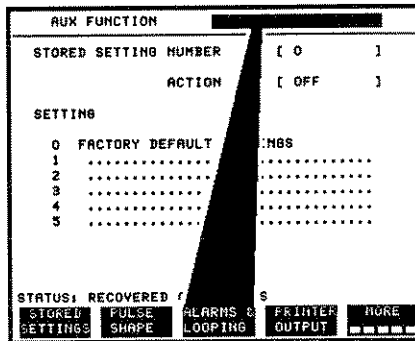

Highlight **USER PROGRAM ERROR RATE** [].

Select the rate **1E - 3**, **1E - 4**, **1E - 5**, **1E - 6** or **1E - 7**.

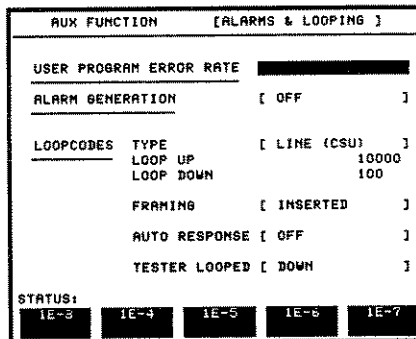

To Transmit Alarms

Press **AUX**.
 Select **ALARMS & LOOPING**.

```

AUX FUNCTION
-----
STORED SETTING NUMBER [ 0 ]
ACTION [ OFF ]

SETTINGS
0 FACTORY DEFAULT SETTINGS
1 .....
2 .....
3 .....
4 .....
5 .....

STATUS: RECOVERED
-----
STORED SETTING NUMBER [ 0 ]
PULSE SHAPE [ ]
ALARMS & LOOPING [ ]
PRINTER OUTPUT [ ]
BEEP [ ]
  
```

Highlight **ALARM GENERATION**
 [].
 Select the type of alarm you want.

```

AUX FUNCTION [ALARMS & LOOPING ]
-----
USER PROGRAM ERROR RATE [ 1E-8 ]
ALARM GENERATION
-----
LOOPCODES TYPE [ LINE (CSU) ]
LOOP UP 10000
LOOP DOWN 100
FRAMING [ INSERTED ]
AUTO RESPONSE [ OFF ]
TESTER LOOPED [ DOWN ]

STATUS:
OFF ALL ONES YELLOW
(AIS) ALARM
  
```

To Transmit and Monitor Signaling Bits

Press **RESULTS**.

Highlight PATTERN [**3-19-1**]

Select **SPECIAL**.

[FULL-T1]	FRAME [D4]	CODE [8825]
PATTERN	[3-19-1]	
TEST PERIOD [CONTINUOUS]		
DISPLAY	[ERROR RESULTS]	[LOGIC]
	[ALL RESULTS]	[STORE OFF]
ES	0	
EFS	88	
XEFS	100.000%	
ERRORS	1	
AVERAGE ER	0	
CURRENT ER	0	
ELAPSED TIME 00d 00h 01m 28s		
STATUS:		
2-19-1	2-20-1	2-23-1
	SPECIAL	MORE

Highlight PATTERN [SPECIAL] [**1**]

Select **SIG BIT TEST**.

[FULL-T1]	FRAME [D4]	CODE [8825]
PATTERN	[SPECIAL]	[LONG USER WORD]
TEST PERIOD [CONTINUOUS]		
DISPLAY	[ERROR RESULTS]	[LOGIC]
	[ALL RESULTS]	[STORE OFF]
ES	0	
EFS	70	
XEFS	100.000%	
ERRORS	0	
AVERAGE ER	0	
CURRENT ER	0	
ELAPSED TIME 00d 00h 01m 10s		
STATUS:		
LONG USE	SIG BIT	THRESHOLD
WORD	TEST	HIGH RES
	CHECK	RT DELAY

Select the test signaling bits A B (A B C D with ESF),the CHANNEL you want to send them in and the signalling bits to go in the OTHER channels.

This example shows the selection of 1 and 0 as A and B bits in channel 5 with 0 and 1 in the the other channels.

```
[FULL-T1] FRAME [ D4 ] CODE [ B82S]
PATTERN [ SPECIAL ] [ SIGNALING BIT TEST]
SEND AB [10]→CHANNEL [ 5] OTHERS [0]
DISPLAY SIGNALING BITS [ SINGLE ] [01]
MAPPING [ D3/D4]

Signaling bits in channel 01 (timeslot 1)

01

STATUS:
SET 0 SET 1 ← →
```

Highlight DISPLAY [SIGNALING BITS] []

To display signaling bits from one channel select SINGLE.

To display signaling bits from all channels select ALL.

```
[FULL-T1] FRAME [ D4 ] CODE [ B82S]
PATTERN [ SPECIAL ] [ SIGNALING BIT TEST]
SEND AB [10]→CHANNEL [ 5] OTHERS [01]
DISPLAY SIGNALING BITS [ ALL ]
MAPPING [ D3/D4]

Channels 1-24 signaling bits
AB AB AB AB
01 01 07 01 13 01 19 01
02 01 08 01 14 01 20 01
03 01 09 01 15 01 21 01
04 01 10 01 16 01 22 01
05 10 11 01 17 01 23 01
06 01 12 01 18 01 24 01

STATUS:
SINGLE ALL
```

Highlight MAPPING []

Select the channel / timeslot mapping for the system being tested.

```
[FULL-T1] FRAME [ D4 ] CODE [ B82S]
PATTERN [ SPECIAL ] [ SIGNALING BIT TEST]
SEND AB [10]→CHANNEL [ 5] OTHERS [01]
DISPLAY SIGNALING BITS [ ALL ]
MAPPING [ D3/D4]

Channels 1-24 signaling bits
AB AB AB AB
01 01 07 01 13 01 19 01
02 01 08 01 14 01 20 01
03 01 09 01 15 01 21 01
04 01 10 01 16 01 22 01
05 10 11 01 17 01 23 01
06 01 12 01 18 01 24 01

STATUS:
D1/D2 D3/D4
```

To Make Out-of-Service Tests at the Customer Premises

Level (for LBO setting), Current, Frequency and Pulse Shape

Press **TEST PERIOD** to recall the results display.

Select **CONTINUOUS**.

FRAME	[D4]	CODE	[B82S]
PATTERN	[QRSS]		
TEST PERIOD [REDACTED]			
DISPLAY	[ERROR RESULTS]	[LOGIC]	
	[ALI .SULTS]	[STORAGE OFF]	
ES		
SYNCHROUS		
EFS		
ZEFS	 %	
ERRORS		0	
AVERAF		0	
CURR		0	
ELAPSED TIME 00d 00h 00m 00s			
CONTIN	15	2	24
-UOUS	MINUTES	HOURS	HOURS
			USER PROGRAM

Press **AUTO/RESTART** to set FRAME, CODE and PATTERN to the incoming signal and start an error test.
 Highlight **DISPLAY** [**ALL RESULTS**].
 Select **SIGNAL RESULTS**.

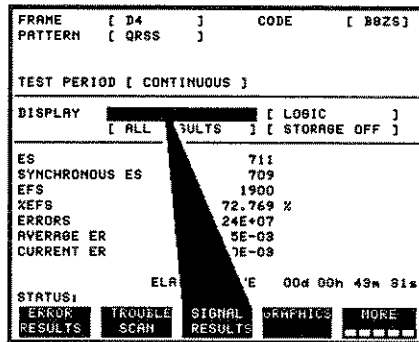

Use the measured RECEIVER LEVEL to set the T1 Tester transmit LBO.

For round trip delay measurement use the QRSS test pattern.

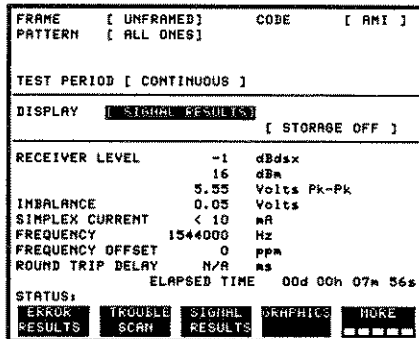

You can now check SIMPLEX CURRENT and FREQUENCY readings. Current is best checked with an all 1's (max current) pattern. Low current might indicate bad PSU's, bad wiring or a bad repeater. When the CSU or network interface is replaced or installed, its transmit output LBO should be set to the value you set on the T1 Tester to get the correct RECEIVER LEVEL.

If the T1 Tester has the optional Pulse Shape display facility
 Press **AUX**.

Select **PULSE SHAPE**.

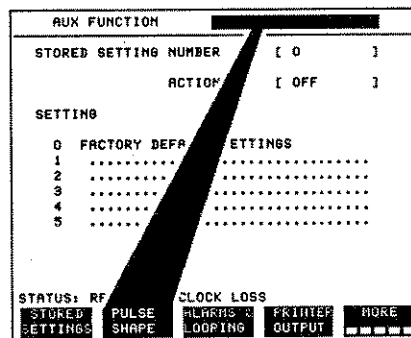

You can check that the received pulse meets the specified mask.

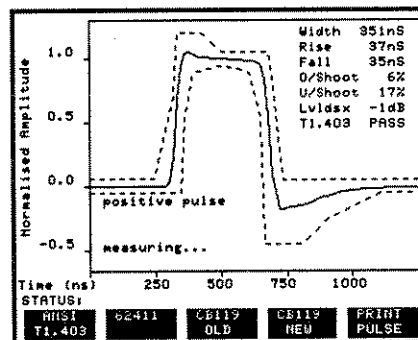

To Measure Round Trip Delay with Higher Resolution

A T1 tester with the fractional T1 capability is required.

Round trip delay is displayed as part of the signal test. A higher resolution display of round trip delay may be obtained as follows:

Press **RESULTS**.

Highlight **PATTERN** []

Select **SPECIAL**.

[FULL-T1]	FRAME [D4]	CODE [B82S]
PATTERN	[2 ¹⁵ -1]	
TEST PERIOD [CONTINUOUS]		
DISPLAY [ERROR RESULTS] [LOGIC]		
[ALL RESULTS] [STORE OFF]		
ES	0	
EFS	88	
%EFS	100.000%	
ERRORS	1	
AVERAGE ER	0	
CURRENT ER	0	
ELAPSED TIME 00d 00h 01m 28s		
STATUS:		
2 ¹⁵ -1	2 ²⁰ -1	2 ²³ -1
SPECIAL	NORE	

Highlight **PATTERN** [SPECIAL] []

Select **HIGH RES RT DELAY**.

[FULL-T1]	FRAME [D4]	CODE [B82S]
PATTERN	[SPECIAL]	[TIMESLOT CHECK]
DISPLAY TIMESLOT MAP [SINGLE] [01]		
Monitoring timeslot 01		
11000011		
STATUS:		
LONG USE	SIG BIT	TIMESLOT
WORD	TEST	CHECK
		HIGH RES
		RT DELAY

Select the transmit and receive timeslots .

[FULL-T1]	FRAME [D4]	CODE [B82S]
PATTERN	[SPECIAL]	[HIGH RES. RT DELAY]
ROUND TRIP DELAY TRANSMIT TIMESLOT [1]		
DISPLAY HIGH RESOLUTION ROUND TRIP DELAY		
RECEIVE TIMESLOT [SELECTED] [1]		
Round Trip Delay in test path		
14.975 ms		
STATUS:		
DECREASE	INCREASE	
DIGIT	DIGIT	← →

To Monitor Errors at the Customer Premises.

The T1 tester measures and stores all error types simultaneously. The display shows one selected type in "real time". The other types can be displayed at any time, during and after the test, up to the start of the next test. Results may also be stored for later reference.

Single path error tests are most useful as an aid to trouble location when making a looped test from the Central Office or the far end of the circuit with another T1 Tester.

With the T1 Tester at the customer premises looped and set up for the Level, Current and Frequency test (with SIGNAL RESULTS selected) the other results : ERROR RESULTS (ALL RESULTS or BASIC RESULTS), TROUBLE SCAN, ALARM SECONDS and SLIPS AND WANDER, apply to the path being received at the Customer Premises.

Just select a TEST PERIOD, press START STOP and select the error type that you want to DISPLAY in "real time".

Local loop Tests

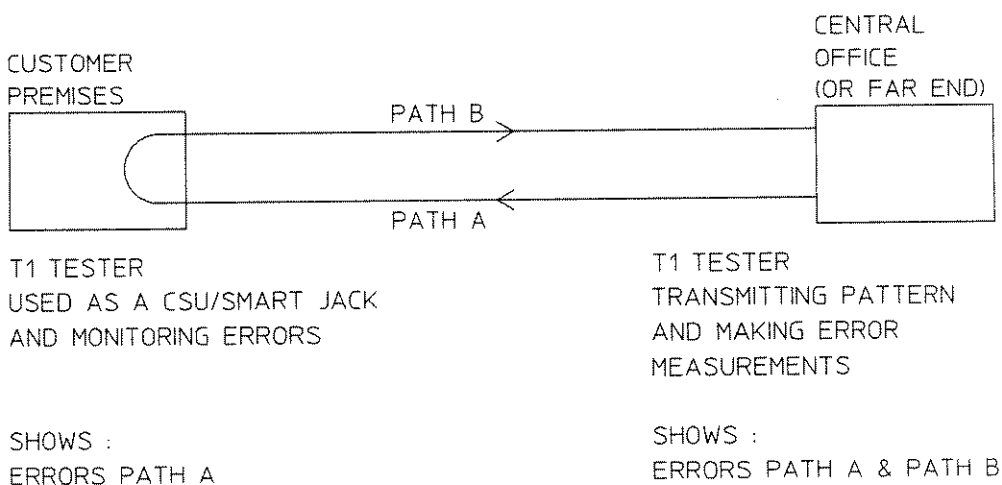

Out of Service Tests From the Central Office

You can make local loop, end to end and round trip loopback tests. Local loop tests are as shown with customer premises tests on page 3-14.

Two kinds of loopback are available when testing devices with ESF framing and out-of-band loopback.

1. LINE (CSU) Loopback - all bits in the T1 signal are retransmitted.
2. PAYLOAD (CSU) Loopback - only the customer data bits are retransmitted, framing and CRC bits are recalculated before being transmitted back to the T1 Tester.

Using both loopbacks help isolate the fault to either the *go* or *return* path of the T1 circuit.

End-to-End and Round Trip Loopback Tests

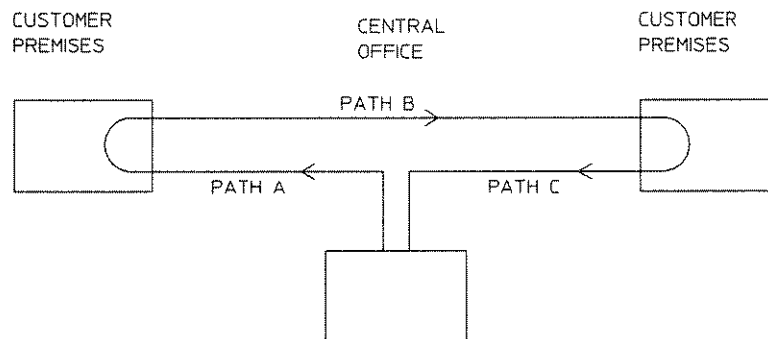

T1 TESTER BEING USED AS A CSU/ SMART JACK AND MONITORING ERRORS

SHOWS :
ERRORS PATH A

T1 TESTER TRANSMITTING PATTERN AND MAKING ERROR MEASUREMENTS

SHOWS :
ERRORS PATH A,
PATH B & PATH C

T1 TESTER BEING USED AS A CSU/ SMART JACK AND MONITORING ERRORS

SHOWS :
ERRORS PATH A
AND PATH B

To Loop the CSU, Network Interface, or T1 Tester at the Customer Premises using an In-Band Loopcode

The loop can be set manually at the customer premises. Alternatively, the loopcode can be sent from the T1 tester at the Central Office using the following procedure.

Press **AUX**.

Select **ALARMS & LOOPING**.

AUX FUNCTION	
STORED SETTING NUMBER	[0]
ACTION	[OFF]
SETTING	
0	FACTORY DEFAULT :NGS
1
2
3
4
5
STATUS: RECOVERED	
STORED SETTINGS	PULSE SHAPE
ALARMS & LOOPING	PRINTER OUTPUT

Highlight **LOOPCODES TYPE [1]**.

Select the loopcode that the far end CSU, Smartjack or T1 tester will respond to.

If ESF framing is being used, ensure the **LOOPCODE TYPE** is set to **[IN-BAND]**.

AUX FUNCTION		[ALARMS & LOOPING]
USER PROGRAM ERROR RATE	[1E-8]	
ALARM GENERATION	[OFF]	
LOOPCODES	TYPE (IN-BAND)	[LINE (CSU)]
	LOOP UP	10000
	LOOP DOWN	100
FRAMING	[INSERTED]	
AUTO RESPONSE	[OFF]	
TESTER LOOPED	[DOWN]	
STATUS:		
LINE (CSU)	4-BIT SMARTJACK	5-BIT SMARTJACK
	USER PROGRAM	

Highlight AUTO RESPONSE [**OFF**].
 Select **OFF**.

AUX FUNCTION		[ALARMS & LOOPING]
USER PROGRAM ERROR RATE	[1E-8]]
ALARM GENERATION	[OFF]]
LOOPCODES	TYPE (IN-BAND)[LINE (CSU)]	
	LOOP UP	10000
	LOOP DOWN	100
FRAMING	[INSERTED]	
AUTO RESPONSE	[OFF]]
TESTER LOOPED	[DOWN]]
STATUS:		
	OFF	ON

Highlight TESTER LOOPED [**DOWN**].
 Select **DOWN**.

AUX FUNCTION		[ALARMS & LOOPING]
USER PROGRAM ERROR RATE	[1E-8]]
ALARM GENERATION	[OFF]]
LOOPCODES	TYPE (IN-BAND)[LINE (CSU)]	
	LOOP UP	10000
	LOOP DOWN	100
FRAMING	[INSERTED]	
AUTO RESPONSE	[OFF]]
TESTER LOOPED	[DOWN]]
STATUS:		
	DOWN	UP

To send the loop code.
 Press **LOOP UP**.
 For round trip loopback tests you may
 need to press **LOOP UP** twice.

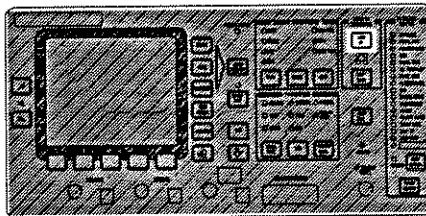

To Loop the CSU, Network Interface, or T1 Tester at the Customer Premises using an Out-of-Band Loopcode

Out-of-band loopcodes are only available with ESF framing.

The loop can be set manually at the customer premises. Alternatively, the loopcode can be sent from the T1 tester at the Central Office using the following procedure.

Press **AUX**.

Select **ALARMS & LOOPING**.

Highlight **LOOPCODES TYPE** [**OUT-BAND**],

then select **OUT-BAND**.

AUX FUNCTION		[ALARMS & LOOPING]	
USER PROGRAM ERROR RATE	[1E-3]	
ALARM GENERATION	[OFF]	
LOOPCODES	TYPE	[OUT-BAND]	[LINE (CSU)]
LOOP UP	00001110	11111111	
LOOP DOWN	00111000	11111111	
AUTO RESPONSE	[OFF]	
TESTER LINE LOOPED	[DOWN]	
TESTER PAYLOAD LOOPED	[DOWN]	
STATUS:			
OUT-BAND	OUT-OF-	BAND	

Select which loopback you want:

[LINE (CSU)], **[PAYLOAD (CSU)]** or

[SMARTJACK].

The LOOP UP and LOOP DOWN codes are shown on the display.

AUX FUNCTION		[ALARMS & LOOPING]	
USER PROGRAM ERROR RATE	[1E-3]	
ALARM GENERATION	[OFF]	
LOOPCODES	TYPE	[OUT-BAND]	[LINE (CSU)]
LOOP UP	00001110	11111111	
LOOP DOWN	00111000	11111111	
AUTO RESPONSE	[OFF]	
TESTER LINE LOOPED	[DOWN]	
TESTER PAYLOAD LOOPED	[DOWN]	
STATUS:			
LINE	PAYLOAD	SMART-	
(CSU)	(CSU)	JACK	

Highlight **AUTO RESPONSE** [**OFF**].
 Select **OFF**.

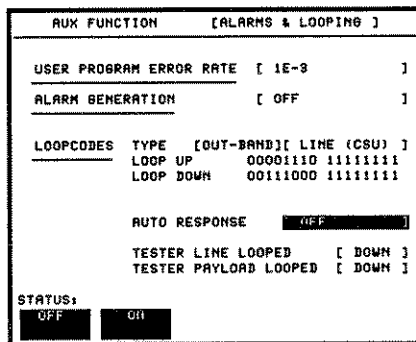

Highlight **TESTER LINE LOOPED** [**DOWN**] and **TESTER PAYLOAD LOOPED** [**DOWN**].
 Select **DOWN** for each.

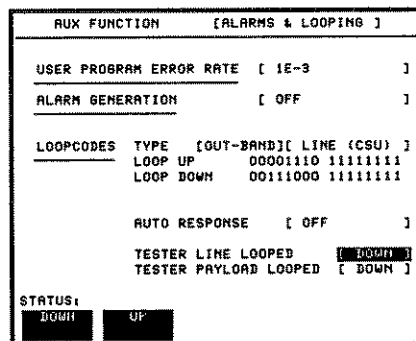

To send the loop code.
 Press **LOOP UP**.
 For round trip loopback tests you may need to press **LOOP UP** twice.

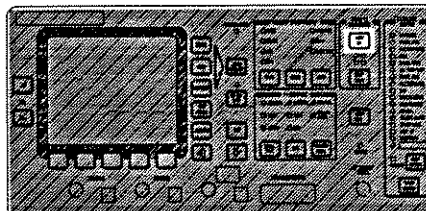

To Set-Up the T1 Tester for a Looped 15 Minute, QRSS, Logic Error Test

Press **FRAME**.
Select **ESF**, **D4**, **SLC96** or **UNFRAMED**.

Press **CODE**.
Select **AMI** or **B8ZS**.
Press **PATTERN**.
Select **QRSS**.
Press **TEST PERIOD**.
Select **15 MINUTES**.
Press **RESULTS**.
Select **DISPLAY**.
ERROR RESULTS LOGIC
BASIC RESULTS.

```
FRAME [ D4 ] CODE [ AMI ]
PATTERN [ QRSS ]

TEST PERIOD [ 15 MINUTES ]

DISPLAY [ ERROR RESULTS ] [ LOGIC ]
        [ BASIC RESULTS ] [ STORAGE OFF ]

ES                0
%EFS              100.000%
ERRORS            0
AVERAGE ER       0
ELAPSED TIME     00d 00h 00m 01s

STATUS:
ERROR RESULTS  TROUBLE SCAN  SIGNAL RESULTS  GRAPHICS  MORE
```

To Run the Test

Press **START STOP**.
The T1 Tester at the central office will display go and return path errors. If a T1 tester is used as a CSU / network interface at the customer premises, use **START STOP** on that T1 tester to display the single path (central office to customer premises) errors.
You can display the other results either during or after the test. The alternatives are : Frame Errors, BPVs and ESF CRC errors (individually or together in Trouble Scan), All (Error) Results, Signal Results, Alarm Seconds, Slips and Wander or Pulse Shape.

In-Service Testing

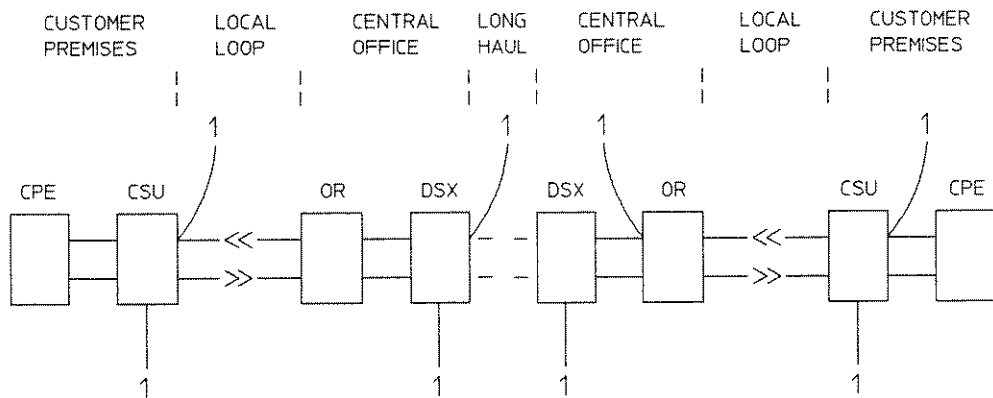

1 Here you can :
Monitor : Frequency
Level
Pulse shape
Errors
Alarms

To Set the Monitor Interface

You can set up to monitor at a protected monitor point (DSX-MON) or at an unprotected point (BRIDGE).

Warning



T1 Line voltages are capable of supplying dangerous currents. Power should be removed from the local loop while the T1 tester is being connected or disconnected. It is recommended that the T1 tester should be connected at a DSX-1 MON for in-service testing.

Use **INTERFACE** to set T1 INTERFACE to DSX-MON or BRIDGE.

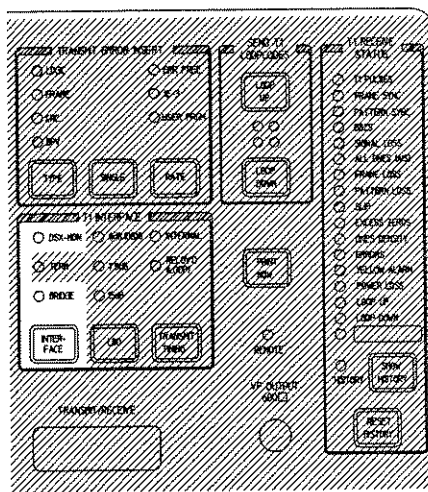

To Connect the T1 Tester for In-service Testing

Connect the T1 tester to the monitor point. As the signal is only being received for in-service tests, Transmitter timing selection is not necessary.

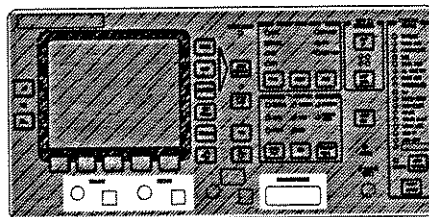

To Use the T1 Tester for Line Identification

The least intrusive method of line identification is to look for a known signal in one VF channel.

Press **AUTO/RESTART** to set the T1 tester to the incoming Frame, Code and Pattern and start an error test.

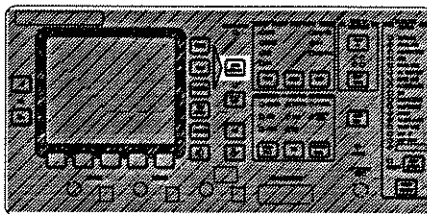

Press **AUX** and select **VF ACCESS**.

Highlight **MAPPING** and select **[D1D]**, **[D2]** or **[D3/D4]**.

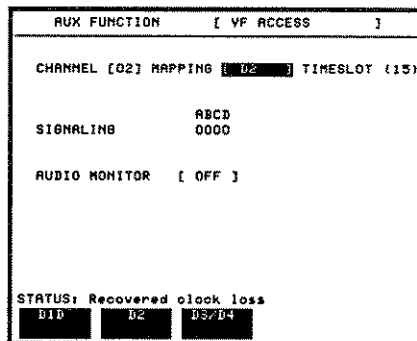

Highlight **CHANNEL []**.

Select channels using **◀ ▶** and **INCREASE DIGIT** or **DECREASE DIGIT** until the known VF signal is heard.

Mapping is automatic, as the channel setting is changed the timeslot reading on the display is automatically updated - you can see at a glance the channel-to-timeslot relationship.

Highlight **AUDIO MONITOR []**.

Select **ON**.

Use **▲ ▼** to adjust the volume.

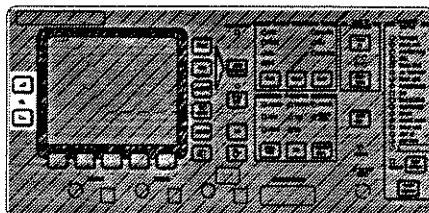

To Make In-Service Tests

To Monitor Circuit Performance

Level, Frequency and Pulse Shape

Press **TEST PERIOD** to recall the results display.

Select **CONTINUOUS**.

Press **AUTO/RESTART** to set FRAME, CODE and PATTERN to the incoming signal and start an error test.

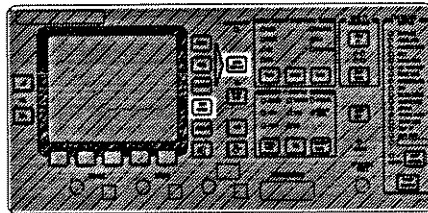

Highlight **DISPLAY** [**↓**].

Select **SIGNAL RESULTS**.

FRAME	[UNFRAMED]	CODE	[AMI]
PATTERN	[ALL ONES]		
TEST PERIOD [CONTINUOUS]			
DISPLAY	[STORAGE OFF]		
RECEIVER LEVEL	-1	dBdsx	
	16	dBm	
	5.55	Volts Pk-Pk	
IMBALANCE	.05	Volts	
SIMPLEX CURRENT	10	mA	
FREQUENCY	10	Hz	
FREQUENCY OFFSET	?	ppm	
ROUND TRIP DELAY	ms		
STATUS:	ELI	IE	00d 00h 07m 56s
ERRORS	TRUCELL	SIGNAL	GRAPHICS
RESULTS	SCAN	RESULTS	MORE

You can now check LEVEL, and FREQUENCY.

Level outside the expected range might indicate a wrongly set LBO, bad wiring, bad splices or a double terminated circuit.

High frequency offset might indicate serious equipment or configuration problems. For example, A faulty clock oscillator, or the terminals at each end of the circuit loop timed from each other.

If the T1 Tester has the optional Pulse Shape display facility

Press **AUX**.

Select **PULSE SHAPE**.

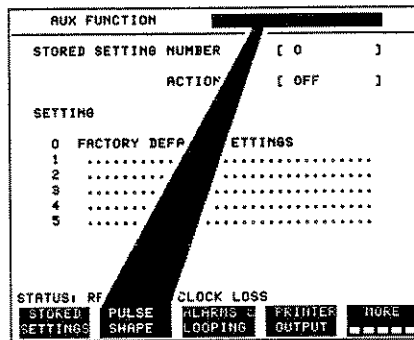

You can now look for gross distortions of the pulse shape. Remember that the pulse may be slightly distorted by :
The termination of the line.
The monitor point itself.

For testing against a mask, the T1 Tester has to terminate the line directly to avoid these distortions.

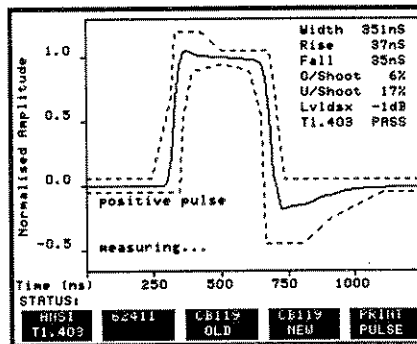

To Set-Up the T1 Tester to Monitor Errors

The T1 tester measures and stores all error types simultaneously. The display shows one selected type in “real time”. The other types can be displayed at any time, either during or after the test, up to the start of the next test. Results may also be stored for later reference.

Example, to Measure All Errors With Real Time Display of ESF CRC Errors.

Press **TEST PERIOD** to recall the results display.

Select **CONTINUOUS**.

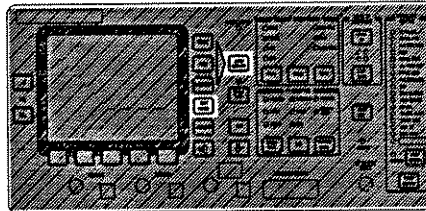

Press **AUTO/RESTART** to set FRAME, CODE and PATTERN to the incoming signal and start an error test.

Highlight **DISPLAY []**.

Select **ERROR RESULTS CRC**.

Highlight **[ERROR RESULTS] [CRC]**.

[]

Select **ALL RESULTS**.

FRAME	[ESF]	CODE	[AMI]
PATTERN	[QRSS]		
TEST PERIOD [15 MINUTES]			
DISPLAY	[ERROR RESULTS]	[CRC]	
	ALL RESULTS	[STORAGE OFF]	
ES	0		
ESFS	5		
XESFS	100.000	%	
ERRORS	0		
AVERAGE ER	0		
CURRENT ER	0		
		ELAPSED TIME	00d 00h 00m 05s
STATUS:			
BASIC RESULTS	ALL RESULTS	ANALYSIS	

To Monitor Timeslot Map/Content

A T1 Tester with the fractional T1 capability is required.

Press **RESULTS**.

Highlight **PATTERN** []

Select **SPECIAL**.

```
[FULL-T1] FRAME [ D4 ] CODE [ B82S ]
PATTERN [ 2 15-1 ]
TEST PERIOD [ CONTINUOUS ]
DISPLAY [ ERROR RESULTS ] [ LOGIC ]
[ ALL RESULTS ] [ STORE OFF ]
ES 0
EFS 88
XEFS 100.000%
ERRORS 1
AVERAGE ER 0
CURRENT ER 0
ELAPSED TIME 00d 00h 01m 28s
STATUS:
2 15-1 2 20-1 2 28-1 SPECIAL NORE
```

Highlight **PATTERN** [SPECIAL] []

Select **TIMESLOT CHECK**.

```
[FULL-T1] FRAME [ D4 ] CODE [ B82S ]
PATTERN [ SPECIAL ] [ TIMESLOT CHECK ]
DISPLAY TIMESLOT MAP [ SINGLE ] [ 01 ]
Monitoring timeslot 01
11000011
STATUS:
LONG USE 816 BIT TIMESLOT HIGH RES
MGRD TEST CHECK PT DELR
```

Highlight TIMESLOT MAP []

For a timeslot map select **ALL**.

```
[FULL-T1] FRAME [ D4 ] CODE [ B92S ]
PATTERN [ SPECIAL ] [ TIMESLOT CHECK ]

DISPLAY TIMESLOT MAP [ ALL ]

TS Bits  TS Bits  TS Bits  TS Bits
01 TS01  07 TS07  13 TS13  19 TS19
02 TS02  08 TS08  14 TS14  20 TS20
03 TS03  09 TS09  15 TS15  21 TS21
04 TS04  10 TS10  16 TS16  22 TS22
05 TS05  11 TS11  17 TS17  23 TS23
06 TS06  12 TS12  18 TS18  24 TS24

STATUS:
SINGLE  ALL
```

To monitor the content of a single timeslot select **SINGLE** highlight TIMESLOT MAP [SINGLE] [] and select the timeslot number.

```
[FULL-T1] FRAME [ D4 ] CODE [ B92S ]
PATTERN [ SPECIAL ] [ TIMESLOT CHECK ]

DISPLAY TIMESLOT MAP [ SINGLE ] [ ]

Monitoring timeslot 5

11001011

STATUS:
DECREASE INCREASE
Digit Digit ← →
```

Full Measurement List.

Error Measurements	Type Of Error			
	Logic	BPV	Frame	CRC (ESF)
Error count	*	*	*	*
Error ratio, average	*	*	*	*
Error ratio, current	*	*	*	*
Error seconds	*	*	*	*
Error free seconds	*	*		*
% error free seconds	*	*		*
Out of frame events			*	
Change of frame alignment events			*	
Frame loss seconds			*	
Loss of frame events			*	
Severely errored framing events			*	

Error Measurements	Type Of Error			
	Logic	BPV	Frame	CRC (ESF)
Unavailable seconds	*		*	*
% availability (unavailability)	*		*	*
Error seconds	*			*
Severely errored seconds	*		*	*
Degraded minutes	*			*
Consecutive severely errored seconds	*		*	*

Alarm Seconds

Power loss
Alarm indication seconds (<3 zeros in two consecutive frames)
Frame loss
Signal loss (175 consecutive zeros)
Yellow Alarm
 (D4 / SLC-96, zero in bit 2 of every timeslot)
 (ESF, data link contains repeated 1111111100000000)
Pattern loss
Ones density / Excess zeros (>15 zeros)

Signal Results

Frequency, absolute and offset from 1544000Hz
Received level, dBm or dBdsx
Simplex current, mA
Balance
Round trip delay

Slips and Wander

Out of service slips (pattern slips)
Clock slips (optional)

Pulse Shape (optional) access via AUX

Test Patterns

$2^{15}-1$ PRBS, $2^{20}-1$ PRBS, $2^{23}-1$ PRBS, QRSS, 3 in 24, ALL ONES, 1 in 8, 1 in 2, 55 octet, userword, live, special (see below).

SPECIAL PATTERNS : Long user word, Signaling bit test, Timeslot check, High resolution round trip delay, 404Hz tone*, 1004Hz tone*, 2804Hz tone*.

* available only with N × 64kBit/s.

Auxiliary Functions

Function	Selections
Pulse shape (optional)	T1.403, 62411, CB119 old, T1.102 / 119 new
Transmit functions	
Error insertion rate	10E-3, 10E-4, 10E-5, 10E-6, 10E-7
Alarm generation type	Off, Yellow, All ones (AIS)
Loopcode	
Mode	In band
Types	Line , 4-bit network interface 5-bit network interface User programmable (3 to 8 bits selectable) Loop up Loop down
Framing	Inserted, overwritten
Printer output	
Squelch	On, off
Print on demand	Current settings, results snapshot
Auto triggered print	Off, event results, every 15 minutes, every 2 hours, end of test, messages only
Stored settings	
Setting number	User selectable 1 to 5
Fixed setting	0
Title/message	User selectable

Function	Selections
Remote control	
RS-232 mode	Computer control, Terminal control, Hewlett Packard printer, Alternative printer (80 col or Condensed)
ENQ ACK	On, off
X on / X off	Off, Rx only, Tx only, Rx and Tx
Speed	300, 600, 1200, 1800, 2400. 4800, 9600 baud
7 bit data parity	0's, 1's, even, odd
Stop bits	1, 2
Time / date	
Real time clock	Run, set-up
Set-up	23 hours 59 minutes 59 seconds
Date	Day month year
VF access	
Channel	01 to 24
Signalling	A B C D
Audio monitor	On, off
Pulse shape result	
	Rise time, fall time, width, overshoot, undershoot, pass/fail Instantaneous wander, positive wander, negative wander, pk-pk wander

4

Displaying Test Results

The result display choices available are shown on the diagram below.
The page numbers lead you to set-up examples.

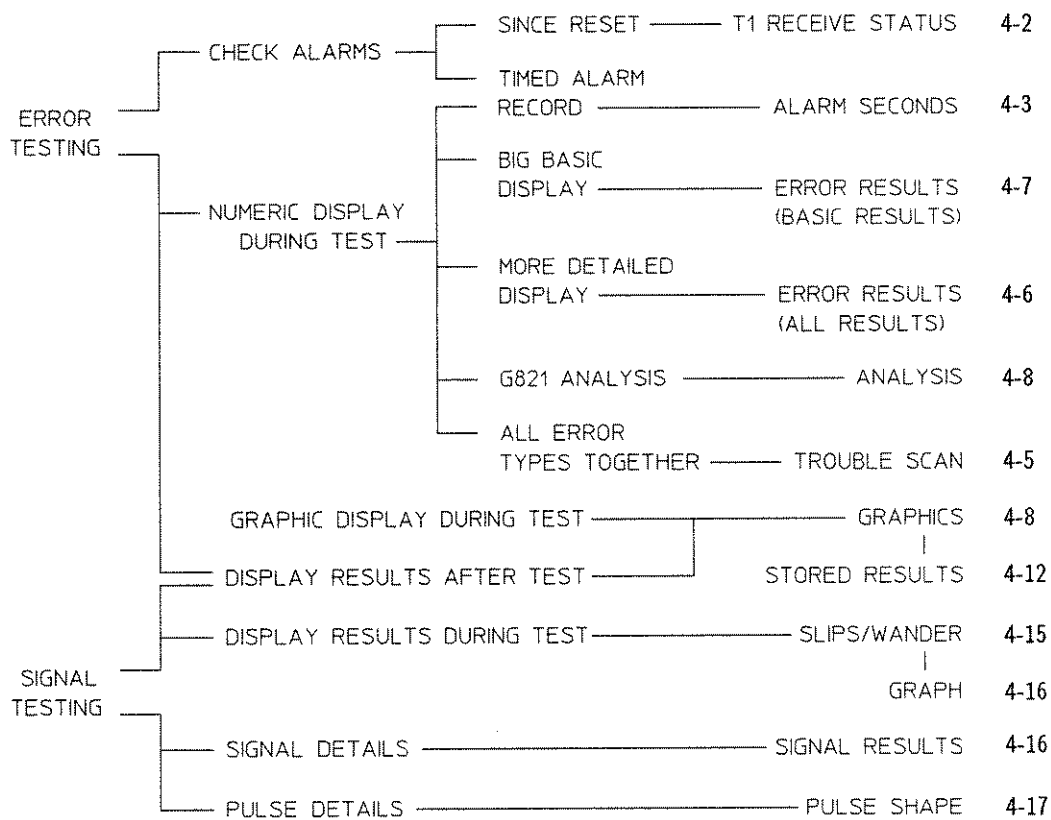

To Display Alarms

The current alarm conditions are always displayed when the T1 tester is connected to the T1 line.

One or more occurrences of an alarm during a test, since the last history reset, may be displayed at any time until the start of the next test.

A record of total alarm durations may be displayed during or after a test at any time until the start of the next test.

A graphic representation of alarms may be displayed by T1 testers with the graphics facility (see To Display Alarm And Error Graphs).

All alarm displays for previously stored results may be recalled on T1 testers with the storage facility (see To Display Stored Results).

A timed record of alarms may be obtained by triggering a printer output (see PRINTING).

To See the Current Alarm Conditions.

The current alarm conditions are always displayed on the T1 RECEIVE STATUS INDICATORS.

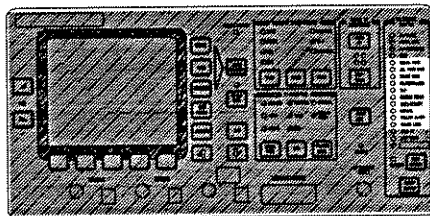

To See the Alarm History

You can run an unattended test and use alarm history to see if any alarms occurred while you were away.

The occurrence of alarms since the start of a test with **START STOP** / **AUTO/RESTART** or since a history reset during a test, is shown while **SHOW HISTORY** is held down.

To clear this record press **HISTORY RESET**.

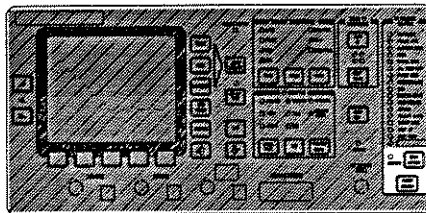

To See the Record of Total Alarm Durations.

This record is the total of each type of alarm since the start of the test. The record is reset at the start of each test. The results of ten tests are stored by T1 testers with the storage / graphics facility (see To Display Alarm and Error, Graphs) and (To Display Stored Results).

Press **RESULTS**.
Select **ALARM SECONDS**.

FRAME [D4]	CODE [882S]
PATTERN [QRSS]	
TEST PERIOD [CONTINUOUS]	
DISPLAY	[STORAGE OFF]
SIGNAL LOSS
ALL ONES (AIS)
FRAME LOSS
PATTERN LOSS
YELLOW ALARM
POWER LOSS
EXCESS ZERO
STATUS:	PSED TIME ..d ..h ..m ..s
SLIPS	ALARM SECONDS
WANDER	None

To Display Errors

When you run a test, all errors are measured and recorded. You chose how you want to display them. The display can be changed, at any time, during and after the test. The record is reset at the start of each test.

The results of ten tests are stored by T1 testers with the storage / graphics facility.

A timed record of result displays may be obtained by triggering a printer output (see PRINTING).

The choice of display at any one time is :

1. A display of the error count of each error type **TROUBLE SCAN**:
 - a. Logic Error Count.
 - b. BPV Count.
 - c. Frame Error Count.
 - d. CRC Error Count.
2. A display of the basic results of one error type in large characters (Logic, Frame, BPV or CRC) **BASIC RESULTS**:
 - a. Error Seconds.
 - b. %Error Free Seconds.
 - c. Error Count.
 - d. Average Error Rate.
3. A more detailed display of the results of one error type (Logic, Frame, BPV or CRC) **ALL RESULTS** This shows the basic results plus :
 - a. Synchronous Error Seconds.
 - b. Error Free Seconds.
 - c. Current Error Rate.
4. The G821 analysis of one error type (Logic, Frame or CRC) **ANALYSIS**.
5. Bar charts of error count updated at selected intervals during the test **GRAPH RESULTS** (see To Display Alarm and Error, Graphs).
6. A complete set of results for the previous ten tests in graphic and numeric form including G821 analysis (see To Display Stored Results).

To Select One of the Error Displays

Press **RESULTS**.

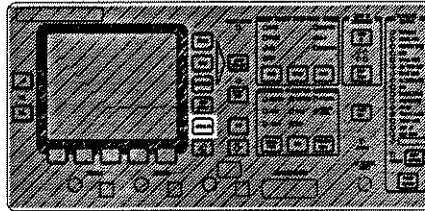

To Display the Error Count of Each Error Type

Select **TROUBLE SCAN**.

FRAME	[04]	CODE	[B825]
PATTERN	[QRSS]		
TEST PERIOD [CONTINUOUS]			
DISPLAY	[STORAGE OFF]		
LOGIC EC			9
BPV E			6
FRAME F			13
STATUS:		PSED TIME 00d 00h 31m 49s	
ERROR RESULTS	TROUBLE SCAN	SIGNAL RESULTS	GRAPHICS MORE

To Display Details of One Error Type

Select **ERROR RESULTS**.

```

FRAME [ D4 ] CODE [ B0ZS ]
PATTERN [ QRSS ]

TEST PERIOD [ CONTINUOUS ]

DISPLAY [ ALL RESULTS ] [ BPV ]
[ ALL RESULTS ] [ STORAGE OFF ]

ES .....
EFS .....
XEFS ..... X
ERRORS .....
AVERAGE .....
CURRENT .....

ELAPSED TIME ..d..h..m..s

ERROR RESULTS TRUBLE SCAN SIGNAL RESULTS GRAPHICS MORE
  
```

Highlight the Error Type and select the type of error you want to display.

```

FRAME [ ESF ] CODE [ B0ZS ]
PATTERN [ QRSS ]

TEST PERIOD [ CONTINUOUS ]

DISPLAY [ ERROR RESULTS ] [ BPV ]
[ ALL RESULTS ] [ STORAGE OFF ]

ES .....
SYNCHRONOUS ES .....
EFS .....
XEFS ..... X
ERRORS .....
AVERAGE ER .....
CURRENT ER .....

ELAPSED TIME ..d..h..m..s

STATUS:
LOGIC FRAME CRC BPV
  
```

For a Display of Basic Errors in Large Characters

Highlight
 DISPLAY [ERROR RESULTS] []
 [].

Select **BASIC RESULTS**.

FRAME	[ESF]	CODE	[882S]
PATTERN	[QRSS]		
TEST PERIOD [CONTINUOUS]			
DISPLAY	[ERROR RESULTS]	[LOGIC]	[]
		[STORAGE OFF]	
ES		
%EFS	%	
ERRORS		
AVERAGE ER		
	ELAPSED TIME	..d..h..m..s	
BASIC RESULTS	ALL RESULTS	ANALYSIS	

For a More Detailed Display of One Type Of Error

Highlight
 DISPLAY [ERROR RESULTS] []
 [].

Select **ALL RESULTS**.

FRAME	[D4]	CODE	[882S]
PATTERN	[QRSS]		
TEST PERIOD [CONTINUOUS]			
DISPLAY	[ERROR RESULTS]	[LOGIC]	[]
		[STORAGE OFF]	
ES		
SYNCHRONOUS ES		
EFS		
%EFS	%	
ERRORS		
AVERAGE ER		
CURRENT ER		
	ELAPSED TIME	..d..h..m..s	
STATUS:	ALL RESULTS	ANALYSIS	

For a G821 Analysis Display of One Type Of Error

The T1 Tester with the optional G821 Analysis facility is required.

Highlight
DISPLAY
[ERROR RESULTS] []
[]

Select **ANALYSIS**

FRAME	[D4]	CODE	[8829]
PATTERN	[QRSS]		
TEST PERIOD [CONTINUOUS]			
DISPLAY	[ERROR RESULTS]	[LOGIC]	
	[ANALYSIS]	[STORAGE OFF]	
G821 ANALYSIS			
XAVAILABILITY		 X
DEGRADED MINUTES X
SES X
ES X
CSES		
UNAVAILABLE SECONDS		
ELAPSED TIME ..d ..h ..m ..s			
STATUS:			
BASIC	ALL	ANALYSIS	
RESULTS	RESULTS		

To Display Alarm and Error Graphs

The T1 tester with the optional graphics facility is required.

During and after a test you can display :

A graphic representation of all alarms (in two sections) simultaneously, with a timescale.

A graphic representation of all types of error count, any two simultaneously, with a timescale.

Any combination of the above : one section of the alarm display with the count of one error type simultaneously.

The graphs make it easy to see how errors and alarms relate to each other and to time of day. Knowing the time pattern of errors often helps point to their cause.

The graphs are constructed from results stored at intervals selected before the test (1, 15 or 60 minutes). The displayed resolution is limited to the storage resolution.

4-8 Displaying Test Results

To Select One of the Graphic Displays

To display results as graphs, the test must be started by selecting a storage resolution.

Press **RESULTS**.

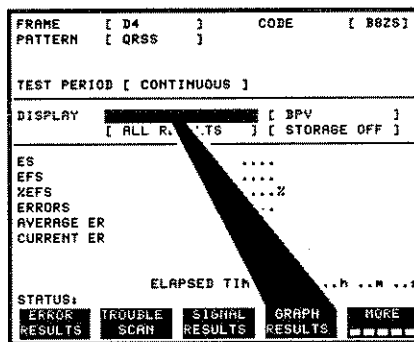

Select **GRAPH RESULTS**.

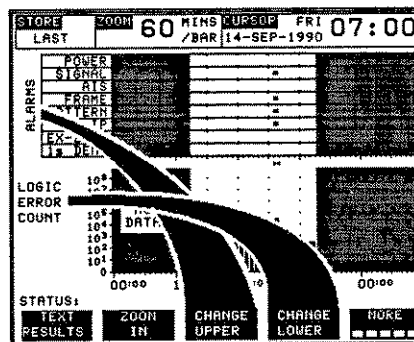

Select each of the two simultaneous displays with **CHANGE UPPER** and **CHANGE LOWER**.



To Select the Time "Window" and Resolution of the Graphic Display

Select the time "window" with  and 

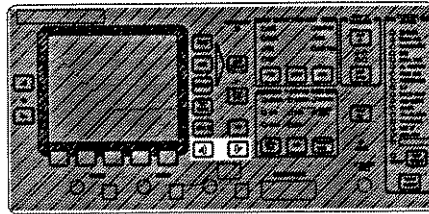

The start time of the cursor is shown in the CURSOR box.

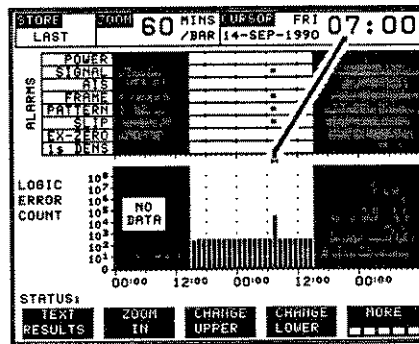

Select the resolution with **ZOOM IN**
ZOOM OUT.

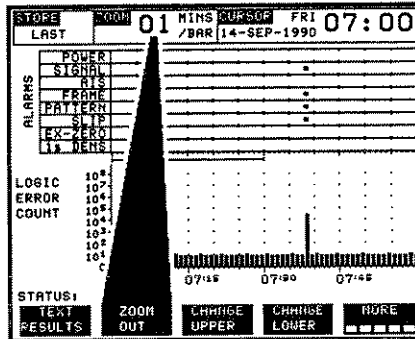

To Return to the Normal Measurement Display

Press **RESULTS**.

To Display Stored Results

The T1 tester with the optional Storage facility is required.

To display stored results, the test must have been started by selecting a storage resolution.

You can display the following details of previously stored tests :

- The settings used.
- The alarms.
- The errors and G821 analysis.
- The slips and wander.
- The alarms and error counts in graphical form.
- The test date and time.

You do not need to carry a printer a printer around. You can store the results and process them later.

To Display One of the Stored Results.

Press **RESULTS**.

Select **GRAPH RESULTS**.

FRAME	[D4]	CODE	[9829]
PATTERN	[QRSS]		
TEST PERIOD [CONTINUOUS]			
DISPLAY	[ALL R. TS]	[3PV]	[STORAGE OFF]
ES		
EFS		
XEFSX		
ERRORS	...		
AVERAGE ER			
CURRENT ER			
ELAPSED TIM ..h..m..s			
STATUS:			
ERROR RESULTS	PROBLE SERN	SIGNAL RESULTS	GRAPH RESULTS

Select **TEXT RESULTS**.

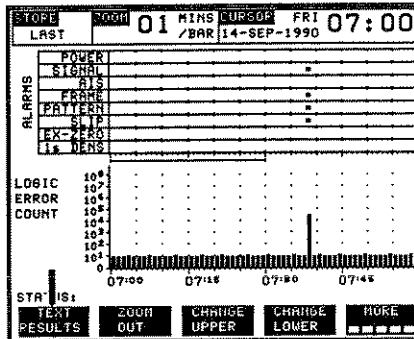

Select **STORE STATUS**.

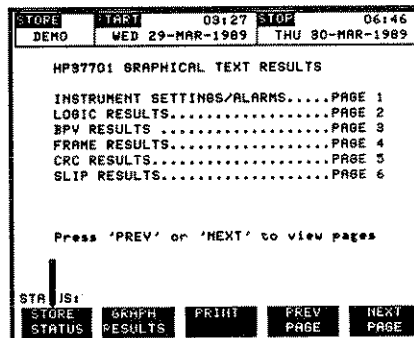

Use **←** and **↓** to highlight the test result you want to display.

Select **GRAPH RESULT** or **TEXT RESULT**.

STORE	START DATE	START TIME	TEST DURATION	STORE USE	
-9					
-8					
-7					
-6					
-5					
-4					
-3					
-2	10-SEP-1990	09:41	00d 21h 54m	82%	
-10	11-SEP-1990	16:26	00d 14h 35m	21%	
LAST	13-SEP-1990	08:26	00d 00h 16m	<1%	
TOTAL			USED	01d 12h 45m	54%
			FREE	01d 07h 31m	46%

STA S: **GRAPH RESULTS** **TEXT RESULTS** **DELETE STORE** **DELETE ALL**

Graphic Display - to Select Error Type or Alarms

see Page 4-9

Numeric Display - to Select Error Type, Alarms or Slips/Wander

Use **PREV PAGE** / **NEXT PAGE** to scroll through the displays.

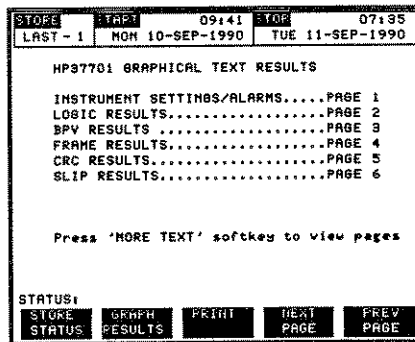

To Return to the Normal Measurement Display

Press **RESULTS**.

To Display Pattern Slips, Clock Slips and Wander

The T1 tester with the optional clock slips/wander facility is required for display of clock slips and wander.

The T1 tester needs a reference at the front panel TIMING REF DS1 INPUT for any clock slips/wander test.

You can display CLOCK SLIPS in graphical form at any time when the T1 tester is connected to the T1 line and has a timing reference.

PATTERN SLIPS and CLOCK SLIPS counts may be displayed, during or after a test at any time until the start of the next test.

WANDER analysis may be displayed, during or after a test at any time until the start of the next test.

The recorded total PATTERN SLIPS counts, CLOCK SLIPS counts and WANDER analysis, for each of the previous ten stored test results, may be displayed if a T1 tester with the optional clock slips/wander facility and the optional storage facility is used (see To Display Stored Results Page xx).

To Select One of the Slips/wander Displays

Press **RESULTS**.

Select **SLIPS** or **Slips/wander** depending on facilities available.

FRAME	[D4]	CODE	[B82S]
PATTERN	[QRSS]		
TEST PERIOD [CONTINUOUS]			
DISPLAY	[LOGIC]		
	[BASIC]	[RESULTS]	[STORAGE ON]
ES			0
%EFS			100.000%
ERRC			0
AVERAGE ER			0
ELAPSED TIME 00d 00h 15m 19s			
SLIPS/WANDER	ALARM SECONDS		NONE

For T1 Testers with the Clock Slips/Wander Facility.

Highlight

[SLIPS /WANDER] [].

Select **SLIPS** **WANDER** or **GRAPH**.

FRAME [D4]	CODE [B92S]
PATTERN [QRSS]	
TEST PERIOD [CONTINUOUS]	
DISPLAY [SLIPS/WANDER]	[STORAGE OFF]
UNCONTROLLED SLIPS (COFA)	0
CONTROLLED SLIPS	0
ESTIMATED FRAME SLIPS	NO REF
ESTIMATED BIT SLIPS	NO REF BITS
ELAPSED TIME 00d 00h 15m 19s	
STATUS:	
SLIPS	WANDER GRAPH

You can quickly see timing differences between two T1 signals with the high resolution of the slips graph feature.

To Display Signal Results

Signal results may be displayed at any time when the T1 tester is connected to a T1 line. Round trip delay is displayed when the QRSS pattern is selected. For high resolution round trip delay see chapter 3.

Press **RESULTS**.

Select **SIGNAL RESULTS**.

FRAME [UNFRAMED]	CODE [AMI]
PATTERN [ALL ONES]	
TEST PERIOD [CONTINUOUS]	
DISPLAY	[STORAGE OFF]
RECEIVER LEVEL	-1 dBdx
	16 dBm
	5.55 Volts Pk-Pk
IMBALANCE	.05 Volts
SIMPLEX CURRENT	10 mA
FREQUENCY	10 Hz
FREQUENCY OFFSET	PPM
ROUND TRIP DELAY	ms
STATUS:	
ERROR	TROUBLE SIGNAL GRAPHICS MORE
RESULTS	SCAN RESULTS RESULTS

4-16 Displaying Test Results

To Display Pulse Shape

The T1 tester with the optional pulse shape facility is required.
Pulse Shape may be displayed at any time when the T1 tester is connected to a T1 line.

Press **AUX** .
Select **PULSE SHAPE**.

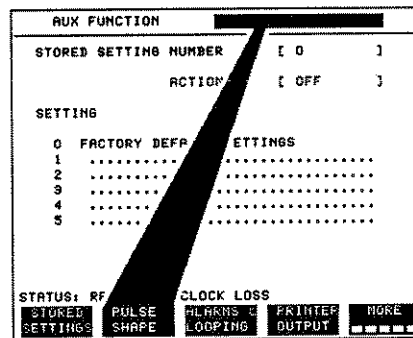

To Change the Pulse Mask

Select **T1.403**, **62411**, **CB119 OLD**
or **T1.102/119 NEW**.

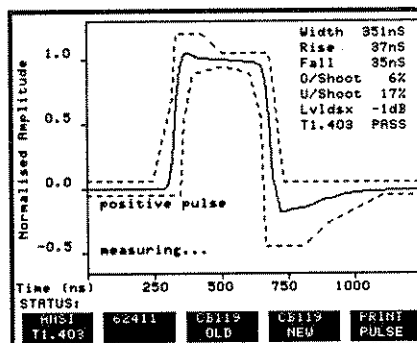

To Return to the Normal Measurement Display

Press **RESULTS**.

Preparing To Print Results.

Printing is enabled by selecting the one of the printing functions of the RS232 connector.

The T1 tester can be set to provide an RS232 output to any one of three types of printer:

1. Any Hewlett - Packard 80 column printer (recommended type HP2225D).
2. An alternative type which may be:
 - a. Any other 80 column printer.
 - b. A 40 column printer which is capable of handling 80 column condensed format.

Cabling information is given in the Installation chapter of this manual.

To Select a Printer Output.

An output suitable for the printer being used, must be selected before any print operation can be performed.

To Select an Output Suitable for a Hewlett - Packard 80 Column Printer.

Press **AUX**.

Select **PRINTER REM CTL**.

AUX FUNCTION	
STORED SETTING NUMBER]
ACTION	OFF]
SETTING	
0	FACTORY DEFAULT SETTINGS
1
2
3
4
5
STATUS:	
ANALYSIS THRESH	PRINTER REM CTL
TIME & DATE	VF ACCESS
MORE	

Highlight **RS232 MODE []**.

Select **HP PRINTER**.

AUX FUNCTION [PRINTER/REM CTL]	
RS232 MODE	
PROTOCOL	[XON/X]
SPEED	[9600 BUD]
PARITY (8 BIT DATA)	[]
STOP BITS	[]
Error number	
STATUS:	
COMPUTER CONTROL	TERMINAL CONTROL
HP PRINTER	ALT. PRINTER

Example Set-Up Using a Hewlett-Packard Thinkjet Printer, Model 2225D.

To make the printer and T1 tester compatible, the switches on the rear panel of the printer, MODE and RS-232C, and the settings on the T1 tester AUX, PRINTER / REMOTE CONTROL display must be compatible. The following example gives one set of compatible settings and the information necessary to select alternatives.

Printer

Printer MODE and RS-232C Settings

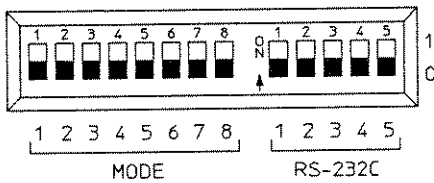

The MODE switches :

- 1,2 and 5 = 0 : for all interfaces.
- 3 = 0 : no perforation skip.
- 4 = 0 : 11 inch paper length.
- 4 = 1 for 12 inch.
- 6, 7 and 8 = 0 : ROMAN characters.

The RS 232C switches :

- 1 = 0 : XON/XOFF.
- 1 = 1 for DTR set.
- 2,3 = 0 : parity none / 8 bit data .
- 2,3 = 0,1 odd / 7 bit data,
- 2,3 = 1,0 even / 7 bit data,
- 2,3 = 1,1 one / 7 bit data.
- 4,5 = 0 : 9600 baud.
- 4,5 = 0,1 19200 baud,
- 4,5 = 1,0 2400 baud,
- 4,5 = 1,1 1200 baud.

T1 Tester

Compatible T1 Tester AUX PRINTER / REM CTL display.

AUX FUNCTION	[PRINTER/REM CTL]
RS232 MODE	[HP PRINTER]
PROTOCOL	[XON/XOFF]
SPEED	[9600 BAUD]
PARITY (8 BIT DATA)	[NONE]
STOP BITS	[1]
Error number	+0
STATUS:	
COMPUTER CONTROL	TERMINAL CONTROL
HP PRINTER	RLT PRINTER

To Select an Output Suitable for an Alternative Printer.

Press **AUX**.

Select **PRINTER REM CTL**.

```

AUX FUNCTION
-----
STORED SETTING NUMBER      ]
ACTION                     ]
OFF                         ]

SETTING
0  FACTORY DEFAULT        INBS
1  .....
2  .....
3  .....
4  .....
5  .....

STATUS:
ANALYSIS  PRINTER/  TIME &  VF  MORE
THRESH    REM CTL  DATE    ACCESS  .....
  
```

Highlight
RS232 MODE [.....].

Select **ALT. PRINTER**.

```

AUX FUNCTION  [ PRINTER/REM CTL ]
-----
RS232 MODE    [.....]
PROTOCOL      [ XON/XO ]
SPEED         [ 9600 ]
PARITY (8 BIT DATA) ( NONE )
STOP BITS     [ 1 ]

Error number

STATUS:
COMPUTER  TERMINAL  HP  ALT.
CONTROL   CONTROL  PRINTER PRINTER
  
```

Highlight PRINT STYLE [.....].

For an 80 column printer select **NORMAL**.

For a 40 column Printer select **COMPRESS**.

Set the PROTOCOL, SPEED, PARITY
and STOP BITS to be compatible with
the printer being used.

```

AUX FUNCTION  [ PRINTER/REM CTL ]
-----
RS232 MODE    [ ALT. PRINTER ]
PROTOCOL      ( DTR )
PRINT STYLE    [.....]
SPEED         [ 5 BAUD ]
PARITY (8 BIT DATA) ( NONE )
STOP BITS     ( 1 )

Error number

STATUS:
COMPRESS  NORMAL
  
```

5-4 Preparing To Print Results.

6

Printing Results

Before printing results, an RS232 output, suitable for the printer being used, must be selected (**AUX** - **PRINTER REM CTL**). Selection details are given in Chapter 5, Preparing to Print Results.

The following printer outputs are available:

Print	Availability
Major alarms only.	Automatically triggered
Alarms and Error count.	Automatically triggered. For previous tests as graphs *
Signal details.	The existing signal details at any time.
Full results.	Automatically triggered. At any time up to the start of the next test. For previous tests in tabular form *
Pulse shape.	The existing pulse shape at any time *.
Full T1 tester settings.	The existing settings at any time.

* Availability depends on T1 tester option.

Selections may be changed during a test.

Print on demand is available while auto triggered print is in use.

To Print Only the Occurrence of Major Alarms.

The date, time and state of the following alarms are printed when any of them occur or clear:

- Power loss
- Signal loss
- All ones
- Frame loss
- Pattern loss

Press **AUX**.

Select **PRINTER OUTPUT**.

```
AUX FUNCTION
-----
STORED SETTING NUMBER [ 0 ]
ACTION [ OFF ]
SETTING
0 FACTORY DEFAULT SETTINGS
1 .....
2 .....
3 .....
4 .....
5 .....
STATUS: RECOVERED CLOCK LOSS
STORED SETTING  PULSE ALARMS  PRINTER  MORE
SETTINGS  SHAPE  LOOPING  OUTPUT  [ ]
```

Highlight
AUTO TRIGGERED PRINT [].

Select **MESSAGES ONLY**.

```
AUX FUNCTION [ PRINTER OUTPUT ]
-----
SQUELCH [ OFF ]
PRINT ON DEMAND [ CURRENT SETTINGS ]
AUTO TRIGGERED PRINT
-----
STATUS:
END OF MESSAGES  MORE
TEST  ONLY  [ ]
```

To Suppress Printing After 10 Consecutive Seconds with Major Alarms.

Press **AUX**.

Select **PRINTER OUTPUT**.

AUX FUNCTION	
STORED SETTING NUMBER	[0]
ACTION	[OFF]
SETTING	
0	FACTORY DEFAULT SETTINGS
1
2
3
4
5
STATUS: RECOVERED CLOCK LOSE	
STORED SETTINGS	PULSE SHAPE
ALARMS LOOPING	PRINTER OUTPUT
	NONE

Highlight **SQUELCH** [].

Select **ON**.

Printing is restored after 2 error free seconds.

AUX FUNCTION [PRINTER OUTPUT]	
SQUELCH	
PRINT ON DEMAND	[PRESENT SETTINGS]
AUTO TRIGGERED PRINT	[OFF]
STATUS:	
OFF	ON

To Print Only Alarms and Error Count

The following choices are available:

1. An automatically triggered print of the test being run.
2. A print in graphical form of a stored result if the T1 tester has the optional storage facility.
 - a. Between the end of a test and the start of the next test.
 - b. For any of the previously stored test results.

To Automatically Trigger a Print of Alarms and Error Count.

Press **(AUX)**.

Select **PRINTER OUTPUT**.

```
AUX FUNCTION
-----
STORED SETTING NUMBER [ 0 ]
                        ACTION [ OFF ]

SETTING
0 FACTORY DEFAULT SETTINGS
1 .....
2 .....
3 .....
4 .....
5 .....

STATUS: RECOVERED CLOCK LOSE
        STORED PULSE ALARMS C
SETTINGS SHAPE LOOPING PRINTER MORE
                        OUTPUT
```

Highlight
AUTO TRIGGERED PRINT [].

Select **EVENT RESULTS**.

```
AUX FUNCTION [ PRINTER OUTPUT ]
-----
SQUELCH [ OFF ]
PRINT ON DEMAND [ CURRENT SETTINGS ]
AUTO TRIGGERED PRINT
-----
STATUS: OFF
        EVENT EVERY EVERY MORE
RESULTS 15 MINS 2 HOURS
```

To Suppress Printing After 10 Consecutive Seconds with EVENT Results

Press **AUX**.

Select **PRINTER OUTPUT**.

AUX FUNCTION []

STORED SETTING NUMBER [0]

ACTION [OFF]

SETTING

0 FACTORY DEFAULT SETTINGS

1

2

3

4

5

STATUS: RECOVERED CLOCK LOSS

STORED SETTINGS FULSE ALARMS & PRINTING PRINTER OUTPUT MORE

Detailed description: This is a terminal-style screenshot of a menu. At the top, 'AUX FUNCTION' is followed by a cursor. Below are 'STORED SETTING NUMBER [0]' and 'ACTION [OFF]'. A 'SETTING' section lists options 0 through 5. Option 0 is 'FACTORY DEFAULT SETTINGS', while 1-5 are represented by dotted lines. At the bottom, a 'STATUS' line reads 'RECOVERED CLOCK LOSS'. A row of menu items includes 'STORED SETTINGS', 'FULSE', 'ALARMS & PRINTING', 'PRINTER OUTPUT' (which is highlighted with a thick black bar), and 'MORE'.

Highlight **SQUELCH []**.

Select **ON**.

Printing is restored after 2 error free seconds.

AUX FUNCTION [PRINTER OUTPUT]

SQUELCH

PRINT ON DEMAND [CURRENT SETTINGS]

AUTO TRIGGERED PRINT [OFF]

STATUS: OFF ON

Detailed description: This is a terminal-style screenshot of a sub-menu. The title is 'AUX FUNCTION [PRINTER OUTPUT]'. It contains three options: 'SQUELCH', 'PRINT ON DEMAND [CURRENT SETTINGS]', and 'AUTO TRIGGERED PRINT [OFF]'. A thick black bar highlights the 'SQUELCH' option. At the bottom, a 'STATUS' line shows 'OFF' and 'ON' with a cursor positioned over 'ON'.

To Print Graphs of Alarms and Error Count.

The T1 tester with the optional graphics facility is required.

What you get is what you see plus alarms.

The general procedure is:

Get the result of the test as a graphic display.

Select the pair of error result graphs to be printed.

Select the time period and resolution.

Press **PRINT**.

Three graphs are printed. The two selected plus a graph of ten alarms (all except Loop up / loop down).

If alarms are displayed an additional graph will be printed.

Results of live traffic, frame off, tests produce only the two valid graphs, BPV errors and alarms.

NOTE : The test must have been started by selecting a storage resolution.

Press **RESULTS**.

Select **GRAPH RESULTS**.

FRAME	[D4]	CODE	[882S]
PATTERN	[QRSS]		
TEST PERIOD [CONTINUOUS]			
DISPLAY	[ALL RESULTS]	[BPV]	[STORAGE OFF]
ES		
EFS		
XEFS		%
ERRORS			..
AVERAGE ER			
CURRENT ER			
ELAPSED TIME ..h ..m ..s			
STATUS:			
ERROR RESULTS	TROUBLE SCAN	SIGNAL RESULTS	GRAPH RESULTS
			NOISE

Select **TEXT RESULTS**.

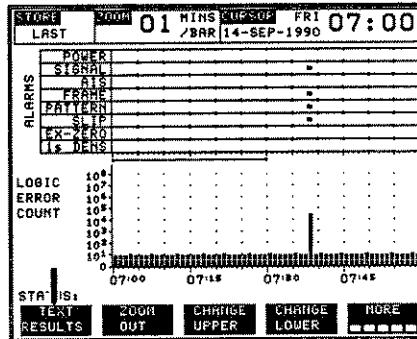

Select **STORE STATUS**.

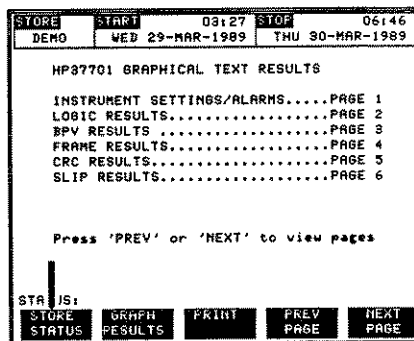

Use **←** and **↓** to highlight the test result to be printed.

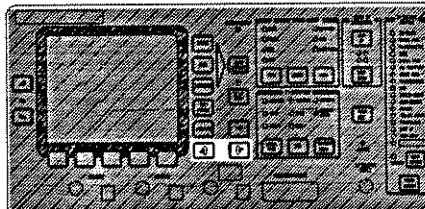

Select **GRAPH RESULTS**.

STAGE	START DATE	START TIME	TEST DURATION	% STORE USE
-9				
-8				
-7				
-6				
-5				
-4				
-3				
-2	10-SEP-1990	09:41	00d 21h 54m	32%
-1	11-SEP-1990	16:26	00d 14h 35m	21%
LAST	13-SEP-1990	08:26	00d 00h 16m	<1%
TOTAL		USED	01d 12h 45m	54%
		FREE	01d 07h 31m	46%



STA S:

GRAPH RESULTS TEXT DELETE DELET

RESULTS STORE ALL

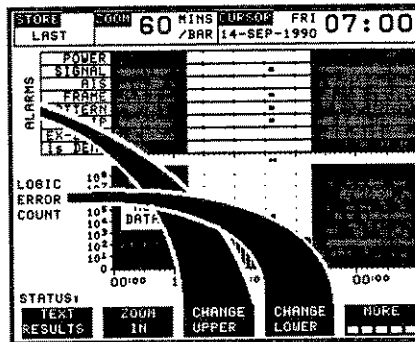
Display the graphs to be printed by selecting **CHANGE UPPER** and **CHANGE LOWER**.



Select the time "window" with  and .

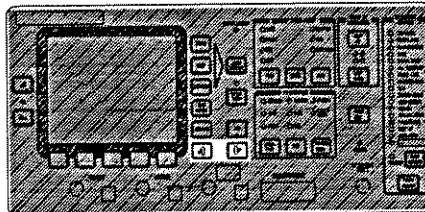

Select the resolution with **ZOOM IN**
ZOOM OUT.

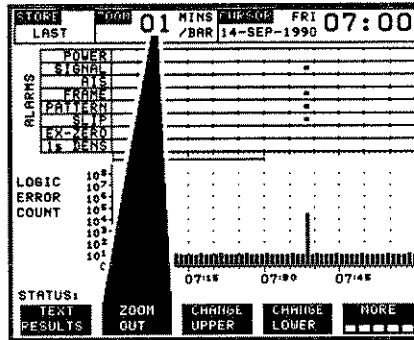

Select **PRINT**.

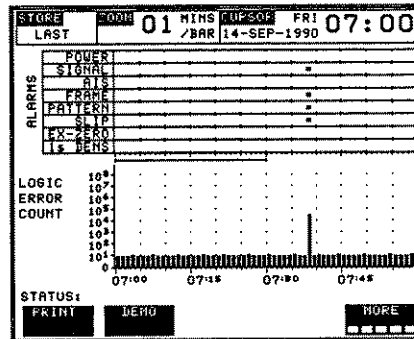

To Print Signal Details

Signal details may be printed on demand during a test.

The signal details are printed as part of a full results print, see the following information on "To Print Full Results".

To Print Full Results

The following choices are available:

1. An automatically triggered print at time intervals or at the end of the test.
2. A print on demand during or after a test, up to the start of the next test.
3. A print in tabular form of a stored result.

To Automatically Trigger a Print of Full Results.

Press **AUX**.

Select **PRINTER OUTPUT**.

```
AUX FUNCTION
-----
STORED SETTING NUMBER [ 0 ]
                        ACTION [ OFF ]

SETTINGS
0  FACTORY DEFAULT SETTINGS
1  .....
2  .....
3  .....
4  .....
5  .....

STATUS: RECOVERED CLOCK LOSS
STORED  PULSE  ALARMS  PRINTER  MORE
SETTINGS SHAPE  LOOPING OUTPUT
```

Highlight

AUTO TRIGGERED PRINT [**OFF**].

Select how often you want to print.

The following choices are available:

- Every 15 minutes **EVERY 15 MIN**.
- Every 2 hours **EVERY 2 HOURS**.
- At the end of the test **END OF TEST**.

```
AUX FUNCTION [ PRINTER OUTPUT ]
-----
SQUELCH [ OFF ]
PRINT ON DEMAND [ CURRENT SETTINGS ]
AUTO TRIGGERED PRINT [ OFF ]

STATUS:
OFF  EVENT  EVERY  EVERY  MORE
RESULTS 15 MINS 2 HOURS
```

To Print Full Results On Demand

The present state of the test may be printed during a test. In this case the analysis, although printed, may not be meaningful. The full results may be printed at any time after a test up to the start of the next test.

Press **AUX**.

Select **PRINTER OUTPUT**.

AUX FUNCTION

STORED SETTING NUMBER [0]

ACTION [OFF]

SETTING

0 FACTORY DEFAULT SETTINGS

1

2

3

4

5

STATUS: RECOVERED CLOCK LOSS

STORED SETTINGS FULSE ALARMS & PRINTER MORE

SHAPE LOOPING OUTPUT

Highlight **PRINT ON DEMAND []**.

Select **RESULTS SNAPSHOT**.

AUX FUNCTION [PRINTER OUTPUT]

SQUELCH [OFF]

PRINT ON DEMAND

AUTO TRIGGERED PRINT [OFF]

STATUS:

CURRENT RESULTS

SETTINGS SNAPSHOT

Press **PRINT NOW**.

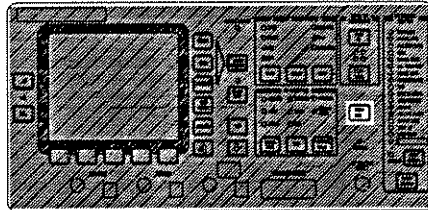

To Print the Stored Results of a Previous Test

The T1 tester with the optional results storage facility is required.

Press **RESULTS**.
Select **GRAPH RESULTS**.

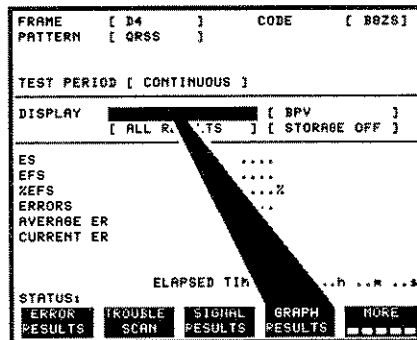

Select **TEXT RESULTS**.

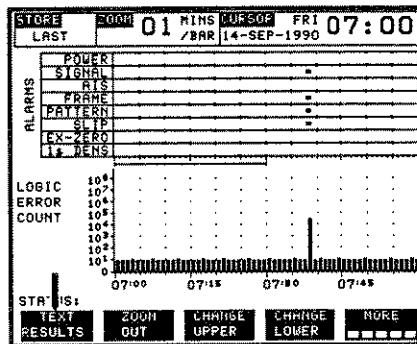

Select **STORE STATUS**.

STORE	START	STOP
DEMO	WED 29-MAR-1989	THU 30-MAR-1989

03:27 06:46



HP87701 GRAPHICAL TEXT RESULTS

INSTRUMENT SETTINGS/ALARMS.....PAGE 1
 LOGIC RESULTS.....PAGE 2
 BPV RESULTS.....PAGE 3
 FRAME RESULTS.....PAGE 4
 CRC RESULTS.....PAGE 5
 SLIP RESULTS.....PAGE 6

Press 'PREV' or 'NEXT' to view pages

STATUS:

STORE STATUS	GRAPH RESULTS	PRINT	PREV PAGE	NEXT PAGE
--------------	---------------	-------	-----------	-----------

Use  and  to highlight the test result to be printed.

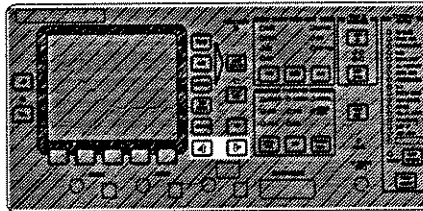

Select **TEXT RESULT**.

STORE	START DATE	START TIME	TEST DURATION	STORE USE
-9				
-8				
-7				
-6				
-5				
-4				
-3				
-2	10-SEP-1990	09:41	00d 21h 54m	32%
-1B	11-SEP-1990	16:26	00d 14h 35m	21%
LAST	18-SEP-1990	08:26	00d 00h 16m	<1%
TOTAL		USED	01d 12h 45m	54%
		FREE	01d 07h 31m	46%

STATUS:

GRAPH RESULTS	TEXT RESULTS	DELETE STORE	DELETE ALL
---------------	--------------	--------------	------------

Select **PRINT**.

STORE	START	10:53	STOP	11:43
LAST	TUE 28-MAR-1989		TUE 28-MAR-1989	

STORED SETTINGS PAGE 1 OF 6

FRAMING : D4 INTERFACE : DSX-MON
CODE : B8Z8 LBO : 0.0 dB
PATTERN : QR6S

ALARM SECONDS DURATIONS

POWER LOSS	0	FRAME LOSS	2
SIGNAL LOSS	1	YELLOW ALARM	0
RIS	0	PATTERN LOSS	2
EXCESS ZEROS	0		

STATUS:

STORE	GRAPH	PRINT	NEXT	PREV
STATUS	RESULTS		PAGE	PAGE

To Print the Pulse Shape

The pulse shape may be printed at any time during a test.

Press **AUX**.

Select **PULSE SHAPE**.

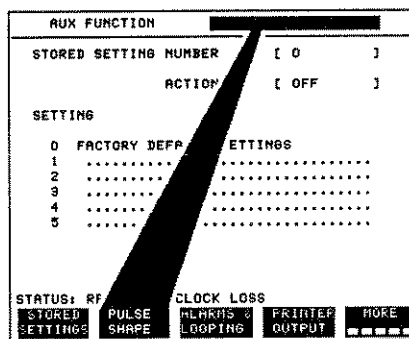

Select **PRINT PULSE**.

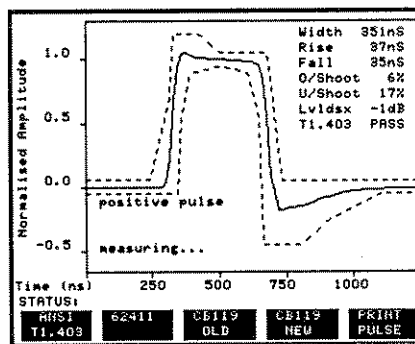

To Print the Full T1 Tester Settings.

The full T1 tester settings may be printed at any time.

Press **AUX**.

Select **PRINTER OUTPUT**.

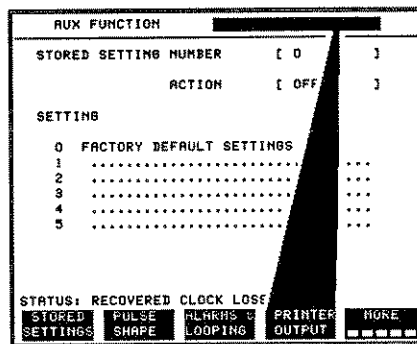

Highlight
PRINT ON DEMAND [].

Select **CURRENT SETTINGS**.

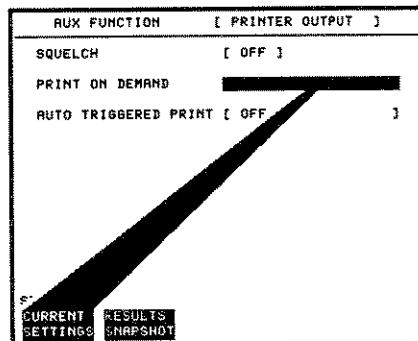

Press **PRINT NOW**.

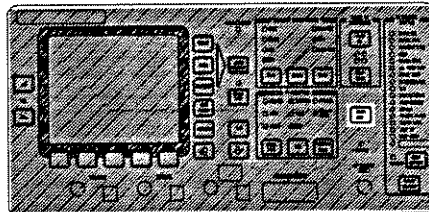

General Information

Introduction

This manual contains information which allows the user to operate and calibrate the Hewlett-Packard Model 37701A T1 Tester. The T1 tester may be part of An HP 37711A T1/Datacom Test Set.

On the title page of this manual is a Microfiche Part Number. This number can be used to order 4 X 6 inch microfilm transparencies of the manual.

Each microfiche contains up to 96 photo duplicates of the manual pages.

Specification

Instrument specifications are listed on Page 7-4. These specifications are the performance standards or limits against which the instrument is tested.

Safety Considerations

This product is a Safety Class 1 instrument (provided with a protective earth terminal). The instrument and manual should be reviewed for safety markings and instructions before operation. Also read the Warning page at the front of this manual.

Options Available

The following options are available and may have been ordered with the T1 Tester:

- Option 001 Pulse Shape, Clock Slips and Wander Measurement Facility.
- Option 002 Alternative Power Source, Internal Battery.
- Option 003 Results Storage and Graphic Presentation Facilities.
- Option 004 Fractional T1, Timeslot check and Timeslot high resolution round trip delay.
- Option 910 Provides an additional copy of the Operating and Calibration Manual.
- Option 915 Used for ordering a copy of the Service Manual to enable a service trained person to troubleshoot and repair the instrument.
- Option W30 3-year Extended Support. W30 is an extended hardware support agreement. It provides 2-year extended hardware support beyond the standard 1-year return to bench warranty.

To See a Display of Options Fitted to your T1 Tester.

Press **AUX** and select **OPTIONS**

Accessories Supplied

The accessories supplied with the T1 Tester are:

<i>Accessories Supplied</i>	<i>Part Number</i>
Power Cord	See Installation
Operating and Calibration Manual	HP 37701-90006
Protective Front Cover	HP 37701-00002

Accessories Available

The following accessories are available and may have been ordered with the T1 Tester:

HP 15901A	Datacom Module.
HP 15513A	Test Cord, WECO 310 - WECO 310, length 1m (3 feet).
HP 15513A H02	Test Cord, WECO 310 - WECO 310, length 3m (10 feet).
HP 18182A	Test Cord, WECO 310 - Alligator clips.
HP 15670A	Test Cord, Bantam - Bantam, length 3m (10 feet).
HP 15707A	Test Cord, DB15 male - modular RJ48, length 3m (10 feet).
HP 92219H	Cable, RS-232-C, T1 Tester (DTE) - Terminal / Computer (DTE), Gnd,Tx,Rx only.
HP 5060-4461	Cable, RS-232-C, T1 Tester (DTE) - Modem (DCE), Gnd,Tx,Rx only.
HP 15711A	19-inch rack mount kit.
HP 15710A	Carrying Case.
HP 2225D	Printer, ThinkJet RS-232-C.
HP 15714A	Cable, T1 Tester - HP 2225D Printer.
HP 5060-4462	RS 232 Test plug.

Specification

Except where otherwise stated the following parameters are warranted performance specifications. Parameters described as "typical" or "nominal" are supplemental characteristics which provide a useful indication of the typical, but non-warranted, performance characteristics.

Specifications

Framing: D4, ESF, SLC-96 (Ft only), Unframed
Line Code: AMI, B8ZS

Test Patterns

QRSS: $2^{20}-1$ PRBS, $D_{20}+D_{17}+1=0$ with 14 zero limit
 $2^{15}-1$ PRBS: $D_{15}+D_{14}+1=0$
 $2^{20}-1$ PRBS: $D_{20}+D_{17}+1=0$
 $2^{23}-1$ PRBS: $D_{23}+D_{18}+1=0$
All ones
1:1 (101010 ...)
1:7 (01000000 ...)
3 in 24 (01000100 00000000 00000100 ...)

55 OCTET, (Network Equipment Technologies)

User programmable word, length 3 to 24 bits

4 user programmable patterns, length 8 to 1024 bits in 8 bit intervals. Pattern programmed in hexadecimal from the front panel or over remote control. The order of bit transmission is selectable.

Live (for use when monitoring live traffic)

Notes: Framing bits are inserted into these patterns in D4, SLC96, and ESF modes. For any user pattern with a pattern length which is a sub-multiple of the frame length (192 bits), the pattern is synchronized to the frame such that the F-bit always occurs at the start of the pattern. This helps to prevent excess zeros caused by framing.

All Signaling Bits Display

Used to display the signaling bits for all receive channels. The transmit signaling bits can be set in all signaling channels.

Auto/Restart

Framing, line code and pattern are automatically determined. The previous measurement results are zeroed and the instrument restarts measuring.

Monitor Mode

Monitor mode is for use on live traffic where no known test pattern exists. No

7-4 General Information

Specifications

pattern synchronization is attempted and pattern error results and pattern slips are not presented. Monitor Mode can be selected by setting the test pattern to "Live". It is automatically set on pressing Auto/Restart if no recognizable pattern is found.

TRANSMITTER

Transmitter timing

The transmitter can be timed from the clock recovered at the receiver (loop timed) or from the internal clock

Internal Tx Clock

Frequency: 1.544 MHz
Stability: ± 5 ppm 0 to 40°C (nominal).
 ± 10 ppm 0 to 50°C
Ageing: ± 2 ppm per year typical

Tx Error Add

Types: Logic, BPV, Frame or CRC (ESF only)
Rates: Selectable 10^{-3} , 10^{-4} , 10^{-5} , 10^{-6} or 10^{-7} , or SINGLE

Notes: Logic errors are inserted only in test patterns, not in framing bits. They include both 0 to 1 and 1 to 0 conversions without violating the 15-zero constraint in the case of QRSS. With ESF they are inserted before CRC calculation and so do not result in CRC errors. Pattern error insertion never causes bipolar violations, CRC or frame errors. Bipolar violations are inserted across both data bits and F-bits. They include both + to - and - to + conversions with equal probability. Other conversions are excluded since they would result also in logic errors. BPV insertion does not cause logic, CRC or frame errors nor affects B8ZS coding. Frame errors are only added to those F-bits which are used for framing. A CRC error is added by inverting one of the 6 CRC bits in a CRC block (an ESF multiframe). An error injection rate of 10^{-n} corresponds to one errored CRC block in 10^n CRC BLOCKS.

Specifications

Tx Alarms

- AIS: Unframed All Ones.
- Yellow Alarm: bit 2 of each timeslot = 0 (D4 and SLC-96) 8 ones/8 zeros pattern in facility data link (ESF)
- Validity: Alarms can be generated with any test pattern. They are disabled when loop codes are being generated. Yellow alarm is not available in unframed mode.

Tx loopback codes (in-band)

Loopback	Loop-up code	Loop-down code
Line loopback	10000	100
4-bit "smrtjack" (NI)	1100	1110
5-bit "smrtjack" (NI)	11000	11100
User	XXXXXXXX	XXXXXXXX

The loopback codes may be sent with or without framing. With framing, the default state is that the framing bits temporarily overwrite the loopcode. The user can select framing to be inserted in loopcodes. The loop-up code is sent for 8 seconds, or will stop after loop-up is detected at the receiver. If loop-up is detected within the first second, a "Pre-exist loop" will be flagged. The loop-down code will be sent for 8 seconds, or will stop when the loop-down code ceases to be received. If no loop-down code is detected at the receiver within the first second, then the instrument cannot determine whether the far end has unlooped and the transmission of loop-down will continue for the full 8 seconds. Accuracy of loopcode intervals: ± 1 Second.

Tx loopback codes (out-of band)

Out-of-band loopback is only available with ESF framing. Loopcodes (16-bit message) are sent in the ESF 4 kbit/s data link in the format:

Specifications

Loopback	Loop-up code	Loop-down code
Line loopback	00001110 11111111	00111000 11111111
Payload loopback	00010100 11111111	00110010 11111111
Smartjack loopback	00010010 11111111	00100100 11111111

Out-of-band loopcode repetition: 15

Idle code. When not transmitting loopcodes, the tx sends idle code (repeated 01111110) in the data link.

Output

Impedance: 100 ohm balanced (nominal)
Pulse Shape: meets ANSI Standard T1.102-1987
Pulse Height: $\pm 3V \pm 600mv$ (at the center)
Pulse Imbalance: Ratio of voltage in +ve and -ve pulses; $0 \pm 100 mV$
Pulse Width: 324 ± 30 nsecs (measured at half amplitude)
Rise & Decay Time: 75 ns maximum. (10% to 90%)
LBO: 7.5dB and 15dB nominal

RECEIVER

DSX-MON

For connection to protected monitor points. Automatic gain control (AGC) between 0 and +36dB compensates for the flat loss at these points, no specific frequency dependent gain is provided except $\pm 6db$ DSX is allowed for cross connect cabling.

Rate: 1.544 Mb/s ± 130 ppm
Pulse shape: DSX-1 compatible per ANSI Std T1.102-1987
Input Impedance: 100 ohms nominal
Dynamic Range: +6 to -30dB relative to DSX-1 level

TERMINATED

For terminating unprotected DSX-1 points or line terminations up to -36db caused by lines of approx 6000 feet of cable. Frequency dependent gain is provided.

Specifications

Input Impedance: 100 ohms nominal
Dynamic Range: 6V pk-pk to 95mV pk-pk or 0 to +36db equalization @ 772kHz

BRIDGE

For use where the circuit is already terminated. Specification as TERMINATED, except input impedance is 1kohm (nominal).

Jitter Tolerance

The receiver will operate without error in the presence of a signal with jitter within the nominal mask shown below. These specifications apply for data with maximum zero runs of 14.

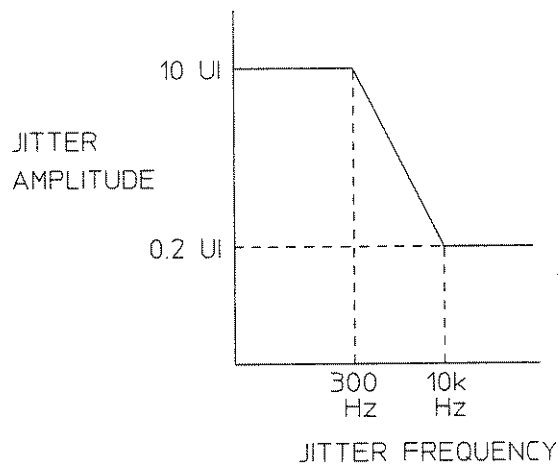

Alarm LEDs (red)

The indication remains for 100 ms beyond the duration of the alarm condition. The history function shows any alarm which occurred during the last measurement period.

Signal Loss: triggered by 175 or more consecutive zeros at the receiver (TR-TSY-000475)

All ones (AIS): triggered when any two consecutive frames contain less than 3 zeroes

7-8 General Information

Specifications

- Frame Loss: see Frame Loss Criteria
- Pattern Loss: triggered by loss of synchronization to the selected test pattern
- Slip: triggered by controlled or uncontrolled slips (out-of-service testing only)
- Excess Zeros: triggered by >15 consecutive zeros
- Ones Density: triggered by a received ones density <12.5% over a 100mS period
- Errors: triggered by an error from any of the available sources in any 1 Second period
- Yellow Alarm: triggered by bit 2 of every timeslot set to zero (D4 and SLC-96) or facility data link contains repeated 1111111100000000 (ESF)
- Power loss: triggered when power is removed from the instrument during a measurement period
- Loop up: triggered when the instrument detects a loop up code (as defined on the AUX TX/RX page) for at least 100mS
- Loop Down: triggered when the instrument detects a loop down code (as defined on the AUX TX/RX page) for at least 100mS
- Excess Wander (Optional): triggered when greater than 5 UI of wander is exceeded in any 15 minute period or 28 UI in any 24 hour period
- Status LEDs (green): T1 pulses, Frame Sync, Pattern Sync, B8ZS

Signal Indication

The presence of T1 pulses is indicated when 1) A 1544 kHz clock \pm 500ppm (nominal) is recovered, and 2) Peak levels (nominal) are between +6 and -30 dBdsx (DSX-MON) or 0 and -36db at 772 kHz (TERM or BRIDGE).

Frame Sync Criteria

- D4: 24 consecutive error-free Ft and Fs bits (nominal)
- ESF: 24 consecutive error-free Fe bits and then 3 CRC error-free multiframe (nominal)
- SLC-96: 24 consecutive error-free Ft bits (nominal)

Specifications

Frame Loss Criteria

D4: 2 in 4 Ft bits in error
ESF: 2 in 4 Fe bits in error
SLC-96: 2 in 4 Ft bits in error

Pattern sync

Sync Loss: Sync loss is deemed to have occurred if the error ratio exceeds 4% as measured over a decisecond
Sync Gain: Sync is regained after 32 error-free clock periods

Test Period

Range: 1 minute to 100 days or continuous.
Resolution: 1 minute/1 hour/1 day
Fixed intervals: 5 min, 15 min, 2 hour
Indicator: Green LED above START/STOP key is illuminated while measurement is in progress

CSU EMULATION

Status Messages

Loop codes are as set for the transmitter. If a set loop code is detected the presence of LOOP UP or LOOP DOWN will be indicated on the Receive Status LED's (latched by the "history" function).

Autoresponse Mode

In-Band If Autoresponse is ON, the instrument performs a line loopback if the LOOP UP code is present > 5 seconds. If the LOOP DOWN code is detected and Autoresponse is ON, the instrument removes the line loopback if the LOOP DOWN code is present for more than 5 seconds (nominal). The line loopback can be set ON/OFF manually. Tx error injection and alarm generation are disabled in Line loopback mode.

Specifications

Out-of-Band When autoreponse is enabled the instrument responds to any out-of-band loopcode. There are two types of loopback available *LINE* and *PAYLOAD*. The loopcodes are as follows:

Received Code	Tester Response
Line loop-up	Enable line loopback
Line loop-down	Disable line loopback
Payload loop-up	Enable payload loopback
Payload loop-down	Disable payload loopback
Smartjack loop-up	Enable line loopback
Smartjack loop-down	Disable line loopback

The instrument is capable of having both loopbacks (line and payload) enabled simultaneously. When this occurs, the net effect is line loopback.

The current status of the two loopbacks is indicated on the LOOPCODES display, these can be manually overridden at any time by the user. The instrument TESTER LOOPED LED lights when either loopback is enabled.

Loopcode Detection

Out-of-Band The receiver constantly monitors for a valid 16-bit message on the ESF data link. Valid messages will remain for at least 10 repetitions and each takes 4 ms. The instrument samples the messages every 5 ms, and a valid loopcode will be flagged whenever 6 out of the last 5 ms samples have contained the same valid loopcode.

Loopcodes are not detected if PATTERN is set to SPECIAL.

Loopback	Loop-up code	Loop-down code
Line loopback	00001110 11111111	00111000 11111111
Payload loopback	00010100 11111111	00110010 11111111
Smartjack loopback	00010010 11111111	00100100 11111111

Specifications

Line Loopback

When line loopback is selected or set by the LOOP UP code, loop timing is forced and the instrument retransmits the recovered receive data. BPVs, frame errors, CRC errors and logic errors are all preserved.



Specifications

MEASUREMENTS

Error sources: Logic errors, BPVs, Frame errors (Ft & Fs bits for D4 mode, Fe bits for ESF mode, Ft bits for SLC-96 mode), CRC errors (ESF only)

For B8ZS the zero replacement code will not be reported as a BPV error (0V10V1).

Recovered Clock Frequency Measurement

Resolution: 1 Hz
Accuracy: $\pm 5\text{ppm}$ 0 to 40°C (nominal)
 $\pm 10\text{ppm}$ 0 to 50°C
Ageing: $\pm 2\text{ppm}$ per year, typical
Result Presentation: Absolute frequency (Hz) and frequency offset in ppm from 1544000Hz.

Pattern Slip Measurements

Valid for all PRBS patterns. If framing is present, then CONTROLLED and UNCONTROLLED slips can be distinguished. For unframed modes it is meaningless to use these terms, and a single measurement of SLIPS is made.

Slip Criteria: Once the error detector has gained sync, a pattern slip is counted if the received pattern is the same as the test pattern over 32 consecutive bits and Sync Loss is simultaneously true.

Uncontrolled Slip: If a pattern slip is accompanied by a COFA (change of frame alignment) then it is an uncontrolled slip.

Controlled Slip: If a pattern slip is not accompanied by a COFA then it is a controlled slip (or frame slip).

Simplex Current Measurement

Volt Drop: Nominal 8 Volts drop @ 60mA
Range: from ± 10 to ± 200 mA (Unsigned)
Accuracy: $5\% \pm 1\text{mA}$
Resolution: 1 mA

Specifications

Simplex current measurements are possible on all front panel Tx/Rx connectors.

Caution



Span Power Measurements

Extreme care should be taken when operating with hazardous voltages. Span power can generate voltages of up to $\pm 130V$ dc.

A dc connection is provided between the receiver and the transmitter paths for operation on wet lines. Ensure span power is removed before connecting or disconnecting the test set.

Signal Level Measurement

Presentation:	Volts, dBdsx and dBm (the dBm result is the dBdsx result plus 17dB, correct for an all-ones signal)
Range:	+6dbdsx to -36 dBdsx (12 Volts to 100mV peak to peak)
Voltage Accuracy:	$\pm 10\%$ (2V to 12V), $\pm 30\%$ (100mV to 2V)
Voltage Resolution:	50mV (2V to 12V), 10mV (60mV to 2V)
Level Accuracy:	$\pm 1dB$ (-9dBdsx to +6dBdsx) $\pm 2dB$ (-19dBdsx to -10dBdsx) $\pm 3dB$ (-36dBdsx to -20dBdsx)
Level Resolution:	1dB

Round Trip Delay Measurement

Only valid for QRSS

Range:	1mS to 670mS
Resolution:	1mS
Accuracy:	3% (nominal)

Specifications

CHANNEL ACCESS

The user can select a single channel (1..24) to be demultiplexed from the incoming T1 stream and u-law decoded D1D, D2 or D3/D4 channel assignment mapping can be selected. The VF signal can be monitored on a loudspeaker mounted behind the instrument front panel or can be fed to an external instrument. The signaling bits associated with the selected channel or all channels simultaneously may be displayed. Voice frequency access, and signaling bit access are available for D4, ESF and SLC-96 modes.

VF Output

Output Impedance: 600 ohm balanced (nominal)
Reference Level: 0dB TLP (nominal)
Dynamic Range: +3dBm to -50 dBm relative
Frequency Response: Within ± 0.25 dB from 300Hz to 3KHz (nominal)
Ref 1010 Hz at -10 dBm: Within +0.25dB,-0.9dB (nominal)

Signal-to-Quantisation Noise Ratio

1010 Hz Level	Quantisation Noise
0 dBm to -30 dBm	-35 dB minimum (nominal)
-30 dBm to -40 dBm	-29 dB minimum (nominal)
-40 dbm to -45 dBm	-24 dB minimum (nominal)

Gain Tracking Error

1010 Hz Level	-10 dBm error
+3 dBm to -40 dBm	± 0.3 dB maximum (nominal)
-40 dBm to -50 dBm	± 0.6 dB maximum (nominal)

Intrinsic Noise: <15 dBmco (nominal).

Specifications

RESULTS

Error Results

Error Count. Errors are counted for all sources over total elapsed time. Counting is not inhibited during alarm conditions, except during pattern sync loss for 300ms (nominal) following instrument power restoration and during signal loss. The counting of errors during pattern loss is user selectable over remote control.

Elapsed time starts after a signal has been detected at the input. BPV results are available at this time. Frame and CRC results are available only after frame sync has been achieved during a measurement. Pattern (logic) results are available after pattern sync has been achieved.

Error Seconds. Asynchronous error seconds are counted for all error sources

Error Count and Error Second. 6-digit display for $< 1,000,000$ errors, X.XXX Exponent YY display for $\geq 1,000,000$ errors. For CRC error counts, an incorrect CRC checksum is counted as one error.

Ave. Error Ratio. Average error ratio over total elapsed time

Cur. Error Ratio. Current error ratio, measured over the last second

Error Ratio Format. X.X Exponent YY display

Error Free Seconds. The number of error free seconds expressed as a count

% Error-free Secs. The number of error free seconds expressed as a percentage of the number of seconds in the measurement period

Percentage format. XX.XX% or 100.00%

SEF Count. Count of Severely Errored Framing events (SEFs) within the measurement period. An SEF event occurs if 2 or more errors are detected in the framing pattern within a 3 ms period. Consecutive 3 ms periods are examined. Valid in ESF mode only.

Specifications

OOF Count. Count of Out Of Frame events (OOFs) within the measurement period. An OOF event occurs if 2 or more errors are detected in any 4 consecutive frame bits. Valid in all framed modes.

LOF Count. A count of the number of times a frame loss occurs for >3 seconds

Frame Loss Seconds. Count of the number of Frame Loss Seconds.

Alarm Seconds

Display Format: 9-Digit display for < 1,000,000,000 seconds
Alarms presented: Yellow Alarm, Pattern Loss, Frame Loss, Signal Loss, AIS, Excess Zeros, Power Loss

Trouble Scan

Displays any non-zero error count (in “large” characters) for the four error types LOGIC, FRAME, BPV and CRC. If the results are all zero then “No Trouble Found” is displayed.

Pattern slips

Uncontrolled (COFAs) and controlled (no COFA). Count of both types with no direction indication.

Time-of-day Clock

Stability: $\pm 0.01\%$ (nominal)

DATA LOGGING

Logging to external printer

External printer data logging provides output of results and instrument control settings via the RS-232 serial port. The recommended printer is an HP Thinkjet. A selectable graphics mode supports other common printers e.g. Epson and Seiko.

Printout types. settings, events (printout of current results triggered by errored seconds or alarms), timed (printout of current results every xx minutes), manual (printout of current results on demand). All printouts include time, date and instrument serial number.

Specifications

PRINTER and REMOTE CONTROL PORT

This dual purpose port is a full duplex RS-232-C serial interface configured as a DCE. Direct connection may be made to DTEs, such as printers and terminals. An adaptor (crossover) cable is required for connection to modems, or other DCEs. The port can be assigned either to printing or remote control, but not both together.

Printer output

Baud rate: 300, 600, 1200, 1800, 2400, 4800, 9600
Data bits: 8
Parity: None
Stop bits: 1 or 2
Transmit pacing: ENQ/ACK, Xon/Xoff or DTR

Remote control

Baud rate: 300, 600, 1200, 1800, 2400, 4800, 9600
Data bits: 7
Parity: ODD, EVEN, ZEROS, ONES
Stop bits: 1 or 2
Pacing: ENQ/ACK, Xon/Xoff (Rx only, Tx only or Rx & Tx) or DTR (Txonly)

In addition to Xon/Xoff and ENQ/ACK character handshake flow control, the 37701A provides an optional COMMAND PROMPT to facilitate remote control via a "dumb" terminal. When this feature is in use, the remote control device waits after sending a command until a user-selectable prompt character is returned by the 37701A to signify that it is ready to accept a new command.

Specifications

RS-232-C connector configuration

Pin	Mnemonic	Description
1	PGND	Connected to chassis ground
2	TXD	37701A data input
3	RXD	37701A data output
4	RTS	Internally connected to CTS in 37701A
5	CTS	Internally connected to RTS in 37701A
6	DSR	Set "ON" by 37701A when powered
7	SGND	Signal ground
8	DCD	Set "ON" by 37701A when powered
20	DTR	When DTR transmit pacing is selected, data output from the 37701A is inhibited if DTR is held "OFF" by receiving device.

Modem operation. Remote control via a modem link requires a pair of full duplex modems. Connection between the 37701A and the modem should be by means of a cable configured as shown below:

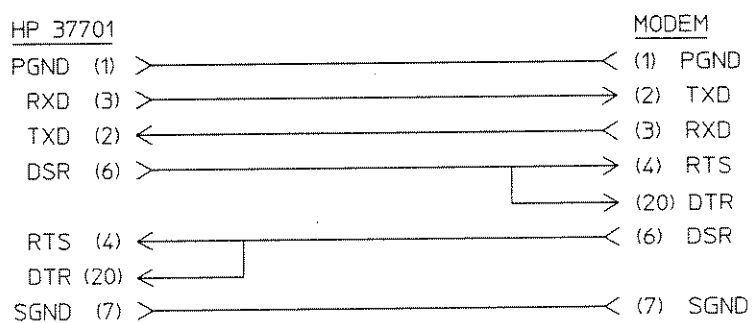

Specifications

General

Size: 340mm (13.4") wide, 190mm (7.5") high, 208mm (8.2") deep
(including front panel cover). Battery power (option 002) adds 64mm
(2.5") to depth.

Weight: 4.5kg (10lbs). Battery power (option 002) adds 2.6kg (5.6lbs).

Operating temperature: 0 to +50C

Storage temperature: -40 to +70C

AC Supply: 85-265V 47-66Hz, continuous input voltage selection.

Power consumption: 30VA

LpA < 70 dB LpA < 70 dB

operator position am Arbeitsplatz

normal operation Normaler Betrieb

per ISO 7779 nach DIN 45635 T. 19

Instrument settings storage

All settings and results are saved in protected memory when the instrument is switched off. In addition, the user can store up to five complete setups, with names, and recall them.

Connectors

Tx/Rx - bantam jacks, 310 jacks and DB15 connector, all in parallel

Slip reference - bantam jack and 310 jack in parallel

VF output - 310 jack

RS-232 printer output/remote control - DB25 connector

Specifications

OPTIONS

Pulse shape and clock slips measurements (option 001)

Pulse Shape

Measurements. Pulse Width, Rise Time, Fall Time, Overshoot, Undershoot, Level(dBdsx), Mask pass/fail, pulse shape display

Range: +6 to -26dBdsx (nominal)
Measurement time: 11 seconds (nominal)

The following four items are specified for DSX-1 pulses within ± 3 dB of 0dBdsx, specifications are nominal for other signals.

Pulse width range: 200-500ns, accuracy: ± 20 ns (nominal)
Rise time resolution: 1nS (nominal)
Fall time resolution: 1nS (nominal)

Overshoot/undershoot resolution: 1% (nominal)

Pulse Masks: Pub 62411, ANSI T1.403, CB 119 (Old equipment), ANSI T1.102/CB 119 (New equipment)

The measured pulse is automatically fitted to the selected mask. For signal levels within ± 3 dBdsx (nominal), pass/fail is indicated. Positive and negative pulses are displayed alternately. On a random data signal, pulses which are preceded and followed by at least 3 zeros are used to compute measurements. If this criterion cannot be met, pulses which are preceded and followed by at least 1 zero will be used. If neither of these criteria can be met, any pulse will be used and a message "insufficient zeros, pulse truncated" will be displayed to the user. Under these conditions, the pulse trace is reduced to 600nS.

Clock slips measurement

Measurements. Estimated Clock Slips, Estimated Frame Slips, Positive Peak Wander, Negative Peak Wander, Peak to Peak Wander,

Time Interval Error, 15 Minute Wander, 24 Hour Wander

Specifications

Timing Reference DSX Input.

Rate: 1.544 Mb/s \pm 130 ppm
Pulse Shape: DSX-1 compatible as per ANSI Std T1.102-1987 There is an indication if no reference signal is present.
Input Impedance: 100 ohms (nominal)
Dynamic Range: +6dB to -30dB relative to DSX-1 level (nominal)

Wander Measurement.

Bandwidth: Low pass response -3dB at 10Hz (nominal)
Resolution: 0.125 UI
Accuracy: \pm 0.125 UI \pm 0.5% of reading, for wander frequency up to 1Hz
Range: \pm 99999 UI

Battery power (option 002)

Battery type: sealed lead-acid
Operating time: 1.5 hours (typical, display on continuously)
3 hours (typical, display timed off)

Built-in recharger, battery charges while instrument is connected to AC, whether operating or not

Recharge time: 9 hours (typical)

Instrument automatically switches off when battery is low, before performance is impaired. Once instrument has switched off, a flashing LED indicates a low battery. A low battery message is displayed 15 minutes (nominal) before the instrument switches off. To maximize operating time, display switches off 5 minutes after user stops pressing keys. Measurements continue and status LEDs remain on. Pressing any key brings the display back on.

Result storage and graphic presentation (option 003)

Internal electronic result storage. Automatic storage for up to 10 periods with a maximum of 99 days total capacity. Once all the store capacity has been used, the oldest test data will be discarded. Storage can be switched on or off. Data is retained when the instrument is switched off.

Specifications

Stored End-of-Period Results. Errored seconds, error Count, synchronous errored seconds, average

error ratio, error free seconds, %error free seconds

Stored End-of-period G.821 analysis. %availability, degraded minutes, %degraded minutes, severely errored seconds, %severely errored seconds, errored seconds, %errored seconds, consecutive severely errored seconds, unavailable seconds.

Stored End-of-Period Alarm Seconds. Power Loss, AIS, signal loss, frame loss, pattern Loss, excess zeros

Graphic result presentation. Histogram display or printout versus time-of-day of two error sources, based on current or stored measurement period.

Error Sources. Logic, BPV, Frame, CRC, Alarms

Display Format.

Width: 60 bars

Bar resolution: 1 minute, 15 minutes, 60 minutes

Error count scale: Pseudo-logarithmic range of more than 8 decades, each decade represented linearly.

G.821 error results during measurement. Performed on logic and CRC errors, limited analysis on F-bit errors.

%availability, degraded minutes, %degraded minutes, severely errored seconds, %severely errored seconds, errored seconds, %errored seconds, consecutive severely errored seconds, unavailable seconds.

n × 56/n × 64 kBit/s measurements (option 004)

Fractional T1 modes: n × 56 kBit/s, n × 64 kBit/s contiguous or non-contiguous. Background timeslots filled with idle code 01111111.

Test patterns: QRSS, 8 bit user defined word (64 kbit/s), 7 bit user defined word (56 kbit/s), 4 user defined patterns (8 to 1024 bits), $2^{15}-1$ PRBS, $2^{20}-1$ PRBS, $2^{23}-1$ PRBS.

Test tones (for single 64 kBit/s timeslot only):

404 Hz, 1004 Hz, 2804 Hz.

Specifications

Timeslot check:	Shows digital content of one or all timeslots. Transmitter sends varying identification in all timeslots simultaneously. The origin timeslot number is displayed for any received timeslot containing an identification code.
Timeslot delay measurement:	High resolution round trip delay measurement in any timeslot. Range 10 μ s to 0.6 s, resolution 10 μ s.



Installation

Introduction

This section provides installation instructions for the Hewlett-Packard Model 37701A T1 Tester and its accessories. This section also includes information about initial inspection, preparation for use, packaging, storage and shipment.

Initial Inspection

Warning

To avoid hazardous electrical shock, do not perform electrical tests when there are signs of shipping damage to any portion of the outer enclosure (covers, panels, meters and so on).

Inspect the shipping container for damage. If the shipping container or cushioning material is damaged, it should be kept until the contents of the shipment have been checked for completeness and the instrument has been checked mechanically and electrically. Procedures for checking electrical performance are given in Chapter 5 of this manual. If the contents are incomplete, if there is mechanical damage or defect or if the T1 Tester does not pass the Performance Tests, notify the nearest Hewlett-Packard office. If the shipping container is damaged or the cushioning material shows signs of stress, notify the carrier as well as the Hewlett-Packard office. Keep the shipping materials for the carrier's inspection. The HP office will arrange for repair or replacement at HP option without waiting for claim settlement.

Preparation for Use

Warning



To avoid the possibility of injury or death, the following precautions must be followed before the instrument is switched on.

- A. Note that the protection provided by grounding the instrument cabinet may be lost if any power cable other than the three-pronged type supplied is used to couple the ac line voltage to the instrument.
- B. If this instrument is to be energized via an auto-transformer to reduce or increase the line voltage, make sure that the common terminal is connected to the neutral pole of the power source.
- C. The power cable plug shall only be inserted into a socket outlet provided with a protective earth contact. The protective action must not be negated by the use of an extension cord without a protective conductor (grounding).

Power Requirements

The instrument requires a power source of (95 to 240 V ac) $\pm 10\%$, 47 to 66 Hz single phase. The power consumption is less than 30 VA for any instrument including those with the alternative battery power option (Option 002).

Line Fuses

The line fuses are located in a compartment on the side panel above the line power input connector and line switch. The correct rating is 250V, 1 A Timed (HP 2110 - 0674).



Caution



Before connecting the instrument to a power outlet ensure that a fuse of the correct rating is fitted.

Power Cable

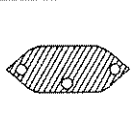
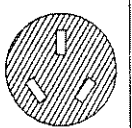
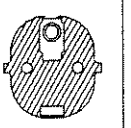
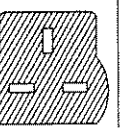
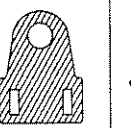
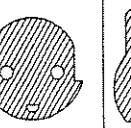
This instrument is equipped with a three-wire power cable. When connected to a properly grounded power outlet, this cable grounds the instrument case. The type of power cable supplied with each instrument depends on the country of destination. Refer to the following figure for the part numbers of the power cables and plug configurations available. The number shown below each plug is the Hewlett-Packard part number of a power cable equipped with that plug. If the appropriate power cable is not included with the instrument, notify the nearest Hewlett-Packard Sales and Service Office and a replacement will be provided.

						
8120-2104	8120-1369	8120-1689	8120-1351	8120-1378 US 8120-4753 JAP	8120-2956	8120-4211

The color code used in each power cable is given below:

Line	Brown
Neutral	Blue
Ground	Green/yellow

Battery (Option 002)

Warning

For operator protection during battery operation, connect the chassis terminal on the rear panel to earth ground.



Two 6 V 3 Ah lead acid batteries (HP 1420-0123) are located inside the battery compartment at the rear of the instrument.

The instrument will run with fully charged batteries (at an ambient temperature of 25 degrees centigrade) for nominally 1.5 hours with settings and results displayed or 2.5 hours with the display blanked.

Power consumption is optimized by automatically blanking the display if there is greater than 2 minutes between key presses. Pressing any key re-displays settings.

When the instrument detects that the battery voltage is low, it displays a **Battery low !!!!** status message. This message remains displayed until the battery voltage drops below the minimum level that guarantees valid results. When this condition is reached, there is an automatic instrument power down and the red *LOW BATTERY* indicator on the side panel then flashes to show the batteries require re-charging.

It is recommended that the batteries be re-charged as soon as possible to optimize battery life.

To Charge the Batteries (Option 002)

Caution

To avoid over charging, do not use an external charger. The instrument has its own charging circuit.



Connect the ac power cord, the green *CHARGING* indicator lights - full charge is obtained after 9 hours at 25 degrees centigrade. The battery charges with the power switch in the *ON* or *STANDBY* position.

To Change the Batteries

Warning



The battery should only be changed by someone who is aware of the hazards involved.

Do not short circuit the battery terminals, it may cause serious personal injury.

Do not incinerate or otherwise mutilate the battery. It might burst or release toxic materials causing personal injury.

1. Ensure that the instrument power switch is set to *STANDBY* and disconnect the ac power cord (if one is connected).
2. Remove the eleven securing screws on the rear panel then remove the back-plate.

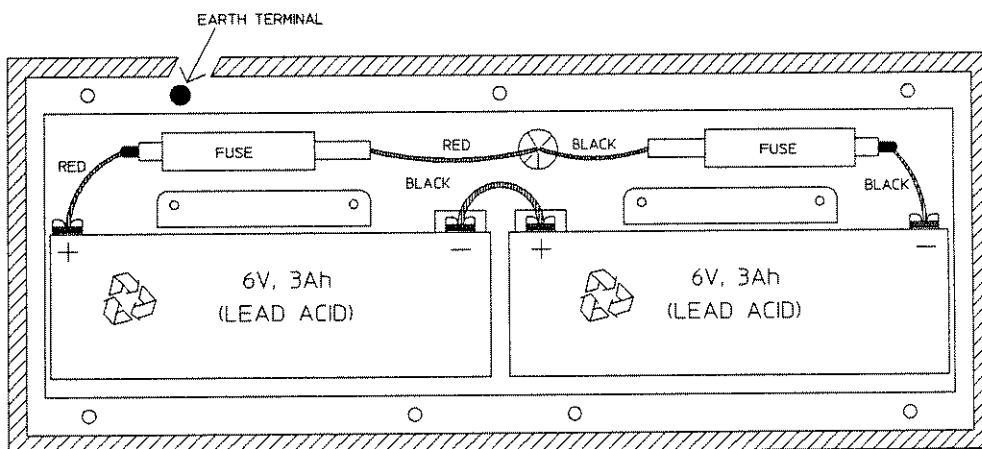

SOME COUNTRIES HAVE LEAD ACID BATTERY RECYCLING REQUIREMENTS.
CONSULT YOUR LOCAL HP OFFICE FOR DETAILS

3. Disconnect the batteries.
4. Replace the batteries.
5. Re-connect the new batteries.

Battery Fuses

Two 5 A fast blow fuses (HP 2110-0010) are located inside the battery compartment at the rear of the instrument.

To Change a Blown Fuse

1. Ensure that the instrument power switch is set to *STANDBY* and disconnect the ac power cord (if one is connected).
2. Remove the eleven securing screws on the rear panel then remove the back-plate.
3. Disconnect the batteries.
4. Replace blown fuse.
5. Re-connect the batteries.

Mating Connectors (Front Panel)

Connectors which mate with the T1 Tester connectors are listed in the following table.

T1 tester Port	Connector type	Mating Connector Part Number
TRANSMIT	WECO 310	HP 1251-0695
TRANSMIT	BANTAM	HP 1251-3060
RECEIVE	WECO 310	HP 1251-0695
RECEIVE	BANTAM	HP 1251-3060
TIMING REF DS1 INPUT	WECO 310	HP 1251-0695
TIMING REF DS1 INPUT	BANTAM	HP 1251-3060
TRANSMIT/RECEIVE	15 WAY D	HP 1251-5503
VF OUTPUT	WECO 310	HP 1251-0695
RS 232 C	25 W D SUBMIN	HP 1251-0063 (plug) HP 1251-1438 (hood)

T1 Tester Selection When Using a T1/DATACOM TEST SET

The T1 Tester may form part of a T1/Datacom Test Set. To select T1 operation, set the DATACOM MODULE, TEST SELECT to T1.

ACCESSORY Port - for Datacom Module Connection

Caution



The Datacom-lid cable must only be connected or disconnected with the instrument powered down.

RS-232 Port - for Printer or Remote Control Connection

Caution



This port is located on the side panel of the HP 37711A or HP 37701A and is NOT to be confused with the RS-232/V.24 port on the Datacom Module.

This port is a full duplex RS-232C serial interface configured as Data Communications Equipment (DCE). This port can be connected directly to printers, dumb terminals and controllers which are configured as Data Terminal Equipment (DTE).

Using an adaptor cable (see page xx), this port can also be connected to modems and other devices which are configured as DCE.

The *RS-232* connector pinout configuration and signal flow are shown in the following diagram:

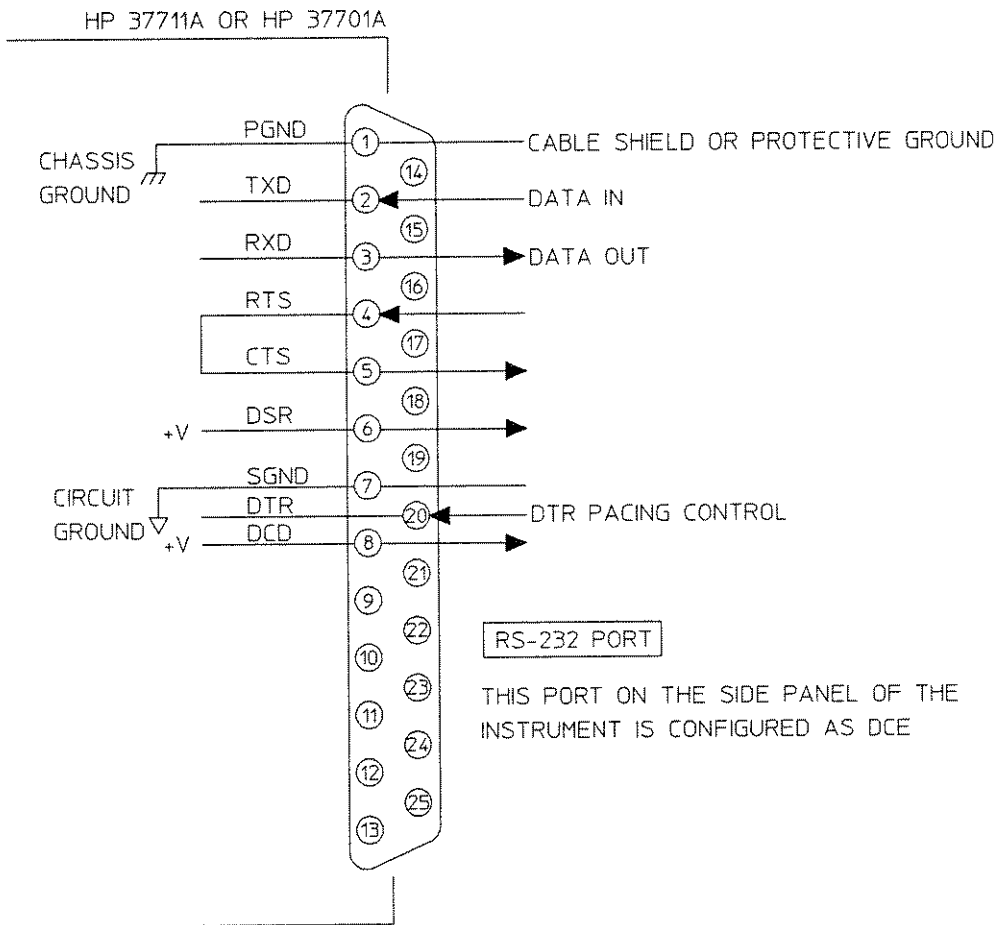

The *RS-232C* port can only transmit or receive asynchronous data, any device connected to it must be set for asynchronous operation. The character formats for Printer and Remote Control are as follows:

8-8 Installation

	Printer Operation	Remote Control
Baud Rate	300, 600, 1200, 1800, 2400, 4800 or 9600	
Data Bits	8	7
Parity	None	Odd, Even, Zeros, Ones
Stop Bits	1 or 2	
Pacing	ENQ/ACK, Xon/Xoff or DTR	

For more details on Printer operation and Remote Control, see chapters 5 Preparing to print, chapter 6 Printing Results and chapter 10 Remote Control.

Modem Connection

Only a full duplex modem may be used. The cable connecting the *RS-232* port to the modem should be configured as follows:

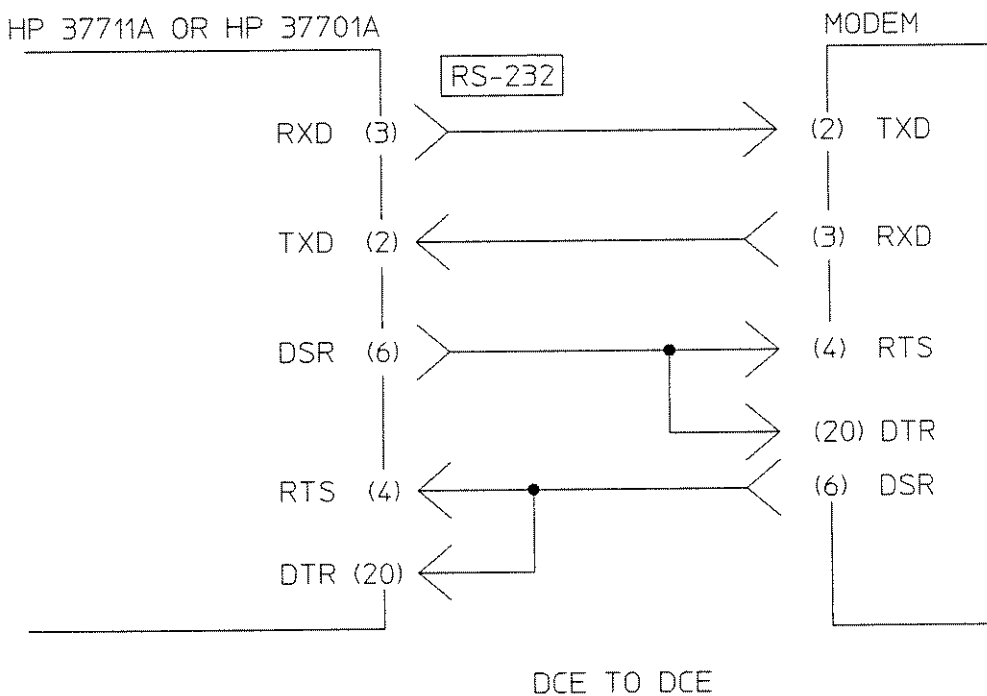

Rack Mounting

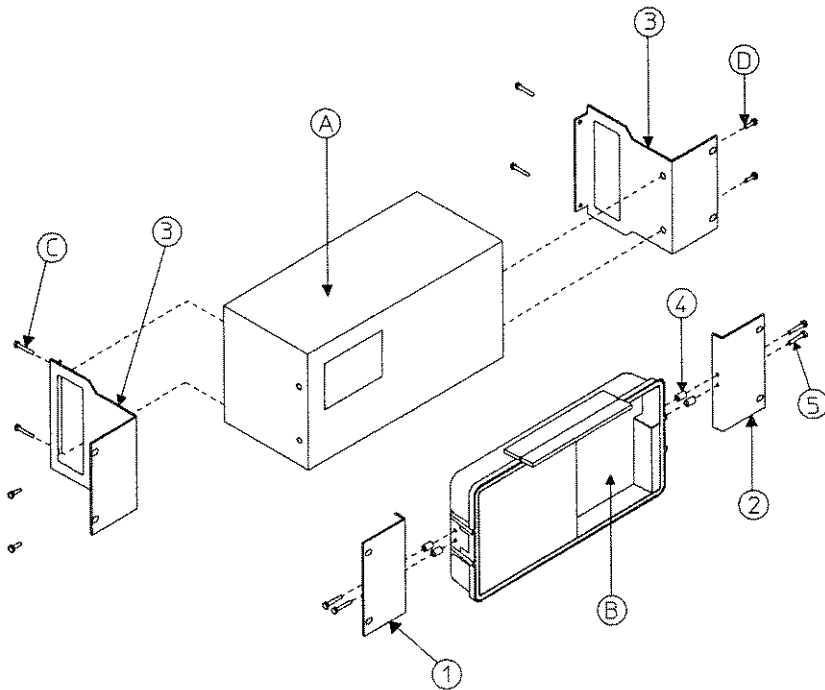

PROCEDURE FOR MOUNTING BRACKETS TO (A)

1. REMOVE 4 SCREWS (C) HOLDING REAR FEET
2. REMOVE 12 SCREWS (D) HOLDING FRONT FEET
3. PLACE BRACKETS ITEM 3 (2 OFF) IN POSITION AND FIX USING EXISTING SCR (4 OFF 'C') FROM THE REAR FEET AND (4 OFF 'D') FROM THE FRONT FEET

PROCEDURE FOR MOUNTING BRACKETS TO (B)

1. REMOVE 4 SCREWS BENEATH LATCH CATCH AND REMOVE DATACOM ASSY FROM THE PLASTIC COVER
2. REMOVE THE LATCH CATCHES BY REMOVING THE NUTS AND WASHERS ON THE INSIDE OF THE PLASTIC COVER
3. REFIT DATACOMS ASSY INSIDE PLASTIC COVER
4. PLACE BRACKETS ITEMS 1 & 2 IN POSITION AND FIX USING SCREWS ITEM 5 (4 OFF) AND SPACERS ITEM 4 (4 OFF)

RACK MOUNT KITS							
ITEM	QTY	KIT No. DESCRIPTION	HP 37711A		HP 37701A		HP 15901A
			HP 15713A	HP 15716A	HP 15711A	HP 15715A	HP 15712A
1	1	BRACKET	37701-00031	37701-00031			37701-00031
2	1	BRACKET	37701-00032	37701-00032			37701-00032
3	2	BRACKET	37701-00029	37701-00039	37701-00029	37701-00039	

Operating Environment

Temperature	The instrument may be operated in temperatures from 0 degrees centigrade to +50 degrees centigrade. The temperature for battery operation is 0 degrees centigrade to +40 degrees centigrade.
Humidity	The instrument may be operated in environments with humidity up to 95% at 40 degrees centigrade. However, the instrument should also be protected from temperature extremes which may cause condensation within the instrument.
Altitude	The instrument may be operated at altitudes up to 4,600m (15,000 ft).
Air Flow	To provide adequate cooling, an air gap of approximately 3-inches should be maintained around the instrument.

Storage and Shipment

Environment

The instrument may be stored or shipped in environments within the following limits:

Temperature	-40 degrees centigrade to +75 degrees centigrade without a battery and -20 degrees centigrade to +55 degrees centigrade with a battery.
Humidity	90%
Altitude	15,300m (50,000 ft)

The instrument should also be protected from temperature extremes which may cause condensation within the instrument.

Packaging

Tagging for Service

If the instrument is being returned to Hewlett-Packard for service, please complete one of the blue repair tags located at the front of the service manual (if you have one) or give details on a label then attach the tag or label to the instrument.

Original Packaging

Containers and material identical to those used in the factory packaging are available through Hewlett-Packard offices. If the instrument is being returned to Hewlett-Packard for servicing, attach a tag indicating the type of service required, return address, model number and full serial number. Also mark the container "FRAGILE" to ensure careful handling.

Other Packaging

The following general instructions should be used for re-packing with commercially available materials:

- a. Wrap instrument in heavy paper or plastic. (If shipping to Hewlett-Packard office or service center, attach a tag indicating type of service required, return address, model number and full serial number.)
- b. Use strong shipping container. A double-walled carton of 35-pound test material is adequate.
- c. Use a layer of shock absorbing material 70 to 100 mm (3 to 4 inch) thick around all sides of the instrument to provide firm cushioning and prevent movement inside the container. Protect the control panel with the front cover provided or with cardboard.
- d. Seal shipping container securely.
- e. Mark the shipping container clearly.
- f. In any correspondence, refer to instrument by model number and full serial number.

T1 Tester Performance Tests

Introduction

This chapter contains procedures which test the HP 37701A electrical performance to the specifications in Chapter 7.

There are two levels of performance testing contained in this chapter:

- Operational Verification** Provides >90% confidence that the instrument is operating to its full warranted specification.
- Full Performance Test** Ensures that the instrument is operating to its full warranted specification.

Results of the Performance Test may be recorded on the Test Record at the end of this chapter, or on the Abbreviated Test Record at the end of the Operational Verification procedures.

Calibration Cycle

Results recorded on the Test Record at incoming inspection can be used for comparison in yearly maintenance and calibration or after repairs or adjustments.

Recommended Test Equipment

The test equipment required is listed in the following table. Equipment which meets or exceeds the critical specifications may be substituted for the recommended model.

Recommended Test Equipment

Instrument	Critical Specification	Recommended Model
Signature Multimeter	Unique	HP 5005B
Frequency Counter	0.00015% accuracy up to 1.544 MHz; Trigger Level O/P available	HP 5316B OPT 001
DC Voltmeter	1% accuracy	HP 3456A
AC Voltmeter	2% accuracy at 772 kHz	HP 3458A
Printer	80 column HP-IB printer	HP 2225A Thinkjet
Synthesizer / Function Generator (2 off)	50 Ω unbalanced output. Sinewave frequency range 772 kHz \pm 110Hz; Level range 23dBm to -20dBm	HP 3325B
Oscilloscope	100 MHz bandwidth; Dual I/P 50 Ω and 1 M Ω	HP 54201A/D
DC Power Supply	Variable DC supply voltage up to 20 V	HP 6205B
Impedance Converter	110 Ω balanced (nominal) to 75 Ω unbalanced (nominal)	HP 15508B
WECO 310 to WECO 310 cable	Unique	HP 15513A
Bantam to bantam cable	Unique	HP 15670A
WECO 310 to BNC adapter (3 off)	Unique	HP 1251-3757
75 Ω Termination	75 Ω \pm 1%	HP 15522-80010

Recommended Test Equipment (continued)

Instrument	Critical Specification	Recommended Model
15 way connector	15 way D-shell connector male	HP 1251-5503
RS-232 Loopback connector	Unique	HP 5060-4462
Accessory cable	Unique	HP 15901-60002
Dual BNC to WECO 310 cable	see figure below	
Resistor	100 $\Omega \pm 1\%$	HP 0757-0178
Resistor	33 $\Omega \pm 1\%$; 5W	HP 0811-0563

Dual BNC to Weco Bantam Cable

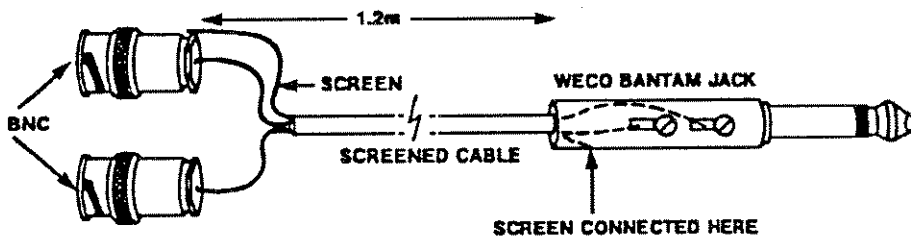

Description	QTY	HP Part Number
BNC Connector (male)	2	1250-1448
Weco Bantam Jack	1	1251-3060
1.2 m Length of Screened Cable	-	8120-2272

Operational Verification

The Operational Verification tests quickly establish with >90% confidence that the HP 37701A meets the specifications listed in Chapter 7. If any test fails to meet specification, refer to the Adjustments in the Service Manual. If after adjustment the specification still cannot be met, refer to the troubleshooting in the Service Manual.

Default Settings

Description

The instrument default settings are factory preset and will be called to reconfigure the instrument when the following procedure is performed. The table below lists the default settings.

Procedure

1. Press **AUX**.
2. Press the **STORED SETTINGS** softkey.
3. Select STORED SETTING NUMBER and press **0**, 0, is the default. Use **↑** and **↓** to highlight this field.
4. Select ACTION (again using the **↑** and **↓** keys) and press **RECALL**.
5. Now press **FRAME** to show the results page.

Default Settings

FRAME	D4
CODE	B8ZS
PATTERN	QRSS
TRANSMIT ERROR INSERT:	
TYPE	LOGIC
RATE	ERR FREE
T1 INTERFACE:	
INTERFACE	DSX-MON
LBO	0dB(DSX)
TRANSMIT TIMING	INTERNAL
TEST TIME	CONTINUOUS

T1 Tester Self Test

T1 Tester Self Test

Description

These tests give a high degree of confidence that the HP 37701A is operating to its warranted specification. A description of each test is given on page 9-8.

Equipment

RS-232 Loopback Connector : HP 5060-4462
15 Way Connector : HP 1251-5503

Procedure

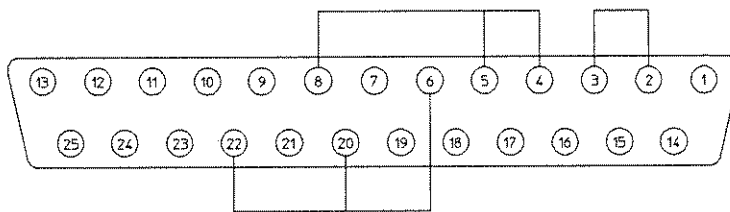

1. Connect the HP 37701A TRANSMIT Weco 310 output to the RECEIVE Weco 310 input (front panel).
2. Connect the RS-232 loopback connector to the RS-232 port (side of the instrument). Alternatively use wire links to either modify an RS-232 connector or connect across the RS-232 port as shown below.



RS-232 Connections

3. Press HP 37701A **AUX**, select **SELF TEST** (use **MORE** to bring up the SELF TEST field) and set the TEST TYPE for ALL TESTS.
4. Press HP 37701A **START/STOP** and verify that "TEST STATUS PASSED" is displayed at the end of ALL TESTS, approximately 7 minutes (Opt 004 approx 15 minutes).

T1 Tester Self Test

5. Disconnect the HP37701A TRANSMIT Weco 310 output from the RECEIVE Weco 310 input.
6. Connect the TRANSMIT Bantam output to the RECEIVE Bantam input (front panel).
7. Set the TEST TYPE for PATTERN TEST (use the  and  keys to bring up the PATTERN TEST field).
8. Press HP37701A **START/STOP** and verify that "TEST STATUS PASSED" is displayed at the end of the PATTERN test.
9. Disconnect the HP37701A TRANSMIT Bantam output from the RECEIVE Bantam input.
10. Take the 15 way Connector and use wire links to connect pins 1 to 3 and pins 9 to 11 (see figure below). Connect the modified 15 way connector to the TRANSMIT/RECEIVE D- Shell connector (front panel) this gives the required loopback.

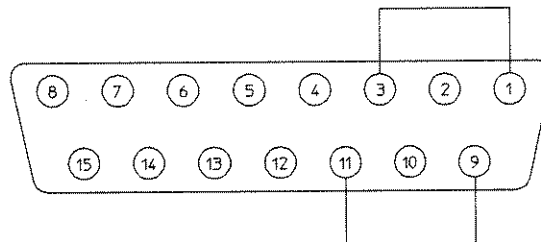

15 way connections on the pin out side of HP 1251-5503.

11. Press **START/STOP** and verify that "TEST STATUS PASSED" is displayed at the end of the PATTERN test.

Note



If a self test fails, each test can be run individually to discover the extent of the instrument malfunction. Refer to the service manual Troubleshooting to find out how to correct this failure.

T1 Self Tests, Order and Fail Codes

T1 Self Tests, Order and Fail Codes

When ALL TESTS is selected the individual tests (1 to 15)are performed in the order shown in the following table. Test 1 is a general test of the Control Processor Unit (CPU). Tests 2 to 15 use a comparison of measured results and expected results. The measurements are made on signals which are externally looped back from transmitter to receiver. If a test failure occurs, the failure code displayed indicates the part of the individual test which has failed. The test which failed is indicated by the group of failure codes shown in the following table. A more detailed list of fail codes is given with the remote control information in chapter 10.

Fail Code Group	Test	Test Number
1 to 99	CPU	1
100 to 299	Pattern	2
300 to 399	Frame	3
400 to 499	Line Code	4
500 to 599	Error Type	5
600 to 699	Error Ratio	6
700 to 799	Alarms	7
800 to 899	Line Interface	8
900 to 999	Level Measurement	9
1000 to 1099	Clock Recovery	10
1100 to 1199	Pulse Shape	11
1200 to 1299	Round Trip Delay	12
1300 to 1399	Slips	13
1400 to 1499	OOF and SEF	14
1500 to 1599	Signalling Bit	15

Auto Configure

Specifications

Framing, line code and pattern are automatically determined.

Description

The HP 37701A's ability to generate an Unframed, All Ones alarm is used to verify that the receiver will auto configure onto the incoming data.

Equipment

None

Procedure

1. Recall the HP 37701A DEFAULT SETTINGS as shown on page 9-5.
2. Connect the HP 37701A TRANSMIT output to the RECEIVE input.
3. Press HP 37701A **AUX**, select **ALARMS & LOOPING** and set the ALARM GENERATION for ALL ONES.
4. Press HP 37701A **FRAME**. Note that the display shows the FRAME set for D4, the CODE set for B8ZS and the PATTERN set for QRSS. Also, the T1 RECEIVE STATUS leds should show T1 PULSES, ALL ONES, FRAME LOSS, PATTERN LOSS and ERRORS all ON (the HISTORY led may also be on due to previous signal conditions).
5. Press AUTO/RESTART and verify that the display now shows the FRAME set for UNFRAMED, the CODE set for AMI and the PATTERN set for ALL ONES.

The T1 RECEIVE STATUS leds should now show T1 PULSES, PATTERN SYNC and ALL ONES all ON (History may also be on).

Pulse Mask (Option 001)

Pulse Mask (Option 001)

Specifications

Pulse Masks ANSI T1.403. The measured pulse is automatically fitted to the selected mask. For signal levels within $\pm 3\text{dBdsx}$ (nominal), pass/fail is indicated. Positive and negative pulses are displayed alternately.

Description

This test verifies the Pulse Mask measurement by connecting the HP 37701A TRANSMIT to RECEIVE and verifying that an isolated pulse from the received data meets the mask called up.

Equipment

None

Procedure

1. Recall the HP 37701A DEFAULT SETTINGS as shown on page 9-5.
2. Connect the HP 37701A TRANSMIT output to the RECEIVE input.
3. Press HP 37701A **FRAME** and select **UNFRAMED**.
4. Press HP 37701A **PATTERN** and select **1 IN 8**.
5. Wait 15 seconds. Press HP 37701A **AUX** and select **PULSE SHAPE**.
6. Ensure that both the positive and negative pulses displayed are within the mask shown and that T1.403 PASS is displayed adjacent to the mask (note: the display will alternate between positive and negative pulses continually).

Voice Frequency Output

Specifications

VF Output

Output Impedance:	600 ohm balanced (nominal)
Reference Level:	0dB TLP (nominal)
Dynamic Range:	+3dBm to -50 dBm relative
Frequency Response:	Within ± 0.25 dB from 300Hz to 3KHz (nominal)

Description

This test verifies the HP 37701A ability to demultiplex a single timeslot from an incoming T1 stream and decode it into a voice frequency signal. The volume control range is also exercised during this test.

Equipment

Oscilloscope	:HP 54201A/D (a 1700 series scope can be used)
Weco 310 to BNC Adapter	:HP 1251-3757

Procedure

1. Recall the HP 37701A DEFAULT SETTINGS as shown on page 9-5.
2. Connect the HP 37701A TRANSMIT output to the RECEIVE input. Connect the VF OUTPUT to the Oscilloscope 1Mohm input using the Weco 310 to BNC adapter.
3. Press HP 37701A **AUX** and select **SELF TEST** (use the **MORE** key to bring up the **SELF TEST** field). Set the TEST TYPE for SIG BITS (use the **←↑**, **↓→** and **MORE** keys to bring up the **SIG BITS** field).
4. Press HP 37701A **START/STOP** and verify that a 2 volts peak to peak (typically) sinewave with a period of 1.0ms is displayed. Slight stepping may be present on the waveform, but there should be no obvious breaks or other

Voice Frequency Output

visible distortion. (note: If the **SELF TEST** ends before this procedure has been completed, simply press the **START/STOP** key to resume the test).

5. Press HP 37701A **VOL** to verify that the 1 KHz tone is audible from the Loudspeaker. Vary volume level using the **VOL** control keys to ensure that the tone can be increased and reduced to a point where no tone is audible from the loudspeaker.



Recovered Loop Timing

Specifications

Transmitter timing: The transmitter can be timed from the clock recovered at the receiver (loop timed)

Description

This test verifies that the transmitter output data rate can be timed by the received data rate.

Equipment

Synthesizer	: HP 3325B
Frequency Counter	: HP 5316B Option 001
Weco 310 to BNC Adapter	: HP 1251-3757
Balanced to Unbalanced Converter	: HP 15508B
75 Ohm Termination	: HP 15522-80010
T Connector	

Procedure

1. Recall the HP37701A DEFAULT SETTINGS as shown on page 9-5.
2. Connect the Synthesizer SIGNAL output to the HP37701A RECEIVE input using the Weco 310 to BNC Adapter. Connect the HP37701A TRANSMIT output to the Frequency Counter via the Balanced to Unbalanced Converter terminated in the 75 Ohm Termination (T Connector required).
3. Press HP37701A **FRAME** and select **UNFRAMED**.
4. Press HP37701A **CODE** and select **AMI**.
5. Press HP37701A **PATTERN** and select **ALL ONES**.
6. Set the HP37701A *T1 INTERFACE* **TRANSMIT TIMING** to RECOVD (LOOP).

Recovered Loop Timing

7. Set the Synthesizer to generate a 772.110 KHz sinewave, 500mV pk-pk, a.c. coupled signal.
8. Verify that the Frequency Counter tracks the received Synthesizer frequency - 772.11 KHz (Set the Frequency Counter to trigger on positive transitions and adjust the trigger level for a reading. If the Frequency Counter reads incorrectly, adjust the Frequency Counter trigger level for a reading of 1.1 volts at the trigger level output - use a DC Voltmeter to measure this).
9. Adjust the Synthesizer to generate a 771.890 KHz signal and verify that the Frequency Counter tracks the received Synthesizer frequency - 771.89 KHz.



Internal Transmitter Clock

Specifications

Internal Tx Clock

Frequency:	1.544 MHz
Stability:	± 5 ppm 0 to 40°C (nominal) ± 10 ppm 0 to 50°C
Ageing:	± 2 ppm per year typical

Description

This test verifies that the Internal Transmitter Clock frequency is within 12PPM with the provision that the instrument has been through it's yearly calibration cycle.

Equipment

Frequency Counter	: HP 5316B Option 001
Balanced to Unbalanced Converter	: HP 15508B
75 Ohm Termination	: HP 15522-80010
T Connector	

Procedure

1. Recall the HP 37701A DEFAULT SETTINGS as shown on page 9-5.
2. Connect the HP 37701A TRANSMIT port to the Frequency Counter via the Balanced to Unbalanced Converter. Terminate the Frequency Counter input in 75 Ohms (use the T Connector).
3. Press HP 37701A **FRAME** and select **UNFRAMED**.
4. Press HP 37701A **PATTERN** and select **ALL ONES**.
5. Ensure that the Frequency Counter reads between 772,009.3Hz and 771,990.7Hz.

Alarm Leds (red)

Alarm Leds (red)

This is a functional test of the Alarm leds

Equipment

None

Procedure

1. Connect the HP37701A TRANSMIT output to the RECEIVE input.
2. Recall the HP 37701A DEFAULT SETTINGS as shown on page 9-5.
3. If either the POWER LOSS led or the HISTORY led in the T1 RECEIVE STATUS area of the front panel is on, then press **RESET HISTORY**.
4. The following *T1 RECEIVE STATUS* leds should be on: T1 PULSES, FRAME SYNC, PATTERN SYNC and B8ZS.
5. Disconnect the Transmit port from the Receive port and ensure that the green leds are off and that the SIGNAL LOSS, FRAME LOSS, PATTERN LOSS, SLIP and HISTORY leds are on. The SLIP led depends on the timing of the signal path break and may not always come on.
6. Reconnect the Transmit port to the Receive port.
7. Press HP 37701A **AUX**, select **ALARMS AND LOOPING** and set the ALARM GENERATION for All ONES.
8. Ensure that the ALL ONES, FRAME LOSS, PATTERN LOSS, ERRORS and HISTORY leds are on. T1 PULSES should be the only green led on.
9. Set the ALARM GENERATION to OFF.
10. Press HP 37701A **FRAME** and select **UNFRAMED**.
11. Press HP 37701A **CODE** and select **AMI**.
12. Press HP 37701A **PATTERN** and select **USER WORD**. Set the USER WORD for a 17 bit length (10000000000000000) and ensure that the EXCESS ZEROS and ONES DENSITY leds are on. T1 PULSES and PATTERN SYNC are the only green leds on.

9-16 T1 Tester Performance Tests

13. Decrease the USER WORD length to 16 bits and ensure that the EXCESS ZEROS led goes off while the ONES DENSITY led remains on. T1 PULSES and PATTERN SYNC are the only green leds on.
14. Decrease the USER WORD length to 9 bits, ensure that the ONES DENSITY led is on, then decrease the USER WORD length to 8 bits and ensure that the ONES DENSITY led goes off. T1 PULSES and Pattern SYNC are the only green leds on.
15. Press HP 37701A **LOOP UP** and ensure that the LOOP UP led comes on momentarily (ignore other leds which momentarily flash on). T1 PULSES and PATTERN SYNC are the only green leds on.
16. Press HP 37701A **LOOP DOWN** and ensure that the LOOP DOWN led comes on for approximately 8 seconds (ignore other leds which momentarily flash on). T1 PULSES and PATTERN SYNC are the only leds on.
17. Switch the instrument power off then on and ensure that the POWER LOSS led and the HISTORY leds are on. T1 PULSES and PATTERN SYNC are the only green leds on.
18. Press HP 37701A **START/STOP** to clear the POWER LOSS led and the HISTORY led.
19. Disconnect the Transmit port from the Receive port then reconnect again. Ensure that the HISTORY led is on. Press **SHOW HISTORY** to view the results of disconnection (HISTORY LED flashes once key is pressed).
20. Press HP 37701A **RESET HISTORY**. Ensure that the HISTORY led goes off and that when **SHOW HISTORY** is pressed, the only Red Led to come on is a flashing HISTORY led.
21. Press **RESET HISTORY** to disable the flashing HISTORY led.

Performance Tests

(see page 9-6)

T1 Tester Self Test

T1 Tester Self Test

Description

These tests give a high degree of confidence that the HP 37701A is operating to its warranted specification. A description of each test is given on page 9-8.

Equipment

RS-232 Loopback Connector : HP 5060-4462
15 Way Connector : HP 1251-5503

Procedure

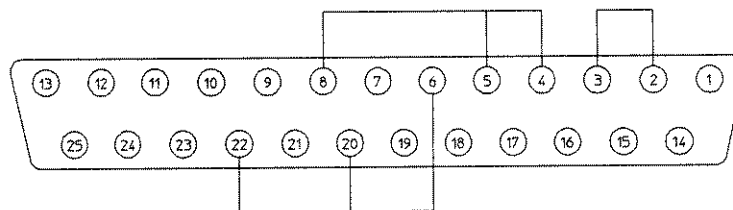

1. Connect the HP 37701A TRANSMIT Weco 310 output to the RECEIVE Weco 310 input (front panel).
2. Connect the RS-232 loopback connector to the RS-232 port (side of the instrument). Alternatively use wire links to either modify an RS-232 connector or connect across the RS-232 port as shown below.



RS-232 Connections

3. Press HP 37701A **AUX**, select **SELF TEST** (use **MORE** to bring up the SELF TEST field) and set the TEST TYPE for ALL TESTS.
4. Press HP 37701A **START/STOP** and verify that "TEST STATUS PASSED" is displayed at the end of ALL TESTS, approximately 7 minutes (Opt 004 approx 15 minutes).

T1 Tester Self Test

5. Disconnect the HP37701A TRANSMIT Weco 310 output from the RECEIVE Weco 310 input.
6. Connect the TRANSMIT Bantam output to the RECEIVE Bantam input (front panel).
7. Set the TEST TYPE for PATTERN TEST (use the  and  keys to bring up the PATTERN TEST field).
8. Press HP37701A  and verify that "TEST STATUS PASSED" is displayed at the end of the PATTERN test.
9. Disconnect the HP37701A TRANSMIT Bantam output from the RECEIVE Bantam input.
10. Take the 15 way Connector and use wire links to connect pins 1 to 3 and pins 9 to 11 (see figure below). Connect the modified 15 way connector to the TRANSMIT/RECEIVE D- Shell connector (front panel) this gives the required loopback.

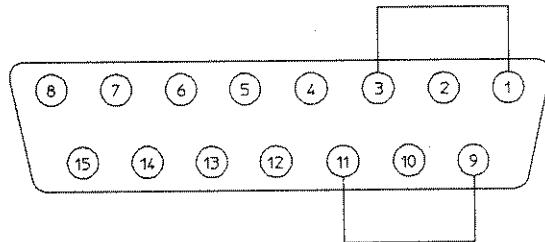

15 way connections on the pin out side of HP 1251-5503.

11. Press  and verify that "TEST STATUS PASSED" is displayed at the end of the PATTERN test.

Note



If a self test fails, each test can be run individually to discover the extent of the instrument malfunction. Refer to the service manual Troubleshooting to find out how to correct this failure.

Same as page 9-8

T1 Self Tests, Order and Fail Codes

T1 Self Tests, Order and Fail Codes

When ALL TESTS is selected the individual tests (1 to 15) are performed in the order shown in the following table. Test 1 is a general test of the Control Processor Unit (CPU). Tests 2 to 15 use a comparison of measured results and expected results. The measurements are made on signals which are externally looped back from transmitter to receiver. If a test failure occurs, the failure code displayed indicates the part of the individual test which has failed. The test which failed is indicated by the group of failure codes shown in the following table. A more detailed list of fail codes is given with the remote control information in chapter 10.

Fail Code Group	Test	Test Number
1 to 99	CPU	1
100 to 299	Pattern	2
300 to 399	Frame	3
400 to 499	Line Code	4
500 to 599	Error Type	5
600 to 699	Error Ratio	6
700 to 799	Alarms	7
800 to 899	Line Interface	8
900 to 999	Level Measurement	9
1000 to 1099	Clock Recovery	10
1100 to 1199	Pulse Shape	11
1200 to 1299	Round Trip Delay	12
1300 to 1399	Slips	13
1400 to 1499	OOF and SEF	14
1500 to 1599	Signalling Bit	15

Same as 9-15

Internal Transmitter Clock

Internal Transmitter Clock

Specifications

Internal Tx Clock

Frequency: 1.544 MHz
Stability: ± 5 ppm 0 to 40°C (nominal)
 ± 10 ppm 0 to 50°C
Ageing: ± 2 ppm per year typical

Description

This test verifies that the Internal Transmitter Clock frequency is within 7PPM with the provision that the instrument has been through it's yearly calibration cycle.

Equipment

Frequency Counter : HP 5316B Option 001
Balanced to Unbalanced Converter : HP 15508B
75 Ohm Termination : HP 15522-80010
T Connector

Procedure

1. Recall the HP 37701A DEFAULT SETTINGS as shown on page 9-5.
2. Connect the HP 37701A TRANSMIT port to the Frequency Counter via the Balanced to Unbalanced Converter. Terminate the Frequency Counter input in 75 Ohms (use the T Connector).
3. Press HP 37701A **FRAME** and select **UNFRAMED**.
4. Press HP 37701A **PATTERN** and select **ALL ONES**.
5. Ensure that the Frequency Counter reads between 772,009.3Hz and 771,990.7Hz.

Transmitter Pattern Generation

Specifications

QRSS: $2^{20}-1$ PRBS, $D_{20}+D_{17}+1=0$ with 14 zero limit

$2^{15}-1$ PRBS: $D_{15}+D_{14}+1=0$

$2^{20}-1$ PRBS: $D_{20}+D_{17}+1=0$

$2^{23}-1$ PRBS: $D_{23}+D_{18}+1=0$

All ones

1:1 (101010 ...)

1:7 (01000000 ...)

3 in 24 (01000100 00000000 00000100 ...)

55 OCTET (Network Equipment Technologies)

User programmable word, length 3 to 24 bits

Description

A Signature Multimeter is used to verify that the HP37701A transmitter produces the above specified and user defined patterns. Since the output is set to give a repeating pattern the Signature Multimeter produces a unique signature for each pattern.

Equipment

Signature Multimeter : HP 5005B

Accessory Cable : HP 15901-60002

Procedure

1. Set the HP37701A Power switch to OFF.
2. Connect the Accessory Cable to the ACCESSORY port at the side of the instrument.
3. Set the Signature Multimeter as follows:

Transmitter Pattern Generation

FUNCTION : NORM

THRESHOLD DATA (TTL) : High=2.00V, Low= 0.80V

CLOCK (TTL) : 1.40V

ST-SP (TTL) : 1.40V

POLARITY CLOCK : Positive Edge

START : Positive Edge

STOP : Positive Edge

4. Connect the Signature Multimeter probes as follows (note: It will be necessary to attach a wire to pin 15 to allow two probes to be connected):

Probe	Accessory Cable Connection
Start (green)	15
Stop (red)	15
Clock (yellow)	34
Gnd (black)	24

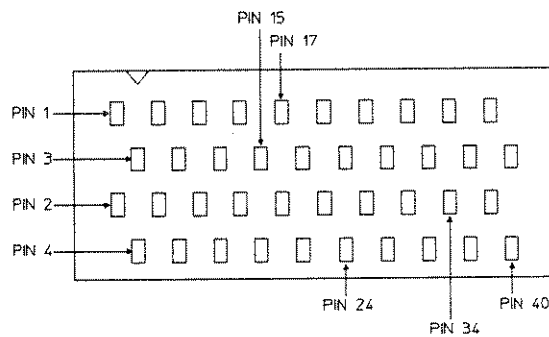

Accessory Cable Pinout

5. Set the HP37701A Power switch to ON.
6. Recall the HP37701A DEFAULT SETTINGS as shown on page 9-5.
7. Set the HP37701A to **FRAME** and select **UNFRAMED**.

Transmitter Pattern Generation

8. Press HP37701A **PATTERN**, select for the patterns shown in the table below and verify the unique signature on the Signature Multimeter using the probe connected to Accessory Cable pin 40:

Pattern	Signature
QRSS	PPA5
3 IN 24	AC1P
ALL ONES	7339
1 IN 8	0P5C
1 IN 2	H117
55 OCTET	FC67
USER WORD	8C6F
2 ¹⁵ -1	5A8H
2 ²⁰ -1	F149 - allow for settling time
2 ²³ -1	A38U - allow for settling time

A/O 3/24/84 H.P. says this does NOT work. J.L.

Transmitter Line Coding

Transmitter Line Coding

Specifications

Line Code: AMI, B8ZS

Description

A Signature Multimeter is used to verify that the HP37701A transmitter produces the above specified line coding. Since the output is set to give a repeating pattern the Signature Multimeter produces a unique signature for each pattern.

Equipment

Signature Multimeter : HP 5005B
Accessory Cable : HP 15901-60002

Procedure

1. Set the HP37701A Power switch to OFF.
2. Connect the Accessory Cable to the ACCESSORY port.
3. Set the Signature Multimeter as follows:

FUNCTION : NORM

THRESHOLD DATA (TTL) : High=2.00V, Low= 0.80V

CLOCK (TTL) : 1.40V

ST-SP (TTL) : 1.40V

POLARITY CLOCK : Positive Edge

START : Positive Edge

STOP : Positive Edge

4. Connect the Signature Multimeter probes as follows (note: It will be necessary to attach a wire to pin 15 to allow two probes to be connected):

Transmitter Line Coding

Probe	Accessory Cable Connection
Start (green)	15
Stop (red)	15
Clock (yellow)	34
Gnd (black)	24

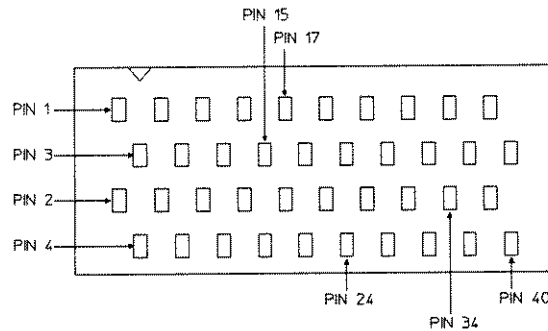

Accessory Cable Pinout

- Set the HP37701A Power switch to ON.
- Recall the HP37701A DEFAULT SETTINGS as shown on page 9-5.
- Press HP37701A **FRAME** and select **UNFRAMED**.
- Press HP37701A **CODE** and select **AMI**.
- Press HP37701A **PATTERN** and select **USER WORD**. Set the USER word to 12 bit length (100000000000).
- Press HP37701A **CODE**, select as shown in the table below and verify the unique signature on the Signature Multimeter using the probe connected to Accessory Cable pin 40:

CODE	Signature
AMI	0814
B8ZS	08FH

Transmitter Line Coding

Transmitter Frame Pattern

Specifications

Framing: D4, ESF, SLC-96 (Ft only)

Description

A Signature Multimeter is used to verify that the HP37701A transmitter continually produces the above specified framing patterns. Since the output is set to give a repeating pattern the Signature Multimeter produces a unique signature for each pattern.

Equipment

Signature Multimeter : HP 5005B
Accessory Cable : HP 15901-60002

Procedure

1. Set the Power switch to OFF.
2. Connect the Accessory Cable to the ACCESSORY port (at the side of the instrument).
3. Set the Signature Multimeter as follows:

FUNCTION : NORM

THRESHOLD DATA (TTL) : High=2.00V, Low= 0.80V

CLOCK (TTL) : 1.40V

ST-SP (TTL) : 1.40V

POLARITY CLOCK : Positive Edge

START : Positive Edge

STOP : Positive Edge

Transmitter Frame Pattern

4. Connect the Signature Multimeter probes as follows (note: It will be necessary to attach a wire to pin 17, to allow two probes to be connected):

Probe	Accessory Cable Connection
Start (green)	17
Stop (red)	17
Clock (yellow)	34
Gnd (black)	24

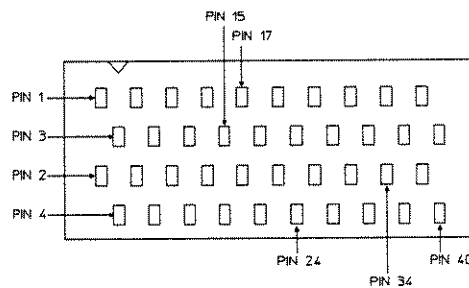

Accessory Cable Pinout

5. Set the HP37701A Power Switch to ON.
6. Recall the HP37701A DEFAULT SETTINGS as shown on page 9-5.
7. Press HP37701A **FRAME** and select **ESF**.
8. Press HP37701A **PATTERN** and select **1 IN 2**.
9. Press HP37701A **FRAME**, to select as per the table below. Use the Signature Multimeter to verify the signatures at pin 40. Note, any of the ESF signatures list below are valid.

Transmitter Frame Pattern

FRAME	Signature
ESF	U5U7, 44FU, U98A, 3224, F54P, 2U66, 64P9 or U457
D4	333C
SLC96	U880

Transmitter Error Add

Specifications

Tx Error Add

Types: Logic

Rates: Selectable 10^{-3} , 10^{-4} , 10^{-5} , 10^{-6} or 10^{-7} , or SINGLE

Description

The ability of the HP37701A transmitter to generate various error rates is verified by inserting errors into a repeating AMI (0000) pattern and using a Frequency Counter to count the error rate. When errors are inserted, zeros become ones at a rate dependant on the error ratio. For example, if a 1544kb/s rate has errors inserted at $1E-3$, then the positive and negative ones appear at a 1544 Hz ($1544\text{kb/s} \times 1E-3$) rate.

Note



In the following procedure the Frequency Counter triggers on the positive pulses therefore the reading on the counter will be at half the error rate (for the example above, 772Hz)

Equipment

Frequency Counter : HP 5316B Option 001
Balanced to Unbalanced Converter : HP 15508B
75 Ohm Termination : HP 15522-80010
T Connector

Procedure

1. Recall the HP37701A DEFAULT SETTINGS as shown on page 9-5.
2. Connect the HP37701A TRANSMIT output to the Frequency Counter input via the Balanced to Unbalanced Converter. Terminate the Frequency Counter in 75 Ohms (use the T Connector).
3. Press HP37701A **FRAME** and select **UNFRAMED**.

Transmitter Error Add

4. Press HP37701A **CODE** and select **AMI**.
5. Press HP37701A **PATTERN** and select **USER WORD** then set the **USER WORD LENGTH** to 4 (0000).
6. Set the HP37701A **TRANSMIT ERROR INSERT RATE** to 1E-3.
7. Verify that the Frequency Counter reads 772 Hz +/- 0.0093 Hz (Set the Frequency Counter to trigger on positive transitions, and adjust for a reading. If the Frequency Counter reads incorrectly, adjust the Frequency Counter trigger level for a reading of 1.1 Volt at the trigger level output - use a DC Voltmeter to measure this).
8. Press HP37701A **AUX** and select **ALARMS & LOOPING**. Set the **TRANSMIT ERROR INSERT RATE** to USER PRGM. Use the **↵** and **⇐** keys to select USER PROGRAM ERROR RATE.

Select the rate using the softkeys and check the Frequency Counter reading is as shown in the table below (set the Frequency Counter attenuation to × 20). Note: Frequency Counter period mode could be used in this test.

Error Add Rate	Frequency Counter Reading
1E-3	772 Hz +/- 0.0093 Hz
1E-4	77.2 Hz +/- 0.00093 Hz
1E-5	7.72 Hz +/- 0.000093 Hz
1E-6	772 x 10 ⁻³ Hz +/- 0.0000093 Hz
1E-7	77.2 x 10 ⁻³ Hz +/- 0.00000093 Hz

Error Add - Single

9. Set the HP37701A **TRANSMIT ERROR INSERT RATE** to ERR FREE.
10. Set the Frequency Counter to TOT START (measures absolute count).
11. Press HP37701A **SNGLE** 6 times to insert 6 errors.
12. Verify that the reading on the Frequency Counter is 3 counts (note: Single errors inserted are of opposite polarity therefore the Frequency Counter, being triggered on the positive pulses, reads only half the errors inserted).

Transmitter Output

Specifications

Output

Impedance:	100 ohm balanced (nominal)
Pulse Shape:	meets ANSI Standard T1.102-1987
Pulse Height:	$\pm 3V \pm 600mv$ (at the center)
Pulse Width:	324 ± 30 nsecs (measured at half amplitude)
Rise & Decay Time:	75 ns maximum. (10% to 90%)

Description

This test verifies the transmitter output level and pulse shape.

Equipment

Oscilloscope	: HP 54201A/D
Dual BNC to Weco 310 Cable	: see page 9-3
Thinkjet Printer	: HP 2225A

Procedure

1. Recall the HP37701A DEFAULT SETTINGS as shown on page 9-5.
2. Connect the TRANSMIT output to the Oscilloscope channels 1 and 2 via the Dual BNC to Weco 310 Cable.
3. Connect the Thinkjet printer, set to LISTEN ALWAYS, to the Oscilloscope via HP-IB.
4. Press HP37701A **FRAME** and select **UNFRAMED**.
5. Press HP37701A **CODE** and select **AMI**.
6. Press HP37701A **PATTERN** and select **1 IN 8**.
7. Configure the Oscilloscope as follows, then display Channel 1-2

Transmitter Output

Status [Configuration] -----Status: Acquired Frame 00059----

Setup Label [REDACTED]

Channel	[1-2]	Inputs	Input 1-2	Timebase
Range		4.0 V	8.0 V	Sampling @ 200 MHz
Offset		0.000 V	0.000 V	Mode [Trig'd]
Probe		[1:1]	[1:1]	Range 1.00 μ s
Coupling		[dc] [50 Ω]	[dc] [50 Ω]	Acquire [Real Time]
Store Mode		[Ave] [256]	[Ave] [256]	Delay -190.000 ns
Auto Scale		[Disabled]	[Disabled]	Reference [Left]
Label		[REDACTED]	[REDACTED]	Auto Scale [Disabled]

Trigger		* Refer to State Trigger Menus for Assignment and Sequence
Mode	[Analog Only]	
Analog Source	[Chan 1]	[+ Slope]
Level	[Adjust]	1.000 V
Probe	[1:1]	
Auto Scale	[Disabled]	
On Event	00001	
Coupling	[dc] [50 Ω]	

- Adjust the Oscilloscope Delay to position the positive peak pulse amplitude at mid-pulse-width point on the third division in from the left screen edge.
- Measure the peak pulse amplitude at mid-pulse-width using the Oscilloscope and verify that this is between 2.4V and 3.6V.
- Measure the pulse width at half the pulse amplitude and verify that this is between 294ns and 354ns.
- Measure the rise and decay time (10% to 90%) of the pulse and verify that this is no more than 73ns.
- Adjust the Oscilloscope Range (gain) to set the peak pulse amplitude at the mid-pulse-width point one division down from the top of the screen (3V).

Transmitter Output

13. Set the Oscilloscope SYSTEM to Peripherals and set for TALK ONLY and PRINTER.
14. Use the Oscilloscope HARDCOPY function to obtain a printout of the displayed pulse.
15. Place the mask, shown in the following figure, over the pulse and ensure that the pulse falls within the mask (a transparent copy of the following figure should be used).

-----Status: Acquired Frame 04661-----

Freq **I** - ---- Hz
Rise **I** - ---- s

Graph **I** ---- V/div ---- V ---- s/div ---- s

1: **I** Mem 1-3

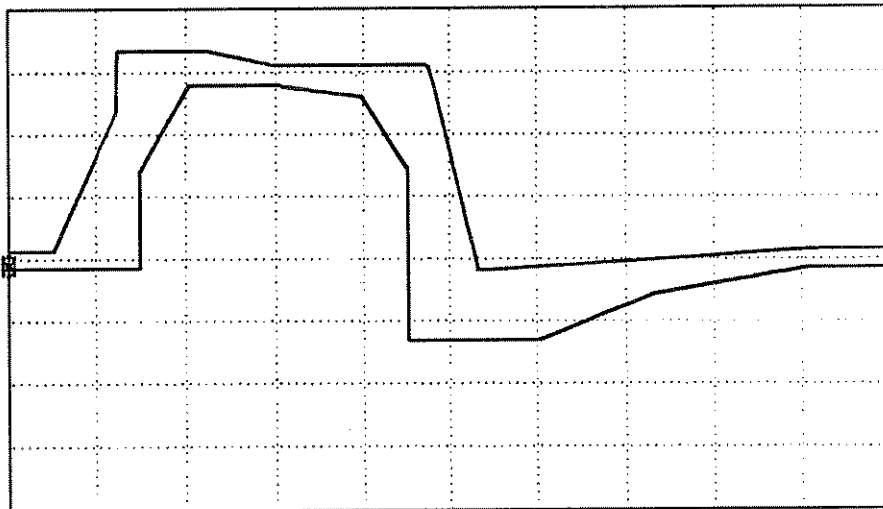

16. Adjust the Oscilloscope Delay to position the negative pulse at mid-pulse-width point on the third division in from the left screen edge then reset the Range (gain) to 1.00 V/div.
17. Repeat steps 9 to 15 for the negative pulse (note: step 12 will be one division UP from the bottom of the screen (-3V)).

Transmitter Output

Recovered Clock Frequency Measurement

Specifications

Recovered Clock Frequency Measurement

Resolution:	1 Hz
Accuracy:	$\pm 5\text{ppm}$ 0 to 40°C (nominal) $\pm 10\text{ppm}$ 0 to 50°C
Ageing:	$\pm 2\text{ppm}$ per year, typical

Description

This test verifies that the recovered clock frequency measurement capability is within 12 ppm with the provision that the instrument has been through its yearly calibration cycle.

Note



A Synthesizer is used to generate a signal at 772 KHz (half the data rate) which corresponds to a ternary all ones signal at the receiver input.

Equipment

Synthesizer	: HP 3325B
Frequency Counter	: HP 5316B Option 001
Weco 310 to BNC Adapter	: HP 1251-3757
T Connector	

Procedure

1. Recall the HP37701A DEFAULT SETTINGS as shown on page 9-5.
2. Equipment set-up: Place the T Connector on the Synthesizer SIGNAL output. Connect the Synthesizer to the HP37701A RECEIVE input using the Weco 310 to BNC Adapter. Also, connect the Synthesizer to the Frequency Counter.
3. Press HP37701A **FRAME** and select **UNFRAMED**.

Recovered Clock Frequency Measurement

4. Press HP37701A **PATTERN** and select **ALL ONES**.
5. Press HP37701A **CODE** and select **AMI**.
6. Set the Synthesizer to generate a 772 KHz sinewave, 500mV pk-pk, a.c. coupled.
7. Adjust the Synthesizer frequency to set it for 772000 Hz +/- 0.75 Hz as read on the Frequency Counter.
8. Press HP37701A **RESULTS** and select **SIGNAL RESULTS**.
9. Verify that the HP37701A FREQUENCY displayed is between 1544019 MHz and 1543981 MHz.

Receiver Equalization, Gain and Level Measurement

Specifications

DSX-MON For connection to protected monitor points. Automatic gain control (AGC) between 0 and +36dB compensates for the flat loss at these points

Rate: 1.544 Mb/s \pm 130 ppm
Input Impedance: 100 ohms nominal
Dynamic Range: +6 to -30dB relative to DSX-1 level

BRIDGE For use where the circuit is already terminated. Specification as TERMINATED, except input impedance is 1kohm (nominal).

TERMINATED For terminating unprotected DSX-1 points or line terminations up to -36db. Frequency dependent gain is provided.

Input Impedance: 100 ohms nominal
Dynamic Range: 6V pk-pk to 95mV pk-pk or 0 to +36db equalization @ 772kHz

Description

This test verifies the receiver operation over the specified input level range and that the level measurement accuracy is met. A synthesizer is used to generate a signal at half the data rate which corresponds to a ternary all ones signal. Setting the level from 6.5dBdsx (23dBm) to -36.5dBdsx (-20dBm) relative to the nominal signal level allows us to verify Equalization in the receive TERM and BRIDGE mode and Automatic Gain in the receive DSX-MON mode. Level measurement accuracy is verified in the receive TERM mode. A mismatch between the synthesizer and HP37701A impedance, allows us to generate the required levels into the HP37701A.

Receiver Equalization, Gain and Level Measurement

Equipment

Synthesizer : HP 3325B
AC Voltmeter : HP 3458A
Resistor, 100 Ohms : HP 0757-0178
Weco 310 to BNC Adapter : HP 1251-3757
T Connector

Procedure

1. Recall the HP37701A DEFAULT SETTINGS as shown on page 9-5.
2. Equipment set up: Place the T connector on the Synthesizer SIGNAL output. Connect the Synthesizer to the HP 37701A RECEIVE input using the WECO to BNC adapter. Also, connect the Synthesizer to the AC Voltmeter.
3. Press HP37701A **FRAME** and select **UNFRAMED**.
4. Press HP37701A **CODE** and select **AMI**.
5. Press HP37701A **PATTERN** and select **ALL ONES**.
6. Press HP37701A **RESULTS** and select **ERROR RESULTS**.
7. Set the Synthesizer as follows:

Frequency : 772 KHz
Function : Sinewave

DSX-MON (Automatic Gain)

8. Set the Synthesizer to 9.7Vp-p and fine tune it until the AC Voltmeter reads 4.484Vrms (6.5dBdsx). note: set for AC Voltmeter readings shown and disregard the additional digits throughout these tests.
9. Press HP37701A **START/STOP** and verify that there are no errors displayed.
10. Set the Synthesizer to 139mVp-p and fine tune it until the AC Voltmeter reads 63.3mVrms (-30.5dBdsx) then repeat step 9.

Receiver Equalization, Gain and Level Measurement

TERM (Equalization)

11. Press HP37701A *T1 INTERFACE* **INTERFACE** to select TERM.
12. Set the Synthesizer to 4.9Vp-p and fine tune it until the AC Voltmeter reads 2.247Vrms (0.5dBdsx).
13. Press HP37701A **START/STOP** and verify that there are no errors displayed.
14. Set the Synthesizer to 70.4mVp-p and fine tune it until the AC Voltmeter reads 31.7Vrms (-36.5dBdsx), then repeat step 13.

BRIDGE (Equalization)

15. Press the HP37701A *T1 INTERFACE* **INTERFACE** to select BRIDGE.
16. Connect the 100 Ohm resistor across the AC Voltmeter terminals and repeat steps 12 to 14.
17. Remove the 100 Ohm resistor.

TERM (Level Measurement)

18. Press HP37701A *T1 INTERFACE* **INTERFACE** to select TERM.
19. Press HP37701A **RESULTS** and select **SIGNAL RESULTS**.
20. Set the Synthesizer to the synth v p-p level shown in the table below and fine tune it until the AC Voltmeter reads as shown in the Amplitude *AC Vrms* column then verify that the RECEIVER LEVEL limits for *dBdsx* and *Volts Pk-Pk* given are met.

Receiver Equalization, Gain and Level Measurement

Amplitude		RECEIVER LEVEL	
<i>Synth Vp-p</i>	<i>AC Vrms</i>	<i>dBdsz</i>	<i>Volts Pk-Pk</i>
9.23	4.233	+5 to +7	10.75 to 13.15
4.66	2.12	-1 to +1	5.4 to 6.6
1.45	0.67	-8 to -12	1.7 to 2.1
0.467	0.212	-17 to -23	0.42 to 0.78
0.075	0.0336	-33 to -39	0.07 to 0.12

Wander/Slips Measurement (Option 001)

Specifications

Measurements Estimated Clock Slips, Estimated Frame Slips, Positive Peak Wander, Negative Peak Wander, Peak to Peak Wander, Time Interval Error

Timing Reference DSX Input

Rate: 1.544 Mb/s \pm 130 ppm. There is an indication if no reference signal is present.

Wander Measurement

Bandwidth: Low pass response -3dB at 10Hz (nominal)

Resolution: 0.125 UI

Accuracy: \pm 0.125 UI \pm 0.5% of reading, for wander frequency up to 1Hz

Description

The Wander measurement is verified in two steps - First, the Receiver and Timing Reference inputs have the HP 37701A Transmitter coupled simultaneously to both. This exercises the wander measurement circuitry by using a division of the Reference input to latch the wander counters and so enable a count of the Receiver input bits. With both inputs being the same, the Wander measurement should be zero based on the expected count being correct. Secondly, two sources are used, one to provide an input to the Receiver port and the other as an input to the Timing Reference port. The sources frequencies are locked together but with one source offset by a known frequency. This allows us to measure for an expected number of bit Slips.

Equipment

Synthesizer/Function Generator (2 off) : HP 3325B*
Weco 310 to BNC Adapters (3 off) : HP 1251-3757
T Connector

*A HP 3335 may be substituted for one of the HP 3325B's.

Wander/Slips Measurement (Option 001)

Procedure

Wander

1. Recall the HP 37701A DEFAULT SETTINGS as shown on page 9-5.
2. Connect the HP 37701A TRANSMIT output to the RECEIVE input and the TIMING REF DS1 INPUT simultaneously using the WECO 310 to BNC Adapters (T Connector required).
3. Press HP 37701A **RESULTS**, select **SLIPS/WANDER** and set the DISPLAY for **WANDER** (note: the **WANDER**, **SLIPS** or **GRAPH** soft keys are revealed by moving the **←↑** and **↓→** keys to the **WANDER**, **SLIP** or **GRAPH** field).
4. Press **START/STOP** and verify that the display shows POSITIVE PEAK WANDER and NEGATIVE PEAK WANDER readings of 0.000 ± 0.125 BITS.
5. Remove the input from the TIMING REF DS1 INPUT and ensure that the display shows NO REF for POSITIVE PEAK WANDER, NEGATIVE PEAK WANDER, PEAK TO PEAK WANDER & TIME INTERVAL ERRORS.

Wander/Slips Measurement (Option 001)

Slips and Wander

6. Connect the equipment as shown below:

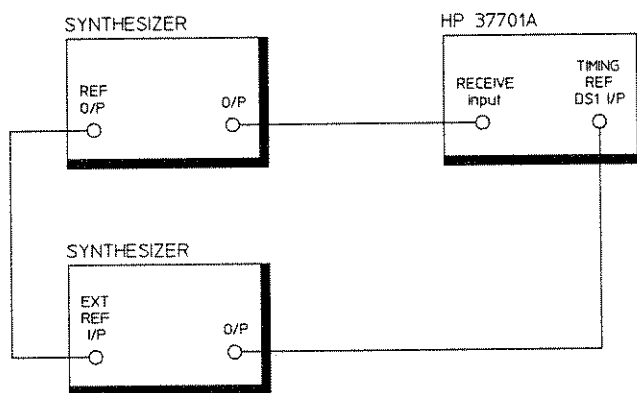

7. Press HP 37701A **TEST PERIOD**, select **USER PROGRAM** and set the TEST PERIOD for 1 MINUTE.
8. Press HP 37701A **RESULTS** and set the DISPLAY for SLIPS
9. Press HP 37701A **FRAME** and select **UNFRAMED**.
10. Press HP 37701A **CODE** and select **AMI**.
11. Press HP 37701A **PATTERN** and select **ALL ONES**.
12. Set both Synthesizers amplitudes to 500mV pk to pk, ac coupled.
13. Set the Synthesizer connected to the RECEIVE input to generate a sinewave at 772092.36Hz and the Synthesizer connected to the TIMING REF DS1 INPUT to generate a sinewave at 772100.36Hz.
14. Press HP 37701A **START/STOP** and verify that the display shows the following at the end of the test period:

Wander/Slips Measurement (Option 001)

UNCONTROLLED SLIPS : N/A
CONTROLLED SLIPS : N/A
ESTIMATED FRAME SLIPS : -4 to -5
ESTIMATED BIT SLIPS : -959 to -961 BITS

15. Press HP 37701A **RESULTS**, set the DISPLAY for WANDER and verify that the display shows the following:

POSITIVE PEAK WANDER : 0.000 BITS
NEGATIVE PEAK WANDER : 955.125 to 964.875 BITS
PEAK TO PEAK WANDER : 955.125 to 964.875 BITS
TIME INTERVAL ERROR : -955.125 to -964.875 BITS
PEAK TO PEAK 15 MINUTES :.... BITS
PEAK TO PEAK 2 HOURS :.... BITS

16. Set the DISPLAY for SLIPS.

17. Set The Synthesizer connected to the RECEIVE input to generate 771891.64Hz and the Synthesizer connected to the TIMING REF DS1 INPUT to generate 771899.64 Hz and repeat steps 14 to 16.
18. Swop over the HP 37701A RECEIVE input with the TIMING REF DS1 INPUT, press HP 37701A **START/STOP** and verify that the display shows the following at the end of the test period:

UNCONTROLLED SLIPS : N/A
CONTROLLED SLIPS : N/A
ESTIMATED FRAME SLIPS : 4 to 5
ESTIMATED BIT SLIPS : 959 to 961

19. Set the DISPLAY for WANDER and verify that the display shows the following:

POSITIVE PEAK WANDER : 955.125 to 964.875 BITS
NEGATIVE PEAK WANDER : 0.000 BITS
PEAK TO PEAK WANDER : 955.125 to 964.875 BITS
TIME INTERVAL ERROR : 955.125 to 964.875 BITS
PEAK TO PEAK 15 MINUTE :.... BITS
PEAK TO PEAK 2 HOURS :.... BITS

Wander/Slips Measurement (Option 001)

Simplex Current Measurement

Specifications

Range: from ± 10 to ± 200 mA (Unsigned)
Accuracy: $5\% \pm 1$ mA
Resolution: 1 mA

Description

This test verifies that the HP 37701A will complete the current path and make a measure of Simplex Current.

Equipment

DC Power Supply : HP 6205B
DC Voltmeter : HP 3456A
33 Ohm, 1%, 5W Resistor : 0811-0563

Simplex Current Measurement

Procedure

1. Recall the HP 37701A DEFAULT SETTINGS as shown on page 9-5.
2. Connect the equipment as shown below:

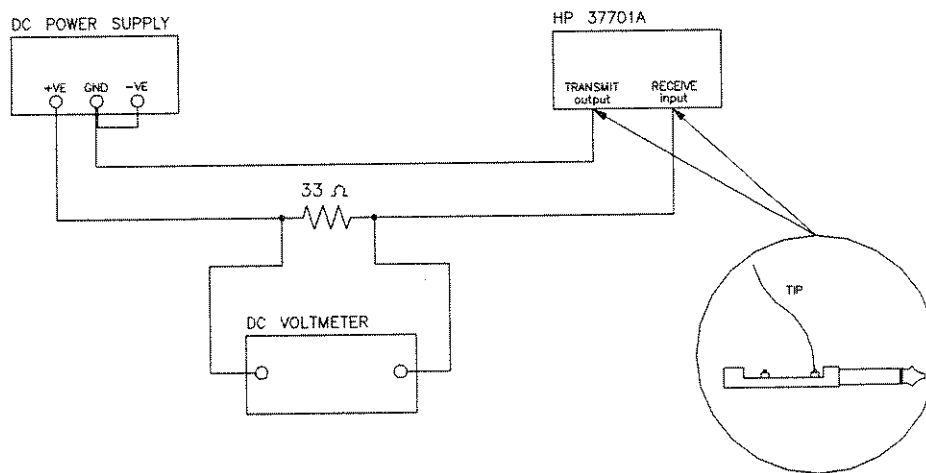

Note: Weco 310 to BNC Adapters can be used in the HP 37701A TRANSMIT and RECEIVE ports to allow connections to be made.

3. Press HP 37701A **RESULTS** and select **SIGNAL RESULTS**.
4. Adjust the DC Power Supply until the DC Voltmeter reads as shown in the table below and verify that the HP 37701A displayed **SIMPLEX CURRENT** measurement meets the limits given in the table.

DC Voltmeter Reading	SIMPLEX CURRENT
6.60V	200 +/-11 mA
1.98V	60 +/-4 mA
0.33V	10 +/-1.5 mA

Alarm Leds (red)

see 9-16 (same)

Alarm Leds (red)

This is a functional test of the Alarm leds

Equipment

None

Procedure

1. Connect the HP37701A TRANSMIT output to the RECEIVE input.
2. Recall the HP 37701A DEFAULT SETTINGS as shown on page 9-5.
3. If either the POWER LOSS led or the HISTORY led in the T1 RECEIVE STATUS area of the front panel is on, then press **RESET HISTORY**.
4. The following *T1 RECEIVE STATUS* leds should be on: T1 PULSES, FRAME SYNC, PATTERN SYNC and B8ZS.
5. Disconnect the Transmit port from the Receive port and ensure that the green leds are off and that the SIGNAL LOSS, FRAME LOSS, PATTERN LOSS, SLIP and HISTORY leds are on. The SLIP led depends on the timing of the signal path break and may not always come on.
6. Reconnect the Transmit port to the Receive port.
7. Press HP 37701A **AUX**, select **ALARMS AND LOOPING** and set the ALARM GENERATION for All ONES.
8. Ensure that the ALL ONES, FRAME LOSS, PATTERN LOSS, ERRORS and HISTORY leds are on. T1 PULSES should be the only green led on.
9. Set the ALARM GENERATION to OFF.
10. Press HP 37701A **FRAME** and select **UNFRAMED**.
11. Press HP 37701A **CODE** and select **AMI**.
12. Press HP 37701A **PATTERN** and select **USER WORD**. Set the USER WORD for a 17 bit length (10000000000000000) and ensure that the EXCESS ZEROS and ONES DENSITY leds are on. T1 PULSES and PATTERN SYNC are the only green leds on.

13. Decrease the USER WORD length to 16 bits and ensure that the EXCESS ZEROS led goes off while the ONES DENSITY led remains on. T1 PULSES and PATTERN SYNC are the only green leds on.
14. Decrease the USER WORD length to 9 bits, ensure that the ONES DENSITY led is on, then decrease the USER WORD length to 8 bits and ensure that the ONES DENSITY led goes off. T1 PULSES and Pattern SYNC are the only green leds on.
15. Press HP 37701A **LOOP UP** and ensure that the LOOP UP led comes on momentarily (ignore other leds which momentarily flash on). T1 PULSES and PATTERN SYNC are the only green leds on.
16. Press HP 37701A **LOOP DOWN** and ensure that the LOOP DOWN led comes on for approximately 8 seconds (ignore other leds which momentarily flash on). T1 PULSES and PATTERN SYNC are the only leds on.
17. Switch the instrument power off then on and ensure that the POWER LOSS led and the HISTORY leds are on. T1 PULSES and PATTERN SYNC are the only green leds on.
18. Press HP 37701A **START/STOP** to clear the POWER LOSS led and the HISTORY led.
19. Disconnect the Transmit port from the Receive port then reconnect again. Ensure that the HISTORY led is on. Press **SHOW HISTORY** to view the results of disconnection (HISTORY LED flashes once key is pressed).
20. Press HP 37701A **RESET HISTORY**. Ensure that the HISTORY led goes off and that when **SHOW HISTORY** is pressed, the only Red Led to come on is a flashing HISTORY led.
21. Press **RESET HISTORY** to disable the flashing HISTORY led.

Operation Verification Test Record

Page No.	Test Description	Result		
		Min	Actual	Max
	<i>T1 Tester Self Test</i>			
9-6	Step 4: "TEST STATUS PASSED" displayed.			
9-7	Step 8: "TEST STATUS PASSED" displayed.			
	Step 11: "TEST STATUS PASSED" displayed.			
	<i>Auto Configure</i>			
9-9	Step 5: FRAME set for UNFRAMED CODE set for AMI PATTERN set for ALL ONES			
	<i>Pulse Mask (Option 001)</i>			
9-10	Step 6: positive pulses within the mask. negative pulses within the mask. T1.403 PASS displayed.			
	<i>Voice Frequency Output</i>			
9-11	Step 4: 2 volts pk-pk (typically) sinewave with a period of 1.0ms displayed.			
9-12	Step 5: 1 kHz tone is audible. Tone can be increased and reduced.			

Operation Verification Test Record (continued)

Page No.	Test Description	Result		
		<i>Min</i>	<i>Actual</i>	<i>Max</i>
9-14	<i>Recovered Loop Timing</i>			
	Step 8: received Synthesizer frequency -772.11 kHz.			
	Step 9: received Synthesizer frequency -771.89 kHz.			
9-15	<i>Internal Transmitter Clock</i>			
	Step 5: Frequency Counter reading.	771.991Hz		772.009Hz
9-16	<i>Alarm Leds (red)</i>			
	Step 4: T1 PULSES, FRAME SYNC, PATTERN SYNC and B8ZS leds on.			
9-16	Step 5: green leds off. SIGNAL LOSS, FRAME LOSS, PATTERN LOSS and SLIP * leds on.			
9-16	Step 8: ALL ONES, FRAME LOSS, PATTERN LOSS and ERRORS leds on.			
9-16	Step 12: EXCESS ZEROS and ONES DENSITY leds on.			

* Occurrence of SLIP depends on signal path break time.

Operation Verification Test Record (continued)

Page No.	Test Description	Result		
		<i>Min</i>	<i>Actual</i>	<i>Max</i>
9-17	Step 13: EXCESS ZEROS led off and ONES DENSITY led on.			
9-17	Step 14: USER WORD length 9 bits, ONES DENSITY led on. USER WORD length 8 bits, ONES DENSITY led off.			
9-17	Step 15: LOOP UP led comes on momentarily.			
9-17	Step 16: LOOP DOWN led comes on approx. 8 seconds.			
9-17	Step 17: POWER LOSS and HISTORY leds on.			
9-17	Step 19: HISTORY led on.			
9-17	Step 20: HISTORY led goes off. No Red Leds come on.			

Performance Test Record

Page No.	Test Description	Result		
		Min	Actual	Max
	<i>T1 Tester Self Test</i>			
9-19	Step 4: "TEST STATUS PASSED" displayed.			
9-20	Step 8: "TEST STATUS PASSED" displayed.			
	Step 11: "TEST STATUS PASSED" displayed.			
	<i>Internal Transmitter Clock</i>			
9-22	Step 5: Frequency Counter reading.	771,990.7Hz		772,009.3Hz
	<i>Transmitter Pattern Generation</i>			
9-25	Step 8: QRSS PPA5 3 IN 24 AC1P ALL ONES 7339 1 IN 8 0P5C 1 IN 2 H117 55 OCTET FC67 USER WORD 8C6F 2^15-1 5A8H 2^20-1 F149 2^23-1 A38U			
	<i>Transmitter Line Coding</i>			
9-27	Step 10: AMI 0814 B8ZS 08FH			

Performance Test Record (continued)

Page No.	Test Description	Result		
		Min	Actual	Max
9-30	<i>Transmitter Frame Pattern</i>			
	Step 9: ESF FH4C D4 333C SLC96 U880			
	<i>Transmitter Error Add</i>			
9-33	Step 7: Frequency Counter reading	771.9907Hz		772.0093Hz
9-33	Step 8: Frequency Counter readings 1E-3 1E-4 1E-5 1E-6 1E-7	771.9907Hz		772.0093Hz
		77.19907Hz		77.20093Hz
		7.719907Hz		7.720093Hz
		.7719907Hz		.7720093Hz
		.07719907Hz		.07720093Hz
	Step 12: Frequency Counter reading 3 counts.			
	<i>Transmitter Output</i>			
9-35	Step 9: peak pulse amplitude.	2.4V		3.6V
	Step 10: pulse width at half pulse amplitude.	294ns		354ns
	Step 11: rise and decay time <73ns.			

Performance Test Record (continued)

Page No.	Test Description	Result		
		Min	Actual	Max
9-36	Step 15: pulse falls within the mask. Step 17: Repeat of Steps (9) to (15). (9) peak pulse amplitude (10) pulse width at half pulse amplitude. (11) rise and decay time <73ns. (15) pulse falls within the mask.	2.4V 294ns		3.6V 354ns
9-38	<i>Recovered Clock Frequency Measurement</i> Step 9: FREQUENCY displayed.	1543981MHz		1544019MHz
9-40	<i>Receiver Equalization, Gain and Level Measurement</i> DSX-MON (Automatic Gain) Step 9: no errors displayed. Step 10: no errors displayed.			
9-41	TERM (Equalization) Step 13: no errors displayed. Step 14: no errors displayed. BRIDGE (Equalization) Step 16: 2.247V rms - no errors displayed. 31.7V rms - no errors displayed.			

Performance Test Record (continued)

Page No.	Test Description	Result		
		Min	Actual	Max
	TERM (Level Measurement)			
9-41	Step 20: <i>Synth Vp-p</i> <i>AC Vrms</i> 9.23 4.233 4.66 2.12 1.45 0.67 0.467 0.212 0.075 0.0336	+5dBdsx 10.75Vpk-pk -1dBdsx 5.4Vpk-pk -8dBdsx 1.7Vpk-pk -17dBdsx 0.42Vpk-pk -33dBdsx 0.07Vpk-pk		+7dBdsx 13.15Vpk-pk +1dBdsx 6.6Vpk-pk -12dBdsx 2.1Vpk-pk -23dBdsx 0.78Vpk-pk -39dBdsx 0.12Vpk-pk
	<i>Wander/Slips Measurement (Option 001)</i>			
9-44	Step 4: POSITIVE PEAK WANDER NEGATIVE PEAK WANDER	-0.125 -0.125		+0.125 +0.125
	Step 5: POSITIVE PEAK WANDER, NEGATIVE PEAK WANDER, PEAK TO PEAK WANDER & TIME INTERVAL ERRORS all show NO REF.			
9-45	Step 14: UNCONTROLLED SLIPS - N/A CONTROLLED SLIPS - N/A ESTIMATED FRAME SLIPS ESTIMATED BIT SLIPS	-5 -961		-4 -959
	Step 15: POSITIVE PEAK WANDER : NEGATIVE PEAK WANDER : PEAK TO PEAK WANDER : TIME INTERVAL ERRORS : PEAK TO PEAK 15 MINS.... BITS PEAK TO PEAK 2 HOURS.... BITS	0.000 BITS 955.125 BITS 955.125 BITS -955.125 BITS		0.000 BITS 964.875 BITS 964.875 BITS -964.875 BITS

Performance Test Record (continued)

Page No.	Test Description	Result		
		Min	Actual	Max
9-46	Step 17 Repeat of Steps (14) to (16).			
	(14) UNCONTROLLED SLIPS - N/A			
	CONTROLLED SLIPS - N/A			
	ESTIMATED FRAME SLIPS	-5		-4
	ESTIMATED BIT SLIPS	-961		-959
	(15) POSITIVE PEAK WANDER :	0.000 BITS		0.000 BITS
	NEGATIVE PEAK WANDER :	955.125 BITS		964.875 BITS
	PEAK TO PEAK WANDER :	955.125 BITS		964.875 BITS
	TIME INTERVAL ERRORS :	-955.125 BITS		-964.875 BITS
	PEAK TO PEAK 15 MINS..... BITS PEAK TO PEAK 2 HOURS..... BITS			
Step 18:	UNCONTROLLED SLIPS - N/A			
	CONTROLLED SLIPS - N/A			
	ESTIMATED FRAME SLIPS	4		5
	ESTIMATED BIT SLIPS	959		961
Step 19:	POSITIVE PEAK WANDER :	955.125 BITS		964.875 BITS
	NEGATIVE PEAK WANDER :	0.000 BITS		0.000 BITS
	PEAK TO PEAK WANDER :	955.125 BITS		964.875 BITS
	TIME INTERVAL ERRORS :	955.125 BITS		964.875 BITS
	PEAK TO PEAK 15 MINS..... BITS PEAK TO PEAK 2 HOURS..... BITS			
9-49	<i>Simplex Current Measurement</i>			
	Step 4: SIMPLEX CURRENT			
	DC Voltmeter Reading			
	6.60V	189ma		211ma
	1.98V	56ma		64ma
	0.33V	8.5ma		11.5ma

Performance Test Record (continued)

Page No.	Test Description	Result		
		<i>Min</i>	<i>Actual</i>	<i>Max</i>
	<i>Alarm Leds (red)</i>			
9-50	Step 4: T1 PULSES, FRAME SYNC, PATTERN SYNC and B8ZS leds on.			
9-50	Step 5: green leds off. SIGNAL LOSS, FRAME LOSS, PATTERN LOSS and SLIP * leds on.			
9-50	Step 8: ALL ONES, FRAME LOSS, PATTERN LOSS and ERRORS leds on.			
9-50	Step 12: EXCESS ZEROS and ONES DENSITY leds on.			

* Occurrence of SLIP depends on signal path break time.

Performance Test Record (continued)

Page No.	Test Description	Result		
		<i>Min</i>	<i>Actual</i>	<i>Max</i>
9-51	Step 13: EXCESS ZEROS led off and ONES DENSITY led on.			
9-51	Step 14: USER WORD length 9 bits, ONES DENSITY led on. USER WORD length 8 bits, ONES DENSITY led off.			
9-51	Step 15: LOOP UP led comes on momentarily.			
9-51	Step 16: LOOP DOWN led comes on approx. 8 seconds.			
9-51	Step 17: POWER LOSS and HISTORY leds on.			
9-51	Step 19: HISTORY led on.			
9-51	Step 20: HISTORY led goes off. No Red Leds come on.			



10

Remote Control

Tests may be set up and run, results may be stored and retrieved, using the remote control facility. The operation of the Tester is the same as in manual operation from the front panel.

Additional facilities are available when using remote control:

Complete test configurations may be down loaded to the Tester either for immediate use or to be stored in the tester memory for future use.

Results may be returned to the controller for display, printing or further analysis.

Command History

The commands contained in this chapter apply directly to instruments with serial prefix(es) and/or firmware revision numbers given on the *Title Page* of this manual. In the command descriptions which follow you may be directed to the *Command History* table at the end of this chapter. This table contains a description of command changes for each firmware revision.

Preparation for Remote Control

The Tester may be controlled directly from a controller at the same location as the Tester, or over a telephone link via modems.

Where control is over a telephone link, the link may be a leased line or a dial-up line.

The controller may be a "dumb" terminal or a computer.

The Tester must be correctly connected and correctly set up for successful remote control.

The RS232C port may be configured for either printer or remote control operation. When printer operation is selected, 8 bit data is transmitted and Xon/Xoff selection may be "ON" or "OFF" only. When remote control operation is selected, 7 bit data is assumed and Xon/Xoff selections are :

OFF, Rx ONLY, Tx ONLY or Rx AND Tx.

The tester receive buffer has a capacity of 128 bytes.

Remote Control / Printer Pin Assignments

Pin	Mnemonic	Description
1	PGND	Connected to chassis ground
2	TXD	37701A data input
3	RXD	37701A data output
4	RTS	Looped to pin 5
5	CTS	Looped to pin 4
7	SGND	Signal ground
20	DTR	Inhibits data output from the 37701A when held "OFF" by the receiving device.

To Connect to Telephone Lines via Modems

The connections of a cable suitable for Tester / modem connection are shown in the following figure.

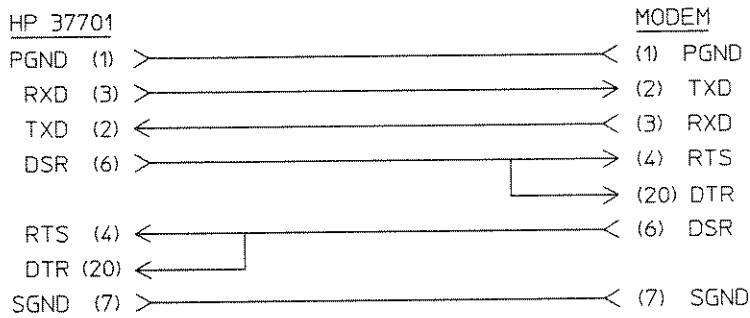

To Connect for Direct Operation

The connections of a cable suitable for direct connection to a controller are shown in the following figure.

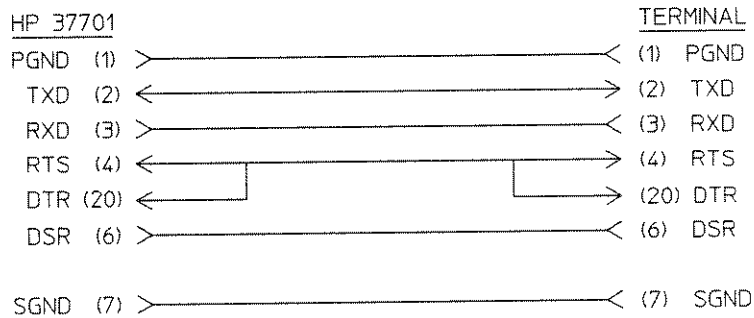

To Set the Tester for Operation from a Terminal

Press **AUX**

Select **PRINTER REM CTL**

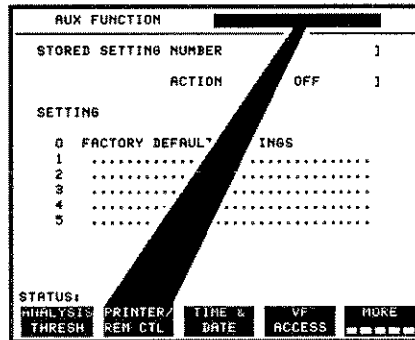

Highlight

RS232 MODE []

Select **TERMINAL CONTROL**

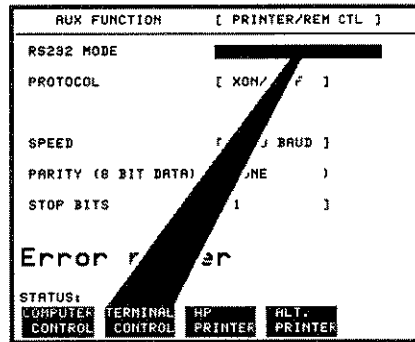

To Set the Tester for Operation from a Computer

Press **(AUX)**

Select **PRINTER REM CTL**

AUX FUNCTION	
STORED SETTING NUMBER]
ACTION	OFF]
SETTING	
0	FACTORY DEFAULT SETTINGS
1
2
3
4
5
STATUS:	
ANALYSIS THRESH	PRINTER/ REM CTL
TIME & DATE	VF ACCESS
	MORE

Highlight

RS232 MODE []

Select **COMPUTER CONTROL**

AUX FUNCTION [PRINTER/REM CTL]	
RS232 MODE	
PROTOCOL	[NONE OFF]
SPEED	9600 BAUD]
PARITY (8 BIT)	(NONE)
STOP BITS	[1]
Err number	
COMPUTER CONTROL	TERMINAL CONTROL
HF PRINTER	ALT. PRINTER

Remote Operation

The following information assumes the user is familiar with the local operation of the tester.

Remote operation is performed by a computer or “dumb” terminal connected to the RS 232 C port on the side of the tester. This port is also used as the printer output port. The printing of results may be performed by returning the results to the computer or printing terminal, or alternatively by storing them in the tester for printing at a later time.

The tester is operated by commands which are listed later in this chapter. Commands are shown in the actual form required and are presented in “computer type” for example the command for starting a test is shown as STR.

Many commands must be qualified with a variable for example the command COD which selects the line code as has a qualifier *<n>* which specifies the type of line code AMI or B8ZS.

The qualifier *<n>* is presented in italic type.

The preferred form of the complete command has a space between the mnemonic and the variable. For example COD 1 is preferred to COD1.

The possible alternative values for *<n>* are presented as a list. There is usually a choice in the form of the variable, a digit or an alpha-numeric code.

The command information for setting the line code to AMI or B8ZS is presented in the following form:

COD <i>n</i>	<i>n</i> =	1 or AMI	AMI coding
		2 or B8ZS	B8ZS coding

To set the code to AMI send: COD 1 or COD AMI

To set the code to B8ZS send: COD 2 or COD B8ZS

A space between the mnemonic part of the command (COD) and the variable (*n*) is desirable.

In local operation, all of the front panel controls are responsive and control the tester. In remote operation the controls which change parameters are inoperative, the tester being controlled by the remote controller. The front panel display reflects the remote programming commands received.

10-6 Remote Control

At power on the tester assumes the local state. To gain control of the tester the controller must put the tester into the remote state. This is accomplished by sending the “remote control enable” command (RMT). The tester can be returned to local control by sending the “return to local” command (LCL).

Commands are normally separated by “newlines” which can be either a single carriage return character or a carriage return-line feed pair.

Terminal Control

In general this chapter describes how to control the tester under computer control. The differences when using a terminal are given here.

The operational differences with terminal use are :

- Characters typed are echoed to the terminal.
- The tester provides a prompt at the beginning of the command line.
- Rudimentary input editing (backspace, erase line) is provided.
- An asynchronous interrupt (quit) is provided.
- Errors are reported as text messages.
- A command history is provided.
- Status bit queries indicate active bits in mnemonic form.
- Selectable variable queries can return mnemonic values.

Note that line feeds are always ignored in input. (It is possible to put multiple commands on one line by separating them with semicolons.) Output lines are always separated by carriage return-line feed pairs, regardless of which separator was used on input. This is different to “computer mode”, where the separator used for output is always the same as was used for input.

The length of an input line is limited to 280 characters. If the user tries to type more than 278 characters (the last two are used to store the CR LF), the terminal bell rings and the extra characters are discarded.

Prompting and Input Editing

The Prompt

With terminal operation, the tester provides a prompt which is displayed on the terminal screen. This prompt may be customized by the user. The preset prompt is :

```
HP37701A>
```

Input Editing

There are three special function characters used for input editing :

BACKSPACE This character (DELETE) causes the last character typed to be erased (the tester outputs BACKSPACE-SPACE-BACKSPACE). If the user attempts to backspace over the prompt, the terminal bell rings.

KILL This character (control-U) causes all of the line from the prompt to the end to be erased.

INTERRUPT This character (control-C) interrupts the execution of the current command and the tester outputs a newline followed by a prompt. Pressing **BREAK** has the same effect.

Error Reporting

When using “computer” mode, errors in parsing or execution cause the processing of the current command to cease, and an error code describing the nature of the problem is placed in the error register, which the user can examine by issuing the ERR? command. In “dumb terminal” mode, the tester reports errors when they occur, without the user performing any special action. When an error occurs, the tester will echo the faulty command with a text message explaining what the problem was.

Examples :

Example 1 : IDX? sent instead of ID?.

```
HP37701A> idx?  
idx? : Command header error
```

Example 2 : A command sent when the tester was not under remote control.

```
HP37701A> rst
rst : Command not executable in local mode
```

Example 3 : A mixture of valid and invalid commands sent.

```
HP37701A> id? ; idx?
HP37701A
idx? : Command header error
HP37701A>
```

In the third example above, a line contains one legal command (id?), and one illegal command (idx?). The legal command is executed, and the response written to the terminal, followed by an error message for the illegal command.

Note that in “dumb terminal” mode, the tester error register is NOT updated. This is because the tester effectively follows each error with an internal ERR? command, which has the effect of clearing the error register.

Mnemonic Responses

When in “computer mode”, commands which query tester status registers (e.g. STA?,RQS? etc.) simply return integers. Where these registers are really collections of bits, each indicating a separate condition, “dumb terminal” mode will output a mnemonic string indicating which bits are active, in addition to the integer value of the register.

Example

```
HP37701A> sta?
28 <RDY LCL FPS>
```

In addition to mnemonic responses for status register queries, “dumb terminal” mode has the facility to return mnemonic responses to selectable variable queries.

Example

```
HP37701A> pat?
QRSS
```

“dumb terminal” mode also provides a command history feature. The tester maintains a buffer of up to 20 commands (or 200 characters, whichever runs

out first) of commands entered. Commands are entered into the history buffer whether legal or not, and a command is only not put into the history if it is exactly the same as the last command sent. If there is no space in the history store when a new command is received, commands are deleted from the store, oldest first, until there is enough space.

Commands are provided to list the contents of the store, re-execute the last command sent and to re-execute a particular command, specified by its number. These commands are not themselves placed into the history store.

!1 : Lists the contents of the history store (if any).

NOTE : Character 1 in this command must be the lower case of character L.

Example : Response to a request to list the contents of the history store !1

```
HP37701A> !!  
1 : sta?  
2 : rst  
3: id?  
4: str  
5: STA?  
HP37701A>
```

!! : Echoes and re-executes the last command in the history store.

Example : To re-execute the last command.

The last command in the previous example was STA?.

Typing !! after the prompt will cause the STA? command to be returned to the terminal and re-executed.

```
HP37701> !!  
STA? 20 <RDY FPS>
```

! n : Echoes and re-executes command number n in the history store.

The command number is either the number given by the “!l” command, or a negative number indicating the “second from last (-2)” etc. If the selected command is not in the store the command is echoed and an error message is written to the terminal.

The following errors can occur when using history commands :

bad history command -- unrecognized history command.

no such history command -- the specified command is not in the store.

10-10 Remote Control

Programming Tips

The programming information given here covers the following :

- The maximum rate of reading status registers.
- How to determine the start/running/stop status of a test.
- Delay in execution of some commands.

Reading of Status Registers

All status registers are updated on a 100ms basis, with the exception of the err register, which will be updated when a remote control error occurs. There is therefore no point in reading the registers at a faster rate than this, and the status register reads actually enforce a 100ms delay before the next read can be attempted. To minimize command queuing therefore, do not send status register query commands at a greater rate than every 100ms.

Determining Start and Stop

There are various bits associated with starting and stopping. These are as follows:

STA:

- EOT - Set at end of testing period
- TIP - Set whilst the tester is testing
- SMG - Set when Stored Measurement and Graphics (SMG) operations are in progress

STB:

- EOT - Set at end of testing period (same as STA)

RDY:

- OST - Set when the tester actually starts testing.

The significance of these bits is as follows: When the OST bit is set, any errors generated at the input to the tester will be counted; and when the SMG bit is set data may not be read from the results store.

The relationships between these bits is shown in the following diagram.

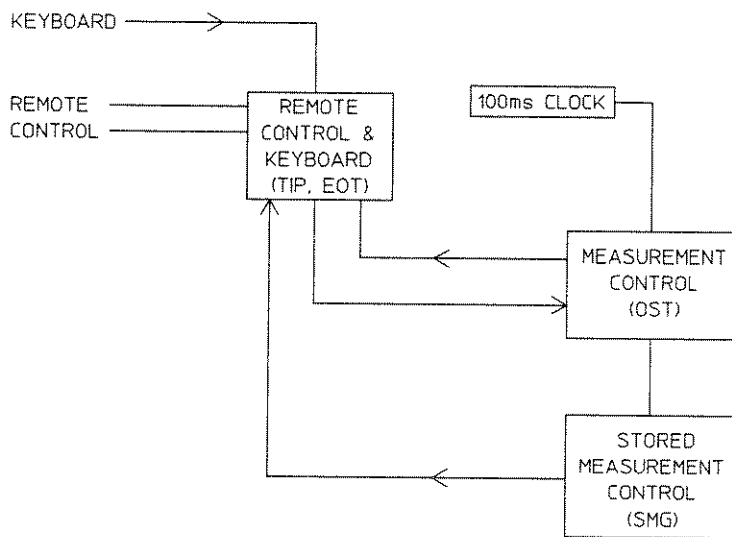

Start/Stop operation timing

Restarting with the STR command or with **START/STOP**

Under these circumstances, the TIP bit will go TRUE and the EOT bit will go FALSE very soon after the command is received. As soon as a valid measurement can be carried out (i.e. a signal is presented) the OST bit will go TRUE. When testing has started this information is passed to the stored measurement graphics process, which will set the SMG bit some time later. The time it takes to set the bit depends on whatever other loading the tester is getting at the time, but typically may be up to 2 seconds.

Stopping with the STP command, with **START/STOP** or after a timed measurement

Under these circumstances, the TIP bit will go FALSE, the OST bit will go FALSE and the EOT bit will go TRUE very soon after the command is received. Sometime later the SMG bit will be cleared. All the bits will have settled to their new values by typically 2 seconds after the command is received.

The Delay in the Execution of Some Commands

If the tester is controlled from a computer which sets a timeout for remote control read and write operations then it is important to realize what factors can contribute to delays.

The execution of commands can take a long time, for example RST will typically take 2 seconds for complete execution. The tester has an input buffer in excess of 100 characters, and can buffer up several commands before executing them. This is deliberate and desirable. It can lead to some long response times for example if the command `RST;RST;RST;ID?` is sent it will be more than 6 seconds before a response to the `ID?` command is received. The programmer should bear these considerations in mind when programming any timeouts.

THE COMMANDS

COMMON CAPABILITY MESSAGES

Reset

The reset action message presets the instrument to its default state. A full listing of this default state is given in this chapter. The predefined default state is as follows:-

- Configuration defined by preset panel 0
- Starts testing
- All buffers flushed
- Stop asserting SRQ (not relevant in this instrument)
- Service request mask set to ERR (not relevant in this instrument)
- Clear all errors
- Clear alarm change and key registers
- Clear status registers except for DAT bit
- Ready register bits LQE, STC, ASC set. RAC set in computer mode, clear in dumb terminal mode.

The remote control parser and executor are also reset by this command. The command is as follows:-

RST

Remote

This command causes the instrument to go remote with local lockout. The command is as follows:-

RMT

Local

This command causes the instrument to disable local lockout and return to local. The command is as follows:-

10-14 Remote Control

LCL

Clear

This command clears all instrument errors and flushes all buffers without affecting the programmed state of the instrument. The following things are performed by executing this command:-

- All buffers flushed
- Clear all errors
- Clear alarm change and key registers
- Clear all bits in status registers, except for DAT and TIP which retain their original values
- Ready register RAC bit set in computer mode, clear in dumb terminal mode

The command is as follows:-

CLR

Device Clear

This is implemented on the 37701A by sending a [BREAK]. These will return the instrument to the initialized condition regardless of the current state. A delay of at least 200ms should be allowed after sending this command. Its effect is identical to sending CLR.

Key Query

This command returns the value of the last key pressed on the front panel. The value is returned as an integer whose meaning is given below. If no key was pressed since the last time the command was used, 0 is returned. Note that this command does not wait until a key is pressed. The command is as follows:-

KEY? returns

- 1 = Up Arrow
- 2 = Down Arrow
- 3 = Softkey 1
- 4 = Softkey 2
- 5 = Softkey 3
- 6 = Softkey 4
- 7 = Softkey 5
- 8 = Aux
- 9 = Interface Select
- 10 = Line Build Out
- 11 = Transmitter Timing
- 12 = Transmit Error Type
- 13 = Transmit Error Rate
- 14 = Frame
- 15 = Code
- 16 = Pattern
- 17 = Period
- 18 = Results
- 19 = Auto Run
- 20 = Show History Depressed
- 22 = Loopup
- 23 = Loopdown
- 24 = Decrease Volume
- 25 = Increase Volume
- 26 = Start/Stop
- 27 = Print Now
- 28 = Reset History
- 29 = Single Error
- 31 = Show History Released

Request Service Mask

This command is used to enable or disable the reasons for setting the RQS bit in status register A and B. Associated with status register A is a mask which enables or disables the various sources (ie only the positive edge of a bit in status register A with it's corresponding mask bit enabled will cause the RQS bit to be set.)

RQS *n* *n* = 0 to 30719 Status reg A mask range

10-16 Remote Control

The mask has a bit map identical to that of status register A, and can be set in three different ways.

1) The parameter can be a single 16 bit integer, corresponding to the addition of binary weighted bits wishing to be enabled. Eg. if we wished to enable STR and ERR then the command would be:-

RQS 288

2) The parameter can be a list of the binary weighted integers corresponding to all those sources wishing to be enabled separated by commas. Eg. if we wished to enable STR, ERR and FPS then the command would be:-

RQS 256,4,32

3) The parameter can be a list of three letter mnemonics defined in Status Registers, separated by commas. Eg. if we wished to enable ERR, RDY and LCL then the command would be:-

RQS ERR,RDY,LCL

As well as the three methods of passing the parameter outlined above, any combination may be used, remembering that the result is always evaluated to a 16 bit integer. Care should be taken to ensure the resultant integer is in range and the desired sources are enabled (Although range checking is done, no checking of constituent parameters is performed to ensure that they are binary values). There are two other special parameters to this command. They are RQS ON and RQS OFF. RQS OFF is not equivalent to RQS 0 because it disables all reasons for SRQ but remembers the stored mask. Upon receipt of the RQS ON command service requests should be enabled again with the same mask as before (NOTE any positive edges of sources with their mask set should be caught, so that they will set the RQS bit when the RQS ON command is sent). If the RQS ON command is sent without a corresponding RQS OFF command sent before it, the instrument shall assume the 'RQS ERR' state as a default.

The complement of this command is used to inspect the Service Request mask. The command responds with a 16 bit integer equivalent to the binary weighted values of those sources which are enabled (outlined in Status Registers).

RQS? returns 0 to 30719

Error Code Query

This command is a request to read the instrument's error register. The error register contains an integer in the range -32768 to 32767. The error codes have various meanings, some defined by "common capabilities" and some instrument dependent (see Error Codes for a full listing). If no error exists at the time of enquiry, then 0 is returned. The error register is cleared on reading the register or by sending the CLR command.

The error register will also contain the result of a remotely initiated selftest command. This is cleared as above. The command is as follows:-

ERR? returns -32768 to 32767

Ready Code Query

This command is a request to read the instrument's ready register. The result is a binary weighted decimal integer. The meanings of the bits is given in "Status Registers". The command is as follows:-

RDY? returns 0 to 127

Status/Events Query

This command is a request for the instrument to return the contents of status register A. It responds with an integer which represents the 16 bit binary weighted contents of the status register bits. A detailed description of status register A is given in "Status Registers". The command is as follows:-

STA? returns 0 to 32767

Status Query

This command is a request for the instrument to return the contents of status register B. It responds with an integer which represents the 8 bit binary weighted contents of the status register bits. The act of executing this command also clears the RQS bit in status registers A and B (similar to the serial poll). A detailed description of status register B is given in "Status Registers". The command is as follows:-

STB? returns 0 to 255

Options Query

This command is a request for the instrument to return its option number.

The command is as follows:-

OPT? returns *nnn* or *0*

<i>0</i>	=	HP37701A (standard instrument)
<i>nn1</i>	=	Pulse Mask and Wander added
<i>n1n</i>	=	G821 Analysis and SMG added
<i>1nn</i>	=	Fractional T1 added

Where n could be zero or a blank in the case of leading zeros.

CONFIGURATION COMMANDS

Instrument Configuration

This command takes as its parameter a block of data which specifies the instrument's internal setup state. The block is a IEEE Std 728 '#H' format. This is intended only for restoring an instrument state saved using the CON? query and hence its internal format is not elaborated.

NOTE: This command does not record the settings of remote control sources, or current states of remote control registers. It is equivalent in scope to store/recall preset panels. One block should not be compared with another in a comparison attempt as redundant but variable information is also included in the block.

The command is as follows:- CON #H

The complement of this command is used to enquire about the configuration of the instrument; it returns the configuration of the instrument in exactly the same form, namely the IEEE Std 728 #H data block. The command is as follows:-

CON? returns #Hdata block

Framing Type

Selects the framing configuration.

FRM <i>n</i>	<i>n</i> =	1 or ESF
		2 or D4
		3 or SLC96
		4 or UNFRAMED

The corresponding query returns the framing configuration, in integer form as described above:-

FRM? returns *frame type* = 1 to 4

Pulse Mask Polarity Query

Provides the polarity of the pulse mask displayed.

PPO? returns *pulse polarity* *pulse polarity* = 0 No pulse has yet been sampled
1 Positive pulse on display
2 Negative pulse on display

Pulse Truncated Query

Provides truncation information about the currently displayed pulse.

PTC? returns *pulse truncated info* *pulse truncated info* = 0 No pulse has yet been sampled
1 Pulse on display is not truncated
2 Pulse on display is truncated

Pulse Mask Selection

Selects the type of pulse mask the pulse will be measured against.

PMS *n* *n* = 1 or ANSIT1403
2 or P62411
3 or OCB119
4 or NCB119 or ANSIT1102

The corresponding query returns the current mask selection, in integer form as described above.

PMS? returns *pulse mask type* = 1 to 4

Application Type

Selects the major application of the instrument.

APP *n* *n* = 1 or FULLT1 Full T1 measurements are enabled
2 or N56K N × 56k timeslot measurements are enabled
3 or N64K N × 64k timeslot measurements are enabled

The corresponding query returns the currently selected coding, in integer form as described above:-

APP? returns *application type* = 1 to 3

Receiver Timeslot Selection

Selects whether the timeslots should map the transmitter timeslots or should be selectable.

RXT <i>n</i>	<i>n</i> = 1 or ASTX	Receiver timeslots are same as transmitter
	2 or RECEIVE	Receiver timeslots are selectable

The corresponding query returns the currently selected coding, in integer form as described above:-

RXT? returns *timeslot selection* = 1 to 2

Transmitter Multiple Timeslot Selection

Selects the transmit timeslots for fractional T1 measurements. It also selects the receiver timeslots when that selection is as RX. The information is passed as a binary representation of the timeslot selection field. Timeslot *n* is selected (deselected) depending on the corresponding mask element being 0 or 1.

TTM "*timeslots*" *timeslots* = 24 characters, 0 or 1

The corresponding query returns the currently selected coding, in integer form as described above:-

TTM? returns "*timeslots*" = 24 characters, 0 or 1

Receiver Multiple Timeslot Selection

Selects the receiver timeslots for fractional T1 measurements. The information is passed as a binary representation of the timeslot selection field. Timeslot *n* is selected (deselected) depending on the corresponding mask element being 0 or 1.

RTM "*timeslots*" *timeslots* = 24 characters, 0 or 1

The corresponding query returns the currently selected coding, in integer form as described above:-

RTM? returns "timeslots" = 24 characters, 0 or 1

Pattern Type

Selects the pattern to be transmitted and configures the receiver accordingly.

PAT <i>n</i>	<i>n</i> =	1 or QRSS	2^{20-1} PRBS, D20+D17+1=0 (14 zero limit)
		2 or THREEIN24	
		3 or ALLONES	
		4 or ONEIN8	
		5 or ONEIN2	101010 ...
		6 or OCTET55	55 octet
		7 or USER	User programmable 3 to 24 bit word
		8 or LIVE	Invokes Monitor Mode
		9 or PRBS15	2^{15-1} PRBS, D15+D14+1=0 (inverted)
		10 or PRBS20	2^{20-1} PRBS, D20+D17+1=0
		11 or PRBS23	2^{23-1} PRBS, D23+D18+1=0 (inverted)
		12 or SPECIAL	Special pattern, use of alternative, SPT recommended

The corresponding query returns the currently selected pattern, in integer form as described above:-

PAT? returns *pattern type* = 1 to 12

If 12 is returned, SPT? is required to define which special pattern is selected.

Special Pattern / Test Type

Selects which of several special patterns or tests should be used.

SPT <i>n</i>	<i>n</i> =	1 or LONGWRD	8 to 1024 bit long user word
		2 or SIGBIT	Signaling bit test
		3 or TSCHECK	Timeslot check test
		4 or HIRERTD	High resolution round trip delay
		5 or TONE1	Tone 1 (404Hz)
		6 or TONE2	Tone 2 (1004Hz)
		7 or TONE3	Tone 3 (2804Hz)

The corresponding query returns the currently selected pattern, in integer form as described above:-

SPT? returns *pattern type* = 0 to 7

Where 0 corresponds to: no special pattern selected.

Long User Word

Specifies the identification number and pattern for one of the long user words. The word length is determined automatically by the length of pattern selected.

L UW *n*,#*H data* *n* = 1 to 4 User word number
 #*H data* = #Haabbcc ... Long user word data (1 to 128 bytes)

The corresponding query returns the long user word pattern in #H block form:-

L UW? *n* returns #*H data*

Where *data* is 1 to 128 bytes, each byte comprising 2 hex characters.

Long User Word Length

Specifies the pattern length for one of the long user words.

This command may be used to restrict the pattern length of an existing long user word. It may also be used to restore the length to its original value after remotely changing the first *n* bytes.

L UL *n,length* *n* = 1 to 4 User word number
 length = 1 to 128 Long user word length in bytes

The corresponding query returns the long user word pattern length:-

L UL? *n* returns *length*

Long User Word Select

Specifies which of 4 long user words to use.

L US *n* *n* = 1 to 4 Long user word number

*

The corresponding query returns the currently selected long user word, in integer form as described above:-

LUS? returns *long user word* = 1 to 4

Long User Word Sync Mode

Specifies whether the sync should be based on the length of the whole word or on a specified number of bytes.

LUY <i>n, sync mode</i>	<i>n</i> = 1 to 4	User word number
	<i>sync mode</i> = 1 or FULL	Full word length used
	2 or VARIABLE	Number of bytes can be controlled

The corresponding query returns the currently selected sync mode:-

LUY?*n* returns *sync mode* 1 or 2

Long User Word Sync Length

Specifies the long user word sync length which will be used when variable sync length is selected.

LSL <i>n, length</i>	<i>n</i> = 1 to 4	Long user word number
	<i>length</i> = 1 to 128	Number of bytes for sync

The corresponding query returns the currently selected sync length, in integer form as described above:-

LSL?*n* returns *sync length* = 1 to 128

Long User Word Left Hand Bit

Specifies whether the left hand bit of the user word bytes should be sent first or last. This command will set the bit transmission order for all 4 of the long user words.

LHB <i>direction</i>	<i>direction</i> = 1 or FIRST	Left hand bit sent first
	2 or LAST	Left hand bit sent last

The corresponding query returns the selected direction, in integer form as described above:-

LHB? returns *direction* = 1 or 2

Coding Type

Selects the coding type to be transmitted and configures the receiver accordingly.

COD <i>n</i>	<i>n</i> =	1 or AMI	AMI coding
		2 or B8ZS	B8ZS coding

The corresponding query returns the currently selected coding, in integer form as described above:-

COD? returns *coding type* = 1 to 2

User Defined Pattern

Sets the user defined pattern.

PAU <i>length</i> , " <i>patt</i> "	<i>length</i> = 3 to 24
	" <i>patt</i> " = <i>length</i> characters 0 or 1

The corresponding query command returns the pattern length and content:-

PAU? returns *length*, "*patt*"

User Defined Pattern (Fractional T1)

Sets the user defined pattern.

PAF *mode*, "*pattern*"

<i>mode</i> =	1 or FULLT1	Full T1 user word <i>length</i> 3 to 24 bits
	2 or N56K	N×56Kbit/s user word <i>length</i> 7 bits
	3 or N64K	N×64Kbit/s user word <i>length</i> 8 bits
" <i>pattern</i> " =	<i>length</i> characters	0 or 1

The corresponding query command returns the fractional T1 pattern:-

PAF?mode returns "user pattern"

Send Signaling Bits

Selects the "foreground" signaling bit sequence for use in the signaling bit test. The user is able to separately select the AB bits for use in D4 etc. and the ABCD bits for use in ESF.

SSB *sig bit type*, "*sig bits*"

<i>sig bit type</i> = 1 or AB	D4 type
2 or ABCD	ESF type
" <i>sig bits</i> " = binary00 to 11	D4 type signaling bits
binary0000 to 1111	ESF type signaling bits

The corresponding query command returns the selected signaling bits in integer form as described above:-

SSB? *sig bits type* returns "*sig bits*"

Send Background Signaling Bits

Selects the "background" signaling bit sequence for use in the signaling bit test. The signaling bits in all channels except the one selected for the "foreground" will have their signaling bits set to this value.

SS0 *sig bit type*, "*sig bits*"

<i>sig bit type</i> = 1 or AB	D4 type
2 or ABCD	ESF type
" <i>sig bits</i> " = binary00 to 11	D4 type signaling bits
binary0000 to 1111	ESF type signaling bits

The corresponding query command returns the selected signaling bits in integer form as described above:-

SS0? *sig bits type* returns "*sig bits*"

Send Signaling Bits in Channel

Selects the channel that the foreground signaling bits should be inserted into.

10-28 Remote Control

SSI sig bit channel *channel = 1 to 24* Foreground channel.

The corresponding query returns the selected channel, in integer form as described above:-

SSI? returns *channel = 1 to 24*

High Resolution Round Trip Delay Transmit Timeslot Selection

Selects the timeslot that the high resolution round trip delay should be transmitted on.

RTT rtd timeslot *timeslot = 1 to 24* rtd timeslot.

The corresponding query returns the selected channel, in integer form as described above:-

RTT? returns *timeslot = 1 to 24*

High Res Round Trip Delay Rx Timeslot Select

Selects the timeslot that the high resolution round trip delay measurement should be received from if the rx timeslot is not "AS TRANSMITTER".

RTR rtd timeslot *timeslot = 1 to 24* rtd timeslot.

The corresponding query returns the selected rtd rx timeslot in integer form as described above:-

RTR? returns *rtd rx timeslot = 1 to 24*

High Res Round Trip Delay Rx From Select

Selects whether the high resolution round trip delay rx timeslot should be the same as the transmitter timeslot or should be selectable.

<i>RTF n</i>	<i>n = 1 or ASTX</i>	Receiver timeslot is the same as transmitter
	<i>2 or SELECT</i>	Receiver timeslot is selectable

The corresponding query returns the currently selected timeslot mode in integer form as described above:-

CHM <i>n</i>	<i>n</i> = 1 or D1D	D1D mapping
	2 or D2	D2 mapping
	3 or D3/D4	D3/D4 mapping

The corresponding query returns the channel mapping selection, in integer form as described above:-

CHM? returns *mapping selection* = 1, 2 or 3

VF Timeslot Query

This command returns the current timeslot, in integer form:-

VFT? returns *vf timeslot* = 1 to 24

Test Period

This command selects the mode of test duration control.

TPD <i>n</i>	<i>n</i> = 1 or CON	Continuous (Controlled by START/STOP)
	2 or T15M	15 minute timed test
	3 or T2H	2 hour timed test
	4 or T24M	24 hour timed test
	5 or USER	User defined test duration (see TDU)

The corresponding query returns the test time mode, in integer form as described above:-

TPD? returns *test time type* = 1 to 5

Test Duration

Selects the user-defined test duration, applicable when the "USER" test time mode is in force.

TDU <i>duration, units</i>	<i>duration</i> = 1 to 100	Duration of test
	<i>units</i> = 0 or SECONDS	Test duration is seconds
	1 or MINUTES	Test duration is minutes
	2 or HOURS	Test duration is hours
	3 or DAYS	Test duration is days

The corresponding query returns the user-defined test duration, in integer form as described above:-

TDU? returns *duration,units*

CSU Auto Mode

The following commands enable the instrument to automatically respond to in-band and out-of-band loop-up or down codes.

Use the following command if the instrument is to respond to in-band codes.

CSA <i>n</i>	<i>n</i> = 0 or OFF	CSU auto is disabled
	1 or ON	CSU auto is enabled

The corresponding query returns the currently selected CSU loop up state, in integer form as described above.

CSA? returns *csu in-band auto type* = 0 or 1

Use the following command the instrument is to respond to out-of-band codes.

COA <i>n</i>	<i>n</i> = 0 or OFF	CSU auto is disabled
	1 or ON	CSU auto is enabled

The corresponding query returns the currently selected CSU loop up state, in integer form as described above.

COA? returns *csu out-of-band auto type* = 0 or 1

Loopback Band

This command configures the instrument for in-band or out-of-band loopback operation. An error is generated if out-of-band is selected and framing is not ESF.

LPB <i>n</i>	<i>n</i> = 1 or INBAND	Set to respond to in-band loopcodes
	2 or OUTBAND	Set to respond to out-of-band loopcodes

The corresponding query returns the current type of loopbacks, in integer form as described above.

LPB? returns *csu loopback type* = 1 or 2

CSU Manual Mode

Three commands can cause the instrument to loop up or down. The instrument can be set for in-band LINE loop-up, or for out-of-band PAYLOAD or LINE loop-up.

Use the following command to achieve an in-band loop-up.

CSM <i>n</i>	<i>n</i> = 0 or DOWN	The instrument is not looped up
	1 or UP	The instrument is looped up

The corresponding query returns the currently selected CSU loop up state, in integer form as described above. Notice that this will also be set to up when the instrument has auto response on and an in-band loop-up code has been received.

CSM? returns *in-band loop up state* = 0 or 1

Use the following command to achieve an out-of-band LINE loop-up.

COL <i>n</i>	<i>n</i> = 0 or DOWN	The instrument is not looped up
	1 or UP	The instrument is looped up

The corresponding query returns the currently selected CSU loop up state, in integer form as described above. Notice that this will also be set to up when the instrument has auto response on and an out-of-band LINE loop up code has been received.

COL? returns *out-of-band line loop up state* = 0 or 1

Use the following command to achieve an out-of-band PAYLOAD loop-up.

COP <i>n</i>	<i>n</i> = 0 or DOWN	The instrument is not looped up
	1 or UP	The instrument is looped up

The corresponding query returns the currently selected CSU loop up state, in integer form as described above. Notice that this will also be set to up when t

the instrument has auto response on and an out-of-band PAYLOAD loop up code has been received.

COP? returns *out-of-band payload loop up state* = 0 or 1

Alarm Generation Type

Selects the type of alarms to be generated. Alarms can be generated with any pattern. They are disabled when loopcodes are being generated. Yellow alarm is not valid in unframed mode. If in unframed mode an error will be generated.

NOTE : This value is always set to off after the instrument is power cycled.

ALG <i>n</i>	<i>n</i> =	1 or OFF	Alarm generation disabled
		2 or AIS	Unframed all ones
		3 or YELLOW	Yellow alarm

The corresponding query returns the type of alarm generation in integer form as described above:-

ALG? returns *alarm type* = 1 to 3

Loopback Type

Two commands enable the instrument to respond to, or transmit in-band or out-of-band loopcodes.

Use the following command for in-band loopcodes.

LPC <i>n</i>	<i>n</i> =	1 or LINE	Line loopback (CSU)
		2 or FAC4B	4-bit facility loopback
		3 or FAC5B	5-bit facility loopback
		4 or USER	User defined (see LPU & LPD commands)

The corresponding query returns the loopback type, in integer form as described above:-

LPC? returns *in-band loopback type* = 1 to 4

Use the following command for out-of-band loopcodes.

10-34 Remote Control

LOC n	n =	1 or LINE	Line loopback (CSU)
		2 or PAYLOAD	Payload loopback
		3 or SMARTJACK	Smartjack loopback

The corresponding query returns the loopback type, in integer form as described above:-

LOC? returns *out-of-band loopback type = 1 to 3*

User Defined Loopdown

Sets the user defined in-band loopdown code.

LPD <i>length, "code"</i>	<i>length = 3 to 8</i>	Number of loopcode bits
	<i>"code" = 00000000 to 11111111</i>	<i>length</i> characters

The corresponding query command returns the in-band loopdown length and code:-

LPD? returns *length, "code"*

User Defined Loopup Code

Sets the user defined in-band loopup code.

LPU <i>length, "code"</i>	<i>length = 3 to 8</i>	Number of loopcode bits
	<i>"code" = 00000000 to 11111111</i>	<i>length</i> characters

The corresponding query command returns the in-band loop up length and code:-

LPU? returns *length, "code"*

Loopup

This command causes the instrument to perform a loopup. It is equivalent to pressing the loopup key on the front panel. If this is attempted during testing, autoseup or selftest an error is generated.

LUA

Printer Demand

Selects the mode of log on demand triggering of printer output.

Note that in practise this command cannot be acted upon immediately. The instrument will only allow logging to occur when the remote control is deselected. This is not a facility available on remote control.

PRD <i>n</i>	<i>n</i> = 1 or SETTINGS	Instrument settings output
	2 or RESULTS	Results snapshot output

PRD? returns *print on demand type* = 1 or 2

Printer Auto Trigger

Selects the mode of auto triggering of printer output.

Note that in practise this command cannot be acted upon immediately. The instrument will only allow logging to occur when the remote control is 126 deselected. This is not a facility available on remote control.

PRA <i>n</i>	<i>n</i> = 1 or OFF	No auto triggered output
	2 or EVENT	Event log summaries
	3 or FIFTEENMIN	Results at 15 minute intervals
	4 or TWOHOUR	Results at 2 hour intervals
	5 or ENDOFTTEST	End of test results
	6 or MESSAGEONLY	Only major messages

PRA? returns *auto trigger type* = 1 to 6

Interface Type

Selects T1 interface type.

IFC <i>n</i>	<i>n</i> = 1 or DSX	DSX monitor interface
	2 or TERM	100 ohm terminated interface
	3 or BRIDGE	> 1kohm bridged interface

The corresponding query returns the interface type, in integer form as described above:-

IFC? returns *interface type* = 1 to 3

Line Build Out

Selects T1 line build out.

LBO <i>n</i>	<i>n</i> = 1 or ZERO	0dB
	2 or SEVENPOINTFIVE	7.5dB
	3 or FIFTEEN	15dB

The corresponding query returns the line build out value, in integer form as described above:-

LBO returns *line build out type* = 1 to 3

Transmit Timing

Selects transmit timing source.

TRT <i>n</i>	<i>n</i> = 1 or INTERNAL
	2 or RECOVERED

The corresponding query returns the transmit timing source, in integer form as described above:-

TRT? returns *timing source type* = 1 or 2

Signaling Bit Display Type Select

This command allows either single or all signaling bits to be displayed. This is necessary because certain results may only be read when this is correctly configured. (Cf. SIG?, SCG?)

SBD <i>n</i>	<i>n</i> = 1 or SINGLE	A single t/s sig. bit is displayed
	2 or ALL	All t/s sig. bits are displayed

SBD? returns *displayed sig bit type* = 1 or 2

Signaling Bit Display Channel Select

Selects the channel number that should be displayed when the single channel monitor test is selected.

SBS *channel no* *channel = 1 to 24* Channel to display.

The corresponding query returns the selected channel in integer form as described above:-

SBS? returns *channel no = 1 or 24*

Timeslot Map Display Type Select

This command allows either single or all timeslots to be displayed in the timeslot check measurement. This is necessary because certain results may only be read when this is correctly configured. (Cf. TSS?, BIT?)

TMD *n* *n = 1 or SINGLE* A single t/s sig. bit is displayed
 2 or ALL All t/s sig. bits are displayed

TMD? returns *displayed t/s check type = 1 or 2*

Timeslot Map Display Timeslot Select Command

Selects the timeslot number that should be displayed when a single timeslot is selected in the timeslot map test.

TMS *timeslot no* *timeslot = 1 to 24* Timeslot to display.

The corresponding query returns the selected timeslot in integer form as described above:-

TMS? returns *timeslot no = 1 or 24*

MISCELLANEOUS COMMANDS

Autoconfigure

This command causes the autotrigger to be initiated. It is equivalent to pressing the “auto” key. The progress of the autoconfigure can then be determined by the bit in the RDY register. If autoconfigure or self test is in progress an error is generated. The instrument will start testing when autoconfigure has been completed.

AUT

Stored Panel Lock

This command allows the stored panels to be store locked. That is to say, if the stored panel lock is set then the save operation is prohibited. After any save or recall operation this field is always set back to ON.

SLK <i>n</i>	<i>n</i> = 0 or OFF	Stored panel lock disabled
	1 or ON	Stored panel lock enabled

SLK? returns *store lock status* = 0 or 1

Beep Command

This command causes an audio “beep” to be made by the instrument. It has no local equivalent operation and is as follows:-

BEEP

Volume Command

This command sets the volume. It is equivalent to pressing either the increase or decrease volume keys on the front panel.

VOL <i>parameter</i>	<i>parameter</i> =	OFF or 0	Switches sound to its quietest level
		ON or 1	Switches sound to its loudest level
		DECREASE or 2	Decreases the level
		INCREASE or 3	Increases the level
		MIDRANGE or 4	Sets the level to a midrange value

- There will be a delay of up to 500mS between the execution of this command and the actual start of testing. This is because the start of testing must be synchronized to the instruments internal 100mS clock, see Programming Tips for more details.

Stop Measurement

This command causes the instrument to stop testing, irrespective of the type of test period it is performing. The results are now left unchanged and can be inspected at leisure.

STP

- There will be a delay of up to 500mS between the execution of this command and the actual end of testing. This is because the end of testing must be synchronized to the instruments internal 100mS clock, see Programming Tips for more details.
- If this command is sent while the instrument has stopped, an error is generated.

T1/Datacom Mode

Selects the mode of the instrument to be either telecom or datacom.

Note: This command causes the instrument to be completely reconfigured. During this reconfiguration any remote control commands sent to the instrument will be ignored, and afterwards the instrument will be LOCAL.

MODE *n* *n* = 1 or DATACOM
 2 or TELECOM

An error is generated if this command is sent to an HP 37701A, i.e. the accessory must be fitted for correct operation of this command.

The corresponding query command returns the currently selected mode in integer format as described below:-

MODE? returns 1 or 2

RS232C Printer Interface

This command configures the printer serial interface configuration. Notice that it sets up parameters for both HP and ALT type printers.

```
PTR baud_rate,stop_bits,protocol,style      baud_rate = 1 or 300
                                                2 or 600
                                                3 or 1200
                                                4 or 1800
                                                5 or 2400
                                                6 or 4800
                                                7 or 9600
stop_bits = 1 or ONE
                                                2 or TWO
protocol = 0 or OFF
                                                1 or ENQUACK
                                                2 or XONXOFF
                                                3 or DTR
style = 1 or COMPRESSED
                                                2 or NORMAL
```

Notice that the data width is always set to 8 bits wide. This is equivalent to 7 bit wide data with zeroes parity. Notice that this command does not set the RS 232 port up to be a printer interface, it only sets up the parameters.

```
PTR? returns baud_rate,stop_bits,protocol,style  baud_rate = 1 to 7
                                                stop_bits = 1 or 2
                                                protocol = 0 to 3
                                                style = 1 or 2
```

Date Set-Up

This command sets the date in the instrument, in terms of the year, month, and day. If a non-existent date is passed (31st November), then an error is generated. This command is equivalent to selecting "TIME AND DATE SETUP" mode on the front panel, updating the setup date, then selecting "TIME AND DATE RUN" mode.

DAT	<i>years,months,days</i>	<i>years =</i>	1980 to 2050	
		<i>months =</i>	1	JAN
			2	FEB
			3	MAR
			4	APR
			5	MAY
			6	JUN
			7	JLY
			8	AUG
			9	SEP
			10	OCT
			11	NOV
			12	DEC
		<i>days =</i>	1 to 31	

The complementary command returns current the real time clock date in string form as shown above.

DAT? returns *years,months,days*

Time Set-Up

This command sets the time in the instrument in terms of hours, minutes, and seconds. This command is equivalent to selecting "TIME AND DATE SETUP" mode on the front panel, updating the setup time, then selecting "TIME AND DATE RUN" mode.

TIM	<i>hours,mins,secs</i>	<i>hours =</i>	0 to 23
		<i>mins =</i>	0 to 59
		<i>secs =</i>	0 to 59

The complementary command returns the time in string form as shown above.

TIM? returns *hours,mins,secs*

Display

Switches the Instrument electroluminescent display ON or OFF. Notice that for instruments without battery power, this will not have any effect (ie. the display will remain on, even if off is sent). The command is still valid however, as is the corresponding query command.

DIS <i>n</i>	<i>n</i> = 0 or OFF	Display disabled
	1 or ON	Display enabled

The complementary command returns the current threshold in integer form as described above:-

DIS? returns *display status* = 0 or 1

ALM Query

This command is a request for the instantaneous status of the alarms in the instrument. They are returned as an integer representing the binary weighted alarm bits of the Alarm Register.

When executed, the "ALM" command clears the ALC bit in both status register A and B. A change in state of any of these alarms causes the ALC bit to be set in status registers A and B only if their corresponding mask is enabled in the alarm mask register.

The "ALM" command has no local equivalent, and is as follows:-

ALM?

The complementary command returns the current threshold in integer form as described above:-

ALM? returns *n* = 0 to 16383

Alarm change Query

This command is a request to determine which alarms have changed their state. The bits which have changed are returned as an integer representing the binary weighted alarm bits of the Alarm Register.

When executed, the "ALC?" command clears all alarm change bits.

The "ALC?" command has no local equivalent, and is as follows:-

ALC? returns *n* = 0 to 16383

Where the bits have the same significance as the alarm register.

Alarm Mask

Sets up Alarm Mask Register (AMR). This register is used to determine under what conditions the Alarm Change (ALC) bit in Status Register A should be set. If a bit in the Alarm Status register changes (either from 1 to 0 or vice-versa), and the corresponding bit in the Alarm Mask Register is set, the ALC bit in Status Registers A and B are set. The ALC bit is cleared by the ALM?, RST, CLR commands.

The argument to AMR can be specified in a number of ways:-

- As a binary-weighted integer
- As a list of integer values (which are OR'ed)
- As a list of alarm mnemonics

AMR *n n* = 0 to 30719

To disable all alarms, specify AMR 0 or AMR NONE.

The corresponding query returns the current value of Alarm Mask Register in integer form as described above.

AMR? returns *n* = 0 to 30719

History Query

This command is a request to determine which alarms have been set during the last testing period or during the current testing period if testing is in progress. The history alarms are all reset at the start of a testing period. In addition they may be reset by the "HSR" command. The bits which have been set are returned as an integer representing the binary weighted alarm bits of the Alarm Register.

The "HIS?" command is equivalent to pressing the history key on the front panel, and is as follows:-

HIS? returns *n* = 0 to 16383

Where the bits have the same significance as the alarm register.

History Reset

This command resets the history leds and the bits in the history register. It is equivalent to pressing the history reset key on the front panel and is as follows:-

HSR

TSS? *n*

Returns:-

<i>flag,oor,n</i>	<i>flag</i> = 0 or 1	Validity Flag
	<i>oor</i> = 0	The monitor result is timeslot data
	<i>oor</i> = 1	The monitor result is a mapped timeslot
	<i>n</i> = 0 to 255	Monitor result (timeslot data)
	<i>n</i> = 1 to 24	Monitor result (mapped timeslot)

ERROR INSERT COMMANDS

Error Insert Rate

Selects the rate of error addition into the transmitter data stream.

EIR <i>n</i>	<i>n</i> = 1 or ERRFREE	Error insert disabled
	2 or ONEINMIN3	Insert errors at 10 ⁻³ ratio
	3 or USER	Insert errors at user defined rate

The corresponding query returns the error insert mode, in integer form as described above:-

EIR? returns *error insert mode* = 1 to 3

Error Insert Type

Selects the type of errors to be inserted. Error insert rate must be set to other than "ERRFREE".

EIT <i>n</i>	<i>n</i> = 1 or LOGIC	Insert logic errors
	2 or FRAME	Insert frame errors
	3 or CRC	Insert CRC errors
	4 or BPV	Insert BPV errors

The corresponding query returns the error insert type, in integer form as described above:-

EIT? returns *error insert type* = 1 to 4

User Defined Error Insert Ratio

Selects user defined error insert ratio.

EIU <i>n</i>	<i>n</i> = 1 or EMIN3	1 in 10 ⁻³
	2 or EMIN4	1 in 10 ⁻⁴
	3 or EMIN5	1 in 10 ⁻⁵
	4 or EMIN6	1 in 10 ⁻⁶
	5 or EMIN7	1 in 10 ⁻⁷

EIU? returns *error rate* = 1 to 5

Single Error Insert

This command injects a single error into the generator output stream provided that the generator is in error free mode. If not, an error is produced. This command is equivalent to pressing the front panel single error button.

SEI

RESULT QUERY COMMANDS

This section contains all measurement result query commands. If these commands are executed outside testing, the last testing period results are returned; during testing the results returned are dependent on the type of measurement period.

If the instrument is in CONTINUOUS, TIMED or USER modes, the results returned are the “current” results.

Some results are not always available, therefore they return not only the result but a validity flag. In addition a second flag indicates whether the result is inrange, under or overrange. For most results this will always be inrange, but it is used in the case of simplex current and wander results. It is included in all results however, to maintain a consistent format.

Wander Lock Query

This query command returns the instantaneous lock status of the wander measurement.

WLK? returns <i>flag</i> = 0	No reference present
1	Reference is present

Logic Error Result Query

This command requests one of the logic error results. The format of the result returned will depend upon the selected result. This will reset the EOT bits in STA and STB.

RLE? <i>n</i>	<i>n</i> = 1 or ES	Asynchronous error seconds count
	3 or EFS	Error free seconds
	4 or PCEFS	% error free seconds
	5 or EC	Error count
	6 or ER	Average error ratio
	7 or CUER	Current error ratio

See also the *Command History* table at the end of this chapter.

Returns:-

<i>flag,oor,n</i>	<i>flag</i> = 0 or 1	Validity Flag
	<i>oor</i> = 1	Out of range (always inrange)
	<i>n</i> = 0 to 999999999	Count, Seconds Result if <1000000000
	<i>n</i> = XX.XXE+X	Count, Seconds Result if ≥1000000000
	<i>n</i> = 0.0 to 1.0E-XX	Ratio Result
	<i>n</i> = XX.XXX or 100.000	Percentage Result

These results will be invalid if the pattern is LIVE.

Logic Analysis Result Query

This command requests one of the logic analysis results. The format of the result returned will depend upon the selected result. This will reset the EOT bits in STA and STB.

RLA? <i>n</i>	<i>n</i> = 1 or PCAVAIL	% availability
	2 or DM	Degraded minutes count
	3 or PCDM	% degraded minutes
	4 or SES	G821 severely errored seconds count
	5 or PCSES	% G821 severely errored seconds
	6 or ES	G821 error seconds count
	7 or PCES	% G821 error seconds
	8 or CSES	Consecutive severely errored seconds
	9 or UAS	Unavailable seconds count

Returns:-

<i>flag,oor,n</i>	<i>flag</i> = 0 or 1	Validity Flag
	<i>oor</i> = 1	Out of range (always inrange)
	<i>n</i> = 0 to 999999999	Count, Seconds Result if <1000000000
	<i>n</i> = XX.XXE+X	Count, Seconds Result if ≥1000000000
	<i>n</i> = XX.XXX or 100.000	Percentage Result

These results will be invalid if the pattern is LIVE.

BPV Error Result Query

This command requests one of the BPV error results. The format of the result returned will depend upon the selected result. This will reset the EOT bits in STA and STB.

RBP? <i>n</i>	<i>n</i> = 1 or ES	Asynchronous error seconds count
	2 or EFS	Error free seconds
	3 or PCEFS	% error free seconds
	4 or EC	Error count
	5 or ER	Average error ratio
	6 or CUER	Current error ratio

Returns:-

<i>flag,oor,n</i>	<i>flag</i> = 0 or 1	Validity Flag
	<i>oor</i> = 1	Out of range (always inrange)
	<i>n</i> = 0 to 999999999	Count, Seconds Result if <1000000000
	<i>n</i> = XX.XXE+X	Count, Seconds Result if ≥1000000000
	<i>n</i> = 0.0 to 1.0E-XX	Ratio Result
	<i>n</i> = XX.XXX or 100.000	Percentage Result

Frame Error Result Query

This command requests one of the frame error results. The format of the result returned will depend upon the selected result. This will reset the EOT bits in STA and STB.

RFE? <i>n</i>	<i>n</i> = 1 or ES	Asynchronous error seconds count
	2 or EC	Error count
	3 or ODFC	Out of frame events count
	4 or COFA	COFA events count
	5 or LOSS	Frame loss seconds count
	6 or LOFC	Loss of frame events count
	7 or SEFC	Severely errored framing events count
	8 or ER	Average error ratio

Returns:-

<i>flag,oor,n</i>	<i>flag</i> = 0 or 1	Validity Flag
	<i>oor</i> = 1	Out of range (always inrange)
	<i>n</i> = 0 to 999999999	Count, Seconds Result if <1000000000
	<i>n</i> = XX.XXE+X	Count, Seconds Result if ≥1000000000
	<i>n</i> = 0.0 to 1.0E-XX	Ratio Result

These results will be invalid if the framing type is UNFRAMED.

Frame Analysis Result Query

This command requests one of the frame analysis results. The format of the result returned will depend upon the selected result. This will reset the EOT bits in STA and STB.

RFA? <i>n</i>	<i>n</i> = 1 or PCAVAIL	% availability
	2 or UAS	Degraded minutes count
	3 or SES	Unavailable seconds count
	4 or CSES	G821 severely errored seconds count
		Consecutive severely errored seconds

Returns:-

<i>flag,oor,n</i>	<i>flag</i> = 0 or 1	Validity Flag
	<i>oor</i> = 1	Out of range (always inrange)
	<i>n</i> = 0 to 999999999	Count, Seconds Result if <1000000000
	<i>n</i> = XX.XXE+X	Count, Seconds Result if ≥1000000000
	<i>n</i> = XX.XXX or 100.000	Percentage Result

These results will be invalid if the framing type is UNFRAMED.

CRC Error Result Query

This command requests one of the CRC error results. The format of the result returned will depend upon the selected result. This will reset the EOT bits in STA and STB.

RCR? <i>n</i>	<i>n</i> = 1 or ES	Asynchronous error seconds count
	2 or EFS	Error free seconds
	3 or PCEFS	% error free seconds
	4 or EC	Error count
	5 or ER	Average error ratio
	6 or CUER	Current error ratio

Returns:-

<i>flag, oor, n</i>	<i>flag</i> = 0 or 1	Validity Flag
	<i>oor</i> = 1	Out of range (always inrange)
	<i>n</i> = 0 to 999999999	Count, Seconds Result if <1000000000
	<i>n</i> = XX.XXE+X	Count, Seconds Result if ≥1000000000
	<i>n</i> = 0.0 to 1.0E-XX	Ratio Result
	<i>n</i> = XX.XXX or 100.000	Percentage Result

These results will only be valid if the framing type is ESF.

CRC Analysis Result Query

This command requests one of the CRC analysis results. The format of the result returned will depend upon the selected result. This will reset the EOT bits in STA and STB.

RCA? <i>n</i>	<i>n</i> = 1 or PCAVAIL	% availability
	2 or DM	Degraded minutes count
	3 or PCDM	% degraded minutes
	4 or SES	G821 severely errored seconds count
	5 or PCSES	% G821 severely errored seconds
	6 or ES	G821 error seconds count
	7 or PCES	% G821 error seconds
	8 or CSES	Consecutive severely errored seconds
	9 or UAS	Unavailable seconds count

Returns:-

<i>flag,oor,n</i>	<i>flag</i> = 0 or 1	Validity Flag
	<i>oor</i> = 1	Out of range (always inrange)
	<i>n</i> = 0 to 999999999	Count, Seconds Result if <1000000000
	<i>n</i> = XX.XXE+X	Count, Seconds Result if ≥1000000000
	<i>n</i> = XX.XXX or 100.000	Percentage Result

These results will only be valid if the framing type is ESF.

Receiver Level Result Query

This command requests the receiver level result. This will reset the EOT bits in STA and STB.

RRL? <i>n</i>	<i>n</i> = 1 or LEVDSX	Signal level in dBx
	2 or LEVDBM	Signal level in dBm
	3 or LEVVOLTS	Signal level in volts
	4 or LEVBAL	Imbalance in volts

Returns:-

<i>flag,oor,n</i>	<i>flag</i> = 0 or 1	Validity Flag
	<i>oor</i> = 0 or 1	Underrange or inrange
	<i>n</i> = -40 to +6	dBx
	<i>n</i> = -23 to +23	dBm
	<i>n</i> = 0 to X.XX	Volts

The measurement will be underrange if no signal is present.

Wander Results Query

This command requests the wander results. Opt.001 is required to perform this measurement and an error number will be generated if it is not fitted. This will reset the EOT bits in STA and STB.

RWN? n	n = 1 or WANINST	instantaneous wander
	2 or WANPOS	positive pk wander
	3 or WANNEG	negative peak wander
	4 or WANPKPK	pk-pk wander
	5 or WAN15MIN	15 min wander
	6 or WAN24HR	24 hour wander

Returns:-

flag,oor,n	flag = 0 or 1	Validity Flag
	oor = 0 or 1	underrange
	n = 0 to XXX.XXX	Wander

The result will be underrange if the wander reference circuit has lost lock.

The result will be invalid in no wander measurement hardware is present.

Signaling Bits Result Query

This command requests the signaling bits result as displayed on the VF access page. This will reset the EOT bits in STA and STB.

RSG? returns *flag,oor,n,"sigbits"*

flag = 0 or 1	Validity Flag
oor = 1	Out of range (always inrange)
n = 0,2,4	length
"sigbits" = 0000 to 1111	signaling bits

The result will be invalid if the framing is SLC96 or UNFRAMED, or the SIGNALING BIT, TIMESLOT CHECK or HI RTD special tests have been selected.

Channel Monitor All Signalling Bits Query Command

This command requests the bit result for the currently selected signalling bit display. The returned result will be a binary number string. Results will be invalid if the pattern is anything other than SPECIAL - SIG BIT TEST with the displayed result type field set to ALL.

The timeslot that the channel corresponds to will depend on the mapping selected (Cf. CHM command).

This will reset the EOT bits in STA and STB.

SIG? when *n* is a channel number

Returns:-

<i>flag, oor, "n"</i>	<i>flag</i> = 0 or 1	Validity Flag
	<i>oor</i> = 1	Inrange
	" <i>n</i> " = "00" to "11"	Signaling bits for non ESF framing in channel <i>n</i>
	"0000" to "1111"	Signaling bits for ESF framing in channel <i>n</i>

Channel Monitor single signaling bits Query Command

This command requests the signaling bit result from the currently selected channel. The result will only be valid if the special signaling bit test has been selected, and the display type is set to single. The returned result will be a binary number string.

The timeslot that the channel corresponds to will depend on the mapping selected (Cf. CHM command).

This will reset the EOT bits in STA and STB.

SCG?

Returns:-

<i>flag, oor, "n"</i>	<i>flag</i> = 0 or 1	Validity Flag
	<i>oor</i> = 1	Inrange
	" <i>n</i> " = "00" to "11"	Signaling bits for non ESF framing
	"0000" to "1111"	Signaling bits for ESF framing

Simplex Current Result Query

This command requests the simplex current result. This will reset the EOT bits in STA and STB.

RSI? returns <i>flag, oor, n</i>	<i>flag</i> = 0 or 1	Validity Flag
	<i>oor</i> = 0 or 1	underrange
	<i>n</i> = 0 to XXX	milliamps

The result will be underrange if the current drops below 10mA.

Signal Frequency Result Query

This command requests the signal frequency result. This will reset the EOT bits in STA and STB.

RSF? returns	<i>flag,oor,n</i>	<i>flag</i> = 0 or 1	Validity Flag
		<i>oor</i> = 1	Out of range (always inrange)
		<i>n</i> = XXXXXXX	Hz

Notice that this result remains valid even if no signal is present. Under these circumstances the count will be zero.

Signal Frequency Offset Result Query

This command requests the signal frequency offset result. This will reset the EOT bits in STA and STB.

RFO? returns	<i>flag,oor,n</i>	<i>flag</i> = 0 or 1	Validity Flag
		<i>oor</i> = 1	Out of range (always inrange)
		<i>n</i> = 0 to XXX	parts per million

Notice that this result remains valid even if no signal is present. Under these circumstances the count will be zero.

Signal Round Trip Delay Query

This command requests the signal round trip delay. This will reset the EOT bits in STA and STB.

RRT? returns	<i>flag,oor,n</i>	<i>flag</i> = 0 or 1	Validity Flag
		<i>oor</i> = 0 or 1	underrange
		<i>n</i> = 1 to 500	milliseconds

The result will go underrange if no signal is present.

Power Fail Alarm Seconds Result Query

This command requests the power fail alarm seconds result. This will reset the EOT bits in STA and STB.

RPF?	<i>flag,oor,n</i>	<i>flag</i> = 0 or 1	Validity Flag
returns		<i>oor</i> = 1	Out of range (always inrange)
		<i>n</i> = 0 to 999999999	Seconds

Yellow Alarm Seconds Result Query

This command requests the yellow alarm seconds result. This will reset the EOT bits in STA and STB.

RYA?	<i>flag,oor,n</i>	<i>flag</i> = 0 or 1	Validity Flag
returns		<i>oor</i> = 1	Out of range (always inrange)
		<i>n</i> = 0 to 999999999	Seconds

This result will be invalid if the framing selection is OFF.

Excess Zeros Alarm Seconds Result Query

This command requests the excess zeros alarm seconds result. This will reset the EOT bits in STA and STB.

RXZ?	<i>flag,oor,n</i>	<i>flag</i> = 0 or 1	Validity Flag
returns		<i>oor</i> = 1	Out of range (always inrange)
		<i>n</i> = 0 to 999999999	Seconds

Pattern Loss Seconds Result Query

This command requests the pattern loss alarm seconds result. This will reset the EOT bits in STA and STB.

RPL?	<i>flag,oor,n</i>	<i>flag</i> = 0 or 1	Validity Flag
returns		<i>oor</i> = 1	Out of range (always invalid)
		<i>n</i> = 0 to 999999999	Seconds

This result will be invalid if the pattern is set to LIVE.

Frame Loss Alarm Seconds Result Query

This command requests the frame loss alarm seconds result. This will reset the EOT bits in STA and STB.

RFL?	<i>flag,oor,n</i>	<i>flag</i> = 0 or 1	Validity Flag
returns		<i>oor</i> = 1	Out of range (always inrange)
		<i>n</i> = 0 to 999999999	Seconds

This command will be invalid if the framing is set to OFF.

Signal Loss Alarm Seconds Result Query

This command requests the signal loss alarm seconds result. This will reset the EOT bits in STA and STB.

RSL?	<i>flag,oor,n</i>	<i>flag</i> = 0 or 1	Validity Flag
returns		<i>oor</i> = 1	Out of range (always invalid)
		<i>n</i> = 0 to 999999999	Seconds

All Ones AIS Alarm Seconds Result Query

This command requests the all ones (AIS) alarm seconds result.

RAO?	<i>flag,oor,n</i>	<i>flag</i> = 0 or 1	Validity Flag
returns		<i>oor</i> = 1	Out of range (always invalid)
		<i>n</i> = 0 to 999999999	Seconds

Uncontrolled Slips Result Query

This command requests the uncontrolled slips result. This will reset the EOT bits in STA and STB.

RUS?	<i>flag,oor,n</i>	<i>flag</i> = 0 or 1	Validity Flag
returns		<i>oor</i> = 1	Out of range (always invalid)
		<i>n</i> = 0 to 999999999	Slip count

This result will be valid if we have a PRBS or QRSS pattern or we have any framing other than unframed.

Controlled Slips Result Query

This command requests the controlled slips result. This will reset the EOT bits in STA and STB.

RCS?	<i>flag,oor,n</i>	<i>flag</i> = 0 or 1	Validity Flag
returns		<i>oor</i> = 1	Out of range (always inrange)
		<i>n</i> = 0 to 999999999	Slip count

This result is only valid if the pattern is a PRBS or QRSS and the framing is anything other than unframed.

Bit Slips Result Query

This command requests the bit slips result. This will reset the EOT bits in STA and STB.

RBS?	<i>flag,oor,n</i>	<i>flag</i> = 0 or 1	Validity Flag
returns		<i>oor</i> = 1	Out of range (always inrange)
		<i>n</i> = 0 to 999999999	Slip count

This result will only be valid if the option is fitted.

Estimated Frame Slips Result Query

This command requests the estimated frame slips result. This will reset the EOT bits in STA and STB.

RFS?	<i>flag,oor,n</i>	<i>flag</i> = 0 or 1	Validity Flag
returns		<i>oor</i> = 1	Out of range (always inrange)
		<i>n</i> = 0 to 999999999	Slip count

This result will only be valid if the option is fitted.

Pulse Mask Result Query

This command requests the pulse mask result.

Only valid when pulse mask option fitted. This will reset the EOT bits in STA and STB.

RPM? <i>n</i>	<i>n</i> = 1 or RTIME	pulse rise time (nS)
	2 or FTIME	pulse fall time (nS)
	3 or WIDTH	pulse width (nS)
	4 or OVERSHOOT	pulse overshoot (nS)
	5 or UNDERSHOOT	pulse undershoot (nS)
	6 or OVERALL	pass/fail

Returns:-

<i>flag,oor,n</i>	<i>flag</i> = 0 or 1	Validity Flag
	<i>oor</i> = 1	Out of range (always inrange)
	<i>n</i> = 0 to 999	Pulse mask result
	<i>n</i> = 0 or 1	Overall result; 1 = pass, 0 = fail

Pulse Mask Plot Query

This command requests the pulse plot information.

Only valid when pulse mask option fitted.

RPP? returns *n,cr,lf,[validity,lwr_msk_pnt, pulse_pnt,upp_msk_pnt,cr,lf]*n*

validity indicates that the pulse points are valid. Some will not be valid if the pulse has been truncated . A value of 0 for *n* means that the result is not yet available.

The points themselves are in terms of the pixel coordinates as would be sent to a printer.

Elapsed Time Result Query

This command requests the elapsed time since the start of the current test. This will reset the EOT bits in STA and STB.

ELP? returns	<i>flag,dd,hh,mm,ss</i>	<i>flag</i> = 0 to 1	Validity Flag
		<i>dd</i> = 0 to 99	Days
		<i>hh</i> = 0 to 23	hours
		<i>mm</i> = 0 to 59	Minutes
		<i>ss</i> = 0 to 59	Seconds

Timeslot Monitor Query Command

This command requests the bit result from the currently selected timeslot. The returned result will be a binary number string. This will reset the EOT bits in STA and STB. The result will be invalid if the test has not been selected.

BIT?

Returns:-

<i>flag,oor,"n"</i>	<i>flag</i> = 0 or 1	Validity Flag
	<i>oor</i> = 1	Inrange
	<i>"n"</i> = "00000000" to "11111111"	Monitor result

TX Timeslot bandwidth query

This command requests the TX fractional T1 bandwidth in kHz. It corresponds to the tx bandwidth field displayed beside the tx timeslot selection field.

TBW? returns *n* *n* = 0 to 1544 Bandwidth (in kHz)

Timeslot Swap Result Query Command

This result gives details about any swapped timeslots. Querying a particular timeslot will return information specifying that either a valid timeslot data stream has been detected or that no valid signature has been detected. In the case of the latter the current timeslot data is returned instead.

This will reset the EOT bits in STA and STB.

Round Trip Delay in Timeslot Query Command

This result gives details of round trip delay in a timeslot. The result will be underrange if no signal is present and invalid if the test has not been selected.

This will reset the EOT bits in STA and STB.

RDT?

Returns:-

<i>flag,oor,n</i>	<i>flag</i> = 0 or 1	Validity Flag
	<i>oor</i> = 0 to 11	Underrange or Inrange
	<i>n</i> = 0 to 999.999	Round trip delay in timeslot (ms)

STORED RESULTS COMMANDS

In general the commands do not work during testing since the stored measurement graphics (SMG) store would be subject to manipulations that corrupt the access made by the remote control.

All query commands which request G.821 analysis data from the store will generate an error if the G.821 option is not fitted. All the remainder of the commands will generate an error if the stored measurement graphics option is not fitted.

Get store size and usage

SMS? returns *storesize,storeuse*

storesize = SMG store size in samples
storeuse = How many store entries are in use

Note that automatic compaction will take place when the store is full.

Get store use information

SMC? returns *storenum,demobit,year,month,day,hour,min,length,res*

storenum = store number (-9 to 0) where 0 is the most recent
demobit = 1 for DEMO measurements, else 0
year = year test was started
month = month test was started
day = day test was started
hour = hour test was started
min = minute test was started
length = the number of samples in the test
res = the resolution of the samples in minutes

followed by one line: EOI

Entries will only be printed for store entries that are in use. For example:

```
0, 0, 1990, 1, 24, 10, 14, 2345, 1
-1, 0, 1990, 1, 10, 23, 54, 12980, 1
-2, 1, 1989, 12, 24, 7, 45, 458, 15
-3, 0, 1989, 12, 5, 7, 23, 561, 15
-4, 0, 1989, 11, 7, 8, 12, 2197, 60
EOI
```

Get store data

SMD? *n* returns store sample data as a series of records, one for each sample, for store *n*. The number of records depends on how many values are sampled in each period. The store number *n* should be in the range 0 to -9. The form is:

logic-data,bpv-data,frame-data,crc-data,"alarms1", "alarms2"

followed by one line: EOI

Graph data is returned as exponential numbers for example 3E+6. The alarms are organized as follows:

"alarms1" =

d0	Ones density alarm
d1	Excess zeros alarm
d2	Slip alarm
d3	Pattern loss alarm
d4	Frame loss alarm
d5	AIS alarm
d6	Signal loss alarm
d7	Power loss alarm

"alarms2" =

d0	reserved for future use (may be 0 or 1)
d1	reserved for future use (may be 0 or 1)
d2	reserved for future use (may be 0 or 1)
d3	reserved for future use (may be 0 or 1)
d4	Loopdown detected alarm
d5	Loopup detected alarm
d6	Excess wander alarm
d7	Yellow alarm

Note the precision is limited to one decimal digit of mantissa and one decimal digit of exponent. Alarms are returned as strings of 1's and 0's, for example "10011000".

An example of the response to SMD? *n* is:

```
0E+0, 0E+0, 0E+0, 0E+0, "00000000", "00000000"  
1E+0, 0E+0, 0E+0, 0E+0, "00000000", "00000000"  
4E+1, 5E+2, 1E+1, 0E+0, "00010000", "10000000"  
0E+0, 0E+0, 0E+0, 0E+0, "00000000", "00000000"  
0E+0, 0E+0, 0E+0, 0E+0, "00000000", "00000000"  
8E+8, 5E+5, 2E+2, 1E+0, "00000110", "00110000"  
0E+0, 0E+0, 0E+0, 0E+0, "00000000", "00000000"  
0E+0, 0E+0, 0E+0, 0E+0, "00000000", "00000000"  
EOI
```

Get store data in compressed form

The command SMZ? *n* returns store sample data for store *n* in a more compressed form than that of the SMD? command. Each output line is prepended by a integer repeat count. Since for live data a lot of the samples will be zero, the data size will be very much compressed, this is useful when operating over modems where transmission is slow. It is up to the controller to interpret the data back to its uncompressed form. Example output:

```
2, 0E+0, 0E+0, 0E+0, 0E+0, "00000000", "00000000"  
1, 4E+1, 5E+2, 1E+1, 0E+0, "00010000", "10000000"  
2, 0E+0, 0E+0, 0E+0, 0E+0, "00000000", "00000000"  
1, 8E+8, 5E+5, 2E+2, 1E+0, "00000110", "00110000"  
2, 0E+0, 0E+0, 0E+0, 0E+0, "00000000", "00000000"  
EOI
```

Storage Lock

This command enables/disables the storing of results to the store. An error will be generated if the instrument is not fitted with stored measurement graphics.

SRG <i>n</i>	<i>n</i> = 0 or OFF	data will not be stored
	1 ON or MIN1	data will be stored at 1 minute resolution
	2 or MIN15	data will be stored at 15 minute resolution
	3 or HR1	data will be stored at 1 hour resolution

The corresponding query returns the current storage status, in integer form as described above:-

SRG? returns *storage selection* = 0 to 3

NOTE: The string of results is always disabled after the instrument has stopped or is restarted. Notice that this command causes the instrument to restart, and no "STR" command is required. If an "STR" command is sent then the instrument will restart and disable the storage.

Stored Logic Error Result Query

This command requests a logic error result from a specified store. The format of the result returned will depend upon the selected result.

SRLE? <i>store,result</i>	<i>store</i> = -9 to 0	Store number
	<i>result</i> = 1 or ES	Asynchronous error seconds count
	3 or EFS	Error free seconds
	4 or PCEFS	% error free seconds
	5 or EC	Error count
	6 or ER	Average error ratio

See also the *Command History* table at the end of this chapter.

Returns:-

<i>flag,oor,n</i>	<i>flag</i> = 0 or 1	Validity Flag
	<i>oor</i> = 1	Out of range (always inrange)
	<i>n</i> = 0 to 999999999	Count, Seconds Result if <1000000000
	<i>n</i> = XX.XXE+X	Count, Seconds Result if ≥1000000000
	<i>n</i> = 0.0 to 1.0E-XX	Ratio Result
	<i>n</i> = XX.XXX or 100.000	Percentage Result

These results will be invalid if the stored pattern was LIVE.

Stored Logic Analysis Result Query

This command requests a stored logic analysis result from a specified store. The format of the result returned will depend upon the selected result.

<i>SRLA? store,result</i>	<i>store</i> = -9 to 0	Store number
	<i>result</i> = 1 or PCAVAIL	% availability
	2 or DM	Degraded minute count
	3 or PCDM	% degraded minutes
	4 or SES	G821 severely errored seconds count
	5 or PCSES	% G821 severely errored seconds
	6 or ES	G821 error seconds count
	7 or PCES	% G821 error seconds
	8 or CSES	Consecutive severely errored seconds
	9 or UAS	Unavailable seconds count

Returns:-

<i>flag,oor,n</i>	<i>flag</i> = 0 or 1	Validity Flag
	<i>oor</i> = 1	Out of range (always inrange)
	<i>n</i> = 0 to 999999999	Count, Seconds Result if <1000000000
	<i>n</i> = XX.XXE+X	Count, Seconds Result if ≥1000000000
	<i>n</i> = XX.XXX or 100.000	Percentage Result

These results will be invalid if the stored pattern was LIVE.

Stored BPV Error Result Query

This command requests a stored BPV error result from a specified store. The format of the result returned will depend upon the selected result.

SRBP? <i>store,result</i>	<i>store</i> = -9 to 0	Store number
	<i>result</i> = 1 or ES	Asynchronous error seconds count
	2 or EFS	Error free seconds count
	3 or PCEFS	% error free seconds
	4 or EC	Error count
	5 or ER	Average error ratio

Returns:-

<i>flag,oor,n</i>	<i>flag</i> = 0 or 1	Validity Flag
	<i>oor</i> = 1	Out of range (always inrange)
	<i>n</i> = 0 to 999999999	Count, Seconds Result if <1000000000
	<i>n</i> = XX.XXE+X	Count, Seconds Result if ≥1000000000
	<i>n</i> = 0.0 to 1.0E-XX	Ratio Result
	<i>n</i> = XX.XXX or 100.000	Percentage Result

Stored Frame Error Result Query

This command requests a stored frame error result from a specified store. The format of the result returned will depend upon the selected result.

SRFE? <i>store,result</i>	<i>store</i> = -9 to 0	Store number
	<i>result</i> = 1 or ES	Asynchronous error seconds count
	2 or EC	Error count
	3 or OOFC	Out of frame events count
	4 or COFA	COFA events count
	5 or LOSS	Frame loss seconds count
	6 or LOFC	Loss of frame events count
	7 or SEFC	Severely errored framing events count
	8 or ER	Average error ratio

Returns:-

<i>flag,oor,n</i>	<i>flag</i> = 0 or 1	Validity Flag
	<i>oor</i> = 1	Out of range (always inrange)
	<i>n</i> = 0 to 999999999	Count, Seconds Result if <1000000000
	<i>n</i> = XX.XXE+X	Count, Seconds Result if ≥1000000000
	<i>n</i> = 0.0 to 1.0E-XX	Ratio Result

These results will be invalid if the stored framing type was UNFRAMED.

Stored Frame Analysis Result Query

This command requests a stored frame analysis result from a specified store. The format of the result returned will depend upon the selected result.

SRFA? <i>store,result</i>	<i>store</i> = -9 to 0	Store number
	<i>result</i> = 1 or PCAVAIL	% availability
	2 or UAS	Unavailable seconds count
	3 or SES	G821 severely errored seconds count
	4 or CSES	Consecutive severely errored seconds

Returns:-

<i>flag,oor,n</i>	<i>flag</i> = 0 or 1	Validity Flag
	<i>oor</i> = 1	Out of range (always inrange)
	<i>n</i> = 0 to 999999999	Count, Seconds Result if <1000000000
	<i>n</i> = XX.XXE+X	Count, Seconds Result if ≥1000000000
	<i>n</i> = XX.XXX or 100.000	Percentage Result

These results will be invalid if the stored framing type was UNFRAMED.

Stored CRC Error Result Query

This command requests a stored CRC error result from a specified store. The format of the result returned will depend upon the selected result.

SRCR? <i>store,result</i>	<i>store</i> = -9 to 0	Store number
	<i>result</i> = 1 or ES	Asynchronous error seconds count
	2 or EFS	Error free seconds count
	3 or PCEFS	% error free seconds
	4 or EC	Error count
	5 or ER	Average error ratio

Returns:-

<i>flag,oor,n</i>	<i>flag</i> = 0 or 1	Validity Flag
	<i>oor</i> = 1	Out of range (always inrange)
	<i>n</i> = 0 to 999999999	Count, Seconds Result if <1000000000
	<i>n</i> = XX.XXE+X	Count, Seconds Result if ≥1000000000
	<i>n</i> = 0.0 to 1.0E-XX	Ratio Result
	<i>n</i> = XX.XXX or 100.000	Percentage Result

These results will only be valid if the stored framing type was ESF.

Stored CRC Analysis Result Query

This command requests a stored CRC analysis result from a specified store. The format of the result returned will depend upon the selected result.

SRCA? <i>store,result</i>	<i>store</i> = -9 to 0	Store number
	<i>result</i> = 1 or PCAVAIL	% availability
	2 or DM	Degraded minute count
	3 or PCDM	% degraded minutes
	4 or SES	G821 severely errored seconds count
	5 or PCSES	% G821 severely errored seconds
	6 or ES	G821 error seconds count
	7 or PCES	% G821 error seconds
	8 or CSES	Consecutive severely errored seconds
	9 or UAS	Unavailable seconds count

Returns:-

<i>flag,oor,n</i>	<i>flag</i> = 0 or 1	Validity Flag
	<i>oor</i> = 1	Out of range (always inrange)
	<i>n</i> = 0 to 999999999	Count, Seconds Result if <1000000000
	<i>n</i> = XX.XXE+X	Count, Seconds Result if ≥1000000000
	<i>n</i> = XX.XXX or 100.000	Percentage Result

These results will only be valid if the stored framing type was ESF.

Stored Wander Results Query

This command requests a stored wander result from a specified store. Opt.001 is required to perform this measurement and an error number will be generated if it is not fitted.

10-72 Remote Control

SRWN? <i>store,result</i>	<i>store</i> = -9 to 0	Store number
	<i>result</i> = 1 or WANINST	instantaneous wander
	2 or WANPOS	positive pk wander
	3 or WANNEG	negative peak wander
	4 or WANPKPK	pk-pk wander
	5 or WAN15MIN	15 min wander
	6 or WAN24HR	24 hour wander

Returns:-

<i>flag,oor,n</i>	<i>flag</i> = 0 or 1	Validity Flag
	<i>oor</i> = 0 or 1	underrange
	<i>n</i> = 0 to XXX.XXX	Wander

The result will be underrange if the wander reference circuit had lost lock when the result was being stored.

Stored Power Fail Alarm Seconds Result Query

This command requests the stored power fail alarm seconds result from a specified store.

SRPF? *store* = -9 to 0 Store number

Returns:-

<i>flag,oor,n</i>	<i>flag</i> = 0 or 1	Validity Flag
	<i>oor</i> = 1	Out of range (always inrange)
	<i>n</i> = 0 to 999999999	Seconds

Stored Yellow Alarm Seconds Result Query

This command requests the stored yellow alarm seconds result from a specified store.

SRYA? *store* = -9 to 0 Store number

Returns:-

<i>flag,oor,n</i>	<i>flag</i> = 0 or 1	Validity Flag
	<i>oor</i> = 1	Out of range (always inrange)
	<i>n</i> = 0 to 999999999	Seconds

This result will be invalid if the stored framing selection was OFF.

Stored Excess Zeros Alarm Seconds Result Query

This command requests the stored excess zeros alarm seconds result from a specified store.

SRXZ? store = -9 to 0 Store number

Returns:-

<i>flag,oor,n</i>	<i>flag</i> = 0 or 1	Validity Flag
	<i>oor</i> = 1	Out of range (always inrange)
	<i>n</i> = 0 to 999999999	Seconds

Stored Pattern Loss Seconds Result Query

This command requests the stored pattern loss alarm seconds result from a specified store.

SRPL? store = -9 to 0 Store number

Returns:-

<i>flag,oor,n</i>	<i>flag</i> = 0 or 1	Validity Flag
	<i>oor</i> = 1	Out of range (always invalid)
	<i>n</i> = 0 to 999999999	Seconds

This result will be invalid if the stored pattern was set to LIVE.

Stored Frame Loss Alarm Seconds Result Query

This command requests the stored frame loss alarm seconds result from a specified store.

SRFL? store = -9 to 0 Store number

Returns:-

<i>flag,oor,n</i>	<i>flag</i> = 0 or 1	Validity Flag
	<i>oor</i> = 1	Out of range (always inrange)
	<i>n</i> = 0 to 999999999	Seconds

This result will be invalid if the stored framing was set to OFF.

Stored Signal Loss Alarm Seconds Result Query

This command requests the stored signal loss alarm seconds result from a specified store.

SRSL? store = -9 to 0 Store number

Returns:-

<i>flag,oor,n</i>	<i>flag</i> = 0 or 1	Validity Flag
	<i>oor</i> = 1	Out of range (always inrange)
	<i>n</i> = 0 to 999999999	Seconds

Stored All Ones AIS Alarm Seconds Result Query

This command requests the stored all ones (AIS) alarm seconds result from a specified store.

SRAO? store = -9 to 0 Store number

Returns:-

<i>flag,oor,n</i>	<i>flag</i> = 0 or 1	Validity Flag
	<i>oor</i> = 1	Out of range (always inrange)
	<i>n</i> = 0 to 999999999	Seconds

Stored Uncontrolled Slips Result Query

This command requests the stored uncontrolled slips result from a specified store.

SRUS? store = -9 to 0 Store number

Returns:-

<i>flag,oor,n</i>	<i>flag</i> = 0 or 1	Validity Flag
	<i>oor</i> = 1	Out of range (always inrange)
	<i>n</i> = 0 to 999999999	Slip count

This result will be valid if the stored pattern was a PRBS or QRSS pattern and the stored framing was anything other than unframed.

Stored Controlled Slips Result Query

This command requests the stored controlled slips result from a specified store.

SRCS? store = -9 to 0 Store number

Returns:-

<i>flag,oor,n</i>	<i>flag</i> = 0 or 1	Validity Flag
	<i>oor</i> = 1	Out of range (always inrange)
	<i>n</i> = 0 to 999999999	Slip count

This result will be valid if the stored pattern was a PRBS or QRSS pattern and the stored framing was anything other than unframed.

Stored Bit Slips Result Query

This command requests the bit slips result. Opt.001 is required to perform this measurement and an error number will be generated if it is not fitted.

SRBS? store = -9 to 0 Store number

Returns:-

<i>flag,oor,n</i>	<i>flag</i> = 0 or 1	Validity Flag
	<i>oor</i> = 1	Out of range (always inrange)
	<i>n</i> = 0 to 999999999	Slip count

Stored Estimated Frame Slips Result Query

This command requests the stored estimated frame slips result from a specified store. Opt.001 is required to perform this measurement and an error number will be generated if it is not fitted.

SRFS? *store* = -9 to 0 Store number

Returns:-

<i>flag,oor,n</i>	<i>flag</i> = 0 or 1	Validity Flag
	<i>oor</i> = 1	Out of range (always inrange)
	<i>n</i> = 0 to 999999999	Slip count

Stored Framing Type Query

This command requests the stored framing type for a specified store.

SFRM? *store* = -9 to 0 Store number

Returns *frame type* = 1 to 4

Refer to the FRM? command for a detailed breakdown of the reply.

Stored Coding Type Query

This command requests the stored coding type for a specified store.

SCOD? *store* = -9 to 0 Store number

Returns *code type* = 1 to 2

Refer to the COD? command for a detailed breakdown of the reply.

Stored Pattern Type Query

This command requests the stored pattern type for a specified store.

`SPAT? store = -9 to 0` Store number

Returns *pattern type* = 1 to 12

Refer to the PAT? command for a detailed breakdown of the reply.

Stored Interface Type Query

This command requests the stored interface type for a specified store.

`SIFC? store = -9 to 0` Store number

Returns *interface type* = 1 to 3

Refer to the IFC? command for a detailed breakdown of the reply.

Stored Test Time Query

This command requests the stored test time for a specified store.

`STPD? store = -9 to 0` Store number

Returns *test time type* = 1 to 5

Refer to the TPD? command for a detailed breakdown of the reply.

Stored Elapsed Time Result Query

This command requests the elapsed time since the start of the current test from a specific store.

`SELP? store = -9 to 0` Store number

Returns *flag,dd,hh,mm,ss*

<i>flag</i> = 0 or 1	Validity
<i>dd</i> = 0 to 99	Flag Days
<i>hh</i> = 0 to 23	Hours
<i>mm</i> = 0 to 59	Minutes
<i>ss</i> = 0 to 59	Seconds

Stored Test Duration (user defined) Query

This command requests the stored user defined test duration from a specific store.

STDU? *store* = -9 to 0 Store number

Returns *duration,units*

Refer to the TDU? command for details of this reply.

Stored User Defined Pattern Query

This command requests the user defined pattern from a specified store.

SPAU? *store* = -9 to 0 Store number

Returns *length, "patt"*

Refer to the PAU? command for details of this reply.

Stored Application Query

This command requests the stored major application of the instrument.

SAPP? *store* = -9 to 0 Store number

Returns *application type 1 to 3*

Refer to the APP? command for details of this reply.

Stored Receiver Timeslot Selection Query

This command requests the stored timeslot mapping.

SRXT? store = -9 to 0 Store number

Returns *timeslot mode* 1 to 2

Refer to the RTX? command for details of this reply.

Stored Long User Word Selection Query

This command requests the stored long user word number.

SLUS? store = -9 to 0 Store number

Returns *long user word number* 1 to 4

Refer to the LUS? command for details of this reply.

Stored Special Pattern/Test Query

This command requests the special pattern/test from a specified store.

SSPT? store = -9 to 0 Store number

Returns *special pattern/test* 0 to 7

Refer to the SPT? command for details of this reply.

Stored Transmitter Multiple Timeslot Query

This command requests the stored transmit timeslots for fractional T1 measurements.

STTM? store = -9 to 0 Store number

Returns "*timeslots*" 24 characters, 0 or 1

Refer to the TTM? command for details of this reply.

Stored Receiver Multiple Timeslot Query

This command requests the stored transmit timeslots for fractional T1 measurements.

SRTM? *store* = -9 to 0 Store number

Returns "*timeslots*" 24 characters, 0 or 1

Refer to the RTM? command for details of this reply.

Stored User Defined Pattern (Fractional T1) Query

This command requests the stored user pattern.

SPAF? *store* = -9 to 0 Store number

Returns "*user pattern*"

Refer to the PAF? command for details of this reply.

Pulse Mask and Data Plot Query

This command requests the pulse plot information along with the various measurements which are carried out on the pulse. This command is used in conjunction with the PST/PST? and PSR commands.

Only valid when pulse mask option fitted.

RPD? Returns

0, cr, lf

or

n, cr, lf

trigger date, cr, lf

trigger time, cr, lf

mask, pol, rise, fall, width, osh, ush, lvl, pass/fail, cr, lf

Followed by
validity, lwr msk pnt, pulse pnt, upp msk pnt, cr, lf
for each point. (There will be n-3 of these lines).

where

trigger date = yyyy,mm,dd

trigger time = hh,mm,ss

mask = 1 to 4

pol = 0 or 1

rise = 0 to 999 ns

fall = 0 to 999 ns

width = 0 to 999 ns

osh = 0 to 100%

ush = 0 to 100%

lvl = -40 to +10 dBsx

pass/fail = 0 or 1

Validity indicates that the pulse points are valid. Some will not be valid if the pulse has been truncated. A value of 0 for <n> means that the trigger condition has not yet been satisfied.

The points themselves are in terms of the pixel coordinates as would be sent to a printer.

Pulse Sample Trigger Mask

This command is used to enable or disable the conditions for storing data and point information about a pulse shape and mask measurement.

PST *n* *n* = 0 to 63 Pulse sample trigger mask range

The mask can be set in three different ways.

1. The parameter can be a single 16 bit integer, corresponding to the addition of binary weighted bits wishing to be enabled. Eg. if we wished to trigger

on truncated pulses which failed to fit the mask, then the command would be:-

PST 20

2. The parameter can be a list of the binary weighted integers corresponding to all those trigger events to be enabled, separated by commas. For example if we wished to enable POS, FIT and NTR then the command would be:-

PST 1,8,32

3. The parameter can be a list of three letter mnemonics, defined in the status register section of this chapter, separated by commas. For example if we wished to enable POS, NFT and TRU then the command would be:-

PST POS,NFT,TRU

As well as the three methods of passing the parameter outlined above, any combination may be used, remembering that the result is always evaluated to a 16 bit integer. Care should be taken to ensure the resultant integer is in range and the desired sources are enabled (Although range checking is done, no checking of constituent parameters is performed to ensure that they are binary values). A special form of the command is PST ANY or PST 0 which has the effect of accepting any pulse as suitable.

The complement of this command is used to inspect the pulse sample trigger mask. The command responds with a 16 bit integer equivalent to the binary weighted values of those sources which are enabled (detailed under status registers).

The corresponding query returns the trigger mask, in integer form as described above:-

PST? returns *range* = 0 to 63

Pulse Sample Trigger Reset

This command is used to reset (or rearm) the pulse mask trigger. After this command has been sent, the first pulse to meet the trigger conditions specified by the pulse sample trigger register will have its points and data stored for subsequent reading by the RPD? command.

PSR

Pattern Loss Count Criterion

This command is used to specify whether errors should be counted or suppressed during periods of pattern loss. This information is stored in EEROM and will be retained under all circumstances. It is supplied so that you can customize the instrument to your own requirements.

As an EEROM can only be programmed a finite number of times, the use of this command should be limited.

PTLC <i>n</i>	<i>n</i> = 0 or NOCOUNT	Errors will not be counted during pattern loss
	1 or COUNT	Errors will be counted during pattern loss

The corresponding query returns the currently selected count criterion, in integer form as described above:-

PTLC? returns *count criterion* = 0 or 1

SELF TEST COMMANDS

Number Of Tests

This command yields the total number of self tests implemented in this instrument as used by the 'TST' command. ie If the reply is '3' then the commands 'TST 0 ... TST 3' are legal.

`NTST?` returns n $n = 15$ for this instrument

Number of Sub-tests in a Test

This command yields the total number of selftest subtests within a test, i.e. 'TST 3' is a selftest. Within this test are a number of hidden subtests which can be accessed by the command:

`NSUB? t` returns $n =$ Total number of tests within subtest t
 $m =$ Number of runnable tests in current option structure

Self-test

The self test command performs a selected self-test on the instrument. A subsequent response of "0" to the "ERR?" query command indicates that the test has passed, any other number indicates a failure (error codes are listed at the end of this chapter).

TST <i>n</i>	<i>n</i> =	0 or ALL	Do all the tests
		1 or TEST1	Test CPU ROM/RAM etc
		2 or TEST2	Test all words and prbs's
		3 or TEST3	Test the different types of framing
		4 or TEST4	Test AMI and B8ZS coding
		5 or TEST5	Test the different error types
		6 or TEST6	Test the different error ratios
		7 or TEST7	Test AIS and yellow alarm
		8 or TEST8	Test the interfaces
		9 or TEST9	Tests different input levels
		10 or TEST10	Tests recovered clock with 2-23 sequence
		11 or TEST11	Checks pulse mask spec
		12 or TEST12	Tests round trip delay
		13 or TEST13	Tests COFAs and uncontrolled slips
		14 or TEST14	Tests OOF and SEF counts
		15 or TEST15	Tests signaling bits

Default Conditions

The following settings are used for the instrument following loss of non-volatile memory (NVM). The "RST" command and "RCL 0" command reset the instrument (except for remote control settings) to these conditions.

System: (Unaffected by "RCL 0")	SRQ mask register	ERR
	Status register A (STA)	LCL*, RDY
	Ready register	LQE, STC, ASC, DRO
	Error register	0
	Alarm mask register	32767
	Key register	0
Transceiver Settings:		
	Application	FULL T1
	Frame	D4
	Code	B8ZS
	Pattern	QRSS
	Interface	DSX-MON
	Clk Source	INT
Transmitter Settings:		
	Error Type	LOGIC
	Error Rate	ERR FREE
	Transmit Timeslots	TIMESLOT 1 ONLY
	Prog. Error Rate	10E-3**
	Alarm Generation	OFF
Receiver Settings:		
	Receiver Timeslot Mode	AS TRANSMITTER
	Receiver Timeslots	TIMESLOT 1 ONLY
Results Control:		
	Test Period Type	CONTINUOUS
	Test Duration (User)	10 MINUTES
Printer:		
	Squelch	OFF
	Print On Demand	CURRENT SETTINGS
	Auto Triggered Print	OFF

Loopcodes in-band (DEFAULT):	Type	LINE (CSU)
	Framing	INSERTED
	User Prog. Loopup Length	8
	User Prog. Loopup Pattern	10101010
	User Prog. Loopdown Length	8
	User Prog. Loopdown Pattern	10101010
	Auto Response	OFF
	Tester Looped	DOWN
Loopcodes out-of-band:	Code	LINE
	Auto response	OFF
	Line looped	DOWN
	Payload looped	DOWN
VF access:	Channel	1
	Audio Monitor	OFF
	Channel mapping	D3/D4
Signaling bit test:		
Foreground:	Channel	01
	Signaling bits (non-ESF)	01
	Signaling bits (ESF)	0101
Background:	Signaling bits (non-ESF)	01
	Signaling bits (ESF)	0101
Tones pattern:		
	Send tone in	01
Timeslot map test:		
	Mode	SINGLE
	Timeslot	01
High resolution round trip delay:	Tx Timeslot	01
	Rx Timeslot	01
	Rx mode	AS TRANSMITTER

Other Functions:

Pulse Mask Type	ANSI T1.403
Stored Setting Number	0
Stored Panel Lock	ON
Real Time clock mode	RUN
Selftest Function	ALL
Storage	OFF

* This default only after power on

** Only available when Error Rate selection set to USER PRGM.

Status Registers

STATUS REGISTER A

This register is accessed by the “STA?” command and contains a 16 bit word describing the instrument’s status. Each bit is a latched record of an event (not an instantaneous reading). The cause of setting and method of clearing are described below:-

DB7	DB6	DB5	DB4	DB3	DB2	DB1	DB0
MSG	RQS	ERR	RDY	LCL	FPS	PWR	RQC

DB15	DB14	DB13	DB12	DB11	DB10	DB9	DB8
0	SMG	DAT	TIP	-	SCA	ALC	EOT

Bits marked (-) may be either 0 or 1.

- Bit 0 RQC : For compatibility with “common capabilities”. Not used in this instrument.
- Bit 1 PWR : For compatibility with “common capabilities”. The instrument is about to power down or the battery is in a low state of charge.
- Bit 2 FPS : Front panel service request. A front panel switch has been pressed. Cleared by “KEY?”, “RST” or “CLR”.
- Bit 3 LCL : Local operation. This is set when the power has just been cycled. Cleared by “STA?”, “STB?”, “CLR” or “RST”.
- Bit 4 RDY : This bit is a direct reflection of the DRO bit (bit 3) of the ready register. It is set when a command causes the instrument to output data, cleared when the instrument has finished outputting the data.
- Bit 5 ERR : Error. An error of some description has occurred (see “ERR?” command and Error Codes for further information). Cleared by “ERR?”, “CLR” or “RST”.

- Bit 6 RQS : Service requested. This is required for common capability reasons. It has no function in this instrument.
- Bit 7 MSG : For compatibility with "common capabilities". There is an ASCII string in the display area or the instrument has something to say. Not used in this instrument.
- Bit 8 *EOT : This bit is set when the instrument reaches the end of its testing period. It is set as the results become valid at EOT. Cleared by "STR", "RST" or "CLR", or by reading any result.
- Bit 9 *ALC : Alarm change. This is set when any of the alarms in the alarm status register change and their corresponding mask in the alarm mask register is enabled. Cleared by "ALM?", "RST" or "CLR".
- Bit 10 *SCA : Scan Trouble detected. Set when the scan has found an error in one of its tests. Cleared by "STR", "RST" or "CLR".
- Bit 12 *TIP : This bit is set during any testing period and cleared when the instrument is not testing. It is set at the start of any period by "STR" and cleared by "RST" or "CLR".
- Bit 13 *DAT : When set the instrument is in datacom mode, else it is in telecom mode.
- Bit 14 *SMG : When set the instrument is logging data to an smg store. Stored results or setting information can only be read when this is cleared.
- Bit 15 0 : Zero. This is included to be compatible with "common capabilities" and is used to ensure a positive number for "STA?" response in 16 bit computers.

* = Status bit not HP standard.

STATUS REGISTER B

This register is accessed by the "STB?" command and contains an 8 bit word describing the important instrument status information. Each bit is a latched record of an event (not an instantaneous reading). The causes of setting and method of clearing are described below:-

DB7	DB6	DB5	DB4	DB3	DB2	DB1	DB0
DAT	RQS	ERR	RDY	LCL	FPS	ALC	EOT

- Bit 0 *EOT : This bit is set when the instrument reaches the end of its testing period. It is set as the results become valid at EOT. Cleared by "STR", "RST" or "CLR", or by reading any result.
- Bit 1 ALC : Alarm change. This is set when any of the alarms in the alarm status register change and their corresponding mask in the alarm mask register is enabled. Cleared by "ALM?", "RST" or "CLR".
- Bit 2 FPS : Front panel service request. A front panel switch has been pressed. Cleared by "KEY?", "RST" or "CLR".
- Bit 3 LCL : Local operation. This is set when the power has just been cycled. Cleared by "STA?", "STB?" or "CLR".
- Bit 4 RDY : Ready. A direct reflection of the DRO bit (bit 3) of the ready register. It is set when a command causes the instrument to output data, cleared when the instrument has finished outputting the data. NOTE: There is a (small but) finite time between reading the last byte of a message and the RDY bit going low.
- Bit 5 ERR : Error. An error of some description has occurred (see "ERR?" command for further information). Cleared by "ERR?", "CLR" or "RST".
- Bit 6 RQS : Service requested. This bit is set if an SRQ is generated for any reason.
Cleared by "STB?", "RST" or "CLR".
- Bit 7 *DAT : Set when the instrument is in datacom mode, else it is in telecom mode.

READY REGISTER

This register is accessed using the RDY? command. The ready register is a byte with binary weighted bits assigned as follows:-

DB7	DB6	DB5	DB4	DB3	DB2	DB1	DB0
0	LQE	STC	ASC	DRO	AOC	OST	RAC

- Bit 0 RAC : Ready to accept new command. This bit is included for “common capabilities” and is not used in this instrument. This bit will always appear set except in dumb terminal mode where it will always appear clear.
- Bit 1 OST : Operation started, this bit is set when the instrument starts testing and reset when it has stopped. This is used to show when the testing has actually started. (cf. STR in Stat reg A).
- Bit 2 AOC : All operations complete. This bit is included for “common capabilities” and is not used in this instrument. This bit will always appear clear.
- Bit 3 DRO : Data ready for output. This bit is set while a command is outputting data on reply to a query command and is included for common capabilities but has no real use in this instrument. However, the RDY bit in status registers A and B directly follow this bit and a positive transition of the former will generate an SRQ if its mask is enabled. On reads of these registers this bit will always appear set.
- Bit 4 ASC : Auto-setup complete. This bit is cleared following a request for auto-setup, and set on completion of that setup.
- Bit 5 STC : Self-Test complete. This bit is cleared following a request for self test, and set on test complete.
- Bit 6 LQE : Logging queue empty. This bit indicates that the logging queue is empty. Included for common capabilities, but will always be set on this instrument.

ALARM REGISTER

This register is accessed by the ALM? command. A “1” in a bit position indicates that the specified condition is prevailing. If a given alarm condition changes and the corresponding bit in the Alarm Mask Register (see AMR/AMR?) is a “1”, then the Alarm Change (ALC) bit will be set in Status Registers A & B.

DB7	DB6	DB5	DB4	DB3	DB2	DB1	DB0
ERR	OSD	EX0	SLP	PTL	FML	AIS	SGL

DB15	DB14	DB13	DB12	DB11	DB10	DB9	DB8
0	-	UAV	EXW	LPD	LPU	PWL	YEL

Bits marked (-) may be either 0 or 1.

- Bit 0 SGL : Signal loss. Set when no signal is present.
- Bit 1 AIS : All 1s signal. Set when an all ones data pattern is received.
- Bit 2 FML : Frame loss. Set when frame sync is lost.
- Bit 3 PTL : Pattern loss. Set when pattern sync is lost.
- Bit 4 SLP : Slip detected. Set if a slip has occurred in the last 100mS.
- Bit 5 EX0 : Excess Zeros. Set if excess zeros have occurred in the last 100mS.
- Bit 6 OSD : Ones Density. Set if density < 12.5 % in the last 100mS.
- Bit 7 ERR : Errors. Set if an error has occurred in the last 100mS.
- Bit 8 YEL : Yellow Alarm. Set if a yellow alarm has occurred in the last 100mS.
- Bit 9 PWL : Power Loss. Set if a power loss has occurred during the last run period, or the currently running period.
- Bit 10 LPU : Loopup detected. Set if a loopup pattern is being detected.
- Bit 11 LPD : Loopdown detected. Set if a loopdown pattern is being detected.

- Bit 12 EXW : Excess Wander. Set if excess wander has occurred.
- Bit 13 UAV : Unavailability. This flag is set when the system under test appears to be unavailable during a testing period (Notice that this will be set if any of the three types of error (ie. logic, frame or crc) go unavailable. If option 003 is not fitted, then this bit will always be false.

PULSE SAMPLE MASK REGISTER

This register is accessed by the PST/PST? commands. Reading or writing a "1" in a bit position indicates that the specified condition is prevailing.

DB7	DB6	DB5	DB4	DB3	DB2	DB1	DB0
-	-	NTR	TRU	FIT	NFT	NEG	POS

DB15	DB14	DB13	DB12	DB11	DB10	DB9	DB8
0	-	-	-	-	-	-	-

Bits marked (-) may be either 0 or 1.

- Bit 0 POS : Positive Pulse: Pulse must be positive polarity to satisfy the trigger condition.
- Bit 1 NEG : Negative Pulse: Pulse must be negative polarity to satisfy the trigger condition.
- Bit 2 NFT : No Fit. The pulse must be outwith the mask to satisfy the trigger condition.
- Bit 3 FIT : Fit. The pulse must be fit within the mask to satisfy the trigger condition.
- Bit 4 TRU : Truncated. The pulse must be truncated to satisfy the trigger condition.
- Bit 5 NTR : Not Truncated. The pulse must be non truncated to satisfy the trigger condition.

Error Codes

The following tables list the error codes which are returned following an ERR? command.

Parse Time Errors (Error codes -100 to -200)

The errors listed here occur during the parsing of GPIB commands.

-100	Command error (Unknown command)
-101	Invalid character received
-110	
-111	Command header error
-120	Header delimiter error
-121	Numeric argument error
-122	Wrong data type (Numeric expected)
-123	Precision error; rounding occurred
-129	Numeric overflow
-130	Missing numeric argument
-131	Non numeric argument error
-132	Wrong data type (char expected)
-133	Wrong data type (string expected)
-134	Wrong data type (block type #A required)
-135	Data overflow : string or block too long
-139	Error in #H block
-141	Missing non numeric argument
-142	Command buffer overflow
-143	Comma is not a legal command separator
-144	Argument delimiter error
-150*	Comma is not a legal command separator
-151*	Invalid message unit delimiter
-160	CR found without following LF
-161	RS232 Parity Error
-162	RS232 Framing Error
-163	RS232 UART Overrun Error
	RS232 Internal Input Buffer Overrun Error

* = Instrument dependent error code.

Execution Time Errors (Error codes -200 to -349)

These errors are caused at execution time of remote control commands.

-200	No can do (generic execute error)
-201	Not executable in local mode
-202	Settings lost due to RTL or PON
-203	Trigger ignored
-211	Legal command, but settings conflict
-212	Argument out of range
-221	Busy doing something else
-222	Insufficient capability or configuration
-231	Input buffer full or overflow
-232	Output buffer full or overflow
-240*	Reserved
-241*	Command not implemented
-250*	Command illegal during testing
-251*	Command illegal when not testing
-252*	Cannot start with testing period of zero
-300*	Only permitted when the selection is error free
-301*	Recall settings only allowed
-302*	Only allowed in telecom mode
-303*	Only allowed in datacom mode
-304*	Not allowed when tx is generating an alarm
-305*	Not allowed when an HP37701A
-306*	The cct is already sweeping
-307*	The cct is not sweeping
-308*	Not allowed when sweep running
-309*	Not allowed because accy faulty
-310*	Only allowed when store is telecom
-311*	Only allowed when store is datacom
-312*	Cannot start when generating FOX pattern
-313*	Not allowed when async data rate is 19.2kb/s
-314*	Only allowed when out-of-band loopcode selected
-315*	Only allowed when in-band loopcode selected
-316*	Only allowed when ESF framing selected
-317*	Not allowed when tester looped
-318*	Only allowed when application in N x 64
-319*	Not allowed when special test selected

* = Instrument dependent error code.

Option or Capability Errors (Error codes -350 to -370)

The error codes in this section are issued if a legal command is received, but it cannot be executed due to insufficient capability or unsuitable option configuration. They are all diagnosed by the remote control parser or executor.

- 350 Instrument has no pulse mask measurement capability
- 351 Instrument has no wander measurement capability
- 352 Instrument has no G821 analysis capability
- 353 Instrument has no Fractional T1 capability

Error Codes for Stored Measurement Results and Graphics

- 410 Not allowed while SMG running
- 411 Requested SMG store out of range
- 412 Requested SMG store unused - no data
- 413 Requested SMG text result out of range
- 414 SMG option not fitted

Self-Test Errors (Error codes 1 to 1599)

Self-test halts when a self-test error occurs. The error codes are listed below.

1 to 99 CPU Self-Test Errors

10	ROM ID's different
11	ROM 1 Number Incorrect
12	ROM 2 Number Incorrect
13	ROM max number values do not agree
14	ROM dates do not agree
15	ROM 1 CRC test fails
16	ROM 2 CRC test fails
20	RAM test fails
51	Printer RS232 loopback test fails
60	RTC set incorrectly
61	RTC not ticking correctly
81	Keybd processor internal RAM fails
82	Keybd processor external RAM fails
83	Keybd processor ROM fails
90	Video RAM fails

100 to 299 Pattern Test Errors

211	DSX i/f; PRBS 15 failed to sync
213	DSX i/f; PRBS 15 had errors
214	odd t/s;QRSS failed to sync
216	odd t/s;QRSS had errors
217	odd t/s;QRSS failed to sync
219	odd t/s;QRSS had errors
221	DSX i/f; PRBS 20 failed to sync
223	DSX i/f; PRBS 20 had errors
224	even t/s;QRSS failed to sync
226	even t/s;QRSS had errors
227	odd t/s;PRBS 15 failed to sync
229	odd t/s;PRBS 15 had errors
231	DSX i/f; QRSS failed to sync
233	DSX i/f; QRSS had errors
234	all t/s;QRSS failed to sync
236	all t/s;QRSS had errors
237	odd t/s;PRBS 20 failed to sync
241	DSX i/f; PRBS 23 failed to sync
243	DSX i/f; PRBS 23 had errors
244	mixed t/s;QRSS failed to sync
246	mixed t/s;QRSS had errors
247	odd t/s;PRBS 23 failed to sync
249	odd t/s;PRBS 23 had errors

251	DSX i/f; 1 in 2 failed to sync
253	DSX i/f; 1 in 2 had errors
261	DSX i/f; 1 in 8 failed to sync
263	DSX i/f; 1 in 8 had errors
271	DSX i/f; 3 in 24 failed to sync
273	DSX i/f; 3 in 24 had errors
281	DSX i/f; 55 OCTET failed to sync
283	DSX i/f; 55 OCTET had errors
291	DSX i/f; All Ones failed to sync
293	DSX i/f; All Ones had errors
300 to 399	Framing Test Errors
311	D4 Framing failed to sync
313	D4 Framing had errors
321	ESF Framing failed to sync
323	ESF Framing had errors
331	SLC96 Framing failed to sync
333	SLC96 Framing had errors
400 to 499	Coding Test Errors
411	AMI coding failed to sync
413	AMI coding had errors
421	B8ZS coding failed to sync
423	B8ZS coding had errors
500 to 599	Error Type Test Errors
511	Logic error subtest failed to gain sync
512	Logic error result too low
513	Logic error result too high
521	BPV error subtest failed to gain sync
522	BPV error result too low
523	BPV error result too high
531	Frame error subtest failed to gain sync
532	Frame error result too low
533	Frame error result too high
541	CRC error subtest failed to gain sync
542	CRC error result too low
543	CRC error result too high

600 to 699 Error Ratio Test Errors

611 1E-3 error subtest failed to gain sync
612 1E-3 error result too low
613 1E-3 error result too high
621 1E-4 error subtest failed to gain sync
622 1E-4 error result too low
623 1E-4 error result too high
631 1E-5 error subtest failed to gain sync
632 1E-5 error result too low
633 1E-5 error result too high
641 1E-6 error subtest failed to gain sync
642 1E-6 error result too low
643 1E-6 error result too high
651 1E-7 error subtest failed to gain sync
652 1E-7 error result too low
653 1E-7 error result too high
661 Single error subtest failed to gain sync
662 Single error result too low
663 Single error result too high

700 to 799 Alarm Test Errors

710 Framing off; no alarm generated;
but alarm being detected
720 Framing off; could not detect AIS
730 Framing off; could not deselect AIS
740 Framing D4; could not detect Yellow Alarm
750 Framing D4; could not deselect Yellow Alarm
760 Framing ESF; could not detect Yellow Alarm
770 Framing ESF; could not deselect Yellow Alarm

800 to 899 Interface Test Errors

811 TERM i/f; PRBS 15 failed to sync
813 TERM i/f; PRBS 15 had errors
821 TERM i/f; PRBS 20 failed to sync
823 TERM i/f; PRBS 20 had errors
831 TERM i/f; QRSS failed to sync
833 TERM i/f; QRSS had errors
841 TERM i/f; PRBS 23 failed to sync
843 TERM i/f; PRBS 23 had errors
851 TERM i/f; 1 in 2 failed to sync
853 TERM i/f; 1 in 2 had errors
861 TERM i/f; 1 in 8 failed to sync
863 TERM i/f; 1 in 8 had errors
871 TERM i/f; 3 in 24 failed to sync
873 TERM i/f; 3 in 24 had errors
881 TERM i/f; 55 OCTET failed to sync
883 TERM i/f; 55 OCTET had errors
891 TERM i/f; All Ones failed to sync
893 TERM i/f; All Ones had errors

10-102 Remote Control

900 to 999 Level Test Errors

911	DSX i/f subtest failed to gain sync
912	DSX i/f result too low
913	DSX i/f result too high
921	0dB TERM i/f subtest failed to gain sync
922	0dB TERM i/f result too low
923	0dB TERM i/f result too high
931	7.5dB TERM i/f subtest failed to gain sync
932	7.5dB TERM i/f result too low
933	7.5dB TERM i/f result too high
941	15dB TERM i/f subtest failed to gain sync
942	15dB TERM i/f result too low
943	15dB TERM i/f result too high

1000 to 1099 Clock Test Errors

1011	Clock recovery test failed to sync
1012	Clock recovery count too low
1013	Clock recovery count too high

1100 to 1199 Pulse Mask Test Errors

1111	Pulse mask failed
------	-------------------

1200 to 1299 Round Trip Delay Test Errors

1211	Could not gain sync
1212	Result not valid
1213	Result not correct
1221	Could not gain sync
1222	Result not valid
1223	Result not correct

1300 to 1399 Slip Test Errors

1311	Could not gain sync
1312	Could not gain sync
1313	Incorrect counts
1314	Results not valid
1321	Could not gain sync
1322	Could not gain sync
1323	Incorrect counts

1400 to 1499 OOF & SEF Test Errors

BASE COUNTS

1410,1416,1422,1428,1434

1440,1446,1452,1458,1464

1470,1476

BASE COUNT + 1

BASE COUNT + 2

BASE COUNT + 3

BASE COUNT + 4

BASE COUNT + 5

Could not gain sync

Incorrect OOF count

Incorrect SEF count

Incorrect frame error count

Incorrect validity bits

1500 to 1599 Signaling Bit Test Errors

BASE COUNTS

1510,1515,1520,1525,1530

1535,1540,1545,1550,1555

1560,1565,1570

BASE COUNT + 2

BASE COUNT + 3

BASE COUNT + 4

Incorrect decoded signaling bits

Incorrect decoded signaling bits

Incorrect validity bits

Restart Causing Commands

The following commands cause the instrument to discard current results and start a new test.

Mnemonic	Notes
FRM	
COD	
PAT	
PAU	If application is full T1 or Opt 004 not fitted
TDU	
PAF	If word modified is relevant to current application
TPD	
SAV	
RCL	
TIM	
DAT	
IFC	
LUW	If longer user word is active
LUL	If longer user word is active
LUS	If longer user word is active
LUY	If longer user word is active
LSL	If longer user word is active
LHB	If longer user word is active
SPT	
STO	If tones are selected
TTM	If the application is n x 56 or n x 64
RTM	If the application is n x 56 or n x 64
STR	
SRG	
RST	

Command History

Command	Page No.	Change Description	Firmware
RLE?	10-41	Add 2 or SYES (synchronous error seconds count) to <i>result</i> parameter	3049 and below
SRLE?	10-57	Add 2 or SYES (synchronous error seconds count) to <i>result</i> parameter	3049 and below
APP	10-22	Delete	3113 and below
BIT?	10-63	Delete	3113 and below
LHB	10-26	Delete	3113 and below
LSL	10-26	Delete	3113 and below
LUL	10-25	Delete	3113 and below
LUS	10-25	Delete	3113 and below
L UW	10-25	Delete	3113 and below
LUY	10-26	Delete	3113 and below
OPT?	10-20	Delete 3 (fractional T1)	3113 and below
PAF	10-27	Delete	3113 and below
PAT	10-24	Delete 12 or SPECIAL	3113 and below
PTLC	10-84	Delete	3113 and below
RPD?	10-81	Delete	3113 and below
PST	10-82	Delete	3113 and below
RDT?	10-64	Delete	3113 and below
RTF	10-29	Delete	3113 and below
RTM	10-23	Delete	3113 and below
RTR	10-29	Delete	3113 and below
RTT	10-29	Delete	3113 and below
RXT	10-23	Delete	3113 and below
SAPP?	10-79	Delete	3113 and below
SBD?	10-38	Delete	3113 and below
SBS?	10-39	Delete	3113 and below
SCG?	10-57	Delete	3113 and below
SIG?	10-56	Delete	3113 and below
SPAF?	10-81	Delete	3113 and below
SLUS?	10-80	Delete	3113 and below
SRG	10-68	Delete	3113 and below
SRTM?	10-81	Delete	3113 and below
SRXT?	10-80	Delete	3113 and below

Command History (continued)

Command	Page No.	Change Description	Firmware
SPT	10-24	Delete	3113 and below
SSB	10-28	Delete	3113 and below
SSI	10-28	Delete	3113 and below
SSO	10-28	Delete	3113 and below
SSPT?	10-80	Delete	3113 and below
STO	10-38	Delete	3113 and below
SSTM?	10-80	Delete	3113 and below
TBW?	10-63	Delete	3113 and below
TDU	10-31	Delete	3113 and below
TMD	10-39	Delete	3113 and below
TMS	10-39	Delete	3113 and below
TSS?	10-63	Delete	3113 and below
TTM	10-23	Delete	3113 and below

Index

5

56kBit/s Fractional T1 testing, 3-11

6

64kBit/s Fractional T1 testing, 3-11

A

Accessories Available, 7-3
Accessories Supplied, 7-2
ACCESSORY Port, 8-7
Alarm history example, 1-8
Alarm indication example, 1-7
Alarm register, 10-94
Alarms display, current conditions, 4-2
Alarms display, durations, 4-3
Alarms display, history, 4-3
Alarm seconds display, 4-3
Alarm seconds example, 1-12
Alarms only printing, 6-2
Alarm transmission, 3-16
All (error) results display selection, 4-7
All results example, 1-9
Automatic setting of frame code and pattern, 2-2
Auto restart, 2-2
Auxiliary functions, full list, 3-40

B

Basic results display selection, 4-7
Battery - Option 002, 8-4
Break, response to, 10-15
Bridge connection, 3-31

C

Cable, dual BNC to WECO, 9-3
Calibration cycle, 9-1
Changing the Batteries, 8-5
Channel access specifications, 7-15
Channel selection, 3-32
Character Format - Printer/Remote Control, 8-8
Charging Battery Fuses, 8-6
Charging the Batteries (Option 002), 8-4
Clock slips display selection, 4-15
Clock slips measurement specifications, 7-21
Clock starting, 2-8
Command execution delays, 10-11
Commands
 Alarm change query, ALC?, 10-45
 Alarm generation type, ALG, 10-34
 Alarm mask, AMR, 10-46
 ALC?, Alarm change query, 10-45
 ALG, Alarm generation type, 10-34
 All ones AIS alarm seconds result query, RAO?, 10-60
 ALM?, ALM query, 10-45
 ALM query, ALM?, 10-45
 AMR, Alarm mask, 10-46
 APP, Application type, 10-22
 Application type, APP, 10-22
 AUT, Autoconfigure, 10-40
 Autoconfigure, AUT, 10-40

BEEP, Beep command, 10-40
 Beep command, BEEP, 10-40
 Bit slips result query, RBS?, 10-61
 BIT?, Timeslot Monitor Query Command, 10-63
 BPV Error result query, RBP?, 10-52
 Channel Monitor All Signalling Bits Query Command, SIG?, 10-56
 Channel Monitor single signaling bits Query Command, SCG?, 10-57
 CHM, VF Channel mapping, 10-30
 Clear command, CLR, 10-15
 CLR, Clear command, 10-15
 COD, Coding type, 10-27
 Coding type, COD, 10-27
 CON #H, Instrument configuration command, 10-21
 Controlled slips result query, RCS?, 10-61
 CRC Analysis result query, RCA?, 10-54
 CRC Error result query, RCR?, 10-54
 CSA, CSU Auto mode, 10-32
 CSM, CSU Manual mode, 10-33
 CSU Auto mode, CSA, 10-32
 CSU Manual mode, CSM, 10-33
 Datacom Mode/T1, MODE, 10-42
 DAT, Date set-up, 10-43
 Date set-up, DAT, 10-43
 DIS, Display, 10-44
 Display, DIS, 10-44
 EIR, Error insert rate, 10-48
 EIT, Error insert type, 10-48
 EIU, User defined error insert ratio, 10-48
 Elapsed time result query, ELP?, 10-63
 ELP?, Elapsed time result query, 10-63
 ERR?, Error code query command, 10-19
 Error code query command, ERR?, 10-19
 Error insert rate, EIR, 10-48
 Error insert type, EIT, 10-48
 Estimated frame slips result query, RFS?, 10-61
 Excess zeros alarm seconds result query, RXZ?, 10-59
 Frame analysis result query, RFA?, 10-53
 Frame error result query, RFE?, 10-52
 Frame loss alarm seconds result query, RFL?, 10-60
 Framing type command, FRM, 10-21
 FRM, Framing type command, 10-21
 High resolution round trip delay transmit timeslot selection, RTT, 10-29
 High Res Round Trip Delay Rx From Select, RTF, 10-29
 High Res Round Trip Delay Rx Timeslot Select, RTR, 10-29
 HIS?, History query, 10-46
 History query, HIS?, 10-46
 ID, Instrument identification command, 10-18
 ID?, Instrument identification query command, 10-18
 IFC, Interface type, 10-37
 Instrument configuration command, CON #H, 10-21
 Instrument identification command, ID, 10-18
 Instrument identification query command, ID?, 10-18
 Interface type, IFC, 10-37
 KEY, Key query command, 10-15
 Key query command, KEY?, 10-15
 LBO, Line build out, 10-38
 LCL, Local command, 10-14
 LDA, Loopdown, 10-36

LHB, Long user word left hand bit, 10-26
 Line build out, LBO, 10-38
 Local command, LCL, 10-14
 Logic analysis result query, RLA?, 10-51
 Logic error result query, RLE?, 10-50
 Long user word left hand bit, LHB, 10-26
 Long user word length, LUL, 10-25
 Long user word, LUW, 10-25
 Long user word select, LUS, 10-25
 Long user word sync length, LSL, 10-26
 Long user word sync mode, LUY, 10-26
 Loopback band, LPB, 10-32
 Loopback code framing, LPF, 10-36
 Loopback type, LPC, 10-34
 Loopdown, LDA, 10-36
 Loopup (In-Band) status query command, LST?, 10-36
 Loopup, LUA, 10-35
 LPB, Loopback band, 10-32
 LPC, Loopback type, 10-34
 LPD, User defined loopdown, 10-35
 LPF, Loopback code framing, 10-36
 LPU, User defined loopup code, 10-35
 LSL, Long user word sync length, 10-26
 LST?, Loopup (In-Band) status query command, 10-36
 LUA, Loopup, 10-35
 LUL, Long user word length, 10-25
 LUS, Long user word select, 10-25
 LUW, Long user word, 10-25
 LUY, Long user word sync mode, 10-26
 MODE, T1/Datacom Mode, 10-42
 NAM?, Panel descriptor query, 10-41
 NTST?, Number of tests, 10-85
 Number of tests, NTST?, 10-85
 Options query command, OPT?, 10-20
 OPT?, Options query command, 10-20
 PAF, User defined pattern (fractional T1), 10-27
 Panel descriptor query, NAM?, 10-41
 PAT, Pattern type, 10-24
 Pattern loss count criterion, PTLC, 10-84
 Pattern loss seconds result query, RPL?, 10-59
 Pattern type, PAT, 10-24
 PAU, User defined pattern, 10-27
 PMS, Pulse mask selection, 10-22
 Power fail alarm seconds result query, RPF?, 10-59
 PRA, Printer auto trigger, 10-37
 PRD, Printer demand, 10-37
 Printer auto trigger, PRA, 10-37
 Printer demand, PRD, 10-37
 printer interface, RS232C, PTR, 10-43
 Printer squelch, PRS, 10-36
 PRS, Printer squelch, 10-36
 PSR, Pulse sample trigger reset, 10-83
 PST, Pulse sample trigger mask, 10-82
 PTC?, Pulse truncated command, 10-22
 PTLC, Pattern loss count criterion, 10-84
 PTR, RS232C printer interface, 10-43
 Pulse mask and data plot query, RPD?, 10-81
 Pulse mask plot query, RPP?, 10-62
 Pulse mask result query, RPM?, 10-62
 Pulse mask selection, PMS, 10-22
 Pulse sample trigger mask, PST, 10-82
 Pulse sample trigger reset, PSR, 10-83

Pulse truncated command, PTC?,
 10-22
 RAO?, All ones AIS alarm seconds
 result query, 10-60
 RBP?, BPV Error result query, 10-52
 RBS?, Bit slips result query, 10-61
 RCA?, CRC Analysis result query,
 10-54
 RCL, Recall panel command, 10-41
 RCR?, CRC Error result query, 10-54
 RCS?, Controlled slips result query,
 10-61
 RDT?, Round Trip Delay in Timeslot
 Query Command, 10-64
 RDY?, Ready code query command,
 10-19
 Ready code query command, RDY?,
 10-19
 Recall panel command, RCL, 10-41
 Receiver level result query, RRL?,
 10-55
 Receiver multiple timeslot selection,
 RTM, 10-23
 Receiver timeslot selection, RXT,
 10-23
 Remote command, RMT, 10-14
 Request service mask command, RQS,
 10-16
 Reset command, RST, 10-14
 Revision date query command, REV?,
 10-18
 REV?, Revision date query command,
 10-18
 RFA?, Frame analysis result query,
 10-53
 RFE?, Frame error result query, 10-52
 RFL?, Frame loss alarm seconds result
 query, 10-60
 RFO?, Signal frequency offset result
 query, 10-58
 RFS?, Estimated frame slips result
 query, 10-61
 RLA?, Logic analysis result query,
 10-51
 RLE?, Logic error result query, 10-50
 RMT, Remote command, 10-14
 Round Trip Delay in Timeslot Query
 Command, RDT?, 10-64
 RPD?, Pulse mask and data plot
 query, 10-81
 RPF?, Power fail alarm seconds result
 query, 10-59
 RPL?, Pattern loss seconds result
 query, 10-59
 RPM?, Pulse mask result query,
 10-62
 RPP?, Pulse mask plot query, 10-62
 RQS, Request service mask command,
 10-16
 RRL?, Receiver level result query,
 10-55
 RRT?, Signal round trip delay query,
 10-58
 RS232C printer interface, PTR, 10-43
 RSF?, Signal frequency result query,
 10-58
 RSG?, Signaling bits result query,
 10-56
 RSI?, Simplex current result query,
 10-57
 RSL?, Signal loss alarm seconds result
 query, 10-60
 RST, Reset command, 10-14
 RTF, High Res Round Trip Delay Rx
 From Select, 10-29
 RTM, Receiver multiple timeslot
 selection, 10-23
 RTR, High Res Round Trip Delay Rx
 Timeslot Select, 10-29
 RTT, High resolution round trip delay
 transmit timeslot selection, 10-29

RUS?, Uncontrolled slips result query, 10-60
 RWN?, Wander results query, 10-55
 RXT, Receiver timeslot selection, 10-23
 RXZ?, Excess zeros alarm seconds result query, 10-59
 RYA?, Yellow alarm seconds result query, 10-59
 SAPP?, Stored application query, 10-79
 Save panel command, SAV, 10-41
 SAV, Save panel command, 10-41
 SBD, Signaling bit display type select, 10-38
 SBS, Signaling bit display channel select, 10-39
 SCG?, Channel Monitor single signaling bits Query Command, 10-57
 SCOD?, Stored coding type query, 10-77
 SEI, Single error insert, 10-49
 Self-test, TST, 10-86
 SELP?, Stored elapsed time result query, 10-78
 Send signaling bits (background), SSO, 10-28
 Send signaling bits in channel, SSI, 10-28
 Send signaling bits, SSB, 10-28
 Send tone in channel, STO, 10-30
 Serial number query command, SER?, 10-18
 SER?, Serial number query command, 10-18
 SFRM?, Stored framing type query, 10-77
 SIFC?, Stored interface type query, 10-78
 SIG?, Channel Monitor All Signalling Bits Query Command, 10-56
 Signal frequency offset result query, RFO?, 10-58
 Signal frequency result query, RSF?, 10-58
 Signaling bit display channel select, SBS, 10-39
 Signaling bit display type select, SBD, 10-38
 Signaling bits result query, RSG?, 10-56
 Signal loss alarm seconds result query, RSL?, 10-60
 Signal round trip delay query, RRT?, 10-58
 Simplex current result query, RSI?, 10-57
 Single error insert, SEI, 10-49
 SLK, Stored panel lock, 10-40
 SLUS?, Stored long user word selection query, 10-80
 SMC?, Store use information, 10-65
 SMD?, Store data, 10-66
 SMS?, Store size and usage, 10-65
 SMZ?, Store data in compressed form, 10-67
 SPAF?, Stored user defined pattern (fractional T1) query, 10-81
 SPAT?, Stored pattern type query, 10-78
 SPAU?, Stored user defined pattern query, 10-79
 Special pattern, SPT, 10-24
 SPT, Special pattern / test type, 10-24
 SRAO?, Stored all ones AIS alarm seconds result query, 10-75
 SRBP?, Stored BPV error result query, 10-69

SRBS?, Stored bit slips result query, 10-76
 SRCA?, Stored CRC analysis result query, 10-72
 SRCR?, Stored CRC error result query, 10-71
 SRCS?, Stored controlled slips result query, 10-76
 SRFA?, Stored frame analysis result query, 10-71
 SRFE?, Stored frame error result query, 10-70
 SRFL?, Stored frame loss alarm seconds result query, 10-74
 SRFS?, Stored estimated frame slips result query, 10-77
 SRG, Storage lock, 10-68
 SRLA?, Stored logic analysis result query, 10-69
 SRLE?, Stored logic error result query, 10-68
 SRPF?, Stored power fail alarm seconds result query, 10-73
 SRPL?, Stored pattern loss seconds result query, 10-74
 SRSL?, Stored signal loss alarm seconds result query, 10-75
 SRTM?, Stored receiver multiple timeslot query, 10-81
 SRUS?, Stored uncontrolled slips result query, 10-76
 SRWN?, Stored wander results query, 10-72
 SRXT?, Stored receiver timeslot selection query, 10-80
 SRXZ?, Stored excess zeros alarm seconds result query, 10-74
 SRYA?, Stored yellow alarm seconds result query, 10-73
 SSB, Send signaling bits, 10-28
 SSI, Send signaling bits in channel, 10-28
 SSO, Send signaling bits (background), 10-28
 SSPT?, Stored special pattern/test query, 10-80
 Start measurement, STR, 10-41
 STA?, Status/events query command, 10-19
 Status/events query command, STA?, 10-19
 Status query command, STB?, 10-19
 STB?, Status query command, 10-19
 STDU?, Stored test duration (user defined) query, 10-79
 Stop measurement command, STP, 10-42
 Storage lock, SRG, 10-68
 Stored all ones AIS alarm seconds result query, SRAO?, 10-75
 Stored application query, SAPP?, 10-79
 Store data in compressed form, SMZ?, 10-67
 Store data, SMD?, 10-66
 Stored bit slips result query, SRBS?, 10-76
 Stored BPV error result query, SRBP?, 10-69
 Stored coding type query, SCOD?, 10-77
 Stored controlled slips result query, SRCS?, 10-76
 Stored CRC analysis result query, SRCA?, 10-72
 Stored CRC error result query, SRCR?, 10-71
 Stored elapsed time result query, SELP?, 10-78
 Stored estimated frame slips result query, SRFS?, 10-77

Stored excess zeros alarm seconds result query, SRXZ?, 10-74
 Stored frame analysis result query, SRFA?, 10-71
 Stored frame error result query, SRFE?, 10-70
 Stored frame loss alarm seconds result query, SRFL?, 10-74
 Stored framing type query, SFRM?, 10-77
 Stored interface type query, SIFC?, 10-78
 Stored logic analysis result query, SRLA?, 10-69
 Stored logic error result query, SRLE?, 10-68
 Stored long user word selection query, SLUS?, 10-80
 Stored panel lock, SLK, 10-40
 Stored pattern loss seconds result query, SRPL?, 10-74
 Stored pattern type query, SPAT?, 10-78
 Stored power fail alarm seconds result query, SRPF?, 10-73
 Stored receiver multiple timeslot query, SRTM?, 10-81
 Stored receiver timeslot selection query, SRXT?, 10-80
 Stored signal loss alarm seconds result query, SRSL?, 10-75
 Stored special pattern/test query, SSPT?, 10-80
 Stored test duration (user defined) query, STDU?, 10-79
 Stored test time query, STPD?, 10-78
 Stored transmitter multiple timeslot query, STTM?, 10-80
 Stored uncontrolled slips result query, SRUS?, 10-76
 Stored user defined pattern (fractional T1) query, SPAF?, 10-81
 Stored user defined pattern query, SPAU?, 10-79
 Stored wander results query, SRWN?, 10-72
 Stored yellow alarm seconds result query, SRYA?, 10-73
 Store size and usage, SMS?, 10-65
 Store use information, SMC?, 10-65
 STO, Send tone in channel, 10-30
 STPD?, Stored test time query, 10-78
 STP, Stop measurement command, 10-42
 STR, Start measurement, 10-41
 STTM?, Stored transmitter multiple timeslot query, 10-80
 T1/Datacom Mode, MODE, 10-42
 TBW?, TX Timeslot bandwidth query, 10-63
 TDU, Test duration, 10-31
 Test duration, TDU, 10-31
 Test period, TPD, 10-31
 Test type, SPT, 10-24
 Time set-up, TIM, 10-44
 Timeslot map display timeslot select Command, TMS, 10-39
 Timeslot Map display type select, TMD, 10-39
 Timeslot Monitor Query Command, BIT?, 10-63
 Timeslot Swap Result Query Command, TSS?, 10-63
 TIM, Time set-up, 10-44
 TMD, Timeslot Map display type select, 10-39
 TMS, Timeslot map display timeslot select Command, 10-39
 TPD, Test period, 10-31
 Transmitter multiple timeslot selection, TTM, 10-23

Transmit timing, TRT, 10-38
TRT, Transmit timing, 10-38
TSS?, Timeslot Swap Result Query
 Command, 10-63
TST, Self-test, 10-86
TTM, Transmitter multiple timeslot
 selection, 10-23
TX Timeslot bandwidth query, TBW?,
 10-63
Uncontrolled slips result query, RUS?,
 10-60
User defined error insert ratio, EIU,
 10-48
User defined loopdown, LPD, 10-35
User defined loopup code, LPU, 10-35
User defined pattern (fractional T1),
 PAF, 10-27
User defined pattern, PAU, 10-27
VFA, VF Channel audio select, 10-30
VF Channel audio select, VFA, 10-30
VF Channel mapping, CHM, 10-30
VF Channel select, VFC, 10-30
VFC, VF Channel select, 10-30
VF Timeslot query, VFT?, 10-31
VFT?, VF Timeslot query, 10-31
Volume command, VOL, 10-40
VOL, Volume command, 10-40
Wander lock query, WLK?, 10-50
Wander results query, RWN?, 10-55
WLK?, Wander lock query, 10-50
Yellow alarm seconds result query,
 RYA?, 10-59
Commands, remote control, 10-14
Commands which cause restart, 10-105
Computer, operation from, 10-5
Connection to T1 line, 3-4, 3-31
CSU emulation specifications, 7-10
CSU, using tester as, 3-5
Current measurement, 3-19
current settings printing, 6-16
Cursor movement, 1-4

D

Datacom Module Connection -
 ACCESSORY Port, 8-7
Datacom / T1 selection, 2-1, 8-7
Datacom /T1 selection, 1-2
Data logging specifications, 7-17
Date setting, 2-6
Default conditions, 10-87
Default settings, 9-5
Device clear command, 10-15
DSX-MON connection, 3-31

E

End-to-end tests, 3-24
Error add example, 1-10
Error Codes, 10-97
Error insertion, 3-12
Error monitoring, 3-35
Error monitoring at customer premises,
 3-23
Error results display selection, 4-6
Errors display, choices, 4-4
Errors display, selection, 4-5
ERR? responses, 10-97
Event results printing, 6-4

F

Fixed set-up recall, 1-3
Fractional T1 testing, 3-11
Frequency measurement, 3-19
Frequency Measurement, 3-33
Full results printing, 6-10
Fuses, 8-2

G

G821 analysis display, 4-8
General specifications, 7-20
Graph display, leaving, 4-11
Graph display of results, 4-8
Graph display resolution selection, 4-11

Graph display selection, 4-9
Graph display time window selection,
4-10
Graphic presentation specifications,
7-22
Graph result printing, 6-6

H

High resolution round trip delay, 3-22
History of alarms, example, 1-8

I

IBR testing, 3-11
Identification of line, 3-32
Initial Inspection, 8-1
In-service testing, 3-30
Intermediate Bit Rate (IBR) testing,
3-11

L

Level measurement, 3-19, 3-33
Line Fuses, 8-2
Line termination, 3-4
Local loop tests, 3-23
Long user word, content selection, 2-5
Loopcode of tester, setting, 3-7, 3-9
Loopcode transmission, 3-25, 3-27
Looping at the customer premises, 3-25,
3-27
Looping down tester, 3-8, 3-10
Looping tester manually, 3-5

M

Mating Connectors, 8-6
Measurement display, return to, 1-5
Measurements, full list, 3-38
Measurements specification, 7-13
Messages only printing, 6-2
Modem connection, 10-3
Monitor point connection, 3-31

N

Naming stored set-ups, 2-11
Network interface, using tester as, 3-5
N × 56kBit/s Testing, 3-11
N × 64kBit/s Testing, 3-11

O

Operational verification, 9-4
Operational verification test record,
9-50
Option 002 - Battery, 8-4
Options Available, 7-2
Options fitted display, 7-2
Options specifications, 7-21
Out of service testing, 3-3

P

Pattern slips display selection, 4-15
Patterns, test, 3-39
Performance test record, 9-52
Performance tests, 9-18
Power Cable, 8-3
Power Requirements, 8-2
Preparation for Use, 8-2
Print alarms and error count only, 6-4
Print at end of test, 6-10
Print at timed intervals, 6-10
Printer and remote control port
specifications, 7-18
Printer choices, 5-1
Printer Output - Character Format, 8-8
Printer output selection, 5-2
Printer Port, 8-7
Print full results, 6-10
Print Graphs of results, 6-6
Print major alarms, 6-2
Print on demand, 6-11
Print out choices, 6-1
Print pulse shape, 6-15
Print signal results, 6-9
Print stored results, 6-12

Print suppression, 6-3, 6-5
Print tester settings, 6-16
Programming tips, 10-11
Pulse sample mask register , 10-96
Pulse shape display, 4-17
Pulse shape display, leaving, 4-17
Pulse shape measurement, 3-19, 3-33
Pulse shape measurement options, 7-21
Pulse shape printing, 6-15

R

Rack mounting, 8-10
Ready register, 10-93
Recall fixed set-up, 1-3
Recall stored set-up, 2-2
Receiver specifications, 7-7
Recommended test equipment, 9-2
Remote Control - Character Format,
8-8
Remote control commands, 10-14
Remote control common capability
messages, 10-14
Remote control configuration commands,
10-21
Remote control, direct connection, 10-3
Remote control error insert commands,
10-48
Remote control miscellaneous commands,
10-40
Remote Control Port, 8-7
Remote control, preparation, 10-2
Remote control result query commands,
10-50
Remote control self test commands,
10-85
Remote control status registers, 10-90
Remote control stored result query
commands, 10-65
Remote operation command example,
10-6

Remote operation, general information,
10-6
Restart causing commands, 10-105
Results snapshot, 6-11
Results specifications, 7-16
Results storage set-up, 2-4
Round trip delay, high resolution, 3-22
Round trip delay measurement, 3-19
Round trip loopback, 3-24
RS-232 Port (on side panel), 8-7

S

Safety Considerations, 7-1
Signaling bit monitor, 3-17
Signaling bit selection, 3-17
Signal result printing, 6-9
Signal results display, 4-16
Signal results example, 1-11
Simplex current measurement, 3-19
Slips display, 4-15
Specification, 7-3
Squelch, 6-3, 6-5
Start of test, remote indication, 10-11
Status register A, 10-90
Status register B, 10-92
Status register reading, 10-11
Status registers, 10-90
Status registers reading rate, 10-11
Stopped test, remote indication, 10-11
Storage resolution - selection, 2-4
Stored result printing, 6-12
Stored results display choices, 4-12
Stored results display, leaving, 4-14
Stored results display selection, 4-12
Stored results specification, 7-22
Stored set-up naming, 2-11
Stored set-up recall, 2-2
Store results set-up, 2-4
Storing test set-ups, 2-9

T

T1 / Datacom selection, 1-2, 2-1, 8-7
T1 line connection, 3-4, 3-31
Telephone lines, connecting to via
modems, 10-3
Terminal, control from, 10-7
Terminal, setting up for operation from,
10-4
Terminating the line in 100 ohms, 3-4
Test patterns, 3-39
Test record, operational verification,
9-50
Test record, performance tests, 9-52
Test setup storing, 2-9
Timed interval printing, 6-10
Time setting, 2-6
Timeslot content monitor, 3-36
Timeslot map display, 3-36

Timing selection, transmit, 3-5
Transmitter specifications, 7-5
Trouble scan display selection, 4-5
Trouble scan example, 1-13

U

Unprotected point connection, 3-31

V

VF Access selection, 3-32

W

Wander display, 4-15
Wander display selection, 4-15
Wideband T1 testing, 3-11

Z

Zoom in /zoom out, 4-11



SALES OFFICES

Arranged alphabetically by country

1

Please send directory corrections to:
 Test & Measurement Catalog
 Hewlett-Packard Company
 3200 Hillview Avenue
 Palo Alto, CA 94304
 Tel: (415) 857-4706
 Fax: (415) 857-3880

HEADQUARTERS OFFICES

If there is no sales office listed for your area, contact one of these headquarters offices

ASIA

Hewlett-Packard Asia Ltd.
 22/F Bond Centre, West Tower
 89 Queensway, Central
HONG KONG
 G.P.O. Box 863, Hong Kong
 Tel: 5-8487777
 Telex: 76793 HPA HX
 Cable: HPASIAL TD

CANADA

Hewlett-Packard (Canada) Ltd.
 6877 Goreway Drive
MISSISSAUGA, Ontario L4V 1M8
 Tel: (416) 678-9430
 Fax: (416) 678-9421

EASTERN EUROPE

Hewlett-Packard Ges.m.b.H.
 Liebigasse 1
 P.O. Box 72
 A-1222 VIENNA, Austria
 Tel: (222) 2500
 Telex: 1 3 4425 HEPA A

NORTHERN EUROPE

Hewlett-Packard S.A.
 V.O. Hooftaan 241
 P.O. Box 999
 NL-118 LN 15 AMSTELVEEN
 The Netherlands
 Tel: 20 5479999
 Telex: 18919 hpner

SOUTH EAST EUROPE

Hewlett-Packard S.A.
 World Trade Center
 110 Avenue Louis-Casari
 1215 Cointrin, GENEVA, Switzerland
 Tel: (022) 96 96 51
 Telex: 27225 hpser
 Mail Address:
 P.O. Box
 CH-1217 Meyrin 1
GENEVA
 Switzerland

MIDDLE EAST AND CENTRAL AFRICA

Hewlett-Packard S.A.
 International Sales Branch
 Middle East/Africa
 7, rue du Bois-du-Lan
 P.O. Box 364
 CH-1217 Meyrin 1
GENEVA
 Switzerland
 Tel: (41/22) 780 7111
 Fax: 783 7535

European Operations
 Hewlett-Packard S.A.
 150, Route du Nant d'Avril
 1217 Meyrin 2
GENEVA, Switzerland
 Tel: (41/22) 780 8111
 Fax: (41/22) 780 8542

UNITED KINGDOM

Hewlett-Packard Ltd.
 Nine Mile Ride
WOKINGHAM
 Berkshire, RG11 3LL
 Tel: 0344 773100
 Fax: (44/344) 763526

UNITED STATES OF AMERICA

Customer Information Center
 (800) 752-0900
 6:00 AM to 5:00 PM Pacific Time

EASTERN USA

Hewlett-Packard Co.
 4 Choce Cherry Road
ROCKVILLE, MD 20850
 Tel: (301) 670-4300

MIDWESTERN USA

Hewlett-Packard Co.
 5201 Tollview Drive
ROLLING MEADOWS, IL 60008
 Tel: (312) 255-9800

SOUTHERN USA

Hewlett-Packard Co.
 2015 South Park Place
ATLANTA, GA 30339
 Tel: (404) 955-1500

WESTERN USA

Hewlett-Packard Co.
 5161 Lankershim Blvd.
NORTH HOLLYWOOD, CA 91601
 Tel: (818) 505-5600

OTHER INTERNATIONAL AREAS

Hewlett-Packard Co.
 Intercontinental Headquarters
 3495 Deer Creek Road
PALO ALTO, CA 94304
 Tel: (415) 857-5027
 Telex: 034-8300
 Cable: HEWPACK

Hewlett-Packard Trading S.A.
 Bureau de Liaison/Bureau de Spport
 Villa des Lions
 5, Hai Gallouf
DZ-BORDJ EL BAHRI
 Tel: 76 02 07
 Fax: 281 0387

ANGOLA

Telectra Angota LDA
 Empresa Tecnica de Equipamentos
 16 rue Cons. Julio de Vilhena
LUANDA
 Tel: 35515.35516
 Telex: 3134

ARGENTINA

Hewlett-Packard Argentina S.A.
 Montaneses 2140/50
BUENOS AIRES
 Tel: (54/1) 781 4059
 (54/1) 781-4090

Laboratorio Rodriguez
 Corswant S.R.L.
 Misiones, 1156 - 1876
 Bernal, Oeste
BUENOS AIRES
 Tel: 252-3858, 252-4991
 Argentina Esanco S.R.L.
 A/ASCO 2328
 1416 BUENOS AIRES
 Tel: 541-58-1981, 541-59-2767
 Telex: 22796 HEW PAC-AR

AUSTRALIA

Customer Information Centre
 Tel: (008) 033821

Adelaide, South Australia Office

Hewlett-Packard Australia Ltd.
PARKSIDE, S.A. 5063
 153 Greenhill Road
ADELAIDE (Parkside) Sales
 Tel: (61-8) 272-5911
 Fax: (61/8) 373-1398

Brisbane, Queensland Office

Hewlett-Packard Australia Ltd.
 10 Payne Road
THE GAP, Queensland 4061
 Tel: 61-7-300-4133
 Telex: 42133
 Cable: HEWPARD Brisbane

Canberra, Australia Capital Territory Office

Hewlett-Packard Australia Ltd.
 Thynne Street, Fern Hill Park
BRUCE, A.C.T. 2617
 P.O. Box 257,
JAMSON, A.C.T. 2614
 Tel: 61-62-51-8999
 Telex: 62650
 Cable: HEWPARD Canberra

Melbourne, Victoria Office

Hewlett-Packard Australia Ltd.
 31-41 Joseph Street
 P.O. Box 221
BLACKBURN, Victoria 3130
 Tel: (61/3) 895-2895
 Fax: (61/3) 895-7831
 Cable: HEWPARD Melbourne

Perth, Western Australia Office

Hewlett-Packard Australia Ltd.
 Hordson Business Park
 Cnr. Haster & Gould Strs.
 Osborne Park
CLAREMONT, W.A. 6017
 Tel: (61/9) 242 1414
 Fax: (61/9) 242-1682
 Cable: HEWPARD Perth

Sydney, New South Wales Office

Hewlett-Packard Australia Ltd.
 17-23 Talavera Road
 P.O. Box 308
NORTH RYDE, N.S.W. 2113
 Sydney, Australia
 Tel: (61/2) 888-4444
 Fax: (61/2) 888-9072
 Cable: HEWPARD Sydney

AUSTRIA

Hewlett-Packard GmbH
 Verkaufsbuero Graz
 Grottenhofstrasse 94
A-8052 GRAZ
 Tel: 43-316-291-5660
 Telex: 312375

Hewlett-Packard GmbH
 Liebigasse 1
 P.O. Box 72
A-1222 VIENNA
 Tel: (43/222) 2500
 Fax: (48/222) 2500 Ext 444

BAHRAIN

Modern Electronic
 Establishment
 Hewlett-Packard Division
 P.O. Box 22015
RIYADH 11495
SAUDI ARABIA
 Tel: (966/1) 4763030
 Telex: 595 (0495) 202049

Wael Pharmacy

P.O. Box 648
MANAMA
 Tel: 256123
 Telex: 8550 WAEL BN

BELGIUM

Hewlett-Packard Belgium S.A./N.V.
 Blvd de la Woluwe, 100
 Woluwedal
 1200 BRUSSELS
 Tel: (32/2) 761.31.11
 Fax: (32/2) 763.06.13

BENIN

S.I.T.E.L.
 Immeuble le General
 Av. General de Gaulle
 P.O. Box 161
ABIDJAN 01
 Ivory Coast
 Tel: 32 12 27
 Telex: 22 149

BERMUDA

Applied Computer Technologies
 Atlantic House Building
 P.O. Box HM 2091
 Par-La-Ville Road
HAMILTON 5
 Tel: 295-1616
 Telex: 380 3589/ACT BA

BOLIVIA

Arrellano Ltda
 Av. 20 de Octubre #2125
 Casilla 1383
LA PAZ
 Tel: 368541
 Siser Ltda. (Sistemas de
 Importacion y Servicios Ltda.)
 Gabriel Gozalvez 221
 Casilla 4084
LA PAZ
 Tel: (591/2) 340962/
 363365/343245
 Fax: 35-9268

BRAZIL

Hewlett-Packard do Brasil S.A.
 Praia de Botafogo 228-A-614
 6. AND.-CONJ. 601
 Edificio Argentina - Ala A
 22250 **RIO DE JANEIRO, RJ**
 Tel: (55/21) 552-6422
 Telex: 21905 HPBR BR
 Cable: HEWPACK Rio de Janeiro

BRUNEI

Komputer Wisman Sdn Bhd
 G6, Chandrawasih Cmplx.
 Jalan Tutong
 P.O. Box 1297,
BANDAR SERI BEGAWAN
NEGARA BRUNI DARUSSALAM
 Tel: 673-2-2000-70/26711

BURKINA FASSO

S.I.T.E.L.
 Immeuble le General
 Avenue General de Gaulle
 P.O. Box 161
ABIDJAN 01
 Ivory Coast
 Tel: 32 12 27
 Telex: 22149

CAMEROON

R.T.I.
 175 Rue Blomet
 75015 PARIS
 France
 Tel: (1) 45 31 0906
 Telex: 203376
 Fax: (1) 45 31 09 18

CANADA

Alberta
 Hewlett-Packard (Canada) Ltd.
 3030 3rd Avenue N.E.
CALGARY, Alberta T2A 6T7
 Tel: (1/403) 235-3100
 Fax: (1/403) 272-2299

Hewlett-Packard (Canada) Ltd.
 11120-178th Street
EDMONTON, Alberta T5S 1P2
 Tel: (1/403) 486-6666
 Fax: (1/403) 489-8764

SALES OFFICES

Arranged alphabetically by country (cont'd)

CANADA (Cont'd)

British Columbia
Hewlett-Packard (Canada) Ltd
10691 Shelbridge Way
RICHMOND,
British Columbia V6X 2W8
Tel: (1/604) 270-2277
Fax: (1/604) 276-0859

Manitoba
Hewlett-Packard (Canada) Ltd.
1825 Inkster Blvd.
WINNIPEG, Manitoba R2X 1R3
Tel: (204) 694-2777

New Brunswick
Hewlett-Packard (Canada) Ltd.
314 Main Street
MONCTON, New Scotia E1C 1E6
Tel: (506) 855-2841

Nova Scotia
Hewlett-Packard (Canada) Ltd.
201 Brownlow Avenue
DARTMOUTH, Nova Scotia B3B 1W2
Tel: (1/902) 469-7820
Fax: (1/902) 468-2817

Hewlett-Packard
(Canada) Ltd.
475 Hood Rd., Unit #2
MARKHAM, L3R 8H1
Tel: (416) 479-1770

Ontario
Hewlett-Packard (Canada) Ltd.
552 Newbold Street
LONDON, Ontario N6E 2S5
Tel: (1/519) 886-9181
Fax: (1/519) 886-9145

Hewlett-Packard (Canada) Ltd.
6877 Goreway Drive
MISSISSAUGA, Ontario L4V 1M8
Tel: (1/416) 678-9430
Fax: (1/416) 673-7253

Hewlett-Packard (Canada) Ltd.
2670 Queensview Dr.
OTTAWA, Ontario K2B 8K1
Tel: (1/613) 820-6483
Fax: (1/613) 820-0377

Hewlett-Packard (Canada) Ltd.
3790 Victoria Park Ave.
WILLOWDALE, Ontario M2H 3H7
Tel: (1/416) 499-2550

Quebec
Hewlett-Packard (Canada) Ltd.
17500 Trans Canada Highway
South Service Road
KIRKLAND, Quebec H9J 2X8
Tel: (1/514) 697-4232
Fax: (1/514) 697-6941

Saskatchewan
Hewlett-Packard (Canada) Ltd.
#1, 2175 Airport Rd.
SASKATOON, Saskatchewan S7L 7E1
Tel: (306) 242-3702

CHILE

Ricardo Borzutsky
Avanzados Sistemas de
Conocimientos S.A.
Austria 2041
SANTIAGO
America del Sur
Tel: (562) 223-5946/6148

**CHINA, People's
Republic of**
China Hewlett-Packard Co., Ltd.
22/F Bond Centre, West Tower
88 Queensway, Central
HONG KONG

Tel: (852/5) 8487777
Fax: (852/5) 868 4997
China Hewlett-Packard Co., Ltd.
P.O. Box 9610, Beijing
38 Bei San Huan X1 Road
Shuang Yu Shu, Hai Dian District
BEIJING
Tel: 256-6888
Fax: 256-3207

China Hewlett-Packard Co., Ltd.
23/F Shanghai Union Building
100 Yan An Road
SHANG-HAI
Tel: 203-240
Fax: 202-149

COLOMBIA
Instrumentación
M. A. Langebaek & Kier S.A.
Carrera 4A No. 52A-26
Apartado Aereo 6287
BOGOTÁ 1, D.E.
Tel: 212-1468
Telex: 44400 INST CO
Cable: AARIS Bogoté

CONGO
Sema-Metra
16-18 Rue Barbes
92126 Montrouge Cedex
FRANCE
Tel: (1) 657/300
Telex: 200601 Semetra
Fax: (1) 46 58 96 53

COSTA RICA
Cientifica Costarricense S.A.
Avenida 2, Calle 5
San Pedro de Montes de Oca
Apartado 10159
SAN JOSE
Tel: 9-011-506-243-820
Telex: 3032367 GALGUR CR

Continex S.A.
Avenida 10C
Apartado 746-1000
34-36 **SAN JOSE**
Tel: (506) 33-0933
Telex: 23 10 Continex CR
Fax: 21-6905

O. Fischel R. Y. Cia. S.A.
Apartados 434-10174
SAN JOSE
Tel: 23-72-44
Telex: 2379
Cable: OFIR

CYPRUS

Heliarco - M. Cotevannis
2, Sikelianou St. & Klissias Av.
P.O. Box 65074
N. Psyhiko 15410
ATHENS
Greece
Tel: 647 79 426. 647 79 427
Telex: 224903

Telerexa Ltd
P.O. Box 1152
Valentine House
8 Stassandrou St.
NICOSIA
Tel: 45 628. 62 698
Telex: 5845 hrx cy

DEMSTAR Ltd
P.O. Box 2260
NICOSIA
Cyprus
Tel: 44 10 64
Telex: 3085
Fax: 46 46 35

DENMARK
Hewlett-Packard A/S
Kongevejen 25
3460 **BIRKEROD**
Tel: (45/42) 816640
Fax: (45/42) 815810

Hewlett-Packard A/S
Rølgædsvej 32
DK-8240 **RISIKOV**, Aarhus
Tel: 45-06-17-6000
Telex: 37409 hpas dk

DOMINICAN REPUBLIC
Microprog S.A.
Juan Tomás Mejía y Cotes No. 60
Arroyo Hondo
SANTO DOMINGO
Tel: 565-6268
Telex: 4510 ARENTA DR (PCA)

ECUADOR
CYEDE Cia. Ltda.
Avenida Eloy Alfaro 1749
y Belgica
Casilla 6423 CCI
QUITO
Tel: 9-011-593-2-450975
Telex: 39322548 CYEDE ED

EGYPT
International Engineering Associates
6 El Gamea Street
Agouza
CAIRO
Tel: 71-21-681 348 0904
Telex: 93830 IEA UN
Cable: INTEGASSO

EL SALVADOR
IPESA de El Salvador S.A.
29 Avenida Norte 1223
SAN SALVADOR
Tel: 9-011-503-266-858
Telex: 301 20539 IPESA SAL

ETHIOPIA

R.T.I.
175 rue Blomet
75016 **PARIS**
France
Tel: (1) 45 31 09 06
Telex: 203376
Fax: (1) 45 31 09 18

FINLAND
Hewlett-Packard Finland
Field Oy
Niittyanpolku 10
00620 **HELSINKI**
Tel: (90) 757-1011
Telex: 122022 Field SF

Hewlett-Packard Oy
Pispankalliontie 17
02200 **ESPOO**
Tel: (358/0) 88721
Fax: (358/0) 887 2277

Hewlett-Packard Oy
Vainonkatu 9 C
40100 **JYVASKYLÄ**
Tel: (358/41) 21 85 11

Hewlett-Packard Oy
Vaitatie 57
90500 **OULU**
Tel: (358/81) 340 144

FRANCE
Hewlett-Packard France
Z.I. Mercure B
Rue Berthelot
13763 **LES MILLES** Cedex
AIX-EN-PROVENCE
Tel: 33-42-59-41-02
Telex: 410770F
Hewlett-Packard France
ZA Kergaradec
Rue Fernand Forest
29239 **GOUESSOU** (Brest)
Tel: (98) 41-87-90

Hewlett-Packard France
Chemin des Mouilles
Boite Postale 162
69131 **ECULLY** Cedex (Lyon)
Tel: (33) 72-29-32-93
Telex: 310817F

Hewlett-Packard France
Z.I. Mercure B
Rue Berthelot
F-13763 **LES MILLES** Cedex
Aix-en-Provence
Tel: (33/42) 59-41-02
Telex: 410770
Fax: 594872

Hewlett-Packard France
Parc Club des Tanneries
Batiment B4
4, Rue de la Faisanderie
67381 **LINGOLSHEIM** (Strasbourg)
Tel: (88) 76-15-00
Telex: 890141F

Hewlett-Packard France
Parc d'activités Cadéra
Quartier Jean-Mermoz
Avenue du Président JF Kennedy
33700 **MERIGNAC** (Bordeaux)
Tel: (33) 56-34-00-64
Telex: 550105F

Hewlett-Packard France
Miniparc ZIRST
Chemin du Vieux Chêne
38240 **MEYLAN** (Grenoble)
Tel: (76) 90-38-40

Hewlett-Packard France
Ru de l'Hôtelerie
Le Petit Bel Air
44470 **CARQUEFOU** (Nantes)
Tel: 40-30-38-38
Telex: 711085F

Hewlett-Packard France
Parc Tertiaire Hétiopolis
Route de Micy
45380 **La CHAPELLE ST MESMIN**
(Orleans)
Tel: 38-43-93-56
Telex: 783 497F

Hewlett-Packard France
Zone Industrielle de Courtaubouef
1, av. du Canada
91947 **LES ULIS** Cedex (Orsay)
Tel: 69-62-60-60
Telex: 600046F

R.T.I. (Realisations
Telematiques Internationales)
175, rue Blomet
F-75015 **PARIS**
Tel: (33/1) 45310906
Telex: 42/203376

Hewlett-Packard France
Parc d'activités de la Poterie
Rue Louis Kerautel-Boimel
35000 **RENNES**
Tel: 99-51-42-44
Telex: 740912F

Hewlett-Packard France
45, rue des 3 Soeurs
Centre d'Affaires Paris Nord II
F-93420 Villepinte
B.P. 60020
F-95971 **ROISSY**
CHARLES DE GAULLE Cedex
Tel: (33/48) 91-68-00
Telex: 232366
Fax: 632183

Hewlett-Packard France
P.A.T. Lavatine
3, rue Jacques Monod
BP 185
76136 **MONT-ST-AIGNAN** (Rouen)
Tel: 35-59-19-20
Telex: 770035F

Hewlett-Packard France
Innoparc
BP 167 - Voie n°7
31328 **LABEGE** Cedex (T...use)
Tel: 61-39-11-40
Telex: 531639F

Hewlett-Packard France
Les Cardoulines
Batiment B2
Route des Dolines
Parc d'activité de Valbonne
Sophia Antipolis
06560 **VALBONNE** (Nice)
Tel: 93-65-39-40

Hewlett-Packard France
Parc d'activité des Prés
1, Rue Papin Cedex
59658 **VILLENEUVE D'ASCQ**
Tel: 20-91-41-25
Telex: 160124F

FRENCH WEST**INDIES****(Antilles)**

R.T.I.
175, Rue Blomet
75015 PARIS
FRANCE
Tel: (1) 45 31 09 06
Telex: 203376
Fax: (1) 45 31 09 18

GABON

R.T.I. Cameroon
Distribution/Services
B.P. 3899
DOULA, CAMEROON
(Please contact R.T.I. France.)
Tel: (237) 423291
Telex: 9705385

R.T.I.
175, rue Blomet
75015 PARIS
FRANCE
Tel: (1) 45 31 09 06
Telex: 203376
Fax: (1) 45 31 09 18

**GERMAN FEDERAL
REPUBLIC**

Hewlett-Packard GmbH
Vertriebszentrale Deutschland
Hewlett-Packard-Strasse
Postfach 1641
D-6380 **BAD HOMBURG v.d.H.**
Tel: (06172) 400-0
Telex: 410 844 hpbhg

Hewlett-Packard GmbH
Geschäftsstelle
Keithstrasse 2-4
D-1000 **BERLIN 30**
Tel: (030) 21 99 04-0
Telex: 018 3405 hpbpln d

Hewlett-Packard GmbH
Verbindungsstelle Bonn
Friedrich-Ebert-Allee 26
5300 BONN
Tel: (0228) 234001
Telex: 8869421

Hewlett-Packard GmbH
Vertriebszentrum Südwest
Schickardstrasse 2
D-7030 **BÖBLINGEN**
Postfach 1427
Tel: (49/7031) 645
Fax: (49/7031) 645-429

Hewlett-Packard GmbH
Zentralbereich Mitg
Herrenberger Strasse 130
D-7030 **BÖBLINGEN**
Tel: (49/7031) 14-0
Fax: (49/7031) 14-2999

Hewlett-Packard GmbH
Geschäftsstelle
Schleefstr. 28a
D-4600 **DORTMUND-41**
Tel: (0231) 45001
Telex: 822858 hepdod
Hewlett-Packard GmbH
Reparaturzentrum Frankfurt
Bernar Strasse 117
6000 FRANKFURT/MAIN 60
Tel: (069) 500001-0
Telex: 413249 hpfm

Hewlett-Packard GmbH
Vertriebszentrum Nord
Kapstadtstr. 5
D-2000 **HAMBURG 60**
Tel: 49-40-63-804-0
Telex: 021 63 032 hphh d

Hewlett-Packard GmbH
Geschäftsstelle
Hedering 37-39
D-3000 **HANNOVER 61**
Tel: (49/511) 5706-0
Fax: (49/511) 5706-126

Hewlett-Packard GmbH
Geschäftsstelle
Rosslauer Weg 2-4
D-6800 **MANNHEIM**
Tel: 49-0621-70-05-0
Telex: 0462105 hpmhm

Hewlett-Packard GmbH
Geschäftsstelle
Messerschmittstrasse 7
D-7910 **NEU ULM**
Tel: 49-0731-70-73-0
Telex: 0712816 HP ULM-D

Hewlett-Packard GmbH
Geschäftsstelle
Emmericher Strasse 13
D-8500 **NÜRNBERG 10**
Tel: (0911) 5205-0
Telex: 0623 860 hpnbg

Hewlett-Packard GmbH
Vertriebszentrum Ratingen
Berliner Strasse 111
D-4030 **RATINGEN**
Postfach 31 12
Tel: (02102) 494-0
Telex: 589 070 hprad

Hewlett-Packard GmbH
Vertriebszentrum München
Eschenstrasse 5
D-8028 **TAUFKIRCHEN**
Tel: 49-89-61-2070
Telex: 0524985 hpmch

Hewlett-Packard GmbH
Geschäftsstelle
Ermisallee
7517 **WALDBRONN 2**
Postfach 1251
Tel: (07243) 602-0
Telex: 782 838 hepk

GREAT BRITAIN
See United Kingdom**GREECE**

Hewlett-Packard Hellas
32, Kifissias Avenue
15125 Amaroussion
ATHENS
Greece
Tel: 6828811
Telex: 216588 hpat gr
Fax: 6832978

GUATEMALA

IPESA DE GUATEMALA
Avenida Reforma 3-48, Zona 9
GUATEMALA CITY
Tel: 316627, 317853, 0647 1/5
9-011-502-2-316627
Telex: 3055765 IPESA GU

GUINEA

R.T.I.
175, Rue Blomet
75015 PARIS
FRANCE
Tel: (1) 45 31 09 06
Telex: 203376
Fax: (1) 45 31 09 18

HONG KONG

Hewlett-Packard Asia, Ltd.
22/F, West Tower Bond Centre
89 Queensway Central
HONG KONG
Tel: (852/5) 648-7777
Fax: (852/5) 868-4997
Cable: HEWPACK HONG KONG

ICELAND

Hewlett-Packard Iceland
Hoelidabakka 9
112 **REYKJAVIK**
Tel: 354-1-67-1000
Telex: 37409
Fax: 354-1-873031

INDIA

Computer products are sold through
Blue Star Ltd. All computer repairs
and maintenance service is done
through Computer Maintenance Corp.

Blue Star Ltd.
B. D. Patel House
Near Sardar Patel Colony
AHMEDABAD 380 014
Tel: 403531, 403532
Telex: 0121-234
Cable: BLUE FROST

Blue Star Ltd.
40/4 Lavelle Road
BANGALORE 560 001
Tel: 57881, 867780
Telex: 0845-430 BSLBN
Cable: BLUESTAR

Blue Star Ltd.
Sahas
414/2 Vir Savarkar Marg
Prabhadevi
BOMBAY 400 025
Tel: 422-6155
Telex: 011-71193 BSSS IN
Cable: FROSTBLUE

Blue Star Ltd.
Kalyan, 19 Vishwas Colony
Alkapuri, **BARODA, 390 005**
Tel: 65235, 65236
Cable: BLUE STAR

Blue Star Ltd.
7 Hare Street
P.O. Box 506
CALCUTTA 700 001
Tel: 230131, 230132
Telex: 031-61120 BSNF IN
Cable: BLUESTAR

Blue Star Ltd.
13 Community Center
New Friends Colony
NEW DELHI 110 065
Tel: 682547
Telex: 031-2463
Cable: BLUEFROST

Blue Star Ltd.
2-2-47/1108 Bolarum Rd.
SECUNDERABAD 500 003
Tel: 72057, 72058
Telex: 0155-459
Cable: BLUEFROST

Blue Star Ltd.
T. C. 7/603 Poornima
Maruthunkuzhi
TRIVANDRUM 695 013
Tel: 65799, 65820
Telex: 0884-259
Cable: BLUESTAR

Hewlett-Packard India
Meridian Commercial Complex
6th Floor
8 Windsor Place
Jampath
NEW DELHI 110 001
Tel: 91-11384911
Telex: 31-4935 HPNDIN

INDONESIA

BERCA Indonesia P.T.
P.O. Box 496/Jkt.
Jl. Abdul Muis 62
JAKARTA
Tel: 21-373009
Telex: 46748 BERSAL IA
Cable: BERSAL JAKARTA

BERCA Indonesia P.T.
P.O. Box 2497/Jkt
Antara Bldg., 12th Floor
Jl. Medan Merdeka Selatan 17
JAKARTA-PUSAT
Tel: 21-340417
Telex: 46748 BERSAL IA

BERCA Indonesia P.T.
Jalan Kutai 24
SURABAYA
Tel: 67118
Telex: 31146 BERSAL SB
Cable: BERSAL-SURABAYA

IRAQ

Hewlett-Packard Trading S. A.
Service Operation
Al Mansoor City 609/10/7
BAGHDAD
Tel: 551-49-73
Telex: 212-455 HEPAIRAQ IK

IRELAND

Hewlett-Packard Ireland Ltd.
Temple House, Temple Road
Blackrock, Co. **DUBLIN**
Tel: (353/1) 883399
Telex: 30439

Hewlett-Packard Ltd.
75 Belfast Rd, Carrickfergus
Belfast BT38 8PH
NORTHERN IRELAND
Tel: 09603-67333
Telex: 747626

ISRAEL

Eidan Electronic Instrument Ltd.
P.O. Box 1270
JERUSALEM 91000
16, Ohalav St.
JERUSALEM 94467
Tel: 533 221, 533 242
Telex: 25231 AB/PAKRO IL

Computation and Measurement
Systems (CMS) Ltd.
11 Masad Street
67060
TEL-AVIV
Tel: 388 388
Telex: 33569 Motil IL

ITALY

Hewlett-Packard Italiana Spa
Via G. di Vittorio 10
20094 **CORSICO (MI)**
Tel: 02/4408351
Fax: 02/4409964

Hewlett-Packard Italiana Spa
Via Nuova Rivottiana 95
20090 **LIMITO (MI)**
Tel: 02/75761
Fax: 02/7576230

Hewlett-Packard Italiana Spa
Via Emilia 51/C
40011 **ANZOLA
DELL'EMILIA (BO)**
Tel: 051/731061

Hewlett-Packard Italiana Spa
Via M. Ricci 17 - Palombina Nuova
60100 ANCONA
Tel: 071/883782

Hewlett-Packard Italiana Spa
Traversa 99C Giulio Petroni 19
70124 **BARI**
Tel: 080/410744
Fax: 080/417891

Hewlett-Packard Italiana Spa
Via Principe Nicola 43G/C
95126 CATANIA
Tel: 095/371087
Fax: 095/398569

Hewlett-Packard Italiana Spa
Via G. Di Vittorio 9
20063 **CERNUSCO S/N (MI)**
Tel: 02/923691
Fax: 02/9237746

Hewlett-Packard Italiana Spa
Via Sacco e Vanzetti 1/A
50145 **FIRENZE**
Tel: 055/318533
Fax: 055/373966

Hewlett-Packard Italiana Spa
Viale Brigata Bisagno 2
16129 **GENOVA**
Tel: 010/541141
Fax: 010/591733

Hewlett-Packard Italiana Spa
Via Orasio 16
80122 **NAPOLI**
Tel: 081/7811444
Fax: 081/680164

Hewlett-Packard Italiana Spa
Via Pellizzo 15
35128 **PADOVA**
Tel: 049/6070166
Fax: 049/773097

Hewlett-Packard Italiana Spa
Via Del Tintoretto 200
00144 **ROMA**
Tel: 06/54831
Fax: 06/5408710

SALES OFFICES

Arranged alphabetically by country (cont'd)

ITALY (Cont'd)

Hewlett-Packard Italiana Spa
Corso Svizzera 185
10149 TORINO
Tel: 011/744044
Fax: 011/7710815

IVORY COAST

Ste Ivoirienne des Techniques
de l'Informatique
Immeuble C.N.A. - 5e etage
Avenue General de Gaulle
P.O. Box 161

ABIDJAN 01

Tel: 32 12 27
Telex: 22149

Engineering Business Concept (E.B.C.)

Angle Avenue J. Anoma et Bd.

Republique

08 B.P. 323 ABIDJAN 08

Tel: 32 50 24, 41 48 70

Fax: 35 37 90

JAPAN

Yokogawa-Hewlett-Packard Ltd.

Nihon-Seimei Akita

Chuo-Dori Bldg.

4-2-7 Naka-dori

AKITA, 010

Tel: (81/188) 36-5021

Yokogawa-Hewlett-Packard Ltd.

152-1, Onna

ATSUGI, Kanagawa, 243

Tel: (81/462) 25-0051

Fax: (81/462) 25-0064

Yokogawa-Hewlett-Packard Ltd.

3-1 Motochiba-cho

CHIBA, 280

Tel: (81/472) 25-7701

Fax: (81/472) 21-0382

Yokogawa-Hewlett-Packard Ltd.

Dai-3 Hakata-Kaisai Bldg

1-3-6 Hakata-eki Minami

Hakata-Ku, FUKUOKA 812

Tel: (81/92) 472-8731

Yokogawa-Hewlett-Packard Ltd.

Nihon-Dantai-Seimei-

Koriyama Bldg.

21-10 Toramaru-cho,

Koriyama FUKUSHIMA, 963

Tel: (81/249) 39-7111

Yokogawa-Hewlett-Packard Ltd.

Yasuda-Seimei Hiroshima Bldg.

6-11, Hon-dori, Naka-ku

HIROSHIMA, 730

Tel: (81/82) 241-0611

Fax: (81/82) 241-0619

Yokogawa-Hewlett-Packard Ltd.

Issei Bldg.

2-3-17 Takezono, Tsukuba

IBARAKI, 305

Yokogawa-Hewlett-Packard Ltd.

Mito Mitsui Bldg.

1-4-73, Sanno-maru

Mito, IBARAKI 310

Tel: (81/292) 25-7470

Yokogawa-Hewlett-Packard Ltd.

Towa Building 2-2-3

Kaigan-dori, Chuo-ku

KOBE, 650

Tel: (81/78) 392-4791

Fax: (81/78) 392-4839

Yokogawa-Hewlett-Packard Ltd.

Kumagaya Asahi 82 Bldg.

3-4 Tsukuba

KUMAGAYA, Saitama 360

Tel: (81/485) 24-6563

Fax: (81/485) 24-9050

Yokogawa-Hewlett-Packard Ltd.

Shin-Kyoto Center Bldg.

614 Higashi-Shioji-cho

Karasuma-Nishi-Iru, Shioji-Dori

Shimogyo-Ku, KYOTO, 600

Tel: (81/75) 343-0921

Fax: (81/75) 343-4356

Yokogawa-Hewlett-Packard Ltd.

Mito Mitsui Bldg.

1-4-73, Sanno-Maru

MITO, Ibaraki 310

Tel: (81/292) 25-7470

Fax: (81/292) 31-6589

Yokogawa-Hewlett-Packard Ltd.

Nagano-Tokyo-kiyo Bldg.

108-1, Minamagata-Machi

Nagano-Shi, NAGANO, 380

Tel: (81/262) 24-8012

Fax: (81/262) 24-8016

Yokogawa-Hewlett-Packard Ltd.

Nagoya Kokusai Center Building

1-47-1, Nagato, Nakamura-ku

NAGOYA, AICHI 450

Tel: (81/52) 571-5171

Fax: (81/52) 565-0896

Yokogawa-Hewlett-Packard Ltd.

Sai-Kyo-Ren Building

1-2 Dote-cho

OOMIYA-SHI SAITAMA 330

Tel: (0486) 45-8031

Yokogawa-Hewlett-Packard Ltd.

Chuo Bldg., 5-4-20 Nishi-Nakajima

4-20 Nishinakajima, 5 Chome,

Yodogawa-ku

OSAKA, 532

Tel: (81/6) 304-6021

Fax: (81/6) 304-0216

Yokogawa-Hewlett-Packard Ltd.

1-27-15, Yabe

SAGAMIHARA Kanagawa, 229

Tel: (81/427) 59-1311

Yokogawa-Hewlett-Packard Ltd.

Hamamatsu Motoshiro-cho Daichi

Seimei Bldg 219-21, Motoshiro-cho

Hamamatsu-shi

SHIZUOKA, 430

Tel: (81/534) 56-1771

Fax: (81/534) 552371

Yokogawa-Hewlett-Packard Ltd.

Shinjuku Daichi Seimei Bldg.

Nishi Shinjuku 2-7-1,

Shinjuku-ku, TOKYO 163

Tel: (81/3) 348-4611

Fax: (81/3) 348-7969

Yokogawa-Hewlett-Packard Ltd.

5-1, Takakura-cho

Hachioji-shi, TOKYO, 192

Tel: 81-426-42-1231

Yokogawa-Hewlett-Packard Ltd.

Tokyo-Nissam-Minato Bldg.

1-6-34 Konan, Minato-ku

TOKYO 108

Tel: (81/3) 458-5411

Yokogawa-Hewlett-Packard Ltd.

29-21 Takaido-Higashi, 3-chome

Sugami-ku TOKYO 168

Tel: (03) 331-6111

Telex: 232-2024 YHPTOK

Yokogawa Hokushin Electric Corp.

(YEW)

Shinjuku-NS Bldg. 10F

9-32 Nokacho 2 Chome

Shinjuku-ku

TOKYO, 163

Tel: (03) 349-1859

Telex: J27584

Yokogawa-Hewlett-Packard Ltd.

Toyoda-Tokyo-Kaijo Bldg.

1-179 Miyuki-Hon-cho

TOYODA 473

Tel: (81/565) 27-5611

Yokogawa-Hewlett-Packard Ltd.

Chiyodaseimei-Utsunomiya Bldg.

2-3-1, Ohtori, UTSUNOMIYA, Tochigi-

Shi 320

Tel: (81/286) 33-1153

Fax: (81/286) 33-1175

Yokogawa-Hewlett-Packard Ltd.

No. 2 Yasuda Bldg.

2-32-12, Tsuruyo-cho

Kanagawa-ku, YOKOHAMA 221

Tel: (81/45) 312-1252

Fax: (81/45) 311-8328

Yokogawa-Hewlett-Packard Ltd.

ADCOM Ltd., Inc., Kenya

P.O. Box 30070

NAIROBI

Tel: 331955

Telex: 22639

Yokogawa-Hewlett-Packard Co. Ltd.

Dongbang Yeeuindo Building

36-1 Yeeui Do-Dong

Yeongdeungpo-Ku

SEOUL, 150

Tel: (82/2) 784-4668, 784-2666

Fax: (82/2) 784-7084

Telex: 25166 SAMSAN K

Yokogawa-Hewlett-Packard Ltd.

Al-Khalidiya Trading & Contracting

P.O. Box 830

BAFAT 13009

Tel: 242 49 10, 241 12 26

Telex: 22481 AREEG KT

Cable: VISCOUNT

Yokogawa-Hewlett-Packard Ltd.

Computer Information Systems S.A.L.

Chammas Building

P.O. Box 11-8274

DORA BEIRUT

Tel: 89 31 13, 58 18 35

Telex: 42309 chacic le

Fax: 58 18 34

Yokogawa-Hewlett-Packard Ltd.

Blvd de la Wokwe, 100

Woutwedai

B-1200 BRUSSELS

Tel: (32/2) 761-3111

Telex: 23-494 paloben brv

MADAGASCAR

R.T.I.

175, Rue Blomet

75015 Paris

FRANCE

Tel: (1) 45 31 09 06

Tlx: 203376

Fax: (1) 45 31 09 18

MALAWI

Systron (Private) Ltd.

Manhattan Court

81 Second Street

P.O. Box 3458

HARARE

Zimbabwe

Tel: 739881/739885

Telex: 4122

Fax: 70 20 06

MALAYSIA

Hewlett-Packard Sales (Malaysia)

Sdn. Bhd.

9th Floor

Chung Khiew Bank Building

46, Jalan Raja Laut

50350 KUALA LUMPUR, MALAYSIA

Tel: (60/3) 298-6555

Fax: (60/3) 291-5495

Protel Engineering

P.O. Box 1917

Lot 6624, Section 64

23/4 Pending Road

Kuching, SARAWAK

Tel: 36299

Telex: 70904 PROMAL MA

Cable: PROTELENG

MALTA

R.T.I.

175, Rue Blomet

75015 PARIS

France

Tel: (1) 45 31 09 06

Telex: 203376

Fax: (1) 45 31 09 18

MAURITANIA

R.T.I.

175, Rue Blomet

75015 PARIS

France

Tel: (1) 45 31 09 06

Tlx: 203376

Fax: (1) 45 31 09 18

MAURITIUS

R.T.I.

175, Rue Blomet

75015 PARIS

France

Tel: (1) 45 31 09 06

Telex: 203376

Fax: (1) 45 31 09 18

Hewlett-Packard Nederland B.V.
Bongerd 2
NL 2900AA **CAPELLE A/D IJSEL**
Tel: 31-20-51-6444
Telex: 21261 HEPAC NL

Hewlett-Packard Nederland B.V.
Pastoor Petersstraat 134-136
P.O. Box 2342
NL 5600 CH **EMHOVEN**
Tel: 31-40-32-6911
Telex: 51484 hepae nl
Fax: (31/40) 446546

NEW ZEALAND

Hewlett-Packard (N.Z.) Ltd.
5 Owens Road
P.O. Box 26-189
Epsom, **AUCKLAND**
Tel: (64/9) 605-651
Fax: (64/9) 600-507

Hewlett-Packard (N.Z.) Ltd.
186-190 Willis Street
P.O. Box 9443
WELLINGTON
Tel: (64/4) 820-400
Fax: (64/4) 843-380

NIGER

S.I.T.E.L.
Immeuble le General
Avenue General de Gaulle
PO Box 161
ABIDJAN 01
Ivory Coast
Tel: 32 12 27
Telex: 22149

NIGERIA

Management Information Systems Ltd.
3 Gerrard Road, Ikoyi
LAGOS
Tel: 68 08 87
Telex: 23582
Fax: 68 54 87

NORTHERN IRELAND

See United Kingdom

NORWAY

Hewlett-Packard Norway A/S
Osterendalen 16-18
P.O. Box 34
N-1345 **ØSTERRAAS**
Tel: (47/2) 24-6090
Telex: 76621 HPNAS N

Hewlett-Packard Norway A/S
Boemergt. 42
Box 2470
N-5037 **SOLHEIMSVIK**
Tel: (5/29) 10 72

OMAN

Suhail & Saud Bahwan
P.O. Box 169
MUSCAT/SULTANATE OF OMAN
Tel: 79 37 41
Telex: 3585 mb
Fax: 79 61 58

Intiac LLC
P.O. Box 9196
MNNA AL FAHAL/SULTANATE OF OMAN
Tel: 70-77-27, 70-77-23
Telex: 3885 Tawoos On

PAKISTAN

Mushko & Company Ltd.
House No. 16, Street No. 16
Sector F-6/3
ISLAMABAD
Tel: 824545

Telex: 54001 Muski Pk
Cable: FEMUS Islamabad

Mushko & Company Ltd.
Osman Chambers
Abdullah Haroon Road
KARACHI 0302
Tel: 524131, 524132
Telex: 2894 MUSKO PK
Cable: COOPERATOR Karachi

PANAMA

Electronico Balboa, S.A.
Calle Samuel Lewis, Ed. Alfa
Apartado 4929
PANAMA CITY
Tel: 9-011-507-636613
Telex: 368 3483 ELECTRON PK

PERU

Cia Electro Médica S.A. (ERMED)
Los Flamencos 145, Ofc. 301/2
San Isidro
Casilla 1030
LIMA 1 Peru
Tel: 9-011-511-4-414325, 41-3705
Telex: 39425257 PE PB SIS

PHILIPPINES

The Online Advanced Systems Corp.
2nd Floor, Electra House
115-117 Esteban Street
P.O. Box 1510
Legaspi Village, Makati
Metro **MANILA**
Tel: 815-36-10 (up to 16)
Telex: 63274 ONLINE PN

PORTUGAL

Mundinter Intercambio
Mundial de Comercio
Avenida Antonio 2761
LISBON
Tel: 53 21 31, 53 21 37
Telex: 16691

CPC Instrumentacao
Torre de Santo Antonio
rue Gregorio Lopes, Lote
Restlelo
1400 LISBON
Tel: 617343/44/45/46
Telex: 27432/26054
Fax: 617345

C.P.C.S.I.
Rua de Costa Cabral 575
4200 PORTO
Tel: 493122
Telex: 26054, 27432
Fax: 48 87 21

PUERTO RICO

Hewlett-Packard Puerto Rico
Box 4048
Aguadilla, PR 00605
KARACHI 0302
Tel: (809) 891-6235

Hewlett-Packard Puerto Rico
101 Munoz Rivera Avenue
Esu. Calle Ochoa
HATO REY, 00918
Tel: (809) 754-7800

QATAR

Qatar Datamation Systems
P.O. Box 350
DOHA
Tel: 41 32 82
Tlx: 4833
Fax: 42 63 78

REUNION ISLAND

R.T.I.
175, Rue Blomet
75015 PARIS
France
Tel: (33/1) 45310906
Telex: 42/203376

RWANDA

R.T.I.
175, Rue Blomet
75015 PARIS
France
Tel: (33/1) 45310906
Telex: 42/203376
Fax: (1) 45 31 09 18

SAUDI ARABIA

Modern Electronics Establishment
P.O. Box 281
Thuqbah
AL-KHOBAR 31952
Tel: 895-1760, 895-1764
Telex: 671 106 HPMEEK SJ
Cable: ELECTA AL-KHOBAR

Modern Electronics Establishment
P.O. Box 1228
Redec Plaza, 6th Floor
JEDDAH
Tel: 644 96 28

Telex: 4027 12 FARNAS SJ
Cable: ELECTA JEDDAH

Modern Electronics Establishment
P.O. Box 22015
RIYADH 11485
Tel: 4763030
Telex: 402040 MEERYD SJ

SCOTLAND

See United Kingdom

SENEGAL

2SC
10, rue Tolbac
B.P. 3716
DAKAR R.P.
(Please contact R.T.I. France.)
Tel: (221) 222248
Telex: 906/671

R.T.I.

175, Rue Blomet
75015 PARIS
France
Tel: 45310906
Telex: 203376
Fax: (1) 45 31 09 18

SINGAPORE

Hewlett-Packard Singapore Ltd.
1150 Depot Road
SINGAPORE, 0410
Tel: (65) 273 7388
Fax: (65) 278 8990

SOUTH AFRICA

Hi Performance Systems (Pty) Ltd.
P.O. Box 120, Howard Place
CAPE TOWN 7450
Tel: (27/21) 53-7954
Fax: (27/21) 53-5119

Hi Performance Systems (Pty) Ltd.
Private Bag Wendywood
SANDTON 2144
Tel: (27/11) 802-5111
Fax: (27/11) 802-6332

SPAIN

Hewlett-Packard Española, S.A.
Avda. Diagonal, 605
08028-BARCELONA
Tel: (34/3) 401 91 00
Telex: 52603 hpbee

Bilbao (Vizcaya) Sales
Hewlett-Packard Español, S.A.
Avda. Zugazarte, 8
48930 - Las Arenas - VIZCAYA

Hewlett-Packard Española, S.A.
Ctra. N-VI, Km. 16, 500
Las Rozas
E-MADRID
Tel: (34/1) 6370011
Telex: 23515 HPE

Hewlett-Packard Española, S.A.
Avda. S. Francisco Javier, S/N
Planta 10, Edificio Sevilla 2
E-SEVILLA 5, SPAIN
Tel: (34/54/64) 4454
Telex: 72933

Hewlett-Packard Española, S.A.
Isabel La Católica, 8
46004 VALENCIA
Tel: (34/6) 351 59 44
Telex: 63435
Fax: (34/6) 351 59 44

Hewlett-Packard Española, S.A.
Avda. de Zugazarte, 8
48930 - Las Arenas VIZCAYA
Tel: (34/4) 464 32 55
Telex: 33032

SUDAN

Mediterranean Engineering &
Trading Co., Ltd.
P.O. Box 1025
KHARTOUM
Tel: (249) 41184
Telex: 24052

R.T.I.

175, Rue Blomet
75015 PARIS
France
Tel: (1) 45 31 09 06
Tlx: 203376
Fax: (1) 45 31 09 18

SWEDEN

Hewlett-Packard Sverige AB
Östra Tuldgatan 3
20011 MALMO
Box 6132
Tel: (46/40) 702 70
Telex: (854) 17886 (via Spånga office)

Fax: (46/40) 97 74 18

Hewlett-Packard Sverige AB
Elementvagen 16
S-7022 7 **ÖREBRO**
Tel: (49/16) 10 48 80

Telex: (854) 17886 (via Spånga office)

Hewlett-Packard Sverige AB
Skalhögsgatan 9, Kista
P.O. Box 19
S-16493 **KISTA**
Tel: 46/8/750-200
Telex: (854) 17886
Telefax: (08) 7527781

Hewlett-Packard Sverige AB
Box 266
Topasgatan 1A
S-42123 **VÄSTRA-FRÖLUNDA**
(Gothenburg)
Tel: (031) 891000
Telex: (854) 17886 (via Spånga office)

SWITZERLAND

Hewlett-Packard (Schweiz) AG
Clarastrasse 12
CH-4058 BASEL
Tel: (41/61) 681 59 20
Fax: (41/61) 681 98 59

Hewlett-Packard (Schweiz) AG
7, rue du Bois-du-Lan
Case postale 365-1366
CH-1217 MEYRIN 1
Tel: (41/22) 7804111
Telex: 27333 HPAG CH

Hewlett-Packard (Schweiz) AG
Allmend
CH-8967 WIDEN
Tel: (41/57) 321 111
Telex: 53933 HPAG CH
Fax: (41/57) 321 475

SYRIA

Middle East Electronics
P.O. Box 2308
Abu Rumaneh
DAMASCUS
Tel: 33 45 92
Telex: 411 771 Meesy

TAIWAN

Hewlett-Packard Taiwan Ltd.
Taipei Office
8th Floor, Hewlett-Packard Building
337 Fu Hsing North Road
TAIPEI
Tel: (02) 712-0404
Telex: 24439 HEWPACK
Cable: HEWPACK Taipei

Hewlett-Packard Taiwan Ltd.
THM Office
2, Huan Nan Road
CHUNG LI, Taoyuan
Tel: (034) 929-666

SALES OFFICES

Arranged alphabetically by country (cont'd)

TAIWAN (Cont'd)

Hewlett-Packard Taiwan Ltd.
Taichung Office
5FL, 67, Sec. 3,
Wen-Hsin Road,
TAICHUNG
Tel: (04) 254-1201

Hewlett-Packard Taiwan Ltd.
Kaohsiung Office
11/F, 456, Chung Hsiao 1st Road
KAOSHIUNG
Tel: (07) 2412318

TANZANIA

Adcom Ltd, Inc. Kenya
P.O. Box 30070

Nairobi

Kenya
Tel: 33 19 55
Telex: 22639

THAILAND

Unimesa Co. Ltd.
2540 Sukumvit Avenue
Bangna

BANGKOK 10260
Tel: 662-398-6953
Telex: 84439 Simonco TH
Cable: UNIMESA Bangkok

TOGO

S.I.T.E.L.
Immeuble le General
Avenue General de Gaulle
P.O. Box 161

ABIDJAN 01
Ivory Coast
Tel: 32 12 27
Telex: 22149

Societe Africaine De Promotion
Immeuble Sageb
Rue d'Atakpame
P.O. Box 4150

LOME
Tel: 21-62-88
Telex: 5357

TRINIDAD & TOBAGO

Caribbean Telecoms Ltd.
P.O. Box 51
1 Taylor Street

PORT-OF-SPAIN
Tel: (809) 622-7719/622-7985
Tel: 38722798 COMCON WG
LOGOO AGENCY 1264

Computer and Controls Ltd.
P.O. Box 51
1 Taylor Street

PORT-OF-SPAIN
Tel: (809) 622-7719/622-7985
Tel: 38722798 COMCON WG
LOGOO AGENCY 1264

TUNISIA

Precision Electronique
5, rue de Chypre
Mutuelleville
1002 TUNIS BELVEDERE
Tunisia
Tel: 78 50 37
Tlx: 13238

TURKEY

E.M.A.
Mediha Etdem Sokak No. 41/6
Yenisehir
ANKARA
Tel: 131 4655, 131 9175
Telex: 46912n emsetr
Cable: EMATRADE ANKARA

Hewlett-Packard Bilgisayar Ve Olcum
Sistemleri A.S. (Headquarter)
Mesrutiyet Mah. 19 Mayıs Cad.
Nova-Baran Plaza Kat. 11-12
SISLI / ISTANBUL
Tel: 175 29 70
Telex: 39150
Fax: 175 29 92

Hewlett-Packard Bilgisayar Ve Olcum
Sistemleri A.S.
Paris Caddesi No 3
Diare 9
06670 **ANKARA**
Tel: 125 83 13
Telex: 46180
Fax: 125 47 45

UGANDA

Adcom Ltd, Inc. Kenya
P.O. Box 30070

Nairobi

Kenya
Tel: 33 19 55
Telex: 22639

UNITED ARAB EMIRATES

Emtac Ltd.
P.O. Box 1641
SHARJAH
Tel: 591181

Telex: 48710 EMITAC EM
Cable: EMITAC SHARJAH

Emtac Ltd.
P.O. Box 2711
ABU DHABI
Tel: 620419-20

Cable: EMITACH ABUDHABI

Emtac Ltd.
P.O. Box 8391
DUBAI
Tel: 377591

Emtac Ltd.
P.O. Box 473
RAS AL KHAMEH
Tel: 28133, 21270

UNITED KINGDOM

ENGLAND

Hewlett-Packard Ltd.
Customer Information Centre
King St. Lane
Winnersh, Wokingham
GB-BERKSHIRE RG11 5AR
Tel: (44/734) 784774
Telex: 847178
Fax: 777285

Hewlett-Packard Ltd.
Miller House
The Ring, **BRACKNELL**
Berkshire RG12 1XN
Tel: (44/344) 424-898

Fax: (44/344) 860015, Ext 56023

Hewlett-Packard Ltd.
Customer Sales & Support
Building 1, Filton Road
Stoke Gifford
BRISTOL, BS12 6OZ
Tel: (44/272) 236000

Hewlett-Packard Ltd.
Oakfield House, Oakfield Grove
Clifton **BRISTOL**, Avon BS8 2BN
Tel: 44-272-736 806
Telex: 444302

Hewlett-Packard Ltd.
9 Bredwell Place
LONDON EC4V 6BS
Tel: (44/583) 6565
Fax: (44/583) 6565, Ext 4713

Hewlett-Packard Ltd.
Heathside Park Rd.
Cheadle Heath, Stockport
GB-MANCHESTER SK3 0PB
Tel: (44/61) 428-0828
Telex: 668068
Fax: 4855009

Hewlett-Packard Ltd.
Harman House
No. 1 George St.
Uxbridge,
GB-MIDDLESEX UB8 1YH
Tel: (44/895) 72020

Telex: 893135
Fax: 73684

Hewlett-Packard Ltd.
Ponetract Road
NORMANTON,

West Yorkshire WF6 1RN
Tel: (44/924) 895-566
Fax: (44/924) 896-691
Telex: 557355

Hewlett-Packard Ltd.
The Quadrangle
105-118 Station Road
REDHILL, Surrey RH1 1PS
Tel: 44-737-686-55
Telex: 847234

Hewlett-Packard Ltd.
Avon House
435 Stratford Road
Shirley, **SOLIHULL**, West Midlands
B90 4BL
Tel: 44-21-745-8800
Telex: 339105

Hewlett-Packard Ltd.
Heathside Park Road
Cheshire SK3 0RB
Tel: (44/61) 428-0828
Fax: (44/61) 495-5009
Telex: 668068

Hewlett-Packard Ltd.
Harman House
No. 1 George Street
UXBRIDGE, Middlesex UB8 1YH
Tel: (44/895) 72020
Fax: (44/895) 73684

Hewlett-Packard Ltd.
King Street Lane
Winnersh, **WOKINGHAM**
Berkshire RG11 5AR
Tel: (44/734) 784774
Fax: (44/734) 777285 Ext 52285

NORTHERN IRELAND

Hewlett-Packard (Ireland) Ltd.
Carrickfergus Industrial Centre
75 Belfast Road, Carrickfergus
CO. ANTRIM BT38 8PM
Tel: 09603 67333

Unit 5
Bridgewood House
Newforge Lane
Malone Road
BELFAST BT95 NW
Tel: (353/232) 664-851
Fax: (353/232) 665-619

SCOTLAND

Hewlett-Packard Ltd.
1/3 Springburn Place
Collegie Milton North
EAST KILBRIDE, G74 5NU
Tel: 035-62-49261
Fax: 03552-35929
Telex: 779615

Hewlett-Packard Ltd.

SOUTH QUEENSFERRY
West Lothian, EH30 9TG
Tel: 031-331-1188
Fax: 031-331-7412

UNITED STATES

Hewlett-Packard Co.
Customer Information Center
Tel: (800) 752-0900
Hours: 6:00 AM to 5:00 PM
Pacific Time

Alabama

Hewlett-Packard Co.
2100 Riverchase Center
Building 100 - Suite 118
BIRMINGHAM, AL 35244
Tel: (205) 988-0547
Fax: (205) 988-5306

Hewlett-Packard Co.
620 Discovery Dr.
HUNTSVILLE, AL 35806
Tel: (205) 830-2000
Fax: (205) 830-1427

Alaska

Hewlett-Packard Co.
4000 Old Seward Highway
Suite 101
ANCHORAGE, AK 99503
Tel: (907) 563-8855
Fax: (907) 561-7409

Arizona

Hewlett-Packard Co.
8080 Pointe Parkway West
PHOENIX, AZ 85044
Tel: (602) 273-8000
Fax: (602) 273-8080

Hewlett-Packard Co.
3400 East Britannia Dr.
Bldg. C, Suite 124
TUCSON, AZ 85706
Tel: (602) 573-7400
Fax: (602) 573-7429

Arkansas

Hewlett-Packard Co.
10816 Executive Center Dr
Conway Bldg, Suite 116
LITTLE ROCK, AR 72211
Tel: (501) 225-7178
Fax: (501) 221-3614

California

Hewlett-Packard Co.
26701 W. Argoura Rd.
CALABASAS, CA 91302
Tel: (818) 880-3400
Fax: (818) 880-3437

Hewlett-Packard Co.
353 Lakeside Dr
POSTER CITY, CA 94404
Tel: (415) 378-8400
Fax: (415) 378-8405

Hewlett-Packard Co.
1907 North Gateway Blvd.
FRESNO, CA 93727
Tel: (209) 252-9652
Fax: (209) 456-9302

Hewlett-Packard Co.
1421 S. Manhattan Av.
FULLERTON, CA 92631
Tel: (714) 999-6700
Fax: (714) 778-3033

Hewlett-Packard Co.
7408 Hollister Ave. #A
GOLETA, CA 93117
Tel: (805) 685-6100
Fax: (805) 685-6163

Hewlett-Packard Co.
9800 Muirlando Ave.
IRVINE, CA 92718
Tel: (714) 472-3000
Fax: (714) 581-3607 (Direct Dial only)

Hewlett-Packard Co.
2525 Grand Avenue
LONG BEACH, CA 90815
Tel: (213) 498-1111
Fax: (213) 494-1986

Hewlett-Packard Co.
5651 West Manchester Ave.
LOS ANGELES, CA 90045
Tel: (213) 337-8000
Fax: (213) 337-8338

Hewlett-Packard Co.
321 E. Evelyn Ave.
Bldg. 330
MOUNTAIN VIEW, CA 94039
Tel: (415) 694-2000
Fax: (415) 694-0600

Hewlett-Packard Co.
5161 Lankershim Blvd.
NORTH HOLLYWOOD, CA 91601
Tel: (818) 505-5600
Fax: (818) 505-5875

Hewlett-Packard Co.
5725 W. Las Positas Blvd.
PLEASANTON, CA 94566
Tel: (415) 460-0282
Fax: (415) 460-0713

Hewlett-Packard Co.
4244 So. Market Court, Suite A
SACRAMENTO, CA 95834
Tel: (916) 929-7222
Fax: (916) 927-7152

Hewlett-Packard Co.
9606 Aero Drive
SAN DIEGO, CA 92123
Tel: (619) 279-3200
Fax: (619) 268-8487

Hewlett-Packard Co.
50 Fremont St., Suite 200
SAN FRANCISCO, CA 94 105
Tel: (415) 882-6800
Fax: (415) 882-6805

Hewlett-Packard Co.
3003 Scott Boulevard
SANTA CLARA, CA 95054
Tel: (408) 988-7000
Fax: (408) 988-7100

Hewlett-Packard Co.
5280 Valentine Rd., Suite 205
VENTURA, CA 93003
Tel: (805) 658-6898
Fax: (805) 650-0721

Colorado

Hewlett-Packard Co.
2945 Center Green Court South
Suite A
BOULDER, CO 80301
Tel: (303) 938-3065
Fax: (303) 938-3025

Hewlett-Packard Co.
24 Inverness Plaza, East
ENGLEWOOD, CO 80112
Tel: (303) 649-5000
Fax: (303) 649-5787

Connecticut

Hewlett-Packard Co.
3 Parkland Dr.
DARLEN, CT 06820
Tel: (203) 656-0040
Fax: (203) 656-5563

Hewlett-Packard Co.
115 Glastonbury Blvd
GLASTONBURY, CT 06033
Tel: (203) 633-8100
Fax: (203) 659-6087

Florida

Hewlett-Packard Co.
5900 N. Andrews, Suite 100
FORT LAUDERDALE, FL 33309
Tel: (305) 938-9800
Fax: (305) 938-2293

Hewlett-Packard Co.
6800 South Point Parkway
Suite 301
JACKSONVILLE, FL 32216
Tel: (904) 636-9955
Fax: (904) 636-9955

Hewlett-Packard Co.
255 East Drive, Suite B
MELBOURNE, FL 32901
Tel: (407) 729-0704
Fax: (407) 723-4557

Hewlett-Packard Co.
6177 Lake Ellenor Drive
ORLANDO, FL 32809
Tel: (407) 858-2900
Fax: (407) 826-9009

Hewlett-Packard Co.
4700 Bayou Blvd.
Building 5
PENSACOLA, FL 32503
Tel: (904) 476-8422
Fax: (904) 476-4116

Hewlett-Packard Co.
5550 Idlewild, #150
TAMPA, FL 33634
Tel: (813) 884-3282
Fax: (813) 889-4445

Georgia

Hewlett-Packard Co.
2015 South Park Place
ATLANTA, GA 30339
Tel: (404) 955-1500
Fax: (404) 980-7669

Hewlett-Packard Co.
3607 Parkway Lane
Suite 300
MORCROSS, GA 30092
Tel: (404) 448-1894
Fax: (404) 246-5206

Hawaii

Hewlett-Packard Co.
Pacific Tower
1001 Bishop St.
Suite 2400
HONOLULU, HI 96813
Tel: (808) 526-1555
Fax: (808) 536-7873

Idaho

Hewlett-Packard Co.
11309 Chinden Blvd
BOISE, ID 83714
Tel: (208) 323-2700
Fax: (208) 323-2528

Illinois

Hewlett-Packard Co.
2205 E. Empire St.
BLOOMINGTON, IL 61704
Tel: (309) 662-9411
Fax: (309) 662-0351

Hewlett-Packard Co.
525 W. Monroe St., Suite 1308
CHICAGO, IL 60606
Tel: (312) 930-0010
Fax: (312) 930-0986

Hewlett-Packard Co.
1200 East Diehl Road
NAPERVILLE, IL 60566
Tel: (312) 357-8800
Fax: (312) 357-9896

Hewlett-Packard Co.
5201 Tollview Drive
ROLLING MEADOWS, IL 60008
Tel: (312) 255-9800
Fax: (312) 259-5878

Indiana

Hewlett-Packard Co.
11911 N. Meridian St.
CARMEL, IN 46032
Tel: (317) 844-4100
Fax: (317) 843-1291

Hewlett-Packard Co.
111 E. Ludwig Road
Suite 106
FT. WAYNE, IN 46825
Tel: (219) 482-4283
Fax: (219) 482-9907

Iowa

Hewlett-Packard Co.
4050 River Center Court
CEDAR RAPIDS, IA 52402
Tel: (319) 393-0606
Fax: (319) 378-1024

Hewlett-Packard Co.
4201 Corporate Dr.
WEST DES MOINES, IA 50265
Tel: (515) 224-1435
Fax: (515) 224-1870

Kansas

Hewlett-Packard Co.
North Rock Business Park
3450 N. Rock Rd.
Suite 300
WICHITA, KS 67226
Tel: (316) 636-4040
Fax: (316) 636-4504

Kentucky

Hewlett-Packard Co.
305 N. Hurstbourne Lane,
Suite 100
LOUISVILLE, KY 40222
Tel: (502) 426-0100
Fax: (502) 426-0322

Louisiana

Hewlett-Packard Co.
160 James Drive East
ST. ROSE, LA 70087
Tel: (504) 467-4100
Fax: (504) 467-4100 x 291

Maryland

Hewlett-Packard Co.
3701 Koppers Street
BALTIMORE, MD 21227
Tel: (301) 644-5800
Fax: (301) 362-7650

Hewlett-Packard Co.
2 Choke Cherry Road
ROCKVILLE, MD 20850
Tel: (301) 948-6370
Fax: (301) 948-5986

Massachusetts

Hewlett-Packard Co.
1775 Minuteman Road
ANDOVER, MA 01810
Tel: (508) 682-1500
Fax: (508) 794-2619

Hewlett-Packard Co.
29 Burlington Mall Rd.
BURLINGTON, MA 01803-4514
Tel: (617) 270-7000
Fax: (617) 221-5240

Michigan

Hewlett-Packard Co.
3033 Orchard Vista S.E.
GRAND RAPIDS, MI 49546
Tel: (616) 957-1970
Fax: (616) 956-9022

Hewlett-Packard Co.
39550 Orchard Hill Place Drive
NOVI, MI 48050
Tel: (313) 349-9200
Fax: (313) 349-9240

Hewlett-Packard Co.
560 Kirts Rd.
Suite 101
TROY, MI 48064
Tel: (313) 362-5180
Fax: (313) 362-3028

Minnesota

Hewlett-Packard Co.
2025 W. Larpenster Ave.
ST. PAUL, MN 55113
Tel: (612) 644-1100
Fax: (612) 641-9787

Mississippi

Hewlett-Packard Co.
800 Woodland Parkway, Suite 101
RIDGELAND, MS 39157
Tel: (601) 957-0730
Fax: (601) 957-2515

Missouri

Hewlett-Packard Co.
13001 Hollenberg Drive
BRIDGETON 63044
Tel: (314) 344-5100
Fax: (314) 344-5273

Hewlett-Packard Co.
6601 Winchester Ave.
KANSAS CITY, MO 64133
Tel: (816) 737-0071
Fax: (816) 737-4690

Montana

Hewlett-Packard Co.
13001 Hollenberg Drive
BRIDGETON, MT 63044
Tel: (314) 344-5100
Fax: (314) 344-5273

Nebraska

Hewlett-Packard
11626 Nicholas St.
OMAHA, NE 68154
Tel: (402) 493-0300
Fax: (402) 493-4334

New Jersey

Hewlett-Packard Co.
120 W. Century Road
PARAMUS, NJ 07653
Tel: (201) 599-5000
Fax: (201) 599-5382

Hewlett-Packard Co.
10 Sylvan Way
PARSIPPANY, NJ 07054
Tel: (201) 682-4000
Fax: (201) 682-4031

Hewlett-Packard Co.
20 New England Av.
PISCATAWAY, NJ 08854
Tel: (201) 562-6100
Fax: (201) 562-6246

New Mexico

Hewlett-Packard Co.
7801 Jefferson N.E.
ALBUQUERQUE, NM 87109
Tel: (505) 823-6100
Fax: (505) 823-1243

Hewlett-Packard Co.
1362-C Trinity Dr.
LOS ALAMOS, NM 87544
Tel: (505) 662-6700
Fax: (505) 662-4312

New York

Hewlett-Packard Co.
5 Computer Drive South
ALBANY, NY 12205
Tel: (518) 458-1550
Fax: (518) 458-1550 x 0390

Hewlett-Packard Co.
130 John Muir Dr
AMHERST, NY 14226
Tel: (716) 669-3003
Fax: (716) 636-7034

Hewlett-Packard Co.
200 Cross Keys Office Park
FAIRPORT, NY 14450
Tel: (716) 223-9950
Fax: (716) 223-6331

Hewlett-Packard Co.
7641 Henry Clay Blvd
LIVERPOOL, NY 13088
Tel: (315) 451-1820
Fax: (315) 451-1820 x 255

Hewlett-Packard Co.
No. 1 Pennsylvania Plaza
55th Floor
34th Street & 7th Avenue
MANHATTAN NY 10119
Tel: (212) 971-0800
Fax: (212) 330-8967

Hewlett-Packard Co.
2975 Westchester Ave
PURCHASE, NY 10577
Tel: (914) 935-6300
Fax: (914) 935-6497

Hewlett-Packard Co.
Executive Square Office Bldg.
66 Middlebush Rd.
WAPPINGERS FALLS, NY 12590
Tel: (914) 298-9125
Fax: (914) 298-9154

Hewlett-Packard Co.
3 Crossways Park West
WOODBURY, NY 11797
Tel: (516) 662-7800
Fax: (516) 682-7806 (2)

Hewlett-Packard Co.
305 Gregson Dr.
CARY, NC 27511
Tel: (919) 467-6600
Fax: (919) 460-2296
(919) 460-2297

Hewlett-Packard Co.
P.O. Box 240318
CHARLOTTE, NC 28224
Tel: (704) 527-8780
Fax: (704) 523-7857

Hewlett-Packard Co.
7029 Albert Pick Rd. #100
GREENSBORO, NC 27409
Tel: (919) 665-1800
Fax: (919) 668-1797

Mailing Address
PO Box 26500
Greensboro, NC 27426

Hewlett-Packard Co.
2717 S. Arlington Rd.
AKRON 44312
Tel: (216) 644-2270
Fax: (216) 644-7415

Hewlett-Packard Co.
4501 Erskine Road
CINCINNATI, OH 45242
Tel: (513) 891-9870
Fax: (513) 891-0033

SALES OFFICES

Arranged alphabetically by country (cont'd)

UNITED STATES (Cont'd)

Hewlett-Packard Co.
Moutroffe West Ave.
COPLEY, OH 44321
Tel: (216) 666-7711
Fax: (216) 666-6054

Hewlett-Packard Co.
7867 Washington Village Dr.
DAYTON, OH 45459
Tel: (513) 433-2223
Fax: (513) 433-8633

Hewlett-Packard Co.
9080 Springboro Pike
MIAMISBURG 45342
Tel: (513) 433-2223
Fax: (513) 433-3633

Hewlett-Packard Co.
15885 Sprague Road
STROGVILLE, OH 44136
Tel: (216) 243-7300
Fax: (216) 234-7230

Hewlett-Packard Co.
One Maritime Plaza, 5th Floor
720 Water Street
TOLEDO, OH 43604
Tel: (419) 242-2200
Fax: (419) 241-7655

Hewlett-Packard Co.
675 Brookseage Blvd.
WESTERVILLE, OH 43081
Tel: (614) 891-3344
Fax: (614) 891-1476

Oklahoma

Hewlett-Packard Co.
3525 N.W. 56th St.
Suite C-100
OKLAHOMA CITY, OK 73112
Tel: (405) 946-9499
Fax: (405) 942-2127

Hewlett-Packard Co.
6655 South Lewis,
Suite 105
TULSA, OK 74136
Tel: (918) 481-6700
Fax: (918) 481-2250

Oregon

Hewlett-Packard Co.
9255 S. W. Pioneer Court
WILSONVILLE, OR 97070
Tel: (503) 682-8000
Fax: (503) 682-8155

Pennsylvania

Hewlett-Packard Co.
Heatherwood Industrial Park
50 Dorchester Rd.
P.O. Box 6080
HARRISBURG, PA 17112
Tel: (717) 657-5900
Fax: (717) 657-5946

Hewlett-Packard Co.
111 Zeta Drive
PITTSBURGH, PA 15238
Tel: (412) 782-0400
Fax: (412) 963-1300

Hewlett-Packard Co.
2750 Monroe Boulevard
VALLEY FORGE, PA 19482
Tel: (215) 666-9000
Fax: (215) 666-2034

South Carolina

Hewlett-Packard Co.
Brookside Park, Suite 122
1 Harbison Way
COLUMBIA, SC 29212
Tel: (803) 732-0400
Fax: (803) 732-4567

Hewlett-Packard Co.
545 N. Pleasantburg Dr.
Suite 100
GREENVILLE, SC 29607
Tel: (803) 232-8002
Fax: (803) 232-8739

Tennessee

Hewlett-Packard Co.
One Energy Center, Suite 200
Mississippi Pkwy.
KNOXVILLE, TN 37932
Tel: (615) 966-4747
Fax: (615) 966-8147

Hewlett-Packard Co.
889 Ridge Lake Blvd.,
Suite 100
MEMPHIS, TN 38119
Tel: (901) 763-4747
Fax: (901) 762-9723

Hewlett-Packard Co.
44 Vantage Way,
Suite 160
NASHVILLE, TN 37228
Tel: (615) 255-1271
Fax: (615) 726-2310

Texas

Hewlett-Packard Co.
9050 Capital of Texas Highway, North
#290
AUSTIN, TX 78759
Tel: (512) 346-3855
Fax: (512) 338-7201

Mailing Address
PO Box 9431
Austin, TX 78766-9430

Hewlett-Packard Co.
5700 Cromo Dr.
EL PASO, TX 79912
Tel: (915) 833-4400
Fax: (915) 581-8097

Hewlett-Packard Co.
10535 Harwin Drive
HOUSTON, TX 77038
Tel: (713) 776-6400
Fax: (713) 776-6495

Hewlett-Packard Co.
3301 West Royal Lane
IRVING, TX 75063
Tel: (214) 869-3377
Fax: (214) 830-8951

Hewlett-Packard Co.
109 E. Toronto, Suite 100
MALLEN, TX 78503
Tel: (512) 630-3030
Fax: (512) 630-1355

Hewlett-Packard Co.
930 E. Campbell Rd.
RICHARDSON, TX 75081
Tel: (214) 231-6101
Fax: (214) 699-4337

Hewlett-Packard Co.
14100 San Pedro Ave., Suite 100
SAN ANTONIO, TX 78232
Tel: (512) 494-9336
Fax: (512) 491-1299

Utah

Hewlett-Packard Co.
3530 W. 2100 South
SALT LAKE CITY, UT 84119
Tel: (801) 974-1700
Fax: (801) 974-1780

Virginia

Hewlett-Packard Co.
840 Greenbrier Circle
Suite 101
CHESAPEAKE, VA 23320
Tel: (804) 424-7105
Fax: (804) 424-1494

Hewlett-Packard Co.
4401 Water Front Dr.
GLEN ALLEN, VA 23060
Tel: (804) 747-7750
Fax: (804) 965-9297

Hewlett-Packard Co.
2800 Electric Road Suite 100
ROANOKE, VA 24018
Tel: (703) 774-3444
Fax: (703) 989-8049

Washington

Hewlett-Packard Co.
15815 S.E. 37th Street
BELLEVUE, WA 98006
Tel: (206) 843-4000
Fax: (206) 843-8748

Hewlett-Packard Co.
N. 1225 Argonne Rd
SPOKANE, WA 99212-2657
Tel: (509) 922-7000
Fax: (509) 927-4236

West Virginia

Hewlett-Packard Co.
501 56th Street
CHARLESTON, WV 25304
Tel: (304) 925-0492
Fax: (304) 925-1910

Wisconsin

Hewlett-Packard Co.
275 N. Corporate Dr.
BROOKFIELD, WI 53005
Tel: (414) 792-8800
Fax: (414) 792-0218

URUGUAY

Pablo Ferrando S.A.C. e.l.
Avenida Italia 2877
Casilla de Correo 370
MONTEVIDEO
Tel: 59-82-802-586
Telex: 398802586

Olympia de Uruguay S.A.
Maquinas de Oficina
Avda. del Libertador 1997
Casilla de Correo 6644
MONTEVIDEO
Tel: 91-1809, 98-3807
Telex: 6342 OROU UY

VENEZUELA

Analytical Supplies, CA
Quinta #103 Impermes
Av El Centro
Los Chorros
Apartado 75472
CARACAS
Tel: 364904, 2394047
Telex: 26274 CABIC

Hewlett-Packard de Venezuela C.A.
Residencias Tria Betty Local 1
Avenida 3 Y con Calle 75
MARACAYO, Estado Zulia
Apartado 2646
Tel: 586175669
Telex: 62464 HPMAR

YUGOSLAVIA

Do Hermes
General Zdanova 4
YU-11000 **BEOGRAD**
Tel: (011) 342 641
Telex: 11433

Do Hermes
Celovska 73
YU-61000 **LJUBLJANA**
Tel: (061) 553 170
Telex: 31583

ZAIRE

C.I.E.
Computer & Industrial Engineering
25 Ave. de la Justice Gombe
Boite Postale 10976
KINSHASA
Tel: 32 063, 32 633, 28 251
Telex: 21552
Fax: 22 850

ZAMBIA

R.J. Tibury (Zambia) Ltd.
P.O. Box 32792
LUSAKA
Tel: 21 55 80
Telex: 40128

ZIMBABWE

Field Consolidated (Private) Ltd.
Systron Division
Manhattan Court
61 Second Street
P.O. Box 3458
HARARE
Tel: 73 98 81
Telex: 26241
Fax: 70 20 08

Please send directory corrections to:
Test & Measurement Catalog
Hewlett-Packard Company
3200 Hillview Avenue
Palo Alto, CA 94304
Tel: (415) 857-4706
Fax: (415) 857-3880

September 1989

Installing Your Datacom Manual

Follow the instructions given below to install this manual into the binder containing your T1 Tester manual.

1. Remove the existing spine insert from the T1 Tester binder and replace it with the spine insert contained in this package.
2. Move the current binder contents over the *D* rings onto the curved side of the *D*.
3. Open the ring mechanism by pulling it apart.
4. Add the contents of this package to the ring binder at the back of the T1 Tester manual then close the ring binder mechanism.

The binder contents now cover operation and calibration of both the T1 Tester and Datacom Tester.

