

# Agilent 82357A

USB/GPIB Interface Converter

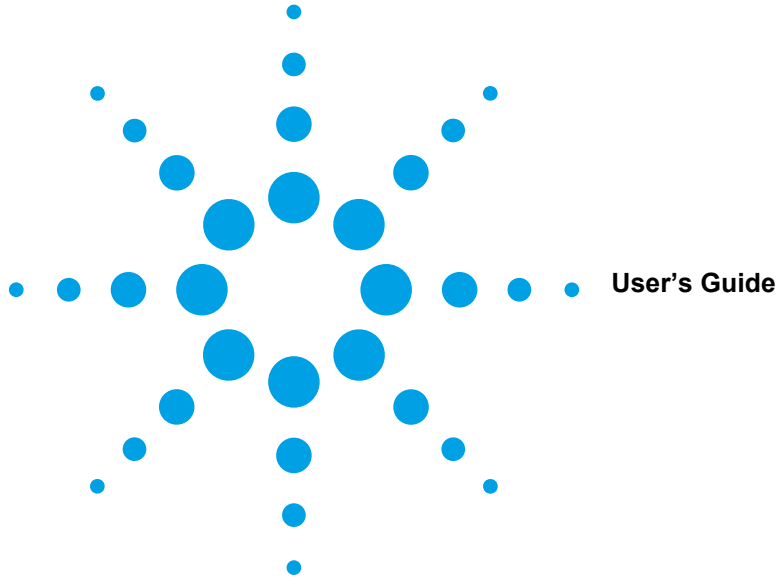

Agilent Technologies



# Contents

## 82357A USB/GPIB Interface Converter User's Guide

<b>Chapter 1 - Installing the 82357A .....</b>	<b>5</b>
Steps to Install the 82357A.....	7
Step 1: Before You Install the 82357A.....	8
Check Your Shipment .....	8
Check System Requirements .....	9
Step 2: Installing Agilent IO Libraries Suite .....	10
Checking for Installed Agilent IO Libraries .....	10
Installing Agilent IO Libraries Suite .....	11
Step 3: Connecting the 82357A.....	13
82357A Hardware Description .....	13
Connecting the 82357A to Your PC .....	14
Connecting the 82357A to a USB Hub .....	15
Observing Windows Plug and Play Manager Sequence (Windows XP Only) .....	17
Step 4: Configuring the 82357A.....	21
Setting 82357A Default Configuration .....	21
Setting 82357A Custom Configuration .....	24
Step 5: Connecting GPIB Instruments.....	27
Connecting a Single GPIB Instrument .....	27
Connecting Multiple GPIB Instruments .....	28
Step 6: Programming via the 82357A.....	29
Establishing Instrument Communication .....	29
Programming GPIB Instruments .....	30
<b>Chapter 2 - Using the 82357A .....</b>	<b>33</b>
Modes of Operation .....	35
Initial 82357A Operating States .....	35
Introduction to 82357A Operating Modes .....	36
Single 82357A Operation .....	37
Multiple 82357A Operation .....	38
SRQ Operation .....	38
Setting Configuration Parameters.....	39
Changing Configuration Parameters .....	39
Changing Modes of Operation .....	40
Setting Timeout Floor Values .....	40
Setting 82357A High-Performance Operation .....	41
<b>Chapter 3 - Troubleshooting the 82357A .....</b>	<b>43</b>
Troubleshooting Flowchart .....	45
Hardware Checks .....	47

Check USB Cables, USB Interface, Host PC .....	47
Reboot the PC .....	47
Check Device Manager .....	48
Software Installation Checks .....	49
Check Suspend/Resume Operation .....	49
Verify Agilent IO Libraries Suite Installation .....	49
Verify 82357A USB Driver Installation .....	51
Software Configuration Checks .....	52
Checking IO Control Operation .....	52
Check USB Scanner .....	53
Check for usbscan.sys (Windows 98 SE Only) .....	54
Service/Support Information .....	56
82357A Service Information .....	56
Contacting Agilent .....	56
<b>Chapter 4 - 82357A User's Guide Information .....</b>	<b>57</b>
Guide Contents.....	59
Guide General Information .....	60
<b>Appendix A - 82357A Specifications .....</b>	<b>63</b>
Technical Specifications .....	65
Supplementary Information .....	66
<b>Index .....</b>	<b>67</b>

---

**Installing the 82357A**

---

---

## Installing the 82357A

This *Agilent 82357A USB/GPIB Interface Converter User's Guide* shows how to install and configure the Agilent 82357A USB/GPIB Interface Converter for PCs with Windows 98 (SE), Windows Me, Windows 2000, or Windows XP Professional operating systems.

**NOTE**

*The 82357A USB/GPIB Interface Converter is supported ONLY for PCs with Windows 98 (Second Edition), Windows Me, Windows 2000, or Windows XP Professional operating systems.*

*These operating systems are specifically not supported:*

*Windows 98 First ("Gold") Edition*

*Windows 95*

*Windows NT 4.0 (OS does not support USB)*

*In case of difficulty in installing the 82357A, see Chapter 3 - Troubleshooting the 82357A. See Chapter 4 - 82357A User Guide Information for guide contents and general guide information.*

This chapter shows suggested steps to install the 82357A, including:

- Steps to Install the 82357A
- Step 1: Before You Install the 82357A
- Step 2: Installing the Agilent IO Libraries Suite
- Step 3: Connecting the 82357A
- Step 4: Configuring the 82357A
- Step 5: Connecting GPIB Instruments
- Step 6: Programming via the 82357A

---

## Steps to Install the 82357A

This figure shows a suggested sequence of steps to install and configure the 82357A and to communicate between your PC and GPIB instruments.

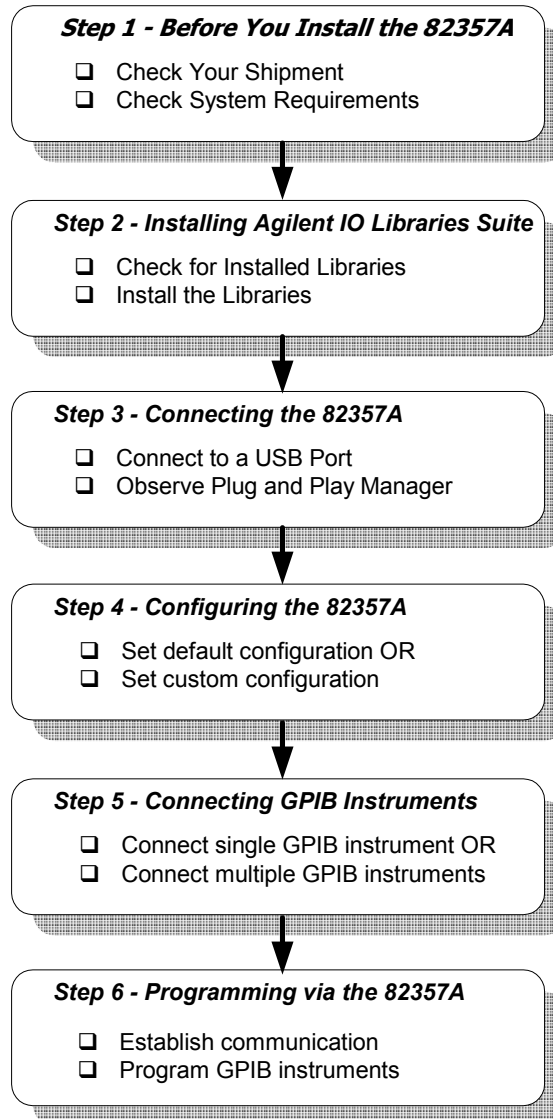

**Step 1: Before You Install the 82357A****Step 1: Before You Install the 82357A**

Before you install the 82357A, you should:

- Check Your Shipment
- Check System Requirements

**Check Your Shipment**

Your 82357A USB/GPIB Interface Converter shipment should include the items in the following figure. If any items are missing or damaged, keep the shipping materials and contact Agilent Technologies. See “*Contacting Agilent*” on page 56 for addresses and telephone numbers.

As you check the shipment items, verify that the 82357A Serial Number on the bottom of the 82357A matches the Serial Number shown on the Serial Number Label on the 82357A Kit Box and on the 82357A Certificate of Calibration. If the Serial Numbers do not match, contact Agilent. If all Serial Numbers match, you may want to record the Serial Number for future reference.

- *Agilent Technologies 82357A USB/GPIB Interface Converter*
- *Agilent Automation-Ready CD with Agilent IO Libraries Suite*
- *82357A USB/GPIB Interface Converter Getting Started Poster*
- *82357A USB/GPIB Interface Converter User's Guide*
- *82357A Registration Card*
- *Software License Agreement*

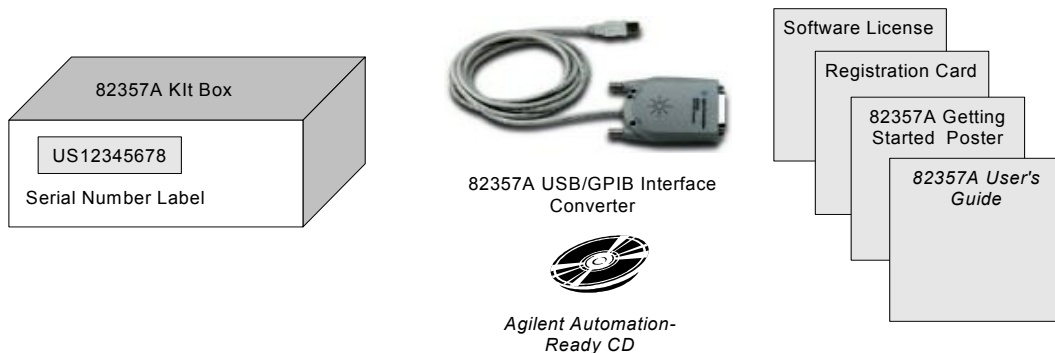

## Check System Requirements

Before you install the Agilent IO Libraries Suite, you should verify that your system meets the **minimum** hardware and software requirements listed to install and use the software. Adding additional RAM may improve overall system performance.

### NOTE

*The 82357A USB/GPIB Interface Converter is supported ONLY on Windows 98 Second Edition, Windows Me, Windows 2000, and Windows XP Professional.*

Item	Minimum Requirements
<b>Hardware Requirements</b>	
PC Operation/ Memory	200 MHz Pentium II (800 MHz recommended) and 64 MBytes RAM (96 MB recommended).
Hard Drive Space	215 MB for installation: 160 MB for Microsoft .NET Framework, 55 MB for Agilent IO Libraries Suite 125 MB for operation: 70 MB for Microsoft .NET Framework, 55 MB for Agilent IO Libraries Suite
USB Port	At least one USB port (to connect 82357A)
<b>Software Requirements</b>	
Operating System	Windows 98 SE, Windows Me, Windows 2000 (Service Pack 4 or later), or Windows XP Professional (Service Pack 1 or later).
Agilent IO Libraries	Agilent IO Libraries Version L.01.00 or greater, or Agilent IO Libraries Suite Version 14.0 or greater.

### NOTE

*For Windows 98 Second Edition, you may need to install usbscan.sys, located on the Windows 98 CD-ROM. See "Check for usbscan.sys (Windows 98 SE Only)" in Chapter 3 - Troubleshooting the 82357A for details.*

**Step 2: Installing Agilent IO Libraries Suite****Step 2: Installing Agilent IO Libraries Suite**

This step shows how to install the Agilent IO Libraries Suite, using default settings, including:

- Checking for Installed Agilent IO Libraries or Agilent IO Libraries Suite
- Installing Agilent IO Libraries Suite

**NOTE**

*See the Agilent IO Libraries Getting Started Guide on your Automation-Ready CD for a full description of installation options and installation troubleshooting information.*

**NOTE**

*You must have Administrator privileges to install the IO Libraries Suite and to run the Connection Expert utility.*

**Checking for Installed Agilent IO Libraries**

Before you begin installation, check for previously installed Agilent IO Libraries software. If a version of the Agilent IO Libraries or Agilent IO Libraries Suite is installed on your PC, a blue IO icon may be displayed on the Windows taskbar (on the lower right-hand side of the screen).

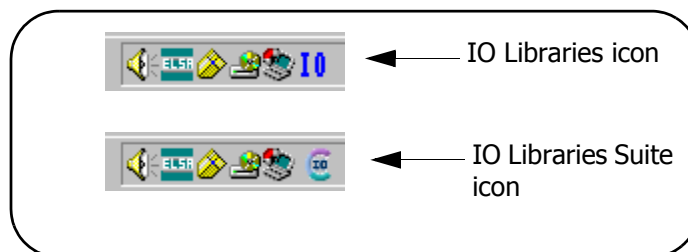

- If either IO icon is displayed, click the icon and click **About Agilent IO Libraries Control** to display the version. The version must be L.01.00 or greater. Note that Agilent IO Libraries Suite 14.0 was the revision

immediately following Agilent IO Libraries M.01.01, so you should consider revision “14.0” to be a greater version number than “L” or “M”.

- If the IO icon is not displayed, a version may still be installed. To check this, click **Start | Programs** and look for the **Agilent IO Libraries** or **Agilent IO Libraries Suite** program group.
- If this group is displayed, click **Agilent IO Libraries | IO Control** to display the IO icon. Then, click the icon and click **About Agilent IO Libraries Control** to display the installed version (must be L.01.00 or greater, inclusive of 14.0 or greater).
- If neither the IO icon nor the Agilent IO Libraries program group is displayed, no Agilent IO Libraries are installed and you can use the steps in this chapter and in the *Agilent IO Libraries Suite Getting Started Guide* to install the libraries.
- If the version of the Agilent IO Libraries is less than L.01.00, you must install the newer version included on your *Automation-Ready CD* to support the 82357A.
- If your version of the Agilent IO Libraries is at least L.01.00, but less than the version on your *Automation-Ready CD*, you may want to install the newer version to take advantage of new features and greater ease of use of the more recent Agilent IO Libraries Suite. Note that Agilent IO Libraries Suite 14.0 was the revision immediately following Agilent IO Libraries M.01.01, so you should consider revision “14.0” to be a greater version number than “L” or “M”. Configuration instructions in this manual make use of Agilent IO Libraries Suite 14.0.

## Installing Agilent IO Libraries Suite

To install the Agilent IO Libraries Suite software,

- 1** First, *disconnect* any USB instruments, USB/GPIB converters, and FireWire-VXI interfaces that are connected to your PC.
- 2** Insert the *Automation-Ready CD* in your CD-ROM drive. Wait a few seconds for the auto-run window to appear.

**Step 2: Installing Agilent IO Libraries Suite**

- 3** If the auto-run window does not appear automatically,
  - Click **Start | Run...**
  - Type <drive>:autorun\auto.exe, where <drive> is your CD drive letter.
  
- 4** When the auto-run window appears, follow the directions in this window to install the Agilent IO Libraries Suite. (See the Agilent IO Libraries Getting Started Guide on your Automation-Ready CD for a full description of installation options and installation troubleshooting information.)

---

## Step 3: Connecting the 82357A

After the Agilent IO Libraries (Version L.01.00 or later) have been installed, you can connect the 82357A to any USB port on your PC or you can connect the 82357A via standard USB hubs. This step includes:

- 82357A Hardware Description
- Connecting the 82357A to Your PC
- Connecting the 82357A to a USB Hub
- Observing Windows Plug and Play Manager (Windows XP)

### NOTE

*If the Agilent IO Libraries or Agilent IO Libraries Suite has not been installed on your PC, **STOP**. Install the libraries (see Step 2: Installing the Agilent IO Libraries Suite) and then return to this step.*

### NOTE

*For Windows 98 Second Edition, you may need to install `usbscan.sys`, located on the Windows 98 CD-ROM. See “Check for `usbscan.sys` (Windows 98 SE Only)” in Chapter 3 - Troubleshooting the 82357A for details.*

## 82357A Hardware Description

The Agilent 82357A USB/GPIB Interface Converter (82357A) provides a direct interface connection from the USB port on your PC to GPIB instruments. The 82357A includes an attached USB cable that is USB 1.1 compliant. This cable is shielded and the connector is specified for up to 1,500 insertions.

An 82357A can be directly connected to a single GPIB instrument or can be connected to up to 14 GPIB instruments via GPIB cables. In addition, several 82357As can be connected to your PC via standard USB hubs. The following figure shows main 82357A hardware features.

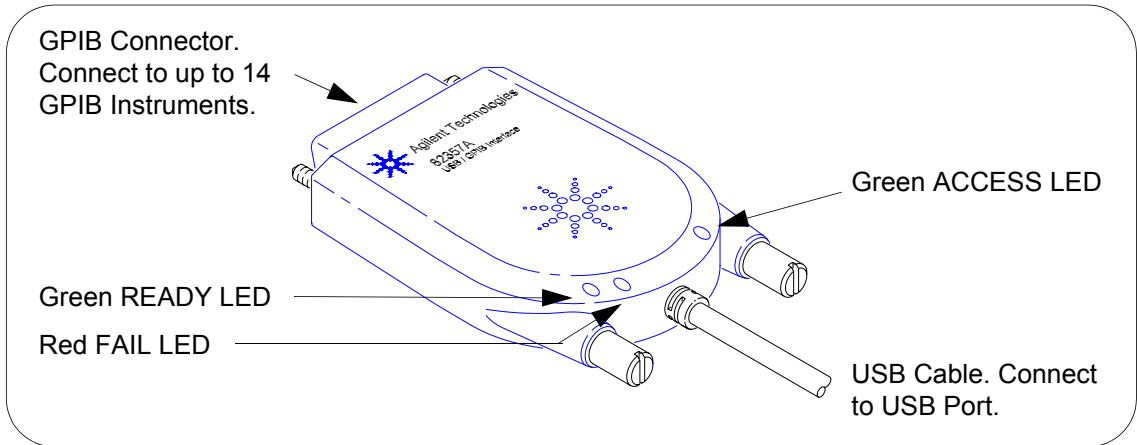

## Connecting the 82357A to Your PC

This section shows steps to connect the 82357A to a USB port on your PC or to connect to your PC via a USB Hub.

- 1 Connect to a USB Port.** Make sure the PC is ON and plug the 82357A USB cable into any available USB port on your PC. Do not connect the 82357A to GPIB instruments at this time.

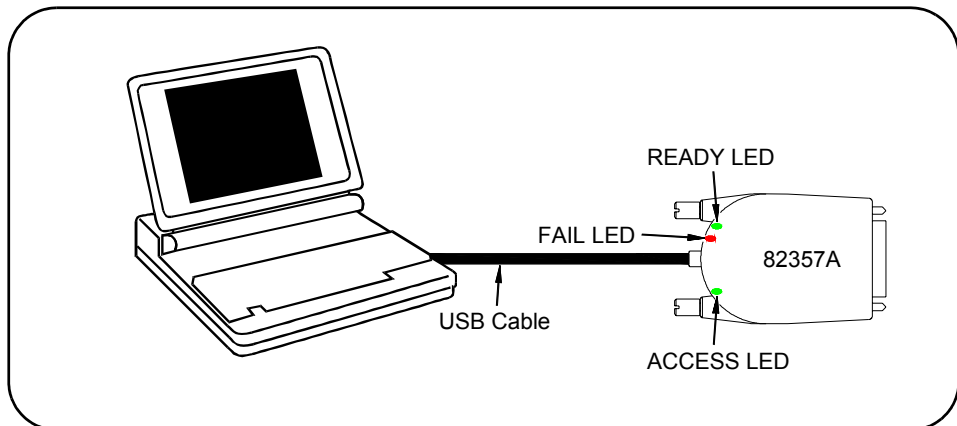

- 2 **Observe the LEDs.** Observe the LEDs on the 82357A for at least 10 seconds. See *Chapter 2 - Using the 82357A* for a description of the normal LED sequence with an initial installation of an 82357A.
  - a Initially, only the red FAIL LED should be ON. After a few seconds, all three LEDs should be ON. All three LEDs ON shows the 82357A has been successfully installed, but is not yet configured for use with the Agilent IO Libraries Suite.
  - b If all three LEDs are *not* ON after 10 seconds and all Windows Plug and Play Manager activity has ceased, **STOP**. See *Chapter 3 - Troubleshooting the 82357A* for diagnostics information.
  - c If all three LEDs are *still* ON after 10 seconds, go to “Observing Windows Plug and Play Manager Sequence (Windows XP Only)”.

## Connecting the 82357A to a USB Hub

This section shows steps to connect the 82357A to a USB port on your PC via a standard USB hub.

### NOTE

*Any USB hub used with the 82357A MUST be **self-powered** (must not be bus-powered or powered from the USB bus). Also, be sure to check the applicable USB hub documentation for hub operating parameters, such as power requirements and maximum length of USB cables.*

- 1 Plug the power adapter into the hub and into an electrical outlet. Make sure the hub is operating in self-powered mode. For example, the following figure shows a 4-port self-powered USB hub with two 82357A USB/GPIB Interface Converters connected.
- 2 Make sure your PC is ON. Connect the USB cable of the USB hub to any available USB port on your PC.
- 3 Plug at least one 82357A USB/GPIB Interface Converter into the port(s) on the USB hub. It is not necessary to connect GPIB instruments to any 82357A at this time.

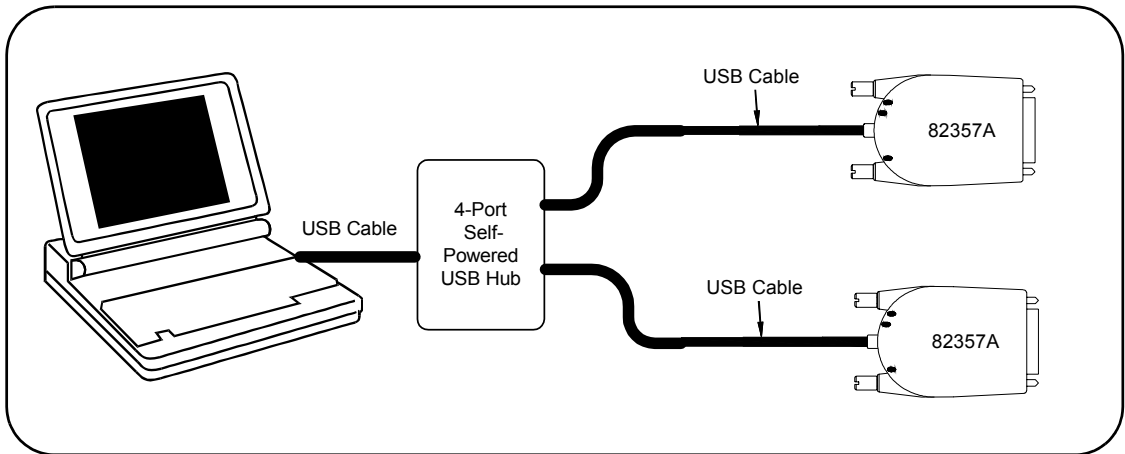

- 4 Observe the LEDs.** Observe the LEDs on the 82357A for at least 10 seconds. See *Chapter 2 - Using the 82357A* for a description of the normal LED sequence with an initial installation of an 82357A.
  - a** Initially, only the red FAIL LED should be ON. After a few seconds, all three LEDs should be ON. All three LEDs ON shows the 82357A has been successfully installed, but is not yet configured for use with the Agilent IO Libraries.
  - b** If all three LEDs are *not* ON after 10 seconds and all Windows Plug and Play Manager activity has ceased, **STOP**. See *Chapter 3 - Troubleshooting the 82357A* for diagnostics information.
  - c** If all three LEDs are *still* ON after 10 seconds, go to “Observing Windows Plug and Play Manager Sequence (Windows XP Only)”.

## Observing Windows Plug and Play Manager Sequence (Windows XP Only)

When an 82357A is first plugged into a USB port, for Windows XP ONLY, a Windows Plug and Play Manager installation sequence may be displayed.

### NOTE

*This section shows typical displays for a Windows XP Professional operating system ONLY. Similar displays may appear for Windows 98 SE, Windows 2000, or Windows Me operating systems.*

### Introduction

The following sequence only appears when an 82357A is initially plugged into a USB port. The sequence appears each time an 82357A with a new serial number is installed or when an 82357A is installed in a new USB port.

For example, if an 82357A with Serial Number US12345678 is initially plugged into USB port #1, the sequence may appear. If this 82357A is configured using the sequence, the next time this 82357A is plugged into USB port #1, the sequence will not appear.

However, if another 82357A is plugged into USB port #1 or if the 82357A with Serial Number US12345678 is initially plugged into USB port #2, the sequence may also appear.

### NOTE

*The displays in the following sequence assume you have installed the Agilent IO Libraries Suite as shown in Step 2 - Installing Agilent IO Libraries Suite. If you have not installed the libraries, STOP and do Step 2 before continuing.*

Typical Windows  
Plug and Play  
Manager Sequence

When an 82357A is initially plugged into a USB port, a **Welcome to the Found New Hardware Wizard** dialog box may appear, as shown in the following figure. If this dialog box appears, select **Install the software automatically (Recommended)** and click **Next>**.

**NOTE**

*Ignore the statement “If your hardware came with an installation CD or floppy disk, insert it now”, as the software has already been installed.*

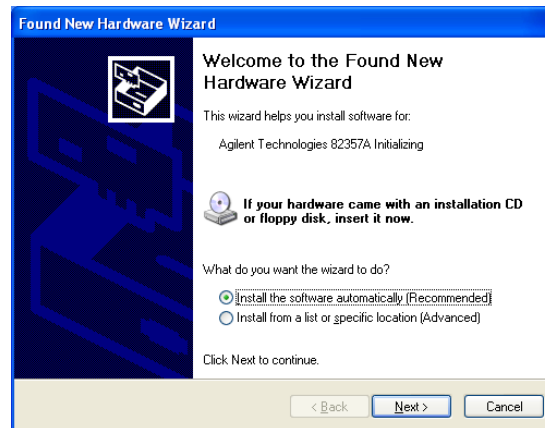

- 5** The **Please wait while the wizard searches...** dialog box appears. Wait until the initializing process completes and then click **Next>**.
- 6** The **Hardware Installation** dialog box appears.

**NOTE**

*Although the statement “Continuing your installation ... passed Windows Logo testing.” appears, you can safely click the Continue Anyway button.*

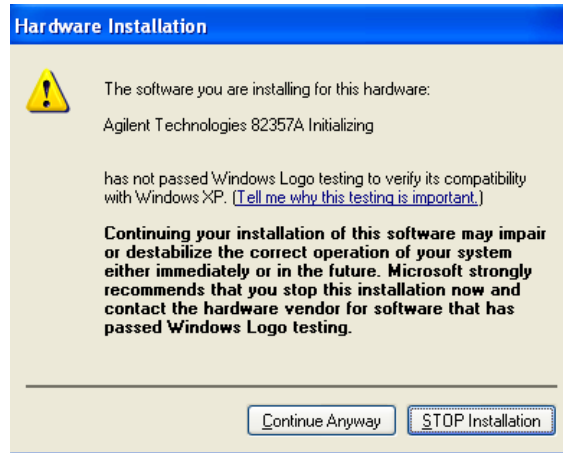

- 7** The **Completing the Found New Hardware Wizard** dialog box appears. Click **Finish** to close the wizard.
- 8** A slightly different version of the **Welcome to the Found New Hardware Wizard** dialog box appears, this time for installing 82357A software. Select **Install the software automatically (Recommended)** and then click **Next>**.

**NOTE**

*Ignore the statement “If your hardware came with an installation CD or floppy disk, insert it now”, as the software has already been installed.*

- 9** The **Please wait while the wizard searches...** dialog box appears. Wait until the initializing process completes and click **Next>**.
- 10** A different version of the **Hardware Installation** dialog box appears.

**NOTE**

*Although the statement “Continuing your installation ... passed Windows Logo testing.” appears, you can safely click the Continue Anyway button.*

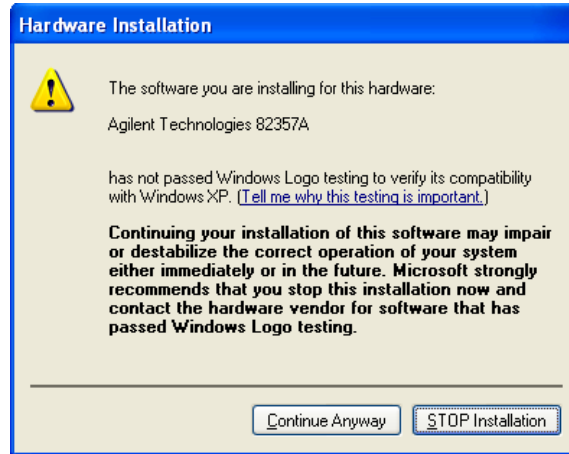

- 11** The **Please wait while the wizard installs the software...** dialog box appears. After the installation is complete, click the **Next>** button to display the **Agilent 82357A USB/GPIB Interface Detected** dialog box. Go to "Step 4: Configuring the 82357A" to continue the installation.

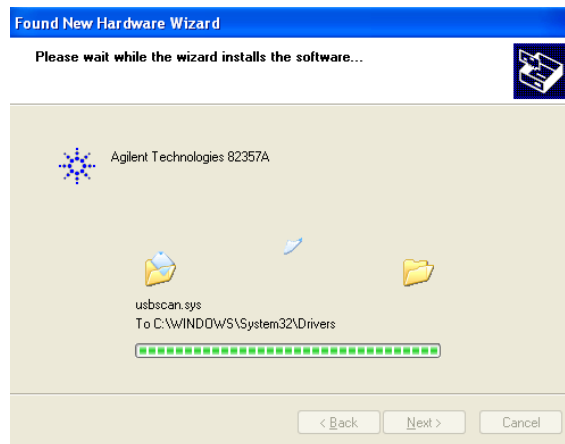

---

## Step 4: Configuring the 82357A

After the 82357A has been installed and the applicable Windows Plug and Play Manager installation sequence has completed, the 82357A must be configured before it can be used with SICL or with Agilent VISA or VISA COM. This step includes:

- Setting 82357A Default Configuration
- Setting 82357A Custom Configuration

### NOTE

*You must have Administrator privileges to install the IO Libraries Suite and to run the Connection Expert utility. If you do not have Administrator privileges, the default configuration for the 82357A will not take effect, and you will not be able to use the 82357A until it has been configured using Connection Expert.*

## Setting 82357A Default Configuration

This section shows steps to configure an 82357A for default settings by using the **Agilent 82357A USB/GPIB Interface Detected** dialog box. The default configuration should be sufficient for most applications.

### NOTE

*The Agilent 82357A USB/GPIB Interface Detected dialog box is displayed only if the Connection Expert utility is not running when you connect the 82357A. If Connection Expert is running, default configuration is automatic; you need take no further action. (If Connection Expert is running and you do not see your 82357A in the Connection Expert window after connecting it, click **Refresh All** to force the default configuration.)*

- 1 Check LED Status.** Before setting 82357A configuration, verify that all three LEDs on the 82357A are still ON to indicate the 82357A has been successfully installed, but has not yet been configured.
- 2 82357A Interface Detected Box Appears.** After an 82357A has been connected to a USB port and the Windows Plug and Play Manager

installation sequence has completed, an **Agilent 82357A USB/GPIB Interface Detected** dialog box should appear.

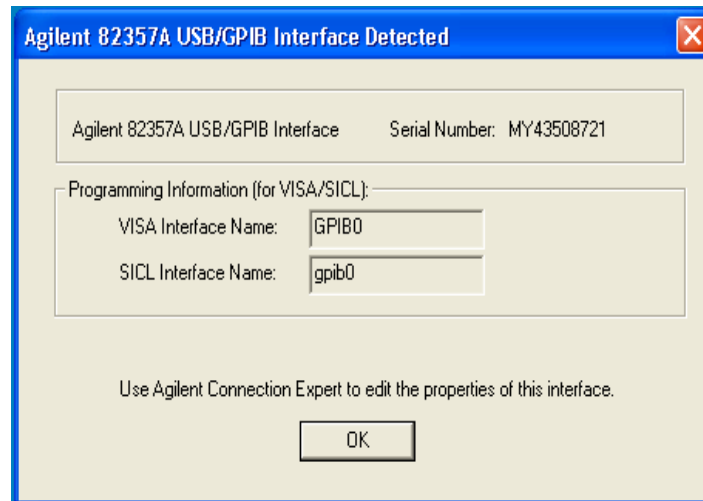

- 3** If the **Agilent 82357A USB/GPIB Interface Detected** dialog box does not appear, *and* the Connection Expert utility is not running, **STOP**. See *Chapter 3 - Troubleshooting the 82357A* before continuing.

**NOTE**

**Connecting Multiple 82357As.** An **Agilent 82357A USB/GPIB Detected** dialog box should appear each time you plug an 82357A into a USB port. For example, if you plug three 82357As into USB ports, three dialog boxes should appear. Each dialog box will remain until you remove it by clicking **OK** (or the **x** box). These dialog boxes will only appear if Connection Expert is not running.

- 4 Record VISA/SICL Names.** For future programming use, you will need to know the VISA Interface Name (also called VISA interface ID) and SICL Interface Name (also called SICL interface ID) as shown on the dialog box. You may want to record these values now. In Connection Expert, you can see these interface IDs displayed in the detail pane

(right pane of the Connection Expert window) when you highlight the USB/GPIB interface.

VISA Interface ID	_____
SICL Interface ID	_____

- 5 Accept Default Settings.** Click **OK** (or click the **x** box) to configure the 82357A with the (default) settings for the VISA Interface Name and the SICL Interface Name shown in the dialog box. If you do not want to accept the default settings, see the next section “Setting 82357A Custom Configuration.”
- 6 Only the READY LED Should Remain ON.** After you click **OK** (or click the **x** box), the dialog box disappears and only the green READY LED should remain ON to indicate the 82357A has been configured.
- 7 Configure Multiple 82357A Interface Converters.** If you have more than one 82357A in your system, repeat 1 - 6 for each additional interface converter.

**NOTE**

*At any time after the Agilent IO Libraries Suite is installed, you can reconfigure an 82357A by clicking the blue IO icon and clicking **Agilent Connection Expert**.*

## Setting 82357A Custom Configuration

This section shows steps to configure an 82357A for custom configuration settings using the Connection Expert utility. Typically, you will need to set custom configuration only for specialized applications, such as changing VISA and/or SICL interface IDs or for use in side-by-side operation with National Instruments VISA.

- 1 Check LED Status.** Before setting 82357A configuration, verify that all three LEDs on the 82357A are still ON to indicate the 82357A has been successfully installed, but has not yet been configured.
- 2 82357A Interface Detected Box Appears.** After an 82357A is connected to a USB port and the Windows Plug and Play Manager installation sequence completes, an **Agilent 82357A USB/GPIB Interface Detected** dialog box may appear. This dialog box will not appear if the Connection Expert utility is already running.
- 3** If this dialog box does not appear, *and* Connection Expert is not running, **STOP**. See *Chapter 3 -Troubleshooting the 82357A* before proceeding.
- 4** Accept the default settings by clicking **OK**. You will change the settings in the next steps.

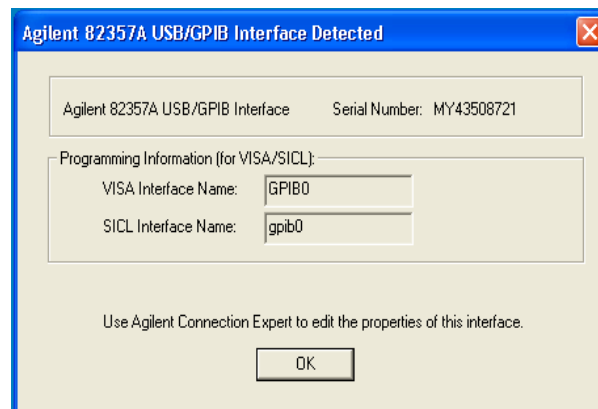

**NOTE**

*Connecting Multiple 82357As. An Agilent 82357A USB/GPIB Interface Detected dialog box should appear each time you plug an 82357A into a USB port. For example, if you plug three 82357As into USB ports, three dialog boxes should appear, one for each 82357A. Each dialog box will remain until you remove it by clicking **OK** (or the **x** box). These dialog boxes will only appear if Connection Expert is not running.*

- 5 Run Connection Expert.** Click the blue IO icon in the taskbar notification area and click **Agilent Connection Expert**. Wait for the Connection Expert window to appear.
- 6 Edit Default Settings.** Click on the USB/GPIB icon in the explorer view at the center of the Connection Expert window. In the property pane on the right, click **Change Properties...** to change the properties for the 82357A.
- 7** In the **Agilent 82357 Interface Converter** properties dialog box, set the **VISA interface ID** (also called the VISA Interface Name), the **SICL interface ID** (also called the SICL Interface Name), the **Logical Unit** and **GPIB address** values as required. Then, click the **OK** button to apply the new settings.
- 8 Only the Green READY LED Should Remain ON.** After you click **OK**, the properties dialog box disappears and only the green READY LED should remain ON to indicate the 82357A has been configured. The USB/GPIB icon and property pane in Connection Expert should show a green check mark, indicating the Verified state.

**Step 4: Configuring the 82357A**

- 9 Record VISA/SICL Names.** For future programming use, you will need to know the VISA interface ID and SICL interface ID as shown in the properties pane. After you finish editing the 82357A configurations, you may want to record these values. You can see these values at any time by running Connection Expert and selecting the USB/GPIB interface.

VISA Interface ID	_____
SICL Interface ID	_____

- 10 Configure Multiple 82357A Interface Converters.** If you have more than one 82357A in your system, repeat 6- 9 for each additional interface converter.

**NOTE**

*At any time after the Agilent IO Libraries Suite is installed, you can configure an 82357A by clicking the blue IO icon and clicking **Agilent Connection Expert**.*

## Step 5: Connecting GPIB Instruments

After the 82357A has been installed and configured, the next step is to connect GPIB instruments to the 82357A. This step includes:

- Connecting a Single GPIB instrument
- Connecting Multiple GPIB Instruments

### CAUTION

*To avoid damage to the connectors, only finger-tighten the connectors.*

### Connecting a Single GPIB Instrument

The following figure shows connection from a single GPIB instrument to the GPIB port on an 82357A. When you have made the connection for your system, go to “Step 6: Programming via the 82357A”. You may want to record the primary GPIB address of the attached instrument for future programming use.

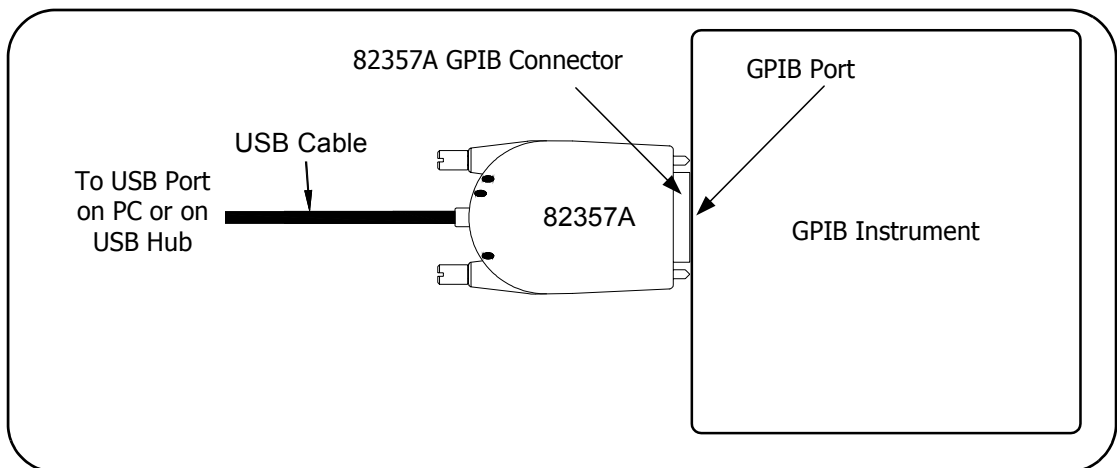

**Step 5: Connecting GPIB Instruments****Connecting Multiple GPIB Instruments**

The following figure shows a typical way to connect three GPIB instruments to an 82357A. When you have made the connections for your system, go to “Step 6: Programming via the 82357A”. You may want to record the primary GPIB address of each attached instrument for future programming use

**NOTE**

*Although the figure shows 82357A connection to GPIB Instrument 1, the connection can be to any GPIB instrument in the system. Be sure to first connect the GPIB cable to the GPIB instrument and then “piggy-back” the 82357A GPIB connector to the GPIB cable.*

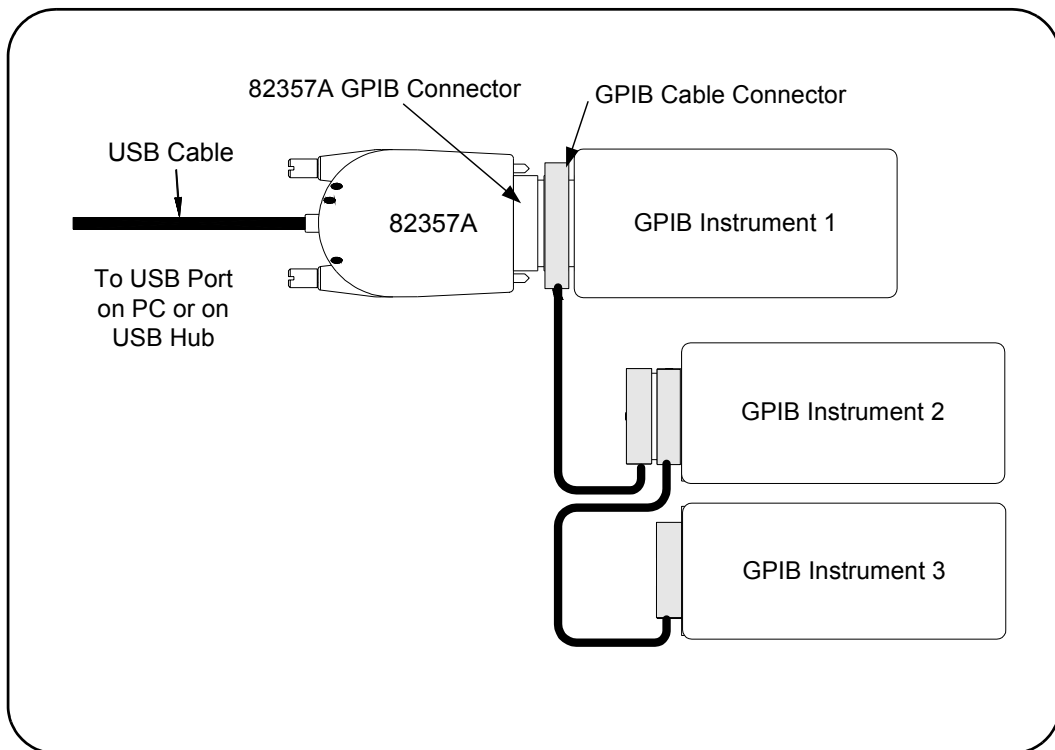

## Step 6: Programming via the 82357A

After the 82357A has been configured and you have connected your GPIB instruments to the 82357A, the next step is to establish communication between your PC and the instruments using VISA Assistant. After communication has been established, you can begin programming the instruments using VISA, VISA COM, or SICL. This section includes:

- Establishing Instrument Communication
- Programming GPIB Instruments

### Establishing Instrument Communication

When the Agilent IO Libraries Suite was installed on your PC, an IO utility called **VISA Assistant** was also installed. You can use VISA Assistant to verify communication between your PC and connected GPIB instruments. To use VISA Assistant for IEEE-488.2 or SCPI instruments:

- 1 Click the blue IO icon on the Windows taskbar (on the lower right-hand corner of the screen).
- 2 Click **VISA Assistant** to display the VISA Assistant main screen. For information on VISA Assistant, click **Help**.

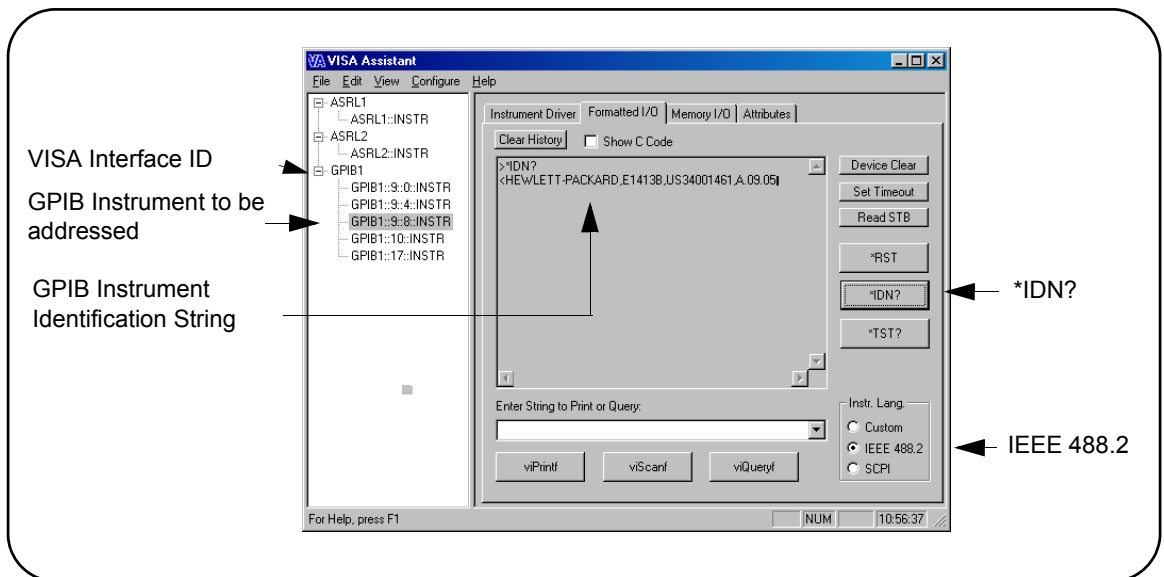

**Step 6: Programming via the 82357A**

- 3** Highlight the GPIB instrument to be addressed.
- 4** Select the **Formatted I/O** Tab.
- 5** Select the **IEEE 488.2** button.
- 6** Click the **\*IDN?** button.
- 7** The GPIB Instrument String should appear.
- 8** Repeat Steps 3 - 8 for the next GPIB instrument.
- 9** When communication has been established with each GPIB instrument, you can begin to program the instruments using VISA, VISA COM, or SICL. See the next section, "Programming GPIB Instruments", for an introduction.

## Programming GPIB Instruments

This section provides an introduction to programming GPIB instruments via the 82357A USB/GPIB Interface Converter using the Agilent VISA, VISA COM, and SICL IO Libraries. You can program in various languages/ applications, including Visual Basic, Visual C++, Agilent VEE, and National Instruments LabVIEW.

See the applicable User's Guide, such as the *Visual Basic User's Guide*, for programming guidelines. You can also find additional programming examples using various IO Libraries and instrument drivers in the instrument User's Guide. After the 82357A is successfully installed and configured, the Interface Converter acts as a transparent interface for programming GPIB instruments.

For information on programming using Agilent VISA, see the *Agilent VISA User's Guide*. For information on VISA COM and for function references for VISA, VISA COM, and SICL, see the *IO Libraries Suite Online Help*.

## Accessing VISA and SICL Manuals

You can access .pdf copies of the *Agilent VISA User's Guide* and the *Agilent SICL User's Guide for Windows* from the blue IO icon on the Windows taskbar. Adobe Reader is required to view these manuals.

To access the *Agilent VISA User's Guide*, click the IO icon and then click **Documentation | VISA Users Guide**. To access the *Agilent SICL User's Guide for Windows*, click the IO icon and then click **Documentation | SICL Users Guide**. To access VISA COM information, and function references for VISA, VISA COM, and SICL, click the IO icon and then click **Documentation | IO Libraries Suite Help**.

## Introduction to IO Interface Configuration

An **IO interface** consists of a hardware interface and a software interface. One purpose of the Connection Expert utility is to associate a unique software interface ID with a hardware interface.

The Agilent IO Libraries Suite uses an **Interface ID** or **Logical Unit Number** to identify an interface. This information is passed in the parameter string of the **viOpen** function call in a VISA program or in the **iopen** function call in a SICL program.

Connection Expert assigns an Interface ID and Logical Unit (LU) Number to the interface hardware, as well as other necessary configuration values for an interface when the interface is configured. Typically, the LU Number is automatically assigned and you can ignore its setting. The LU Number is used internally as a unique identifier. When the IO interface is configured, you can use Agilent VISA, VISA COM, or SICL to program assigned instruments.

## Example: IO Interface Configuration

For example, the GPIB interface system in the following figure consists of a Windows PC with an 82357A USB/GPIB Interface Converter connected between a USB port and three GPIB instruments with GPIB primary addresses of 3, 4, and 5, respectively. The instruments are connected via GPIB cables.

For this system, the Connection Expert utility has been used to assign a VISA name of "GPIB1" and a SICL name of "hplib7". With these names assigned to the interfaces, the VISA/SICL addressing is as shown in the figure.

Since unique names have been assigned by Connection Expert, you can use the VISA **viOpen** command to open the IO paths to the GPIB instruments as shown in the figure. Or, you can use the SICL **iopen** command to open the IO paths.

**Typical System Installation - 82357 USB/GPIB Interface**

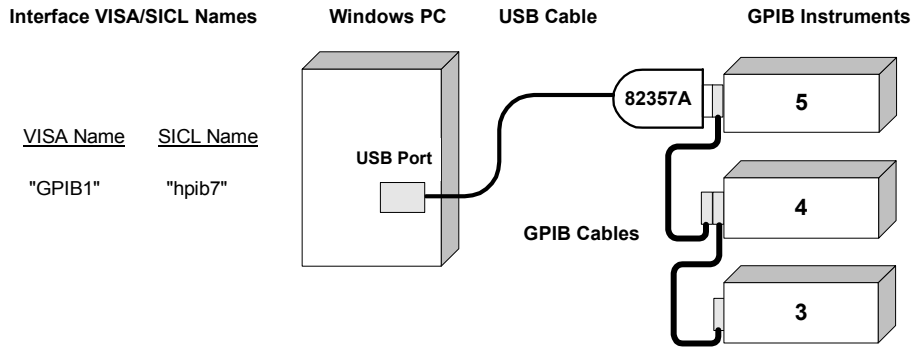

**VISA/SICL Addressing**

VISA:	viOpen (... "GPIB1::5::INSTR"...)	Open IO path to GPIB instrument at address 5 using 82357
	viOpen (... "GPIB1::4::INSTR"...)	Open IO path to GPIB instrument at address 4 using 82357
	viOpen (... "GPIB1::3::INSTR"...)	Open IO path to GPIB instrument at address 3 using 82357
SICL:	iopen ("hplib7,5")	Open IO path to GPIB instrument at address 5 using 82357
	iopen ("hplib7,4")	Open IO path to GPIB instrument at address 4 using 82357
	iopen ("hplib,3")	Open IO path to GPIB instrument at address 3 using 82357

**Using the 82357A**

---

---

## Using the 82357A

This chapter describes normal operating states for the 82357A and gives guidelines to use the 82357A including:

- Modes of Operation
- Setting Configuration Parameters





















## Modes of Operation

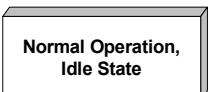

This section describes normal operational modes for the 82357A, including:

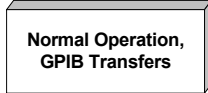
- Initial 82357A Operating States
- Introduction to 82357A Operating Modes
- Single 82357A Operation
- Multiple 82357A Operation
- SRQ Operation

### Initial 82357A Operating States

The following figure shows the sequence of initial operating states when the 82357A is first connected to a USB port on a PC or on a USB hub.

	State	Description	LED States		
			READY (Green)	FAIL (Red)	ACCESS (Green)
1		82357A is connected to a USB port on the PC or on a USB hub, but no power is applied to the 82357A.			
2		Power is applied to the 82357A from the USB port, but startup firmware not yet downloaded.			
3		Host computer has downloaded startup firmware to the 82357A. The 82357A has been installed but not yet configured.			
4		82357A has been configured for operation with the Agilent IO Libraries.			
5		The ACCESS LED is ON for any GPIB transfers.			

 LED OFF  
  LED ON  
  Intermittent

## Introduction to 82357A Operating Modes

The 82357A has two modes of operation. When only one 82357A is connected to a USB port within a system, we define the operation as the **single mode of operation**. When two or more 82357As are connected at the same time to USB ports within a system, we define the operation as the **multiple mode of operation**.

### NOTE

*All SICL/VISA applications are notified when their 82357A has been removed from the system by returning **VI\_ERR\_NOINFC** (for VISA) or **I\_ERR\_NCIC** (for SICL).*

### Single Mode Features

For the single mode of operation, the operating parameters (VISA Interface ID, SICL Interface ID, Logical Unit Number, and GPIB Address) are set when the 82357A is first installed and configured.

If this 82357A is unplugged and replugged or if the 82357A is replaced with a *different* 82357A, the original configuration parameters are automatically assigned to the newly attached 82357A. Thus, you can exchange 82357As at any time without reconfiguring the interface. This allows exchanging 82357As among users, as long as only one 82357A is attached at any one time.

### Multiple Mode Features

In contrast, when two or more 82357As are connected to the system at the same time, each 82357A must have its own specific set of operating parameters and each 82357A Serial Number is “bound” to its operating parameters. In multiple mode of operation, if you add a new 82357A or if you unplug an 82357A and plug in a new 82357A, the newly installed 82357A will be assigned a new (unique) set of operating parameters.

### NOTE

*Each time you attach a new 82357A, if Connection Expert is not running, an **Agilent 82357A USB/GPIB Interface Detected** dialog box will be displayed. If Connection Expert is running, the Connection Expert window will automatically refresh as the new 82357A is configured.*

## Single 82357A Operation

When an 82357A is first installed and configured, a default VISA Interface ID, SICL Interface ID, Logical Unit (LU) number and GPIB Address are automatically assigned to the Serial Number associated with this specific 82357A.

For example, assume an 82357A with Serial Number US12345678. When this 82357A is first installed, typical values as shown are automatically assigned to this Serial Number.

- VISA Interface ID: GPIB0
- SICL Interface ID: hpib7
- Logical Unit: 7
- GPIB Address: 21

For *single mode of operation*, when the existing 82357A is removed and a new 82357A is installed, the new 82357A assumes all configuration attributes of the previously configured 82357A (same VISA Interface ID, SICL Interface ID, LU and GPIB Address). Thus, any SICL/VISA applications using that VISA/SICL configuration will continue to run using the new 82357A.

### NOTE

*You can change the parameter values of the 82357A as required. See “Changing Configuration Parameters” for details.*

The first time an 82357A is attached to a system (assuming the Agilent IO Libraries Suite is installed), the software recognizes that an 82357A is attached. If Connection Expert is not running, the software displays an **Agilent 82357A USB/GPIB Interface Detected** dialog box that allows you to accept the current settings. If Connection Expert is running, it automatically refreshes, displaying the 82357A as a USB/GPIB interface in its tree view; you can then change the properties of the interface in Connection Expert.

The VISA and SICL interface IDs, Logical Unit, and GPIB Address may be viewed at any time in the property pane of the Connection Expert. (To view this window, click the blue IO icon and then click **Agilent Connection Expert**.)

Then, if you disconnect this 82357A and plug in another 82357A (with a different Serial Number) or if you re-plug the same 82357A, the new 82357A will assume the same VISA Interface ID, SICL Interface ID, LU, and GPIB Address as the original 82357A.

## Multiple 82357A Operation

When two or more 82357As are attached to a system at the same time, we define the mode as the **multiple mode of operation**. In multiple mode of operation, each 82357A is “bound” to its related IO Configuration for that Serial Number. This is a different mode of operation than the single mode of operation in that the configuration is not reused if you replace an 82357A with another 82357A.

As with single mode of operation, the first time an 82357A is attached to a system (assuming the Agilent IO Libraries Suite is installed), the software recognizes that an 82357A is attached. If Connection Expert is not running, the software displays an **Agilent 82357A USB/GPIB Interface Detected** dialog box that allows you to accept the current settings. If Connection Expert is running, it automatically refreshes, displaying the 82357A as a USB/GPIB interface in its tree view; you can then change the properties of the interface in Connection Expert.

The VISA and SICL interface IDs, Logical Unit, and GPIB Address may be viewed at any time in the property pane of the Connection Expert. (To view this window, click the blue IO icon and then click **Agilent Connection Expert**.)

Then, if you plug in another 82357A (with a different Serial Number), the new 82357A will automatically be assigned a unique VISA Interface ID, SICL Interface ID, LU, and GPIB Address.

### NOTE

*You can change the parameter values of the 82357A as required. See “Changing Configuration Parameters” for details.*

*You can also convert from multiple mode of operation to single mode of operation. See “Changing Modes of Operation” for details.*

## SRQ Operation

If your VISA/SICL application uses SRQ callbacks (**viEventHandler()** in VISA or **ionsrq()** in SICL) and your callback does not service the SRQ in a timely manner, your SRQ callback function may be called multiple times.

To avoid this possible situation, design your SRQ callback functions to handle being called when an SRQ is no longer asserted on the GPIB bus.

## Setting Configuration Parameters

This section gives guidelines to change or set various configuration parameters for the 82357A, including:

- Changing Configuration Parameters
- Changing Modes of Operation
- Setting Timeout Floor Value
- Setting High-Performance Operation

## Changing Configuration Parameters

To change the VISA or SICL Interface ID or the LU or GPIB Address value, or if you want to check the values, highlight the USB/GPIB interface in the explorer view (tree view) of the Connection Expert window. Click the **Change Properties...** button in the property pane to display the **Agilent 82357 Interface Converter** dialog box. Choose the settings you want and then click **OK**. Clicking **Cancel** will cause the configuration set in the preceding dialog box to be used..

### NOTE

*Although you can change the Logical Unit (LU) and GPIB Address values for an 82357A, this is generally not necessary and may cause running applications to fail or to stop running.*

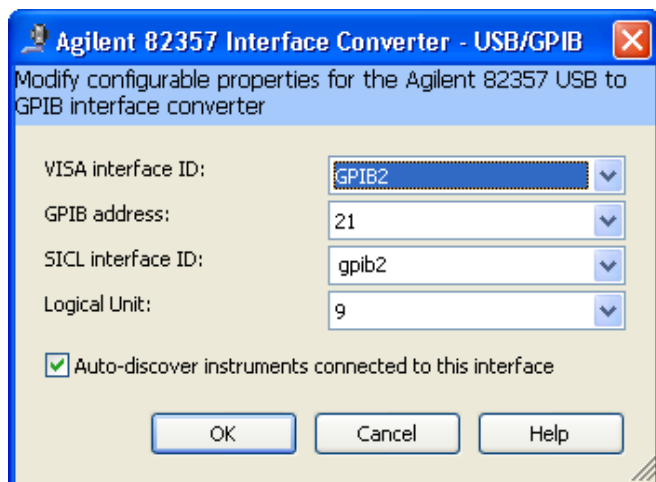

## Changing Modes of Operation

If your system has multiple 82357As configured (multiple mode of operation), the **only** way to change from multiple mode of operation back to the single mode of operation is:

- 1 Unplug all 82357As from the system.
- 2 Run Connection Expert (click the blue IO icon and click **Agilent Connection Expert**).
- 3 Delete all 82357A configurations by selecting each USB/GPIB icon in the explorer view and clicking **Delete** (or delete all except one configuration).
- 4 Reattach and reconfigure a single 82357A.

## Setting Timeout Floor Values

The 82357A has a default timeout “floor” value that is an internal requirement to ensure reliable USB communication. The 82357A will not allow timeouts LESS than the floor value. (By default, VISA/SICL timeouts are set to an infinite time.)

To programmatically determine the timeout floor, you can set the timeout to a very small value, such as 1 msec, and then query for the actual timeout floor value. VISA and SICL examples follow.

Example: Query  
Timeout Floor  
(VISA)

```
tval = 1; // Try to set timeout to 1 msec
err = viSetAttribute(id, VI_ATTR_TMO_VALUE, tval_in);
...
err = viGetAttribute(id, VI_ATTR_TMO_VALUE, &tval_out);
...
printf("Set timeout to [%d], actual timeout that resulted [%d]\n",
      tval_in, tval_out );
```

Example: Query  
TimeOut Floor  
(SICL)

```
tval = 1; // Try to set timeout to 1 msec
err = itimeout(id, tval_in);
...
err = igettimeout(id, &tval_out);
...
printf("Set timeout to [%d], actual timeout that resulted [%d]\n",
      tval_in, tval_out );
```

## Setting 82357A High-Performance Operation

### NOTE

*Changing the T1 delay as described in this section is an advanced feature and also requires attention to cable lengths and other system features.*

### Introduction

The GPIB transfer rate for 82357A writes using large (>1000 bytes) buffer size is affected by the Data Available (T1) delay time. (The transfer rates are not noticeably affected when the buffer size is <1000 bytes). The default delay time used by the 82357A is 800 nsec.

The maximum transfer rate for T1 = 350 nsec is about 900 KBytes/sec as compared to about 650 KBytes/sec for the 82357A default value of 800 nsec. Changing the T1 delay affects ONLY the *write* performance of the 82357A.

### Setting T1 Value With VISA

To set the T1 value with VISA, use the **VI\_AGATTR\_GPIB\_T1\_DELAY** attribute. The **VI\_AGATTR\_GPIB\_T1\_DELAY** value is the time of the T1 delay in nanoseconds, and should be no less than **VI\_AG\_GPIB\_T1DELAY\_MIN** or no greater than **VI\_AG\_GPIB\_T1DELAY\_MAX**. This value is defined in Agilent's 'visa.h' header file. To use this value, you must **#define AGVISA\_ATTRIBUTES** before the **#include "visa.h"** in your C or C++ source file.

The 82357A supports T1 delays from 350 nsec to *<max\_value>* in steps of 40 nsec. You can find out the actual value by calling **viGetAttribute()**.

Attribute	Access Priv.	Data Type	Range (nsec)	Used By
<b>VI_AGATTR_GPIB_T1_DELAY</b>	RW Global	ViInt32	<b>VI_AG_GPIB_T1DELAY_MIN</b> to <b>VI_AG_GPIB_T1DELAY_MAX</b>	GPIB INTFC resources

### Setting T1 Value With SICL

To set the T1 value with SICL, use the **igpibsett1delay()** command and modify the GPIB environment. For further information, you may want to see the Hewlett-Packard document "Tutorial Description of the Hewlett-Packard Interface Bus". See Section 2.12, Optimizing Performance.

**Notes:**

---

---

**Troubleshooting the 82357A**

---

---

## Troubleshooting the 82357A

This chapter provides troubleshooting guidelines and service/support information for the Agilent 82357A USB/GPIB Interface Converter.

The chapter contents are:

- Troubleshooting Flowchart
- Hardware Checks
- Software Installation Checks
- Software Configuration Checks
- Service and Support Information

---

## Troubleshooting Flowchart

The figure on the next page shows a suggested sequence of steps to diagnose and troubleshoot 82357A problems, based on the LED states. You can use the LED states to help diagnose and troubleshoot the 82357A whenever the LED states do not match expected normal states. See *Chapter 2 - Using the 82357A* for the normal LED sequence when the 82357A is initially connected to a USB port.

### Observe the LED States

To begin troubleshooting, determine the LED states after at least 10 seconds have elapsed since the 82357A was connected to a USB port and all Windows Plug and Play Manager activity has ceased. Then:

- If all LEDs are OFF, start with “Hardware Checks”
- If the red FAIL LED is ON, start with “Software Installation Checks”
- If all LEDs are ON, start with “Software Configuration Checks”

After taking the steps in the check sequence, use the boxes at the bottom of the chart to determine the next step. For example, if doing a Hardware Check results in only the red FAIL LED remaining ON, go to “Software Installation Checks”, etc.

#### NOTE

*You do not have to do all the steps or do the steps in the order shown. If any action results in a change in LED states, go to the applicable check sequence to continue troubleshooting.*

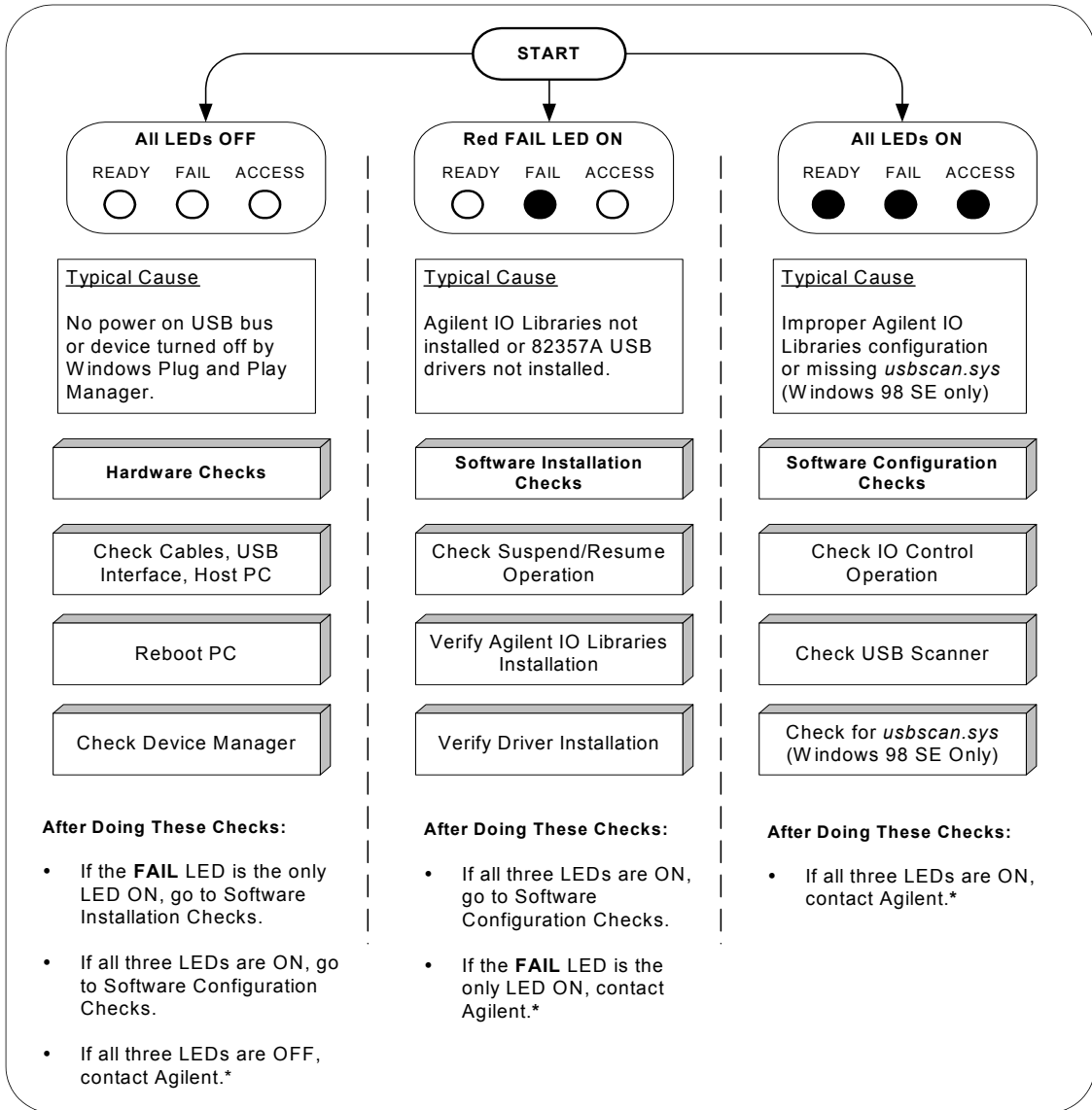

\*For telephone and web assistance, see "Contacting Agilent" on page 56.

---

## Hardware Checks

If all LEDs are still OFF 10 or more seconds after plugging the 82357A USB cable into a USB port, and all Windows Plug and Play Manager activity and Connection Expert refreshes have ceased, start your troubleshooting sequence by performing hardware checks. If any action taken results in a change in the LED status, go to “Software Installation Checks” or to “Software Configuration Checks”.

### Check USB Cables, USB Interface, Host PC

Begin the hardware checks by checking connections between the 82357A and PC (plus USB hubs, if used).

- 1 Check USB Cable Connections.** Check the 82357A USB cable for a good connection to the USB port on the PC or on the USB hub. If you are using a USB hub, verify that the hub is connected to the PC.
- 2 Unplug/replug the 82357 USB cable.** If this does not change the LED status, try plugging the 82357A into another USB port.
- 3 Check PC USB Port.** Verify that the PC USB port is functional and powered (such as checking by using another USB device).
- 4 Check PC State.** Verify that host computer is not in a Suspended power management state.
- 5 Check USB Hub.** Try disconnecting the 82357A from the hub and connecting it directly to a USB port on the PC. Some USB hubs are vulnerable to static shock.
- 6 Check USB Cables for Damage.** Check the USB cable for cuts/crashes. Since the end connectors are somewhat fragile, check for bent/misaligned/crushed connectors.

### Reboot the PC

If Steps 1, 2, 3, 4, 5, or 6 do not change the LED status, reboot the PC.

## Check Device Manager

You can use the Windows Device Manager to reinstall the 82357A, as required. For example, with Windows 2000, go to **Control Panel** by selecting **Start | Settings | Control Panel**.

Then, select **System | Hardware | Device Manager**. From **Device Manager**, select **82357** and then **Properties**. Tab to **Driver** and click **Reinstall Driver**. This will allow the Windows Plug and Play Manager to begin searching for a driver for the 82357A. Since **Device Manager** may have disabled the 82357A USB device, click **Enable** to restart the 82357A.

### **NOTE**

*If you are using a USB scanner, scanner conflicts are possible. See "Check USB Scanner" in the Software Configuration Checks section.*

---

## Software Installation Checks

When only the red FAIL LED is still ON after 10 seconds, the 82357A has been detected by the host computer, but has not yet been configured for use with the Agilent IO Libraries. Possible causes for this is that the appropriate version of the Agilent IO Libraries or Agilent IO Libraries Suite has not been installed on your PC or the 82357A USB drivers have not been installed.

### Check Suspend/Resume Operation

Some Windows operating systems support Power Management which can suspend the PC while the 82357A is in operation. After a Suspend/Resume cycle, the 82357A may not properly resume operation. In this case, you may need to unplug/replug the USB cable to restore 82357A operation. If this does not correct the problem, go to “Verify Agilent IO Libraries Suite Installation”.

#### NOTE

*If your 82357A applications must not be preempted by a PC Suspend event, we recommend you disable Power Management on your PC by using the **Control Panel | Power Options** dialog.*

### Verify Agilent IO Libraries Suite Installation

When only the red LED is ON after 10 seconds and all Windows Plug and Play Manager activity has ceased, start your troubleshooting sequence by verifying IO Libraries installation. If any action taken results in a change in the LED status, go to “Software Configuration Checks” or to “Hardware Checks”.

- 1 Check Agilent IO Libraries Version.** If a version of the Agilent IO Libraries or IO Libraries Suite has been installed, a blue **IO** icon is normally displayed on the Windows taskbar (on the lower right-hand side of the screen).

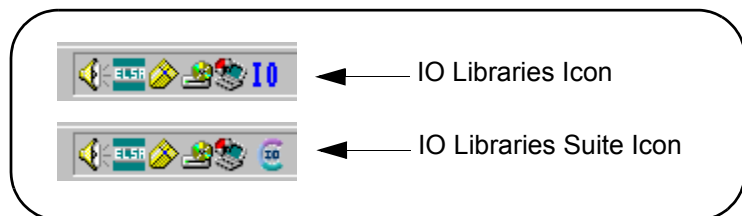

- a If the IO icon is displayed, click the icon and click **About Agilent IO Control** to display the version. The version must be L.01.00 or greater. Note that Agilent IO Libraries Suite 14.0 was the revision immediately following Agilent IO Libraries M.01.01, so you should consider revision “14.0” to be a greater version number than “L” or “M”.
  - b If the IO icon is not displayed, a version may still be installed. To check this, click **Start | Programs** and look for the **Agilent IO Libraries** or **Agilent IO Libraries Suite** program group.
  - c If this group is displayed, click **Agilent IO Libraries | IO Control** to display the IO icon. Then, click the icon and click **About Agilent IO Libraries Control** to display the installed version (must be L.01.00 or greater).
  - d If neither the IO icon nor the Agilent IO Libraries program group is displayed, no Agilent IO Libraries are installed. In this case, or if the installed version is not L.01.00 or greater, you must install the newer version (see Step 2).
- 2 Install Agilent IO Libraries (as Required).** If Version L.01.00 or greater of the Agilent IO Libraries or IO Libraries Suite is not installed on your PC, use this step. Otherwise, skip to “Verify 82357A USB Driver Files Installation”.
- a Remove the 82357A USB cable from the USB port.
  - b Insert the *Automation-Ready CD* in your CD-ROM drive and follow the instructions in *Chapter 1 - Installing the 82357A* to install the libraries. If you do not have the *Automation-Ready CD*, you can download the Agilent IO Libraries Suite from <http://www.agilent.com/find/iolib>
  - c Re-attach the 82357A USB cable to the USB port and check the LEDs for at least 10 seconds.
    - If only the red FAIL LED remains ON, go to “Verify 82357A USB Driver Installation”.
    - If all three LEDs remain ON, go to “Software Configuration Checks”.

## Verify 82357A USB Driver Installation

After installing the Agilent IO Libraries, check for installed driver files.

- 1 Check for Driver Files.** This table lists the USB driver files in their default directories.

Windows 2000	
Program Files	<i>C:\Program Files\Agilent\IO Libraries Suite\drivers\ag357i32.dll</i>
Driver Files	<i>C:\Winnt\system32\drivers\agt82357.sys</i>
.inf Files	<i>C:\Winnt\inf\agt357.inf</i>
Windows Me/XP	
Program Files	<i>C:\Program Files\Agilent\IO Libraries Suite\drivers\ag357i3l.dll</i>
Driver Files	<i>C:\Windows\system32\drivers\agt82357.sys</i>
.inf Files	<i>C:\Windows\inf\agt357.inf</i>
Windows 98 SE	
Program Files	<i>C:\Program Files\Agilent\IO Libraries Suite\drivers\ag357i3l.dll</i>
Driver Files	<i>C:\Windows\system32\drivers\agt82357.sys</i>
.inf Files	<i>C:\Windows\inf\agt3579x.inf</i>

- 2 Uninstall the Agilent IO Libraries Suite.** If the driver files cannot be found, uninstall the Agilent IO Libraries Suite by going to the Windows Control Panel, Add or Remove Programs, selecting Agilent IO Libraries Suite, and clicking **Remove** and **Next>**. Then, follow the instructions to remove the libraries.
  
- 3 Reinstall the Agilent IO Libraries Suite.** Insert the CD into the CD-ROM. Follow the instructions in *Chapter 1 - Installing the 82357A* to install the libraries. If you do not have the *Automation-Ready CD*, you can download the Agilent IO Libraries Suite from <http://www.agilent.com/find/iolib>
  - If only the FAIL LED remains ON, go to “Hardware Checks”.
  - If all three LEDs turn ON, go to “Software Configuration Checks”.
  - If the red FAIL LED still does not turn OFF, contact Agilent.

---

## Software Configuration Checks

If all three LEDs remain ON for more than 10 seconds after the 82357A is connected to a USB port, the 82357A has been installed but is not yet configured for use with the Agilent IO Libraries.

When all three LEDs are ON after 10 seconds, start your troubleshooting sequence by checking IO Control operation. If any action taken results in a change in the LED status, go to “Software Installation Checks” or “Hardware Checks”, as applicable.

### NOTE

*If you are using the 82357A with Windows 98 (SE), before beginning these checks verify that your operating system is Windows 98 (SE), not Windows 98, First (“Gold”) Edition. The 82357A will not operate correctly for a Windows 98, First Edition operating system.*

## Checking IO Control Operation

When the Agilent IO Libraries Suite was installed, an IO Control was created. When the IO Control is active, it is displayed as a blue IO icon on the Windows taskbar. By default, the IO Control is always active after the libraries are installed and the blue IO icon is displayed. However, if the IO Control is deactivated, SICL/VISA applications that are running with the 82357A will malfunction. Some symptoms that may occur when IO Control is not active include:

- Connection Expert is not running, but an **Agilent 82357A USB/GPIB Interface Detected** dialog box does not appear when an 82357A is first connected to a USB port.
- Connection Expert is running, but does not automatically refresh when an 82357A is first connected to a USB port.
- SICL/VISA applications using the 82357A are unable to open sessions.
- The Windows Task Manager shows that iproc82357.exe is not running or is non-responsive.

If any of these symptoms occur, use the following troubleshooting sequence:

- 1 Unplug/Replug the 82357A.** If unplugging and replugging the 82357A causes the **Agilent 82357A USB/GPIB Interface Detected** dialog box to appear or the Connection Expert window to refresh, the problem is solved. If not, go to Step 2.
- 2 Shut Down and Restart IO Control.** Take these steps to shut down and then restart the IO Control. Taking these actions should result in all attached and configured 82357As to be initialized and to display only the green Ready LED
  - a** If the blue IO icon is displayed, click the icon and then click **Exit**. A dialog box explaining the consequences of removing the IO Control appears. Click **OK** to shut down the IO Control.
  - b** If the blue IO icon is not displayed, either the icon display has been turned off or the IO Control (and associated *iprocsvr.exe* and *iprocsvr.exe*) are not active. In this case, select **Start | Programs | Agilent IO Libraries Suite** and click **IO Control** to re-start the IO Control and display the blue IO icon.

#### NOTE

*Rebooting your PC should ALWAYS restart the IO Control and iprocsvr.exe and iproc82357.exe.*

## Check USB Scanner

In general, USB scanners do not cause problems with the 82357A. However, if you do have problems with 82357A operation and have a scanner installed on your system that uses a USB port, unplug the scanner and then plug the 82357A into the port.

If the 82357A will configure without your scanner attached to your system, the scanner was locking out the 82357A from using the USB bus. In this case, contact your scanner's manufacturer to request software or firmware updates for the scanner.

## Check for *usbscan.sys* (Windows 98 SE Only)

The 82357A relies on a Microsoft driver called *usbscan.sys* that ships with Windows 98/Me/2000/XP. However, for Windows 98 SE, this file and its parent file, *driver20.cab*, may not be installed on your PC. Typically, the *usbscan.sys* file is located under the system root directory at `\WINDOWS\SYSTEM32\DRIVERS\`.

### NOTE

*usbscan.sys* parent *.cab* file name is different for each Windows release. The “*driver20.cab*” file name only applies to Windows 98 SE. The *usbscan.sys* install problem is NOT expected on Windows Me/2000/XP systems.

### Windows 98 SE Symptoms

If the *usbscan.sys* driver and the Microsoft *.cab* file (typically named “*driver20.cab*” on Windows 98 systems) are not resident on your Windows 98 SE system, after you install the Agilent IO Libraries Suite and connect an 82357A to a USB port, a Windows Plug and Play Manager dialog box appears that queries you for the location of *usbscan.sys*; *driver20.cab*. If this dialog box appears:

- **If you have a Windows 98 SE CD:** Insert the CD and browse to `x:\Win98`. The install process will resume and the 82357A will begin operation.
- **If you do not have a Windows 98 SE CD:** Click **Cancel** on the dialog box. Then, use one of the following methods to obtain the CD and follow the step above.
  - Locate the original Windows 98 SE Installation CD
  - Contact your System Administrator for the CD
  - Contact Microsoft for a replacement CD

### Assigning *usbscan* Driver to the 82357A

If, when you initially plugged an 82357A into a USB port, a Windows Plug and Play Manager dialog box appeared that requested the location of *usbscan.sys* and you were forced to click **Cancel** from this dialog box, see the following information in this section. Otherwise, skip this section.

After an initial attachment of an 82357A to a system without *usbscan.sys* installed, future unplugs/replugs of an 82357A will result in the system (silently) assigning the wrong driver and not querying the user for the *usbscan.sys* driver location. This action leaves the 82357A inoperative, with all 3 LEDs ON (assuming the Agilent IO Libraries Suite is installed).

To properly associate the *usbscan.sys* driver with an 82357A, you can either update the driver using the Windows Device Manager utility or uninstall/reinstall the Agilent IO Libraries Suite (with the 82357A unattached) and then attach the 82357A and provide the Windows 98 SE media location to the Plug and Play Manager.

#### Uninstall/Reinstall the Agilent IO Libraries

With this method, the 82357A install software (found in the Agilent IO Libraries Suite installer) cleans the Windows Registry of any memory of an 82357A being on the system, forcing the Plug and Play Manager to query again for the location of *usbscan.sys*. This method has the side effect of removing any Agilent IO Libraries Suite IO Configurations established previously.

Disconnect all 82357As from the USB ports. Then, uninstall and reinstall the Agilent IO Libraries Suite (version L.01.00 or greater, or 14.0 or greater). Attach the 82357A and provide the Window 98 SE media location to the Windows Plug and Play Manager.

#### Update the Driver using Windows Device Manager

With this method, you tell Windows that a new driver is to be assigned to the 82357A. This method requires you to locate where the Device Manager has mistakenly located the 82357A device.

- 1 Start Windows Device Manager and select the 82357A device, usually presented in Device Manager as an “Other” type device. Then, select Properties for that device and then select the Driver tab in the resulting dialog.
- 2 Click the **Update driver...** button and provide the Windows 98 SE CD when prompted. This forces the Windows Plug and Play Manager to reassess the drivers needed for that device, allowing you to provide the *usbscan.sys* source media location.

---

## Service/Support Information

This section provides service and support information for the 82357A and lists numbers and a Web site you can use to contact Agilent about the 82357A.

### 82357A Service Information

There are no user-serviceable parts for the Agilent 82357A USB/GPIB Interface Converter. If you suspect a hardware failure for the 82357A, contact Agilent for instructions to return the unit. See the following section “Contacting Agilent” for telephone numbers/web site address.

### Contacting Agilent

- You can reach Agilent Technologies at this telephone number for the Americas:

Americas Call Center: 1-800-829-4444

- For other countries, contact your country’s Agilent support organization. A list of contact information for other countries is available on the Agilent Web site:

<http://www.agilent.com/find/assist>

---

**82357A User's Guide Information**

---

---

## 82357A User's Guide Information

This chapter provides general information for the *82357A User's Guide*, including:

- Guide Contents
- Guide General Information

## Guide Contents

This *Agilent 82357A USB/GPIB Interface Converter User's Guide* shows how to install and configure the Agilent 82357A USB/GPIB Interface Converter for PCs with Windows 98 (SE), Windows Me, Windows 2000, or Windows XP Professional operating systems. This table summarizes the contents of this guide.

Chapter	Description
<i>Chapter 1 - Installing the 82357A</i>	Shows a suggested six-step process to install the 82357A and the Agilent IO Libraries Suite, to connect the 82357A to your PC, to configure the 82357A, and to program GPIB instruments via the 82357A
<i>Chapter 2 - Using the 82357A</i>	Describes 82357A modes of operation and shows how to set 82357A configuration parameters.
<i>Chapter 3 - Troubleshooting the 82357A</i>	Gives guidelines to troubleshoot the 82357A, including hardware and software checks, and provides service and support information for the 82357A.
<i>Chapter 4 - User Guide Information</i>	Provides guide contents and general information for this guide.
<i>Appendix A - 82357A Specifications</i>	Provides technical specifications and supplementary information for the 82357A.

---

## Guide General Information

General Information for this guide follows, including:

- Notice
- U.S. Government Restricted Rights
- Warranty Information
- Trademark Information
- Printing History
- Copyright Information
- Declaration of Conformity

### Notice

The information contained in this document is subject to change without notice.

Agilent Technologies shall not be liable for any errors contained in this document. *Agilent Technologies makes no warranties of any kind with regard to this document, whether express or implied. Agilent Technologies specifically disclaims the implied warranties of merchantability and fitness for a particular purpose.* Agilent Technologies shall not be liable for any direct, indirect, special, incidental, or consequential damages, whether based on contract, tort, or any other legal theory, in connection with the furnishing of this document or the use of the information in this document.

### U.S. Government Restricted Rights

The Software and Documentation have been developed entirely at private expense. They are delivered and licensed as “commercial computer software” as defined in DFARS 252.227- 7013 (Oct 1988), DFARS 252.211-7015 (May 1991) or DFARS 252.227-7014 (Jun 1995), as a “commercial item” as defined in FAR 2.101(a), or as “Restricted computer software” as defined in FAR 52.227-19 (Jun 1987) (or any equivalent agency regulation or contract clause), whichever is applicable. You have only those rights provided for such Software and Documentation by the applicable FAR or DFARS clause or the Agilent standard software agreement for the product involved.

## Warranty Information

A copy of the specific warranty terms applicable to your Agilent Technologies product and replacement parts can be obtained from Agilent Technologies, Inc.

## Trademark Information

Windows ® 98, Windows ® Me, Windows™ NT 4.0, Windows ® 2000 and Windows XP™ Professional are U.S. registered trademarks of Microsoft Corporation. All other brand and product names are trademarks or registered trademarks of their respective companies.

## Printing History



Edition 1 - January 2002  
Edition 2 - March 2003  
Edition 3 - May 2004  
Edition 4 - November 2004  
Manual part number: 82357-90002

## Copyright Information

*Agilent Technologies 82357A USB/GPIB Interface Converter  
User's Guide*  
Copyright © 2002-2004 Agilent Technologies, Inc.  
All rights reserved.

## Declaration of Conformity

See the next page for the Declaration of Conformity for the 82357A USB/GPIB Interface Converter.

 <b>Agilent Technologies</b>	<b>DECLARATION OF CONFORMITY</b> According to ISO/IEC Guide 22 and CEN/CENELEC EN 45014	
---	--	---

**Manufacturer's Name:** Agilent Technologies, Incorporated  
**Manufacturer's Address:** 815 – 14<sup>th</sup> St. SW  
Loveland, CO 80537  
USA

**Declares under sole responsibility that the product as originally delivered**

**Product Name:** USB/GPIB Interface Converter  
**Model Number:** 82357A  
**Product Options:** This declaration covers all options of the above product(s)

**complies with the essential requirements of the following applicable European Directives, and carries the CE marking accordingly:**

EMC Directive (89/336/EEC, amended by 93/68/EEC)  
Low Voltage Directive (73/23/EEC, amended by 93/68/EEC)

**and conforms with the following product standards:**

EMC	Standard	Limit
	IEC 61326-1:1997+A1:1998 / EN 61326-1:1997+A1:1998	
	CISPR 11:1990 / EN 55011:1991	Group 1 Class A
	IEC 61000-4-2:1995+A1:1998 / EN 61000-4-2:1995	4 kV CD, 8 kV AD
	IEC 61000-4-3:1995 / EN 61000-4-3:1995	3 V/m, 80-1000 MHz
	IEC 61000-4-4:1995 / EN 61000-4-4:1995	0.5 kV signal lines
	IEC 61000-4-6:1996 / EN 61000-4-6:1996	3 V, 0.15-80 MHz 1 cycle, 100%
	Canada: ICES-001:1998	
	Australia/New Zealand: AS/NZS 2064.1	
	The product was tested in a typical configuration with Agilent Technologies test systems.	
<b>Safety</b>	IEC 61010-1:2001 / EN 61010-1:2001	
	Canada: CSA C22.2 No. 1010.1:1992	
	UL 61010B-1: 2003	

**Supplementary Information:**

**This DoC applies to above-listed products placed on the EU market after:**

20 April 2004

Date



**Ray Corson**

Product Regulations Program Manager

---

**82357A Specifications**

---

---

## **82357A Specifications**

This appendix lists 82357A USB/GPIB Interface Converter Technical Specifications and Supplementary Information.

## Technical Specifications

<b>General Requirements</b>	
Minimum System Requirements	Windows 98 Second Edition /Me/2000/XP Professional, Pentium® - 200, 64 MB RAM, 55 MB free disk space, USB port (OS and Microsoft .NET Framework may require more resources)
Supported Standards	USB 1.1*, IEEE-488.1 and IEEE-488.2 compatible, SICL and VISA 2.2
Supported Applications (with IntuiLink)	Microsoft Excel 97 and 2000; Microsoft Word 97 and 2000. Check the web for latest supported applications.
Supported Software Development Applications	Visual Basic 6.0, Visual C++ 6.0, Visual Studio .NET, Agilent VEE 6.0 or greater, BASIC for Windows, LabVIEW 6.0 or greater
<b>General Characteristics</b>	
Power	USB bus powered device, +5V, 500 mA (max), 200 mA (typ)
Connectors	Standard 24-pin IEEE-488, Standard USB A
USB Hubs	Self-powered hubs (Optional)
Dimensions	105 mm (L) x 64 mm (W) x 30 mm (H) (includes connectors)
Weight	215 grams
Cable	2.5 Meters, shielded, 1500 insertions
Indicators	READY, ACCESS, FAIL
Warranty	1 year
<b>Environmental Specifications</b>	
Operating Environment	0°C to 55°C
Storage Environment	-40°C to +75°C
Humidity	up to 65% (0°C to 40°C)
Storage Humidity	up to 65% (0°C to 55°C)
<b>Ordering Information</b>	
Interface	82357A USB/GPIB Interface Converter
Options	Opt 0B1 - Add Manual Set
Accessories	None

\* USB 2.0 interfaces support the USB 1.1 standard.

---

## Supplementary Information

This section provides supplementary information on the 82357A performance, including supported GPIB modes. The 82357A is defined as a **controller** as it can be (and is required to be) the system controller.

### GPIB Modes of Operation Supported

The 82357A supports standard GPIB modes of operation, except for:

- Parallel Poll (PPOLL)
- Passing of Active Controller
- Non-System Controller mode, which prevents using SICL Commander sessions or VISA Servant sessions

### IEEE-488.1 and IEEE-488.2 Compliance

The 82357A is in full compliance with IEEE 488.1 and IEEE-488.2 specifications. The 82357A fully supports IEEE-488.1 subsets AH1, C1, C2, C3, C4, C27, DC0, DT0, LE3, PP0, RL0, SH1, SR0, and TE7.

### SRQ Response Time

SRQ response time is slower than with the 82350 PCI GPIB interface as an artifact of the USB implementation. In addition, sharing the USB bus with other devices may impact GPIB performance.

### Default T1 Delay

The default T1 delay for the 82357A is 800 nsec. See “Setting 82357A High-Performance Operation” in *Chapter 2 - Using the 82357A* for details.

### Maximum 82357A System Configuration

Up to four 82357As on a system have been successfully tested.

**A**

Agilent IO Libraries Suite, verify  
  installation, 49  
Agilent telephone number, 56  
Agilent Web site, 56

**C**

changing configuration parameters, 39  
changing modes of operation, 40  
check IO Control operation, 52  
check PC, 47  
check USB cables, 47  
check USB interface, 47  
check USB scanner, 53  
checking shipment, 8  
compliance, IEEE, 66  
configuration parameters, changing, 39  
configuration parameters, setting, 39  
connecting 82357A to PC, 14  
connecting 82357A to USB hub, 15  
Connection Expert, 21–25, 31, 36–40, 52  
  Administrator privileges required, 10  
copyright information, 61  
custom configuration, setting, 24

**D**

Declaration of Conformity, 61  
default configuration, setting, 21  
device manager, checking, 48

**E**

examples  
  IO Interface Configuration, 31

**H**

hardware checks, 47  
hardware description, 13  
high-performance operation, setting, 41

**I**

initial operating states, 35  
installing the 82357A  
  before you install, 8  
  configuring the 82357A, 21  
  connecting GPIB instruments, 27  
  connecting the 82357A, 13  
  installing IO Libraries Suite, 10  
  programming via 82357A, 29  
  steps to install, 7  
interface ID, 31  
Interface Name, 31  
IO Control operation, checking, 52  
IO interface, 31  
IO Libraries Suite, checking for installation,  
  10  
iopen, 31

**L**

LED states, 35  
Logical Unit Number, 31

**M**

maximum system configuration, 66  
modes of operation, changing, 40  
multiple 82357A operation, 38  
multiple mode of operation, 36

**P**

PC  
  power management, 49  
  suspend, 49  
PC, checking, 47  
PC, rebooting, 47  
printing history, 61  
programming GPIB instruments, 30

## R

rebooting the PC, 47  
restricted rights, 60

## S

service and support, 56  
service information, 56  
setting configuration parameters, 39  
setting custom configuration, 24  
setting default configuration, 21  
setting high-performance operation, 41  
setting timeout floor values, 40  
single 82357A operation, 37  
single mode of operation, 36  
software configuration checks, 52  
software installation checks, 49  
specifications, 65  
SRQ operation, 38  
SRQ performance, 66  
supplementary information, 66  
suspend/resume operation, 49  
system requirements, checking, 9

## T

T1 delay, default, 66  
telephone number, Agilent, 56  
timeout floor values, setting, 40  
trademark information, 61  
troubleshooting  
    check device manager, 48  
    hardware checks, 47  
    software configuration checks, 52  
    software installation checks, 49  
    suspend/resume operation, 49  
troubleshooting flowchart, 45  
troubleshooting the 82357A, 44

## U

USB cables, checking, 47  
USB driver installation, verifying, 51  
USB interface, checking, 47  
USB scanner, checking, 53

usbscan driver, assigning to 82357A, 55  
usbscan.sys, 9  
usbscan.sys, checking, 54  
using the 82357A, 34

## V

viOpen, 31  
VISA Assistant, 29

## W

warranty, 60  
Web site, Agilent, 56  
Windows plug and play manager, 17





**Agilent Technologies**

Agilent Technologies, Inc.  
Printed in Malaysia  
November 2004 E1104



**User's Guide**

**82357-90002**