

VALHALLA SCIENTIFIC, INC.

MODEL 2500EP/EN
AC/DC CURRENT CALIBRATOR

OPERATION MANUAL



9955 MESA RIM ROAD
SAN DIEGO, CA 92121
(619) 457-5576
(619) 457-0127 Fax

CERTIFICATION

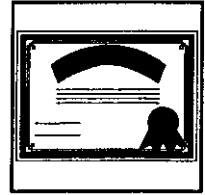

Valhalla Scientific, Inc. certifies that this instrument was thoroughly tested and inspected and found to meet published specifications when shipped from the factory. Valhalla Scientific, Inc. further certifies that its calibration measurements are traceable to the National Institute of Standards and Technology to the extent allowed by NIST's calibration facility.

WARRANTY

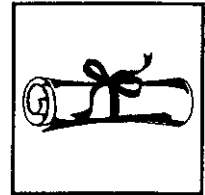

The warranty period for this instrument is stated on your invoice and packing list. Please refer to these to determine appropriate warranty dates. We will repair or replace the instrument during the warranty period provided it is returned to Valhalla Scientific, Inc. freight prepaid. No other warranty is expressed or implied. We are not liable for consequential damages. Permission and a return authorization number must be obtained directly from the factory for warranty repairs. No liability will be accepted if returned without such permission. Due to continuing product refinement and due to possible parts manufacturer changes, Valhalla Scientific reserves the right to change any or all specifications without notice.

TABLE OF CONTENTS

SECTION I UNPACKING & INSTALLATION



- 1-1 Introduction
- 1-2 Initial Inspection
- 1-3 Power Requirements
- 1-4 Installation

SECTION II SPECIFICATIONS & OPTIONS



- 2-1 2500EP Accuracy
- 2-2 2500EN Accuracy
- 2-3 General Specifications
- 2-4 Options

SECTION III FRONT PANEL CONTROLS



- 3-1 General
- 3-2 Input Voltage Terminals
- 3-3 Power Switch
- 3-4 Zero Adjustment
- 3-5 Range Switch
- 3-6 Output Current Terminals
- 3-7 Output Fuse
- 3-8 Standby/Operate Switch
- 3-9 Overload LED

Figure 3-1. 2500EP Front Panel

SECTION IV REAR PANEL CONTROLS



- 4-1 General
- 4-2 Remote Current Range Programming
- 4-3 Power Receptacle
- 4-4 Fuseholder
- 4-5 AC Line Voltage Selector
- 4-6 Input Voltage Terminals
- 4-7 Output Current Terminals
- 4-8 Voltage Input (Option CK-R)
- 4-9 Air Intake
- 4-10 Air Exhaust

Figure 4-1. 2500EP Rear Panel

SECTION V MANUAL OPERATION

- 5-1 General
- 5-2 Applying AC Power
- 5-3 Connections
- 5-4 Range Selection
- 5-5 Zero Adjustment
- 5-6 Overload Indicator
- 5-7 Using AC Currents
- 5-8 Error Sources

SECTION VI REMOTE OPERATION

- 6-1 General
- 6-2 GPIB Operation (using 2701C)
- 6-3 Remote Operation (direct)

Table 6-1. Remote Range Programming Connector (Pin Functions)

SECTION VII CALIBRATION PROCEDURE

- 7-1 General
- 7-2 Required Test Equipment
- 7-3 Initial Settings
- 7-4 Routine Calibration (DC)
- 7-5 AC Calibration

Table 7-1. Range Calibration Adjustments

SECTION VIII MAINTENANCE

- 8-1 General
- 8-2 Cleaning
- 8-3 Troubleshooting

SECTION IX THEORY OF OPERATION

- 9-1 General
- 9-2 Functional Description
- 9-3 Detailed Circuit Descriptions

SECTION X SPECIAL PROCEDURES

- 10-1 Driving Inductive Loads
- 10-2 Capacitive Loads
- 10-3 Ground Loops

SECTION XI PARTS LISTS**SECTION XII DRAWINGS & SCHEMATICS**

SECTION I UNPACKING & INSTALLATION

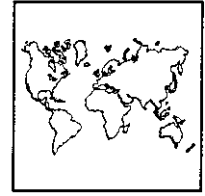

1-1. Introduction

The Valhalla Scientific Model 2500EP and 2500EN are wide range voltage-to-current converters, also known as "transconductance amplifiers". These devices are capable of translating a precise input voltage into a proportional output current. The output current possesses the same amplitude, frequency, and phase characteristics as the input voltage.

Both models feature a remote range programming capability, and may be linked with the Valhalla Model 2701C for IEEE-488 interface control. The 2500EP is the standard model featuring a 0-2V input range. The 2500EN is the high impedance model featuring a 0-20V input range.

1-2. Initial Inspection

If the external shipping container shows evidence of damage, it should be immediately brought to the attention of the carrier and such damage noted on the bill of lading.

Unpack the instrument and retain the shipping container until the instrument has been inspected for possible damage in shipment. If shipment damage is apparent, notify the carrier and obtain authorization for repairs before returning the instrument to the factory. If the external shipping container shows evidence of damage, but the instrument shows no external damage, it may be advisable to check the performance of the unit to determine that the instrument has not sustained hidden damage.

1-3. Power Requirements

The instrument is shipped from the factory for operation at either 115VAC or 230VAC, 50 to 60 Hz. This voltage range is selectable via the rear panel switch. All units are set for 115VAC unless otherwise noted. When 115VAC is selected, the unit will operate at line voltages of 103 to 127 volts. When 230VAC is selected, the unit will operate at line voltages of 206 to 250 volts. The rear panel fuse value is 5 amps in the 115VAC position and 3 amps in the 230VAC position.

1-4. Installation

If the Model 2500EP/EN is to be used in the bench top configuration, installation requires only that the line cord be connected to the rear panel connector and the other end inserted into the appropriate wall receptacle. A rear panel mounted fuse provides protection for the internal circuits.

A three contact power connector and grounded outlet is required for safe operation of the 2500EP/EN. If an extension cord is used, it must be a three-contact type and provide a continuous ground.

CAUTION!

Operation of the 2500EP/EN without proper grounding can be hazardous.

If the unit is to be installed in a rack, install the rack ears (Option R2) using the hardware provided. Then it is necessary only to locate the unit in the rack and make

the power source, input and load connections. Care must be taken to ensure a free flow of air around the calibrator's air ducts or dangerous overheating may occur.

The unit should be operated only in areas where the ambient temperature does not exceed 50°C. If the internal temperature of the rack system in which the unit is installed will exceed this temperature limit, forced air cooling should be employed to maintain the ambient air at or below the 50°C limit.



2-3. General Specifications

Input Impedance	100k Ω (10M Ω for 2500EN)
Output Capacitance	500pF
Compliance Voltage	10V _{Peak} linearly decreasing to 7V _{Peak} @ 10A _{RMS}
Short-term Maximum Output	12A _{RMS} for 2 minutes maximum (25% max duty cycle)
Maximum Input Voltage	3V _{Peak} (30V _{Peak} for 2500EN) without damage
Output Protection	Fuse protected @15 amps
Common Mode Voltage (input→output)	10V _{Peak} maximum
Common Mode Voltage (to ground)	100V _{Peak} maximum
CMRR (input→output)	60dB RTI at DC linearly decreasing to 40dB at 5kHz
Temperature Range	Operating 0°C to 50°C (Storage -40°C to 70°C)
Humidity	70% RH maximum @ 45°C (non-condensing)
Temperature Coefficient	10% of Accuracy specification per °C
Size	17"(43cm)W x 17"(43cm)D x 5.5"(13.5cm)H
Weight	29lbs (13.5kg) net / 36lbs (16.5kg) shipping



SECTION II SPECIFICATIONS & OPTIONS



2-1. 2500EP Accuracy (12 months at 20°C to 30°C)

Range	Maximum Output	Maximum Input [1]	Accuracy (DC to 5kHz maximum)	
			DC (% of output)	AC (% of output)
100 μ A	200 μ A	2V	$\pm 0.01\% \pm 40\text{nA}$	$\pm 0.05\% \pm 200\text{nA}$ [2][3]
1mA	2mA	2V	$\pm 0.01\% \pm 400\text{nA}$	$\pm 0.05\% \pm 2\mu\text{A}$ [2]
10mA	20mA	2V	$\pm 0.01\% \pm 4\mu\text{A}$	$\pm 0.05\% \pm 20\mu\text{A}$ [2]
100mA	200mA	2V	$\pm 0.01\% \pm 40\mu\text{A}$	$\pm 0.05\% \pm 200\mu\text{A}$ [2]
1A	2A	2V	$\pm 0.01\% \pm 400\mu\text{A}$	$\pm 0.05\% \pm 2\text{mA}$ [2]
10A	10A	1V	$\pm 0.01\% \pm 4\text{mA}$	$\pm 0.05\% \pm 20\text{mA}$ [2]

- [1] DC or AC_{RMS}
 [2] Add $\pm 0.01\%$ of range x compliance voltage x frequency (kHz) for compliance voltages greater than 2V_{RMS}.
 [3] Add $\pm 0.5\%$ of output above 1kHz.

2-2. 2500EN Accuracy (12 months at 20°C to 30°C)

Range	Maximum Output	Maximum Input [1]	Accuracy (DC to 500Hz maximum)	
			DC (% of output)	AC (% of output)
100 μ A	200 μ A	20V	$\pm 0.01\% \pm 40\text{nA}$	$\pm 0.05\% \pm 200\text{nA}$ [2]
1mA	2mA	20V	$\pm 0.01\% \pm 400\text{nA}$	$\pm 0.05\% \pm 2\mu\text{A}$ [2]
10mA	20mA	20V	$\pm 0.01\% \pm 4\mu\text{A}$	$\pm 0.05\% \pm 20\mu\text{A}$ [2]
100mA	200mA	20V	$\pm 0.01\% \pm 40\mu\text{A}$	$\pm 0.05\% \pm 200\mu\text{A}$ [2]
1A	2A	20V	$\pm 0.01\% \pm 400\mu\text{A}$	$\pm 0.05\% \pm 2\text{mA}$ [2]
10A	10A	10V	$\pm 0.01\% \pm 4\text{mA}$	$\pm 0.05\% \pm 20\text{mA}$ [2]

- [1] DC or AC_{RMS}
 [2] Add $\pm 0.01\%$ of range x compliance voltage x frequency (kHz) for compliance voltages greater than 2V_{RMS}.

2-4. Options

The Model 2500EP/EN is shipped from the factory with a detachable power cord, a "Remote Ranging" interface connector, and an operation manual. Available options are listed below.

Model 2009: Buffer Amplifier

The Valhalla Model 2009 is a battery operated precision buffer amplifier with a gain of 1.0000. The Model 2009 has an input impedance of $10^{10}\Omega$ and an output impedance of 10Ω maximum. The 2009 has a frequency response of DC to 10kHz. This device may be necessary in some applications to eliminate voltmeter loading effects when driving high load impedances.

Option R2: Rack Ears

Use of this option is recommended when mounting the Model 2500EP/EN in a standard 19" equipment rack.

Option BBL: Banana-to-Banana Cable

Option BBL is a 48" shielded cable terminated in dual banana plugs. This cable may be used for input or output connections to the calibrator.

Option SL-48: Low Thermal Leads

Option SL-48 is a 48" shielded lead set terminated in gold-plated spade lugs. This lead set is designed to eliminate problems caused by thermal EMF's and is rated for the maximum output current of the instrument.

Option C: Banana-to-Clip Cable

Option C is a 48" general purpose shielded lead set terminated on one end in a dual banana plug and on the other end in red and black copper alligator clips.

Option CK-R: Rear BNC Connector

The Model 2500EP/EN may be equipped with a rear input voltage BNC-type connector which may be useful when mounting the instrument in a rack system. The mating cable is 48" in length and designated as Option CK.

Option CK: BNC-to-BNC Cable

Option CK is a 48" shielded cable terminated in BNC connectors at both ends.

Replacement Filter Element

The rear intake filter must be periodically cleaned to allow unrestricted air flow. If the filter becomes heavily soiled, replacements are available as Valhalla Stock #05-10494.



SECTION III FRONT PANEL CONTROLS

3-1. General

This section outlines the function of each of the front panel controls and connectors. Refer to Figure 3-1 for a pictorial diagram. The user is advised to review Section 5 for a complete description of the operating principles of the 2500EP/EN.

3-2. Input Voltage Terminals [1]

The polarity, amplitude, and phase of the output current is directly proportional to the signal applied at these terminals.

3-3. Power Switch [2]

This switch applies or removes power to the internal circuits of the instrument.

3-4. Zero Adjustment [3]

This hole provides access to the zero adjustment potentiometer. The instrument should be warmed up for at least one hour before making the adjustment. See Section 5-5 for more details on setting the zero level.

3-5. Range Switch [4]

This rotary switch is used to select one of the six possible current ranges. It should be placed in REMOTE when using the remote ranging function (See Section 6). A red LED indicates the present range selected.

3-6. Output Current Terminals [5]

These terminals provide a current output that is directly proportional to the frequency, amplitude and phase of the signal at the Input Terminals.

3-7. Output Fuse [6]

This fuse is used to protect the output from levels greater than $15A_{RMS}$. If problems are observed with the instrument, check this fuse first. **Always replace with the same type and rating fuse.**

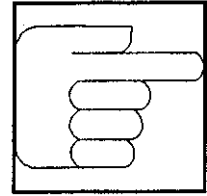

3-8. Standby/Operate Switch [7]

When the Standby/Operate switch is depressed (green dot showing), the unit is in the STANDBY mode. In this mode the input terminals are open-circuited and an internal short is placed across the input to the current source. A $1k\Omega$ resistor is also placed across the output terminals. This has the effect of shutting off the current amplifier regardless of the input signal, and eliminates the need to disconnect the input signal in order to turn off the current flow.

3-9. Overload LED [8]

This indicator illuminates when the instrument is in an out-of-compliance situation. If this indicator is illuminated, the output is unreliable and the current range or input signal should be reduced and/or the value of the load decreased. This occurs when the output voltage level (compliance voltage) exceeds approximately 10 volts.

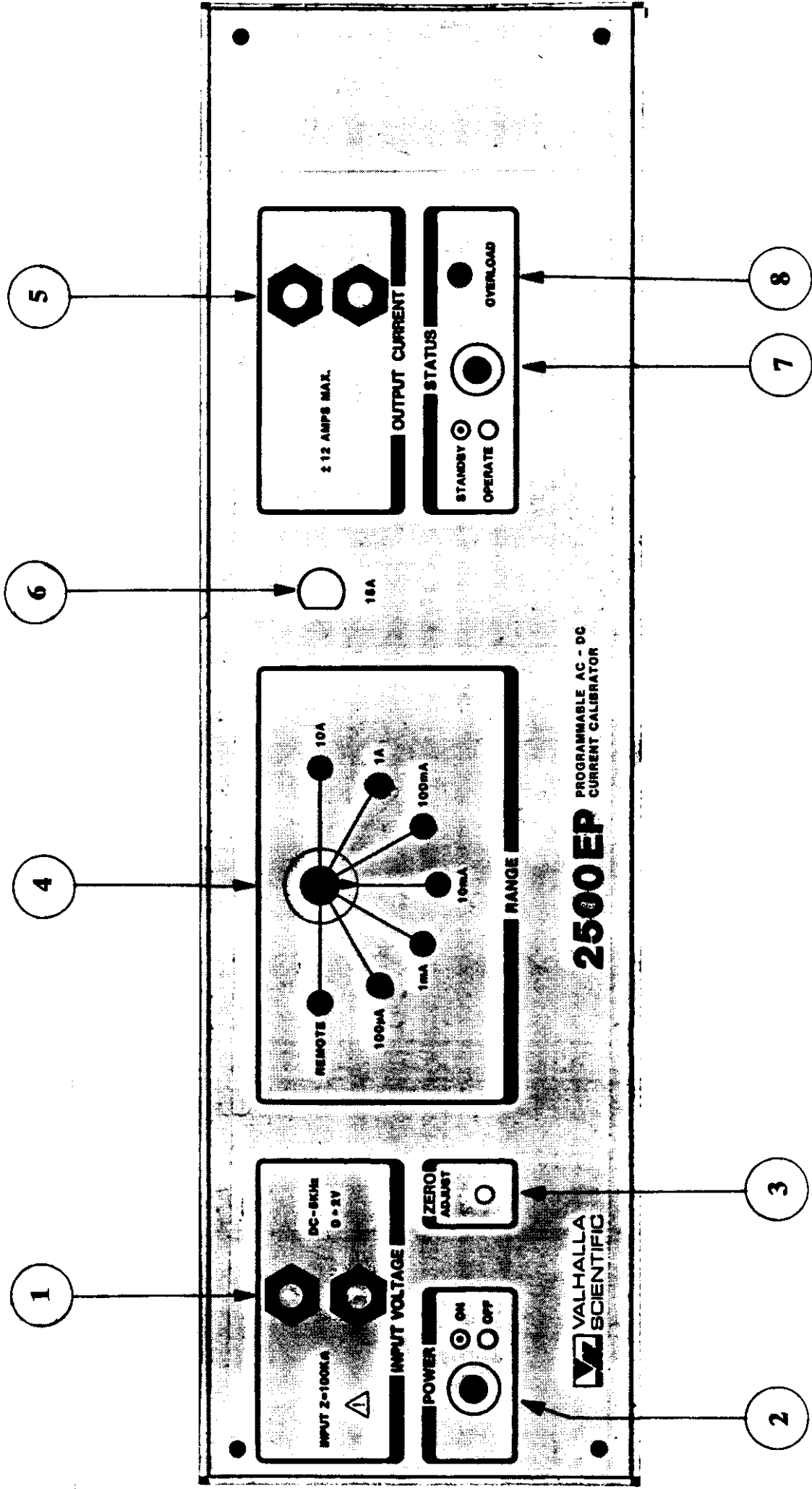
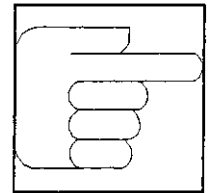

Figure 3-1. 2500EP Front Panel



SECTION IV REAR PANEL CONTROLS



4-1. General

This section describes the function of the rear panel controls and connectors. See Figure 4-1 for a pictorial diagram.

4-2. Remote Current Range Programming [1]

This connector allows remote range switching of the 2500EP/EN current calibrator. This function is detailed in Section 6.

4-3. Power Receptacle [2]

The 2500EP/EN is supplied with a detachable power cord that mates with this receptacle. If a longer cord is necessary, use a heavy-duty 3-prong type extension cord *only*.

4-4. Fuseholder [3]

This device contains the AC line fuse. This fuse protects the internal circuitry and should be replaced with an identical part only. See Section 1.

4-5. AC Line Voltage Selector [4]

This slide switch should be set to the local line voltage. See Section 1.

4-6. Input Voltage Terminals [5]

The polarity, amplitude, and phase of the output current is directly proportional to the signal applied at these terminals.

4-7. Output Current Terminals [6]

These terminals provide a current output that is directly proportional to the frequency, amplitude and phase of the signal at the Input Voltage Terminals.

4-8. Voltage Input (Option CK-R) [7]

This auxiliary connector may be installed and duplicates the functions of the voltage input terminals. See Section 2-4.

4-9. Air Intake [8]

This vent supplies cooling airflow for the internal circuits. This vent should *always* be kept clear and a free flow of air provided around it. The grill is removable and should periodically be cleaned with dry compressed air. **Insufficient airflow will result in a dangerous overheating condition!** Note that replacement filters are available as Valhalla Stock #05-10494.

4-10. Air Exhaust [9]

This vent is the exhaust port for the internal cooling fan. Care must be taken to ensure that this vent does not become blocked otherwise a **dangerous overheating condition will result!**

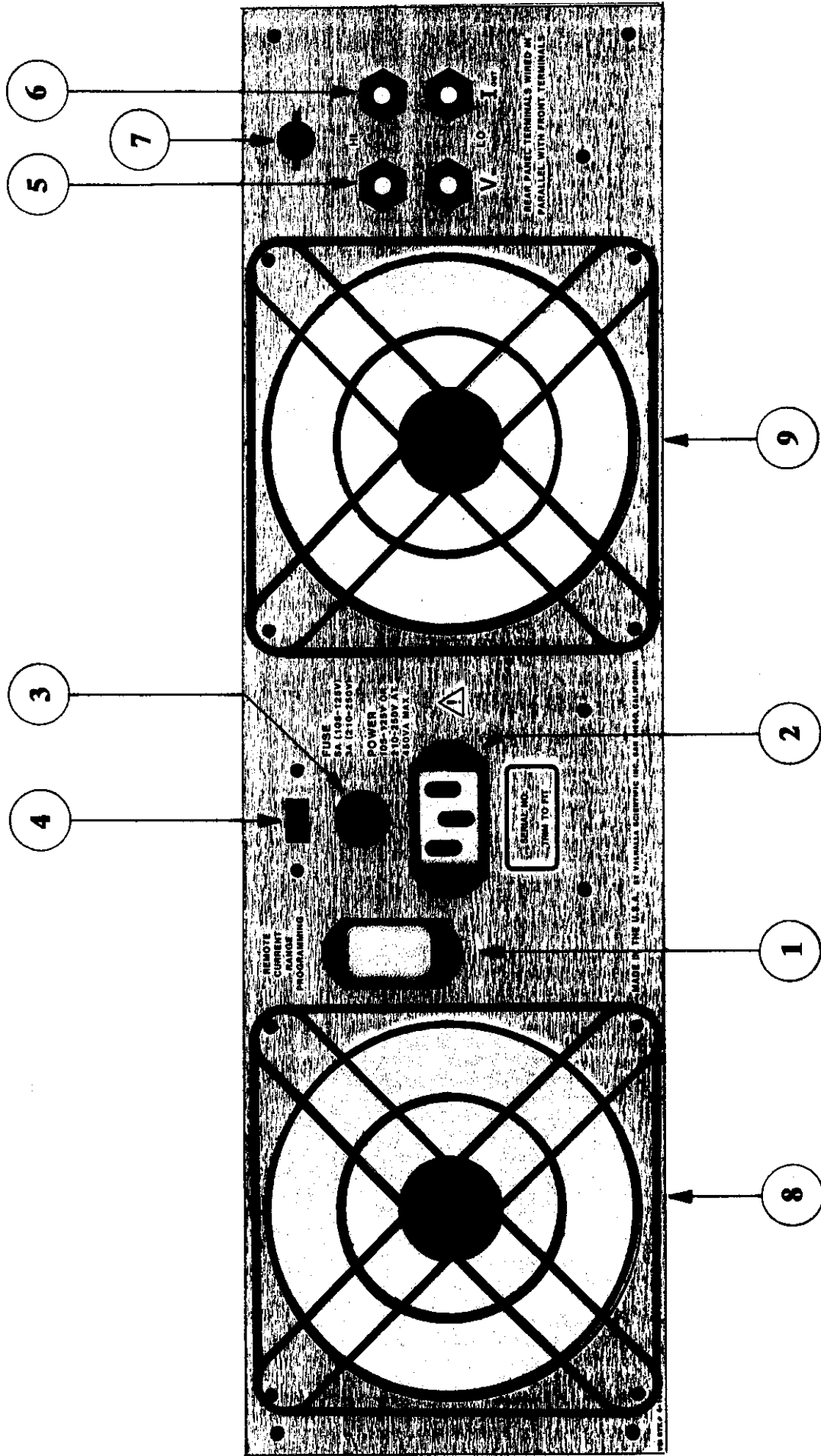

Figure 4-1. 2500EP Rear Panel



SECTION V MANUAL OPERATION

5-1. General

This section describes the operating principles of the Model 2500EP/EN current calibrator. Also listed are some common error sources such as parallel capacitance and series inductance. The user should have a good understanding of this section before attempting to operate the current calibrator.

The polarity and level of output current is directly proportional to that of the input applied to the Voltage Input terminals. A zero input will cause the 2500EP/EN to produce zero output current. As the input is increased, the output current will increase proportionally.

For example, if the 1mA range is selected and an input of +1VDC (+10VDC for 2500EN) is applied, the calibrator will produce an output current of 1.0000mA. An input of 1VAC (10VAC for 2500EN) will provide an output current of 1.0000mA that has the frequency, phase and amplitude characteristics of the input signal.

5-2. Applying AC Power

Before applying AC power to the instrument, ensure that the front panel POWER switch is in the OFF position and the front panel status switch is in the STANDBY position. Equipment should not be connected to the input or output terminals of the 2500EP/EN.

Ensure that the rear panel slide switch is set for the correct local line voltage and then turn on the front panel POWER switch. The appropriate range LED should illuminate and operation of the cooling fan should be observed. If not, turn off the POWER switch and check the line connections and line fuse for integrity.

5-3. Connections

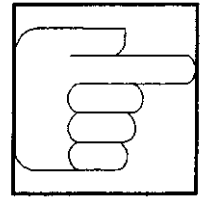

The 2500EP/EN has approximately a 10 volt compliance voltage for most applications. This means that the calibrator can supply a constant current to the load provided that the voltage drop across the *total* load (cables included) remains lower than the compliance limit. The size and length of the current carrying leads must be chosen so that the voltage drop across them does not exceed this limit.

Twisted, paired leads are recommended for currents above 1mA and/or frequencies above 100Hz. At very low current levels single leads must be used to prevent a shunt effect between the conductors of these cables. Refer to the table below for the recommended wire gauge. The gauges listed are based on a standard 4' cable length. If a longer length is necessary, the gauge of the wire used must be increased accordingly.

<u>Current</u>	<u>Wire Gauge</u>
10 amps	16AWG or heavier
1 amp	18AWG or heavier
< 100mA	20AWG or heavier

Note: Prior to connecting or removing a load from the calibrator, the user should always place the 2500EP/EN Status switch in the STANDBY position.

5-4. Range Selection

The output current range of the 2500EP/EN can be selected by a rotary knob on the front panel of the instrument or by remote signal. Remote range switching is discussed in Section 6.

The range is selected depending on the needs of the user. The available output on

any given range is 0 to 200% of that range. For example, the 1A range may be used for outputs from 0 amps to 2 amps maximum. As a general rule, the greatest accuracy is obtained by using a given range from 10% to 200% of its rated output. (i.e. from 200 milliamps to 2 amps on the 1A range) If a lower level of current is required, the calibrator should be switched to the 100mA range (in this example) by turning the rotary knob until the corresponding LED is illuminated on the front panel of the 2500EP/EN.

Note: It is recommended that the Status switch be placed in the STANDBY mode prior to changing ranges to prevent possible transient current flow and damage to the load.

5-5. Zero Adjustment

The Model 2500EP/EN has been designed to allow the user access to the zero level adjustment potentiometer. This adjustment may be necessary if there is an output current offset between +/- polarities, or to compensate for any leakage current when the unit is in the STANDBY mode. This procedure may be performed at any time provided the unit has been powered for at least 1 hour prior to making the adjustment. The following procedure is recommended:

- 1) Place the Status switch in the STANDBY mode.
- 2) Remove all connections from both the Input and Output terminals.
- 3) Place a short circuit between the desired set of Input terminals (front or rear).
- 4) Select the 1mA range with the selector knob.
- 5) Connect a 1k Ω 5% resistor across the Output terminals and monitor the voltage drop across it with a voltmeter

having at least 0.003% accuracy and 10 μ V resolution.

- 6) Select OPERATE with the front panel Status switch.
- 7) Adjust the zero potentiometer for an indication on the voltmeter of 0 \pm 100 μ V.

5-6. Overload Indicator

The Overload LED on the 2500EP/EN front panel is provided to alert the user to conditions that are outside of the capabilities of the instrument. This LED will illuminate if the calibrator is unable to deliver the requested current to the load due to excessive compliance voltage requirements. For example, the calibrator could not deliver 1 mA to a 100k Ω load, because the voltage necessary to do so would be approximately 100 volts. If this indicator is illuminated the output current should not be used.

Listed below are some common situations that will trigger the LED.

- a) **The value of the load is too high.** The calibrator must be operated within its compliance limits (\pm 10 volts).
- b) **The resistance in the cables is too high.** The impedance of the cables must be added to the value of the load when determining if the total load is within compliance limits. Cable impedance can be reduced by shortening the leads and/or increasing the wire size.
- c) **The protection fuse is blown.** A blown front panel fuse will cause the Overload LED to illuminate regardless of the load or requested current level. Replace blown fuses with their exact equivalent *only*.



5-7. Using AC Currents

There are certain characteristics of alternating current (AC) that must be considered before using this type of constant-current calibrator. These are the effects of *parallel capacitance* and *series inductance*. Both items will affect the overall accuracy of the measurements taken and must be taken into account. These sources of error are described below.

5-7-1. Parallel Capacitance

Resistance or capacitance in parallel with the load will "steal" current from the load, producing an apparent error in the output of the 2500EP/EN.

For example, if the 100 μ A range of the calibrator is used to drive a 10k Ω load at 5kHz and the voltage across the load is monitored by a voltmeter having a 100pF input capacitance with 5-foot RG58A/U coaxial cables, the total parallel capacitance across the 10k Ω load is: 50pF (from the 2500EP/EN) + 100pF (the DVM) + 150pF (the cables). This 300pF will cause an error of 0.44% in the current flowing through the load.

The actual equation for the effect of parallel capacitance is as follows:

$$\% = -100 \times \left(\frac{1}{\sqrt{1 + (2 \times \pi \times f \times R_L \times C)^2}} - 1 \right)$$

Where:

% is the amount of error in percent
 R_L is the load resistance in ohms
 C is the parallel capacitance in Farads
 π is the value of pi (3.1415927)
 f is the frequency in Hertz

5-7-2. Series Inductance

Any internal inductance within the load will cause the load's impedance to increase with frequency and cause apparent errors in the output of the 2500EP/EN. As an example, if the 10A range is used to drive a 0.1 Ω resistor with 0.5 μ H series inductance, the voltage across the resistor will be 1.23% higher than expected at 5kHz.

Very low levels of inductance within the load are required to correctly evaluate high frequency performance. It is this type of inductance that prevents most laboratory standard resistors from being used for making AC measurements. The use of specially manufactured non-inductive high frequency shunts is necessary for resistances below 5 ohms. The equation for the amount of error caused by series inductance is shown below.

$$\% = 100 \times \left(\sqrt{1 + \frac{(2 \times \pi \times f \times L_S)^2}{R_L^2}} - 1 \right)$$

Where:

% is the amount of error in percent
 R_L is the load resistance in ohms
 L_S is the series inductance in Henries
 f is the frequency in Hertz
 π is the value of pi (3.1415927)

There is a "second order" effect of total load inductance causing increased compliance voltage requirements on the 2500EP/EN at higher frequencies. This is the reason for the reduced compliance voltage specification shown in Section 2-3.



5-8. Error Sources

There are certain potential sources of error that the user should be aware of when working with either AC or DC. These are *source impedance* and *voltmeter impedance*.

5-8-1. Source Impedance

Source impedance errors occur at the input to the 2500EP/EN. This error source is formed when the output impedance of the signal generator forms a resistor divider with the input impedance of the 2500EP/EN. To maintain this error at 0.01% or less, the ratio of source:input impedance must be 1:10,000 or greater.

When using a 2500EP the output impedance of the signal generator should be $\leq 10\Omega$.

When using a 2500EN the output impedance of the signal generator should be $\leq 1000\Omega$.

5-8-2. Voltmeter Impedance

Voltmeter impedance errors occur when the voltmeter input impedance forms a resistor divider with the load impedance. To maintain this error at 0.01% or less, the ratio of load:voltmeter impedance must be kept at 1:10,000 or greater. For example, if the value of the load is $10k\Omega$, the input impedance of the voltmeter must be $100M\Omega$ or greater.

To eliminate this problem, Valhalla offers a precision buffer amplifier, Model 2009, that has an input impedance of 10^{10} ohms and a gain of 1.0000. See Section 2-4 for details.

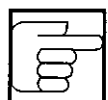

<u>Pin Number(s)</u>	<u>Signal Name</u>	<u>Function</u>
1	10A	+5V selects 10A range
2	1A	+5V selects 1A range
3	100mA	+5V selects 100mA range
4	10mA	+5V selects 10mA range
5	1mA	+5V selects 1mA range
6	100 μ A	+5V selects 100 μ A range
7	0V	All voltages are referenced to this pin
9,12	Overload	Relay closure on these pins if overload LED is on
8,10,11,13,14	no connection	

Table 6-1. Remote Range Programming Connector (Pin Functions)



SECTION VI REMOTE OPERATION

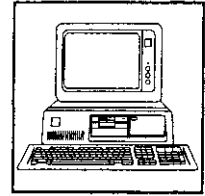

6-1. General

The Valhalla Model 2500EP/EN has been designed to allow remote ranging capability. This feature is directly compatible with the Valhalla Model 2701C DC Voltage Standard, which allows both units to be controlled via the IEEE-488 GPIB. The 2500EP/EN may also be controlled without using the 2701C. Both methods are described below.

6-2. GPIB Operation (using 2701C)

The 2500EP/EN may be controlled via the GPIB IEEE-488 bus by using the Valhalla Model 2701C as its controller. Follow the steps below describing operation in this manner.

- 1) Connect the 2500EP/EN to the 2701C using the interface cable provided. Connect the 2701C SENSE terminals to the voltage input of the 2500EP/EN using Valhalla Option "BBL" or similar.
- 2) Set the 2500EP/EN range switch to REMOTE.
- 3) Apply power to both instruments. The details regarding remote operation and the appropriate IEEE commands are described in the 2701C operation manual.

6-3. Remote Operation (direct)

The 2500EP/EN may be controlled by a custom switching device connected directly to the rear panel of the calibrator. Refer to Table 6-1 for pin functions of the rear panel connector.

The range control signals (pins 1-6) require a drive current of approximately 10mA and must be +4 to +6 volts above the level of pin 7 (common) to trigger the desired range. The circuits connected to these pins are fully isolated from the other circuits in the 2500EP/EN and may be up to 100V_{Peak} from either ground or the output of the current calibrator.

The contact closure between pins 9 and 12 is also completely isolated and is rated at 100V/100mA. This contact closure is available whether or not the calibrator is being remotely ranged.

The selected range is indicated on the front panel by the illumination of the corresponding LED. It is recommended that a short overlap period be allowed when changing ranges. **Selection of no range or more than one range is not recommended.**

Note: The range selection pins are only enabled when REMOTE has been selected using the front panel range selector knob.

SECTION VII CALIBRATION PROCEDURE

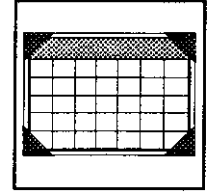

7-1. General

The following paragraphs describe the routine calibration procedures involved in maintaining the 2500EP/EN at its specified accuracy. It is assumed that the user is familiar with the normal operating procedures and principles of the instrument and that Section 5 has been reviewed.

7-2. Required Test Equipment

Routine calibration of the Model 2500EP/EN Current Calibrator is required to ensure that the instrument remains within the specifications described in Section 2. The recommended calibration interval is 12 months.

The following equipment is required to perform the procedures described in this section:

- 1) DC Voltage Standard with ranges from 1V to 10V, 0.003% accuracy (Valhalla 2701C or equivalent)
- 2) DC Voltmeter having at least 10 μ V resolution and 0.003% accuracy (HP3458A or equivalent)
- 3) Precision DC current shunt resistors with 0.003% accuracy having the values and current ratings indicated below:

<u>Resistance</u>	<u>Current Rating</u>
.1 Ω	10 Amps *
1 Ω	1 Amp *
10 Ω	100 mAmps *
100 Ω	10 mAmps *
1k Ω	1 mAmps *
10k Ω	100 μ Amps

* May be replaced by Valhalla Model 2575A

- 4) 1k Ω 5% ¼W general purpose carbon resistor

Note: The Model 2500EP/EN may also be returned to Valhalla Scientific for an NIST traceable calibration.

7-3. Initial Settings

The following procedure may be performed at any time however does not need to be included in the regular calibration procedure. This adjustment is set at the factory and usually need be performed only following component replacement. If the adjustment is made, it should be followed by a full calibration.

- 1) Select STANDBY on the front panel Status switch.
- 2) Select the 1A range using the front panel RANGE switch.
- 3) Short the Output Terminals together.
- 4) Connect the voltmeter between the rear ends of R7 and R8.
- 5) Connect the DC voltage standard between the Input and Output LO terminals of the 2500EP/EN.
- 6) Alternate the output of the Voltage Standard from 0V to 10V and adjust RV3 until no change in DVM reading is observed (within 1mV).

7-4. Routine Calibration (DC)

The following procedure should be used to ensure that the calibrator remains within its specification limits. The location of the adjustment potentiometers is shown on

drawing number 2500-604 at the back of this manual and is indicated on the board itself. The instrument should be warmed up for at least 1 hour prior to calibration.

7-4-1. Output Zero Adjustment

This procedure should be performed prior to the range calibration adjustments below.

- 1) Select the 1mA range using the 2500EP/EN RANGE switch.
- 2) Short circuit the Input Terminals.
- 3) Select OPERATE using the front panel Status switch.
- 4) Connect the 1k Ω general purpose resistor across the Output Terminals.
- 5) Connect the DC voltmeter across the leads of the 1k Ω resistor.
- 6) Adjust the front panel Zero potentiometer (RV1) for a reading on the voltmeter of $\pm 100\mu\text{V}$ or less. Remove all connections.

7-4-2. Range Adjustments

Each range of the 2500EP/EN is calibrated in a similar manner using the appropriate shunts and potentiometer adjustments. The precision current shunt to use and the corresponding adjustment is given in Table 7-1. The 10A range is calibrated in the sample procedure below.

- 1) Select STANDBY using the front panel Status switch and the 10A range using the Range switch.
- 2) Connect the DC voltage standard to the 2500EP/EN Voltage Input terminals. Select an output of 1.00000 volts from the Voltage Standard (10.0000 volts for 2500EN).

3) Connect the .1 ohm current shunt to the 2500EP/EN Output Terminals. A heavy duty cable set is recommended. (Valhalla Option SL-48 or equivalent)

4) Connect the DC voltmeter across the voltage sensing terminals of the current shunt.

5) Select OPERATE using the front panel Status switch.

6) Adjust RV4 for a voltmeter reading of 0.9995 to 1.0005 volts.

All ranges are calibrated using the same procedure by making the substitutions as shown in Table 7-1.

7-5. AC Calibration

The AC frequency response of this instrument is inherent in its design. Verification of this response requires costly equipment not normally found in most calibration laboratories, therefore it is not discussed in this manual. If you should doubt the integrity of your instrument, please consult the factory.

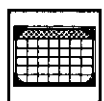

<u>Range</u>	<u>Input Voltage [1]</u>	<u>Current Shunt</u>	<u>Adjust [3]</u>	<u>DVM Reading [2]</u>
10A	1.00000	0.1 Ω	RV4	1.0000
1A	1.00000	1 Ω	RV5	1.0000
100mA	1.00000	10 Ω	RV6	1.0000
10mA	1.00000	100 Ω	RV7	1.0000
1mA	1.00000	1k Ω	RV8	1.0000
100 μ A	1.00000	10k Ω	RV9	1.0000

[1] For 2500EN, use a 10.0000 volt DC input for all ranges.

[2] Adjust for this reading on DVM $\pm 500\mu$ V.

[3] Balance for an equal deviation with \pm input voltage polarities

Table 7-1. Range Calibration Adjustments

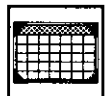

SECTION VIII MAINTENANCE

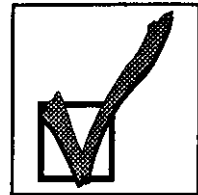

8-1. General

With periodic maintenance your Valhalla Current Calibrator will provide years of trouble-free operation. This section describes preventative maintenance procedures designed to give maximum performance to your Model 2500EP/EN. These procedures are in addition to the routine calibration adjustments described in Section 7.

8-2. Cleaning

It is recommended that the 2500EP/EN be operated in a clean environment. If the environment is dusty, periodic cleaning of the instrument will be required. Cleaning ensures proper cooling and maximum efficiency from heatsinks and other devices.

The most important routine cleaning necessary is that of the rear air intake filter. This filter may be removed for ease of cleaning by first removing the plastic guard cover. The recommended cleaning method is to use dry, compressed air to blow out any debris. If filters are excessively dirty or become damaged, spares may be ordered as Valhalla Stock # 05-10494.

Loose dirt or surface dust may be removed with a soft cloth or brush. Any remaining dirt may be removed with a soft cloth dampened in a mild soap and water solution. **Do not use abrasive cleaners!** The front panel may be cleaned with a soft cloth and a "Windex" type cleaner. **Do not use petroleum based cleaners on the front panel!**

The interior of the 2500EP/EN should be periodically cleaned using dry, compressed air. Ideally this should be done before calibration and after cleaning the rear air

intake filter. The cleaning interval is entirely dependant on usage and environment, however it may be most convenient to combine a thorough cleaning with the calibration described in Section 7.

8-3. Troubleshooting

Malfunctions are often the result of misinterpretation of specifications or to an incomplete understanding of the instrument. **A thorough review of the operating instructions for this instrument is recommended prior to any component replacement, etc.** Check to be sure that cables and other test equipment are in good working order before attempting to troubleshoot the 2500EP/EN.

If the Model 2500EP/EN exhibits problems that cannot be eliminated by reviewing Section 5 and Section 10, the following guidelines have been established to help solve the problem.

8-3-1. Localizing the Problem

The key to successful troubleshooting is to localize the problem as much as possible before trying to pin the problem down to a specific component. Certain questions should be asked such as "Does the problem occur on all ranges or on a specific range only?". The power supplies are also one of the first things that should be checked.

It is not possible to anticipate all failure modes of the 2500EP/EN, therefore servicing personnel should become familiar with Section 9 to gain a complete understanding of the internal workings of the instrument.

8-3-2. Component Replacement

If the problem has been identified as a faulty component, the accuracy of the 2500EP/EN can be maintained only if the following precautions are taken:

- ▲ Use only the specified component or its exact equivalent. Spare parts can be ordered from your nearest Valhalla Scientific Service Center or from the factory directly by referring to the Valhalla Stock Number listed in the parts lists section at the back of this manual.
- ▲ Use only 63/37 grade rosin core electronic grade solder with a 50W or lower maximum power soldering iron.
- ▲ When soldering, heat the terminal of the component, *not* the solder. Apply solder smoothly and evenly. Do not move the component until the solder has cooled. **Bad solder joints can cause additional problems!**
- ▲ Static sensitive parts require special handling procedures. Always treat an unknown part as if it were static sensitive.



SECTION IX THEORY OF OPERATION



9-1. General

This section of the manual contains an explanation of the internal circuitry of the 2500EP/EN. The schematics referenced are located at the rear of this manual. Two types of descriptions are given here. Section 9-2 contains a description of the basic functions of the various circuits. Section 9-3 contains detailed circuit descriptions intended to make troubleshooting to component level possible.

9-2. Functional Description

General

A 1 volt signal applied to the input terminals of the instrument will cause the *input amplifier* to produce an output voltage of 1 volt referenced to the internal common (0V). This voltage is supplied to the error amplifier. The *error amplifier* drives the *output amplifier* to produce the requested output current level. Feedback to the error amplifier compensates for the load placed on the output terminals (within compliance limits).

Input Amplifier

The input amplifier is a unity gain differential amplifier. This converts the differential voltage at the 2500EP/EN Input Terminals to the single ended voltage necessary to drive the error amplifier. Circuitry is also provided to protect the input from accidental voltage spikes.

Error Amplifier

The error amplifier is a high gain differential stage that compares the signal from the input amplifier to the signal from the range switching circuitry. This produces an error signal that drives the output

amplifier. With an output load connected, negative feedback drives the difference between the two error amplifier inputs to zero.

Output Amplifier

The output amplifier is a current booster stage capable of delivering up to ± 12 amps to the load. The output amplifier is controlled by the error amplifier to maintain its output at a precise level.

Range Switching

The range switching circuitry selects one of six precision current shunts for the load current to pass through. The shunts are selected to provide feedback to the error amplifier in order to produce a precise output current level.

Overload Indicator

The overload detector circuitry monitors the compliance voltage of the output amplifier and illuminates when the compliance voltage exceeds approximately 10 volts.

9-3. Detailed Circuit Descriptions

This section includes detailed descriptions of circuitry and is intended to make component level troubleshooting possible. Refer to schematic diagram 2500-074 and assembly diagram 2500-604 at the back of this manual.

Power Supplies

The AC line voltage is stepped down by transformer T1 to provide isolation and to provide the lower voltages needed by the rectifier diodes. The working internal power supplies are $\pm 25V$, $+24VR$ and $\pm 15V$.

The $\pm 25\text{V}$ supplies are used by the output amplifier. The $\pm 25\text{V}$ supplies are rectified by D109-D112 and filtered by C118 and C119. This unregulated supply typically operates from 22V to 28V depending upon load.

The +24VR supply is used to drive the range relays. This supply voltage is regulated from the +25V supply above. Although this supply is not usually maintained at +24 volts, the regulator IC6 is used to protect the relays should the +25V supply exceed approximately 24 volts. The +24VR supply typically operates between 18V to 24V, depending upon the level of the +25V supply.

The $\pm 15\text{V}$ supplies are used to power the remaining integrated circuits. These supplies are regulated from the $\pm 25\text{V}$ supplies above. IC1 regulates the +15V supply and IC2 regulates the -15V supply. These supplies typically operate between 14.8V to 15.2V.

Input Amplifier

The input amplifier is formed by IC3 with feedback elements R5-R8, and RV3. This forms a conventional unity gain differential amplifier stage with zero offset capability provided by RV1. Common Mode Rejection Ratio (CMRR) is adjusted with RV3. Zener diodes D1 and D2 protect the input amplifier from voltage spikes greater than 5 volts.

Error Amplifier

The error amplifier is formed by amplifier IC4. Feedback from the precision internal shunt resistors is sensed at pin 3. This feedback is used to maintain the output current at a precise level, regardless of load (within compliance limits). R10 and C9 provide frequency compensation. Zener diodes D3 and D4 protect the input from voltages greater than 6 volts.

Range Switching

The output current range is changed by placing a different reference current shunt in the feedback loop. The output current passes through this shunt and develops a voltage across it. This voltage is used to provide feedback to the error amplifier which adjusts its output in order to provide a precise output current level.

Relays RLA through RLF are used to place the necessary shunt resistor in the feedback loop. These relays are either driven by contacts in the front panel Range switch or by the contacts of RLG through RLM if the instrument is being remotely ranged (see Section 6).

It should be noted that each range also uses the shunts of every higher current range. Therefore a faulty range shunt may affect other ranges by making their output unusually high or low. Note also that the range relays switch both the current path and voltage sense path to the error amplifier.

Output Amplifier

The output amplifier consists of five pairs of complementary emitter-followers (TR5-TR14) driven by TR3 and TR4. TR3 and TR4 are driven by voltage controlled current sources TR1, TR2 and associated components. The output stage is defined by the diodes D9-D11 along with the 1Ω emitter resistors of the output stage.

Overload Detection

The output of the error amplifier (IC4) is also monitored by a pair of limit comparators formed by portions of IC5. These amplifiers are set up as a "window detector" that triggers the overload indicator whenever the output of the error amplifier exceeds approximately $\pm 12\text{V}$.



SECTION X SPECIAL PROCEDURES

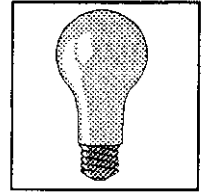

10-1. Driving Inductive Loads

The 2500EP/EN has been designed to have a very wide bandwidth and remain stable when driving inductive loads, however the user must be aware of the following application notes when using inductive loads (transformers, ballasts, coils, and some types of fuses):

- ▲ This type of load becomes a higher impedance as the frequency increases. The actual formula for determining the apparent impedance of the load (Z) is:

$$Z = \sqrt{R_L^2 + (2\pi \cdot f \cdot L)^2}$$

Where:

- Z = impedance of the load (in ohms)
- f = frequency in Hertz
- π = the value of pi (3.1415927)
- L = total inductance in Henries
- R_L = the DC load resistance (Ω)

- ▲ There is no attenuation of any high frequency noise that may be present. It is advisable to shunt the load with a suitable capacitor (usually 100pF is sufficient) to provide a conductive path for high frequency noise.
- ▲ Many loads have self-resonating frequencies within the bandwidth of the 2500EP/EN (typically 1MHz) which may cause apparent oscillation problems. This may usually be cured by shunting the load with a capacitor/resistor combination to lower the Q of this self-resonance.

- ▲ Almost all loads are inductive to some extent, and the **largest problem is caused by the leads used to connect the load.** Use twisted pairs of heavy gauge wires whenever possible.

10-2. Capacitive Loads

Another common effect to consider when using AC current is the effect of cable and load capacitance. RG 58/U coaxial cable, for example, has a capacitance of approximately 300pF per foot. The actual formula for determining the impedance (Z) due to load and cable capacitance is:

$$Z = \frac{R_L \left(\frac{1}{2\pi \cdot f \cdot C_C} \right)}{\sqrt{R_L^2 + \left(\frac{1}{2\pi \cdot f \cdot C_C} \right)^2}}$$

Where:

- Z = impedance of the load (in ohms)
- f = frequency in Hertz
- π = the value of pi (3.1415927)
- R_L = the DC load resistance (Ω)
- C_C = total load capacitance in Farads

10-3. Ground Loops

Ground loops are created when different items of test equipment are grounded at varying points in a system. This ground loop may cause high-frequency oscillations or other problems. To avoid ground loops, plug instruments into the AC line at the same point, or as close together as possible.

SECTION XI PARTS LISTS

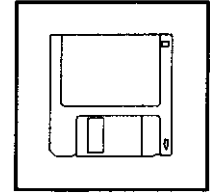

The following parts lists are included with this manual:

2500-405	2500EP Final Assembly
2500-604	2500EP Main Board Assembly
2500-408	2500EP to 2500EN Conversion

REF.DES.	STOCK #	QUANTITY			DESCRIPTION	MANUFACTURING/PURCHASING DATA	ALTERNATE
		A	T	N			
3	2500-604	1			2500EP Main Board Assembly	Assembly 2500-604	
5	04-10051	4			2500EP Main bd. support bracket	DWG 2500-208	
6	04-10377	1			2500EP Rear panel	DWG 2500-225	
7	04-10347	1			2500EP Modified chassis (side rail)	DWG 2500-213 using 04-10223	
8	04-10604	1			2500EP Front panel (screened)	DWG 2500-105 using 04-10603	
9	04-10223	1			CASE (5 1/4") (2500EP)	TDJ B-525-15-1700H	
11	05-10493	2			Filter, fan guard, 4 1/2	AFP FF450A/30 or 45PPI	
13	05-10062	2			Bracket, capacitor, 3" dia	CDE VR-12	
16	05-10217	5			Spacer, 1/4 hex, 1/4 lg, #6	Smith 2300 or 2100	
17	05-10291	1			Plug, hole, .375", Black	Smith 3091	
21	05-10019	50			Cable tie, 4"x 1/8"	Panduit WRN-4	
22	05-10441	9			Tie-wrap block, small	Panduit ABMM-AT	
26	05-10231	8			Grommet, LED, panel mount	HP 5082-4707	
30	05-10680	1			Knob,Black with Pointer Skirt	Rogan GRI-11-CSK-7-M	
41	05-10086	1			Solder lug, #6, internal star	Smith 1412-6	
43	90-06008	6			#6-32 x 1/2 Phil Pan S.S.		
44	90-06006	13			#6-32 x 3/8" Phil Pan S.S.		
47	91-06014	4			#6-32 x 7/8" Phil Flat 82 Deg. S.S.		
49	91-06006	8			#6-32 x 3/8" Phil Flat 82 Deg. S.S.		
50	91-06010	12			#6-32 x 5/8" Phil Flat 82 Deg. S.S.		
52	91-06008	4			#6-32 x 1/2" Phil Flat 82 Deg. S.S.		
55	98-06001	23			#6 Split Lock Washer,STD,S.S.		
56	98-06002	4			#6 Internal Star Washer, S.S.		
57	98-06000	4			#6 Flat Washer STD S.S.		
60	96-00006	1			3/8-32 Panel Nut		
61	97-06001	23			#6-32 Hex Nut, Small Pattern, Stainless-Steel		
67	90-02006	2			#2-56 x 3/8" Phil Pan S.S.		
68	98-02001	2			#2 Split Lock Washer		
69	97-02001	2			#2-56 Radio Hex Nut		
70	80-01212	9			12awg Wire, Red PVC	M16878/1-BLE-2	
71	80-01012	108			12awg Wire, Black PVC	M16878/1-BLE-0	
72	80-01512	60			12awg Wire, Green PVC	M16878/1-BLE-5	
73	80-01014	12			14awg Wire, Black PVC	M16878/1-BKG-0	
74	80-01216	60			16awg Wire, Red PVC	M16878/1-BJE-2	
75	80-01016	60			16awg Wire, Black PVC	M16878/1-BJE-0	
76	80-01516	6			16awg Wire, Green PVC	M16878/1-BJE-5	
77	80-01514	12			14awg Wire, Green PVC	M16878/1-BKE-5	
78	80-01020	42			20awg Wire Black PVC	M16878/1-BGE-0	
79	80-01120	30			20awg Wire, Brown PVC	M16878/1-BGE-1	
80	80-01220	66			20awg Wire, Red PVC	M16878/1-BGE-2	
81	80-01320	66			20awg Wire, Orange PVC	M16787/1-BGE-3	
82	80-01420	66			20awg Wire, Yellow PVC	M16878/1-BGE-4	
83	80-01520	66			20awg Wire, Green PVC	M16878/1-BGE-5	
84	80-01620	66			20awg Wire, Blue PVC	M16878/1-BGE-6	
85	80-01720	66			20awg Wire, Violet PVC	M16878/1-BGE-7	
86	80-01820	42			20awg Wire, Gray PVC	M16878/1-BGE-8	
87	80-01920	42			20awg Wire, White PVC	M16878/1-BGE-9	
89	99-08000	7			#8 18-22awg Ring Lug (Red)	ELCOM B3651-169	
90	99-06200	7			#6 10-12awg Ring Lug (Yellow)	Western Fastener YOU6RY	
91	99-08200	6			#8 10-12awg Ring Lug (Yellow)	Western Fastener YOU8RY	
92	99-10200	2			#10 10-12awg Ring Lug (Yellow)	Western Fastener YOU10RY	

REF.DES.	STOCK #	QUANTITY			DESCRIPTION	MANUFACTURING/PURCHASING DATA	ALTERNATE
		A	T	N			
94	80-01022	30			22AWG Wire, Black PVC	M16878/1-BFE-0	
95	80-01122	30			22AWG Wire, Brown PVC	M16878/1-BFE-1	
96	80-01222	30			22AWG Wire, Red PVC	M16878/1-BFE-2	
97	80-01322	30			22AWG Wire, Orange PVC	M16878/1-BFE-3	
98	80-01422	30			22AWG Wire, Yellow PVC	M16878/1-BFE-4	
99	80-01522	30			22AWG Wire, Green PVC	M16878/1-BFE-5	
100	80-01622	30			22AWG Wire, Blue PVC	M16878/1-BFE-6	
101	80-01722	30			22AWG Wire, Violet PVC	M16878/1-BFE-7	
102	80-01822	30			22AWG Wire, Gray PVC	M16878/1-BFE-8	
103	80-01922	30			22AWG Wire, White PVC	M16878/1-BFE-9	
C32	02-60003	1			1uF 100V Mylar	Illinois 105MSR250K	
C44	02-10013	1			1uF 50V Ceramic disc	8131-050-651-105M	
C118	02-40003	1			61000u 40V Aluminum	Sangamo DCM613U040DD2B	
C119	02-40003	1			61000u 40V Aluminum	Sangamo DCM613U040DD2B	
DS1	05-01028	1			LED,Red,Panel Mount	Hewlett Packard,HLMP3301	
DS2	05-01028	1			LED,Red,Panel Mount	Hewlett Packard,HLMP3301	
DS3	05-01028	1			LED,Red,Panel Mount	Hewlett Packard,HLMP3301	
DS4	05-01028	1			LED,Red,Panel Mount	Hewlett Packard,HLMP3301	
DS5	05-01028	1			LED,Red,Panel Mount	Hewlett Packard,HLMP3301	
DS6	05-01028	1			LED,Red,Panel Mount	Hewlett Packard,HLMP3301	
DS7	05-01028	1			LED,Red,Panel Mount	Hewlett Packard,HLMP3301	
DS8	05-01028	1			LED,Red,Panel Mount	Hewlett Packard,HLMP3301	
F1	05-04009	1			5A,Fuse	Littlefuse,312-005	
F2	05-04012	1			15A,Fuse	Bussman,AGC15	
FS1	05-10018	1			Fuseholder, panel mount	Littlefuse 345061	
FS2	05-10018	1			Fuseholder, panel mount	Littlefuse 345061	
J1	05-10021	1			Binding post, red, 30 amp	Superior BP30R	
J2	05-10020	1			Binding post, black, 30 amp	Superior BP30B	
J3	05-10021	1			Binding post, red, 30 amp	Superior BP30R	
J4	05-10020	1			Binding post, black, 30 amp	Superior BP30B	
J5	05-10063	1			Connector, AC, receptacle	Switchcraft EAC-301	
J6	05-10020	1			Binding post, black, 30 amp	Superior BP30B	
J7	05-10021	1			Binding post, red, 30 amp	Superior BP30R	
J8	05-10020	1			Binding post, black, 30 amp	Superior BP30B	
J9	05-10021	1			Binding post, red, 30 amp	Superior BP30R	
J10	05-10089	1			Connector, female, 14 pin, with bail	Amphenol 5740140	
R44	01-01061	1			10K 5% 1/4W Carbon Film	RCC07GF103J	
S1	05-03031	1			Rotary Switch,2Pole 12 Way	Centralab,SA-203-3F000	
S2	05-03061	1			Switch, 2PDT, Black w/yellow eye	Schadow ZFNE152UEE11010106B	
S3	05-03061	1			Switch, 2PDT, Black w/yellow eye	Schadow ZFNE152UEE11010106B	
S4	05-03017	1			Slide Switch,115/230V,2Pole	Switchcraft,4625LFR	
T1	04-20009	1			2500EP Power transformer	DWG 2500-011	

REF.DES.	STOCK #	QUANTITY			DESCRIPTION	MANUFACTURING/PURCHASING DATA	ALTERNATE
		A	T	N			
71	04-10049	2			2500EP Heat sink	DWG 2500-206	
72	04-10065	2			2500EP Heat sink support bracket	DWG 2500-211	
73	04-10050	1			2500EP Ground bracket	DWG 2500-207	
77	05-10233	2			2500EP Adhesive insulator	DWG 2500-212	
78	90-06008	4			#6-32 x 1/2 Phil Pan S.S.		
79	95-06010	4			# 6-32 x 5/8" Hex, S.S.		
80	90-06010	32			#6-32 x 5/8" Phil Pan S.S.		
81	98-06001	20			#6 Split Lock Washer,STD,S.S.		
82	98-06000	8			#6 Flat Washer STD S.S.		
83	97-06001	20			#6-32 Hex Nut, Small Pattern, Stainless-Steel		
84	90-02108	2			#2-56 x 1/2" Phil Pan S.S.		
85	98-02001	4			#2 Split Lock Washer		
86	97-02001	4			#2-56 Radio Hex Nut		
87	90-02006	2			#2-56 x 3/8" Phil Pan S.S.		
88	05-10005	12			Standoff, swage, 1/4 od, 3/16 lg, 6-32	Useco B1530B-3/16-11	
89	98-06002	32			#6 Internal Star Washer, S.S.		
90	80-00022	25			22AWG Buss Wire	1BB-2201 ANIXTER	
91	70-11022	24			22AWG TFE Sleeving	ATC TPT 22	
A1	04-30152	1			2500EP Main Board	DWG 2500-704	
C1	02-30011	1			4.7u 35V Tantalum Bead	TDC475K035WLE	
C2	02-30011	1			4.7u 35V Tantalum Bead	TDC475K035WLE	
C3	02-30011	1			4.7u 35V Tantalum Bead	TDC475K035WLE	
C4	02-30011	1			4.7u 35V Tantalum Bead	TDC475K035WLE	
C5	02-30011	1			4.7u 35V Tantalum Bead	TDC475K035WLE	
C6	02-30011	1			4.7u 35V Tantalum Bead	TDC475K035WLE	
C7	02-30011	1			4.7u 35V Tantalum Bead	TDC475K035WLE	
C8	02-30011	1			4.7u 35V Tantalum Bead	TDC475K035WLE	
C9	02-20009	1			470p 500V Mica	CM05FD471J03	
C12	02-30011	1			4.7u 35V Tantalum Bead	TDC475K035WLE	
C13	02-30011	1			4.7u 35V Tantalum Bead	TDC475K035WLE	
C30	02-60012	1			3300pF, 100V, Mylar, 5%	WIMA, FKS2-3000P	
C33	02-20009	1			470p 500V Mica	CM05FD471J03	
C34	02-20009	1			470p 500V Mica	CM05FD471J03	
C36	02-30010	1			10u 10V Tantalum Bead	AVX TAP106K010SP	
C37	02-30011	1			4.7u 35V Tantalum Bead	TDC475K035WLE	
D1	03-20031	1			Diode, zener, 4.7V, 10%, 5watts	1N5337A	
D2	03-20031	1			Diode, zener, 4.7V, 10%, 5watts	1N5337A	
D3	03-20038	1			Diode, zener, 6.2V, 10%, 1watt	1N4735	
D4	03-20038	1			Diode, zener, 6.2V, 10%, 1watt	1N4735	
D5	03-20038	1			Diode, zener, 6.2V, 10%, 1watt	1N4735	
D6	03-20038	1			Diode, zener, 6.2V, 10%, 1watt	1N4735	
D7	03-20000	1			Diode, general purpose	1N4148 or 1N914	
D8	03-20000	1			Diode, general purpose	1N4148 or 1N914	
D9	05-01005	1			Single LED,Red,Small	Hewlett Packard,HLMP1000	
D10	03-20000	1			Diode, general purpose	1N4148 or 1N914	
D11	05-01005	1			Single LED,Red,Small	Hewlett Packard,HLMP1000	
D109	03-20012	1			Diode, rectifier, 10A (reverse),(DO-5)	1N1183RA	
D110	03-20011	1			Diode, rectifier, 10A,(DO-5)	1N1183A	
D111	03-20012	1			Diode, rectifier, 10A (reverse),(DO-5)	1N1183RA	
D112	03-20011	1			Diode, rectifier, 10A,(DO-5)	1N1183A	
D113	03-20000	1			Diode, general purpose	1N4148 or 1N914	

REF.DES.	STOCK #	QUANTITY			DESCRIPTION	MANUFACTURING/PURCHASING DATA	ALTERNATE
		A	T	N			
D114	03-20000	1			Diode, general purpose	1N4148 or 1N914	
D115	03-20000	1			Diode, general purpose	1N4148 or 1N914	
D116	03-20000	1			Diode, general purpose	1N4148 or 1N914	
D117	03-20000	1			Diode, general purpose	1N4148 or 1N914	
D118	03-20000	1			Diode, general purpose	1N4148 or 1N914	
D119	03-20000	1			Diode, general purpose	1N4148 or 1N914	
D120	03-20000	1			Diode, general purpose	1N4148 or 1N914	
D121	03-20000	1			Diode, general purpose	1N4148 or 1N914	
D122	03-20000	1			Diode, general purpose	1N4148 or 1N914	
D123	03-20000	1			Diode, general purpose	1N4148 or 1N914	
D124	03-20000	1			Diode, general purpose	1N4148 or 1N914	
D125	03-20000	1			Diode, general purpose	1N4148 or 1N914	
D126	03-20000	1			Diode, general purpose	1N4148 or 1N914	
D127	03-20000	1			Diode, general purpose	1N4148 or 1N914	
D128	03-20000	1			Diode, general purpose	1N4148 or 1N914	
D129	03-20000	1			Diode, general purpose	1N4148 or 1N914	
D130	03-20000	1			Diode, general purpose	1N4148 or 1N914	
D131	03-20000	1			Diode, general purpose	1N4148 or 1N914	
FAN	05-10059	1			Fan, 4 1/4", 115V	Rotron MU2A1	
IC1	03-30036	1			Regulator,+15V,0.5A,TO202 or TO220	78M15CP or LM340T-15	
IC2	03-30037	1			Regulator,-15V,0.5A,TO202 or TO220	79M15CP or LM320T-15	
IC3	03-30315	1			Precision JFET Op Amp	Burr Brown OPA103CM	
IC4	03-30170	1			Low Noise, low drift Op-amp	OP07DP	
IC5	03-30133	1			Quad general purpose comparator	LM339N	
IC6	03-30451	1			Regulator, +24v, 1.0A, (TO220)	Motorola MC7824CT	
R1	01-01007	1			10 5% 1/4W Carbon Film	RC07GF100J	
R2	01-01007	1			10 5% 1/4W Carbon Film	RC07GF100J	
R3	01-01007	1			10 5% 1/4W Carbon Film	RC07GF100J	
R4	01-01007	1			10 5% 1/4W Carbon Film	RC07GF100J	
R5	01-20034	1			50K 0.05% 5ppm/C wire wound	Goldstar GS711-50K-0.05%-5ppm	
R6	01-20034	1			50K 0.05% 5ppm/C wire wound	Goldstar GS711-50K-0.05%-5ppm	
R7	01-20034	1			50K 0.05% 5ppm/C wire wound	Goldstar GS711-50K-0.05%-5ppm	
R8	01-20034	1			50K 0.05% 5ppm/C wire wound	Goldstar GS711-50K-0.05%-5ppm	
R9	01-01043	1			1.5K 5% 1/4W Carbon Film	RC07GF152J	
R10	01-01043	1			1.5K 5% 1/4W Carbon Film	RC07GF152J	
R11	01-01037	1			680 5% 1/4W Carbon Film	RC07GF681J	
R12	01-01021	1			100 5% 1/4W Carbon Film	RC07GF101J	
R13	01-01037	1			680 5% 1/4W Carbon Film	RC07GF681J	
R14	01-01037	1			680 5% 1/4W Carbon Film	RC07GF681J	
R15	01-01037	1			680 5% 1/4W Carbon Film	RC07GF681J	
R16	01-01015	1			47 5% 1/4W Carbon Film	RC07GF470J	
R17	01-01015	1			47 5% 1/4W Carbon Film	RC07GF470J	
R18	01-01033	1			470 5% 1/4W Carbon Film	RC07GF471J	
R19	01-01033	1			470 5% 1/4W Carbon Film	RC07GF471J	
R20	01-30001	1			1 20% 8W power wire wound	Ohmite 1500 Brown Devil	
R21	01-30001	1			1 20% 8W power wire wound	Ohmite 1500 Brown Devil	
R22	01-30001	1			1 20% 8W power wire wound	Ohmite 1500 Brown Devil	
R23	01-30001	1			1 20% 8W power wire wound	Ohmite 1500 Brown Devil	
R24	01-30001	1			1 20% 8W power wire wound	Ohmite 1500 Brown Devil	
R25	01-30001	1			1 20% 8W power wire wound	Ohmite 1500 Brown Devil	
R26	01-30001	1			1 20% 8W power wire wound	Ohmite 1500 Brown Devil	

REF.DES.	STOCK #	QUANTITY			DESCRIPTION	MANUFACTURING/PURCHASING DATA	ALTERNATE
		A	T	N			
R27	01-30001	1			1 20% 8W power wire wound	Ohmite 1500 Brown Devil	
R28	01-30001	1			1 20% 8W power wire wound	Ohmite 1500 Brown Devil	
R29	01-30001	1			1 20% 8W power wire wound	Ohmite 1500 Brown Devil	
R30	01-30034	1			25 5% 15W Power W/W	Dale RH10	
R31	01-30034	1			25 5% 15W Power W/W	Dale RH10	
R32	01-01043	1			1.5K 5% 1/4W Carbon Film	RC07GF152J	
R33	01-20051	1			8.95K 0.1% 5ppm/C wire wound	Goldstar GS805-8K95-0.1%-5ppm	
R34	01-10072	1			64.9K 1% 50ppm/C 1/4W Metal Film	RN60C6492F	
R35	01-20050	1			909 0.1% 5ppm/C wire wound	Goldstar GS809-909R-0.1%-5ppm	
R36	01-10071	1			6.49K 1% 50ppm/C 1/4W Metal Film	RN60C6491F	
R37	01-20049	1			90.9 0.1% 5ppm/C wire wound	Goldstar GS809-909R-0.1%-5ppm	
R38	01-10070	1			649 1% 50ppm/C 1/4W Metal Film	RN60C6490F	
R39	01-20048	1			9.09 0.1% 5ppm/C wire wound	Goldstar GS811-9R09-0.1%-5ppm	
R40	01-10069	1			64.9 1% 50ppm/C 1/4 Metal Film	RN60C6490F	
R41	01-20047	1			0.909 0.1% Manganin	Goldstar R0004 (Lollipop)	
R42	01-10068	1			7.15 1% 50ppm/C 1/4 Metal Film	RN60C7R15F	
R43	01-20046	1			0.101 0.1% Manganin	Goldstar R0003 (Washer)	
R44	01-01041	1			1K 5% 1/4W Carbon Film	RC07GF102J	
R45	01-10067	1			3.01K 1% 50ppm/C 1/4 Metal Film	RN60C3011F	
R46	01-10008	1			10K 1% 50ppm/C 1/4W Metal Film	RN60C1002F	
R47	01-10008	1			10K 1% 50ppm/C 1/4W Metal Film	RN60C1002F	
R48	01-10060	1			3.92K 1% 50ppm/C 1/4W Metal Film	RN60C3921F	
R49	01-01041	1			1K 5% 1/4W Carbon Film	RC07GF102J	
R50	01-01021	1			100 5% 1/4W Carbon Film	RC07GF101J	
R51	01-01045	1			2K 5% 1/4W Carbon Film	RC07GF202J	
R52	01-01061	1			10K 5% 1/4W Carbon Film	RC07GF103J	
R61	01-01061	1			10K 5% 1/4W Carbon Film	RC07GF103J	
RV1	01-50035	1			50K End Adjust	Beckman 89PR50K	
RV3	01-50014	1			100 Top Adjust	Beckman 68WR100ohm	
RV4	01-50018	1			10 Top Adjust	Beckman 68WR100ohm	
RV5	01-50014	1			100 Top Adjust	Beckman 68WR100ohm	
RV6	01-50013	1			1K Top Adjust	Beckman 68WR1K	
RV7	01-50012	1			10K Top Adjust	Beckman 68WR10K	
RV8	01-50024	1			100K Top Adjust	Beckman 68WR100K	
RV9	01-50014	1			100 Top Adjust	Beckman 68WR100ohm	
R150	01-01046	1			2.2K 5% 1/4W Carbon Film	RC07GF222J	
R151	01-01046	1			2.2K 5% 1/4W Carbon Film	RC07GF222J	
RV10	01-50028	1			50K Top Adjust	Beckman 68WR50K	
RV11	01-50028	1			50K Top Adjust	Beckman 68WR50K	
RLA	05-03088	1			Relay, 4 Pole C/O	P-B,R10-E2-Z4-J2.5K	
RLB	05-03088	1			Relay, 4 Pole C/O	P-B,R10-E2-Z4-J2.5K	
RLC	05-03088	1			Relay, 4 Pole C/O	P-B,R10-E2-Z4-J2.5K	
RLD	05-03088	1			Relay, 4 Pole C/O	P-B,R10-E2-Z4-J2.5K	
RLE	05-03088	1			Relay, 4 Pole C/O	P-B,R10-E2-Z4-J2.5K	
RLF	05-03088	1			Relay, 4 Pole C/O	P-B,R10-E2-Z4-J2.5K	
RLG	05-03012	1			Relay, Reed, 5V Coil, DIL, Form A	CP Clare: PRMA 1A 05	
RLH	05-03012	1			Relay, Reed, 5V Coil, DIL, Form A	CP Clare: PRMA 1A 05	
RLJ	05-03012	1			Relay, Reed, 5V Coil, DIL, Form A	CP Clare: PRMA 1A 05	
RLK	05-03012	1			Relay, Reed, 5V Coil, DIL, Form A	CP Clare: PRMA 1A 05	
RLL	05-03012	1			Relay, Reed, 5V Coil, DIL, Form A	CP Clare: PRMA 1A 05	
RLM	05-03012	1			Relay, Reed, 5V Coil, DIL, Form A	CP Clare: PRMA 1A 05	

REF.DES.	STOCK #	QUANTITY	DESCRIPTION	MANUFACTURING/PURCHASING DATA	ALTERNATE
RLN	05-03070	1	Relay,Reed,1 Form A,12V	Claire,PRMA1A12	
TR1	03-10002	1	PNP Transistor (TO5)	2N4036	
TR2	03-10007	1	NPN Transistor (TO5)	2N2102	
TR3	03-10008	1	NPN Transistor (TO3 steel)	2N3055 (steel)	
TR4	03-10009	1	PNP Transistor (TO3 steel)	2N6246-8 (steel)	
TR5	03-10008	1	NPN Transistor (TO3 steel)	2N3055 (steel)	
TR6	03-10008	1	NPN Transistor (TO3 steel)	2N3055 (steel)	
TR7	03-10008	1	NPN Transistor (TO3 steel)	2N3055 (steel)	
TR8	03-10008	1	NPN Transistor (TO3 steel)	2N3055 (steel)	
TR9	03-10008	1	NPN Transistor (TO3 steel)	2N3055 (steel)	
TR10	03-10009	1	PNP Transistor (TO3 steel)	2N6246-8 (steel)	
TR11	03-10009	1	PNP Transistor (TO3 steel)	2N6246-8 (steel)	
TR12	03-10009	1	PNP Transistor (TO3 steel)	2N6246-8 (steel)	
TR13	03-10009	1	PNP Transistor (TO3 steel)	2N6246-8 (steel)	
TR14	03-10009	1	PNP Transistor (TO3 steel)	2N6246-8 (steel)	
TR15	03-10010	1	PNP Transistor (TO92)	2N4402	
XIC4	05-10824	1	Socket, DIL, 8Pin	Augat 208-AG49D	
YTR1	05-10207	1	Heatsink, TO5	Wakefield 209CB	
YTR2	05-10207	1	Heatsink, TO5	Wakefield 209CB	

REF.DES.	STOCK #	QUANTITY			DESCRIPTION	MANUFACTURING/PURCHASING DATA
		A	T	N		
1	2500-405	1			2500EP Final Assy.	Assembly 2500-405
2	04-10644	1			2500EN Front Panel (screened)	DWG 2500-106 using 04-10603
R5	01-20036	1			5M 0.05% 5ppm/C wire wound	Goldstar GS812-5M-0.05%-5ppm
R6	01-20036	1			5M 0.05% 5ppm/C wire wound	Goldstar GS812-5M-0.05%-5ppm
R7	01-20054	1			500K 0.05% 5ppm/C wire wound	Goldstar GS711-500K-0.05%-5ppm
R8	01-20054	1			500K 0.05% 5ppm/C wire wound	Goldstar GS711-500K-0.05%-5ppm
RV3	01-50012	1			10K Top Adjust	Beckman 68WR10K

DELETE THE FOLLOWING FROM PARTS LIST: 2500-405

2	04-10604	1			2500EP Front Panel (Screened)	DWG 2300-105 using 04-10603
D1	03-20031	1			Diode, Zener, 4.7V, 10%, 5W	1N5337A
D1	03-20031	1			Diode, Zener, 4.7V, 10%, 5W	1N5337A
R5	01-20034	1			50K 0.05% 5ppm/C wire wound	Goldstar GS711-50K-0.05%-5ppm
R6	01-20034	1			50K 0.05% 5ppm/C wire wound	Goldstar GS711-50K-0.05%-5ppm
R7	01-20034	1			50K 0.05% 5ppm/C wire wound	Goldstar GS711-50K-0.05%-5ppm
R8	01-20034	1			50K 0.05% 5ppm/C wire wound	Goldstar GS711-50K-0.05%-5ppm
RV3	01-50014	1			100 Top Adjust	Beckman 68WR100ohm

SECTION XII DRAWINGS & SCHEMATICS

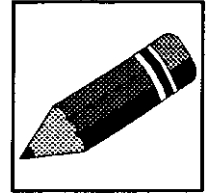

The following drawings are included in this manual:

2500-074	2500EP Main Board Schematic
2500-604	2500EP/EN Main Board Assembly
2500-405	2500EP/EN Final Assembly

ManualsPlus.com

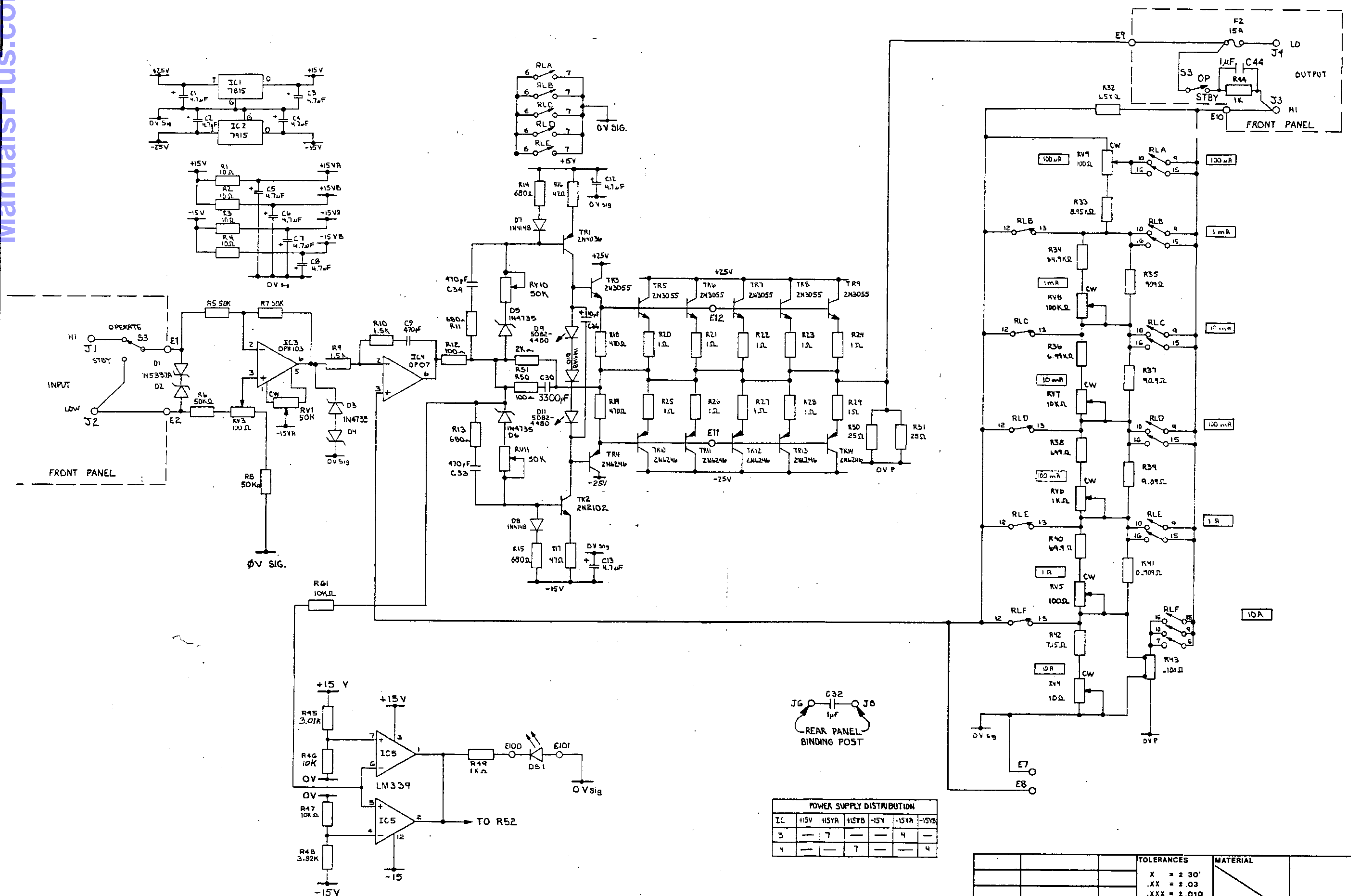

POWER SUPPLY DISTRIBUTION

IC	+15V	+15VA	+15VB	-15V	-15VA	-15VB
3	—	7	—	—	4	—
4	—	—	7	—	—	4

		TOLERANCES	MATERIAL
		X = ± 30'	
		.XX = ± .03	
		.XXX = ± 0.10	
		BREAK ALL SHARP CORNERS AND EDGES. MACH SURFACES	FINISH
		64	

Valhalla Scientific Inc.
SAN DIEGO, CA

MAIN BOARD SCHEMATIC 2500EP

SCALE	CODE IDENT	SIZE	DRAWING NO	REV
	53504	D	2500 - 074	Y

SHEET 1 OF 2

NOTES: (UNLESS OTHERWISE SPECIFIED)
ALL UNMARKED DIODES ARE 1N4148.

REVISIONS			
ECO	LTR	DESCRIPTION	DATE

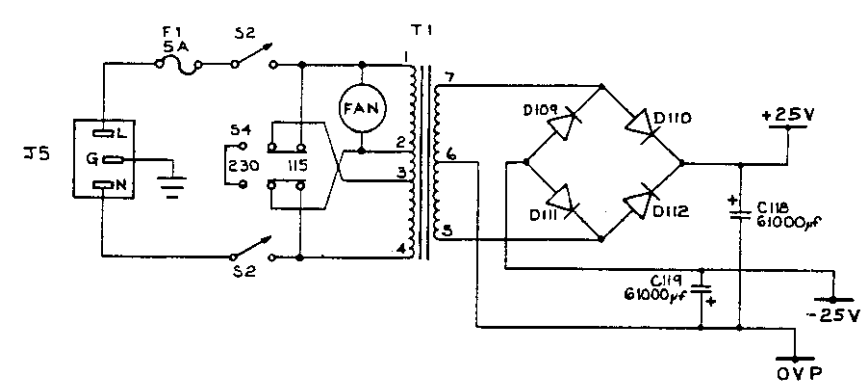
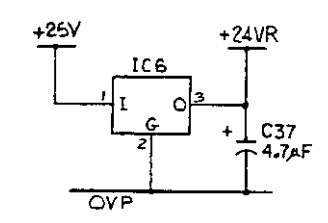
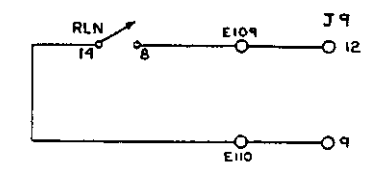
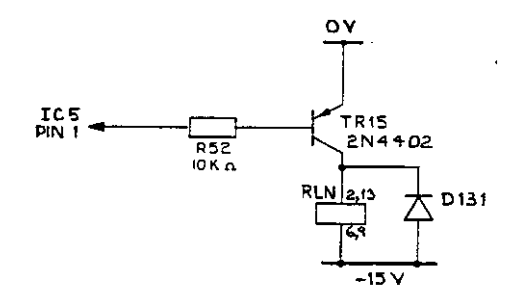
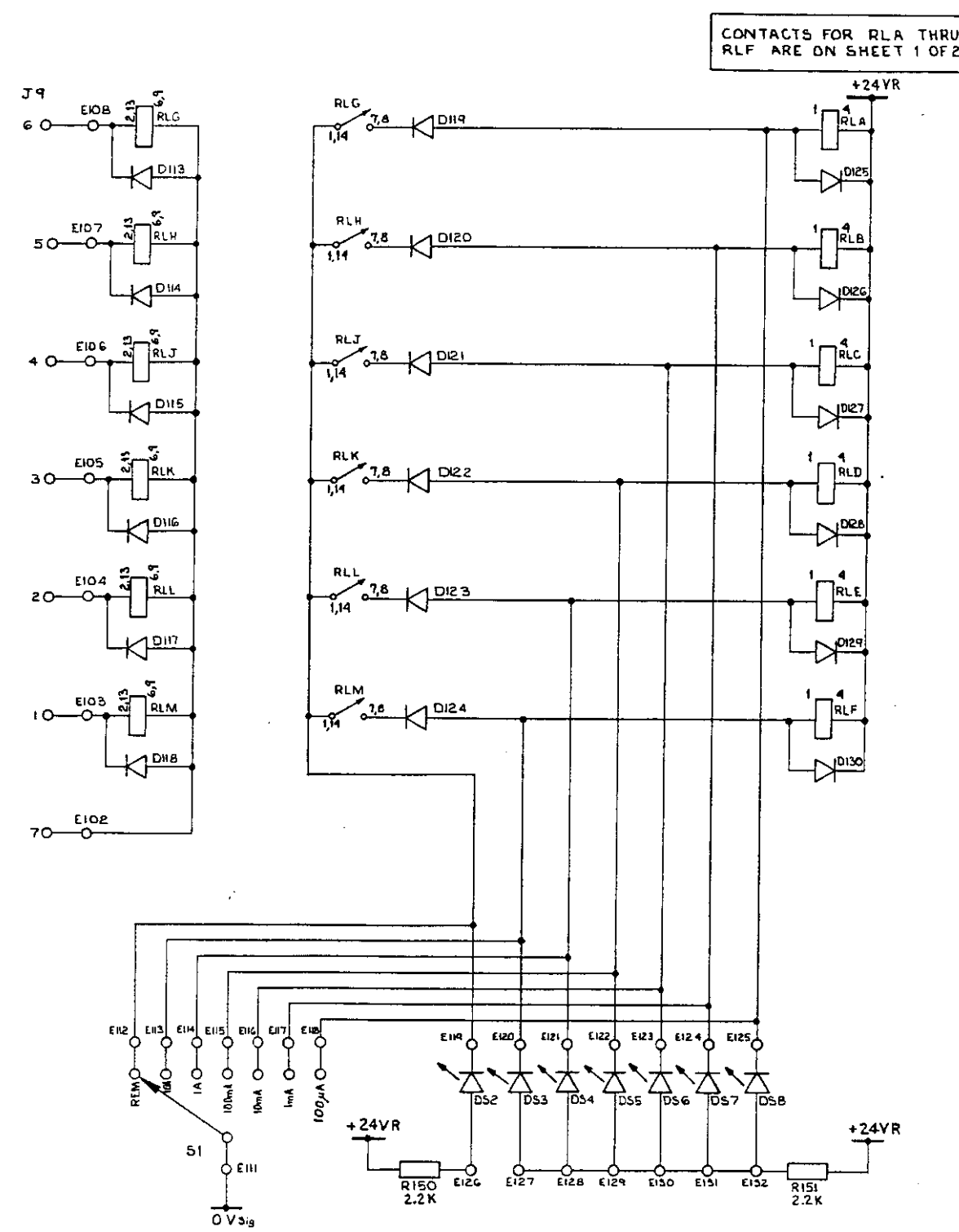

TR1	—	15	IC1	—	5
T1	—	1	F1	—	2
S1	—	4	E100	—	E125
RV1	Z	11	E1	3-6	12
RLA	I	N	DS1	—	8
R150	—	151	D109	—	131
R1	53-60	61	D1	—	11
J1	7	9	C118	—	119
FIRST USED	NOT USED	LAST USED	C1	10,11,14,29,35	36

TOLERANCES
X = ± 30'
.XX = ± .03
.XXX = ± .010

BREAK ALL SHARP CORNERS AND EDGES. MACH SURFACES

FINISH



MAIN BOARD SCHEMATIC 2500EP

SCALE NONE	CODE IDENT 53504	SIZE D	DRAWING NO 2500-074	REV Y
SHEET 2 OF 2				

NOTES: (UNLESS OTHERWISE SPECIFIED)

REVISIONS				
ECO	LTR	DESCRIPTION	DATE	APPR.

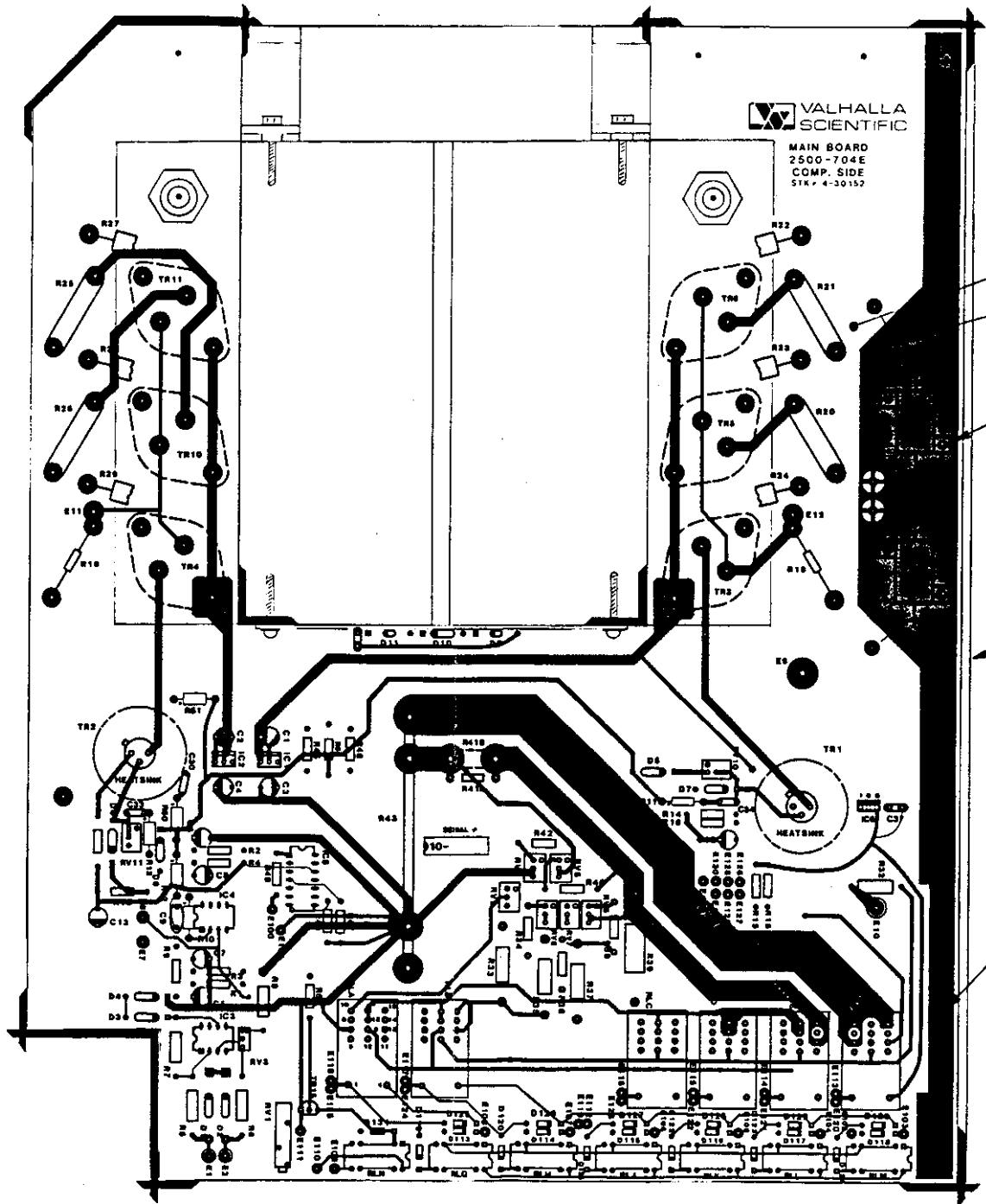
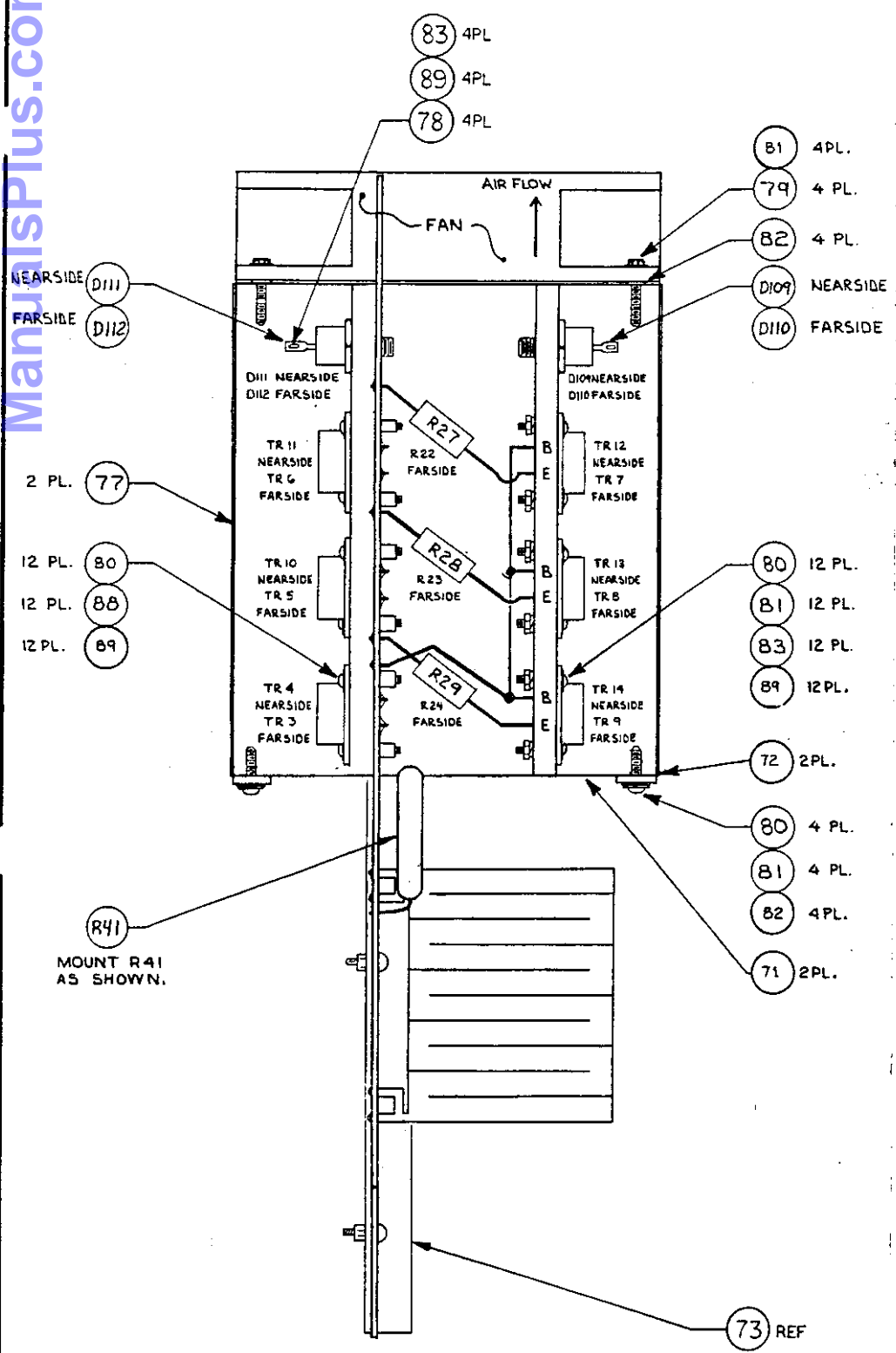

- (A1) P.C. BOARD
- USE 20AWG BUSS WIRE TO WIRE RESISTORS TO BOARD.
- (84) 2 PL.
- (85) 4 PL.
- (87) 2 PL.
- (86) 4 PL.
- (73)
- (83) 4 PL.
- (80) 4 PL.
- (89) 4 PL.

NOTES:
 (1) NEARSIDE AND FAR SIDE OF HEATSINK ASSY ARE SIMILAR.

CLAD SHOWN IS COMP SIDE

TOLERANCES				MATERIAL		 Valhalla Scientific Inc. SAN DIEGO, CA
X° = ± .30' .XX = ± .03 .XXX = ± .010						
BREAK ALL SHARP CORNERS AND EDGES, MACH SURFACES				FINISH		MAIN P.C.B. ASSEMBLY SCALE 1=1 CODE IDENT 53504 SIZE D DRAWING NO 2500-604 REV S
83						
DASH NO	QTY REQD	NEXT ASSEMBLY	USED ON	SHEET 1 OF 1		

1 INSTALL AT TEST.

2 MAKE SURE RVI ALIGNS WITH HOLE IN FRONT PANEL.

REVISIONS				
E.CO	LTR	DESCRIPTION	DATE	APPROVED

ManualsPlus.com

SI INSTRUCTIONS

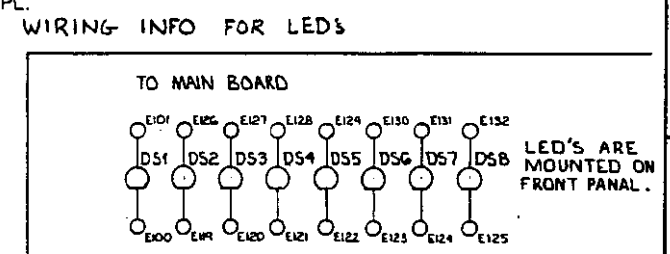
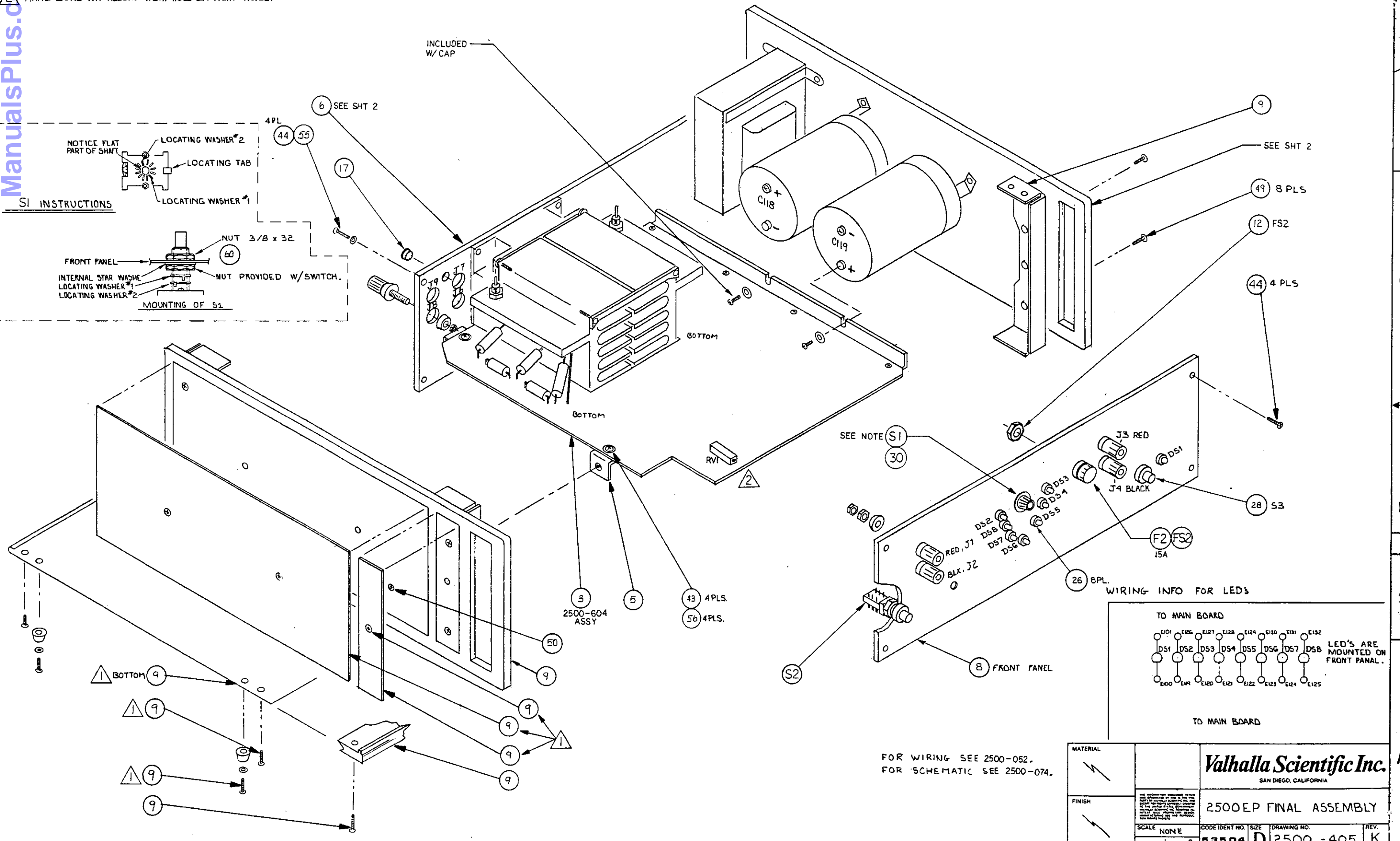
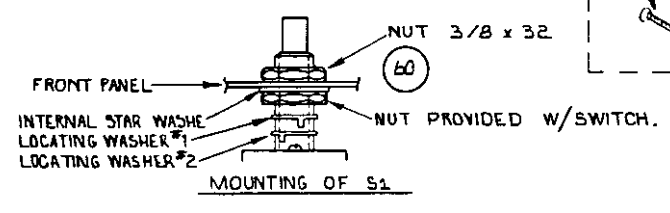
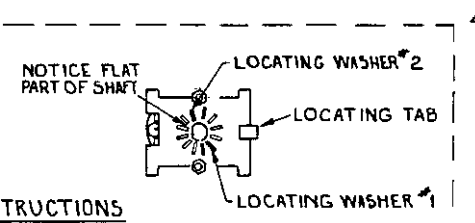

FOR WIRING SEE 2500-052.
FOR SCHEMATIC SEE 2500-074.

MATERIAL	Valhalla Scientific Inc. SAN DIEGO, CALIFORNIA		
FINISH	2500EP FINAL ASSEMBLY		
SCALE NONE	CODE IDENT NO. 53504	SIZE D	DRAWING NO. 2500-405
SHEET 1 OF 2	REV. K	REV. K	

REVISIONS				
ECO	LTR	DESCRIPTION	DATE	APPROVED

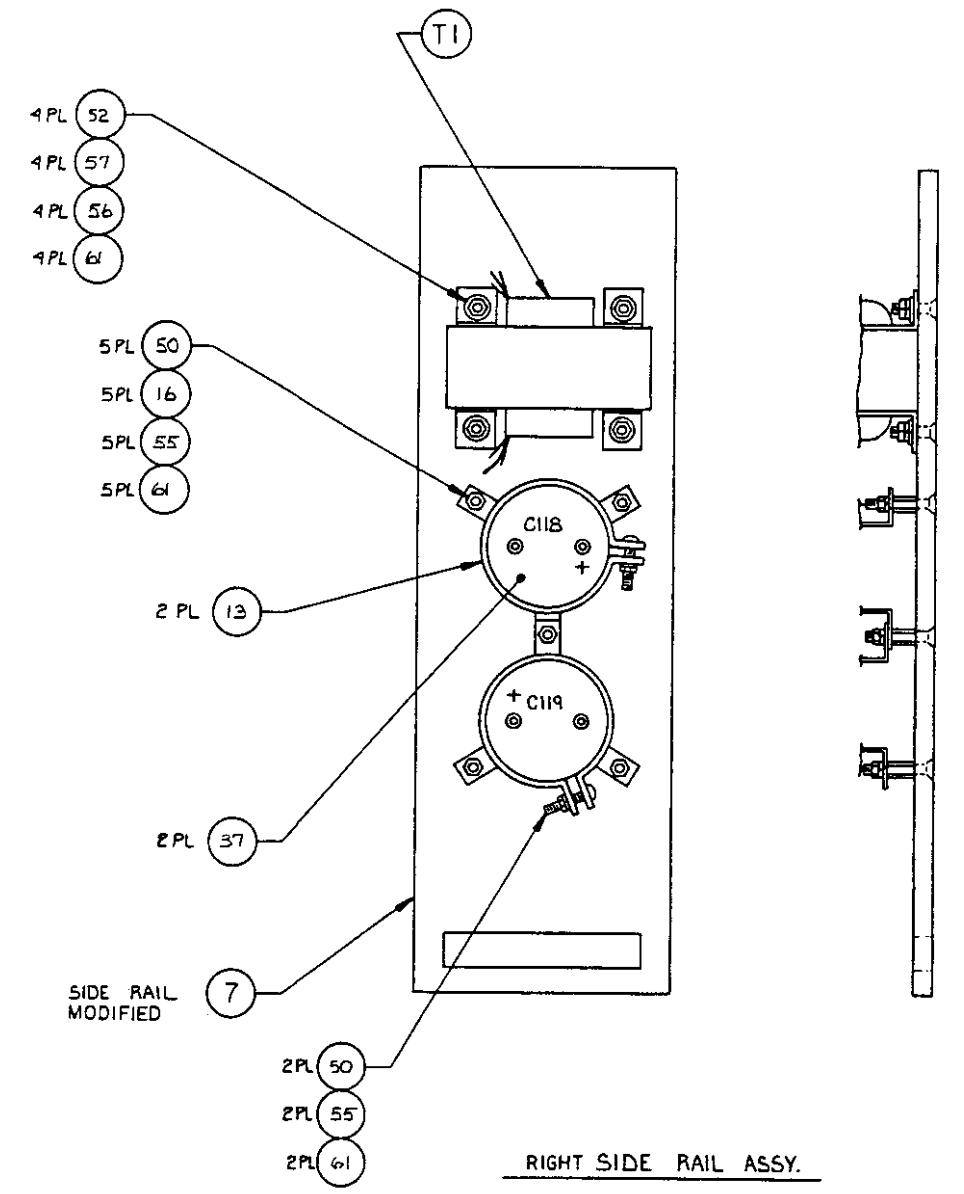
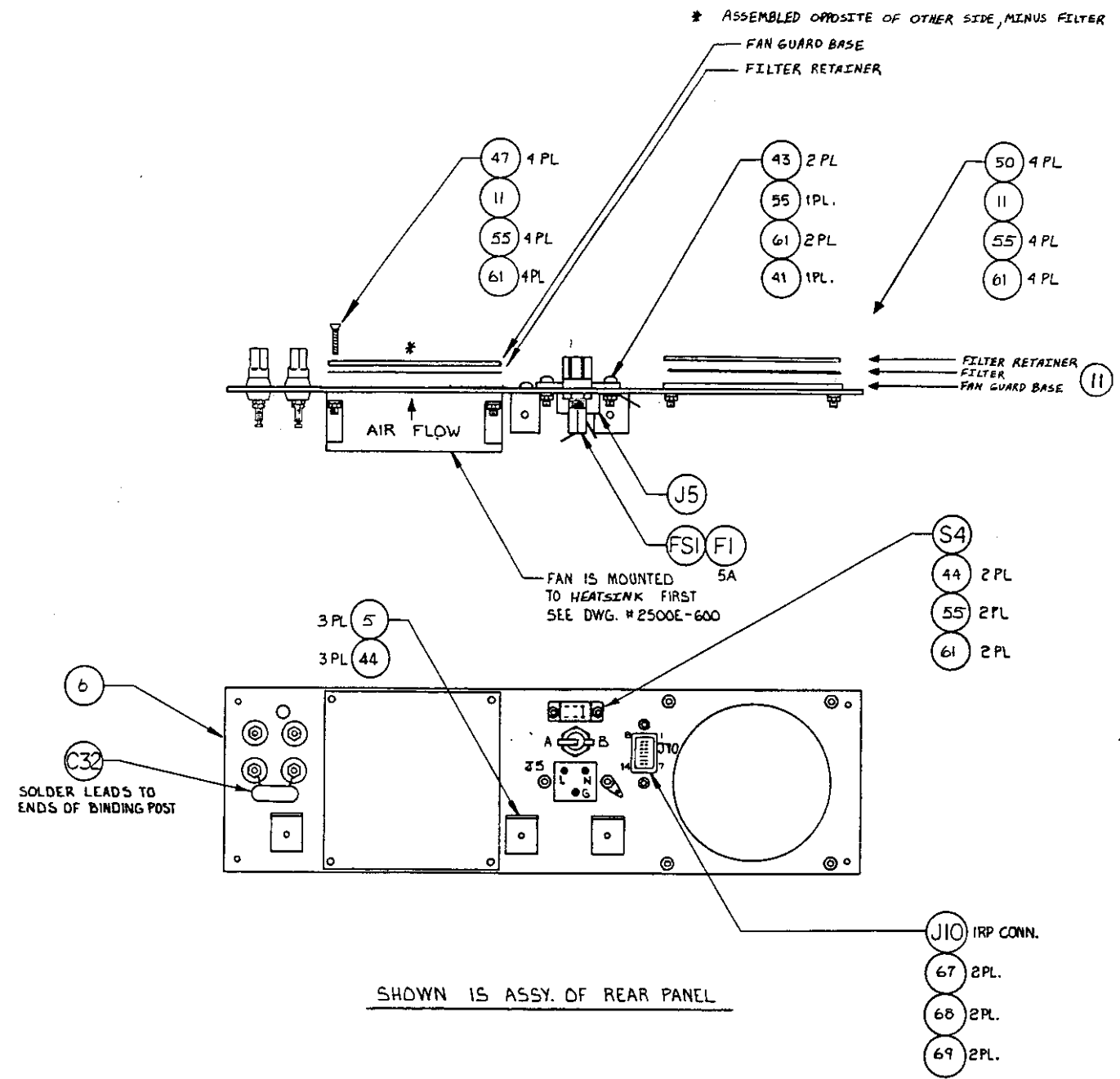

MATERIAL		Valhalla Scientific Inc. SAN DIEGO, CALIFORNIA			
FINISH		2500 EP FINAL ASSY.			
SCALE	NONE	CODE IDENT NO.	SIZE	DRAWING NO.	REV.
SHEET	2 OF 2	53504	D	2500 - 405	K