

2701 C

Programmable Precision DC Voltage Calibrator

Operating and Maintenance Manual

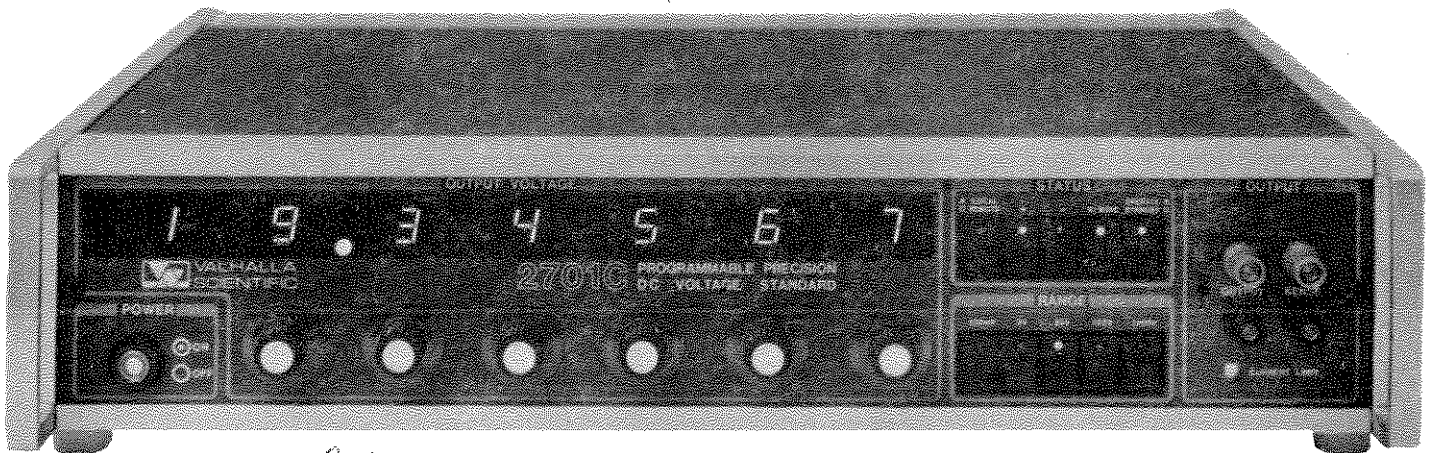

SN 26-822

CERTIFICATION

Valhalla Scientific, Inc. certifies that this instrument was thoroughly tested and inspected and found to meet its published specifications when it was shipped from the factory. Valhalla Scientific, Inc. further certifies that its calibration measurements are traceable to the National Bureau of Standards to the extent allowed by NBS's calibration facility.

WARRANTY

The warranty period for this instrument is stated on your invoice and packing list. Please refer to these to determine appropriate warranty dates. We will repair or replace the instrument during the warranty period provided it is returned to Valhalla Scientific, Inc. freight prepaid. No other warranty is expressed or implied. We are not liable for consequential damages. Permission and a return authorization number must be obtained directly from the factory for warranty repair returns. No liability will be accepted if returned without such permission.

TABLE OF CONTENTS

PARAGRAPH	PAGE
SECTION I - UNPACKING AND INSTALLATION	
1.1	Unpacking.....1-1
1.2	Initial Adjustments.....1-1
1.3	Instructions for Bench Use.....1-1
1.4	Instructions for Rack Mounting.....1-1
1.5	Safety Precautions.....1-2
SECTION II - SPECIFICATIONS	
2.1	General.....2-1
2.2	Accuracy.....2-1
2.2.1	2701C Accuracy.....2-1
2.3	Stability.....2-1
2.4	Temperature Coefficient.....2-2
2.5	General Performance Characteristics.....2-2
2.6	Output Settling Times.....2-2
2.7	Miscellaneous.....2-3
2.8	Physical.....2-3
2.9	Environmental.....2-3
2.10	Recommended Calibration Interval.....2-3
SECTION III - OPTIONS AND ACCESSORIES	
3.1	General.....3-1
3.2	Option "TL-3".....3-1
3.3	Option "RX3".....3-1
3.4	Option "BBL".....3-1
3.5	Option "SL-48".....3-1
3.6	Options "GP1" and "GP2".....3-1
3.7	Option "SP-2".....3-1
3.8	Option "IT-2".....3-1
SECTION IV - FRONT PANEL CONTROLS AND CONNECTORS	
4.1	General.....4-1
4.1.1	"OUTPUT VOLTAGE" Section.....4-1
4.1.2	"RANGE" Section.....4-1
4.1.3	"MODE" Section.....4-1
4.1.4	"POWER".....4-2
4.1.5	"OUTPUT" Section.....4-2

SECTION V - REAR PANEL CONTROLS AND CONNECTORS

5.1	General.....	5-1
5.1.1	Rear Panel OUTPUT and SENSE Terminals.....	5-1
5.1.2	GPIB (IEEE488) Connector.....	5-1
5.1.3	IRP INTERFACE Connector.....	5-1
5.1.4	Power Connector.....	5-1
5.1.5	Fuseholder.....	5-1
5.1.6	IEEE ADDRESS Switches.....	5-1
5.1.7	OPERATE/CALIBRATE Key Operated Switch.....	5-1

SECTION VI - MANUAL OPERATION

6.1	General.....	6-1
6.1.1	Applying AC Power.....	6-1
6.2	Connections.....	6-1
6.3	Setting an Output Voltage or Current.....	6-2
6.4	Performing the Calibration of a Voltmeter.....	6-3

SECTION VII - REMOTE OPERATION

7.1	General.....	7-1
7.2	Definitions.....	7-1
7.3	Basic Description of the IEEE 488 (1978) Bus.....	7-2
7.3.1	The Purpose of the IEEE 488 Standard.....	7-2
7.3.2	Basic IEEE 488 Standard Defined Parameters.....	7-2
7.4	Device Independent Messages.....	7-4
7.4.1	Device Clear (DCL).....	7-4
7.4.2	Selective Device Clear (SDC).....	7-4
7.4.3	Group Execute Trigger (GET).....	7-4
7.4.4	Go To Local (GTL).....	7-5
7.4.5	Interface Clear (IFC).....	7-5
7.4.6	Identify (IDY).....	7-5
7.4.7	Local Lock Out (LLO).....	7-5
7.4.8	Parallel Poll Configure (PPC), Enable (PPE), Disable (PPD) and Unconfigure (PPU).....	7-5
7.4.9	Remote Enable (REN).....	7-5
7.4.10	Serial Poll Enable (SPE) and Disable (SPD).....	7-6
7.4.11	Take Control (TCT).....	7-6
7.5	IEEE commands for the 2701C (Device Dependent).....	7-6
7.5.1	REMOTE and LOCAL States.....	7-6
7.5.2	Data Format Used in the 2701C.....	7-7
7.5.3	Post RESET Delay.....	7-8
7.6	Commands and Examples.....	7-8
7.6.1	Commands That are ALWAYS Executed.....	7-9
7.6.2	Commands which cannot be Executed During External Calibration.....	7-9
7.6.3	Commands which May Only be Executed in External Calibration.....	7-12

SECTION VIII - CALIBRATION

8.1	General.....	8-1
8.2	Calibration Philosophy.....	8-1
8.3	Calibration.....	8-1
8.3.1	Procedure For Each Step.....	8-1
8.3.2	Calibration Sequence.....	8-2

SECTION IX - MAINTENANCE AND TROUBLESHOOTING

9.1	General.....	9-1
9.2	Periodic Maintenance.....	9-1
9.2.1	Cleaning.....	9-1
9.3	Troubleshooting.....	9-1
9.3.1	Component Replacement.....	9-1
9.3.2	Assembly Replacement.....	9-2
9.3.3	Finding the Faulty Component.....	9-2

SECTION X - THEORY OF OPERATION

10.1	General.....	10-1
10.2	Functional Description.....	10-1
10.2.1	Microprocessor.....	10-1
10.2.2	IEEE.....	10-1
10.2.3	Display.....	10-1
10.2.4	Keyboard.....	10-1
10.2.5	D-to-A Convertor.....	10-1
10.2.6	Relay Drives.....	10-1
10.2.7	Sense Feedback.....	10-2
10.2.8	Output Drive.....	10-2
10.2.9	Current Drive.....	10-2
10.2.10	Power Supply.....	10-2
10.3	Detailed Description.....	10-2
10.3.1	Microprocessor.....	10-2
10.3.2	IEEE.....	10-3
10.3.3	Display.....	10-4
10.3.4	Keyboard.....	10-4
10.3.5	D-to-A Convertor.....	10-4
10.3.6	Relay Drives.....	10-5
10.3.7	Sense Feedback.....	10-5
10.3.8	Output Drive.....	10-6
10.3.9	Current Drive.....	10-6
10.3.10	Power Supply.....	10-6
10.4	Relay Selections.....	10-7
10.5	Operation of Microprocessor Software.....	10-8
10.5.1	Power-on Reset Routine.....	10-8
10.5.2	Main Executive Duties.....	10-8
10.5.3	Interrupt Routines.....	10-9
10.5.4	Individual "Action" Routines.....	10-9

SECTION XI - PERFORMANCE VERIFICATION

11.1 General.....11-1
11.2 Verification of Operation.....11-1
11.3 Verification of Specification.....11-1

SECTION XII - USEFUL HINTS

12.1 Getting the Most Out of Your 2701C.....12-1
12.2 Dielectric Storage in Cabling.....12-2

LIST OF FIGURES

Figures are inserted in this manual at the end of the corresponding section.

Figure 1-1 AC Power Voltage Selection
Figure 4-1 Front Panel Controls and Connectors
Figure 5-1 Rear Panel Controls and Connectors
Figure 6-1 Using the 2701C to calibrate a Voltmeter
Figure 10-1 Block diagram of the 2701C
Figure 10-2 Simplified Output and Sense System

SECTION XIII - MANUAL CHANGE INFORMATION**SECTION XIV - SCHEMATIC AND ASSEMBLY DIAGRAMS**

2701-403	(1 sheet)	Chassis Assembly
2701-404	(1 sheet)	Rear Panel Assembly
2701-075	(4 sheets)	Main PCB Schematic
2701-605	(1 sheet)	Main PCB Assembly
2701-076	(1 sheet)	Display PCB Schematic
2701-606	(1 sheet)	Display PCB Assembly
2701-077	(1 sheet)	IEEE/IRP PCB Schematic
2701-607	(1 sheet)	IEEE/IRP PCB Assembly
2701-405	(1 sheet)	IEEE/IRP Installation Assembly

SECTION XV - PARTS LISTS

2701-403	(3 sheets)	Chassis Assembly
2701-404	(1 sheet)	Rear Panel Assembly
2701-605	(6 sheets)	Main PCB Assembly
2701-406	(2 sheet)	Option IT-2
2701-606	(2 sheets)	Display PCB Assembly
2701-607	(2 sheets)	IEEE/IRP PCB Assembly
2701-405	(1 sheet)	IEEE/IRP Installation Assembly

SECTION I**UNPACKING AND INSTALLATION****1.1 Unpacking**

If the shipping carton is damaged, request that the carriers' agent be present when the 2701C is unpacked. If the 2701C appears damaged when unpacked then notify the carriers' agent who should authorize repairs before the 2701C is returned to Valhalla Scientific or Service Center. Even if the 2701C appears undamaged it may have suffered internal damage in transit that may not be evident until the 2701C is operated or tested to verify performance. If the 2701C fails to meet the performance specifications in Section II then notify the carriers' agent and Valhalla Scientific or Service Center. Retain the shipping carton for the carriers inspection, **DO NOT RETURN EQUIPMENT TO VALHALLA SCIENTIFIC OR ANY OF ITS SERVICE CENTERS PRIOR TO OBTAINING AUTHORIZATION TO DO SO.**

1.2 Initial Adjustments

The only adjustments required prior to operation of the 2701C are the correct selection of the local power source voltage (internally selected) and to verify that the correct fuse for this voltage is fitted. The supply voltages and fuses are listed below:

105 to 128VAC 50/60Hz	3 Amp SLO BLO fuse
210 to 256VAC 50/60Hz	1.5 Amp SLO BLO fuse

ENSURE THAT THE CORRECT SELECTION IS MADE PRIOR TO APPLYING POWER TO THE 2701C. (See Figure 1-1 for details).

1.3 Instructions for Bench Use

The 2701C is delivered for operation in bench use and special instructions for use in this manner are not required. However, before connecting the 2701C to the AC power source the user should verify that the power cord is equipped with a three-terminal connector (see the Safety precautions in 1.5).

1.4 Instructions for Rack Mounting

Optional rack mounting brackets are available for mounting the 2701C in a standard 19" equipment rack. These are listed in Section III of this manual. The size and weight of the 2701C dictate that the unit should be supported on both sides along its entire length (by the use of "trays" or "slides"). If it is to be transported while mounted in a rack then it **MUST BE SUPPORTED SO AS TO PREVENT UPWARDS or DOWNWARDS MOVEMENT.**

The user should note that the specifications of the 2701C become degraded at high temperatures thus it is recommended that sufficient room be allowed for airflow around the 2701C. This may be achieved by placing at least 1.75" high blank panels above and below the 2701C in the rack.

If the unit placed beneath the 2701C has an exceptionally hot exterior top surface and it is not possible to alter its location

then the user is recommended to fit an aluminum "reflector" plate between this unit and the 2701C.

Under no circumstances should the ambient air temperature surrounding the 2701C be allowed to exceed 50C while in operation or 70C while not in operation.

1.5 Safety Precautions

The power connector should be a three-contact device meeting the safety requirements of the area in which the 2701C is to be used, and should only be mated with a three-contact connector where the third contact provides a ground connection. If power is provided through an extension cable then the ground connection must be continuous throughout this cable to the 2701C.

FAILURE TO PROVIDE A CONTINUOUS GROUND CONNECTION TO THE 2701C MAY RENDER THE UNIT UNSAFE FOR USE.

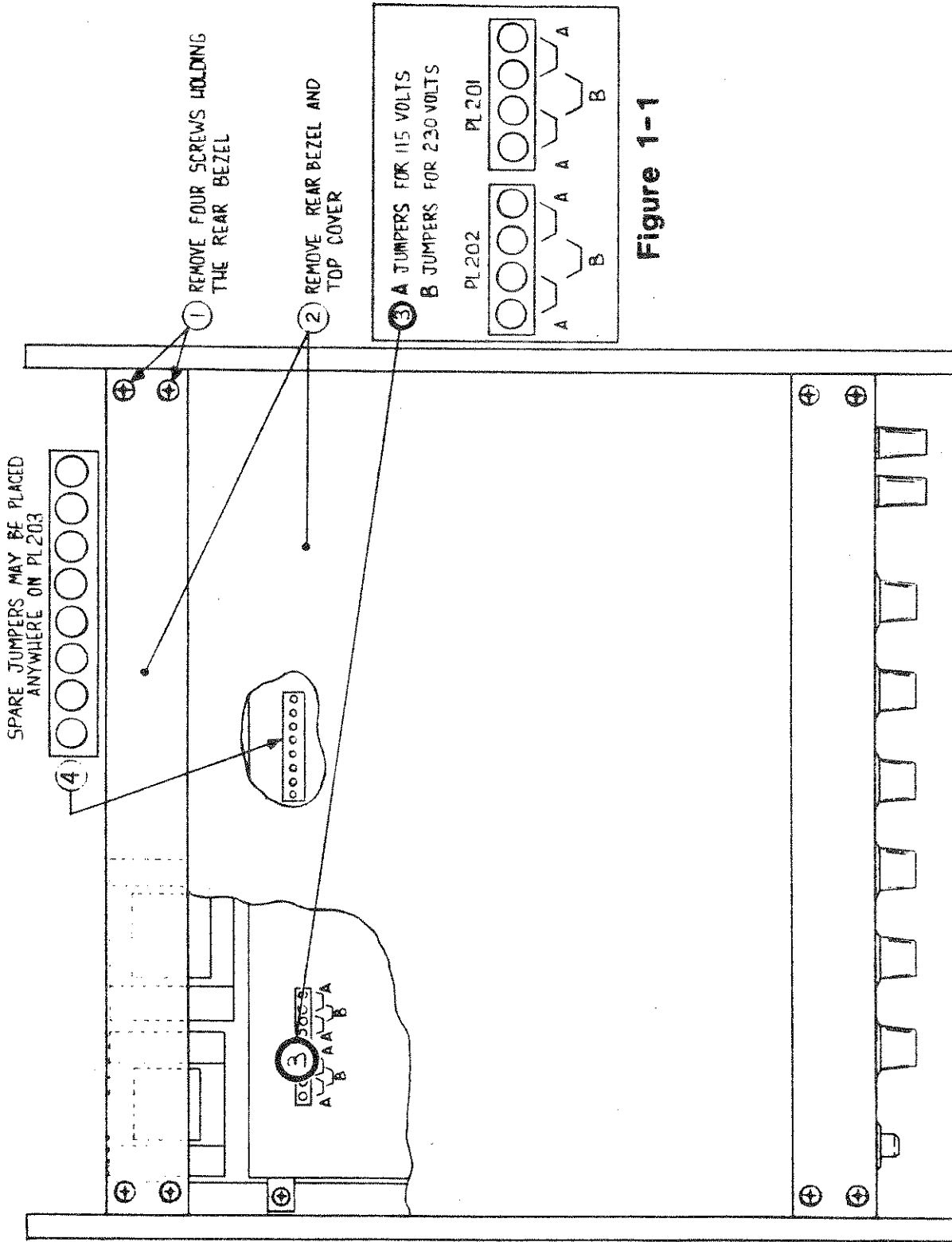

Figure 1-1

SECTION II

SPECIFICATIONS

2.1 General

The specifications of the 2701C PROGRAMMABLE PRECISION DC VOLTAGE CALIBRATOR are listed in the following paragraphs.

2.2 Accuracy

The accuracy specifications are valid for +/-5C from the calibration temperature within 10 to 35C. The values stated below include the effects of line, load and temperature variations within the above window. To derive absolute accuracies relative to the National Bureau of Standards add 1.5ppm (15ppm for 120mA range) for Valhalla Scientific's traceability and transfer uncertainty.

2.2.1 2701C Accuracy (ppm of setting +/- uV)

Range	30day	90day	180day	1year	3years
200mV	15+1.0	20+1.0	25+1.5	30+2.0	50+3.0
2V	10+3	15+4	20+5	25+6	40+10
20V	8+20	13+30	17+40	22+50	35+80
120V	9+150	14+250	18+350	23+400	38+750
1200V	10+1.5mV	15+2.5mV	19+3.5mV	24+4mV	40+7.5mV
120mA*	35+3uA	45+4uA	55+5uA	65+6uA	95+10uA

* Option IT-2 only

2.3 Stability

The 24 hour stability specifications below apply for constant line, load and temperature (within 1C).

Range	Noise	24hr Stability
	0.1-10Hz	DC-0.2Hz
200mV	1uV	1uV
2V	2uV	0.5ppm+2uV
20V	15uV	0.5ppm+10uV
120V	150uV	0.5ppm+100uV
1200V	1.5mV	0.5ppm+1mV
120mA*	300nA	1ppm+500nA

* Option IT-2 only

2.4 Temperature Coefficient

These specifications apply following stabilization to a change in temperature (thermal time constant of unit is approximately 1min/C). The temperature coefficient adder is applicable only when outside of the +/-5C window of the calibration temperature.

Range	0-35C	35-50C
200mV	2ppm+0.1uV	3ppm+0.2uV
2V	1ppm+0.6uV	2ppm+1.0uV
20V	1ppm+6uV	2ppm+10uV
120V	1ppm+30uV	2ppm+50uV
1200V	1ppm+300uV	2ppm+500uV
120mA	6ppm+250nA	10ppm+500nA

2.5 General Performance Characteristics

The table below gives the general operating characteristics of the 2701C.

The Resolution is the displayed resolution of the requested output voltage, the actual resolution of the 2701C is actually better than these figures.

The Linearity of the 2701C is defined as the maximum allowable deviation from a straight line between the zero and full-scale outputs on each range.

Range	Resolution	Maximum Current	Wideband Noise 10Hz-10KHz	Linearity	Output Impedance
200mV	100nV	----	25uV RMS	0.5uV	450 ohm nominal
2V	1uV	25mA	80uV RMS	1uV	< 1 milliohm
20V	10uV	25mA	130uV RMS	10uV	< 5 milliohm
120V	100uV	25mA	500uV RMS	100uV	< 50 milliohm
1200V	1mV	25mA	800uV RMS	1mV	< 0.5 ohm
120mA*	100nA	**	10uA RMS	500nA	> 10 Megohm

* Option IT-2 only

** 10V maximum compliance voltage

2.6 Output Settling Times

The table below gives the errors remaining after the given time following a change in output voltage. The errors are given in ppm of output voltage change. For changes requiring a change of range, or changes between Standby and Operate, then the error is in ppm of final output voltage.

Range	0.5second	1seconds	10seconds
20V and below	20ppm	5ppm	2ppm
120V	30ppm	7ppm	3ppm
1200V	50ppm	10ppm	5ppm

For a decrease in output voltage add 2ms per volt of change.

For a range change add 0.5s + 2ms per volt of previous output voltage.

2.7 Miscellaneous

Warmup Time : 15 seconds to <15ppm of final value
: 30 minutes to <3ppm of final value

IEEE-488 : Compliance with IEEE-488(1978) with subsets
: SH1AH1T6TEOL4LEOSR1RL1PP2DC1DT1C0

Power : 115/230V +/-10% at 45 to 65Hz at 80VA

2.8 Physical

Size : 89mm(3.5") high x 432mm(17") wide x 432mm(17") deep
Weight : 11Kg(24lbs) net, 13Kg(29lbs) shipping

2.9 Environmental

Temperature range : Operating : 0 to 50C
: Storage : -30 to 70C

Humidity : 70% RH max at 40C (non-condensing)

2.10 Recommended Calibration Interval

The calibration interval for the 2701C is dependent on the accuracy the user wishes to maintain. The user should consult the accuracy tables in 2.2 to determine the number of days between external calibrations to obtain the required accuracy.

SECTION III

OPTIONS AND ACCESSORIES

3.1 General

The following options are available for the 2701C PROGRAMMABLE PRECISION DC VOLTAGE CALIBRATOR.

3.2 Option "TL-3"

This option provides the 2701C with a full talk/listen IEEE488 interface (see Section VI for details) and also an interface to a Valhalla 2500EP to provide precision output current capabilities for currents between 100pA and 15 Amps.

3.3 Option "RX3"

This option allows rack mounting of the 2701C in a standard 19" equipment rack.

3.4 Option "BBL"

This option is a 48" long shielded cable terminated at both ends with high performance 3/4" spaced dual banana plugs. Use of this option is recommended for signal levels where inaccuracies of μV or more can be tolerated.

3.5 Option "SL-48"

This option is a 48" long shielded cable terminated at each end by high quality gold plated copper spade lugs. Use of this option is recommended for low signal levels or whenever the best performance is required.

3.6 Options "GP1" and "GP2"

These options are IEEE-488 cables of 1 meter and 2 meter lengths respectively.

3.7 Option "SP-2"

This option provides a selection of the most likely parts to fail during the first two years of operation.

3.8 Option "IT-2"

This option provides an internal 120mA current source range.

SECTION IV

FRONT PANEL CONTROLS AND CONNECTORS

4.1 General

This section outlines the use of each of the front panel controls and connectors, the user is advised to read Section VI to obtain full descriptions of the method to operate the 2701C in the various modes available.

The paragraph numbers used in this section correspond to the reference numbers used in Figure 4-1.

4.1.1 "OUTPUT VOLTAGE" Section

This display section is used to show the 2701C output voltage or current setting. The units are in Volts except when the 2701C is on the 200mV or 120mA ranges when the units are mV or mA respectively. The switches beneath each display window (with the exception of the lefthand window) are used to increment (clockwise rotation) or decrement (counter-clockwise rotation) the respective digit, with full borrow/carry if required.

4.1.2 "RANGE" Section

The RANGE section of the keyboard provides the user with the means to alter the range for the 2701C output voltage. The user should note that these keys are disabled if option "IT-2" is fitted and the 120mA mode selection is made.

4.1.3 "MODE" Section

The MODE section of the 2701C keyboard is for the selection of the various operating parameters.

4.1.3.1 "LOCAL/REMOTE" Key

This key will select the LOCAL mode of operation if the 2701C is in REMOTE and the key is not disabled by the LOCAL LOCKOUT command (see Section VII). The LED within the switch is illuminated whenever the 2701C is in REMOTE.

4.1.3.2 "+/-" Key

This key will alternately select positive or negative output polarity. The LED within the switch is illuminated whenever the 2701C has a positive output polarity.

4.1.3.3 "VOLTS/120mA" Key

This key will alternately select voltage or current output from the 2701C. The LED within the switch is illuminated whenever the 2701C has current output. The user should note that only the 120mA range is available in the current mode and that the voltage range present when the current mode is selected will be reselected when the voltage mode is selected again by the user.

4.1.3.4 "2-WIRE/4-WIRE" Key

This key will alternately select 2-wire or 4-wire mode of operation. The LED within the switch will be illuminated whenever the 2701C is configured for 4-wire operation. The user should note that 4-wire operation in the 120mA mode is not possible. The user is advised to use 4-wire configuration whenever significant loads are present on the 2701C output terminals and/or significant lead lengths are in use. The user should note that, although the output voltage is present on both sets of output terminals, the SENSE terminals should be used for the best accuracy when using the 2-wire configuration.

4.1.3.5 "OPERATE/STANDBY" Key

This key will alternately select the OPERATE or STANDBY modes of operation. In the STANDBY mode the output will be at zero on the selected range. In OPERATE mode the output will be at the requested output voltage or current. The LED within the switch will be illuminated whenever the 2701C is in the STANDBY mode.

4.1.4 "POWER"

This switch controls the power to the 2701C. When in the "ON" position (depressed with yellow dot showing) and with AC power supplied the 2701C will be operational. When in the "OFF" (not depressed) position the 2701C will be unpowered.

4.1.5. "OUTPUT" Section

This section contains the outputs from the 2701C and also the warning indicators.

4.1.5.1 "OUTPUT" Terminals

These terminals carry the output of the 2701C. The user should note that these terminals provide the current to the load and should not be used as the terminals with precision.

4.1.5.2 "SENSE" Terminals

These terminals are the inputs to the sense feedback system within the 2701C. The output voltage to high impedance loads (such as DVMS for example) should be taken from these terminals as this will eliminate any thermal emfs or other voltage drops in the OUTPUT terminal to SENSE terminals links.

4.1.5.3 Lightning Bolt Indicator

This indicator is illuminated whenever an output voltage of 30V or more is selected and the 2701C is in OPERATE.

4.1.5.4 "CURRENT LIMIT" Indicator

This LED will illuminate whenever the current limit of the 2701C is exceeded. When a current limit is detected by the 2701C, the STANDBY mode will be automatically selected.

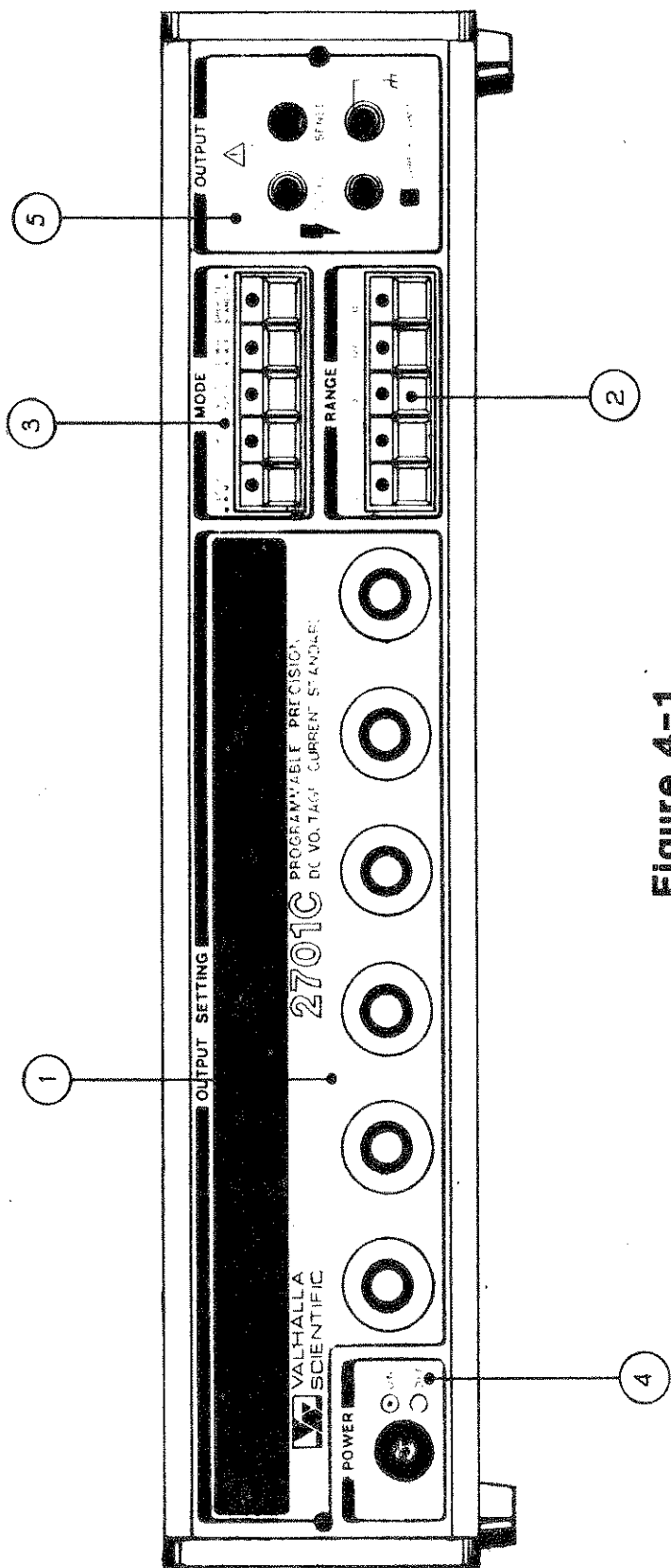

Figure 4-1

SECTION V**REAR PANEL CONTROLS AND CONNECTORS****5.1 General**

The functions of the rear panel controls and connectors are described in the following paragraphs, the paragraph numbers corresponding to the reference numbers of Figure 5-1.

5.1.1 Rear Panel OUTPUT and SENSE Terminals

These low thermal emf terminals are wired in parallel with the respective front panel terminals.

5.1.2 GPIB (IEEE-488) Connector

This is the IEEE-488 interface connector.

5.1.3 IRP INTERFACE Connector

This is the connector which provides the signals and power required to control an external Valhalla Scientific .2500EP Current Calibrator.

5.1.4 Power Connector

This is the AC power connector.

5.1.5 Fuseholder

This contains the main power fuse.

5.1.6 IEEE ADDRESS Switches

These switches are used to set the address to which the 2701C will respond over the IEEE488 bus interface. See Section VII for details.

5.1.7 OPERATE/CALIBRATE Key Operated Switch

This switch is used to enable the calibration mode of operation. Operation of this switch requires the use of the correct key. Refer to Section X for details.

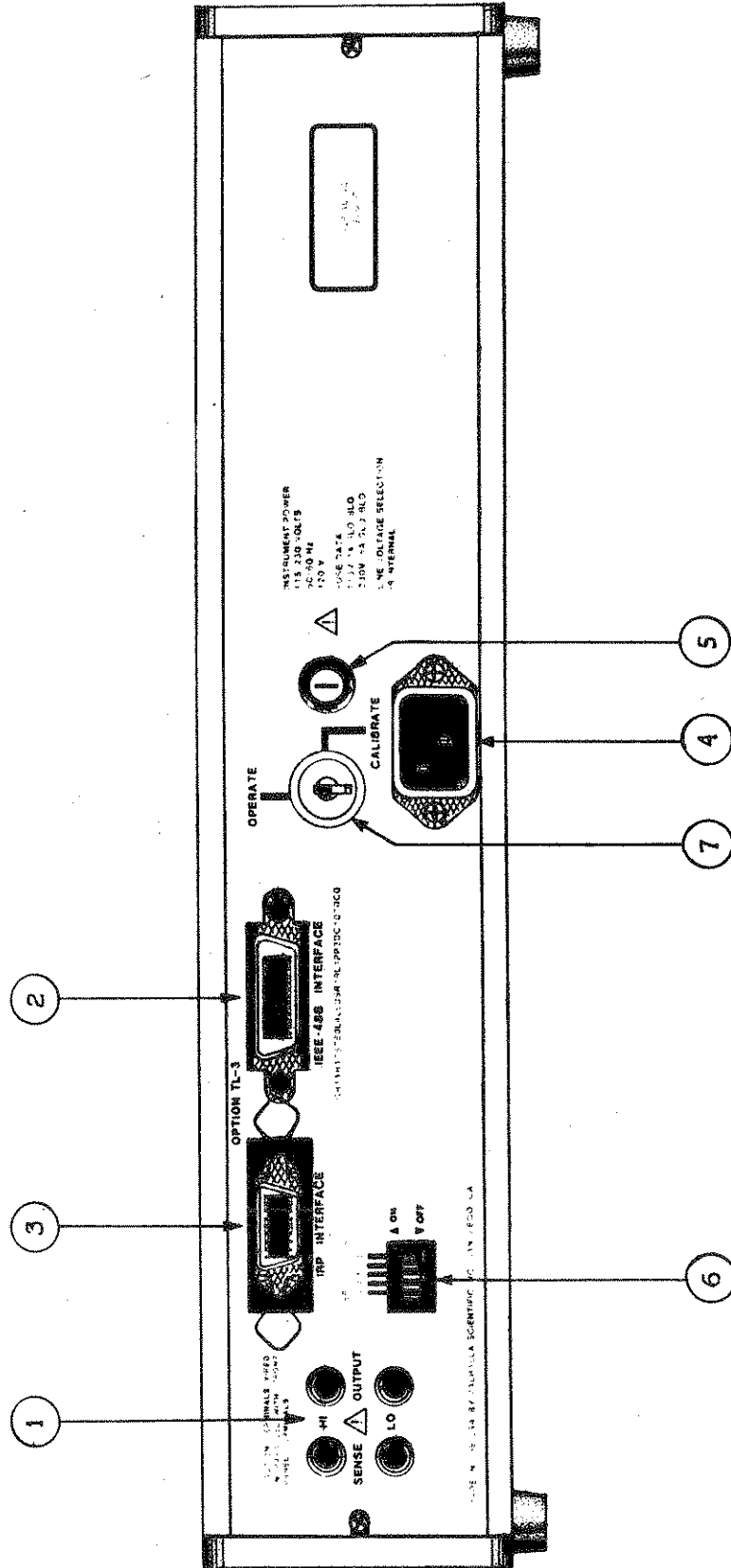

Figure 5-1

SECTION VI**MANUAL OPERATION****6.1 General**

The following paragraphs describe the manual operation of the 2701C and available options and should be used along with Section IV when using the unit. The user is advised to fully read both this section and Section IV before attempting to operate the 2701C manually.

6.1.1 Applying AC Power

Before applying AC power to the 2701C, the user is advised to ensure that the 2701C power switch is in the OFF position (no Yellow dot showing). Push the power switch. The unit will respond by greeting the user in the display, followed after approximately 1 second by the following sequence :

- a) The display will show either the IEEE488 address (if TL-3 option is fitted) or that no IEEE option is fitted.
- b) The display will show the software revision of the unit (e.g. 2701C - 2)
- c) The unit will commence normal operation. Should the display flash then this indicates that the calibration data has become corrupted and a recalibration of the 2701C is required.

Should the preceding procedure fail to occur, turn off the power switch and set the 2701C aside for maintenance.

6.2 Connections

To preserve the full accuracy of the 2701C it is strongly recommended that 4-wire connections be utilized whenever possible to eliminate the possibility of errors due to lead resistance. The user should note that it is the connections to the SENSE terminals which determine the overall accuracy of the 2701C (like any other voltage source) thus it is strongly recommended that low thermal emf shielded cabling be used for the SENSE connections while ordinary shielded cable may be used for the OUTPUT connections. For less crucial applications or when the user is certain that there will be negligible current drawn from the 2701C then 2-wire connections may be used. For 2-wire operation the SENSE terminals should be used for connections. The user is reminded to ensure that, before connecting or disconnecting leads, the unit is in STANDBY to protect the user from any dangerous voltages. The user is further reminded that the 200mV range presents an output impedance of 450 ohms and that 4-wire operation is not possible in this mode nor is it possible on the 120mA current range.

WARNING

**DANGEROUS VOLTAGES ARE PRESENT ON THE
OUTPUT TERMINALS WHENEVER THE
LIGHTNING BOLT ON THE FRONT PANEL IS ILLUMINATED.
THESE VOLTAGES MAY CAUSE**

DEATH**ON CONTACT.**

**NEVER TOUCH THE CONNECTIONS WHILE THE OUTPUT
IS IN OPERATE
OR THE LIGHTNING BOLT IS ILLUMINATED.**

6.3 Setting an Output Voltage or Current

To manually set an output voltage or current the following procedure may be followed:

- a) If connections are to be made or adjusted then first select the STANDBY mode (if the STANDBY LED is not illuminated then press the STANDBY/OPERATE key) before adjusting or making the connections.
- b) Select the desired range by pressing the 200mV, 2V, 20V, 120V, 1200V or 120mA key as desired. The user should note that if the 2701C is presently on the 120mA range then pressing a voltage range key will automatically deselect the current mode and select the voltage mode.
- c) Adjust the displayed value of output voltage (or current) by the use of the dials under each display window. The user should note that clockwise rotation of the dials will cause the displayed digit above the dial to increase in value while counter-clockwise rotation will cause it to decrease in value. The 2701C will perform all required carries or borrows from preceding digits, thus the user may continuously alter the output by using one dial only, if so desired.
- d) Select the required polarity of output by pressing the +/- key if required. The user should note that the LED in the +/- key is illuminated for a positive output polarity.
- e) Select OPERATE if required (i.e. press STANDBY/OPERATE key)

6.4 Performing the Calibration of a Voltmeter

This is achieved by connecting the Voltmeter to the 2701C as shown in Figure 6-1. It is recommended that the 2701C be placed in STANDBY before making the connections.

a) Select the required calibration voltage or current from the 2701C by using the RANGE, 120mA, and/or +/- keys as required and the dials (see 6.3).

b) Modify the output from the 2701C using the dials until the voltmeter reads the required voltage (as entered into the 2701C in step a).

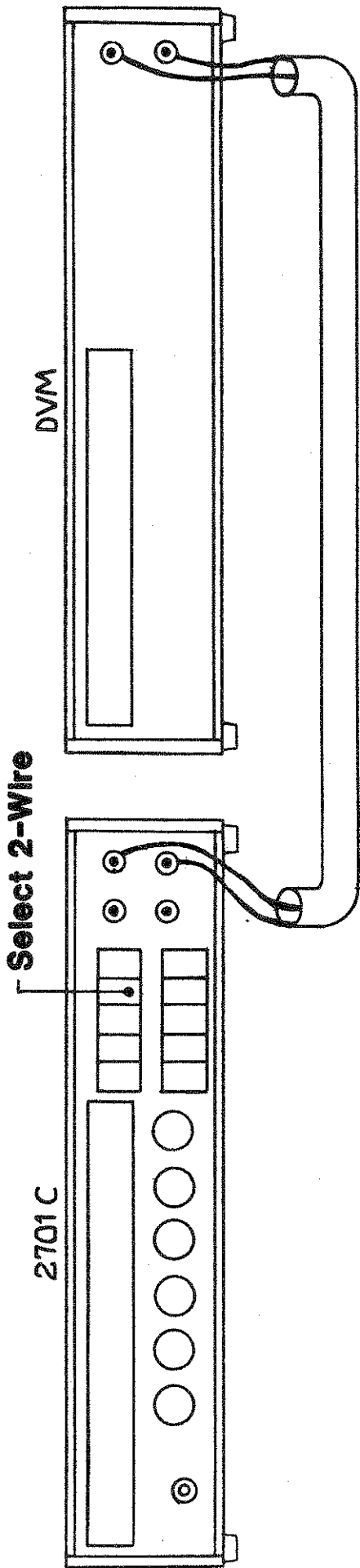

Figure 6-1a Two Terminal Connections (All Ranges)

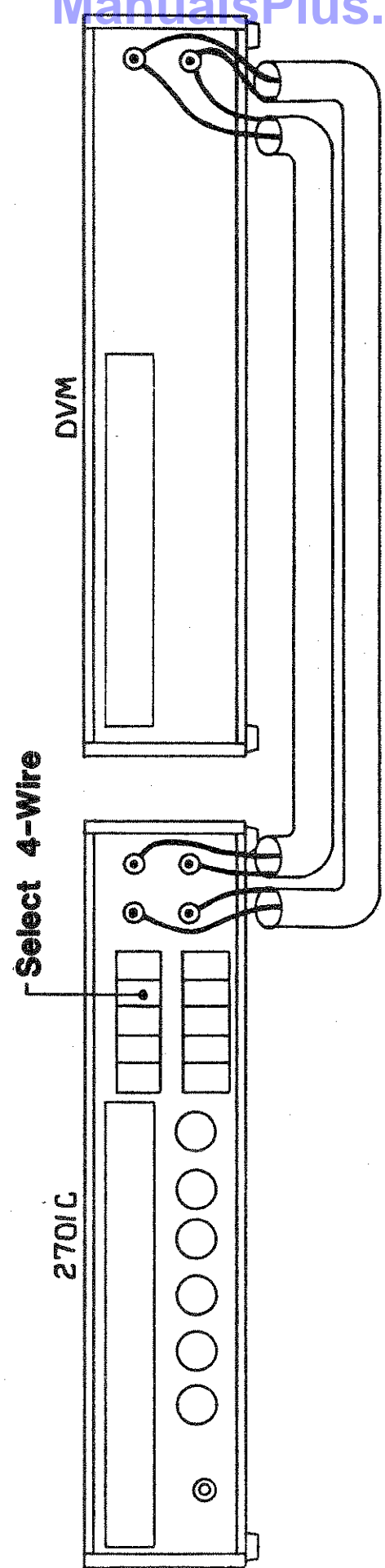

Figure 6-1b Four Terminal Connections. (Excluding 200mV Range)

SECTION VII

REMOTE OPERATION

7.1 General

This section contains a description of the IEEE 488 bus and how to use this interface to control and operate the 2701C. It is assumed throughout this section that the user has read Sections IV and VI, and is familiar with the manual operation of the 2701C.

7.2 Definitions

The following are definitions of the terms used in describing the IEEE 488 interface and its operation in the 2701C.

Bus : A data link which is usually a set of several parallel wires within a multi-wire cable.

Bi-directional Bus : A "highway" used for two-way communication between to devices, with input and output data being carried on the same wires.

Bit parallel : A data transmission method in which all of the bits comprising an item of data are present simultaneously on a group of wires in a bus.

Byte : A group of data bits (usually 8) which are treated as a single item of data.

Byte serial : A data transmission method in which information, in bit parallel bytes, is transferred sequentially between devices.

Device : A unit or controller connected to the bus.

Device dependent message : A message containing information or commands having meaning only to the recipient device (usually refers to commands which are not included in the IEEE 488 (1978) standard).

Handshake : An exchange of signals between two devices which is usually used to control the transfer of data between them.

Interface message : A message intended for interface or bus management.

Local operation : Operation of a device by its front panel controls or other form of manual operation.

Remote operation : Operation of a device under the control of another via the bus.

7.3 Basic Description of the IEEE 488 (1978) Bus

This chapter gives a basic description of the general principles of the IEEE 488 (1978) bus (also known as GPIB, HP-IB, IEC DTC-66, ANSI MCl-1 etc.). The user is recommended to read the full IEEE-488 standard for more details if required.

7.3.1 The Purpose of the IEEE 488 Standard

The purpose of the standard is to allow for interconnection of programmable instruments with a minimum of engineering. Its intent is to remove the need for adapters and numerous types of patching cables often encountered with other forms of interfaces. The IEEE 488 standard allows system configurations using programmable instruments, calculators and other types of peripheral devices produced by different manufacturers, providing a set of rules for establishing an unambiguous communications link with a high degree of compatibility yet maintaining flexibility between independently manufactured products.

The IEEE 488 (1978) standard defines the :

Electrical characteristics - interface circuit parameters, electrical signal levels, loading requirements and grounding requirements.

Mechanical characteristics - connector type, contact assignments and cable assembly.

Functional characteristics - the complete repertoire and precise definition of each of the signal lines, the protocol and timing relationships and the response to each message.

The IEEE 488 (1978) standard does not define the :

Way in which information (device dependent messages) will be interpreted by the receiving device.

Maximum amount of time for a full handshake of data to occur (it does define the minimums however).

7.3.2 Basic IEEE 488 Standard Defined Parameters

The IEEE 488 standard defines a bi-directional bus carrying bit parallel, byte serial data. The most basic of its definitions are as follows :

All bus data is digital

A maximum of 15 devices may be interconnected on a single bus

The total length of the bus cabling may not exceed 20 meters, with a maximum interconnection cable length of 4 meters.

The maximum data transmission rate is 1 megabyte per second

Of all the devices on the bus only one may be the controller at any

time. The controller exercises control over all other devices on the bus. The other devices may be listeners (only able to receive data), talkers (only able to transmit data) or both (as is the 2701C, capable of both transmitting and receiving data). The controller is the only device capable of addressing other devices on the bus and commanding them to talk or listen as required. Only one device may talk at any one time.

The interconnecting cable consists of 16 signal wires and eight ground returns linking devices into a complete system (the user is cautioned to be careful of generating ground loops when interconnecting devices via the bus). Each cable connector is a plug and socket combination to permit the "daisy chaining" of devices.

The 16 signal wires are as follows :

8 data wires (DIO0 through DIO7 inclusive)
5 management wires (ATN, EOI, SRQ, IFC and REN)
3 handshake wires (DAV, NRFD and NDAC)

It should be noted that all of these wires use "inverse logic", i.e. a low voltage level indicates the "true" state (also called "asserted") while the high voltage level indicates the "false" state.

DIO0 to 7 - These wires are the bi-directional data bus

ATN - This wire may be asserted by the controller to indicate that an address or command is present on the bus.

EOI - This wire may be asserted by the controller or the talker. If ATN is also asserted, then EOI being asserted indicates that the controller is polling devices. If ATN is false, then EOI may be asserted by the talker to indicate the end of a message (see 7.5.1.3).

SRQ - This wire may be asserted by any device to indicate that it requires attention (e.g. a fault has occurred or data is ready). Usually the controller will respond by polling the devices to determine which requires service.

IFC - This wire is asserted by the controller to reset the bus (note that only the bus is affected) to an idle state.

REN - This wire is asserted by the controller to indicate to all devices that they may enter the REMOTE state. The user should note that for a device to enter REMOTE the REN wire must be asserted and the device must subsequently receive its listen address. If this wire is not asserted then all devices will be in the LOCAL state.

DAV - This wire is asserted by the talker and indicates that a valid data byte has been placed on the DIO0 to 7 wires.

NRFD - This wire may be asserted by any listener and indicates that it is not yet ready to receive further data.

NDAC - This wire may be asserted by any listener and indicates that it has not yet completed reading the data byte present on the DIO wires.

7.4 Device Independent Messages

This paragraph describes all of the IEEE 488 defined commands and their affect upon the operation of the 2701C.

In this paragraph (as in all further paragraphs) examples are given for the HP85 computer and it is assumed that the 2701C has its address set to 15.

7.4.1 Device Clear (DCL)

This command will cause all of the devices to enter the reset state (both interface and instrument functions). The 2701C will perform a power on reset cycle when this is received.

The user should note that this command can cause "peculiar" activity by the devices on the bus. This is because the device clear itself will cause the interface to reset, as soon as the interface is again ready to read the bus it may re-read the device clear command, if a slower device has not yet released the hand-shake, and thus restart a further device clear. This will be visible as a complete bus lock-out with all of the devices continuously performing a device clear. Although every precaution has been taken in the 2701C to eliminate this problem with the IEEE 488 Standard, it cannot be entirely overcome. If possible the user is recommended to use the Selective Device Clear command (7.4.2).

This command is implemented with the HP85 by the statement **CLEAR7**

7.4.2 Selective Device Clear (SDC)

This command will cause the addressed device to individually enter the reset state. This command will perform the same function as the DCL command in 7.4.1 but only on one unit at a time, thus overcoming the problem inherent with the DCL command.

This command is implemented with the HP85 by the statement **CLEAR715**

7.4.3 Group Execute Trigger (GET)

The execution of this command is dependent on the particular device receiving it, the exact result not being defined by the IEEE 488 (1978) standard. When received by the 2701C it will be handshaked and will not cause an error but will be ignored.

The user should note that only the addressed form of this command is defined by the IEEE 488 (1978) standard however certain manufacturers also include an unaddressed form of this command. The result of receiving this "unofficial" command by the 2701C is not defined and may cause bus errors if used.

This command is implemented in the HP85 by the statement **TRIGGER715** for the addressed form, and **TRIGGER7** for the unaddressed, "unofficial" form.

7.4.4 Go To Local (GTL)

This addressed command will cause the individual addressed device to enter the LOCAL state (i.e. enables manual operation of the device). This command is fully implemented in the 2701C and is commanded by the HP85 statement **LOCAL715**.

The user should note that many computers also have a similar unaddressed version of this command (**LOCAL7** for the HP85). This command is actually quite different from the addressed command (it unasserts the REN line) but will cause all of the devices, including the 2701C to enter the LOCAL state.

7.4.5 Interface Clear (IFC)

This command will cause all of the interfaces of the devices to enter an idle state. This is fully implemented in the 2701C and may be commanded with an HP85 by the statement **RESET7**.

7.4.6 Identify (IDY)

This command is also called "parallel poll".

This will cause all devices to respond by simultaneously placing their parallel poll response byte onto the DIO bus wires. The 2701C fully implements this command which is commanded with an HP85 by the statement **PPOLL7**.

7.4.7 Local Lock Out (LLO)

This command will cause all of the devices to enter either the LOCAL WITH LOCK OUT or REMOTE WITH LOCK OUT state (depending on whether they were in LOCAL or REMOTE states respectively). The function of this command is to disable the manually operated LOCAL key or control on the devices. The 2701C fully implements this command which may be commanded with an HP85 by the statement **LOCKOUT7**.

7.4.8 Parallel Poll Configure(PPC), Enable(PPE), Disable(PPD) and Unconfigure(PPU)

These commands are used to set the Parallel Poll response byte and to dis/en-able the parallel poll response. These commands are not implemented in the 2701C and are ignored if received.

7.4.9 Remote Enable (REN)

This command (the assertion of the REN wire) enables all devices to enter the REMOTE state when they next receive their listen address. The 2701C fully implements this command which may be commanded with an HP85 by the statement **REMOTE7**.

Many computers also have a command which includes the sending of the listen address which will immediately place the addressed device into the REMOTE (or REMOTE WITH LOCK OUT, see 7.4.7) state. With an HP85 this is accomplished by the statement **REMOTE715**

7.4.10 Serial Poll Enable (SPE) and disable (SPD)

These commands control the process of performing a serial poll. The serial poll sequence is as follows :

- a) The controller commands SPE
- b) The controller addresses a single device as a talker
- c) The addressed device returns its Serial Poll response byte
- d) The controller reads the response byte
- e) The controller may now repeat the sequence from b) or send SPD to end the serial poll

The 2701C fully implements this function and may be commanded to send its serial poll response byte with an HP85 by the statement **SPOLL(715)**. This statement will implement the entire sequence once.

7.4.11 Take Control (TCT)

This command from the controller to another potential controller will request the other to take over as controller. The 2701C does not have the capability of becoming a controller thus this command is not implemented and will be ignored.

7.5 IEEE Commands for the 2701C (Device Dependent)

The command set for the 2701C is described in the following paragraphs. For each command examples are given and, as for the previous paragraphs, they assume the 2701C has an address of 15 and that an HP85 computer is used.

7.5.1 REMOTE and LOCAL States

Although not device dependent commands, a full explanation of the implementation of the LOCAL and REMOTE states is explained here.

7.5.1.1 LOCAL

When the 2701C is in the LOCAL or the LOCAL WITH LOCK OUT states the REMOTE LED on the front panel is extinguished and full manual control of the 2701C as described in Sections IV and VI may be performed. The user should note that it is not possible to enter the REMOTE state manually other than via the controller. Although they are separate states there is no difference apparent to the user between the LOCAL and LOCAL WITH LOCK OUT states, the difference not becoming apparent until the 2701C is commanded into REMOTE. The user should note that the 2701C will accept commands from the IEEE 488 bus while in LOCAL but they will be discarded, the unit may however be read at any time.

If desired, more than one command may be transmitted on the same line, there is no required separator however the user should ensure that each command cannot be decoded as part of the previous command (particularly when using free format) thus the use of a comma is advised. The user should note that the 2701C will except any number of characters on the same line (i.e. up to the terminator) with a maximum limit of 20 characters. If more than 20 characters are sent to the 2701C without a terminator then the 2701C will discard the entire line and will generate an error condition. The commands are not actioned until a terminator is received (either "Line feed" character or EOI asserted with the last character, or both) when any valid commands are executed in the order received. If an erroneous command is received then an error message is generated and the remaining portion of the line is discarded.

7.5.2.2 Data Format from the 2701C

There is only one type of data which may be read from the 2701C and this may be read any number of times as required. The data read from the 2701C will be in the following format :

```
sn.nnnnnnEsn xxo
```

where s is either + or - indicating polarity

n is a numeric digit

E is the character E indicating the start of the exponent

xx is " V" if the 2701C is in voltage mode and the IRP is not commanding a current range.

"mA" if the 2701C is in voltage mode and the IRP is commanding a current range.

"uA" if the 2701C is on the 120mA range.

o is a space character if in OPERATE or a "*" if in STANDBY

7.5.3 Post RESET Delay

To ensure that all wires are settled following a device clear or L command it is recommended that a 3s minimum delay is forced prior to performing any bus operation with the 2701C following either of the above actions. The user should also note that the 2701C will not operate the IEEE 488 bus until the complete set of status messages have been displayed following a power up. Any bus activity with the 2701C during either of the above periods of time may cause undefined results.

7.6 Commands and Examples

This set of paragraphs list each command, its exact operation and one (or more) example which may be used with an HP85 computer with the 2701C set to address 15. The actual statement for the HP85 is printed in bold.

7.6.1 Commands That are ALWAYS Executed

These paragraphs contain the commands which are always executed independent of the activity currently being performed by the 2701C.

7.6.1.1 "T" - 2 or 4-Wire Control

This command is used to control the 2- or 4-wire mode of configuration of the 2701C. The "T" command should be followed by an integer which may be either a "0" (to select 2-wire configuration) or a "1" (to select 4-wire configuration). The user should note that 4-wire configuration is not possible while the 2701C is on the 200mV or 120mA ranges.

EXAMPLE :

OUTPUT715;"T1" Selects 4-wire configuration

7.6.2 Commands Which Cannot be Executed During Calibration

7.6.2.1 "V" - Set Output Voltage or Current (Direct Format)

This command will set the individual digits of the 2701C display to the required data following the "V" character and will also force the 2701C into the OPERATE mode. This command provides compatibility with previous 2701 series products and is not recommended for new applications. The user should note that if all 6 digits are not included after the V character then the remaining digits are left unchanged by this command. The user should also note that this command does not affect the range of the 2701C and that displays above 1222221 cannot be achieved with this command.

EXAMPLES :

OUTPUT715;"V000000" sets the display to 0000000

OUTPUT715;"V:00000" sets the display to 1000000

OUTPUT715;"v123456" sets the display to 0123456

OUTPUT715;"V" does not affect the display but places the 2701C in OPERATE

7.6.2.2 "I" - Set IRP and Output Polarity

This command will control the range of a 2500EP which is connected to the IRP connector on the rear panel and will also control the polarity of the 2701C output. This is achieved by the two characters following the I character.

The first character following the I will control the 2500EP through the IRP port as follows :

```
9 100uA range
: 1mA range
; 10mA range
< 100mA range
= 1A range
> 10A range
```

Any other character in this position will select for the 2500EP to select no range. The user should note that selection of a range on the 2500EP has no affect on the settings of the 2701C itself.

The second digit is used to control the output polarity of the 2701C. If the least significant bit of the ASCII code is a 0 (e.g. 0,2,4,6,8 etc.) then the output will be of positive polarity while a 1 (e.g. 1,3,5,7,9 etc.) will cause a negative output polarity.

As for the V command above this is included to produce compatibility with earlier 2701 series products and is not recommended for new applications.

7.6.2.3 "R" - Set Output Range

This command will select the voltage range of the 2701C to the range indicated by the digit character following the R character. Selection of this command will automatically deselect the internal 120mA range if required.

The character following the R defines the range as follows :

```
0 2V range
1 20V range
2 120V range
3 1200V range
```

The user should note that this command cannot access the 200mV range. This command is included for compatibility with earlier 2701 series products and is not recommended for new applications.

7.6.2.4 "VO" - Set Voltage Output (Free Format)

This command will cause the 2701C to select a voltage output of the quantity defined by the free format number following the VO characters. This command will deselect both the IRP outputs and the 120mA range if active at the time. The 2701C will automatically select OPERATE upon decode of this command.

EXAMPLES :

OUTPUT715;"VO+1.123456" selects an output of 1.123456V
 OUTPUT715;"vo+1.234e-3" selects an output of 0.001234V
 OUTPUT715;"vo-1001.4567" selects an output of -1001.456V
 OUTPUT715;"VO",A selects an output of A volts

Note that the 2701C will automatically select the best possible range to output the desired voltage and will discard any extra digits specified.

The user should note that this command supercedes the V and I commands mentioned previously, and the use of this command is recommended for new applications.

7.6.2.5 "IO" - Set Output Current (IRP Free Format)

This is similar to the VO command in 7.6.2.4 but will select the required output current from a Valhalla Scientific 2500EP. The current is defined by the free format numeric quantity following the IO characters in milliamps. The 2701C will automatically deselect the internal 120mA range (if active) and will select the best possible combination of 2701C output voltage and 2500EP range to achieve the desired current output. The 2701C will automatically select OPERATE upon decode of this command.

7.6.2.6 "II" - Set Output Current (Internal Free Format)

This command is similar to the VO command in 7.6.2.4 but will select the required output current from the 2701C (if Option IT-2 is fitted) directly (unlike the IO command in 7.6.2.5). Upon decode of this command the 2701C will automatically deselect the 2500EP range. The 2701C will automatically select OPERATE upon decode of this command.

7.6.2.7 "S" - Select STANDBY

This command will cause the 2701C to enter the STANDBY mode and will not affect the range, IRP range or any other status of the 2701C.

7.6.2.8 "E" - Select Output Delimiter

This command will cause the character(s) following the standard data output from the 2701C to be set to the required data. The numeric character following the E character defines these characters as follows :

- 0 (Carriage Return)(Line Feed)
- 1 (Carriage Return)(Line Feed with EOI asserted)
- 2 (Carriage Return)
- 3 (Carriage Return with EOI asserted)
- 4 EOI asserted with the last character in the standard output

7.6.2.9 "Q" - Select SRQ Cause

This command will control whether the 2701C will assert the SRQ wire if an erroneous message is received. The numeric character following the Q character defines this as follows :

- 0 2701C will not assert SRQ
- 1 2701C will assert SRQ

7.6.3 Commands That Can Only be Executed During Calibration

The technique used for calibration of the 2701C while under IEEE488 control is basically similar to the manual technique. The user is strongly recommended to read the section on calibration (see Section VIII) before attempting to perform a IEEE488 controlled calibration. The procedure followed for IEEE488 controlled calibration is the same as that for manual calibration.

The procedure for each step in the procedure is the same and follows the following procedure :

- i) Increase (with the U command) or decrease (with the D command) the output to obtain the indicated output voltage.
- ii) Terminate the step and proceed to the next step by the use of the N command.

The user should note that the calibration sequence MUST be started by turning the rear panel mounted key-operated switch to the CALIBRATE position and MUST be terminated by turning this switch back to the OPERATE position when requested to do so on the front panel (i.e. when all steps have been completed)

If the user wishes to skip a step without altering the stored calibration data then this is achieved by the N command without altering the output by the U or D commands.

7.6.3.1 "U" - Increase the Output

This command will cause the 2701C to increase the output voltage (or current if calibrating option IT-2) by the quantity defined by the numeric character following the U character. The amount is as defined below :

- 0 Approx. 0.25ppm of range
- 1 Approx. 4ppm of range
- 2 Approx. 64ppm of range

7.6.3.2 "D" - Decrease the Output

This command is identical to the U command in 7.6.3.1 except that it decreases the output instead of increasing the output.

7.6.3.3 "N" - Step on to the Next Calibration Step

This command will cause the 2701C to terminate the calibration step in progress and update the relevant calibration data, then step on to the next step in the calibration procedure (if any).

SECTION VIII

CALIBRATION

8.1 General

The following paragraphs describe the overall calibration requirements for the 2701C and the method for performing the calibration of the unit. It is assumed that the user is familiar with the operation of the 2701C and that section VI has been read.

8.2 Calibration Philosophy

The maintenance of the specifications of the 2701C is achieved by the periodic calibration of the unit. The 2701C may be calibrated at any desired interval and will require the use of the following equipment :

a) DC Voltage measurement equipment capable of measuring 0V (within 0.5uV), 0.1V (within 1uV), 1V (within 5uV), 10V (within 30uV), 100V (within 500uV) and 1000V (within 5mV). The use of a Valhalla Scientific 2720GS or 2720HSR is strongly recommended.

b) High quality, low thermal emf cabling. The use of Valhalla Scientific option SL-48 is recommended (2 required with 2720GS or HSR).

The philosophy of calibration is that the user corrects the 2701C's output to be the exact value required and then steps on to the next step in the sequence. The 2701C will then calculate the required correction factor and store this data in non-volatile memory for future use.

8.3 Calibration

A calibration of the 2701C is always started by the user turning the rear panel mounted key-operated switch to the CALIBRATE position. The 2701C will automatically select the next step in the sequence whenever the previous step has been completed and each step follows the identical procedure outlined below :

8.3.1 Procedure For Each Step

8.3.1.1 Manual Calibration Procedure For Each Step

i) At the start of each step the 2701C will display the required output voltage/current in the display with a "C" in the least significant window (rightmost window).

ii) The user should (using the three rightmost dials only) adjust the output of the 2701C until the exact required quantity is actually being output. The user should note that the display will always show the required quantity, thus will not change as the dials are turned. The user should note that the dials do not alter the output by the same amount as they would in normal operation, but have the significance shown below :

Sixth dial : 0.25ppm of range (approx)

Fifth dial : 4ppm of range (approx)

Fourth dial : 64ppm of range (approx)

iii) When the correct quantity is being output by the 2701C, the user should press the STANDBY/OPERATE key. This will cause the present step to be completed and the next step (if any) to be started.

The user should note that if step ii) of the above procedure is omitted then the next step will be selected without altering the calibration data for that step, thus a step may be skipped if desired.

8.3.1.2 Remote (IEEE 488) Calibration Procedure For Each Step

The procedure for remotely calibrating the 2701C is shown in the previous section (Section VII).

8.3.2 Calibration Sequence

The sequence of calibration (manual or remote) of the 2701C and the tolerance required at each step is shown below :

i)	200mV range zero	0V +/- 0.5uV
ii)	2V range zero	0V +/- 1uV
iii)	20V range zero	0V +/- 10uV
iv)	120V range zero	0V +/- 100uV
v)	1200V range zero	0V +/- 1mV
vi)	200mV range scaling	100mV +/- 0.5uV
vii)	2V range scaling	1V +/- 5uV
viii)	20V range scaling	10V +/- 30uV
ix)	120V range scaling	100V +/- 500uV
x)	1200V range scaling	1000V +/- 5mV
xi)	120mA range zero	0mA +/- 0.5uA
xii)	120mA range scaling	100mA +/- 2uA

The user should note that the last two steps are only used if option IT-2 is fitted and requires the use of a 10 ohm +/- 20ppm four terminal resistance standard (e.g. Valhalla Scientific 2718A).

After completion of all of the above steps the 2701C will display "END CAL". The user should then return the key-operated switch to the OPERATE position.

SECTION IX

MAINTENANCE AND TROUBLESHOOTING

9.1 General

The following paragraphs provide the information required to perform the required periodic maintenance and basic guidelines for troubleshooting the 2701C.

9.2 Periodic Maintenance

The 2701C requires little periodic maintenance, that which is required is discussed in the following paragraphs.

9.2.1 Cleaning

It is recommended that the 2701C be operated in a clean environment, however if the environment is "dusty" then periodic cleaning of the unit will be required.

Loose dirt or dust, which is collected on the exterior surfaces of the 2701C, may be removed with a soft cloth or brush. Any remaining dirt may be removed with a soft cloth dampened in a mild soap and water solution. **Do not use abrasive cleaners.**

The front panel may be cleaned with a soft cloth and a "Windex" type cleaner. **Do not use petroleum based cleaners on the front panel.**

If required, the 2701C interior may be cleaned by blowing with dry compressed air.

If the 2701C has become "heavily" contaminated with dirt or by other contaminant(s) then it is recommended that the unit be completely overhauled (contact your local Valhalla Scientific Service Center for details).

9.3 Troubleshooting

The following paragraphs give basic procedures for troubleshooting and component replacement in the 2701C.

9.3.1 Component Replacement

The 2701C accuracy and reliability can only be maintained if the following precautions are taken when changing a component:

a) Only use the specified component or exact equivalent. Spare parts can be ordered from your nearest Valhalla Scientific Service Center by the Valhalla part number listed in the parts list in section XIV of this manual. Please provide the type and serial number of the unit with your order.

b) Only use 63/37 rosin core electronic grade solder with a 50W (or lower) maximum power soldering iron.

c) Always use extreme care when removing or inserting components.

d) Many of the semiconductor devices used in the 2701C can be damaged by static discharges. Thus the user should follow strict

static free procedures to ensure that damage does not occur.
The user should :

Minimize handling of components and assemblies to a minimum.

Transport and store components in the original containers.

Discharge any static build up on the user (or 2701C) prior to handling components or assemblies.

Handle the components such that all (or many as possible) of the leads are in contact with the user.

Never slide a component over a surface.

Use a grounded tip soldering iron and ensure that the assembly being (de)soldered is also grounded.

e) When soldering leads to the terminals the user must ensure that the highest possible quality soldering is used. A dry joint may cause the 2701C to exceed its specification limits.

9.3.2 Assembly Replacement

The only user replaceable assembly in the 2701C is the option TL-3 assembly which may be ordered under that part number on an exchange basis.

9.3.3 Finding the Faulty Component

WARNING

THE 2701C PRODUCES HIGH VOLTAGES THEREFORE

DEATH

MAY RESULT IF PERSONNEL FAIL TO OBSERVE SAFETY PRECAUTIONS

It is not possible to anticipate all failure modes of the components in the 2701C, therefore the servicing technician should be familiar with the contents of Section X of this manual. Experience has shown that malfunctions are often the result of misinterpretation of the specifications or operating procedures of the unit. Check to be sure that the cables and other test equipment are in good order before attempting to fault find the 2701C.

KNOWLEDGE OF CIRCUIT OPERATION IS A PREREQUISITE FOR EFFICIENT FAULT FINDING IN THE 2701C.

As a servicing aid the troubleshooting chart below lists a number of fault symptoms and the probable causes. If the exhibited fault symptom is not shown or a check of the probable causes does not locate the source of the problem then it will be necessary to employ normal troubleshooting procedures.

SYMPTOM	PROBABLE CAUSE
No display	Check AC Power source Check power fuse Check 5V DC power supply Check microprocessor section
Displays random data	Check microprocessor section
Output at very high voltage all of the time	Check TR1-12 etc.
Output does not change except when range changed	Check IC107, 110, 111 and TR13 - 16.
Output slightly non-linear	Check TR14, 16, R34-37
Output noisy (Low frequency)	Check IC5
Output noisy (Medium frequency)	Check IC8
Output noisy (High frequency)	Check C15, IC5 etc.
Output OK but will not exit current limit	Check IC9, 10 etc.
Output slow recovering from 1000V	Check TR17, RLJ, R220, 222
Output incorrect on one range only	Check relays and R32,41,42,48 R52,53 if 200mV range

SECTION X

THEORY OF OPERATION

10.1 General

This section gives the theory of operation of the circuitry used in the 2701C, and is divided into two parts. The first part is a functional description referring to the block diagram shown in Figure 10-1, the second being a detailed description referring to the schematic diagrams found at the end of this manual.

10.2 Functional Description

This section describes the general operation of each section of the 2701C. The paragraph titles refer to the block diagram shown in Figure 10-1.

10.2.1 Microprocessor

This section contains the microprocessor and associated components which accepts inputs from the keyboard, IEEE and overload detection circuitry and outputs the data to the display, IEEE, D-to-A convertor and Relay drive circuitry. As can be seen in the block diagram this section is the central section of the 2701C, all data in the 2701C flows through this section.

10.2.2 IEEE

This section contains all of the interface circuitry required for communication between the IEEE 488 bus and the microprocessor bus.

10.2.3 Display

This section contains all of the displays and LEDs on the front panel of the 2701C and is driven under direct control of the microprocessor.

10.2.4 Keyboard

This section contains all of the front panel controls of the 2701C and directly provides this data to the microprocessor.

10.2.5 D-to-A Convertor

This section of the circuitry generates a variable DC voltage signal from data provided by the microprocessor. This data is obtained from data collected from the IEEE 488 bus or from the front panel settings as required.

10.2.6 Relay Drives

This section contains the drive circuitry for the various range and mode selection relays in the 2701C and is driven directly by the microprocessor section.

10.2.7 Sense Feedback

This section compares the actual sensed output voltage with the output of the D-to-A convertor and alters the input to the output drive section to perform the required correction for any error present. It is this section and the D-to-A convertor section which determine the overall accuracy and performance of the 2701C other than output drive capability.

10.2.8 Output Drive

This section is controlled by the Sense Feedback section and provides the actual output voltage from the 2701C. The user should note that this section does not affect the accuracy of the 2701C other than output drive capability.

10.2.9 Current Drive

This section performs the same function as the Output Drive section but generates the 120mA range output current, while the output drive section is configured to generate output voltage (with up to 25mA drive).

10.2.10 Power Supply

This section provides all of the power rails required in the 2701C.

10.3 Detailed Description

The paragraphs that follow use the same functional blocks as that used in 10.2, but give full detail on their operation down to individual component level. Throughout this section it is assumed that the reader has a knowledge of electronics and is conversant with the operation of the 2701C from the front panel.

10.3.1 Microprocessor

The schematic for this section is contained in Sheet 2 of 2701-075. This section consists of 5 sub-sections as follows :

10.3.1.1 MC6802 Microprocessor

The microprocessor itself is IC101 and is a Motorola MC6802. This device contains all of the Random Access Memory required, within the IC itself. A full description of the operation of the microprocessor is beyond the scope of this manual and user is referred to the manufacturers data sheets and publications for details on the operation of this microprocessor. Communication with the other sub-sections is by means of the two main busses:

i) The Data Bus - This consists of 8 lines (D0 to 7) and is a 3-state bus for data and instruction transfer into and out of the microprocessor.

ii) The Address Bus - This consists of 16 lines (A0 to 15) and four bus control lines, R (Read), I (Interrupt), V (Valid Memory Address) and E (Enable). The 16 bus lines are used to specify the device to/from which the microprocessor is sending/reading data. The R line defines if the microprocessor is reading (Logic 1) or

writing data. The I line is pulled low if a device wishes to interrupt the microprocessor (the IEEE interface does this). The V line is a logic 1 if the microprocessor is accessing a valid address. The E line is the bus clock which is 1MHz in the 2701C, bus transactions being valid during the logic 1 portion of this signal.

10.3.1.2 ROM

The microprocessor instructions are stored in Read Only Memory (ROM) which is IC102. This is a 8192 by 8 bit memory which is preprogrammed by Valhalla Scientific with the instructions for operating the 2701C.

10.3.1.3 NOVDRAM

The calibration constants for the 2701C are stored in Non-Volatile Random Access Memory which is IC103. This is a 64 by 4 bit (2701C) or 256 by 4 bit (Option IT-2) memory which maintains the stored data even if power is removed. The updating of this non-volatile data is controlled by means of SW101 (the rear-panel key operated switch) disabling the microprocessor from writing data into this device except when this switch is in the CALIBRATE position.

10.3.1.4 Interface

The microprocessor interfaces with external circuitry through Peripheral Interface Adapters (MC6821). These devices (IC108 and 109) are used to latch the data output from the microprocessor and to enable the microprocessor to read the data input to it. These devices are used to interface to the Relay Drive, Keyboard and Display sections of the 2701C.

10.3.1.5 Address Decode

The various sections of the microprocessor are enabled in their respective address portions by the address decode devices IC104 and 105. These devices take the most significant 6 address bus lines (A10 to 15) and "split" the available address space into 15 portions. IC104 splits the entire address range into 8 portions, one of which is further split by IC105 into 8 portions.

10.3.2 IEEE

This section of the 2701C is shown on the schematic 2701-077, is located on the PCB mounted on the rear panel of the 2701C, and consists of two sub-sections :

10.3.2.1 IRP Interface

This interface is simply a latch providing 8 static lines under microprocessor control. The device is a 74LS574 and is notated as IC5. The outputs of this device drive the bases of six transistors (TR1 to 6) via 1Kohm resistors (in RN2) to provide open collector type drives for the 2500EP.

10.3.2.2 IEEE 488 Interface

This interface consists of an address switch and 3-state buffer (SW1 and IC1) and an interface device (Motorola MC68488, IC2) with bus transceivers (MC3447, IC3 and 4) for driving the bus itself. The operation of these devices is beyond the scope of this manual and the user is referred to the manufacturers data sheets and publications for details.

10.3.3 Display

The display circuitry is located on the front panel PCB (located immediately behind the front panel of the 2701C) and is shown in the upper half of schematic 2701-076. The displays are multiplexed by the microprocessor directly by means of a code presented to the inputs of IC1, which will decode this and drive one display at a time through the PNP transistors TR1 to 10. The elements of each display are driven by the microprocessor via the buffer ICs IC113 and 114 on the main PCB and the resistors in the network pack RN3.

10.3.4 Keyboard

The keyboard circuitry is located on the front panel PCB (located immediately behind the front panel of the 2701C) and is shown in the lower half of the schematic 2701-076. Each switch is interrogated, one at a time, by means of the microprocessor providing a code to the inputs of IC2 which enables one switch at time. The state of each switch is thus read by the microprocessor through the buffer ICs IC3 to 8.

10.3.5 D-to-A Convertor

This circuitry is located on the main PCB and is shown on the schematic 2701-075 sheets 1 and 2. This convertor is of the duty cycle type. That is a variable duty cycle, fixed frequency, waveform is generated where the highest voltage is defined by a reference voltage and the lowest voltage is 0V. Thus the average (or filtered) output voltage is an exact ratio of the reference voltage. This is achieved in the 2701C as follows :

- i) A timer device IC107 (Motorola MC6840) is used to provide two variable duty cycle waveforms at 40ms period (approx.) under the control of the microprocessor.
- ii) These two waveforms and the system clock (1.5MHz) is buffered by IC106 and then optically isolated by IC110 and 111 to transfer these signals to the analog section of the 2701C which is fully floating.
- iii) These signals are resynchronized to the system clock by means of IC112 latching these signals. These devices also supply the required true and inverted versions for driving the switches.
- iv) These four lines directly drive the switching MOSFETs TR13 to 16 which act to provide two, variable duty cycle, waveforms switching from 0V to the reference voltage defined by IC7. IC11

buffers any switching transients caused by TR14 and 16 from the other pair of switches.

v) The outputs of these two stages are summed by R34 to 37, to provide the correct weighting such that the overall system appears as if it were one D-to-A convertor.

vi) The summed output of the two convertors is provided to R38 which forms part of an active filter with IC8 and associated circuitry.

10.3.6 Relay Drives

All relays in the 2701C are of the two coil latching type and are driven by the microprocessor by several of the outputs from IC108. Whenever a change in the state of the relays is required the microprocessor selects the required combination of outputs from IC108 and then selects to turn on TR113. This applies power to the required coil of each latching relay. After a delay of 20ms (approx.) the microprocessor will turn off TR113 thus allowing the relays to remain in the same state as commanded without the necessity of powering the relays continuously. The user should note that, due to this procedure, the coils of the relays are only driven for 20ms and only when a change in the state of the relays is required. The action of all of the relays in the 2701C is listed in 10.4.

10.3.7 Sense Feedback

This circuitry compares the actual output voltage (as present on the SENSE terminals) with the output of the D-to-A convertor and adjusts the output drive to maintain the correct voltage on these terminals. The main items in this circuitry are :

i) The amplifier IC5. This is a chopper stabilized amplifier powered from +/- 5V rails supplied by IC4 and 6. The output of this amplifier is provided to the output drive section to regulate the output voltage.

ii) Sense attenuator. This is comprised of R32, R41, R42 and R48. The configuration of these resistors is altered by the relays RLA, RLB and RLC to provide the various ranges of the 2701C (except the 200mV range).

Figure 10-2 shows a simplified diagram of the sense and output drive system.

10.3.8 Output Drive

As can be seen from Figure 10-2 the output drive is basically a transistor. In the 2701C this is implemented by a cascade set of transistors each stage being configured in the Darlington configuration. The main control transistor is formed by TR12 and 6 which are protected from over voltage by zener diode D3. The fuse FS1 provides overcurrent protection.

10.3.9 Current Drive

The 120mA range of option IT-2 is provided by the circuitry shown on sheet 4 of 2701-075. When this range is selected the voltage output section of the 2701C is configured to provide 0 to 2V which is applied to the input of the voltage to current convertor formed by IC301, TR301, TR302 and associated components. The fuse FS301 provides over current protection. The relays RLL and RLK provide polarity selection and mode selection respectively.

10.3.10 Power Supply

The power supply is in several sub-sections :

10.3.10.1 Microprocessor, Front Panel and IEEE Supplies

The microprocessor, front panel and IEEE interface circuitry is powered by a single 5V supply which is ground referenced. This supply is formed from an output of the "Low Voltage Transformer" (T202 on schematic 2701-075 sheet 3) by the rectifiers D212 and 213, the storage capacitor C212 and the 5V regulator IC201.

10.3.10.2 Floating Low Voltage Supplies

The analog circuitry in the 2701C is floating with respect to ground and is thus isolated from the ground referenced supply for the microprocessor etc.. The supplies for the Op-Amps in the 2701C are generated from an output winding of the "Low Voltage Transformer" T202 by the rectifier package D214, the storage capacitors C208 and 209, and 15V regulators IC202 and 203. The user should note that the Current Drive section of circuitry is driven from the un-regulated supplies.

10.3.10.3 High Voltage Supplies

The output drive section of the 2701C is powered by a variable 200 to 1400V supply (as indicated in Figure 10-2). This is generated by the "High Voltage Transformer" (T201) and associated circuitry. Referring to sheet 1 of schematic 2701-075, the part of IC1 whose output is on pin 1 is configured to compare the voltage across the transistor chain TR1 to 12 with 200V and to turn on the LED in IC2 if this voltage is high. The other half of IC1 is configured to force a short pulsed on condition of IC2 LED at each zero crossing of line. The output transistor in IC2 is turned on whenever the LED is on, and this turns off TR201 (and TR202), thus turning off the drive to the transformer T201. In the above manner this circuitry will maintain the output of the transformer T201 such that the voltage across the chain of transistors TR1 to 12 at approximately 200V independent of the actual output voltage. The

rectifier bridge formed by D206 to 209 and capacitors C203 to 206 form the rectification and storage of T201 output. As can be seen from the simplified schematic of 2701C (Figure 10-2) the decay of the high voltage supply requires some load current, this is achieved without a load by means of an additional supply formed by D210, D211, C211 and C214. This is a 500V supply which forces a "bleed" current from the high voltage supply. Whenever a faster decay is required (as sensed by the amplifier IC5) RLJ is energized, pulsing a higher bleed current from the high voltage supply.

10.4 Relay Selections

The user should note that all of the relays, except RLJ, in the 2701C are of the "latching" type. This type of relay does not require that the drive signal be present all of the time (for the ON condition) or not present (OFF condition) but has two coils, either one of which may be pulsed to force the selection of the required state. With the absent of power on either coil the relay will remain in the same state as it was in. The "states" of this type of relay are called RESET and SET.

The "truth tables" for the relays in the 2701C are given below, the RESET condition is indicated by a "R", the SET condition being indicated by a "S", if either condition may be found then this is indicated by a "X".

	200mV	2V	20V	120V	1200V	120mA
RLA	S	S	S	R	R	S
RLB	R	R	R	R	S	R
RLC	S	R	R	R	R	R
RLD	(1)	(1)	(1)	(1)	(1)	X
RLE(2)	(1)	(1)	(1)	(1)	(1)	X
RLF	S	R	R	R	R	S
RLG(2)	S	R	R	R	R	S
RLH	R	(3)	(3)	(3)	(3)	S
RLK	R	R	R	R	R	S
RLL	X	X	X	X	X	(4)

Notes :

(1) RLD and RLE are SET for positive voltage output, RESET for negative.

(2) RLD/RLE and RLF/RLG are driven in tandem (i.e. RLD and RLE are always in the same state as each other as are RLF and RLG).

(3) RLH is RESET for 2-wire, SET for 4-wire.

(4) RLL is SET for positive current output, RESET for negative.

10.5 Operation of Microprocessor Software

The user should note that these paragraphs contain supplemental information to enable the advanced user to fully understand how the 2701C operates. An understanding of these paragraphs is not required either for operation or maintenance of the 2701C. A full description is beyond the scope of this manual and is unnecessary for understanding the operation of the 2701C. However some knowledge of the method of operation of the software in the 2701C is of benefit, thus this section contains a brief description of the operating characteristics of the software in the 2701C. Throughout this section some knowledge of microprocessor programming is assumed.

The user should be aware of the following standard software organization features which are used in the 2701C:

- i) Power-up routine
To initialize all data areas, perform tests etc. required at power-up
- ii) Interrupt routines (also called "Real Time")
To perform actions requiring immediate response to hardware events.
- iii) An executive control loop
The loop which is normally being executed by the processor
- iv) Individual "action" routines
Called from the executive loop to action events or perform duties.

10.5.1 Power-on Reset Routine

After a power-on reset the uP performs the following tasks in the order given :

- i) Check RAM operation for stack area.
- ii) Initialize LEDs and displays
- iii) Initialize RAM volatile data
- iv) Check ROM and RAM operation and data contents
- v) Display greeting to user
- vi) Fetch and check calibration data
- vii) Initialize IEEE interface and parameters

The then starts to perform its "main executive" duties.

10.5.2 Main Executive Duties

This continuous loop is normally executed by the uP all of the time. The processor only leaves this loop temporarily to perform one of the other duties. The duties within this loop are as follows:

- i) Select required keyboard action level
- ii) If key pressed or switch moved: Perform action for key
- iii) If IEEE command received: Perform action for command
- iv) If delay just finished: Perform required action
- v) Repeat loop

10.5.3 Interrupt Routines

There are two sources of interrupt to the uP in the 2701C. These are :

i) Periodic Interrupt

This interrupt is generated by IC115 and occurs every 667uS (approx.). The uP uses this interrupt to multiplex the displays and also for timing functions.

ii) IEEE interface Interrupt

This interrupt is generated by the IEEE-488 interface circuitry whenever an event on the bus has occurred which requires activity by the 2701C. Examples of this are reception of a character, transmission of a character or reception of a command. This interrupt performs all of the required duties to complete the event and release the IEEE-488 bus. It informs the main executive when a complete character string has been received from the controller so that it may be actioned.

10.5.4 Individual "action" Routines

This is a numerous set of routines which control the activity required due to an event. Examples of these events are a manual key being pressed, an IEEE command line being received etc.. It is not necessary to explain the operation of these routines in this manual except to explain that they all perform the required task completely and then return to the previous action.

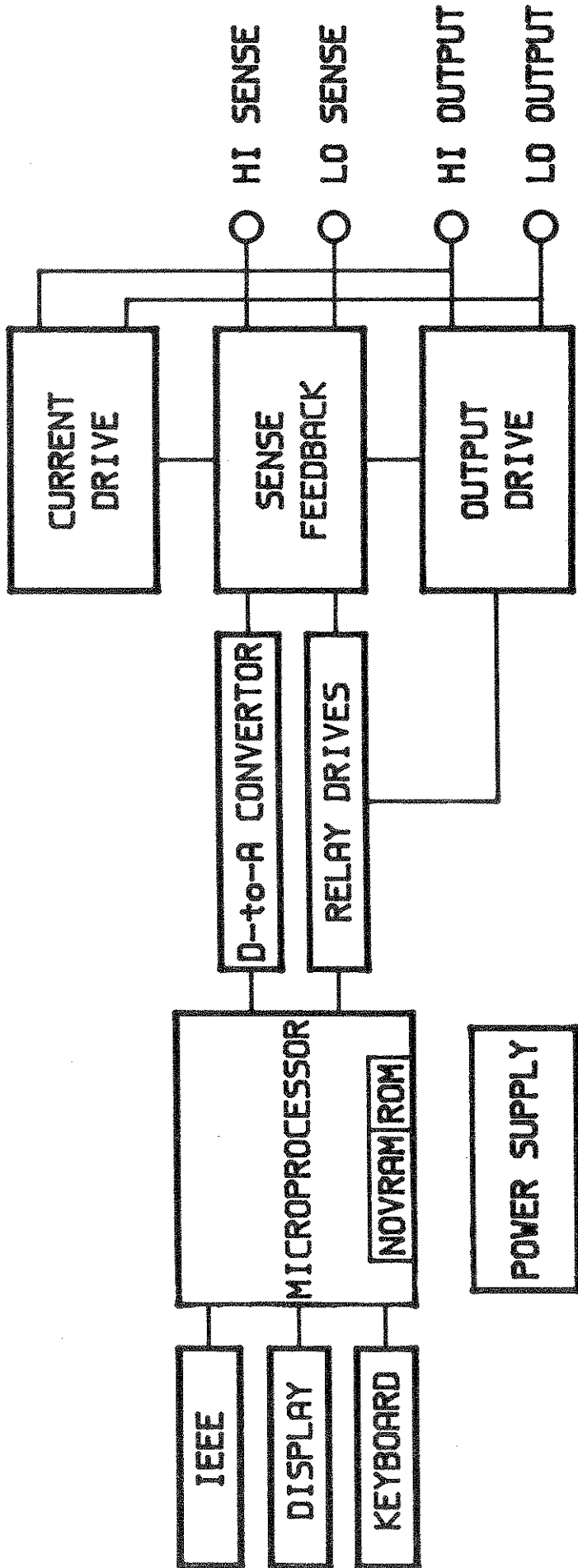

Figure 10-1
Block Diagram

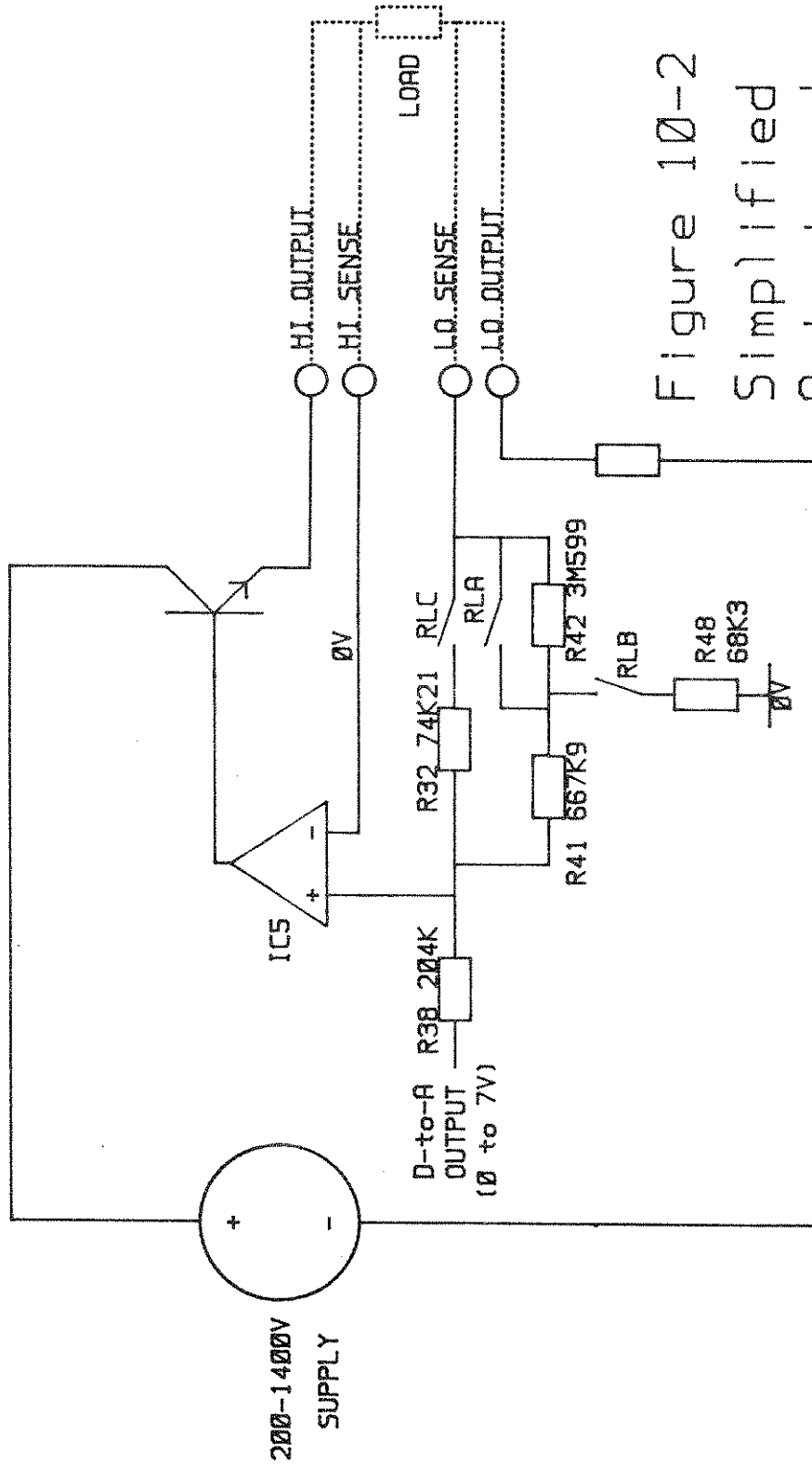

Figure 10-2
Simplified
Output and
Sense system

SECTION XI

PERFORMANCE VERIFICATION

11.1 General

Verification of the performance of the 2701C may be performed at any time, and is especially recommended following receipt of the unit or following transportation. Verification may be achieved with two levels as follows :

11.2 Verification of Operation

To verify that the 2701C is in operational condition, the following procedure should be followed. If any test fails then no further test should be performed and the 2701C should be set aside for maintenance.

- i) Ensure that the POWER switch (lower left hand corner of the front panel) of the 2701C is in the OFF position, i.e. no yellow dot showing.
- ii) Apply AC power to the 2701C (connector is in center of the rear panel).
- iii) Press the 2701C POWER switch to the ON position (yellow dot showing). The display on the front panel should illuminate with a greeting message ("HELLO" as standard).
- iv) Allow 2701C to warm up for 1 minute.
- v) With a known operational voltmeter having better than 0.1% accuracy check that the output at zero, positive full scale and negative full scale for each range on the 2701C is within 0.5%. Note that 2701Cs with option IT-2 will require the use of an ammeter as well as the voltmeter.

After successful completion of all the above steps the 2701C is fully operational with no faulty parts apparent.

11.3 Verification of Specification

Before attempting to prove that the 2701C is performing to specification the user must be aware of the following points:

- i) The specifications in section II are valid for reasonable use of the 2701C during the specified period of time. If the 2701C has been transported then it has probably been subjected to temperature shock and extremes. As with any precision equipment some change in calibration will occur due to this. This effect has been carefully monitored by Valhalla Scientific and has been found to be less than 15ppm even in extreme cases, however the user can expect some effect due to transportation.

ii) The specifications in section II are relative to the calibration standards at Valhalla Scientific (or, in some countries, the local Service Center for Valhalla products). The uncertainty of the Valhalla Scientific standards to NBS is 1.5ppm, thus this must be added to these specifications for verification purposes (if verification is attempted prior to calibration to the users standards). If the 2701C was locally calibrated then the uncertainty of those standards must be added instead.

iii) The above adder will obtain the uncertainty specification to National Standards. Thus, when a comparison is made, as it is here, the uncertainty of the users standards and equipment must also be added to the specifications. In cases where the 2701C was not locally calibrated and the National Standards differ from the NBS (i.e. U.S.A.) standards then this difference must also be accounted for.

iv) Prior to specification verification it is recommended that the user familiarizes himself with the manual operation of the 2701C and allows at least 24 hours (preferably 48 hours) for the unit to settle while powered.

If the 2701C is found to be fully operational but not performing to specification then contact your nearest Valhalla Scientific Service Center before returning the unit for repair or attempting repair yourself.

SECTION XII**USEFUL HINTS****12.1 Getting The Most Out of Your 2701C**

As with all precision instrumentation there are some general "caretaking" procedures that will help the user obtain even better performance than that specified. Most of the points listed below are good habits for any equipment, and if followed should also enhance all of the user equipments' performance and reliability at minimal cost.

i) Leave equipment powered at all times. This greatly reduces the drift and unreliability caused by temperature stresses during warm-up and cool-down.

ii) Avoid operating equipment in direct sunlight (e.g. through a window). Very high surface temperatures can be reached and the highly uneven temperature distribution will considerably affect the performance and reliability of the equipment.

iii) Avoid operating equipment directly under an air-conditioning outlet duct. This will cause similar affects as in ii) above. If there is significant air movement over the terminals then cover them and the cabling by a cloth cover (not synthetic - static will cause worse problems).

iv) Avoid other causes of temperature shock. If it is necessary to transport equipment then always ensure that it is well packed and thermally lagged. Also ensure that no rain or condensation can penetrate into the equipment.

v) Avoid static electricity. Discharges into the case or terminals of equipment can cause damage and will certainly cause noisy measurements to be made. Even a charged body (e.g. a person) which is moving can cause noise if impedance levels are significant, thus always sit or stand on a conductive surface and avoid movement whenever sensitive measurements are being made.

vi) Avoid high energy electro-magnetic fields. Although modern equipment is relatively insensitive to fields, they will produce errors. Always use shielded cabling wherever possible and always ensure that the shield is connected to a low impedance node.

vii) Always use the highest quality cables. Many "good looking" cables do not actually use pure copper for conductors and can cause many microvolts of thermal emfs. Also many banana jacks are actually made of steel or similar material and can cause several tens of microvolts of thermal emfs. If you are unsure then try reversing your connections and compare the measurements.

viii) Keep connectors and cables clean and free from grease. Corrosion can cause what was a perfectly good, high quality connector to become one that is worse than a "cheap" one. Surface grease will collect moisture and further grease, and also produce a significant leakage path. This can seriously affect high impedance and/or high accuracy measurements.

ix) Keep handling of terminations and cabling to a minimum. This reduces grease build up on these items (as in viii above) and also reduces the errors caused by thermal emfs.

x) Always try to "balance" cabling. Even with the highest quality cabling and terminals several microvolts of thermal emfs can occur if there is significant temperature difference. Thus always use the same gauge and type of wire to both terminations of sensitive measuring and generating devices (such as the 2701C) to reduce the temperature differential between conductors. Care in balancing the routing of cables (i.e. route the Hi and LO terminal connections close together) will also reduce thermals and pick up of interference.

xi) Do not "stack" equipment on top of each other. Most equipment require air flow around them and any restriction will decrease the performance, also the top instrument in a "pile" a several can be 10 or even 20 degrees hotter than the bottom one.

xii) Treat your equipment correctly and it will treat you correctly. Keep equipment clean, do not attempt any measurement that could yield damaging out of specification voltages or currents without protecting the instrumentation, and the equipment should perform well within specification for many years. Frequent breakdowns can be due to faulty equipment or design, but are more often caused by a lack of care and/or understanding of the product.

12.2 Dielectric Storage in Cabling

The effect of dielectric storage in cabling is often overlooked by many users but can have significant effects on the accuracy or repeatability of measurements. All cables have dielectric storage. Many people believe that there a relationship between dielectric storage and the published loss (also called dissipation factor) data for cables and capacitors. The answer is that there is and there is not! There are two major effects in dielectric storage:

- i) The initial stored quantity.
- AND
- ii) The time constant of the discharge.

Dielectric storage (or absorption as it is also called) can be simulated by placing a very small capacitance in series with a very large resistance in parallel with the actual capacitance of the cable (or capacitor). The initial stored quantity is dependent on

the value of the "very small capacitance" while the time constant is dependent on this and the "very high resistance". In practice most materials behave as if they had several of these capacitor-resistor combinations with widely varying values and time constants.

In practice the use of polyethylene insulated cables (never use PVC or Teflon) will help with this effect.

If the user is unsure, or just wishes to see the effect, then try the following test on a two-conductor cable. The user is warned that this can be a dangerous test to the user, extreme caution must be exercised.

i) Ensure that neither end of the cable has any connections and are not shorted.

ii) Connect one end of the cable across a 100V (approx.) DC source and leave for several minutes.

iii) Connect a 1 megohm resistor across the input terminals to a DVM with 1 μ V sensitivity and a reading rate of greater than 1 per second. Allow sufficient time for the reading to settle.

iv) Very carefully and quickly disconnect the cable from the 100V DC supply (do not set to zero or standby first) and connect instead to the DVM and 1Mohm. The user will see many microvolts (millivolts for bad cables) of reading which may take several minutes to decay.

If the user wishes, the DVM and 1Mohm (if high enough wattage) may be connected to the cable all of the time, in which case the dielectric storage of the DVM (as well as the cable) will be measured.

The effect of this is most visible in resistance measurements, particularly at higher values (above 10Kohm), but is also very noticeable when performing measurements of standard cells or the outputs of voltage dividers. In both of these cases the impedance levels are quite high and very long settling times can result if "bad" cabling is used. With the 2701C, the effect can be easily seen if the cable on the terminals is of "bad" material, the output has been at 1000V for some time and then a divided output (100mV for instance) is selected. There will appear to be a relatively large error at the 100mV level which will slowly disappear (it will look like thermal emfs). This is caused by the dielectric storage "leakage" discharging into the 450 ohm output impedance of the divider. It is recommended that if this sequence of events is to take place then the user should change the cable after subjecting it to 1000V and leave it to discharge for several minutes before using it again.

