



***Modification Information (MOD)***

***For***

***TKR-750/850 Version2***  
***TKR-751/851***

<i>Version:</i>	<i>1.02 USA</i>
<i>Last Updated:</i>	<i>Sep, 2005</i>
<i>Language:</i>	<i>English</i>
<i>Type:</i>	<i>K</i>



## About Copyright

All copyrights and other intellectual property rights for this technical document and relevant in-depth manuals as well as the software described in this technical document, relevant in-depth manuals, and help texts and manuals attached to the software are owned by Kenwood Corporation.

A right to use the software described in this technical document and relevant in-depth manuals is granted to a licensee by Kenwood Corporation; however, the title to and ownership of the software shall be owned by Kenwood Corporation. Refer to the help texts attached to this software for details.

Kenwood Corporation does not warrant quality and performance of the software described in this technical document and relevant in-depth manuals to conform to the applicability of any use, and Kenwood Corporation shall be free from liability for any defects, damage or loss, or from any warranty to anything other than expressly described in this technical document and relevant in-depth manuals.

## Revision history

Date	Description
Sep. 2005	Add Terminal description
Sep. 2005	K-USA R&D modify

<b>1</b>	<b>TERMINAL FUNCTION .....</b>	<b>1</b>
1.1	8-pin Connector .....	1
1.2	15-pin Connector .....	2
1.3	25-pin Connector (D-SUB).....	3
1.4	14-pin Connector (CN601).....	4
<b>2</b>	<b>MODIFICATION OF THE ANTENNA .....</b>	<b>5</b>
<b>3</b>	<b>INSTALLING THE VOICE SCRAMBLER BOARD .....</b>	<b>7</b>
3.1	Configuring and Modifying the SC20-460 Board .....	7
3.2	Installing the SC20-460.....	9
3.3	Configuration with the Software .....	10
<b>4</b>	<b>MODIFYING THE DC POWER .....</b>	<b>12</b>
<b>5</b>	<b>EXTRACTING RSSI SIGNAL FROM THE ACC 25-PIN D-SUB CONNECTOR .....</b>	<b>13</b>



This section describes Input/Output terminals of the TKR-750/850/751/851.

can write the configuration data into the TKR-750/850/751/851 by connecting it to the PC with the KPG-91D.

## 1.1 8-pin Connector

The 8-pin connector is located on the front panel of the TKR-750/850/751/851. It can use as the microphone connector for a base station usage and maintenance. You

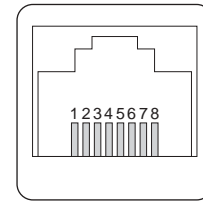

Figure 1-1 8-pin connector

Table 1-1 Assigning signals to 8-pin connector

No.	Pin name	Input/Output	Description
1	NC	---	No connection
2	SB	Output	Switched Battery Power Output/10.8 - 15.6 V/ 200m A max.,
3	GND		Ground
4	PTT	Output	PTT signal Input/ H=more than 4.0V/ L=less than 1.0V/Active L
	TXD1	Output	PC serial data from radio (COM 1)/ CMOS level/ H=more than 4.0V/ L=less than 1.0V FPU read, PC Tuning, Firmware Programing
5	MIG	---	Microphone Ground
6	MIC	Input	Microphone Signal Input/ 60% STD@5.0+/-2mV 1kHz input/ 600ohm Road/ 10uF AC coupled/ 300-3kHz +6dB/Oct. (EIA curve)
7	HOOK	Input	Hook Signal Input/ H=more than 4.0V/ L=less than 1.0V/ 5V pull up/ Active L
	RXD1	Input	PC serial data to radio (COM 1)/ CMOS level/ H=more than 4.0V/ L=less than 1.0V FPU read, PC Tuning, Firmware Programing
8	NC	---	No connection

## 1 TERMINAL FUNCTION

## 1.2 15-pin Connector

The 15-pin connector is located on the rear panel of the TKR-750/850/751/851 and you can connect external devices, such as an external speaker.

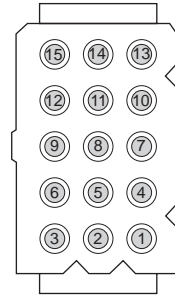

Figure 1-2 15-pin connector

Table 1-2 Assigning signals to 15-pin connector

No.	Pin name	Input/Output	Description
1	SB	Output	Output the voltage between 10.8 to 15.6 V: 1 A max.
2	SB	Output	Output the voltage between 10.8 to 15.6 V: 1 A max.
3	NC	---	No connection
4	GND	---	Ground
5	GND	---	Ground
6	SPG	---	Speaker ground
7	RD	Output	Received Data output/ 1kohm Road, 10uF AC coupling, 80mVrms@1kHz 60% Dev.
8	RSSI	Output	RSSI output; 0.2 to 2.5V
9	SPI	Input	Internal Speaker input (short with SPO)
10	Auxiliary Output 1	Output	Open Collector Output; 16V /150 mA max.
11	Auxiliary Output 2	Output	Open Collector Output; 16V /150 mA max.
12	SPO	Output	External Speaker output; 4 W @less than 5% distortion/ 4ohm Road
13	Auxiliary Output 3	Output	CMOS Level Output/ H=more than 4V/ L=less than 1V/ 0.2mAmax/ 5V pull-up
14	Auxiliary Output 4	Output	CMOS Level Output/ H=more than 4V/ L=less than 1V/ 0.2mAmax/ 5V pull-up
15	Auxiliary Output 5	Output	CMOS Level Output/ H=more than 4V/ L=less than 1V/ 0.2mAmax/ 5V pull-up

### ■ Connecting the external speaker

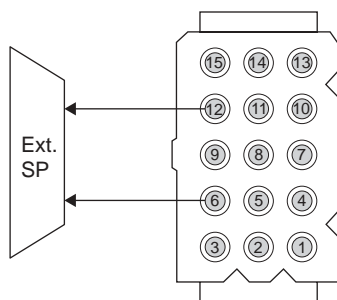

Figure 1-3 Connecting the external speaker

Disconnect the Jumper Lead and insert the external speaker's cable to the 12-pin and 6-pin of the 15-pin connector. It needs to reconnect the Jumper Lead when using the internal speaker.

### 1.3 25-pin Connector (D-SUB)

The 25-pin connector is located on the rear panel of the TKR-750/850/751/851 and you can connect external devices, such as a trunking controller.

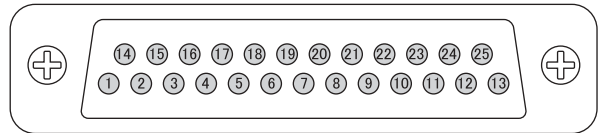

Figure 1-4 25-pin connector (D-SUB)

Table 1-3 Assigning signals to 25-pin connector

No.	Pin name	Input/Output	Description
1	NC	---	No connection (RSSI output after modification; 0.2 to 2.5V)
2	RXD2	Input	PC serial data input (COM 2); TTL/RS-232C level H=more than +2.4V/ L=less than +0.4V/ 5ohm Road/ for FPU read, PC Tuning
3	TXD2	Output	PC serial data output (COM 2); TTL/RS-232C level H=more than +5V/ L=less than -5.0V/ for FPU write, PC Tuning
4	AUXI 1	Input	H=more than 4.0V/ L= less than 1.0V/ 5V pull-up
5	AUXI 2	Input	H=more than 4.0V/ L= less than 1.0V/ 5V pull-up
6	AUXI 3	Input	H=more than 4.0V/ L= less than 1.0V/ 5V pull-up
7	DG	---	Control line Ground (TXD/RXD/AUX, etc.)
8	TD	Input	Transmission Data input; Deviation=15% STD@0.5Vpp 100Hz (Adjustable) 600ohm Road, 50uF AC coupled, Non Pre-emphasis (+1/-3dB@0-10kHz)
9	TA	Input	Transmitted Audio signal input; Deviation=60% STD@280mVrms 1kHz (Adjustable) 600ohm Road, 1uF AC coupled 300-3kHz +6dB/Oct. (EIA curve)@TA line pre emphasis off=Enable 300-3kHz +/-3dB@TA line pre emphasis off=Disable
10	RD	Output	Received Data output; 80mVrms@1kHz STD/ 1kohm Road/ 10uF AC coupled/ Response +/-2.5dB@0 - 5kHz/ Non-squelched
11	RA	Output	Received audio signal output; 400mVrms@1kHz STD/ 1kohm Road/ 1uF AC coupled/ Response -6dB/oct@300-3kHz/ Squelched
12	RXG	---	Ground for RA/RD
13	SPM	Input	Speaker Mute input; H=more than 4.0V/ L=less than 1.0V/ 5V pull-up/ Active L
14	NC	---	No connection
15	EMON	Input	External Monitor Switch input; H=more than 4.0V/ L=less than 1.0V/ 5V pull-up/ Active L
16	EPTT	Input	External PTT Switch input; H=more than 4.0V/ L=less than 1.0V/ 5V pull-up/ Active L
17	SC	Output	Squelch Control output; H=more than 4.0V/ L=less than 1.0V/ 5V pull-up/ L=Busy
18	NC	---	No connection
19	TXG	---	Ground for TA/TD
20	AUXIO 1	Input/Output	CMOS Level Input/Output; H=more than 4.0V/ L=less than 1.0V/ 5V pull-up/ 0.2mA max
21	AUXIO 2	Input/Output	CMOS Level Input/Output; H=more than 4.0V/ L=less than 1.0V/ 5V pull-up/ 0.2mA max
22	AUXIO 3	Input/Output	CMOS Level Input/Output; H=more than 4.0V/ L=less than 1.0V/ 5V pull-up/ 0.2mA max
23	AUXIO 4	Input/Output	CMOS Level Input/Output; H=more than 4.0V/ L=less than 1.0V/ 5V pull-up/ 0.2mA max
24	AUXIO 5	Input/Output	CMOS Level Input/Output; H=more than 4.0V/ L=less than 1.0V/ 5V pull-up/ 0.2mA max
25	AUXIO 6	Input/Output	CMOS Level Input/Output; H=more than 4.0V/ L=less than 1.0V/ 5V pull-up/ 0.2mA max

**Note:** Refer to the "Function Reference" for functions that you can assign to the Auxiliary Input/Output terminal.

## 1.4 14-pin Connector (CN601)

The 14-pin connector for installing an additional Voice Scrambler board is located in the internal board of the TKR-750/850/751/851, and it can be connected cables of Voice Scrambler board (SC20-460/480, etc.). (Refer to [3.2 Installing the SC20-460.](#))

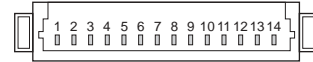

Figure 1-5 14-pin connector (CN601) for installing additional Voice Scrambler

Table 1-4 Assigning signals to 14-pin connector

No.	Pin name	Input/Output	Description
1	TXO	Output	Mic signal output
2	TXI	Input	Mic signal input
3	RXO	Output	Received audio signal output
4	AC	Output	Audio control signal output
5	BC1	Output	Scramble code signal output 1
6	BC2	Output	Scramble code signal output 2
7	BC3	Output	Scramble code signal output 3
8	BC4	Output	Scramble code signal output 4
9	PTI	Input	PTT signal input
10	CLRC	Input	Scramble code Clear signal input
11	RXI	Input	Received audio signal input
12	PTO	Output	PTT signal output
13	8C	Output	The repeater outputs 8 V interlocking with the power.
14	GND	Output	Ground

# 2 MODIFICATION OF THE ANTENNA [ManualsPlus.com](http://ManualsPlus.com)

This section describes how to modify the antenna to connect it to the antenna connector for transmission and reception located on the TKR-750/850/751/851. It allows to use as one antenna base by sharing an external antenna connector for both transmitting and receiving.



## WARNING

You must turn the power OFF before antenna modification.

Follow the procedures below to modify the antenna.

1. Remove the rear side top panel.  
Remove 6 screws (N33-3006-45, 3 mm diameter, black) and pull the panel up.
2. Move location of C92 and C160 on the Final unit (B/2) for TK750/751.

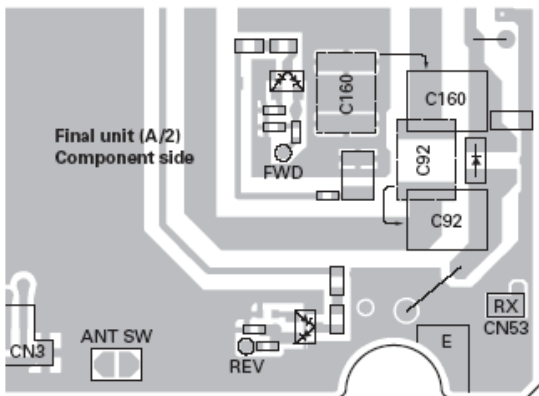

Move location of C81 and C160 on the Final unit (B/2) for TK850/851.

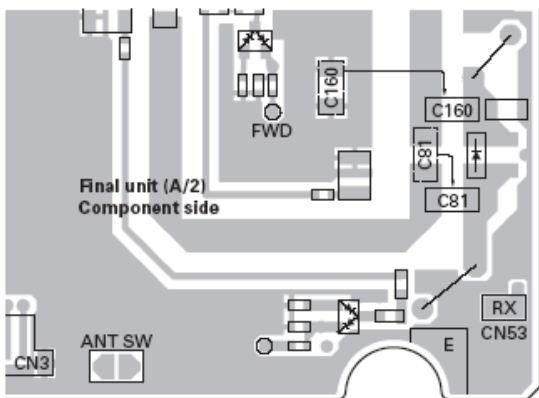

3. Remove the front side top panel.  
Remove 6 screws (N33-3006-45, 3 mm diameter, black) and pull the panel up.
4. Remove the antenna cable.
  - 4-1. Remove the receive cable from the CN18 of the TX-RX unit (A/2).

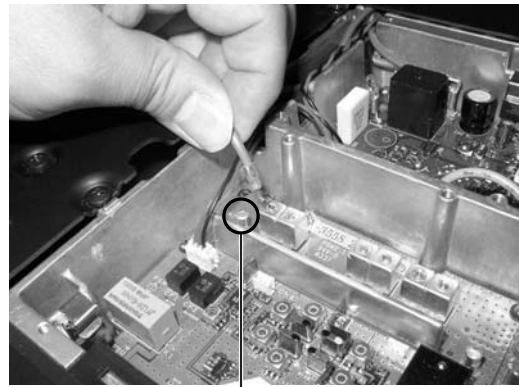

CN18

- 4-2. Remove 2 screws (N33-2606-46, 2.6 mm diameter, gold) on the BNC connector fixed to the rear panel and pull the ANTENNA CABLE backward.

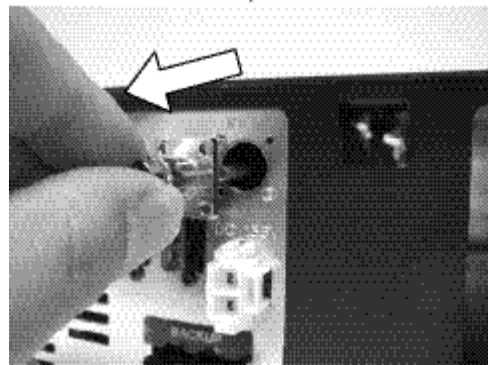

5. Cut the coaxial cable of the ANTENNA CABLE at the BNC connector side and remove the insulated part to perform soldering on the board.

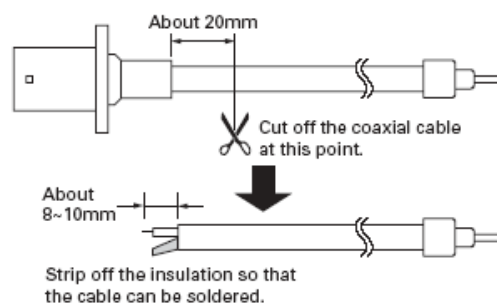

6. Connect the ANTENNA CABLE to the board.
  - 6-1. Solder the cut surface of the coaxial cable center pin to "RX" and the shield of cable to "E".

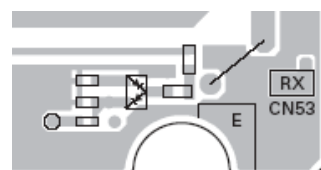

**6-2.** Connect the pin connector side of cable to the CN18 of the TX-RX unit (A/2).

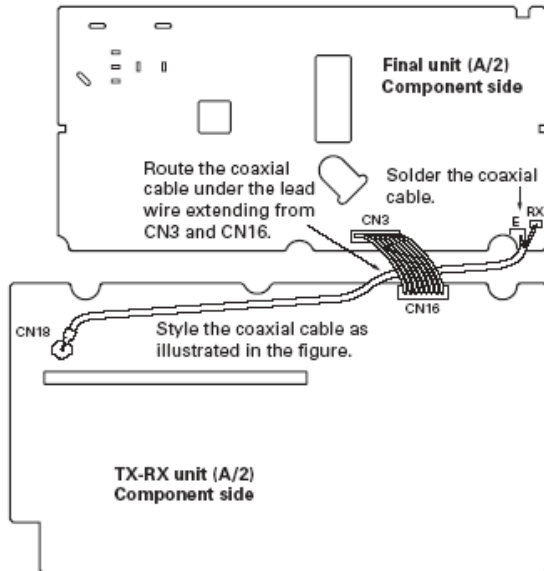

**7.** Short the "ANT SW" pads located next CN3 by solder.

**8.** Reassemble the top panels after modifying the antenna cable.

**Note:**

- ◆ You must configure the operation mode of the channel as **Simplex**. Refer to the "Field Programming Reference" for details.
- ◆ To install the base radio on the location where the strong radio interference may exist such as mountain top remote base system, we recommend you coupling the external antenna switching relay. You can prevent the degradation of the reception performance caused by the internal antenna switch diode.

**Order Number: KSG-90/00-50 TX/RX Relay kit**

Ask KENWOOD System for detailed information about this product.



# 3 INSTALLING THE VOICE SCRAMBLER BOARD

It can install an optional Voice Scrambler board into the TKR-750/850/751/851. This section describes how to install the TRANSCRIPT SC20-460 in it. You can use the KENWOOD service part (E37-0808-05) when installing the SC20-460 board.

## ■ Requirement Items

- TKR-750/850/751/851
- SC20-460
- KENWOOD Part (E37-0808-05)
- Cushion Tape

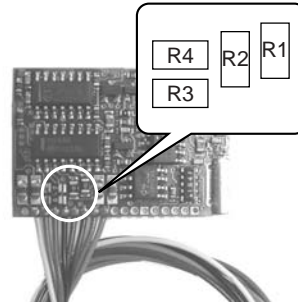

### Note:

- ◆ The required modification must be performed to avoid problems, such as too small audio signals from the speaker, or too loud synchronizing noise.
- ◆ Refer to the Voice Scrambler board's instruction manual for details.

4. Disconnect the cable connected to the SC20-460 board.

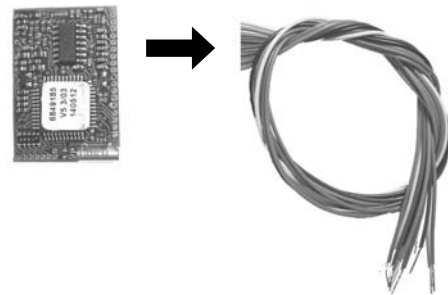

## 3.1 Configuring and Modifying the SC20-460 Board

1. Modify the SC20-460 board and change the RX Audio Input method.

TKR-750/850/751/851 output a received audio after De-emphasizing to input into the option board. Therefore, it might be necessary to modify the voice scrambler board.

(Confirm your SC20-460 is enabled de-emphasis.)

- 1-1. Cut the foil between E52 and E53.
- 1-2. Solder the position between E51 and E52 to connect them.
- 1-3. Solder the position between E53 and E54.

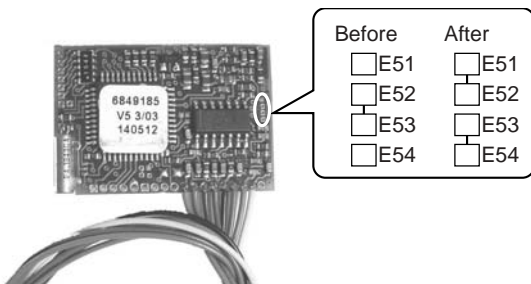

3. Change the constant in conjunction with the TX/RX Audio level.

- 3-1. Replace R1 with 100 kΩ and R3 with 100 kΩ in conjunction with the RX Audio level.
- 3-2. Replace the R2 with 6.8 kΩ and R4 with 6.8 kΩ in conjunction with the TX Audio level.

Before modification	After modification
R1, R3: 100 kΩ	R1, R3: 100 kΩ (No modification)
R2, R4: 100 kΩ	R2, R4: 6.8 kΩ

5. Solder the KENWOOD service parts (E37-0808-05) cables to the SC20-460 board. You must connect the part as shown in the as shown below. (Refer to 1.4 14-pin Connector (CN601).)

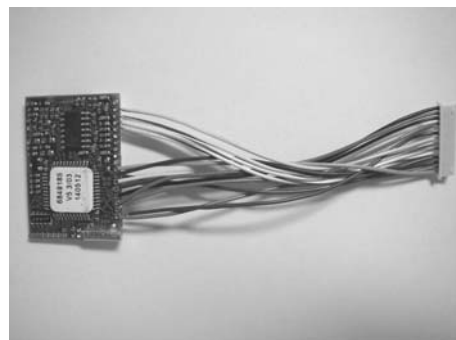
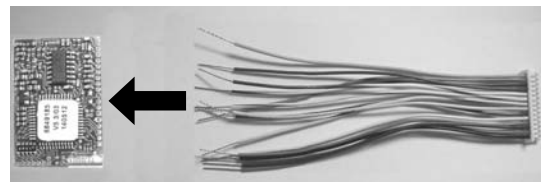

3 INSTALLING THE VOICE SCRAMBLER BOARD

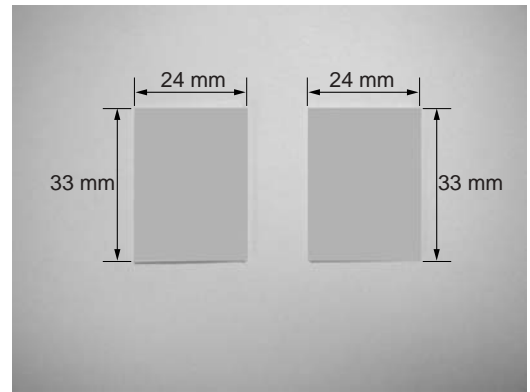
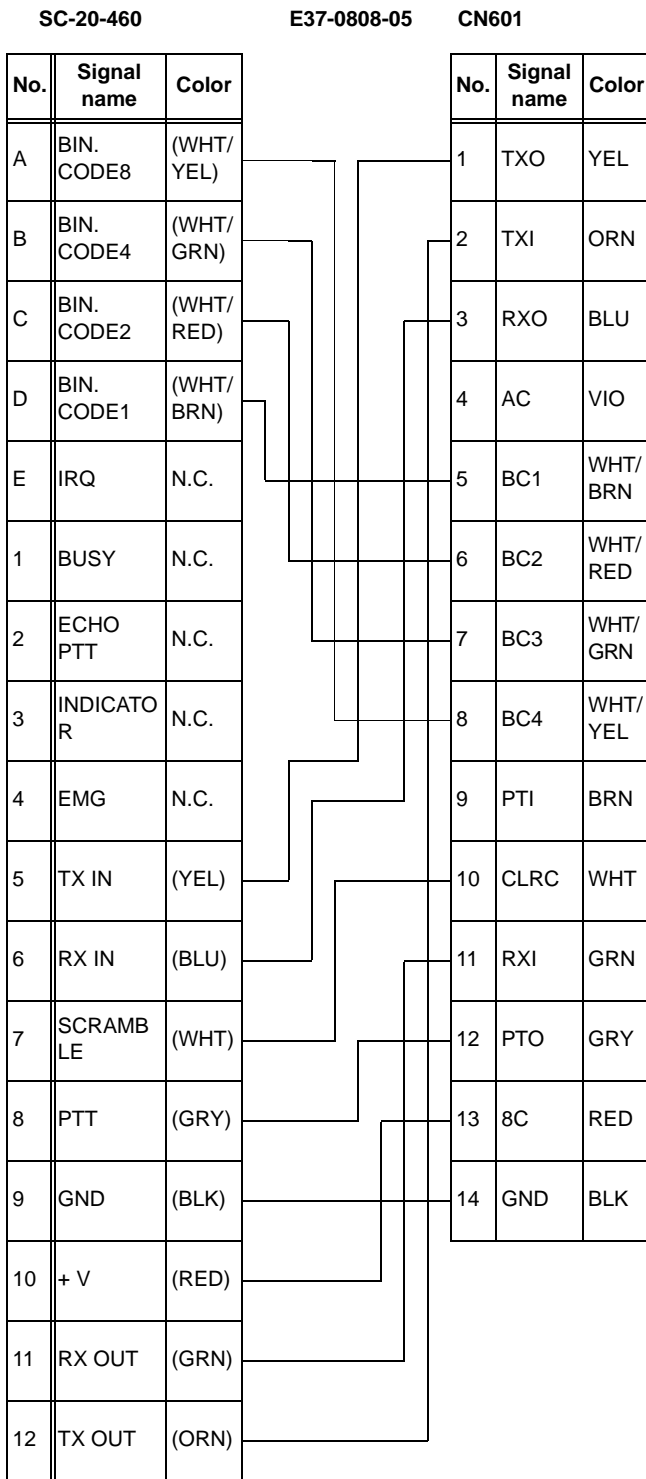

**Note:**

- ◆ The 3M cushion tape having a double-sided adhesive tape has following thickness.

No. 4016 (or No. 4416): 1.6 mm (1/16 inch)  
 No. 4008 (or No. 4408): 3.2 mm (1/8 inch)

- ◆ The above sizes are reference values. You must cut the cushion tape into the same size as the Voice Scrambler.

7. Stick the cushion tapes both side of the SC20-460.

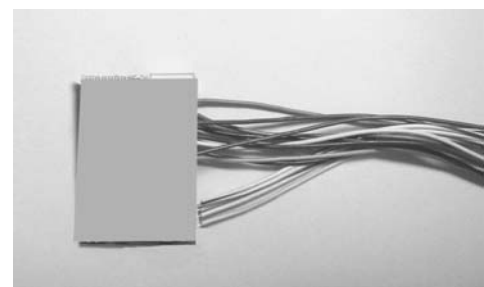
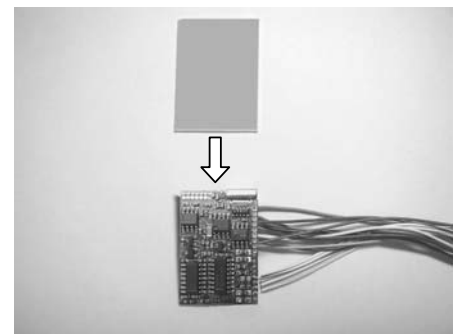

**Figure 3-1 Connecting the SC-20-460**

**Note:** The KENWOOD service parts (E37-0808-05) have a connector allowing you connect it to CN-601 of the TKR-750/850/751/851.

6. Prepare the cushion having a double-sided adhesive tape. In this case, the cushion tape (No. 4008, No. 4016) manufactured by 3M can be used.

Cut the cushion tape in the same size as the SC20-460 (24 mm x 33 mm).

### 3 INSTALLING THE VOICE SCRAMBLER BOARD

#### 3.2 Installing the SC20-460

Follow the procedures below to install the board into the TKR-750/850/751/851.

1. Remove the front side top panel of the TKR-750/850/751/851.

Remove 6 screws (N33-3006-45, 3 mm diameter, black) and pull it up.

2. Remove the FRONT PANEL of the TKR-750/850/751/851.

Remove 6 screws (N33-4008-45, 4 mm diameter, black) and pull the FRONT PANEL forward.

3. Remove the FRONT PANEL of the main unit.

**3-1.** Unhook 4 hooks located on the top and bottom of the FRONT PANEL and pull it forward.

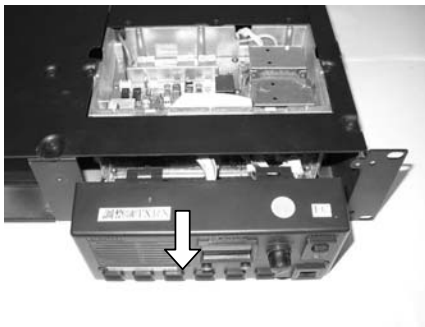
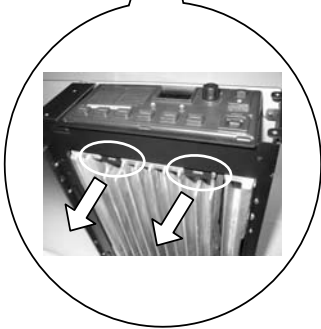
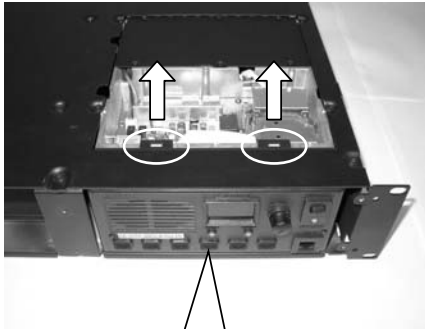

- 3-2.** Remove two connectors (CN600, CN613).

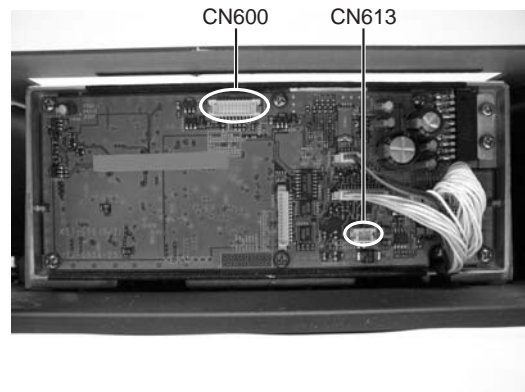

You must be careful when removing the FRONT PANEL since the panel is connected to the main unit board with the cable.

4. Remove R742 and R653.

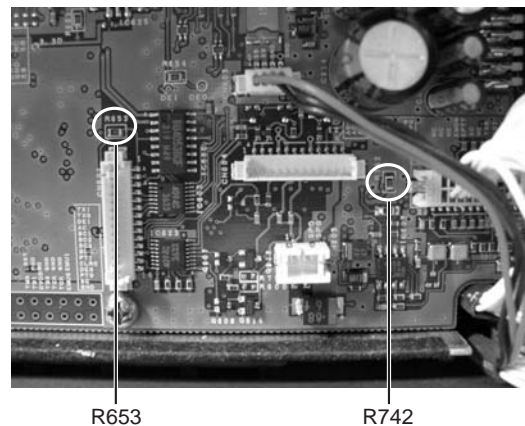

5. Install the SC20-460 board.

**5-1.** Connect the connector on the SC20-460 board to the connector (CN601) on the PCB (TX-RX unit B/2).

### 3 INSTALLING THE VOICE SCRAMBLER BOARD

## 3.3 Configuration with the Software

You can write the Voice Scrambler information to the repeater using the KPG-91D after installing the board. Follow the procedures below to write the Voice Scrambler data to the repeater.

1. Install the KPG-91D in the PC and start the program. The Main window of the KPG-91D appears.

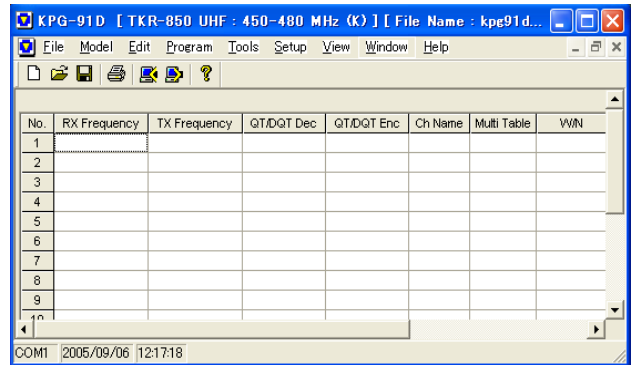

Figure 3-2 KPG-91D Main window

**Note:** Refer to the "Field Programming Reference" for how to connect the TKR-750/850/751/851 to the PC and install and start the KPG-91D.

2. Select "Program" > "Read Data from Repeater". Click the icon on the Toolbar. The "Read Data from Repeater" window appears.

3. Click "Read". You can read the configuration data from the TKR-750/850/751/851 with the KPG-46 programming cable by using the KPG-91D.

4. Select "Model" > "Model Information". The "Model Information" window appears.

5. Select "Voice Scrambler" from the "Option Board" dropdown list and click "OK".

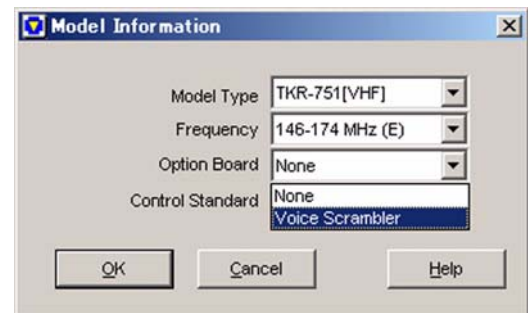
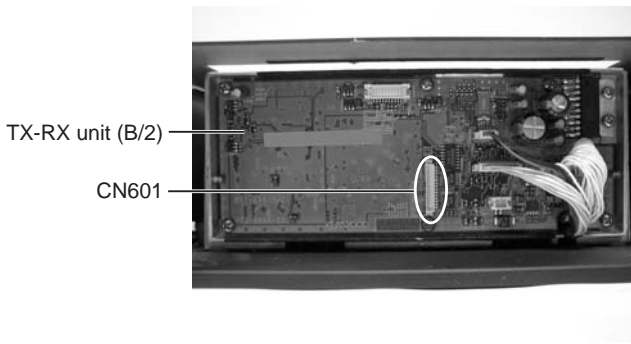
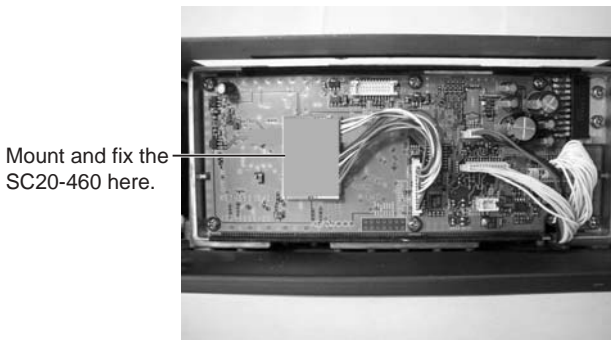

Figure 3-3 Model Information



5-2. Peel off the cover of the tape on the rear surface of the SC20-460 board and install the board to the following location.



6. Reassemble the repeater after installing the SC20-460 board.

**Note:** In case of test the operation of the TKR in PC Test Mode and adjust the maximum deviation after installing the Voice Scrambler board, the audio signal emitted from the local microphone is not modulated. In this case, you must remove the 12-pin cable connected to the CN601 connector of the TX-RX unit (B/2) and perform soldering on the land of the Display Unit. (Refer to the figure below.)

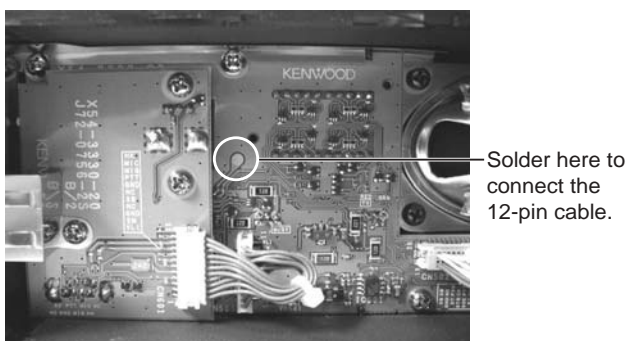
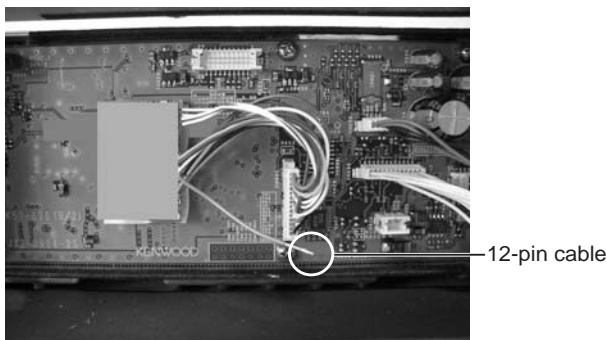

### 3 INSTALLING THE VOICE SCRAMBLER BOARD

- Configure the “Scrambler Setting” to be enable and select scrambler code for each channel.

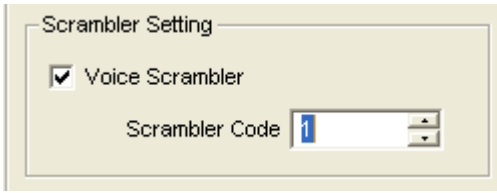

**Figure 3-4 Channel Information**

Refer to the “FPRG 6.2.17 Voice Scrambler” for details.

- Assign the “Scrambler On/Off” function to a function key in the “Key Assignment” menu, if needed.

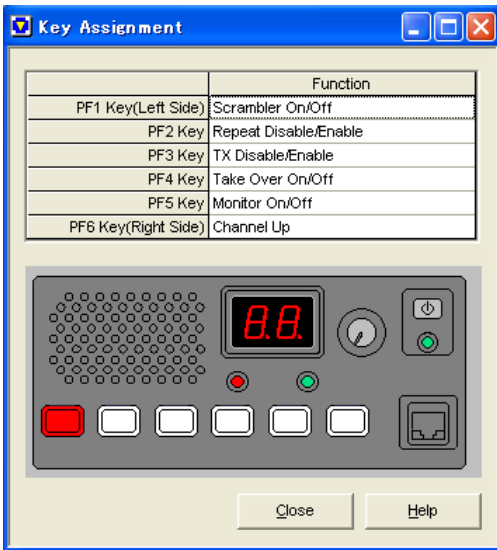

**Figure 3-5 Key Assignment**

Refer to the “FPRG 6.5 Key Assignment window” for how to configure the function.

- Or assign function port to scrambler on, off or on/off.

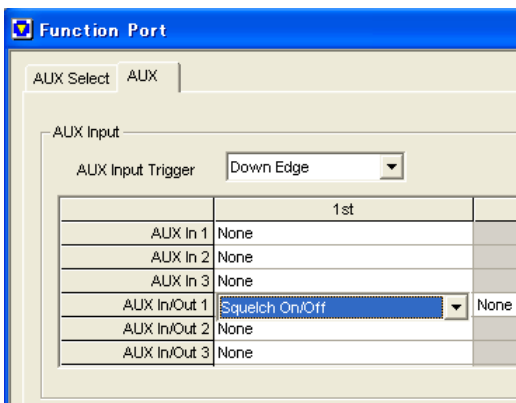

**Figure 3-6 Function Port**

- Select “Program” > “Write Data to Repeater” or click the icon on the Toolbar.

The “Write Data to Repeater” window appears.

It is possible to modify the DC power to prevent the TKR-750/858/751/851 is turned ON with the erroneous operation of the power switch. With this modification, the DC power is always turned ON regardless of the power switch operation.

Follow the procedures below to modify the DC power.



**WARNING**

It must turn the power OFF before DC power modification.

1. Remove the front side top panel.  
Remove 6 screws (N33-3006-45, 3 mm diameter, black) and pull the TX-RX PANEL up.
2. Solder the PSW part located on the left side of the TX-RX unit (A/2) to make a soldering bridge.

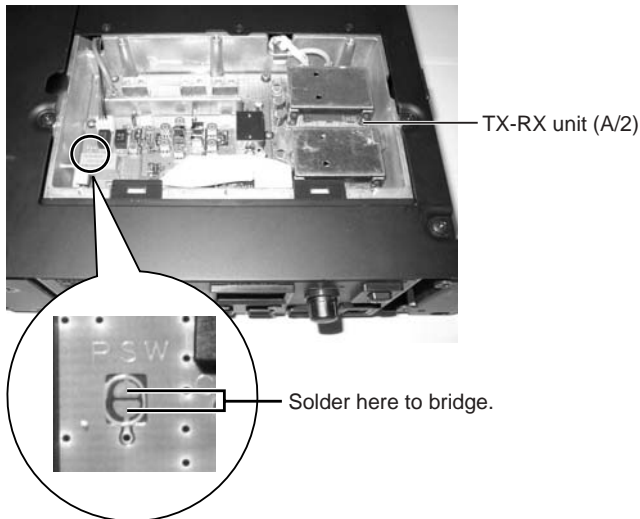

3. Reassemble the repeater after modifying the DC power.

