

Printed in the Federal
Republic of Germany

1050.9008.60

CMD60

Tester for DECT

Digital Radiocommunication

Operating Manual

Test and
Measurement Division

ROHDE & SCHWARZ



1	Preparation for Use	Tabbed Divider 1
2	Manual Operation	Tabbed Divider 2
	Getting Started	
	Description of the Menus (Reference Description)	
3	Remote Control	Tabbed Divider 3
4	Maintenance	Tabbed Divider 4
5	Testing the Rated Specifications	Tabbed Divider 5
	Annex A (Interfaces)	Tabbed Divider 6
	Annex B (List of Error Messages)	Tabbed Divider 7
	Annex C (List of Commands)	Tabbed Divider 8
	Annex D (Program Example)	Tabbed Divider 9
	Index	Tabbed Divider 10

Data Sheet

Safety Instructions
 Certificate of quality
 EC Certificate of Conformity
 List of R & S Representatives

Safety Instructions

This unit has been designed and tested in accordance with the EC Certificate of Conformity and has left the manufacturer's plant in a condition fully complying with safety standards.

To maintain this condition and to ensure safe operation, the user must observe all instructions and warnings given in this operating manual.

1. The unit may be used only in the operating conditions and positions specified by the manufacturer. Unless otherwise agreed, the following applies to R&S products:

Pollution severity 2, overvoltage category 2, IP degree of protection 2X, altitude max. 2000 m. The unit may be operated only from supply networks fused with max. 16 A.

2. For measurements in circuits with voltages $V_{ms} > 30$ V, suitable measures should be taken to avoid any hazards.

(using, for example, appropriate measuring equipment, fusing, current limiting, electrical separation, insulation).

3. If the unit is to be permanently wired, the PE terminal of the unit must first be connected to the PE conductor on site before any other connections are made (installation and cabling of the unit to be performed only by qualified technical personnel).

4. For permanently installed units without built-in fuses, circuit breakers or similar protective devices, the supply circuit must be fused such as to provide suitable protection for the users and equipment.

5. Prior to switching on the unit, it must be ensured that the nominal voltage set on the unit matches the nominal voltage of the AC supply network. If a different voltage is to be set, the power fuse of the unit may have to be changed accordingly.

6. Units of protection class I with disconnectible AC supply cable and appliance connector may be operated only from a power socket with earthing contact and with the PE conductor connected.

7. Any additional safety instructions given in this manual are also to be observed.

8. If the unit has no power switch for disconnection from the AC supply, the plug of the connecting cable is regarded as the disconnecting device. In such cases it must be ensured that the power plug is easily reachable and accessible at all times (length of connecting cable approx. 2 m). Functional or electronic switches are not suitable for providing disconnection from the AC supply.

9. If units without power switches are integrated in racks or systems, a disconnecting device must be provided at system level.

10. Applicable local or national safety regulations and rules for the prevention of accidents must be observed in all work performed.

Prior to performing any work on the unit or opening the unit, the latter must be disconnected from the supply network. Any adjustments, replacements of parts, maintenance or repair may be carried out only by authorized R&S technical personnel.

Only original parts may be used for replacing parts relevant to safety (eg power switches, power transformers, fuses). A safety test must be performed after each replacement of parts relevant to safety.

(visual inspection, PE conductor test, insulation-resistance, leakage-current measurement, functional test).

Safety-related symbols used on equipment and documentation from R&S:

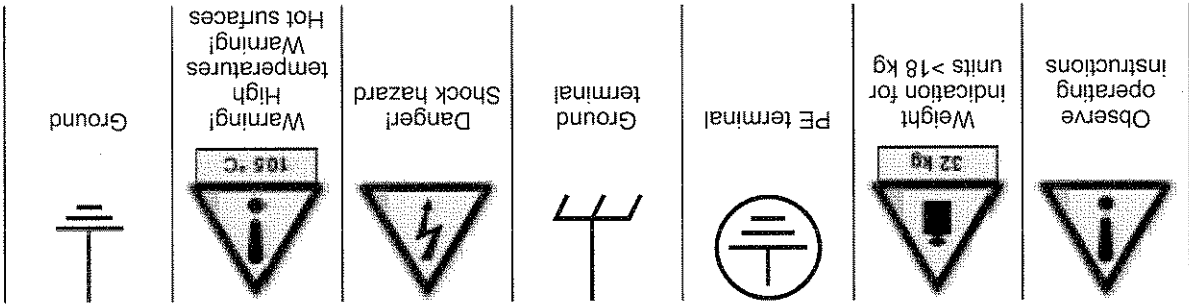

Munich, 1999-01-12
 Central Quality Management FS-QZ / Becker
ROHDE & SCHWARZ GmbH & Co. KG
 Mühldorfstr. 15, D-81671 München

Affixing the EC conformity mark as from 1995

- EN61010-1 : 1993 + A2 : 1995
- EN50081-1 : 1992
- EN50082-1 : 1992

Conformity is proven by compliance with the following standards:

- relating to electromagnetic compatibility (89/336/EEC revised by 91/263/EEC, 92/31/EEC, 93/68/EEC)
- relating to electrical equipment for use within defined voltage limits (73/23/EEC revised by 93/68/EEC)

complies with the provisions of the Directive of the Council of the European Union on the approximation of the laws of the Member States

Equipment type	Order No.	Designation
CMD60	1050.9008.60	Dig. Radiocommunication Tester

This is to certify that:

Certificate No.: 9502035



Contents

- 1 Preparation for Use 1.1
- 1.1 Explanation of Front-panel and Rear-panel Views 1.1
- 1.2 Putting into Operation 1.6
 - 1.2.1 Setting up the Instrument 1.6
 - 1.2.2 Mounting in a 19" Rack 1.6
 - 1.2.3 Connecting the Instrument to the AC Supply 1.6
 - 1.2.4 How to ensure EMC 1.7
 - 1.2.5 Switching on the Instrument 1.7
 - 1.2.6 Power Fuses 1.7
 - 1.2.7 Operation 1.8

The next pages show the front and rear views of the instrument, each with brief explanations of the controls and connectors.

1.1 Explanation of Front-panel and Rear-panel Views

- Take the instrument out of the shipping box and check whether the items listed are all included.
- Carefully check the instrument for mechanical damage. Should the instrument be damaged, immediately notify the forwarder which shipped the instrument to you. Therefore make sure to keep the box and packing material.
- For further transport or shipment of the instrument, the original packing should also be used. It is urgently recommended to use the protective caps included in the shipping box for protection of the front and rear panel. This serves to prevent damage e.g. to the controls on the front panel.

1 Preparation for Use

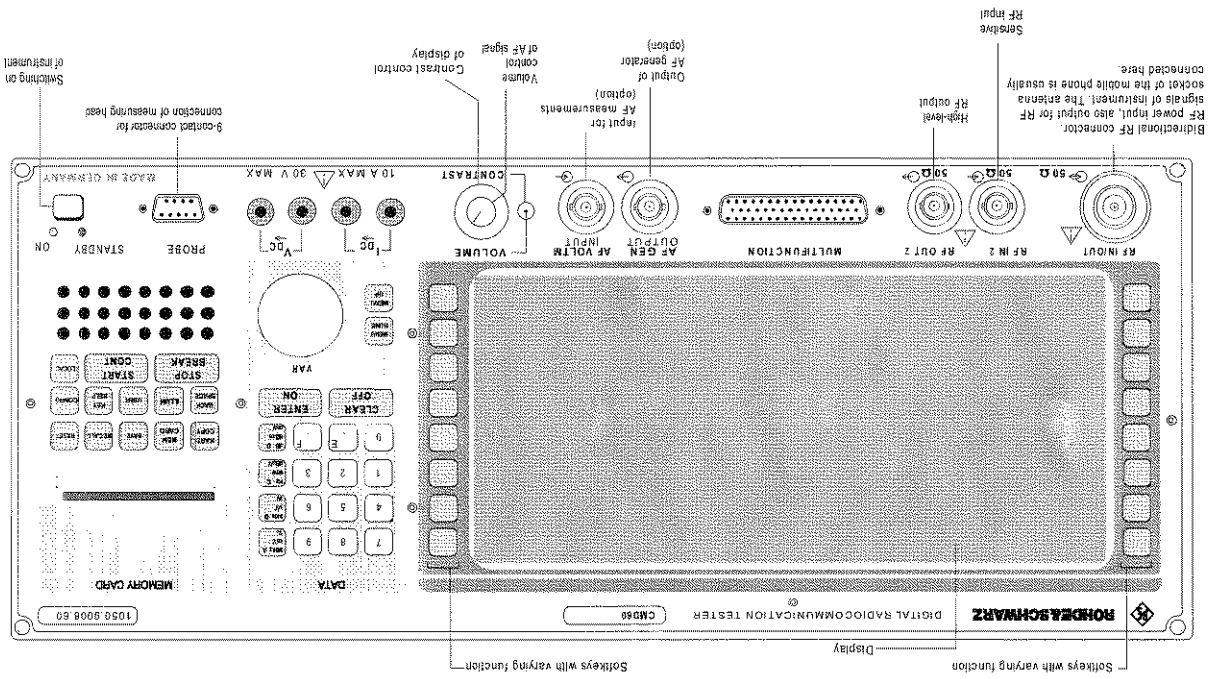

Explanation of Front-panel View

1050,9008,60

1.4

E-4

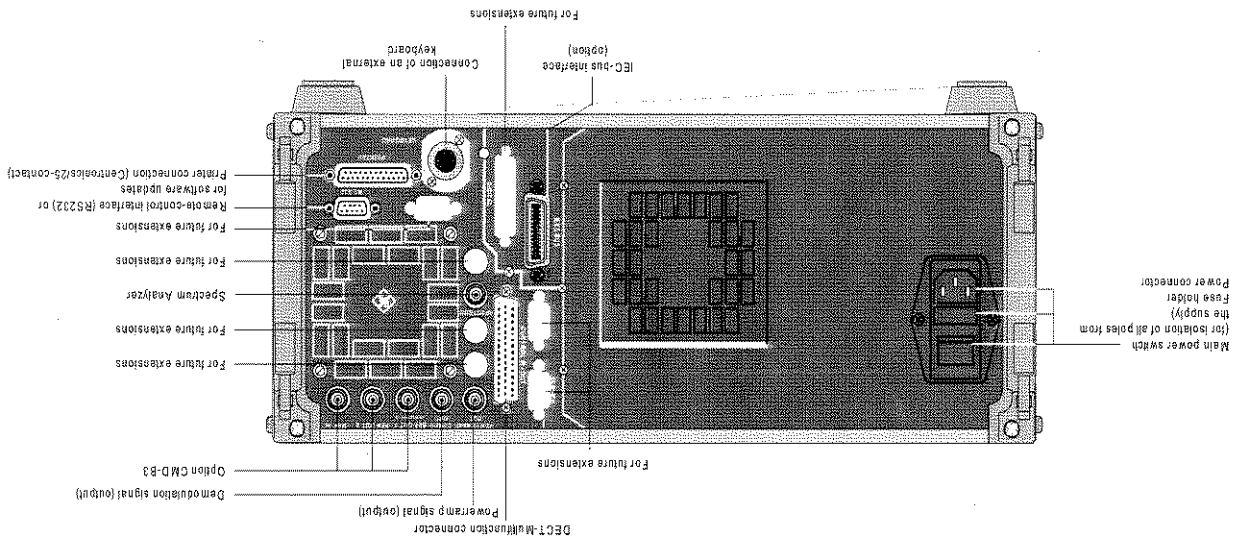

Explanation of Rear-panel View

CMD60

Pin	Signal name	Direction	Type	Description
1	TPP1	O	D	ADPCM1 signal
2	+5V	O	A	+5V for external use, max. 15mA
3	CLK1	O	D	ADPCM1 signal
4	RPE1	O	D	ADPCM1 signal
5	REFOUT3	O	D	see section 2.5.4.2
6	TP12_IN	I	D	ADPCM2 signal, not supported
7	TP1_IN	I	D	ADPCM1 signal
8	RP12_IN	I	D	ADPCM2 signal, not supported
9	RP1_IN	I	D	ADPCM1 signal
10	PO2_OUT	O	D	ADPCM2 signal, not supported
11	PO1_OUT	O	D	ADPCM1 signal
12	/NRM/PCM_OUT	O	D	BMC signal, not supported
13	FS2_OUT	O	D	BMC signal, not supported
14	FS1_IO	I/O	D	BMC signal, not supported
15	DO_OUT	O	D	BMC signal, not supported
16	DL_IN	I	D	BMC signal, not supported
17	DCK_IO	I/O	D	BMC signal, not supported
18	12/32/SLOT_OUT	O	D	BMC signal, not supported
19	R_DATA_IN	I	D	RX data via switch to BMC, not supported
20	T_DATA_IN	I	D	External modulation (TTL) of RF generator, see section 2.4.4.4
21	/PWRINT/	O	D	indicates RX power by negative edge
22	CLK100_OUT	O	D	100Hz frame signal of BMC, 1:FP>PP, 0:PP>FP
23	T_DATA_OUT	O	D	the data stream sent by BMC
24	SYNC_LO_IO	I/O	D	DECT time synchronization signal, master: Out, see S.2.5.4.2
25	SYNC_HI_IO	I/O	D	DECT time synchronization signal, master: Out, see S.2.5.4.2
26	MAS/SLV/OUT	O	D	CMD60 mode: master: Hi, slave: Low, see section 2.5.4.2
27	TXD	O	D	reserved
28	RXD	I	D	reserved
29	VG2	I	A	ADPCM2 analog ground, not supported
30	GND		A	
31	MIC2MINUS	I	A	ADPCM2 signal, not supported
32	MIC2PLUS	I	A	ADPCM2 signal, not supported
33	GND		A	
34	RE2MINUS	O	A	ADPCM2 signal, not supported
35	RE2PLUS	O	A	ADPCM2 signal, not supported
36	GND		A	
37	BZ2MINUS	O	A	ADPCM2 signal, not supported
38	BZ2PLUS	O	A	ADPCM2 signal, not supported
39	EXTRRG	I	D	Trigger input, see section 2.4.4
40	RF_T_PWR_RMP	O	D	indicates the TX power ramp
41	VG1	I	A	ADPCM1 analog ground
42	GND		A	
43	MIC1MINUS	I	A	ADPCM1 microphone input, see section 2.4.5
44	MIC1PLUS	I	A	ADPCM1 microphone input, see section 2.4.5
45	GND		A	
46	RE1MINUS	O	A	ADPCM1 headphones, see section 2.4.5
47	RE1PLUS	O	A	ADPCM1 headphones, see section 2.4.5
48	GND		A	
49	BZ1MINUS	O	A	ADPCM1 buzzer
50	BZ1PLUS	O	A	ADPCM1 buzzer

Pin assignment of 50-pin CONTROL IN/OUT connector

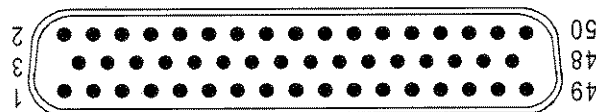

A number of different numbering conventions exists for this type of connector.

Note:

CMD60 Pin Assignment of 50-pin CONTROL IN/OUT Connector

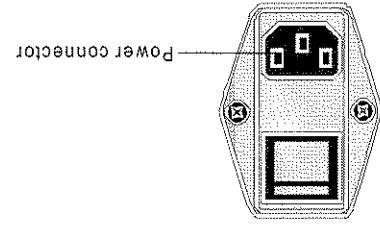

➤ Plug the supplied power cable into the rear power connector and connect the CMD to the current supply.

The CMD is equipped with an AC voltage detection, i.e. it is automatically set to the respective AC supply voltage. (Range: AC voltage 90 to 132 V and 180 to 265 V; 47 to 440 Hz).

1.2.3 Connecting the Instrument to the AC Supply



As the power switch is situated at the rear of the instrument, an all-pole mains disconnection must be near at hand for safety reasons when the instrument is mounted in a rack!

Using the rack adapter ZZA-94 (order number 396.4905.00) the instrument can be mounted in 19" racks according to the mounting instructions supplied.

1.2.2 Mounting in a 19" Rack

- Do not cover the ventilation openings!
- Ambient temperature 0 to 45 °C.
- Avoid moisture condensation. If it however occurs, the instrument must be wiped dry before switching on.
- Note the warm-up time of the temperature-controlled OCXO reference oscillator (option).



For convenient operation of the instrument note the following:

For bench measurements, it is recommended to fold out the feet at the bottom of the instrument.

1.2.1 Setting up the Instrument

1.2 Putting into Operation

1.2.4 How to ensure EMC

In order to avoid electromagnetic interference, the instrument may only be operated in the closed state and with all shielding covers. Only appropriate shielded signal and control cables may be used.

1.2.5 Switching on the Instrument

As soon as the main power switch at the rear of the instrument is in the OFF position, the complete instrument is disconnected from the power supply. If it is set to the ON position, the instrument is in standby mode or in operation, depending on the position of the power switch at the front of the instrument.

Standby position:

Only the reference frequency oscillator is supplied with operating voltage and the yellow LED (STANDBY) is illuminated.

ON position:

The green LED (ON) is illuminated, all modules of the instrument are supplied with operating voltage.

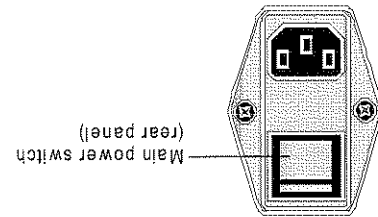

1.2.6 Power Fuses

The CMD is equipped with two fuses complying with the label of the power supply. The fuses are located in the extendable fuse holder, which is inserted between power connector and main power switch.

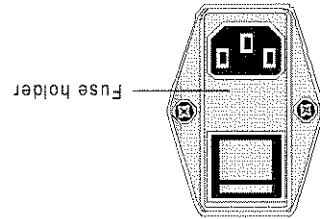

1.2.7 Operation

When the DUT has been connected to the front panel for measurement, make sure that the rear connector for the spectrum analyzer is terminated by 50 Ω , either using the supplied 50- Ω terminator or a 50- Ω spectrum analyzer or signal generator. An open connector will lead to false results of the level measurement. Termination of the front-panel sockets not used is not required.

Contents

2	Manual Operation	2.1
2.1	Getting Started	2.1
2.1.1	Connection of CMD60	2.2
2.1.2	Synchronization and Call Setup to Fixed Part (FP)	2.4
2.1.2.1	Synchronization and Call Setup to FP in the GAP Mode	2.6
2.1.3	Synchronization and Call Setup to Portable Part (PP)	2.8
2.1.3.1	Synchronization and Call Setup to PP in the GAP Mode	2.10
2.1.4	DECT Transmitter Measurements on Portable Parts and Fixed Parts	2.12
2.1.5	DECT Receiver Measurements on Portable Parts and Fixed Parts	2.16
2.2	Menu Structure	2.18
2.3	Basic Operating Instructions and Storage of Parameters	2.20
2.4	Description of Operating Menus	2.26
2.4.1	Main Menu	2.26
2.4.2	Manual Test	2.27
2.4.2.1	Menu SIGNALLING PP-TEST	2.27
2.4.2.2	Menu SIGNALLING PP TEST in the GAP mode	2.30
2.4.2.3	Menu SIGNALLING FP-TEST	2.32
2.4.2.4	Menu SIGNALLING FP TEST in the GAP mode	2.35
2.4.3	DECT Measurements	2.38
2.4.3.1	Menu CONNECTION ESTABLISHED	2.38
2.4.3.2	Menu POWER RAMP	2.40
2.4.3.3	Menu RF MODULATION	2.42
2.4.3.4	Menu TIMING	2.45
2.4.3.5	Menu BIT ERROR RATE	2.46
2.4.4	Module Test	2.48
2.4.4.1	Menu BURST ANALYSIS	2.48
2.4.4.2	Menu POWER VERSUS TIME	2.50
2.4.4.3	Menu RF - MODULATION	2.51
2.4.4.4	Menu RF SIGNAL GENERATOR	2.53
2.4.5	Additional Measurements (Option CMD-B41)	2.56
2.4.5.1	Menu ADDITIONAL MEASUREMENTS	2.56
2.4.5.2	Menu MULTITONE AUDIO ANALYSIS	2.58

2.5	Description of Configuration Menus	2.61
2.5.1	Configuration Main Menu	2.61
2.5.2	Signalling Menus	2.63
2.5.2.1	Menu SIGNALLING PP-TEST CONFIGURATION	2.63
2.5.2.2	Menu SIGNALLING FP-TEST CONFIGURATION	2.66
2.5.2.3	Menu SIGNALLING PP-TEST CONFIGURATION HELP	2.67
2.5.3	Configuration Menus for Measurements	2.70
2.5.3.1	Menu TX TEST CONFIGURATION	2.70
2.5.3.2	Menu POWER RAMP CONFIGURATION	2.70
2.5.3.3	Menu RF-MODULATION CONFIGURATION	2.72
2.5.3.4	Menu TIMING CONFIGURATION	2.74
2.5.3.5	Menu BIT ERROR RATE CONFIGURATION	2.75
2.5.4	General Configuration Menus	2.77
2.5.4.1	Menu RF CONNECTOR/EXTERNAL ATTENUATION	2.77
2.5.4.2	Menu SYNCHRONIZATION	2.78
2.5.4.3	Menu PRINTER	2.80
2.5.4.4	Menu REPORT	2.83
2.5.4.5	Menu SOFTWARE OPTIONS	2.84
2.5.4.6	Menu HARDWARE OPTIONS	2.84
2.5.4.7	Menu OTHER CONFIGURATION PARAMETERS	2.85
2.5.5	Configuration Menus for Additional Measurements	2.86
2.5.5.1	Menu ADDITIONAL MEASUREMENTS CONFIGURATION	2.86
2.5.5.2	Menu AF METER CONFIGURATION	2.87
2.5.5.3	Menu DISTORTION METER CONFIGURATION	2.88
2.5.5.4	Menu AF GENERATOR CONFIGURATION	2.89
2.5.5.5	Menu MULTITONE AUDIO ANALYSIS CONFIGURATION	2.90
2.6	Autotest	2.92
2.6.1	Menu AUTO TEST	2.92
2.6.2	Menu AUTO TEST EDIT	2.93
2.6.3	Menu SIGNALLING PP-TEST CONFIGURATION	2.95
2.6.4	Menu SIGNALLING FP-TEST CONFIGURATION	2.99
2.6.5	Menu POWER RAMP CONFIGURATION	2.101
2.6.6	Menu RF MODULATION CONFIGURATION	2.103
2.6.7	Menu TIMING CONFIGURATION	2.105
2.6.8	Menu BIT ERROR RATE CONFIGURATION	2.106
2.6.9	Menu CONDITIONAL GOTO CONFIGURATION	2.108
2.6.10	Menu AUTO TEST Active	2.109
2.6.11	Menu AUTO TEST End	2.109
2.6.12	Menu DISPLAY RESULTS	2.110
2.6.13	Menu AUTO TEST COPY	2.111

2 Manual Operation

The DECT Digital Radiocommunication Tester CMD60 is easy and convenient to operate despite the wide variety of test functions it offers.

If you are working with the CMD60 for the first time and wish to get familiarized quickly with DECT measurements, you should start with section 2.1. In this section, you will be guided through a complete test of a fixed part (DECT base station) and a portable part (DECT handset).

Section 2.4 describes all manual control functions. Starting from the main menu, all menus are described completely in a logical order.

2.1 Getting Started

Section 2.1 is mainly intended for users that work with the CMD60 for the first time. First it is described how to connect a DUT (device under test) and then guides the user step by step through the most important DECT tests (synchronization, call setup, etc).

To get acquainted quickly with the CMD60 and its wide variety of measurement functions, we recommend that you work with the CMD60 together with a DECT fixed part (FP) or a DECT portable part (PP) while going through section 2.1. If an FP is used, you can skip subsection 2.1.3, if a PP is used, you can skip subsection 2.1.2. If both a DECT PP and FP are to be tested, it is expedient to start with the FP.

For each step, additional information is given on the opposite page (eg under ①). The contents and layout of this section are practice-oriented. It provides important information not only on the CMD60 but also on the DECT system.

For further information on menus and keys please refer to section 2.2.

2.1.1 Connection of CMD60

Step 1

Plug power cable into power socket on the rear and connect CMD60 to AC supply ①. Switch on CMD60 with main power switch on the rear ②.

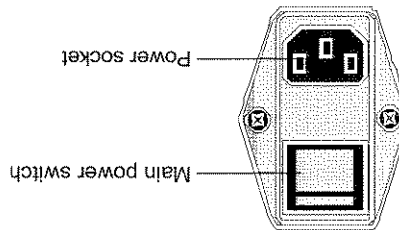

Step 2

Connect N socket RF IN/OUT of CMD60 with antenna connector of FP or FP. Alternatively, an antenna can be connected to the N socket for coupling via the air interface ③.

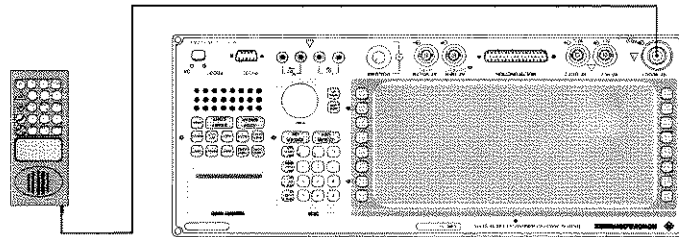

Step 3

Switch on CMD60 with power switch on the front ④. Select the contrast for the display ⑤.

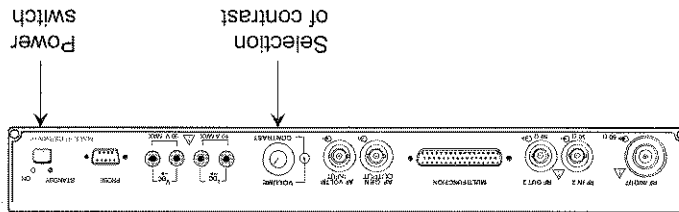

The following mask will appear on CMD60.

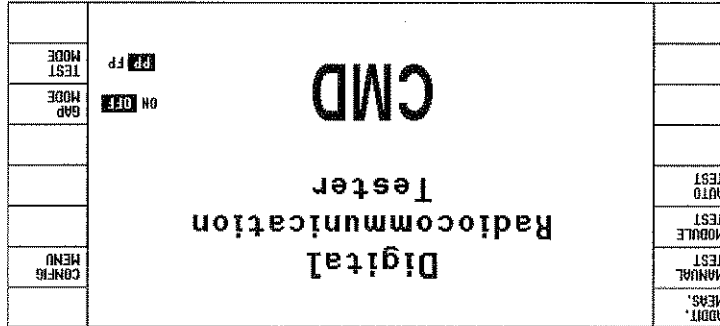

Additional Information

Step 1

① **Connection to AC supply**
The CMD60 automatically detects and adapts itself to the available AC supply (voltage ranges: 90 to 132 VAC and 180 to 265 VAC, 47 to 440 Hz).

② **Main power switch on rear of unit**
If the main power switch on the rear of the unit is set to OFF, the complete unit is disconnected from the AC supply. If the main power switch is set to ON, the unit is in the standby mode or in operation, depending on the position of the power switch on the front of the unit. With the power switch in position ON, the optional OCXO reference oscillator is supplied with operating voltage.

Step 2

③ **RF connection**
Normally, no direct RF connection is provided for DECT PPs and FPs. For coupling via the air interface, an antenna suitable for the DECT band is to be used (1900 MHz). For an accurate measurement of the NTP (normal transmitted power) and the BER (bit error rate) it is important to know the coupling attenuation.

Step 3

④ **Power switch on front of unit**
With the power switch on the front, the unit can be set to standby or to operation.

Standby:
Only the optional OCXO reference oscillator is supplied with operating voltage. The yellow LED (STANDBY) lights.

Operation:
All modules of the unit are supplied with operating voltage. The green LED (ON) lights.

⑤ **Contrast**
The contrast of the display can be set with the rotary knob CONTRAST on the front of the unit. The setting depends on the viewing angle of the user relative to the unit and may have to be readjusted from time to time.

2.1.2 Synchronization and Call Setup to Fixed Part (FP)

Step 1

Press softkey TEST MODE until "FP" is displayed in inverse video, which indicates that the mode is active. Press the GAP MODE softkey until OFF is displayed in inverse video, ie until the GAP mode is deactivated. Press softkey MANUAL TEST. CMD60 changes to menu SIGNALING FP-TEST and searches for a dummy bearer signal ①.

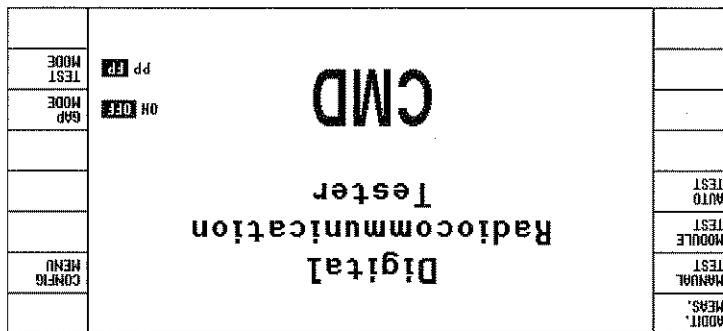

Step 2

Switch on the FP and set it to the DECT test mode ②.

When CMD60 has found the dummy bearer signal of the FP under test, this is indicated by LOCKED in the field "Signalling Status". In addition, information on the channel number and time on the dummy bearer and slot ③ of the dummy bearer and RF LEVEL ④ of the FP are on the RFP1 ⑤ of the FP are indicated.

If softkey ACCEPT RFP1 is pressed, CMD60 uses the same RFP1 as the FP. Some FPs additionally require a specific PMID ⑥.

Press softkey RF LEVEL, enter -40 and confirm with ENTER, or turn spinwheel until -40 dBm is indicated.

Step 3

Now a call can be set up by pressing softkey SETUP CONNECTION. After a successful call setup ⑦, CMD60 is in the status CONNECTION ESTABLISHED (see section 2.1.4).

MODE	LOOPBACK NORMAL ECHO	Press key to setup connection	SETUP CONNECT.
SET RFP1 FOR PP	Detected RFP1: 0000418320		RF LEVEL
ACCEPT RFP1	Dummy Carrier: 1		TRAFFIC CARRIER
	Dummy Slot: 0		TRAFFIC SLOT
	Signalling Status: LOCKED		PMID
CONNECT/EXT. ANT.	USED RF CONNECTOR: RF IN/OUT		RFP1
	Ext. Attenuation: 0.0 dB		
ADPT. MEAS.	SIGNALING FP-TEST		

Additional Information

Step 1

① **Dummy bearer**
The dummy bearer is a signal sent by the FP to which PPs (and also CMD60 if used as a PP) can synchronize. The signal is transmitted at the DECT clock of 10 ms and contains information for synchronization between FP and PP and for authentication, ie for verification if a call setup is permissible between a specific pair of FP and PP (or FP and CMD60 if the latter is used as a PP).

Step 2

② **DECT test mode**
For tests on DECT systems, the FP must be set to a special test mode for a successful call setup. In this mode, the FP accepts test messages it otherwise ignores. The procedure for activating the test mode varies from unit to unit. In the case of some FPs, the paging button must be kept pressed for a specified period of time during switch-on, other FPs require a special test software to be loaded via an interface. Relevant information is to be obtained from the manufacturer in each case.

③ **Slot**
Please note that the slot numbers of the dummy bearer and of the traffic bearer (permissible values are 0 to 11 for both) are not identical. Moreover, adjacent slots (eg 5 and 6 or 11 and 0) are permissible only if the channel numbers of the dummy bearer and the traffic bearer are identical. Some FPs can set up a call only on even-numbered slots, others only on odd-numbered slots. If required, the value for TRAFFIC SLOT is to be changed.

④ **RFP1**
The "Radio Fixed Part Identity" is a number that unambiguously identifies a fixed part. A call setup between a PP and an FP is possible only if the RFP1 stored in the PP coincides with that of the FP.

⑤ **PMID**
The "Portable Part MAC Identity" is an identification number of the portable part. Most FPs accept any PMID in the DECT test mode. The PMID of a PP can be determined during call setup by means of the PP test (see section 2.1.4 - Step 1).

Step 3

⑥ **Call setup**
The requirements for a successful call setup are described in section 2.4.2.3.

2.1.2.1 Synchronization and Call Setup to FP in the GAP Mode

Step 1

Press the TEST MODE softkey until FP is displayed in inverse video which indicates that the mode is active. Press the GAP MODE softkey until ON is displayed in inverse video and the GAP mode is active. Press the MANUAL TEST softkey. This opens the SIGNALING FP-TEST menu where CMD60 searches for a dummy bearer signal ①.

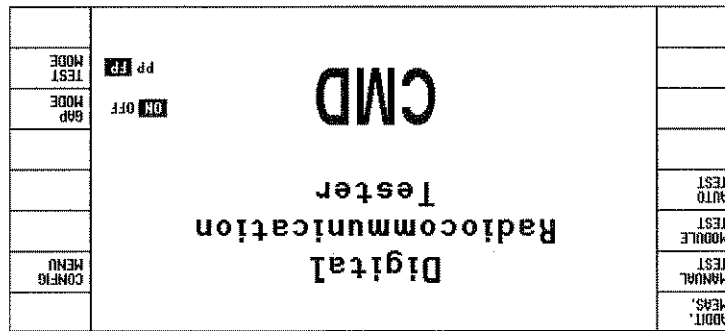

Step 2

Switch on the FP without activating the DECT test mode. ②

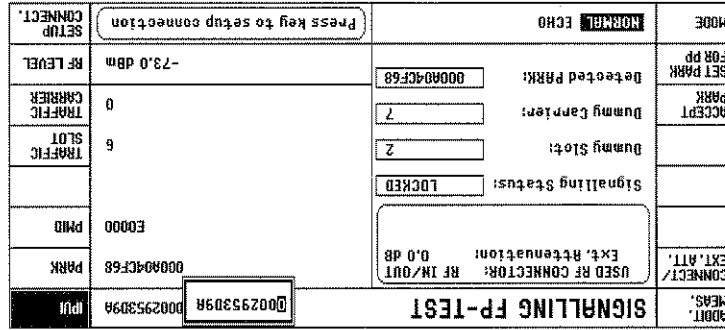

Step 3

When the ACCEPT PARK softkey is pressed, CMD60 uses the same PARK as the FP. Some FPs additionally require a correct PMID. The correct PUI ④ is also needed in the GAP mode. Press the RF LEVEL softkey, enter -40 and confirm with ENTER or turn the spinwheel until -40 dbm is displayed.

A call can now be set up by pressing the SETUP CONNECT softkey. After a successful call setup ⑤, CMD60 is in the CONNECTION ESTABLISHED status (see section 2.1.4).

Additional information

Step 1

- ① **Dummy bearer**
The dummy bearer in the GAP mode does not differ significantly from that in the test mode (see section 2.1.2).

Step 2

- ② **GAP mode**
After power-up, a DECT GAP unit is automatically in the GAP mode unless the DECT test mode has been activated. In the GAP mode the unit uses the normal signalling procedure of the GAP standard and ignores all test messages defined for the DECT test mode.

- ③ **PARK**
The "portable access rights key" is a code permitting the portable part to establish a connection only to specific fixed parts. The FP identifies itself by the ARI (access rights identity) contained in the PARK. CMD60 only uses PARKs of this class which are identical with the RFPi (see section 2.1.2).

- ④ **IPUI**
The IPUI (international portable user identity) is a number which unambiguously identifies the portable part. A fixed part can establish a connection to a portable part only if it knows the PP's IPUI. For a successful call setup one of the IPUIs stored in the fixed part must be entered.

Step 3

- ⑤ **Call setup**
The requirements for a successful call setup are described in section 2.4.2.4.

Additional Information

Step 1

① **Dummy bearer**
 The dummy bearer is a signal sent by the FP (in this case CMD60) to which the PP can synchronize. The signal is transmitted at the DECT clock of 10 ms and contains information for synchronization between FP and PP and for authentication, ie for verification if a call setup is permissible between a specific pair of FP and PP. In the default state, the dummy bearer is transmitted on channel 0 (softkey DUMMY CARRIER) in time slot 0 (softkey DUMMY SLOT).

Step 2

② **RFPI**
 The "Radio Fixed Part Identity" is a number that unambiguously identifies a fixed part, which is CMD60 in this case. A call setup between the PP and the FP is possible only if the RFPI stored in the PP coincides with that of the FP. If the RFPI of the PP is not known, it can be determined from the associated FP as shown in section 2.1.2, Step 2.

③ **DECT test mode**
 For tests on DECT systems, the PP must be set to a special test mode for a successful call setup. In this mode, the PP accepts test messages it otherwise ignores. The procedure for activating the test mode varies from unit to unit. In the case of some PPs, a specific key combination must be pressed during switch-on, others require a sequence of keys to be pressed after switch-on or a special test software to be loaded via an interface. Relevant information is to be obtained from the manufacturer in each case.

④ **Synchronization**
 Synchronization is understood to mean that the PP has received the dummy bearer (see ①) of the FP correctly, that it has the same RFPI (see ②) as the FP and has taken over the timing information from the FP. Indication of synchronization varies from PP to PP. In most cases synchronization is indicated by a symbol on the display of the PP. **Only then is it possible to set up a call.** Since the DECT system does not provide for any further sync status information, it is basically not possible for a tester to recognize if a PP is synchronized or not.

Step 3

⑤ **Call setup**
 In the default status of CMD60, call setup is performed on channel 0 (softkey TRAFFIC CARRIER) in slot 2 (softkey TRAFFIC SLOT).

Additional information

Step 1

- ① **Dummy bearer**
The dummy bearer in the GAP mode does not differ significantly from that in the test mode (see section 2.1.3).

Step 2

- ② **PARK**
The "portable access rights key" is a code permitting the portable part to establish a connection only to specific fixed parts. The FP (here CMD60) identifies itself by the ARI (access rights identity) contained in the PARK. CMD60 only uses PARKS of the class which are identical with the RFPI (see section 2.1.3).

- ③ **IPUI**
The IPUI (international portable user identity) is a code which unambiguously identifies the portable part. A fixed part can establish a connection to a portable part only if it knows the P's IPUI. For a successful call setup the IPUI of the portable part must be known.

- ④ **GAP mode**
After power-up, a DECT GAP unit is automatically in the GAP mode unless the DECT test mode has been activated. In the GAP mode the unit uses the normal signalling procedure of the GAP standard and ignores all test messages defined for the DECT test mode.

- ⑤ **Synchronization**
Synchronization means that the FP has received the dummy bearer (see ①) of the FP correctly, that one of its PARKS (see ②) contains the received ARI and that it has taken over the timing information from the FP. Indication of the sync status varies from PP to PP. In most cases synchronization is indicated by a symbol on the PP display. **Only then is it possible to set up a call.** Since the DECT signalling does not provide for any further sync status information, it is basically not possible for a tester to recognize if a PP is synchronized or not.

Step 3

- ⑥ **Call setup**
In the GAP mode the call is always set up from the portable part. A connection is established when the PP is picked up. An incoming call can however be simulated by pressing the SETUP CONNECT softkey. In this case the PP rings. The channel/slot combination for this call is determined by the PP and cannot be defined by CMD60.

On pressing softkey POWER RAMP, the power versus time can be measured. Parts of the power ramp can be magnified with softkeys RISING EDGE, USEFUL PART and FALLING EDGE. When softkey MARKER is pressed, a marker can be moved along the test trace by turning the spinwheel, the position being indicated in bits and the relative power referred to the measured NTP being indicated in dB. Tolerances and test parameters can be set for each measurement. For this, press hardkey CONFIG on the right of the front panel. CMD60 then goes to an intermediate menu from where the configuration menu can be called with softkey DY-POWER. Press softkey DYNAMIC to activate HIGH. Start a new measurement with MENU UP: a test trace with a wider dynamic range will be displayed. With AVERAGE (BURSTS), the number of bursts is displayed over which the power (NTP) is averaged. With STOP CONDITION, the condition for the end of the measurement is defined.

Step 2

The most important transmitter parameters are measured at ready in the menu CONNECTION ESTABLISHED: power (NTP) ①, frequency offset ② and maximum modulation deviation ③. If a tolerance is exceeded, the associated measured value is displayed in inverse video. In the PP test, the PMID ④ of the PP is indicated. Note that the softkey for the BER measurement (see 2.1.5) is not available in the GAP mode.

Step 1

2.1.4 DECT Transmitter Measurements on Portable Parts and Fixed Parts

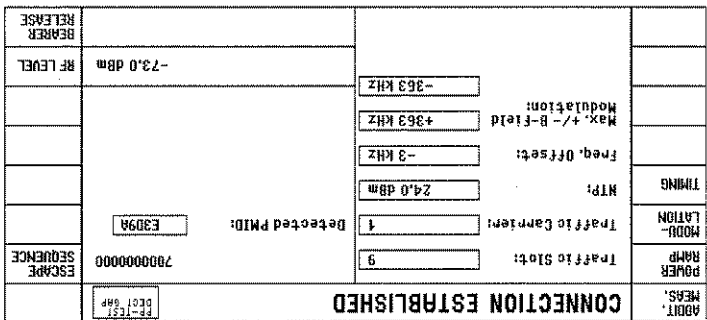
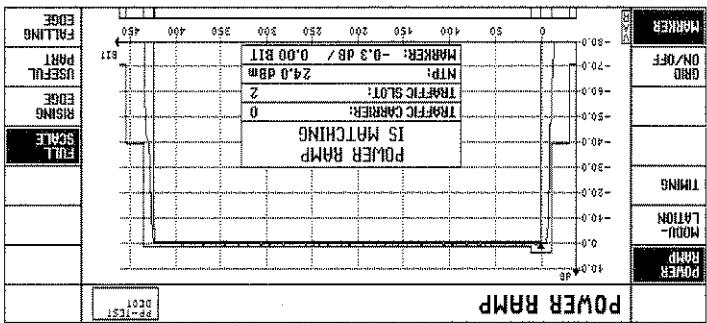
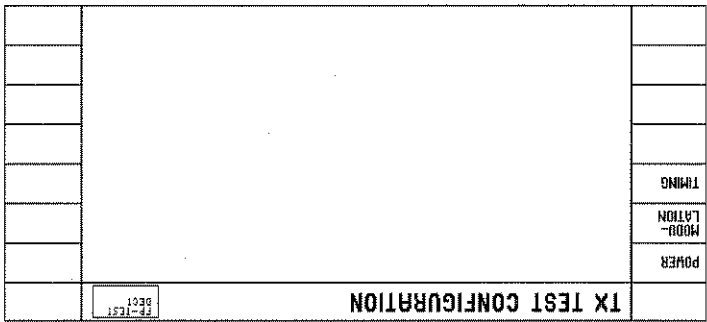
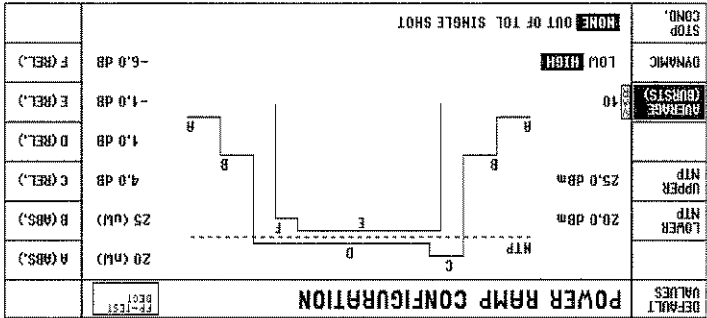

Additional Information

Step 1

① NTP The NTP (normal transmit power) is the power in dBm averaged over the DECT burst.

② Frequency offset The frequency offset is obtained as the average value of the demodulated signal over the B field (see step 3) for a selectable number of received bursts.

③ Modulation deviation The modulation deviation is the positive and negative maximum deviation from the average value of the demodulated signal over the B field for a selectable number of received bursts.

④ PMID The "Portable Part MAC Identity" is an identification number for the portable part.

Step 2

⑤ Bit P0 The first bit of the burst is derived from the demodulated signal by detecting the sync word (sync field, see step 3). Bit P0 determines the timing of the power ramp within the tolerance limits.

⑥ HIGH DYNAMIC If HIGH is selected, two bursts of different input sensitivity are measured and displayed simultaneously. With this function it can be checked if the level outside the burst meets the relevant requirements.

⑦ AVERAGE BURSTS The setting made here is also valid for the measurements made in menu CONNECTION ESTABLISHED and for modulation measurements.

⑧ STOP CONDITION You can select if a measurement is to be performed continuously (NONE), if only one measurement is to be performed (SINGLE SHOT) or if the measurement is to be stopped on exceeding a tolerance limit (OUT OF TOL).

When a measurement has been stopped, it can be restarted by pressing the associated softkey (POWER RAMP in this case).

The timing measurement menu can be called by pressing TIM-NG. In this menu, the timing accuracy ⑥, jitter ⑦ and, in the PP test, the packet delay ⑧ can be measured.

After completion of the measurement, press MENU UP to return to the menu CONNECTION ESTABLISHED.

Step 4

In the GAP mode the DATA TYPE softkey is disabled and the tested instrument sends a random data pattern. This can be seen from the graphics display. Because of the random pattern the frequency drift cannot be evaluated and is not displayed.

Upon pressing softkey DATA TYPE, the data pattern can be changed by means of the spin-wheel ③. Various DECT packet types ④ can be set with the aid of the PACKET TYPE softkey. Parts of the test trace can be magnified with softkeys PRE-AMBLE/SYNC, A-FIELD and B-FIELD ⑤.

The modulation measurement menu can be called from one of the menus CONNECTION ESTABLISHED or POWER RAMP by pressing MODULATION. Same as in CONNECTION ESTABLISHED, the measured frequency offset and modulation deviation ("Max. \pm B-field") are displayed. Moreover, the modulation deviation over the preamble ① and the frequency drift ② are measured.

Step 3

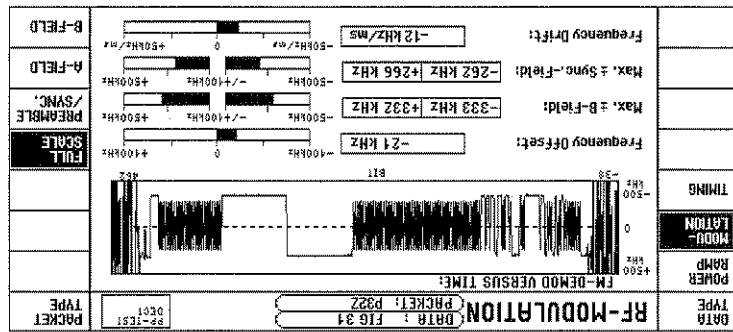
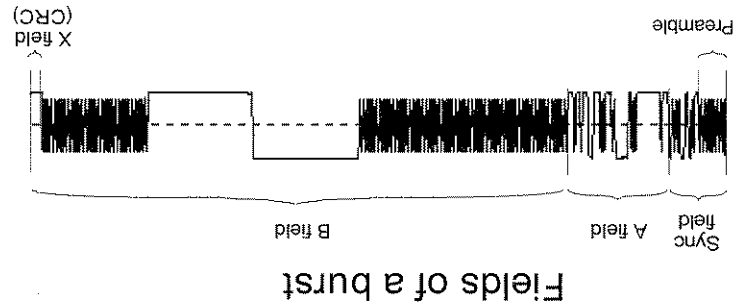
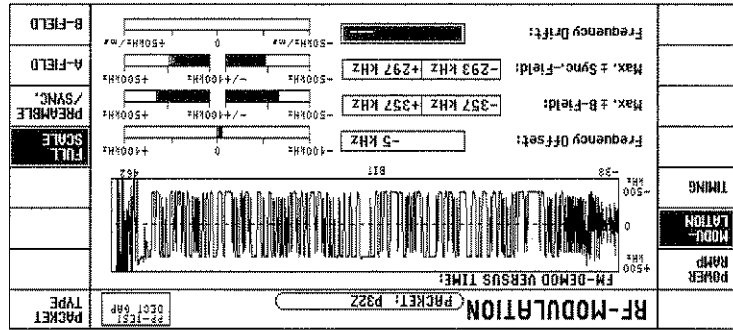
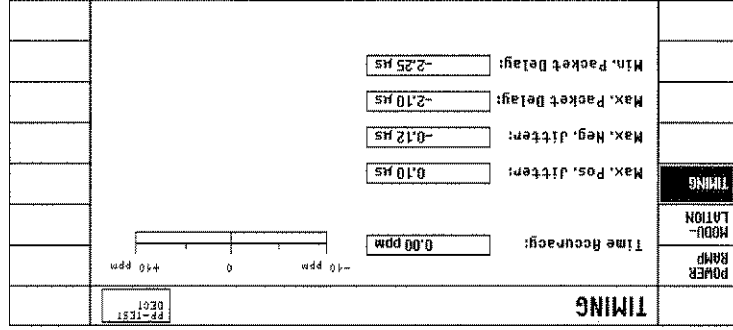

Additional Information

Step 3

① **Preamble**
The preamble consists of the first 16 bits of a burst with the modulation 010101...

② **Frequency drift**
The frequency drift is understood to be the frequency variation within a burst. The average modulation deviation is formed from the middle 14 bits of the preamble and also from the first 14 bits of the last 16 bits of the B field. The difference between the two average values is weighted with a constant, yielding the frequency drift in kHz/ms. Frequency drift measurements are possible only for data patterns ending with the sequence "zero-one". This applies to "FIG31" and "01010101".

③ **Data pattern (data type)**
After call setup, the CMD60 sets the DUT to the loopback mode. In this mode, the DUT returns the received data to the CMD60.

The following patterns can be selected: "FIG31", "01010101", "00110011...", "00001111...", "PSRBS" and "SPRBS". "FIG31" is a sequence of 128 alternating bits (0101...), 64 ones, 64 zeroes and 64 alternating bits. "PSRBS" is a sequence of pseudo random numbers with a repetition period of 2¹¹-1 bits. "SPRBS" is a sequence of pseudo random numbers repeated in every burst. Measurement of the frequency drift is possible only with the two first-named patterns.

④ **Packet type**
The DECT standard defines various packet types. They differ by the information data rate as well as by extensions at the beginning (prolonged preamble) and end (Z field) of the normal packet. CMD60 is able to handle the standard type F32 with prolonged preamble (P32), Z field (P32Z) or both (PP32Z). With prolonged preamble selected, the first 16 bits (preamble) of the packet are doubled. The Z field is a repetition of the last four bits (X field) at the packet end.

⑤ **Display ranges**
The selection of a specific display range has no effect on the measurement.

Step 4

⑥ **Timing accuracy**
This is understood to be the accuracy of the time interval between two successive bursts relative to the nominal value of 10 ms (see example below). This parameter is measured and averaged over a selectable number of bursts.

⑦ **Jitter**
Maximum and minimum interval between two successive bursts minus the average interval (see example below).

⑧ **Packet delay (PP test only)**
Maximum and minimum interval between bursts of CMD60 as FP and bursts of PP under test minus 5 ms.

Example:

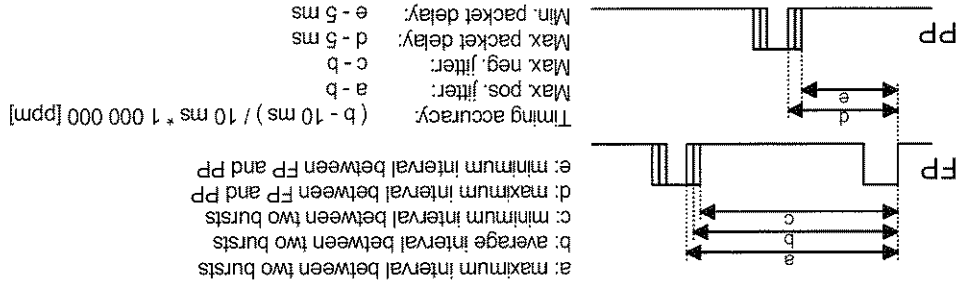

2.1.5 DECT Receiver Measurements on Portable Parts and Fixed Parts

Step 1

The BER measurement menu can be called from menu CONNECTION ESTABLISHED by pressing softkey BER.

NOTE: A BER measurement cannot be performed in the GAP mode.

In this measurement, the bits received are compared with the number of erroneous bits and yields the bit error rate BER ①. The frame erasure rate FER is the ratio of erroneous frames to total frames ②.

"Current BER/FER" indicates the current values ③, "Longterm BER/FER" the values averaged over a time window ("Evaluation Window") selectable in the configuration menu.

Upon pressing RF LEVEL, the transmit power of CMD60 can be varied with the spinnwheel to examine the effect of the power level received by the DUT on the bit error rate and the frame erasure rate.

BIT ERROR RATE		DATA TYPE: PSRBS		RF LEVEL	
BER	Current BER:	0 ppm	Current FER:	0 ppm	RF LEVEL: -73.0 dbm
	Longterm BER:	0 ppm	Longterm FER:	0 ppm	
	Eval. Window Indicator:	0	Longterm BER:	0 ppm	
		1.00	Current FER:	0 ppm	
			Longterm FER:	0 ppm	
			Eval. Window:	0	
			STOP CONDITION:	NONE	
				(1.00 s)	
				EVAL. WINDOW: 100 * [320 BIT]	
				TEST SETUP:	
				0 1 2 3 4 5	6 7 8 9 10 11
				MULTI BEARER (slots):	

Step 1

Additional Information

- ① BER (bit error rate)
The bits of invalid frames are not taken into account in the BER measurement (see ②).
- ② FER (frame erasure rate)
If 25% or more of all bits of a frame is erroneous, the frame is declared invalid and taken into account in the FER and not in the BER.
- ③ Current BER / FER
Average value formed over the last approximately 33 bursts.

2.2 Menu Structure

The following diagrams show the structures of the operating, configuration and autotest menus of the CMD60. The connections between operating and configuration menus are not presented here for reasons of clarity.

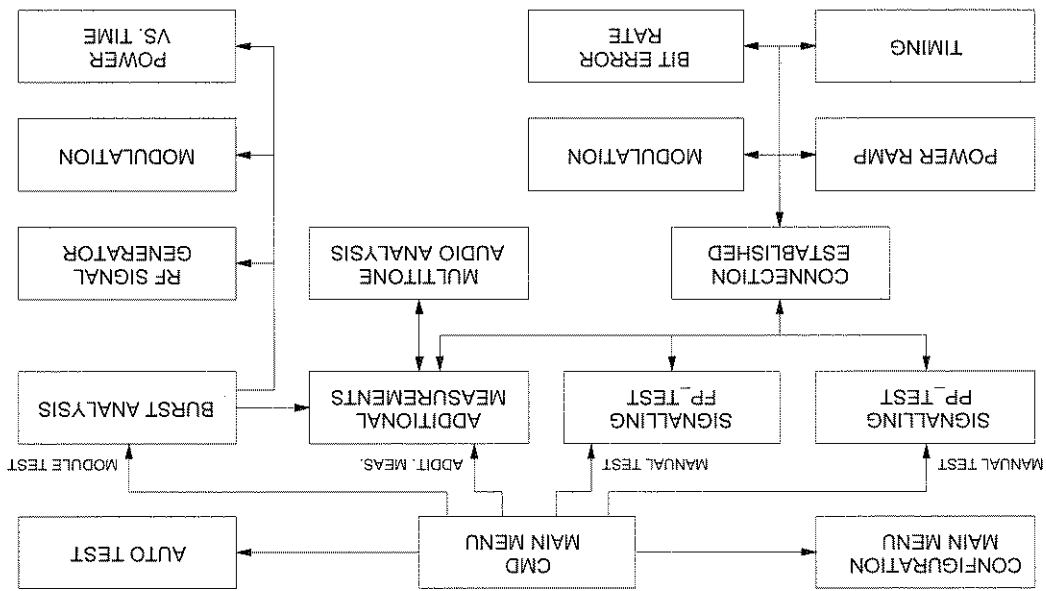

Fig. 2.2-1 Structure of operating menus of CMD60

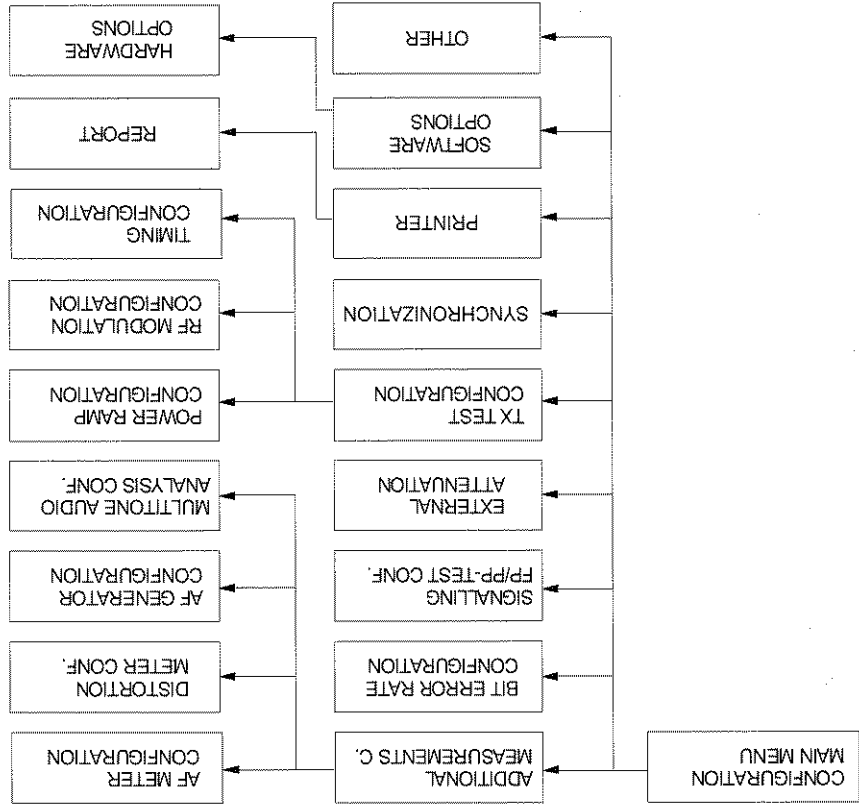

Fig. 2.2-2 Structure of configuration menus of CMD60

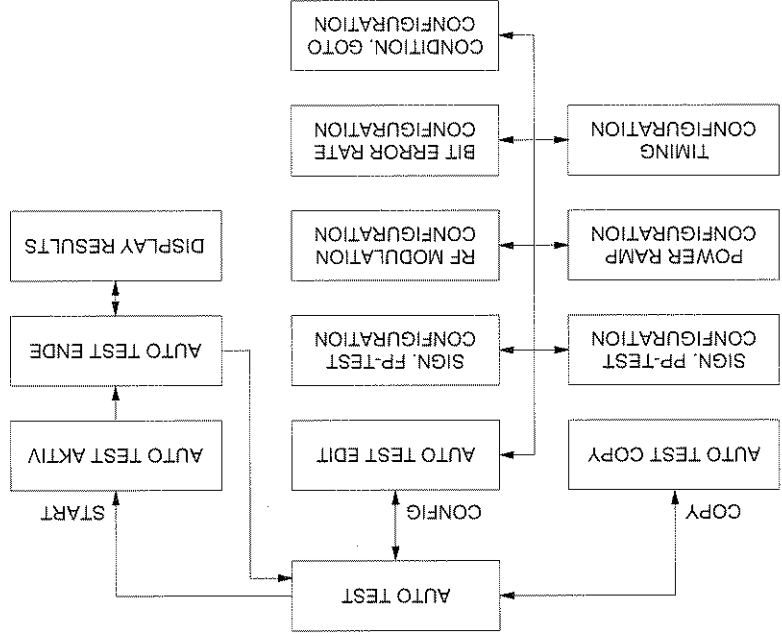

Fig. 2.2-3 Structure of autotest menus of CMD60

2.3 Basic Operating Instructions and Storage of Parameters

The controls used for data entry into the CMD60 are explained below:

Numerical input

Data entry is only possible if the respective softkey is shown in inverse video (white text on black background). The softkey appears in inverse video when it is activated. If a VAR symbol appears on the softkey, data can be entered alternatively using the spinwheel VAR.

- Turning the spinwheel VAR directly increases or reduces the setting value.

- On actuation of a number key, an input window is opened up, allowing the entry of further digits (or the hexadecimal letters A to F). The hardkey BACKSPACE deletes the last digit, CLEAR deletes the entire entry, STOP BREAK closes the input window without having transferred the value. ENTER is used to terminate the entry and transfer the value.

- In some cases, the entry can also be terminated by means of the unit keys, the entered value being transferred together with the desired unit, eg

1 5 dBm ⇒ 15 dBm

When using the ENTER key, the currently set unit is used.

1 8 ENTER ⇒ 18 dBm

The conversion of units is possible by pressing the respective unit key.

Channel 0 ⇒ MHz ⇒ 1897.344 MHz

1 out of n selection with softkeys

On actuation of a softkey, it appears in inverse video and the corresponding selection is made.

Loop toggle

Two or more operating states are displayed next to a softkey. The active status is shown inversely. The operating status can be changed by pressing the associated softkey (repeatedly if necessary).

Selection with confirmation

After activation of a softkey, any possible setting can be made with the spinwheel. The setting becomes effective by pressing the ENTER key.

Text input

Alphanumeric text entries (eg USER CONFIG) are made via a PC-AT keyboard connected to the rear of the instrument. Alternatively, characters can also be entered directly. The selection of characters is made using the spinwheel, the cursor position is changed using START (to the left) and LOCAL (to the right). The character left to the cursor is deleted using BACKSPACE.

Hardkeys



In addition to the measurement menus, there are many configuration menus, which permit the definition and variation of parameters for measurements and default settings. These configuration menus are selected either directly via the configuration tree or in the respective context by pressing the CONFIG hardkey.



This key permits changing to the next higher menu. For example, it can be used to leave configuration menus, measurement menus or help menus.



This key permits direct return to the main menu.



After actuation of this key, the current screen contents is output to a connected printer. The appropriate printer driver is to be selected before in the printer configuration menu ("PRINTER").



On actuation of the RESET key, the following picture appears:

RESET DATA	
ALL DATA	<p>"ALL DATA" resets all parameters.</p> <p>"WITHOUT REMOTE" resets all parameters without the IEEE ADDRESS and the RS232 configuration.</p> <p>"MENU UP" will leave the menu without changing any data.</p>
WITHOUT REMOTE	

With the functions offered in this menu, the user can set the CMD60 to a defined initial status.



All internal parameters including the remote registers are reset.

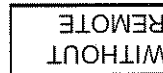

All internal parameters except the remote registers are reset. This function is useful in the remote-control mode, for example, to prevent an interruption of the remote-control connection.

If no reset is to be performed, the menu can be left using the keys MENU HOME or MENU UP. After triggering the two reset functions, a change is made to the main menu.

After activating the associated softkey, the user name can be entered numerically via the keypad and confirmed using the ENTER key. If an external AT keyboard is connected (rear of instrument), the entry can also be made alphanumerically. Alternatively, the selection of characters can be made using the spinwheel (see text input). For returning to the USER menu (Fig. 2.3-2), the MENU UP key is used.

Fig. 2.3-3 CONFIGURATION (USER) menu

USER 7	NOBODY	
USER 6	NOT KNOWN	
USER 5	UNKNOWN	
USER 4	SCHMIDT	DR.NO.
USER 3	MAYER	
USER 2	MUELLER	MY DATA
USER 1	MUSTERMANN	MUSTERFRAN
CONFIGURATION		
USER 14		
USER 13		
USER 12		
USER 11		
USER 10		
USER 9		
USER 8		

The user names are entered in an extra configuration menu. This menu can be selected from the USER menu (Fig. 2.3-2) by pressing the CONFIG key:

The SAVE/RECALL functions in the CMD60 can be used by different users (max. 14) independently of each other. Thus, every user can store his own settings under names selected by himself. The menu can be left using the keys MENU HOME or MENU UP.

Fig. 2.3-2 USER menu

USER 7	NOBODY	
USER 6	NOT KNOWN	
USER 5	UNKNOWN	
USER 4	SCHMIDT	
USER 3	MAYER	
USER 2	MUELLER	MY DATA
USER 1	MUSTERMANN	MUSTERFRAN
USER		
USER 14		
USER 13		
USER 12		
USER 11		
USER 10		
USER 9		
USER 8		

By actuating the USER key, the user list is called up:



SAVE/RECALL functions

Instrument settings, eg RF signal generator settings or tolerance values can be stored using this function. These settings can be recalled at a later date.



By pressing the SAVE key, the following menu is called up:

7	FREE	MEMCARD	INTERM	MEMORY
6	SETTINGS5			
5	FREE			
4	FREE			
3	FREE			
2	SETTING1			
1	FILE_XYZ			
SAVE		USER 1 MUSTERMANN		

Fig. 2.3-4 SAVE menu

By pressing one of these softkeys, the current instrument setting is stored under the name indicated next to the softkey. The name can be entered in the configuration menu in Fig. 2.3-5.

1

to
13

MEMORY

If INTERN is active, the setting is stored on the harddisk of CMD60. The name for the setting can be entered in the configuration menu in Fig. 2.3-5. If MEMCARD is active, the instrument setting is stored on a memory card (only with Options CMD-B6 and CMD-B62). Storage is performed in this way irrespective of the selected user (USER).

The menu can be left with key MENU HOME or MENU UP.

After pressing the CONFIG key in the SAVE menu (Fig. 2.3-4), the configuration menu for entering the memory name is called up:

CONFIGURATION	
1	FILE_XYZ
2	SETTING1
3	FREE
4	FREE
5	FREE
6	SETTINGS5
7	FREE
test 1,2,95	
8	FREE
9	FREE
10	FREE
11	FREE
12	FREE
13	SPECIAL

Fig. 2.3-5 CONFIGURATION (SAVE) menu

The name under which a setting is to be stored can be entered numerically via the keypad after activation of the associated softkey and is confirmed with the ENTER key. If an external AT keyboard is connected (rear of instrument), an alphanumeric entry is also possible. Alternatively, characters can be entered using the spinwheel (see text input).

NOTE:

If settings are stored on the memory card, the configured name is also stored as directory name.

To return to the SAVE menu (Fig. 2.3-4), press the MENU UP key.



By actuating the RECALL key, the following menu is called up:

DEFAULT VALUES	RECALL	USER 1 MUSTERMANN	
1	FILE_XYZ	FREE	8
2	SETTING 1	FREE	9
3	FREE		10
4	FREE		11
5	FREE		12
6	SETTING 5	SPECIAL	13
7	FREE	MEMCARD INTERN	MEMORY

Fig. 2.3-6 RECALL menu

All settings are reset to the default values.



By actuating one of these softkeys, the instrument setting with the name next to the softkey is loaded. The instrument then continues operation with the activated setting and tolerance values.

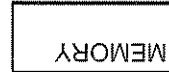

If INTERN is active, the setting is loaded from the harddisk of the CMD60. This is done separately for each user. The currently selected user (USER) is indicated in the upper status line. User names can be entered in the configuration menu in Fig. 2.3-5.

If MEMCARD is active, the instrument setting is read from a memory card (only with Options CMD-B6 and CMD-B62). Settings are loaded in this way irrespective of the selected user (USER).

NOTE:

Reading of the memory card contents is started when the menu is entered. When changing the card, the menu is to be left temporarily for reasons of consistency.



The brightness of the display can be varied in three steps.



The character last entered in a text window is deleted.



Display of brief description of hardkeys.

2.4 Description of Operating Menus

After switch-on and initialization of the instrument, the main menu appears. Measurement functions can be selected by pressing the associated softkeys.

2.4.1 Main Menu

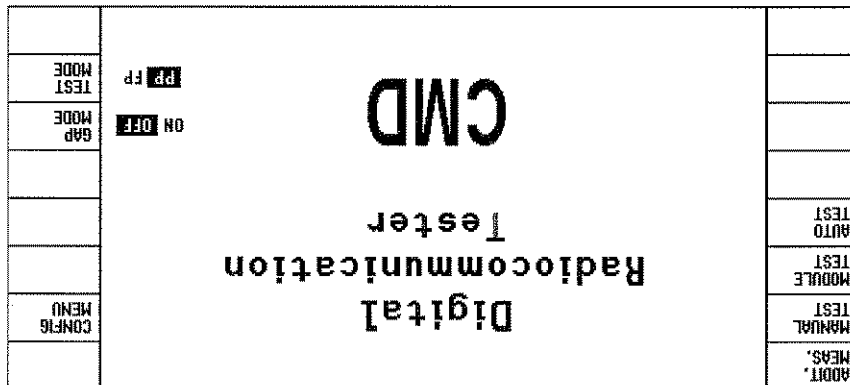

Fig. 2.4-1 Main menu

Return to the main menu can be made from any other menu by pressing the hardkey MENU HOME. The menu ADDITIONAL MEASUREMENTS is called up (only with Option CMD-B41). This menu permits Af measurements to be performed (see sections 2.4.5 and 2.5.5).

ADDIT. MEAS.

Depending on the selected DUT (PP-TEST or FP-TEST), you can go to the DECT signalling menus (manual operation). Depending on the mode selected, the CMD60 simulates a fixed part (in the PP-TEST) or a portable part (in the FP-TEST) (see sections 2.4.2 and 2.4.3).

MANUAL TEST

This mode permits measurements on modules or DECT systems without requiring a call setup (see Section 2.4.4).

MODULE TEST

The autotest enables automatic sequences of measurement steps without any remote control function (see section 2.6).

AUTO TEST

The configuration main menu is called up (see section 2.5.1). Apart from this softkey, the hardkey CONFIG also permits entering context-sensitive configuration menus.

CONFIG MENU

Selects the signalling mode for testing the DUT. With ON selected, normal signalling is used, with OFF selected, a test mode signalling is used which can handle only a limited set of test messages. With OFF selected, the DUT has to be set to the DECT test mode. This is a device-specific procedure and should be enquired from the manufacturer.

GAP MODE

Selection of a portable part (PP) or a fixed part (FP) as DUT. By subsequent activation of the softkeys MANUAL TEST, the menu SIGNALLING PP-TEST or SIGNALLING FP-TEST is called up.

TEST MODE

2.4.2 Manual Test

In this test mode, PPs (portable parts) and FPs (fixed parts) are tested manually with call setup. Depending on the selected mode (PP-TEST or FP-TEST), a change is made from the main menu to one of the menus SIGNALLING PP-TEST or SIGNALLING FP-TEST by actuating the softkey MANUAL TEST.

2.4.2.1 Menu SIGNALLING PP-TEST

In this menu, the CMD60 sends a dummy bearer signal for synchronization of the PP (portable part) as DUT. As a prerequisite for successful synchronization, the RFP1 (Radio Fixed Part Identity) for the FP (fixed part) simulated by the CMD60 must be entered correctly. If this identification number is not known, it can be derived from the corresponding FP in the menu SIGNALLING FP-TEST (section 2.4.2.2).

Prior to the call setup, the PP under test is set to the test mode so that it can respond to test messages. This is done in different ways depending on the instrument (information to be obtained from the manufacturer). The display indicating whether the PP has synchronized is also instrument-specific. When the PP has synchronized to the CMD60, a call setup can be made by actuating the softkey SETUP CONNECT.

If an external reference frequency and/or the SLAVE mode has been set in the menu SYNCHRONIZATION, a warning is output in the top right corner of this menu.

SIGNALLING PP-TEST		ADDIT. MEAS.
CONNECT/EXT. ATT.		USED RF CONNECTOR: RF IN/OUT Ext. Attenuation: 0.0 dB
CONNECT/EXT. ATT.		Wait for mobile synchronization before setup the connection ...
CONNECT/EXT. ATT.		Loopback Normal Echo
MODE	Press key to setup connection	SETUP CONNECT.
RF LEVEL	-50.0 dbm	
DUMMY SLOT	0	
DUMMY CARRIER	0	
TAFIFIC SLOT	2	
TAFIFIC CARRIER	0	
RFP1	0002501997	

Fig. 2.4-2 Menu SIGNALLING PP-TEST

The menu **ADDITIONAL MEASUREMENTS** is called (only with Option CMD-B41). This menu permits AF measurements to be performed (see sections 2.4.5 and 2.5.5).

This softkey is used to go to a configuration menu, in which the RF connectors and correction values for attenuation on external paths can be entered (see section 2.5.4.1). The values set are indicated in the **SIGNALLING PP-TEST** menu.

CONNECT/EXT. ATT.

ADDIT. MEAS.

MODE

Various modes of connection can be selected:

- LOOPBACK: the DUT (device under test) is set to the loopback mode in order to return the transmitted data without modification. This is the prerequisite for modulation and bit error rate measurements.

- NORMAL: the DUT converts the received data in the CODEC and passes them on to the loudspeaker. Signals recorded via the microphone are also converted and sent to the CMD60. The associated audio signals are available at the 50-contact socket of the CMD60. This mode permits audio measurements to be performed (microphone, loudspeaker, converter).

NOTE:
Not all portable parts permit audio connections in the test mode. Therefore, it may happen that the NORMAL and ECHO mode do not have the desired result.

- ECHO: the signals applied to the microphone are sent to the CMD60, delayed by one second, returned to the DUT and output at its loudspeaker. This mode permits fast qualitative testing of the DUT.

NOTE:
Not all portable parts permit audio connections in the test mode. Therefore, it may happen that NORMAL and ECHO mode do not have the desired result.

Input of the Radio Fixed Part Identity. This is the identification number of the fixed part to be simulated. If the number is not known, it can be derived from the corresponding FP in the menu SIGNALLING FP-TEST (section 2.4.2.2).

RFPI

As a prerequisite for a successful synchronization of the PP, the RFPI must be entered correctly.

DUMMY SLOT

Input of the slot number of the dummy bearer to be transmitted. Permissible values are 0 to 11. It should however be noted that the slot values of dummy bearer and traffic bearer are not identical. Besides, adjacent slot values (eg 5 and 6; even 11 and 0 are adjacent) are permissible only if the channel numbers of dummy bearer and traffic bearer are adjacent, the channel numbers of dummy bearer and traffic bearer must coincide. The assignment of channel numbers to the frequencies used is shown in the table below.

DUMMY CARRIER

Input of the slot number of the traffic bearer with call setup. Permissible values are 0 to 11. It should however be noted that the slot values of dummy bearer and traffic bearer are not identical. Besides, adjacent slot values (eg 5 and 6, even 11 and 0 are adjacent) are permissible only if the channel numbers of dummy bearer and traffic bearer are identical.

TRAFFIC SLOT

TRAFFIC CARRIER

Input of the channel number of the traffic Carrier with call setup. Channel numbers from 0 to 9 are possible. If the slot values of dummy bearer and traffic bearer are adjacent, the channel numbers of dummy bearer and traffic bearer must coincide. The assignment of channel numbers to the frequencies used is shown in the table below.

RF LEVEL

Setting of the transmit power from -40 dBm to 100 dBm (referred to RF IN/OUT) in steps of 0.1 dB.

SETUP CONNECT.

Call setup and change to the menu CONNECTION ESTABLISHED. Please note that the call setup is successful only if the PF under test has been set to the device-specific test mode and has synchronized to the CMD60. This is indicated on the PF.

Assignment of DECT channel numbers to frequencies

The following table shows the frequencies used in DECT in MHz. To enable simultaneous operation of a larger number of test stations and/or keeping up the telephone operation with DECT systems, the CMD60 permits to make use of extended channels. By varying the value CARRIER # OFFSET in the menu SIGNALING PP/FP-TEST CONFIGURATION (see sections 2.5.2.1 and 2.5.2.2), it is possible to vary the assignment of the channel numbers to the frequencies by half the DECT channel spacing. This is an extension to DECT. Values for CARRIER # OFFSET unequal to zero are indicated in the menus SIGNALING PP-TEST and SIGNALING FP-TEST.

NOTE:

To make use of the feature of extended channels of the CMD60, the devices under test must be able to perform the same frequency assignment (exceeding DECT).

Channel	0	1	2	3	4	5	6	7	8	9
Offset	1902.528	1900.800	1899.072	1897.344	1895.616	1893.888	1892.160	1890.432	1888.704	1886.976
-3	1901.664	1899.936	1898.208	1896.480	1894.752	1893.024	1891.296	1889.568	1887.840	1886.112
-2.5	1900.800	1899.072	1897.344	1895.616	1893.888	1892.160	1890.432	1888.704	1886.976	1885.248
-2	1899.936	1898.208	1896.480	1894.752	1893.024	1891.296	1889.568	1887.840	1886.112	1884.384
-1.5	1899.072	1897.344	1895.616	1893.888	1892.160	1890.432	1888.704	1886.976	1885.248	1883.520
-1	1898.208	1896.480	1894.752	1893.024	1891.296	1889.568	1887.840	1886.112	1884.384	1882.656
-0.5	1897.344	1895.616	1893.888	1892.160	1890.432	1888.704	1886.976	1885.248	1883.520	1881.792
0	1896.480	1894.752	1893.024	1891.296	1889.568	1887.840	1886.112	1884.384	1882.656	1880.928
0.5	1895.616	1893.888	1892.160	1890.432	1888.704	1886.976	1885.248	1883.520	1881.792	1880.064
1	1894.752	1893.024	1891.296	1889.568	1887.840	1886.112	1884.384	1882.656	1880.928	1879.200
1.5	1893.888	1892.160	1890.432	1888.704	1886.976	1885.248	1883.520	1881.792	1880.064	1878.336
2	1893.024	1891.296	1889.568	1887.840	1886.112	1884.384	1882.656	1880.928	1879.200	1877.472
2.5	1892.160	1890.432	1888.704	1886.976	1885.248	1883.520	1881.792	1880.064	1878.336	1876.608
3	1890.432	1888.704	1886.976	1885.248	1883.520	1881.792	1880.064	1878.336	1876.608	

Table 2.4-1: Channel/frequency assignment on CMD60

2.4.2.2 Menu SIGNALLING PP TEST in the GAP mode

Description of Operating Menus

CMD60

In this menu, CMD60 sends the dummy bearer signal required for synchronizing the PP (portable part) as a DUT. However, a prerequisite for a successful synchronization is the correct entry of the PARK (portable access rights key) of the PP to be tested, which enables the CMD60 to send a suitable ARI (access rights identity) which is included in the PARK (Note: CMD60 only uses class A PARKs and ARIs). The IPUI (international portable user identity) of the PP must also be entered. If the PARK is not known, it can be obtained in the SIGNALLING FP-TEST menu, also in the GAP mode, from the corresponding FP.

A call can be set up as soon as the PP has synchronized to the CMD60. The indication whether the PP has synchronized or not is device-specific. Press the SETUP CONNECT softkey to simulate an incoming call and to cause the PP to ring. Press the key with the handset icon (pick up) on the PP to establish a connection. The call can also be set up directly from the PP without previously pressing the SETUP CONNECT key. This has no effect on the subsequent measurements.

ADDT. MEAS.	SIGNALLING PP-TEST		002295309A	IPUI
CONNECT/ EXT. ATT.	USED RF CONNECTOR: RF IN/OUT Ext. Attenuation: 0.0 dB		000A04CF68	PARK
	Wait for mobile synchronization before setup the connection ...		0	DUMMY SLOT
			0	DUMMY CARRIER
			-50.0 dBm	RF LEVEL
	NORMAL ECHO		Press key to setup connection	
MODE	SETUP CONNECT.			

Fig. 2-4-3 Menu SIGNALLING PP-TEST GAP-MODE

Most of the softkey functions of this menu are identical with those described in section 2.4.2.1. The differences encountered in the GAP mode are described below. Note that in the GAP mode the PP decides about channel and slot used for a call setup. For this reason the TRAFFIC SLOT and TRAFFIC CARRIER softkeys are not longer available.

Different connect modes are available:

MODE

- NORMAL

The DUT converts the received data in its CODEC and forwards them to the loudspeaker. Signals picked up by the microphone are also converted and sent to the CMD60. The corresponding audio signals are available at the 50-contact female connector of CMD60. In this mode, audio measurements (microphone, loudspeaker, converter) can be performed.

- ECHO

The signals picked up by the microphone are sent to the CMD60 where they are delayed by one second, returned to the DUT and output at the DUT loudspeaker. In this mode a fast quality test of the DUT can be performed.

- The LOOPBACK setting of the normal SIGNALLING PP-TEST menu uses a message of the DECT test mode. This setting is therefore not available in the GAP mode and BER measurements cannot be performed.

Entry of "international portable user identity". This is a number permitting an unambiguous identification of the PP.

IPUI

A correctly entered IPUI is a precondition for a successful call setup.

Entry of "portable access rights key". It includes information on the access rights of the FP to be simulated. If the PARK is not known, it can be obtained from the corresponding FP in the SIGNALLING FP-TEST menu (see section 2.4.2.4).

PARK

A correctly entered PARK is a precondition for the successful synchronization of the PP.

Entry of slot number of dummy bearer to be sent. Permissible values are 0 to 11.

**DUMMY
SLOT**

Entry of channel number of dummy bearer to be sent. Channel numbers from 0 to 9 can be entered. The assignment of the channel numbers to the frequencies to be used can be looked up in Table 2.4-1.

**DUMMY
CARRIER**

Simulation of an incoming call which causes the PP to ring. The connection is established when the PP is picked up even without prior pressing of SETUP CONNECT.

**SETUP
CONNECT**

2.4.2.3 Menu SIGNALLING FP-TEST

In this menu, the CMD60 attempts to synchronize to the dummy bearer signal of the fixed part under test. The signalling status indicates LOCKED if the synchronization is successful, otherwise UNLOCKED. If the synchronization is successful, the slot, channel and RFPI of the FP to which the CMD60 has synchronized remain indicated.

If a value unequal to zero has been selected for CARRIER # OFFSET, this is indicated in the menu.

A successful call setup is possible only if the following conditions are met:

- The FP under test is set to the test mode and can thus respond to test messages. The way how to do this varies from instrument to instrument (information to be obtained from manufacturer).
- Signalling status: LOCKED
- The set RFPI (Radio Fixed Part Identity) and the detected RFPI correspond to each other.
- A PMID (Portable Part MAC Identity) accepted by the FP has been entered. Most FPs accept any PMID in the test mode. If necessary, the PMID of a FP corresponding to the FP can be derived from the menu CONNECTION ESTABLISHED in the PP-TEST.
- The value set for TRAFFIC SLOT is unequal to the value for DUMMY SLOT. If the slots are adjacent (eg 5 and 6, even 11 and 0 are adjacent), the values for TRAFFIC CARRIER and DUMMY CARRIER must be identical.

NOTE:

The values of the dummy bearer may change.

- The FP under test must be able to set up a traffic bearer with the selected slot/carrier pair. Many FPs accept even slot values only.
- The transmit power set is sufficiently high for the call setup.

If an external reference frequency has been set in the menu SYNCHRONIZATION, a warning is output in the top right corner of this menu.

A call setup can be started by means of softkeys SETUP CONNECT..

NOTE:

Synchronization is performed continuously even after activating the softkey SETUP CONNECT. It is thus ensured that only one connection to the FP with the set RFPI is made if signals from several FPs are received.

ADDT. MEAS.		SIGNALLING FP-TEST	
CONNECT/	USED RF CONNECTOR: RF IN/OUT	0.0 dB	
EXT. RTT.	Ext. Attenuation:	0.0 dB	
	Signalling Status:	LOCKED	
	Dummy Slot:	3	
ACCEPT	Dummy Carrier:	7	
RFPI	Detected RFPI:	6162636465	
SET FOR FP			
MODE	LOOPBACK NORMAL ECHO	Press key to setup connection	
		SETUP CONNECT.	
		TRAFFIC SLOT	0
		TRAFFIC CARRIER	0
		REF LEVEL	-50.0 dBm
		PMID	01A2C
		RFPI	0002501997

Fig. 2-4-4 Menu SIGNALLING FP-TEST

The menu **ADDITIONAL MEASUREMENTS** is called (only with Option CMD-B41). This menu permits AF measurements to be performed (see sections 2.4.5 and 2.5.5).

This softkey is used to go to a configuration menu in which the RF connectors and correction values for attenuation on external paths can be entered (see section 2.5.4.1). The selected values are indicated in the menu **SIGNALLING FP-TEST**.

The currently displayed value for "Detected RFP" is accepted as RFP setting.

The currently displayed value for "Detected RFP" is accepted as RFP setting in the menu **SIGNALLING PP-TEST** (see section 2.4.2.1).

Various modes of connection can be selected:

- **LOOPBACK:** the DUT is set to the loopback mode in order to return the transmitted data without modification. This is a prerequisite for modulation and bit error rate measurements.

- **NORMAL:** the DUT converts the received data in its ADPCM. Recorded data are also converted and sent to the CMD60. The associated audio signals are available at the 50-contact socket of the CMD60. In this mode, audio measurements (converter) can be performed (see note for ECHO).

NOTE:
Not all fixed parts permit audio connections in the test mode. Therefore, it may happen that the NORMAL and ECHO modes do not have the desired result. The NORMAL and ECHO modes are more useful for portable parts than for fixed parts.

- **ECHO:** the signals applied to the FP are sent to the CMD60, delayed by one second and returned to the DUT. This mode permits fast qualitative testing of the DUT.

NOTE:
Not all fixed parts permit audio connections in the test mode. Therefore, it may happen that the NORMAL and ECHO modes do not have the desired result. The NORMAL and ECHO modes are more useful for portable parts than for fixed parts.

Input of the "Radio Fixed Part Identity". This is an identification number of the fixed part under test. A successful call setup is possible only if the values of the selected and the received RFP are identical.

Input of the "Portable Part MAC Identity". This is the identification number of the portable part to be simulated. Most FPs accept any PMID in the test mode. If necessary, the PMID of a portable part corresponding to the FP can be read from the menu **CONNECTION ESTABLISHED** in the **PP-TEST**.

ADDIT.
MEAS.

CONNECT/
EXT. ATT.

ACCEPT
RFP

SET RFP
FOR PP

MODE

RFP

PMID

Description of Operating Menus **CMD60**

Input of the slot number of the traffic bearer on call setup. Permissible values are 0 to 11. It should be noted however that the slot values of dummy bearer and traffic bearer are not identical. Besides, adjacent slot values (eg 5 and 6, even 11 and 0 are adjacent) are permissible only if the channel numbers of dummy bearer and traffic bearer are identical.

TRAFFIC
SLOT

The FP under test must be able to set up a traffic bearer for the indicated slot value. Many FPs accept even slot values only.

NOTE:

The values of the DUMMY SLOT may change.

Input of the channel number of the traffic bearer on call setup. Channel numbers from 0 to 9 are possible. If the slot values of dummy bearer and traffic bearer are adjacent, the channel numbers of dummy bearer and traffic bearer must correspond to each other. The assignment of channel numbers to the frequencies used is indicated in section 2.4.2.1.

TRAFFIC
CARRIER

Setting of the transmit power from -40 dBm to -100 dBm (referred to RF IN/OUT) in steps of 0.1 dB.

RF LEVEL

Call setup and change to the menu CONNECTION ESTABLISHED. Please note that a successful call setup is possible only if the above-mentioned conditions are met.

SETUP
CONNECT.

2.4.2.4 Menu SIGNALING FP TEST in the GAP mode

In this menu, CMD60 attempts to synchronize to the dummy bearer signal of the FP to be tested. With successful synchronization, the signaling status LOCKED is indicated, otherwise UNLOCKED. Once synchronization is achieved, the slot, channel and PARK of the FP to which the CMD60 has synchronized are also indicated.

A note is displayed in the menu if a value other than zero has been set for CARRIER # OFFSET. The following requirements have to be met for a successful call setup:

- Signalling status: LOCKED
 - The set IPUI (international portable user identity) corresponds to the PP associated with the FP.
 - The set PARK (portable access rights key) and the detected PARK are identical.
 - A PMID (portable part MAC identity, ie the identification number of the PP) is entered which is accepted by the FP. Most of the FPs accept any PMID. The PMID of a PP associated with the FP may be looked up in the CONNECTION-ESTABLISHED menu of the PP-TEST.
 - The value set for TRAFFIC SLOT is unequal to the Dummy Slot value. If the slots are next to each other (eg 5 and 6 or 11 and 0), identical values have to be set for TRAFFIC CARRIER and Dummy Carrier.
- CAUTION:**
- Dummy bearer values may change.*

- The FP to be tested must be able to generate a traffic bearer on the specified slot/carrier pair. Many FPs accept even slot values only.
 - The set transmit power is sufficient for a call setup.
- If an external reference frequency has been set in the SYNCHRONIZATION menu, a respective warning is displayed in the top righthand corner of this menu.
- A connection is now established by pressing the SETUP CONNECT softkey.

CAUTION:

The synchronization procedure is continuously repeated. A new synchronization procedure is also performed upon pressing the SETUP CONNECT. This ensures that a connection is established only to the FP with the set PARK when several FPs are received.

MODE	NORMAL ECHO	Press key to setup connection	SETUP CONNECT
SET PARK FOR PP	Detected PARK: 00004CF68	-50.0 dBm	RF LEVEL
ACCEPT PARK	Dummy Carrier: 4	0	TRAFFIC CARRIER
	Dummy Slot: 6	8	TRAFFIC SLOT
	Signalling Status: LOCKED		
CONNECT/EXT. ATT.	USED RF CONNECTOR: RF IN/OUT Ext. Attenuation: 0.0 dB	E0000	PMID
MEAS.	SIGNALING FP-TEST	00004CF68	PARK
		000295309A	IPUI

Fig. 2.4-5 Menu SIGNALING FP-TEST GAP-MODE

Most of the softkey functions of this menu correspond to those described in section 2.4.2.3. The differences encountered in the GAP mode are described below.

The currently displayed value for the detected PARK is stored as PARK setting.

ACCEPT
PARK

The currently displayed value for the detected PARK is stored in the SIGNALLING PP-TEST menu as PARK setting (see section 2.4.2.2).

SET PARK
FOR PP

Different connect modes are available:

MODE

The DUT converts the received data in its ADPCM. Picked up signals are also converted and sent to the CMD60. The corresponding audio signals are available at the 50-contact female connector of CMD60. In this mode, audio measurements (converter) can be performed (see note under ECHO).

ECHO

The signals present at the FP are sent to the CMD60, delayed for one second and then returned to the DUT. In this mode, a fast quality test of the DUT can be performed.

The LOOPBACK setting from the normal SIGNALLING PP-TEST menu uses a message of the DECT test mode. This setting is therefore not available in the GAP mode and BER measurements cannot be performed.

Entry of "International portable user identity". This number permits an unambiguous identification of the FP to be simulated.

IPIU

A correctly entered IPIU is a precondition for a successful call setup.

PARK

Entry of "portable access rights key". It includes information on the access rights of the FP. A successful call setup is only possible if the set and the received PARK are identical.

TRAFFIC
SLOT

The FP to be tested must be able to generate a traffic bearer on the specified slot value. Many FPs accept only odd slot values.

CAUTION:

Dummy slot values may change.

Entry of channel number of Traffic Bearer for a call setup. Channel numbers from 0 to 9 are permissible. If the slot values of Dummy Bearer and Traffic Bearer are neighbouring, the channel numbers of Dummy Bearer and Traffic Bearer must be identical. The assignment of channel numbers and frequencies used can be looked up in section 2.4.2.1.

TRAFFIC
CARRIER

Setting the transmit power from -40 dBm to -100 dBm (referred to RF IN/OUT) in 0.1 dB steps.

RF LEVEL



SETUP
CONNECT.

Call setup and branching to the CONNECTION ESTABLISHED menu. Please note that the requirements described at the beginning of the section must be met for a successful call setup.

Description of Operating Menus

CMD60

2.4.3 DECT Measurements

In this section the measurement menus are described. They apply both to portable parts and fixed parts. If there are any differences, these will be explained.

CAUTION:

Working in the GAP mode involves some new aspects, because in this mode the bit pattern sent by the DUT cannot be influenced. In the GAP mode, the bit pattern sent by the DUT is always a random sequence.

2.4.3.1 Menu CONNECTION ESTABLISHED

In this menu, a combined power/modulation measurement is performed. For this purpose, the CMD60 sends the data "00001110000111...", which are received and returned by the DUT (not in the GAP mode, see above). This type of signal is interpreted as "silence" by the converters.

The measured values are averaged over a number of bursts which can be set in the configuration menus POWER RAMP CONFIGURATION or 00RF - MODULATION.

The NTP (normal transmit power) is the power in dbm averaged over the DECT burst.

The frequency offset is obtained as the average of the demodulated signal over the B field for a selectable number of received bursts. Besides, the maximum and minimum modulation deviation is calculated that deviates from this average value.

The channel number and slot of the traffic bearer are displayed. Besides, the detected PMID of the PP under test appears in the PP-TEST. You may use this PMID in the FP test if the FP belonging to the PP does not accept any other PMID.

ADIT. MEAS.	CONNECTION ESTABLISHED		PP-TEST
POWER RAMP	Traffic Slot:	2	ESCAPE SEQUENCE
MODULATION	Traffic Carrier:	0	7000000000
TIMING	NTP:	24.0 dbm	Detected PMID: EA007
	Freq. Offset:	-2 KHZ	
	Max. +/- B-Field Modulation:	+326 KHZ	
		-324 KHZ	
BER			
			RF LEVEL
			-40.0 dbm
			BEARER RELEASE
			TRAFFIC SLOT
			2
			TRAFFIC CARRIER
			0
			BEARER RELEASE

Fig. 2.4-6 CONNECTION ESTABLISHED menu

If the call is released (eg due to interference from other DECT units or excessive path attenuation), this is indicated by the message "Poor Signal Quality" in the upper menu area. In this case, it is necessary to return to the menu SIGNALLING PP/FP-TEST (keys BEARER RELEASE or MENU UP) and set up the call again.

By changing the values for TRAFFIC SLOT and TRAFFIC CARRIER, the traffic bearer can be changed during the call setup. This is done in different ways for portable parts and fixed parts.

NOTE: In the GAP mode, CMD60 cannot perform a bearer handover.

With portable parts, the CMD60 sends the message "FORCE TRANSMIT" with the "keep-previous" bit section 2.5.2.1) should be set to ON. It must further be ensured that the settings for the dummy bearer reset. This causes the PP to clear down the old bearer and set up a new one. To maintain synchronization of the PP, the switch DUMMY IF TRAFFIC in the signalling configuration menu (see section 2.5.2.1) should be set to ON. It must further be ensured that the settings for the dummy bearer

and traffic bearer do not contradict each other (it is not permissible to use the same slots, nor different channel numbers for adjacent slots).

With fixed parts, the message "BEARER HANDOVER" is sent. This causes a second bearer to be set up and the previous bearer to be cleared down subsequently. If it is not possible to set up a new bearer while the previous one still exists (identical slots, or different channel numbers with adjacent slots), a brief changeover is made to an intermediate slot. This intermediate bearer is in the same channel as the original bearer and is placed in a slot that is spaced from the original bearer by an even number and is not occupied by the dummy bearer.

NOTE:

The described method of bearer changeover is not supported by all DECT systems. If "Poor Signal Quality" is displayed after an attempted changeover, this indicates that changeover was not successful. In case of doubt, the bearer can be changed by clearing down the existing call, changing the bearer parameters and setting up a new call.

NOTE ON REMOTE CONTROL:

In the remote control mode, a slot and channel change can be effected during a call (DCE status) by means of configuration commands (eg CONFIGURE:PP:TRAFfic:SLOT for changing the slot and CONFIGURE:PP:TRAFfic:CARRIER for changing the carrier).

The ADDITIONAL MEASUREMENTS menu is called (only with Option CMD-B41). In this menu, AF measurements can be performed (see sections 2.4.5 and 2.5.5).

ADDIT.
MEAS.

By pressing this softkey, the power ramp measurement is started. The menu changes to the display for this measurement.

POWER
RAMP

By pressing this softkey, the modulation measurement is started. The menu changes to the display for this measurement.

MODU-
LATION

By pressing this softkey, the timing measurement is started. the menu changes to the display for this measurement.

TIMING

By pressing this softkey, the bit error rate measurement is started. The menu changes to the display for this measurement.

BER

By pressing this softkey, the message displayed in hexadecimal format is sent as an MT message (MAC message). Messages can be set or modified with the hardkey CONFIG.

ESCAPE
SEQUENCE

This feature of the CMD60 permits the use of device-specific escape messages starting with number "7".

Test messages start with "2", "7", test escape messages with "24".

NOTE:

This softkey is not required for normal test operation. Incorrect MT messages may cause a call release.

Softkey for entry of slot number of traffic bearer for changing the slot during a call (see NOTE above).

TRAFfic
SLOT

Softkey for entry of channel number of traffic bearer for changing the channel during a call (see NOTE above).

TRAFfic
CARRIER

Setting of transmit power between -40 dBm and -100 dBm (referred to RF IN/OUT) in steps of 0.1 dB.

RF LEVEL

When this softkey is pressed, the CMD60 releases the call. It changes to the previous SIGNALING PP/FP-TEST menu, from where a new call can be set up.

BEARER RELEASE

2.4.3.2 Menu POWER RAMP

In this menu, the power ramp of a burst of the DUT is displayed as a function of time. The first bit of the burst (P0) derived from the modulation signal (not displayed) is used as the time reference. Bit P0 is derived with an accuracy of approx. 1/12 bit, ie approx. 0.075 µs.

The CMD60 uses "0000111100001111..." as transmit data. These data are received and returned by the DUT (not in the GAP mode, see above). This type of signal is interpreted as "silence" by the converters.

The NTP is averaged over a number of bursts selectable in the configuration menu POWER RAMP CONFIGURATION.

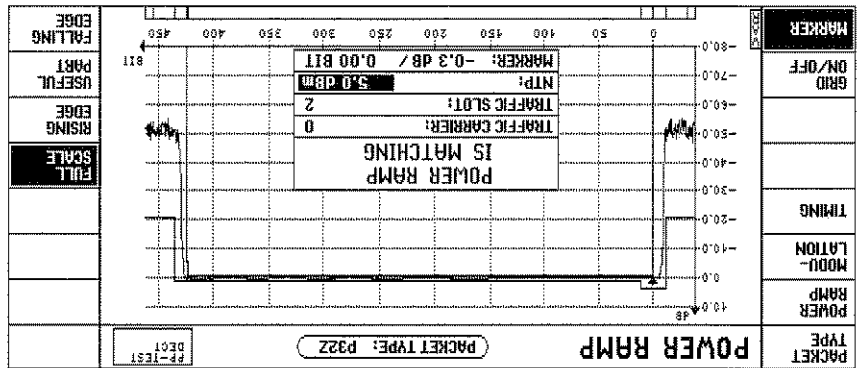

Fig. 2-4-7 Menu POWER RAMP

In this measurement menu, the display consists of the following items:

- Measurement curve showing the power ramp versus time.
- Tolerance mask. For the test to be successful, the measurement curve must not exceed the tolerance mask (power template) which is shown graphically. The tolerances can be entered in a configuration menu (see section 2.5.3.2). Depending on the type of measurement selectable in the configuration menu (HIGH DYNAMIC or LOW DYNAMIC), the limit values are used for the low power levels.
- Text. The traffic carrier, traffic slot and the power averaged over the burst (NTP) are indicated. Furthermore, an overall judgement indicates whether the power ramp measured always lies within the tolerance mask. Likewise, the marker coordinates are represented as bit number and relative power with respect to the NTP.
- Status bar. A bar in the bottom part of the menu indicates in which time segment the tolerance mask is exceeded.

The following packet types may be selected

PACKET TYPE

- P32
- P32Z
- PP32
- PP32Z

The (P)P32Z packet is identical to the (P)P32 packet, except that it has an extra four bits (the Z-field) appended which are a repeat of the last four bits of the P32 packet (the X-field). This test helps in the detection of collisions from multiple sources. In the PP32(Z) packet, 16 additional alternating bits (prolonged preamble) are sent before the first alternating 16 bits (preamble).

The default value after a system reset is P32Z.

The shape of the power ramp template shown on this menu changes according to the packet type selected.

POWER RAMP

Start of power ramp measurement in single-shot mode or after a stop caused by a tolerance being exceeded. Stop and start of measurement in continuous mode.

MODULATION

By pressing this softkey, the modulation measurement is started. The menu changes to the display for this measurement.

TIMING

By pressing this softkey the timing measurement is started. The menu changes to the display for this measurement.

GRID ON/OFF

This softkey is used to display a grid to facilitate reading of the measurement curve.

MARKER

After activation of this softkey, the marker position can be varied by turning the spinwheel or via a numerical entry in order to display the relative power with respect to the NTP.

FULL SCALE

Display of full power ramp (zoom function).

RISING EDGE

The rising edge of the burst is displayed (zoom function).

USEFUL PART

The part of the burst used for data transfer is displayed with higher resolution (zoom function).

FALLING EDGE

The falling edge of the burst is displayed (zoom function).

2.4.3.3 Menu RF MODULATION

In this menu, the demodulated signal of a burst of the DUT is displayed as a function of time. The first bit of the burst (P0) derived from the signal is used as the time reference.

The following patterns can be selected as transmit data:

- "FIG31": This data pattern is of interest for modulation measurement since it contains long sequences of successive "zeros" and "ones" (measurement of maximum modulation deviation) and since there is a sequence of alternating "zeros" and "ones" at the end. The latter is a prerequisite for performing drift measurements.
- "01010101": Data sequence with the smallest deviation.
- "00100111":
- "00001111": This data pattern is interpreted as "silence" by the converters (CODEC).
- "PSRBS": Pseudo-random bit sequence: random numbers similar to the data sent in real operation.
- "SPRBS": Static pseudo-random bit sequence: sequence of random numbers that is the same in all frames.

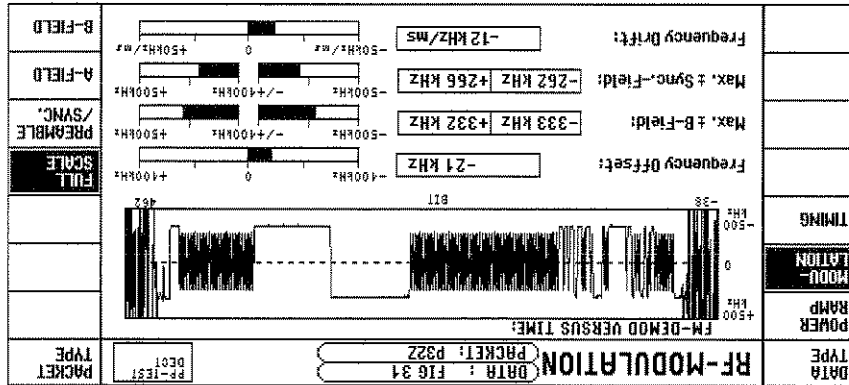

Fig. 2.4-8a Menu RF - MODULATION

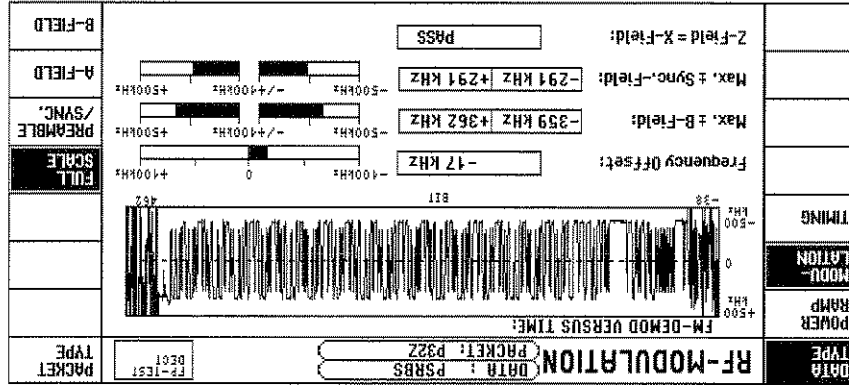

Fig. 2.4-8b Menu RF - MODULATION

The display in this measurement menu shows the graphical curve of the FM-demodulated signal of a burst of the DUT versus time. Below the curve, the following measured values are displayed as numerical values and as analog bars. The modulation pattern corresponds to the data bits sent to DUT and returned by it:

DESCRIPTION OF OPERATING MENUS

CMD60

- Frequency offset. It is obtained as the average of the demodulated signal over the B field for a selectable number of received bursts.

- Max. \pm B field modulation. The peak values of the modulation deviation measured over the B field that maximally and minimally deviate from the frequency offset.

- Max. \pm sync field modulation. The peak values of the modulation deviation measured over the S field (synchronization field) that deviate maximally and minimally from the frequency offset. The sync field consists of alternating "zeros" and "ones" (8 zeros and 8 ones) at the beginning of the burst.

- Frequency drift. The latter is obtained from the frequency that varies within a burst. The frequency drift can only be measured by means of data patterns ending with "zero-one sequences". These are: "FIG31" and "01010101".

Measurement of the frequency drift is performed as follows: The mean modulation deviation is formed each of the middle 14 bits of the 16 preamble bits and of the first 14 bits of the last 16 B field bits. The difference is multiplied by a constant, and the result is the frequency drift in kHz/ms.

NOTE:

This measurement is very sensitive to interference, therefore averaging should be performed over a large number of bursts. 200 bursts are recommended by the CTR06 specification.

- Z-field=X-field. This measurement compares the Z-field (the last four bits of a P32Z packet) with the previous four bits (the X-field) for each burst. If the X-field and Z-field are different for any burst within the number of bursts over which the other measurements are averaged, then the comparison fails. The Z-field=X-field comparison is only made for the "PSRBS" data type.

NOTE:

The Z-field=X-field test is only displayed when the data type is "PSRBS". The frequency drift measurement is only displayed when the data type is "FIG31" or "01010101".

The limit values for the measurement and the number of bursts over which the modulation values are to be averaged are entered in a configuration menu (see section 2.5.3.3).

DATA TYPE

Selection of data type used for modulation measurements.

POWER RAMP

By pressing this softkey, the power ramp measurement is started. The menu changes to the display for this measurement.

MODULATION

Start of the modulation measurement in single-shot mode or after a stop caused by a tolerance being exceeded. Stop and start of measurement in continuous mode.

TIMING

By pressing this softkey, the timing measurement is started. The menu changes to the display for this measurement.

FULL SCALE

Display of complete modulation characteristic (zoom function). The zoom function only affects the display, not the measurement itself.

PREAMBLE/ SYNC.

Display of preamble and of synchronization word (zoom function). The zoom function only affects the display, not the measurement itself.

Display of A field (zoom function). The zoom function only affects the display, not the measurement itself.



Display of B field (zoom function). The zoom function only affects the display, not the measurement itself.



The bit pattern sent by the DUT in the GAP mode is always a random sequence. Because of this, the frequency drift cannot be evaluated and displayed when modulation measurements are made. Apart from that, the modulation measurements and the RF MODULATION menu are as described above.

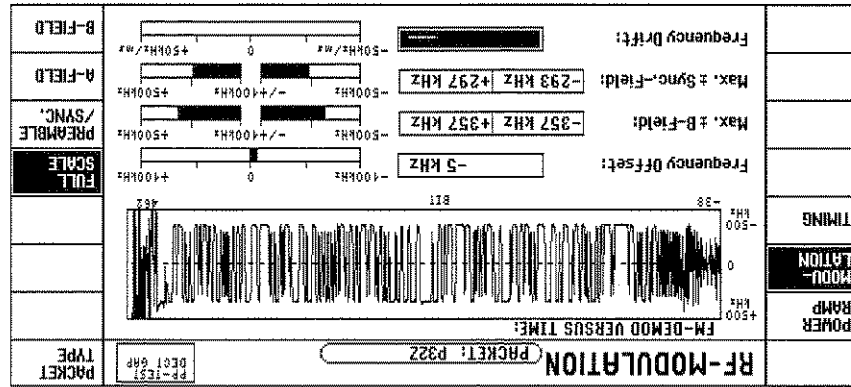

Fig. 2.4-8c Menu RF-MODULATION GAP-MODE

2.4.3.5 Menu BIT ERROR RATE

In contrast to the other tests, the bit-error-rate test is used for measuring the receiver of the DUT. The received bits are compared with the transmitted bits. The number of bits detected to be faulty compared to the number of all bits received yields the bit error rate (BER). However, if at least 25% of all bits of a frame are detected to be faulty, they are not considered in the BER, but in the frame error rate FER, which is the ratio of faulty frames to all frames.

NOTE:

Since the DUT does not return the received data, BER measurements are not possible in the GAP mode. A receiver measurement cannot therefore be performed.

The following data patterns can be selected:

- "FIG31" 128 bits with the pattern "01010101...", 64 bits "1", 64 bits "0", 64 bits with the pattern "010101..."
- "01010101" 320 bits with the pattern "01010101..."
- "00110011" 320 bits with the pattern "00110011..."
- "00001111" 320 bits with the pattern "00001111..."
- "PRBS" CCITT 0.153 pattern with the period $2^{11}-1$ in accordance with CTR06 (default)
- "SPRBS" Static pseudo-random bit sequence with the period 320, ie same sequence of random numbers for all frames

BIT ERROR RATE		DATA TYPE: PRBS		PP-TEST	
BER	Current BER:	0 ppm	RF LEVEL	-73.0 dBm	
	Current FER:	0 ppm	MULTI BEARER (Slots): 288 KHz		
	Longterm BER:	62 ppm	DEVIATION		
	Longterm FER:	0 ppm	RF LEVEL		
	Eval. Window	0	TEST SETUP:		
	Indicator:	4.00 %	EVAL. WINDOW: 100 * [320 bit] (1.00 s)		
	TEST IS RUNNING		STOP CONDITION: NONE		

Fig. 2.4-10 Menu BIT ERROR RATE

The displays "Current BER" and "Current FER" indicate current values, the displays "Longterm BER" and "Longterm FER" indicate values averaged for a time window (Evaluation Window) to be set in the configuration menu (see section 2.5.3.5). The bargraph of the "Evaluation Window Indicator" shows the time elapsed compared to the measurement time.

A special feature of the CMD60 is its capability of determining bit errors simultaneously in several time slots. Since the bit error rate measurement is one of the most time-consuming measurements, this feature is particularly important if only short measurement times are available.

The slots involved in the measurement are displayed in inverse video in the right half of the menu. They can be selected in the configuration menu. After leaving the configuration menu, a call setup for the other bearers is attempted. If the call setup fails, this is indicated by the fact that the bearer in question is not displayed in inverse video. All further slots use the channel number (carrier) of the traffic bearer. All of the six slots can be used in the PP TEST, and two in the FP TEST.

NOTE:
Not all DECT systems can set up and maintain calls to the same partner in several slots simultaneously.

For example, if two traffic bearers are set up and an FER of 50% is displayed, this indicates that a second slot can be set up (eg for the purpose of handover) but that this slot is not intended for data transmission.

If the dummy slot of an FP is maintained after the call setup, this may prevent a further bearer from being set up in the dummy slot and its adjacent slot.

Another window indicates the size of the time window, the resulting net measurement time and the stop condition for the measurement. These parameters can be set in the configuration menu (see section 2.5.3.5).

BER

Start of bit error rate measurement in single-shot mode or after a stop caused by a tolerance being exceeded. Stop and start of the measurement in continuous mode.

RF LEVEL

Setting of transmit power (also during a measurement) between -40 dBm and -100 dBm (referred to RF IN/OUT) in steps of 0.1 dB. By varying the transmitted power, the limit of sensitivity of the DUT receiver can be determined.

DEVIATION

For setting the transmitter frequency deviation. The transmitter deviation can take values in the range 0..510 kHz in steps of 2 kHz. The default value of the transmitter deviation is 288 kHz.

2.4.4 Module Test

In this mode, measurements on modules or DECT systems can be performed without call setup and signalling.

2.4.4.1 Menu BURST ANALYSIS

In this menu, a combined power/modulation measurement can be performed for investigating transmitter units. The time range for the measurements is determined by the parameters MEAS. WINDOW (time window), TRIGGER DELAY (delay of the measurement after the trigger event) and TRIGGER (selected trigger mode).

BURST ANALYSIS		ADDIT. MEAS. POWER VS. TIME MODULATION RF GEN.	
NTP: -49.6 dBm Freq. Offset: -27 KHZ Max. \pm Modulation: 523 KHZ Ext. Attenuation: 0.0 DB		USED RF INPUT: RF IN/OUT CONNECT/EXT. ATT.	
MEAS. WINDOW: 350 μ s TRIGGER DELAY: 0 μ s TRIGGER: FREE RUN		MODULATION: -476 KHZ FREQ. OFFSET: -27 KHZ MAX. \pm MODULATION: 523 KHZ EXT. ATTENUATION: 0.0 DB	
EXP. POWER: 24 dBm FREQ./RF CHAN.: 1897.344 MHZ MOD. REF.: MEASURED NOMINAL \pmPEAK/2		MEAS. WINDOW: 350 μ s TRIGGER DELAY: 0 μ s TRIGGER: FREE RUN	
HSB-TEST DECT		MEAS. WINDOW: 350 μ s TRIGGER DELAY: 0 μ s TRIGGER: FREE RUN	

Fig. 2.4-11 Menu BURST ANALYSIS

The following measured values are displayed:

- NTP
Average power for selected measurement window in dBm. Since the average power does not correspond to the average of the dBm values (logarithm), the high power values are preferably considered in an intelligent averaging procedure.
 - Frequency Offset
This value is obtained as the average of the demodulated signal in the measurement window. If the number of modulated "zeros" and "ones" is the same (eg with data pattern "010101"), the measured value corresponds to the frequency offset.
 - Max. \pm Modulation
The positive and negative peak values of the demodulated signal compared with the frequency offset. The measurement of the maximum positive and negative modulation requires a signal with an even distribution of "zeros" and "ones" in the measurement window.
- Moreover, the values set for the external attenuation are displayed in the menu.

ADDIT. MEAS.

The ADDITIONAL MEASUREMENTS menu is called up (only with Option CMD-B41). This menu permits AF measurements to be performed (see sections 2.4.5 and 2.5.5).

POWER VS. TIME

By pressing this softkey, the power measurement is started as a function of time. The menu changes to the display for this measurement.

MODULATION

By pressing this softkey, the modulation measurement is started within the module test. The menu changes to the display for this measurement.

Selection of RF SIGNAL GENERATOR menu for investigating receive units.

RF GEN.

This softkey is used for going to a configuration menu (see section 2.5.4.1) in which the RF connectors and correction values for external path attenuations can be entered. The selected values are displayed in the BURST ANALYSIS menu.

CONNECT/
EXT. ATT.

Setting of the maximum expected power between -10 dBm and 30 dBm in steps of 1 dB for fully utilizing the dynamic range of the test receiver of the CMD60.

EXP.
POWER

NOTE:
If a value below the power of the measured signal is selected, the measured NTP value is not correct.

Input of the frequency or channel number of the signal to be received. The frequency input is terminated with the key "MHz A", the channel number input with "dB D". Channel numbers between -3 and 12 at half the DECT channel spacing (864 kHz) are possible.

FREQ./
RF CHAN.

The reference frequency against which the modulation is measured can be selected. The values are:

MOD.
REF

- MEASURED. The mean frequency of the measured signal. This mode is also used in manual test (CTR06).
- NOMINAL. The exact centre frequency of the carrier, as selected by the user.
- \pm PEAK/2. The mid-point between the measured minimum and maximum measured peaks.

The default value is MEASURED.

Setting of discrete values between 25 μ s and 1000 μ s for the measurement window.

MEAS.
WINDOW

Setting of time values for the measurement delay after the trigger event from 0 to 10 ms in steps of 1 μ s. In the trigger mode FREE RUN, the value set for TRIGGER DELAY is irrelevant. TRIGGER DELAY also allows displaying the rising edge of a periodical signal triggered with the condition RISING SLOPE.

TRIGGER
DELAY

Selection of one of the following trigger modes:

TRIGGER

- FREE RUN. The measurement is restarted again and again without any trigger condition being present.
- RISING SLOPE. The measurement is started with rising power as the trigger event.
- EXTERNAL. The measurement is started with the rising edge of the signal EXT_TRIGGER at the 50-contact socket on the rear.

2.4.4.2 Menu POWER VERSUS TIME

In this menu, the power ramp versus time can be displayed. This type of measurement, too, can be used for testing transmitter units without requiring a call to be set up. The time range for the measurements is determined by the parameters MEAS. WINDOW (time window), TRIGGER DELAY (delay of the measurement after the trigger event) and TRIGGER (selected trigger mode).

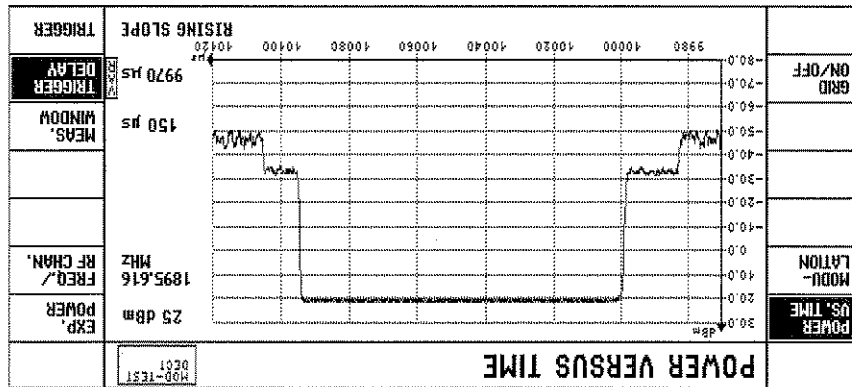

Fig. 2.4-12 Men POWER VERSUS TIME

By pressing this softkey, the measurement is stopped and continued again.

POWER VS. TIME

By pressing this softkey, the modulation measurement in the module test is started. The menu changes to the display for this measurement.

MODULATION

This softkey is used for displaying a grid to facilitate reading of the measurement curve.

GRID ON/OFF

Setting of the maximum expected power between -10 dbm and 30 dbm in steps of 1 dB for fully utilizing the dynamic range of the test receiver of the CMD60.

EXP. POWER

NOTE:
If a value below the power of the measured signal is selected, the measured curve is not correct.

FREQ./RF CHAN.

Input of the frequency or channel number of the signal to be received. The frequency input is terminated with the key "MHz A", the channel number input with "dB D". Channel numbers between -3 and 12 at half the DECT channel spacing (864 KHz) are possible.

MEAS. WINDOW

Setting of discrete values between 25 µs and 1000 µs for the measurement window. The selected value considerably influences the repetition rate of the measurement.

Setting of time values for the measurement delay after the trigger event from 0 to 10 ms in steps of 1 μ s. In the trigger mode FREE RUN, the value set for TRIGGER DELAY is irrelevant.

TRIGGER DELAY also allows displaying the rising edge of a periodical signal triggered with the condition RISING SLOPE.

Selection of one of the following trigger modes:

- **FREE RUN**
The measurement is restarted again and again without any trigger condition being present.
- **RISING SLOPE**
The measurement is started with rising power as the trigger event.
- **EXTERNAL**
The measurement is started with the rising edge of the signal EXTTRG at the 50-contact socket (pin 19) on the rear.

TRIGGER

TRIGGER DELAY

2.4.4.3 Menu RF - MODULATION

In this menu, the demodulated signal versus time can be displayed. This type of measurement, too, can be used for testing transmitter units without requiring a call to be set up. The time range for the measurements is determined by the parameters MEAS. WINDOW (time window), TRIGGER DELAY (delay of the measurement after the trigger event) and TRIGGER (selected trigger mode).

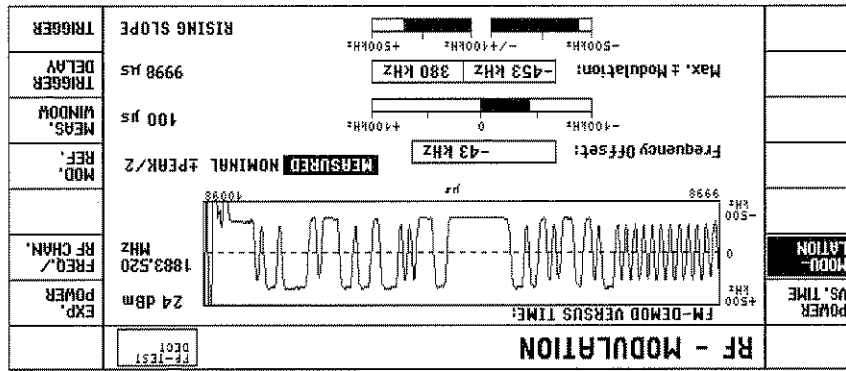

Fig. 2.4-13 Menu RF - MODULATION

The following measured values are displaced in addition to the measurement curve:

- **Frequency Offset**
This value is obtained as the average of the demodulated signal in the measurement window. To measure the frequency offset, a signal with an equal number of "zeros" and "ones" (eg "010101") is required.
- **Max. \pm Modulation**
The positive and negative peak values of the demodulated signal compared with the frequency offset. To measure the maximum positive and negative modulation, a signal with an even distribution of "zeros" and "ones" in the measurement window is required.

By pressing this softkey, the power measurement is started as a function of time. The menu changes to the display for this measurement.

POWER
VS. TIME

By pressing this softkey, the measurement is stopped and continued again.

MODU-
LATION

Setting of the maximum expected power between -10 dBm and 30 dBm in steps of 1 dB for fully utilizing the dynamic range of the test receiver of the CMD60.

EXP.
POWER

Input of the frequency or channel number of the signal to be received. The frequency input is terminated with the key "MHz A", the channel number input with "dB D". Channel numbers between -3 and 12 at half the DECT channel spacing (864 kHz) are possible.

FREQ./
RF CHAN.

The reference frequency against which the positive and negative modulations are measured may be selected. The values are:

MOD.
REF

- MEASURED. The mean frequency of the measured signal.

- NOMINAL. The exact centre frequency of the carrier, as selected by the user. This mode is also used in manual test (TBR06).

- \pm PEAK/2. The mid-point between the measured minimum and maximum measured peaks.

The default value is MEASURED. The graphical display is not influenced by this setting.

Setting of discrete values between 25 μ s and 1000 μ s for the measurement window. The selected value considerably influences the repetition rate of the measurement.

MEAS.
WINDOW

Setting of time values for the measurement delay after the trigger event from 0 to 10 ms in steps of 1 μ s. In the trigger mode FREE RUN, the value set for TRIGGER DELAY is irrelevant.

TRIGGER
DELAY

TRIGGER DELAY also allows displaying the rising edge of a periodical signal triggered with the condition RISING SLOPE.

Selection of one of the following trigger modes:

TRIGGER

- FREE RUN The measurement is restarted again and again without any trigger condition being present.

- RISING SLOPE The measurement is started with rising power as the trigger event.

- EXTERNAL The measurement is started with the rising edge of the signal EXT_TRIGGER at the 50-contact socket on the rear.

SIGNAL

Selection of one of the following modulation data patterns:

- CONST.ENVELOP (01010101) Non-pulsed signal with a modulation frequency of 576 kHz corresponding to the data sequence "01010101".
- CONST.ENVELOP (00110011) Non-pulsed signal with a modulation frequency of 288 kHz corresponding to the data sequence "00110011".
- CONST.ENVELOP (00001111) Non-pulsed signal with a modulation frequency of 144 kHz corresponding to a data sequence of "00001111".
- CONST.ENVELOP EXTERN Non-pulsed signal that can be modulated with an external signal via the TTL-compatible digital input T_DATA_IN (pin 20 of 50-pin multifunction connector).
- BURST (01010101) Pulsed signal with a modulation frequency of 576 kHz corresponding to the data sequence "01010101". The burst lasts approx. 370 µs and is repeated every 10 ms.
- BURST (00110011) Pulsed signal with a modulation frequency of 288 kHz corresponding to the data sequence "00110011". The burst lasts approx. 370 µs and is repeated every 10 ms.
- BURST (00001111) Pulsed signal with a modulation frequency of 144 kHz corresponding to the data sequence "00001111". The burst lasts approx. 370 µs and is repeated every 10 ms.
- BURST EXTERN Pulsed signal that can be modulated with an external signal via the TTL-compatible digital input T_DATA_IN (pin 20 of 50-pin multifunction connector). The burst lasts approx. 370 µs and is repeated every 10 ms.
- DECT BURST (01010101) DECT BURST signal consisting of sync word, preamble, CRC and A and B field modulation with the data sequence "01010101" (packet P32).
- DECT BURST (00110011) DECT BURST signal consisting of sync word, preamble, CRC and A and B field modulation with the data sequence "00110011" (packet P32).
- DECT BURST (00001111) DECT BURST signal consisting of sync word, preamble, CRC and A and B field modulation with the data sequence "00001111" (packet P32).
- DECT BURST (FIG31) DECT BURST signal consisting of sync word, preamble, CRC, A and B field modulation with the data sequence "01010101" and 64 bits of successive "ones" and 64 bits of successive "zeros" (packet P32).
- DECT BURST (PSRBS) DECT BURST signal consisting of sync word, preamble, CRC and A and B field modulation with random numbers (packet P32).
- DECT BURST (SPRBS) Pulsed DECT signal consisting of sync word, preamble, CRC and A and B field modulation with random numbers that are the same in each frame (packet P32).
- DECT BURST USER DATA DECT BURST signal consisting of sync word, CRC and user-definable contents of the preamble and the A and B fields (packet P32). If this type of signal is selected, softkey USER-DATA is displayed.

For an unmodulated signal, 0 must be entered for DEVIATION.

This softkey appears only if DECT BURST USER DATA is selected for SIGNAL. It allows user-defined values to be entered in hexadecimal format for the preamble and the A and B fields.

**USER
DATA**

Setting of the transmit power between -40 dBm and -100 dBm (referred to RF IN/OUT) in steps of 0.1 dB.

RF LEVEL

This softkey is used for going to a configuration menu in which the RF connectors and correction values for external path attenuations can be selected. The set values are displayed in the RF GENERATOR menu.

**CONNECT/
EXT. ATT.**

Recalling of up to seven stored settings of the signal generator. The settings are stored in the configuration menu (key CONFIG).

SETTING 1

SETTING 7
to

2.4.5 Additional Measurements (Option CMD-B41)

2.4.5.1 Menu ADDITIONAL MEASUREMENTS

The CMD60 with Option CMD-B41 includes a 60-MHz frequency counter, an AF voltmeter and an AF signal generator for measurements in the audio range. In addition, current and voltage measurements can be performed.

For current measurements, an offset can be defined that is added to the results (see section 2.5.5.1). This can be used for accurate zero adjustment. Furthermore, it allows results to be related to a reference value.

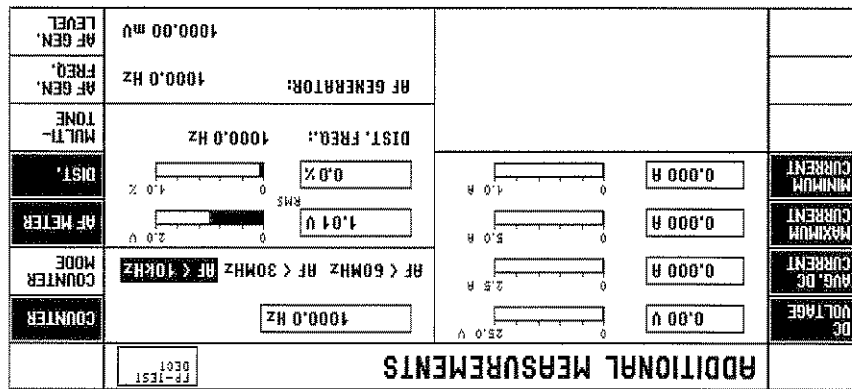

Fig. 2.4-15 Menu ADDITIONAL MEASUREMENTS

In the left half of the display, the results of current and voltage measurements are indicated. For these measurements, the DUT is connected to sockets I_{bc} and U_{bc} on the front of the unit. In current measurements, results are classified as maximum, minimum and average values. This is expedient since, with pulsed transmissions, current consumption varies at the rate of the pulse. This type of measurement is difficult to perform or not possible at all using conventional voltmeters.

Measured DC value (together with AVG. DC CURRENT, this value allows the actual thermal power consumption to be measured).

Average DC current (together with DC VOLTAGE, this value allows the actual thermal power consumption to be measured).

Maximum DC current (current consumption during active burst).

Minimum DC current (current consumption in the intervals between active bursts).

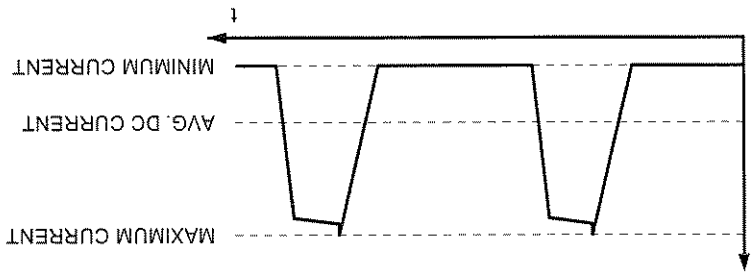

General information on current measurements:

The physical minimum and maximum values of the measured current is weighted. This results in a reversal of the displayed values if the polarity is reversed.

Example:

AVG. DC CURRENT	0.5A	-0.5A
MAXIMUM CURRENT	1.5A	0.3A
MINIMUM CURRENT	0.3A	-1.5A

For the display of the average value, a time constant matched to the frame clock is used. Unsynchronized current bursts may therefore cause a lag of the average measurement relative to the other two measurements. This does however not cause any measurement errors, ie the current consumption of the DUT is measured correctly.

COUNTER

Display of measured frequency.

COUNTER MODE

Selection of frequency counter mode for measurements up to 10 kHz (measurement time < 1 s), up to 30 MHz (measurement time 1 s) and up to 60 MHz (measurement time 2 s).

AF METER

Level measurement of input signals applied to socket AF VOLT.M.

DIST.

Distortion measurement of input signals applied to socket AF VOLT.M.

MULTI-TONE

Change to menu MULTITONE AUDIO ANALYSIS.

AF GEN. FREQ.

Setting of frequency of AF output signal at socket AF GEN.

AF GEN. LEVEL

Setting of level of AF output signal at socket AF GEN. The AF generator can be deactivated by pressing hardkey CLEAR OFF and switched on by pressing ENTER ON.

2.4.5.2 Menu MULTITONE AUDIO ANALYSIS (only with Options CMD-B41 and CMD-B44)

The Option CMD-B44 enables the simultaneous generation and analysis of up to 14 audio frequencies. This allows fast measurements as required for frequency response and intermodulation.

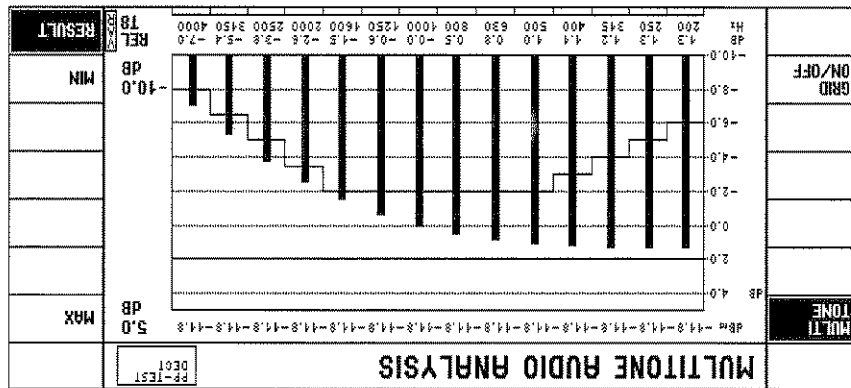

Fig. 2.4-16 Menu MULTITONE AUDIO ANALYSIS

The 14 tones can be varied in frequency and level largely independently of one another (for configuration see section 2.5.5). The total generator level must not exceed 5 V. For each level, upper and lower tolerance limits can be set. Measurements can be made in linear or logarithmic mode; logarithmic results can be indicated as absolute or relative values. Results are displayed as bars (see Fig. 2.4-16), tolerance limits as a staircase characteristic.

Above the bar diagram the generator levels are indicated in mV for linear and dBm for logarithmic representation. If a tone or tone generator is switched off for a measurement (see section 2.5.5), this is indicated by OFF.

NOTE: Settings in dBm are referred to a resistance of 600 Ω in audio measurements.

Below the bar diagram, results and frequencies are displayed in mV for linear representation, in dBm for absolute logarithmic and in dB for relative logarithmic representation. If a tone is switched off for a measurement (see section 2.5.5), this is indicated by OFF in the frequency line. Out-of-tolerance condition is indicated by the associated oblong rectangle at the bottom of the screen.

NOTE: The tone analyzers used for multitone measurement are coupled to the tone generators. Therefore, only the built-in tone generators may be used for this measurement. Phase shift and delay are taken into account in the measurement.

Each tone analyzer has zeroes spaced at 1-Hz intervals. This ensures that the tones do not interact with one another, which increases spectral purity.

Start of multitone measurement in single-shot mode or after a stop caused by a tolerance being exceeded. Stop and start of measurement in continuous mode.

MULTI
TONE

This softkey is used to display a grid to facilitate reading of the measurement curve.

GRID
ON/OFF

Selection of upper limit value of test diagram. The unit is *mV* for linear measurements, *dBm* for absolute logarithmic measurements and *dB* for relative logarithmic measurements.

MAX

Selection of a reference value for the display type REL REF under RESULT. The softkey REF appears only if RESULT is selected. The reference value can also be entered in *dBm* or converted into *dBm* by means of the keys for entering units.

REF

Selection of lower limit value of the diagram. The unit is *mV* for linear measurements, *dBm* for absolute logarithmic measurements and *dB* for relative logarithmic measurements.

MIN

Selection of display type. Possible settings are:

RESULT

- ABS LIN
Results are displayed on a linear scale as absolute values in *mV*.
- ABS LOG
Results are displayed on a logarithmic scale as absolute values in *dBm*.
- REL GEN
Results are displayed on a logarithmic scale as relative values in *dB* referred to the set generator level. A typical application of this display mode is measurement of the transmission characteristics of single frequencies. The display is correct even if different generator levels are selected (eg artificial mouth). If a generator is switched off (see section 2.5.5), the result is invalid.

- REL REF
Results are displayed on a logarithmic scale as relative values in *dB* referred to the value set under REF. The value set under REF may be the expected level, for example.
- REL T1 to REL T14
Results are displayed on a logarithmic scale as relative values in *dB* referred to the measured value of a selected reference tone 1 out of 14. The result for the selected reference tone is 0 *dB*. The measured values of the other tones are referred to the measured value of the reference tone. If the measured value of the reference tone is below 1 *mV*, all measured values are invalid. Typical applications are frequency response, intermodulation and harmonics measurements.

Use of Option CMD-B41 for DECT audio measurements

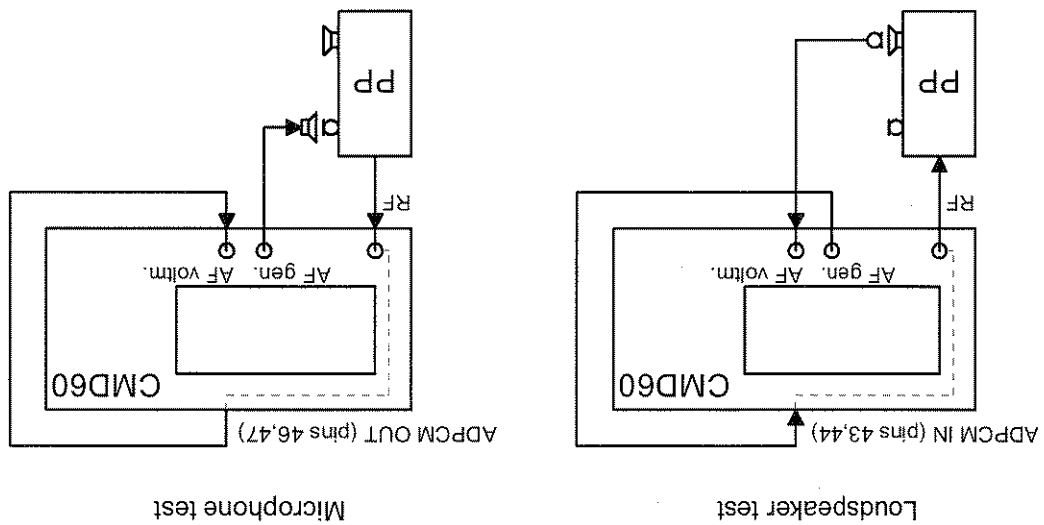

Fig. 2.4-17 DECT audio measurements

For performing these measurements, select the operating mode NORMAL in the menu SIGNALING PP-TEST (see section 2.4.2.1).

CMD60 from serial No. 841 236 offers the possibility of internal cabling from and to ADPCM.

2.5 Description of Configuration Menus

The following configurations can be made with these menus:

- Configuration of measuring instrument (eg selection of printer)
- Configuration of test setup with DUT (eg taking into account external attenuator pads between measuring instrument and DUT, for example)
- Configuration of measurement (eg setting of the data to be sent)
- Configuration of tolerance parameters. The preset tolerances correspond to the test specifications CTR06 for DECT systems. These values can be restored using the softkey DEFAULT VALUES.
- Information on configuration of CMD60 (menu OPTIONS)
- Help menus

Configuration menus can be called in two ways:

- Configuration main menu: from main menu with softkey CONFIG
- Other configuration menus: context-sensitive with hardkey CONFIG. Further configuration menus, if available, can be selected via further softkeys.

2.5.1 Configuration Main Menu

ADDIT. MEAS.		TX TEST	BER TEST	SIGN.	CONNECT/ EXT. ATT.	SYNC.
CONFIGURATION MENU		1				
DECT	IEEE ADDRESS	PRINTER	OPTIONS			

Fig. 2.5-1 Configuration main menu

The configuration menu for Af measurements is called up (only with Option CMD-B41).

Change to the configuration menus for transmitter tests, ie power ramp, modulation measurements and time measurements.

Change to the configuration menu for bit error rate measurements.

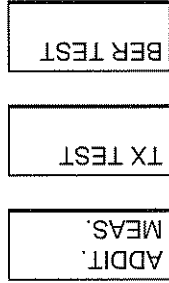

Change to the configuration menus for setting the signalling parameters. Depending on the test mode selected in the main menu (PP-TEST or FP-TEST), one of menus "SIGNALLING PP-TEST CONFIGURATION" or "SIGNALLING FP-TEST CONFIGURATION" is entered.

SIGN.

With this softkey a configuration menu can be called up in which the RF connectors and the correction values for external path attenuations can be entered.

CONNECT/
EXT. ATT.

Change to a configuration menu for selecting synchronization of the CMD60 to an external reference frequency or to another CMD60 (only PP-TEST), and for selecting a DECT output reference frequency.

SYNC.

Input of IEC/IEEE-bus remote-control address (with Options CMD-B6 and CMD-B61 fitted).

IEEE
ADDRESS

Change to printer configuration menu or selection of printer driver.

PRINTER

Change to an information menu for display of the built-in options and the software and firmware versions.

OPTIONS

2.5.2 Signalling Menus

2.5.2.1 Menu SIGNALLING PP-TEST CONFIGURATION

DEFAULT VALUES	SIGNALLING PP-TEST CONFIGURATION		PP-TEST	HELP
Q0 PROTO	000003FF0000			
Q3 PROTO	003041108008			
Q6 PROTO	006F0F000000			
Q6 PROTO	000000000000			
Q6 PROTO	03060306	ON OFF	SCRAMBLE	
		ON OFF	DUMMY IF TRAFFIC	
			CARRIER #	
			OFFSET	+0.0

Fig. 2.5-2 Menu SIGNALLING PP-TEST CONFIGURATION

When this softkey is pressed, the default values for this menu are used.

DEFAULT VALUES

Q0 PROTO

Prototype of Q0 packet. In the Q0 packet, the FP (CMD60 in this measurement mode) transmits static system information, eg supported DECT channels. The value can be entered in hexadecimal format. However, not all bits are transferred for signalling. Decoding of the individual bits can be requested using the softkey HELP (not to be confused with the hardkey KEY HELP). The transmission sequence of the Q packets is defined in the QMUX-TABLE.

NOTE:

Changing the preset value may cause the call setup to fail. It is normally not necessary to change this value.

Q3 PROTO

Prototype of Q3 packet. In the Q3 packet, the FP (CMD60 in this measurement mode) sends the features it supports, eg slot types and message types. The value can be entered in hexadecimal format. However, not all bits are transferred for signalling. Decoding of the individual bits can be requested using the softkey HELP (not to be confused with the hardkey KEY HELP). The transmission sequence of the Q packets is defined in the QMUX-TABLE.

NOTE:

Changing the preset value may cause the call setup to fail. It is normally not necessary to change this value.

Q6
PROTO

Prototype of Q6 packet. In the Q6 packet, the FP (CMD60 in this measurement mode) sends the number of the current multiframe. For DECT signalling, this packet is optional, it is however required by some portable parts. Not all bits are transferred for signalling. Decoding of the individual bits can be requested using the softkey HELP (not to be confused with the hardkey KEY HELP). The transmission sequence of the Q packets is defined in the QMUX-TABLE.

NOTE:

Changing the preset value may cause the call setup to fail. It is normally not necessary to change this value.

QE
PROTO

Prototype of another, user-selectable Q packet. Any desired packet can be formed by entering the associated number (eg Q5 packet). The transmission sequence of the Q packets is defined in the QMUX-TABLE.

NOTE:

Changing the preset value may cause the call setup to fail. It is normally not necessary to change this value. The user-selectable Q packet is intended only for products whose PPs require a further Q packet.

QMUX
TABLE

Entry of transmission sequence of Q packets used. If "0306030E" is entered for example, this means a periodic sequence of Q packets, ie Q0 - Q3 - Q0 - Q6 - Q0 - Q3 - Q0 - QE. "QE" represents the user-selectable Q packet. Since at least one Q0 packet and one Q3 packet are obligatory in DECT, the entry must contain at least one "0" and one "3".

NOTE:

Changing the preset value may cause the call setup to fail. It is normally not necessary to change this value.

HELP

Change to the help menus, which provide further information on entries for Q packets.

SCRAMBLE

Turn signal scrambling on or off. The default value when the DEFAULT key is pressed is off. Signal scrambling is only available in manual and remote test modes. Default is OFF.

DUMMY IF
TRAFFIC

Setting of the switch determining whether the dummy bearer is to be maintained after call setup. Some DECT systems require the dummy carrier to be maintained. This leads however to restrictions in the selection of additional slots for fast bit error rate measurements.

CARRIER #
OFFSET

Selection of value for CARRIER # OFFSET between -3 and +3 in steps of 0.5. To operate a larger number of test assemblies simultaneously and/or maintain telephone communication with DECT systems, the CMD60 offers the possibility of extended channels, ie channels going beyond the DECT frequency band. By varying the CARRIER # OFFSET value, the assignment of channel numbers to frequencies can be changed at half the DECT channel spacing (see assignment table 2.4-1 in section 2.4.2.1). Values for CARRIER # OFFSET unequal to zero are displayed in the menus SIGNALING PP-TEST and SIGNALING FP-TEST.

NOTE:

To make use of the facility of extended channels offered by the CMD60, the DUTs must be capable of performing the same channel/frequency assignment (exceeding the DECT frequency band). If the value for CARRIER # OFFSET is changed accidentally, this will cause the call setup to fail.

2.5.2.3 Menus SIGNALLING PP-TEST CONFIGURATION HELP

The following help menus support changing of the settings Q0 PROTO, Q3 PROTO, Q6 PROTO, QE PROTO and Q-MUX TABLE in the menu SIGNALLING PP-TEST CONFIGURATION.

SIGNALLING PP-TEST CONFIG. HELP

The following pages contain a description of the four editable Q-Packets and the Q-MUX Table.

Caution: You should be very careful with modifications. In case of wrong manipulations the signalling will not work!

Legend of the following tables:
 X: not changeable
 E: editable
 C: constant, must set to the default value
 -: no default value available

Note: Not each editable feature is supported by the test set.

Page 1

PAGE DOWN	PAGE UP
-----------	---------

Fig. 2.5-4 Menu SIGNALLING PP-TEST CONFIGURATION HELP, page 1

SIGNALLING PP-TEST CONFIG. HELP

Q0: STATIC SYSTEM INFO

Bits	X/E/C	Default-Value	Meaning
a0-a7	X	-	header
a8-a11	X	0000	slot-number
a12-a15	X	-	start-position
a16,a17	X	00	escape bit
a19,a20	X	00	number of transceivers
a21	X	0	extended RF carrier info
a22-a31	E	1111111111	RF carriers available
a32,a33	X	00	spare bits
a34-a39	X	-	carrier number
a40,a41	X	-	spare bits
a42-a47	X	-	primary receiver scan carrier number

Page 2

PAGE DOWN	PAGE UP
-----------	---------

Fig. 2.5-5 Menu SIGNALLING PP-TEST CONFIGURATION HELP, page 2

SIGNALLING PP-TEST CONFIG. HELP

Q3: FIXED PART CAPABILITIES

Bits	X/E/C	Default-Value	Meaning
a0-a7	X	-	header
a8-a11	X	0011	Q3 extended FP info (Q4)
a12	C	0	reserved
a13	C	0	reserved
a14	C	0	reserved
a15	C	0	double slot
a16	C	0	half slot
a17	C	1	full slot
a18	C	0	frequency control
a19	C	0	page reception
a20	C	0	C/B setup on dummy allowed
a21	C	0	C/L uplink
a22	C	0	C/L downlink

Page 3

PAGE DOWN	PAGE UP
-----------	---------

Fig. 2.5-6 Menu SIGNALLING PP-TEST CONFIGURATION HELP, page 3

Fig. 2-5-7 Menu SIGNALING PP-TEST CONFIGURATION HELP, page 4

Bits	X/E/C	Default-Value	Meaning
a23	E	1	basic A-field setup
a24	E	0	advanced B-field setup
a25	E	0	B-field setup
a26	E	0	CF messages
a27	E	1	IN minimum delay
a28	E	0	IN normal delay
a29	E	0	IP error detection
a30	E	0	IP error detection
a31	E	0	multibearer connections
a32	E	1	ADPCM/G.721 Voice service
a33	E	0	Public Access Profile supported
a34	E	0	Non-voice circuit switched service
a35	E	0	Non-voice circuit switched service

Q3: FIXED PART CAPABILITIES (cont.)

Page 4

SIGNALING PP-TEST CONFIG. HELP

PAGE UP

PAGE DOWN

Fig. 2-5-8 Menu SIGNALING PP-TEST CONFIGURATION HELP, page 5

Bits	X/E/C	Default-Value	Meaning
a36	E	0	Standard authentication required
a37	E	0	Standard ciphering supported
a38	E	0	Location registration supported
a39	E	0	STN service available
a40	E	0	Non-static Fixed Part
a41	E	0	CISS service available
a42	E	0	CLMS service available
a43	E	0	COMS service available
a44	E	1	Access Rights requests supported
a45	E	0	External handover supported
a46	E	0	Connection handover supported
a47	E	0	Reserved

Q3: FIXED PART CAPABILITIES (cont.)

Page 5

SIGNALING PP-TEST CONFIG. HELP

PAGE UP

PAGE DOWN

Fig. 2-5-9 Menu SIGNALING PP-TEST CONFIGURATION HELP, page 6

Bits	X/E/C	Default-Value	Meaning
a0-a7	X	-	header
a8-a11	C	0110	Q6
a12-a23	C	111100001111	spare bits
a24-a47	X	-	multiframe number

Q6: MULTI-FRAME NUMBER

Page 6

SIGNALING PP-TEST CONFIG. HELP

PAGE UP

PAGE DOWN

Bits	X/E/C	Default-Value	Meaning
a0-a7	X	-	header
a8-a11	E	-	Q-packet number
a12-a47	E	-	packet specific number

QE: OPTIONAL Q-PACKET

Page 7

Fig. 2.5-10 Menu SIGNALLING PP-TEST CONFIGURATION HELP, page 7

SIGNALLING PP-TEST CONFIG. HELP	
Q-MUX TABLE	
At maximum 8 digit sequence of Q-packets e.g. 03060306 (E means QE packet) Restriction: at minimum one Q0 and Q3 packet per sequence	
Page 8	
PAGE UP	
PAGE DOWN	

Fig. 2.5-11 Menu SIGNALLING PP-TEST CONFIGURATION HELP, page 8

Change to previous help menu.

Change to subsequent help menu.

To exit a help menu, press hardkey MENU UP.

Tolerance for the maximum absolute power of the DUT, averaged over a burst.

UPPER NTP

Number of bursts (1 to 1200) over which the NTP (normal transmit power) is averaged. The graphic display shows only one burst. The value set here is effective in the measurement menus CONNECTION ESTABLISHED, POWER RAMP and RF - MODULATION.

AVERAGE (BURSTS)

Selection of dynamic range:

DYNAMIC

- LOW
- Display of one burst. Tolerance A (see Fig. 2.5-13) cannot be checked.
- HIGH

Measurement and display of two bursts with different input sensitivity. Tolerance A (see Fig. 2.5-13) can be checked.

Selection of stop condition:

STOP COND.

- NONE
- The measurement is performed continuously.
- OUT OF TOL
- The measurement is stopped when a tolerance is exceeded.
- SINGLE SHOT
- Only one measurement is made.

Selection of tolerance for maximum absolute power up to 27 μ s prior to bit P0 and from 27 μ s after the end of the packet.

A (ABS.)

Selection of tolerance for maximum absolute power up to 10 μ s prior to bit P0 and from 10 μ s after the end of the packet.

B (ABS.)

Selection of tolerance for maximum relative power referred to NTP between 10 μ s prior to bit P0 and 10 μ s after bit P0.

C (REL.)

Selection of tolerance for maximum relative power referred to NTP between 10 μ s after bit P0 and 10 μ s after the end of the packet.

D (REL.)

Selection of tolerance value for minimum relative power referred to NTP between bit P0 and the end of the packet.

E (REL.)

Selection of tolerance for minimum relative power referred to NTP between the end of the packet and 0.5 μ s after the end of the packet.

F (REL.)

STOP COND.	<p>Selection of stop condition:</p> <ul style="list-style-type: none"> • NONE • The measurement is performed continuously. • OUT OF TOL • The measurement is stopped when a tolerance is exceeded. • SINGLE SHOT <p>Only one measurement is made.</p>
FREQ. OFFSET	<p>Selection of tolerance for minimum and maximum frequency offset.</p>
MIN. +/- B-FIELD	<p>Selection of tolerance for minimum frequency deviation, measured over the B field of received bursts.</p>
MAX. +/- B-FIELD	<p>Selection of tolerance for maximum frequency deviation, measured over the B field of received bursts.</p>
MIN. +/- S-FIELD	<p>Selection of tolerance for minimum frequency deviation, measured over sync field of received bursts.</p>
MAX. +/- S-FIELD	<p>Selection of tolerance for maximum frequency deviation, measured over sync field of received bursts.</p>
FREQ. DRIFT	<p>Selection of tolerance for maximum frequency drift within a received burst.</p>
F. DRIFT UNITS	<p>The units in which the frequency drift measurement and tolerance limits are displayed are selectable. The following units are available:</p> <ul style="list-style-type: none"> • KHz/ms • KHz/slot <p>When the unit KHz/slot is selected the displayed number is greater by the factor of 2.4.</p> <p>The DEFAULT VALUES softkey does not change this setting, however the default units after a system reset are KHz/ms. The default values for the frequency drift tolerance limit (after pressing the DEFAULT VALUES softkey) are:</p> <ul style="list-style-type: none"> • 13 KHz/ms (CTR06 first edition) • 15 KHz/slot (CTR06 second edition) <p>These values are <i>not</i> equivalent.</p> <p>For each of these units, the maximum values for the frequency drift tolerance limits are:</p> <ul style="list-style-type: none"> • 100 KHz/ms • 42 KHz/slot.

2.5.3.4 Menu TIMING CONFIGURATION

TIMING CONFIGURATION		LIMITS:		VALUES	
FP-TEST		5.0 ppm	TIME ACCURACY		
		1.0 μs	MAX. POS. JITTER		
		-1.0 μs	MAX. NEG. JITTER		
		2.0 μs	MAX. PCKT. DELAY		
		-2.0 μs	MIN. PCKT. DELAY		
				32	AVERAGE (BURSTS)
					STOP COND.
					NONE OUT OF TOL

Fig. 2.5-15 Menu TIMING CONFIGURATION

When this softkey is pressed, the default values for this menu are used. These values contain tolerances laid down in DECT Test Specification CTR06.

Number of bursts (2 to 100) over which the timing values are averaged.

Selection of stop condition:

- NONE
The measurement is performed continuously.
- OUT OF TOL
The measurement is stopped when a tolerance is exceeded.
- SINGLE SHOT
Only one measurement is made.

Selection of tolerance value for time accuracy. This is the accuracy of the time period in which the selected number of bursts is received referred to the time standard of the CMD60.

Selection of tolerance for maximum positive jitter. This is the maximum time interval between two successive bursts minus the average interval.

Selection of tolerance for maximum negative jitter. This is the minimum time interval between two successive bursts minus the average interval.

Selection of tolerance for maximum time interval between bursts of the CMD60 as FP and bursts of the FP under test minus 5 ms. This softkey is not provided in the FP-TEST.

Selection of tolerance for minimum time interval between bursts of the CMD60 as FP and bursts of the FP under test minus 5 ms. This softkey is not provided in the FP-TEST.

MIN.PCKT. DELAY

MAX.PCKT. DELAY

MAX.NEG. JITTER

MAX.POS. JITTER

TIME ACCURACY

STOP COND.

AVERAGE (BURSTS)

DEFAULT VALUES

2.5.3.5 Menu BIT ERROR RATE CONFIGURATION

BIT ERROR RATE CONFIGURATION	PRBS	UPPERLIMIT:	5000 ppm	CURRENT BER	5000 ppm	CURRENT FER	5000 ppm	CURRENT BER	1000 ppm	LONGTERM BER	1000 ppm	LONGTERM FER	1000 ppm	MULTI BEAMER
DEFAULT VALUES	PRBS													
DATA TYPE	PRBS													
EVAL. WINDOW	400 * 1320 BIT													
RESULT UNIT	PPM EXP													
STOP COND.	NONE													

Fig. 2.5-16 Menu BIT ERROR RATE CONFIGURATION

When this softkey is pressed, the default values for this menu are used. These values contain tolerances laid down in DECT Test Specification CTR06.

DEFAULT VALUES

The following data patterns can be selected:

DATA TYPE

- "FIG31" pattern "010101..."
- 128 bits with the pattern "010101...", 64 bits "1", 64 bits "0", 64 bits with the pattern "010101..."
- "01010101"
- 320 bits with the pattern "010101..."
- "00110011"
- 320 bits with the pattern "00110011..."
- "00001111"
- 320 bits with the pattern "00001111..."
- "PRBS"
- CCITT 0.153 pattern with the period $2^{11}-1$ in accordance with CTR06 (default)
- "SPRBS"

EVAL. WINDOW

Input of measurement window in bursts between 1 and 30 000 000 (one burst with 320 net bits per slot. Frames are repeated with a period of 10 ms).

RESULT UNIT

Display of result in ppm or in exponential notation.

Description of Configuration Menus

CMD60

Selection of stop condition: STOP COND.

- NONE

- EVAL. WINDOW ELAPSED
The measurement is stopped when the time of the measurement window has elapsed.

- UPPERLIMIT BER
The measurement is stopped when the tolerance for LONGTERM BER is exceeded.

- UPPERLIMIT FER
The measurement is stopped when the tolerance for LONGTERM FER is exceeded.

Selection of tolerance for maximum current bit error rate.

CURRENT BER

Selection of tolerance for maximum current frame error rate.

CURRENT FER

Selection of tolerance for maximum bit error rate averaged over the measurement window.

LONGTERM BER

Selection of tolerance for maximum frame error rate averaged over the measurement window.

LONGTERM FER

Selection of slots to be used for fast bit error rate measurement. After activating the softkey MULTI BEARER, the slot number is selected by means of the spinwheel and activated or deactivated with ENTER. The slot for the traffic bearer selected in menu SIGNALLING PP/FP-TEST cannot be deactivated. All selected slots use the channel number (carrier) of the traffic bearer. Adjacent slots cannot be used. Six slots can be used in the PP-TEST, two slots in the FP-TEST.

MULTI BEARER

NOTE:

Not all DECT systems can set up and maintain calls to the same partner in several slots simultaneously.

For example, if two traffic bearers are set up and an FER of 50% is displayed, this indicates that a second slot can be set up (eg for the purpose of handover), but that this slot is not intended for data transmission.

If the dummy slot of an FP is maintained after the call setup, this may prevent a further bearer from being set up in the dummy slot and its adjacent slot. If the CMD60 operates as FP (PP-TEST), the dummy bearer can be switched off in menu SIGNALLING PP-TEST CONFIGURATION (see section 2.5.2.1).

2.5.4 General Configuration Menus

2.5.4.1 Menu RF CONNECTOR/EXTERNAL ATTENUATION

RF CONNECTOR / EXT. ATTENUATION		RF IN/OUT	RF IN 1 / RF OUT 1	RF IN 2 / RF OUT 1	RF IN 2 / RF OUT 2
EXT. ATT. RF IN/OUT	0.0 dB	RF IN/OUT IN USE:	RF IN 1 / RF OUT 1	RF IN 2 / RF OUT 1	RF IN 2 / RF OUT 2
EXT. ATT. RF IN 2	0.0 dB	RF CONNECTOR IN USE:	RF IN 1 / RF OUT 2	RF IN 2 / RF OUT 2	
EXT. ATT. RF OUT 2	0.0 dB	RF IN/OUT (1)	RF IN 2 / RF OUT 2		

Fig. 2.5-17 Menu RF CONNECTOR/EXTERNAL ATTENUATION

The CMD60 has three RF connectors:

- a bidirectional input/output (RF IN/OUT)
- a sensitive input (RF IN 2)
- a high-level output (RF OUT2)

The three connectors cannot only be used alternately but also combined. There are four possible combinations. An attenuation can be entered into the CMD60 for each connector. The attenuation is taken into account in level settings and level measurements. Negative attenuation values have the effect of amplification.

With these four softkeys, one of the four possible input/output combinations is selected. The associated switch positions are shown in the figure below.

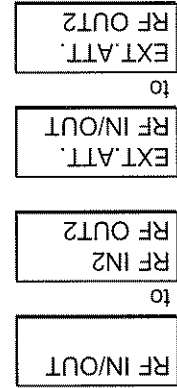

Selection of correction value for path attenuation between the CMD60 and the DUT at I/O connector RF IN/OUT. Negative values are intended for series-connected amplifiers, if any. The correction values are used, for example, for optimally using the dynamic range of the CMD60. They are further taken into account in level outputs and level measurements.

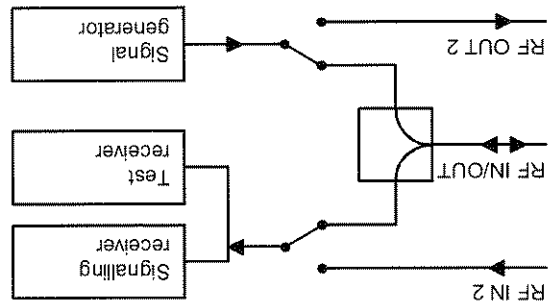

Fig. 2.5-18 Input and output circuitry

2.5.4.2 Menu SYNCHRONIZATION

SYNCHRONIZATION		PP-TEST DECT	
REF. FREQUENCY:	10 MHZ INTERN (= REF OUT 1)	REF. FREQ.	
	13.824 MHZ (board on REF. FREQ.)	REF. OUT 3	
	MASTER SLAVE	SYNC PORT	

Fig. 2.5-19 Menu SYNCHRONIZATION

REF. FREQ.

(only with Option CMD-B3)
 Selection of internal or external reference frequency of 10 MHz. All internal frequencies of the CMD60 are derived from this reference frequency.

NOTE:

If "10 MHZ EXTERN" is selected and no external reference is connected, attempts to set up a call may fail and measurements may produce incorrect results. This condition is indicated by a message in the upper status line of the menus SIGNALING PP-TEST and SIGNALING FP-TEST.

REF. OUT 3

Selection of a DECT frequency to be output at socket REF OUT 3 (rear panel). Possible values are: 13.824 MHz, 6.912 MHz, 3.456 MHz, 1.152 MHz, 576 KHz, 288 KHz or 144 KHz. These frequencies are derived from the internal or external 10-MHz reference frequency.

NOTE:

The output frequency of REF OUT 3 is undefined in the main menu and in menu RF SIGNAL GENERATOR.

SYNC PORT

If several CMD60 are operated in the PP-TEST (production line), they can be synchronized to one another. This allows simultaneous measurements on different slot/carrier pairs without the testers interfering with one another. To this end, the testers are interconnected via two differential lines connected to the 50-pin socket on the rear. One CMD60 operates as a MASTER, the others as SLAVES. The MASTER must change to the status SIGNALING PP-TEST before the SLAVES change to this status.

NOTE:

If "SLAVE" is selected accidentally and no master is connected, attempts to set up a call may fail and measurements may produce incorrect results. This condition is indicated by a message in the upper status line.

Example of master/slave operation of CMD60 (synchronized to DECT timing)

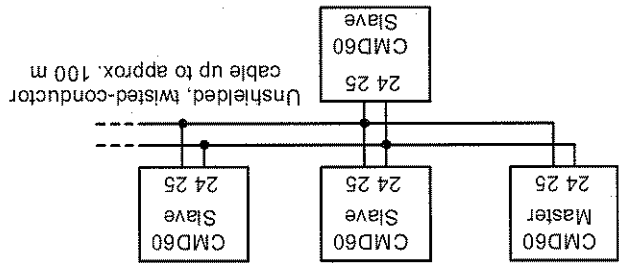

Fig. 2.5-20 Synchronization of several Testers CMD60

2.5.4.3 Menu PRINTER

Various setting for data printout can made in this menu:

- Selection of printer type
- Selection whether a hardcopy is made immediately or whether the drawing is first stored in a file.
- Selection whether the application report is printed immediately or whether it is first stored in a file.
- Selection of file name in which the hardcopy or application report can be stored. The name may include a number which is incremented each time a new file is created (auto increment).
- Files can be displayed before they are printed by the CMD.

PRINTER		PRINTER TYPE	Epson RX Series	FILE PRINT:	FILE TYPE	HARDCOPY
PRINT CHANNEL	INTERM	PRINT CHANNEL	INTERM	FILE NAME	PREV LINE	INTERM
PRINT CHANNEL	REPORT	FILE NAME	PRINT???	PREV LINE	NEXT LINE	PRINT???
PRINT CHANNEL	INTERM	FILE NAME	PROT???	PREV LINE	DELETE	PRINT???
PRINT CHANNEL	REPORT	FILE NAME	-----	DELETE	SHOW HARDCOPY	-----
PRINT CHANNEL	INTERM	FILE NAME	-----	DELETE	SHOW HARDCOPY	-----
PRINT CHANNEL	REPORT	FILE NAME	-----	DELETE	SHOW HARDCOPY	-----
PRINT CHANNEL	INTERM	FILE NAME	-----	DELETE	SHOW HARDCOPY	-----
PRINT CHANNEL	REPORT	FILE NAME	-----	DELETE	SHOW HARDCOPY	-----

Fig. 2.5-21a Menu PRINTER

PRINTER TYPE
Selection of printer type (relevant for hardcopy only).

Softkeys in the **HARDCOPY** field:
PRINT CHANNEL
Selection of print channel for hardcopy.

CENTRONICS CMD prints via the Centronics interface.
INTERM CMD prints into an internally generated file. The name of this file can be selected with the **FILE NAME** softkey.
MEMCARD CMD prints into a file generated on its memory-card drive. The name of this file can be selected with the **FILE NAME** softkey.

Entry of file name into which a hardcopy should be written. The general DOS rules apply for the file name. Groups of successive question marks in the file name are replaced by a numeral when the file is created. Counting starts at 0, if 0 already exists it is replaced by 1, an existing 1 is replaced by 2, etc. When the group of numerals is full, no more files can be created by the CMD.

Example:

Files PRINT000 to PRINT999 are created with FILE NAME in the PRINTER menu. If file PRINT999 already exists no more files can be created. Therefore, with the next hardcopy the CMD will write into the PRINT999 file, however not before asking the operator whether the existing file may be overwritten. In the Printer menu shown, files PRINT000 to PRINT004 already exist. The next hardcopy command on the print channel INTERN would create the file PRINT005. This softkey cannot be used if CENTRONICS has been selected under PRINT CHANNEL.

FILE NAME

Softkeys in the REPORT field:

PRINT CHANNEL

Selection of print channel for the different application reports.

CENTRONICS CMD directly prints onto the Centronics interface.

INTERN CMD prints into an internally created file. You may choose a name for this file with the FILE NAME softkey.

MEMCARD CMD prints into a file created on its memory-card drive. You may choose a name for this file with the FILE NAME softkey.

OFF CMD ignores all print commands.

Same as in the **HARDCOPY** field. This softkey cannot be used if **CENTRONICS** or **OFF** has been selected under **PRINT CHANNEL**.

FILE NAME

Softkeys in the FILEPRINT field:

Here the services are available which are required for selecting, displaying and printing the files generated for printing into the **INTERN** or **MEMCARD** channel.

Selection of report type.

FILE TYPE

AUTOTEST REPORT Files generated by the CMD during a DECT autotest.

HARDCOPY Files generated by the CMD when the **HARDCOPY** key is pressed.

Selection of file display.

SELECT SOURCE

INTERN CMD displays internally stored files.

MEMCARD CMD displays the files stored on the memory card.

The files selected with FILE TYPE are displayed at the right-hand side in the FILEPRINT field. The lines around a file name mark the currently displayed file and will in the following be referred to as file cursor:

Downward scroll in the displayed file list. The cursor remains in its original position.

PREV
LINE

Upward scroll in the displayed file list. The cursor remains in its original position.

NEXT
LINE

Clears the cursor-selected file.

DELETE

Display of cursor-selected file. Since the hardcopy display takes up the whole screen, all softkeys are disabled while the file is displayed. For printing the displayed file press the HARDCOPY key.

SHOW
HARDCOPY

This softkey is only available if HARDCOPY has been selected with FILE TYPE.

Display of cursor-selected file. To do so CMD changes to the REPORT menu.

SHOW
REPORT

This softkey is only available if AUTOTEST REPORT has been selected under FILE TYPE. The key is at the same location as the SHOW HARDCOPY softkey.

With the print channel set to internal, the user is asked upon pressing the hardkey HARDCOPY to confirm the file name. When ENTER is pressed the proposed name is used (? being replaced by corresponding numerals), STOP aborts the procedure, CLEAR allows editing of the file name. In this case the following menu is displayed.

PRINTER	PRINTER TYPE	Epson RX Series	FILE NAME	PRINT???	START PRINT				

Fig. 2.5-21b Menu PRINTER (for editing a file name)

Selection of printer type (relevant for hardcopy only).

PRINTER
TYPE

2.5.4.5 Menu SOFTWARE OPTIONS

In the SOFTWARE OPTIONS, the options are indicated that can be enabled by means of a code.

SOFTWARE OPTIONS	CODE NUMBER
	0
	1 CMD-K30 NDC/MTC (CMD54/57)
	1 CMD-K43 NARROW BAND RF SPECTRUM ANALYZER
	1 CMD-K54 CIPHERING (CMD54/57)
	1 CMD-K80 VIO (CMD54/57)
	1 CMD-K77 VIRTUAL PG
	1 CMD-B20 U/I MEASUREMENTS (CMD 50/53)
	1 CMD-B30 RF IN2 / RF OUT2 (CMD 50/53)
	1 CMD-B44 MULTITONE AUDIO ANALYSIS

Fig. 2.5-23 Menu SOFTWARE OPTIONS

Entry of code for enabling a software option.

CODE NUMBER

Selection of menu HARDWARE OPTIONS (see section 2.5.4.6).

HARDW. OPTIONS

2.5.4.6 Menu HARDWARE OPTIONS

In the menu HARDWARE OPTIONS, the hardware configuration of the CMD60, the software and firmware versions and the serial number of the unit are indicated.

Digital Radiocommunication Tester CMD	
MODEL: 60 M	SERIAL NO: 840675/018
SOFTWARE VERSION: X 3.00 02.05.96	
DECT FIRMWARE VERSION: B4.474 45.4.96	
INSTALLED OPTIONS:	
1	CMD-B4/2 00X0 REFERENCE OSCILLATOR
1	CMD-B3 MULTI-REFERENCE FREQUENCY IN/OUT
1	CMD-B8 TEST MOBILE FUNCTIONALITY (CMD 54/57)
1	CMD-B7 RB12 INTERFACE (CMD 54/57)
1	CMD-B9 2nd RF-SYNTHESIZER
1	CMD-B49 DCS 1900 (CMD 55/57)
1	CMD-B42 HIGH DYNAMIC BURST ANALYSIS
1	CMD-B43 SPECTRUM MEASUREMENT UNIT
1	CMD-B5 SPEECH CODEC
1	CMD-B6 ADAPTER FOR CMD-B6.. OPTIONS
1	CMD-B64 IEEE 488 BUS INTERFACE
1	CMD-B62 MEMORY CARD INTERFACE
5008 DYN. ATT. H.MEMS 8 MB CPU 3	

Fig. 2.5-24 Menu HARDWARE OPTIONS

2.5.4.7 Menu OTHER CONFIGURATION PARAMETERS

OTHER CONFIGURATION PARAMETERS		KEY BEEP ON <input checked="" type="checkbox"/>	ACUSTIC WARNINGS ON <input checked="" type="checkbox"/>	
DATE	24.02.97			
TIME	11:58			

Fig. 2.5-25 Menu OTHER CONFIGURATION PARAMETERS

Switches keyboard click on and off.

KEY BEEP

Switches acoustic warning on and off.

ACUSTIC WARNINGS

The date can be entered.

DATE

The time can be entered.

TIME

2.5.5 Configuration Menus for Additional Measurements

2.5.5.1 Menu ADDITIONAL MEASUREMENTS CONFIGURATION

For current measurements, an offset can be defined that is added to the results. This can be used for accurate zero adjustment. Furthermore, it allows results to be related to a reference value.

ADDITIONAL MEASUREMENTS CONFIGURATION							
		DC VOLTAGE	0.00 V				
		AVG. DC CURRENT	0.300 A			ZERO OFFSET	
						CURRENT OFFSET	
AF METER							
DIST.							
MULTI-TONE							
AF GEN. FREQ.							
AF GEN. LEVEL							

Fig. 2.5-26 Menu ADDITIONAL MEASUREMENTS CONFIGURATION

The last measured value of the actual average current consumption (ie without any offset correction) is taken as the offset for current measurements.

Entry of a user-selectable value as the offset for current measurements. If the hardkey CLEAR/OFF is pressed or if "0" is entered, no offset correction is performed.

Change to configuration menu for AF voltage measurements.

Change to configuration menu for distortion measurements.

Change to configuration menu for multitone measurements.

Change to configuration menu for AF generator

ZERO OFFSET

CURRENT OFFSET

AF METER

DIST.

MULTI-TONE

AF GEN.

AF GEN. FREQ.

AF GEN. LEVEL

2.5.5.2 Menu AF METER CONFIGURATION

AF METER CONFIGURATION		RMS	3400.0 Hz	BAND PASS	
		SQRT(2) * RMS	300.0 Hz	BAND WIDTH	
INPUT	AF VOLTM. ADPCM	will also change the Distortion Meter setting			
			100 Hz	LOWEST FREQ.	

Fig. 2.5-27 Menu AF METER CONFIGURATION

The AF voltmeter measures rms values.

RMS

The AF voltmeter measures rms values. However, the displayed value is weighted with a factor of 1.41 (corresponding to the peak value of a sine wave signal).

SQRT(2) * RMS

For Testers CMD60 with serial No. 841 236 and higher, this softkey allows the input of the AF voltmeter to be applied directly to the output of the ADPCM (see section 2.4.5).

INPUT

NOTE:

The internal ADPCM is addressed in the NORMAL mode only (see section 2.4.2.1).

NOTE:

This setting also changes the input for the distortion and the multitone measurements.

A bandpass filter can be connected in the signal path of the AF voltmeter to suppress ambient noise. After activating this softkey, the center frequency can be varied. The bandpass filter can be deactivated by pressing the hardkey CLEAR OFF and switched on again with ENTER ON.

BAND PASS

After activating this softkey, the bandwidth of the bandpass filter can be changed.

BAND WIDTH

Entry of the lowest AF frequency weighted without measuring error. High values reduce the measurement time.

LOWEST FREQ.

NOTE: This setting also changes the limit frequency for distortion measurements.

2.5.5.3 Menu DISTORTION METER CONFIGURATION

DISTORTION METER CONFIGURATION		DIST. FREQ.	1000.0 Hz
INPUT	RF VOLTM. ADPCM	will also change the RF Meter setting	
		100 Hz	LOWEST FREQ.

Fig. 2.5-28 Menu DISTORTION METER CONFIGURATION

Entry of the operating frequency for distortion measurements (center frequency of notch filter).

DIST. FREQ.

For Testers CMD60 with serial No. 841 236 and higher, this softkey allows the input of the AF voltmeter to be applied directly to the output of the ADPCM (see section 2.4.5).

INPUT

NOTE:
The internal ADPCM is addressed in the NORMAL mode only (see section).

NOTE:
This setting also changes the input of the voltmeter.

Entry of lowest AF frequency weighted without measuring error. High values reduce the measurement time.

LOWEST FREQ.

NOTE:
This setting also changes the limit frequency for distortion measurements.

2.5.5.4 Menu AF GENERATOR CONFIGURATION

AF GENERATOR CONFIGURATION		AF GEN. TO ADPCM	ON OFF	LEVEL INC.	FREQ. INC.
				10.00 mV	10.0 Hz

Fig. 2.5-29 Menu AF GENERATOR CONFIGURATION

AF GEN. TO ADPCM

For Testers CMD60 with serial No. 841 236 and higher, this softkey allows the output of the AF signal generator to be connected to the input of the internal ADPCM (see section 2.4.5). Any connections made to pins 43 and 44 of the 50-pin multifunction connector on the rear will then be ineffective.

NOTE:
The internal ADPCM is addressed in the NORMAL mode only (see section 2.4.2.1).

NOTE:
This setting also changes the AF generator.

FREQ. INC.

Entry of increment for varying the frequency of the AF generator by means of the spinwheel.

LEVEL INC.

Entry of increment for varying the level of the AF generator by means of the spinwheel.

The signal generator can be deactivated by pressing the hardkey CLEAR OFF and switched on again with ENTER ON.

2.5.5.5 Menu MULTITONE AUDIO ANALYSIS CONFIGURATION (only with Options CMD-B41 and CMD-B44)

In this menu, the settings for multitone measurements (see section 2.4.5.2) are made.

MULTITONE AUDIO ANALYSIS CONFIGURATION		DEFAULT	TONE INDEX	8	FREQ	1000 Hz	LEVEL	10 mV	LOWER LIM.(ABS)	12 mV	UPPER LIM.(ABS)	8 mV	LOWER LIM.(REL)	3 dB	UPPER LIM.(REL)	-3 dB	INPUT	RF VOLT., 80PCW	AF GEN. TO ADCPW	ON OFF	will also change RF GEN. and RF METER settings	NONE OUT OF TOL. SINGLE SHOT	STOP COND.	0 ms	AF GEN. LEAD	
--	--	---------	------------	---	------	---------	-------	-------	-----------------	-------	-----------------	------	-----------------	------	-----------------	-------	-------	-----------------	------------------	--------	--	------------------------------	------------	------	--------------	--

Fig. 2.5-30 Menu MULTITONE AUDIO ANALYSIS CONFIGURATION

When this softkey is pressed, the default values for this menu are used.

With TONE INDEX, the index of the tone is selected for which the frequency, level and tolerance limits are to be set. Indexes between 1 and 14 can be selected.

Setting of frequency for the tone selected under TONE INDEX. Integers between 50 and 8460 Hz can be selected. If the tone in question is not to be measured, ie if less than 14 tones are to be measured, the index can be switched off by pressing the hardkey OFF.

Setting of generator level for the tone selected under TONE INDEX. Values between 1 mV and 5 V can be selected. It should be noted however that the sum of the levels of all tones must not exceed 5 V. The generator can be switched off by pressing hardkey OFF. In contrast to switch-off performed under FREQ, a measurement takes place in this case.

Selection of stop condition:

- NONE
The measurement is performed continuously.
- OUT OF TOL
The measurement is stopped when a tolerance is exceeded.
- SINGLE SHOT
Only one measurement is performed.

STOP COND.

LEVEL

FREQ

TONE INDEX

DEFAULT

For Testers CMD60 with serial No. 841 236 and higher, this softkey allows the input for the multitone measurement to be applied directly to the output of the ADPCM.

INPUT

NOTE:

The internal ADPCM is addressed in the NORMAL mode only (see section

2.4.2.1).

NOTE:

This setting also changes the input for the other AF measurements.

Setting of upper tolerance limit for the tone selected under TONE INDEX for absolute measurements. Values between 1 mV and 9.999 V can be selected. The value must however be at least 1 mV above the lower tolerance limit. The value can also be entered in dBm or converted from or to dBm using the unit keys.

UPPER LIM.(ABS)

Setting of lower tolerance limit for the tone selected under TONE INDEX for absolute measurements. Values between 0 mV and 9.998 V can be selected. The value must however be at least 1 mV below the upper tolerance limit. The value can also be entered in dBm or converted from or to dBm using the unit keys.

LOWER LIM.(ABS)

Setting of upper tolerance limit for the tone selected under TONE INDEX for relative measurements. Values between -79 dB and +80 dB can be selected. The value must however be at least 1 dB above the lower tolerance limit.

UPPER LIM.(REL)

Setting of lower tolerance limit for the tone selected under TONE INDEX for relative measurements. Values between -80 dB and +79 dB can be selected. The value must however be at least 1 dB below the upper tolerance limit.

LOWER LIM.(REL)

Setting of lead time of generator until the start of the measurement. This lead allows filter transient times and delays in transmission to be taken into account. Values between 0 and 65 s can be selected in steps of 1 ms.

AF GEN. LEAD

For Testers CMD60 with Serial No. 841 236 and higher, the output of the multitone generator can be connected to the input of the internal ADPCM. The connections made to pins 43 and 44 of the 50-pin multifunction connector on the rear are in this case ineffective.

AF GEN. TO ADPCM

NOTE:

The internal ADPCM is addressed in the NORMAL mode only (see section

2.4.2.1).

NOTE:

This setting also changes the output of the AF generator.

2.6 Autotest

The autotest enables the automatic run of measurement steps without any remote control. There are 20 different autotests consisting of up to 50 freely configurable measurement steps referred to as actions. The actions are used for call setup and call clearing and for measurement steps. Log printouts may be generated either while the test is being performed or after completion of the test. After the autotest has been completed, it is indicated whether the actions have been carried out successfully or whether tolerances were exceeded. If Option CMD-B62 is fitted, transfer to other Testers CMD60 is possible via the memory card.

2.6.1 Menu AUTO TEST

The softkey AUTO TEST in the main menu is activated to branch into the AUTO TEST menu. In this menu, one of 20 autotests is selected, general report and test parameters are entered and the selected autotest is started. Besides, the menu is provided to branch into further menus for performance, configuration and copying of the tests.

SELECT	AUTO TEST	01: Auto Test 01	
DEVICE	<Device>		
TESTED	<Name>		
BY			
TEST LOCATION	<Location>		
COMPANY NAME	<Company>		
RFP	0000000000		
PMD	00000		
CONFIG.			
START			

Fig. 2.6-1 Menu AUTO TEST

After activating this softkey, one of 20 autotests is selected using the spinwheel.

Entry of report information either by means of a PC-AT keyboard connected to the rear panel or by means of the spinwheel in conjunction with the cursor keys START and LOCAL. This information is not specific for an autotest.

Branching to a menu for copying and deleting autotests.

SELECT
DEVICE
TESTED
BY
TEST LOCATION
SERIAL NO
COMPANY NAME
COPY

This indicates that a report is generated on the printer while the autotest is performed. The report can be switched off by pressing this softkey.

PRINT IS ON

This indicates that there is no report generated while the autotest is performed. The report can be switched on by pressing this softkey.

PRINT IS OFF

Entry of an RFP1 for the DECT unit under test. In case of an FP, automatic RFP1 identification and acceptance are possible (see section 2.6.4). The value set is displayed with the test report.

RFP1

Entry of a PMID for the DECT unit under test. With PP-TEST, it is used for logging only.

PMID

Branching to the configuration menu AUTO TEST EDIT, where the autotest is programmed. The CONFIG hardkey can be used alternatively.

CONFIG.

Starting the currently selected autotest.

START

2.6.2 Menu AUTO TEST EDIT

The AUTO TEST menu allows for branching into this menu by actuating the CONFIG softkey or hardkey. In this menu, the current autotest is programmed by selection of the actions.

AUTO TEST EDIT		01: Short PP Test	
REMOVE	Press "CONFIG" to change the setup.	08 FREE	
INSERT	QMUX TABLE: 03060306	07 FREE	
	QX PRTO: 0000000000	06 BEARER RELEASE	
	Q6 PRTO: 006F000000	05 BIT ERROR RATE	
	Q3 PRTO: 003041108008	04 TIMING	
	Q0 PRTO: 000003FF0000	03 RF MODULATION	
	DUMMY IF TRAFFIC: OFF	02 POWER RAMP	
	CARRIER OFFSET: +0.0	01 SETUP CONNECTION PP-TEST	
	TRAFFIC CARRIER: 0		
	DUMMY CARRIER: 0		
	TRAFFIC SLOT: 2		
	DUMMY SLOT: 0		
	RF LEVEL: -40.0 dbm		
	MODE: AUTO 5		
	SYNCH. TIME: L00BACK		
	SETUP CONNECTION PP-TEST CONFIG.:		

Fig. 2.6-2 Menu AUTO TEST EDIT

Entry of a name for the current autotest using either the PC-AT keyboard connected to the rear panel or the spinwheel in conjunction with the START and LOCAL keys used as cursor keys. Presetting of the name is "FREE" and, after programming, it is "Auto Test xx", xx indicating the autotest memory location.

NAME

Inserting a free action step prior to the current (framed) action.

INSERT

NOTE:

If the previous action is occupied, it is removed.

Action	Operation	For measurement see section	For configuration see section
FREE	none-is skipped		
SETUP CONNECTION PP-TEST	Call setup to a PP An existing connection is cleared	2.4.2.1	2.6.3
SETUP CONNECTION FP-TEST	Call setup to an FP An existing connection is cleared	2.4.2.2	2.6.4
POWER RAMP	Measurement of power and power ramp versus time	2.4.3.2	2.6.5
RF MODULATION	Measurement of modulation parameters	2.4.3.3	2.6.6
TIMING	Measurement of timing parameters	2.4.3.4	2.6.7
BIT ERROR RATE	Measurement of BER and FER	2.4.3.5	2.6.8
BEARER RELEASE	Clearing of the connection		
CONDITIONAL GOTO	Jump that can be linked to a condition		2.6.9
PAUSE	Breakpoint at which the program can be interrupted and continued by pressing a key		

The actions initiate the following operations:

REMOVE

Deleting of the current (framed) action. The subsequent actions move up by one position each.

Paging up the autotest by 14 actions (in the direction of step 01).

Selection of the previous step.

PREV. ACTION

Selection of an action for the current action step. The following actions may be selected:

FREE
SETUP CONNECTION PP-TEST
SETUP CONNECTION FP-TEST
POWER RAMP
RF MODULATION
TIMING
BIT ERROR RATE
BEARER RELEASE
CONDITIONAL GOTO
PAUSE

Each of these actions except for FREE, BEARER RELEASE and PAUSE can be configured upon actuating hardkey CONFIG.

Selection of next action step.

NEXT ACTION

Paging down the autotest by 14 action steps (in the direction of step 50).

PAGE DOWN

REMOVE

PAGE UP

PREV. ACTION

SELECT ACTION

NEXT ACTION

PAGE DOWN

Description of Autotest Menus

2.6.3 Menu SIGNALING PP-TEST CONFIGURATION

DEFAULT VALUES	SIGNALING PP-TEST CONFIGURATION		AUTOTEST DECT	HELP
B0	000003FF0000	ON	DECT	
D3	003041108008	0		
D6	006F0F000000	0		
D9	000000000000	2		
Q3	000000000000	2		
Q6	000000000000	2		
Q9	000000000000	2		
Q12	000000000000	2		
Q15	000000000000	2		
Q18	000000000000	2		
Q21	000000000000	2		
Q24	000000000000	2		
Q27	000000000000	2		
Q30	000000000000	2		
Q33	000000000000	2		
Q36	000000000000	2		
Q39	000000000000	2		
Q42	000000000000	2		
Q45	000000000000	2		
Q48	000000000000	2		
Q51	000000000000	2		
Q54	000000000000	2		
Q57	000000000000	2		
Q60	000000000000	2		
Q63	000000000000	2		
Q66	000000000000	2		
Q69	000000000000	2		
Q72	000000000000	2		
Q75	000000000000	2		
Q78	000000000000	2		
Q81	000000000000	2		
Q84	000000000000	2		
Q87	000000000000	2		
Q90	000000000000	2		
Q93	000000000000	2		
Q96	000000000000	2		
Q99	000000000000	2		
Q102	000000000000	2		
Q105	000000000000	2		
Q108	000000000000	2		
Q111	000000000000	2		
Q114	000000000000	2		
Q117	000000000000	2		
Q120	000000000000	2		
Q123	000000000000	2		
Q126	000000000000	2		
Q129	000000000000	2		
Q132	000000000000	2		
Q135	000000000000	2		
Q138	000000000000	2		
Q141	000000000000	2		
Q144	000000000000	2		
Q147	000000000000	2		
Q150	000000000000	2		
Q153	000000000000	2		
Q156	000000000000	2		
Q159	000000000000	2		
Q162	000000000000	2		
Q165	000000000000	2		
Q168	000000000000	2		
Q171	000000000000	2		
Q174	000000000000	2		
Q177	000000000000	2		
Q180	000000000000	2		
Q183	000000000000	2		
Q186	000000000000	2		
Q189	000000000000	2		
Q192	000000000000	2		
Q195	000000000000	2		
Q198	000000000000	2		
Q201	000000000000	2		
Q204	000000000000	2		
Q207	000000000000	2		
Q210	000000000000	2		
Q213	000000000000	2		
Q216	000000000000	2		
Q219	000000000000	2		
Q222	000000000000	2		
Q225	000000000000	2		
Q228	000000000000	2		
Q231	000000000000	2		
Q234	000000000000	2		
Q237	000000000000	2		
Q240	000000000000	2		
Q243	000000000000	2		
Q246	000000000000	2		
Q249	000000000000	2		
Q252	000000000000	2		
Q255	000000000000	2		
Q258	000000000000	2		
Q261	000000000000	2		
Q264	000000000000	2		
Q267	000000000000	2		
Q270	000000000000	2		
Q273	000000000000	2		
Q276	000000000000	2		
Q279	000000000000	2		
Q282	000000000000	2		
Q285	000000000000	2		
Q288	000000000000	2		
Q291	000000000000	2		
Q294	000000000000	2		
Q297	000000000000	2		
Q300	000000000000	2		
Q303	000000000000	2		
Q306	000000000000	2		
Q309	000000000000	2		
Q312	000000000000	2		
Q315	000000000000	2		
Q318	000000000000	2		
Q321	000000000000	2		
Q324	000000000000	2		
Q327	000000000000	2		
Q330	000000000000	2		
Q333	000000000000	2		
Q336	000000000000	2		
Q339	000000000000	2		
Q342	000000000000	2		
Q345	000000000000	2		
Q348	000000000000	2		
Q351	000000000000	2		
Q354	000000000000	2		
Q357	000000000000	2		
Q360	000000000000	2		
Q363	000000000000	2		
Q366	000000000000	2		
Q369	000000000000	2		
Q372	000000000000	2		
Q375	000000000000	2		
Q378	000000000000	2		
Q381	000000000000	2		
Q384	000000000000	2		
Q387	000000000000	2		
Q390	000000000000	2		
Q393	000000000000	2		
Q396	000000000000	2		
Q399	000000000000	2		
Q402	000000000000	2		
Q405	000000000000	2		
Q408	000000000000	2		
Q411	000000000000	2		
Q414	000000000000	2		
Q417	000000000000	2		
Q420	000000000000	2		
Q423	000000000000	2		
Q426	000000000000	2		
Q429	000000000000	2		
Q432	000000000000	2		
Q435	000000000000	2		
Q438	000000000000	2		
Q441	000000000000	2		
Q444	000000000000	2		
Q447	000000000000	2		
Q450	000000000000	2		
Q453	000000000000	2		
Q456	000000000000	2		
Q459	000000000000	2		
Q462	000000000000	2		
Q465	000000000000	2		
Q468	000000000000	2		
Q471	000000000000	2		
Q474	000000000000	2		
Q477	000000000000	2		
Q480	000000000000	2		
Q483	000000000000	2		
Q486	000000000000	2		
Q489	000000000000	2		
Q492	000000000000	2		
Q495	000000000000	2		
Q498	000000000000	2		
Q501	000000000000	2		
Q504	000000000000	2		
Q507	000000000000	2		
Q510	000000000000	2		
Q513	000000000000	2		
Q516	000000000000	2		
Q519	000000000000	2		
Q522	000000000000	2		
Q525	000000000000	2		
Q528	000000000000	2		
Q531	000000000000	2		
Q534	000000000000	2		
Q537	000000000000	2		
Q540	000000000000	2		
Q543	000000000000	2		
Q546	000000000000	2		
Q549	000000000000	2		
Q552	000000000000	2		
Q555	000000000000	2		
Q558	000000000000	2		
Q561	000000000000	2		
Q564	000000000000	2		
Q567	000000000000	2		
Q570	000000000000	2		
Q573	000000000000	2		
Q576	000000000000	2		
Q579	000000000000	2		
Q582	000000000000	2		
Q585	000000000000	2		
Q588	000000000000	2		
Q591	000000000000	2		
Q594	000000000000	2		
Q597	000000000000	2		
Q600	000000000000	2		
Q603	000000000000	2		
Q606	000000000000	2		
Q609	000000000000	2		
Q612	000000000000	2		
Q615	000000000000	2		
Q618	000000000000	2		
Q621	000000000000	2		
Q624	000000000000	2		
Q627	000000000000	2		
Q630	000000000000	2		
Q633	000000000000	2		
Q636	000000000000	2		
Q639	000000000000	2		
Q642	000000000000	2		
Q645	000000000000	2		
Q648	000000000000	2		
Q651	000000000000	2		
Q654	000000000000	2		
Q657	000000000000	2		
Q660	000000000000	2		
Q663	000000000000	2		
Q666	000000000000	2		
Q669	000000000000	2		
Q672	000000000000	2		
Q675	000000000000	2		
Q678	000000000000	2		
Q681	000000000000	2		
Q684	000000000000	2		
Q687	000000000000	2		
Q690	000000000000	2		
Q693	000000000000	2		
Q696				

Prototype of the Q6-packet. In the Q6-packet, the FP (in this measurement mode the CMD60) sends the number of the current multiframe. This packet is optional in the DECT signalling, however it is required by some portable parts. However, not all of the bits are transferred to the signalling. Decoding of the individual bits can be requested using the HELP softkey (not to be confused with the hardkey KEY HELP). The transmission sequence of the Y-packets is determined by the QMUX-TABLE.

NOTE:
Modification of the preset value may cause a failure of the call setup.
Normally, it is not necessary to change this value.

Prototype of any further Q-packet. This packet can be freely selected and any Q-packet can be formed by entering the corresponding value (eg a Q5-packet). The transmission sequence of the packets is determined by the QMUX-TABLE.

NOTE:
Modification of the preset value may cause a failure of the call setup.
Normally, it is not necessary to change this value. This possibility is only provided for products whose PPs require a further Q-packet.

Entry of the transmission sequence of the Q-packets used. The entry of "0306030E" eg implies a periodic sequence of Q-packets, ie: Q0 - Q0 - Q6 - Q0 - Q3 - Q0 - QE. "E" represents the freely selectable Q-packet. Since at least one Q0-packet and one Q3-packet are mandatory in DECT, the entry must contain at least one "0" and one "3" in each case.

NOTE:
Modification of the preset value may cause a failure of the call setup.
Normally, it is not necessary to change this value.

Entry of a time period for synchronization of the FP to the synchronization signal of the CMD60. Time values from 0 to 10 seconds can be selected in steps of one second. Besides, in the MANUAL setting, the successful synchronization can be indicated using the CONTINUE softkey. This key may also be used to shorten set synchronization times to the delay.

Q6
PROTO

QE
PROTO

QMUX
TABLE

SYNCH.
TIME

Different modes of connection are set:

MODE

- LOOPBACK: The DUT (Device Under Test) is set to the loopback mode in order to return the transmitted data without modification. This is the prerequisite for modulation and bit error rate measurements.

- NORMAL: The DUT converts the received data in the CODEC and passes them on to the loudspeaker. Signals recorded via the microphone are also converted and sent to the CMD60. This mode allows for performing audio measurements (microphone, loudspeaker, converter).

NOTE:
Not all portable parts permit audio connections in the test mode. Therefore, it may happen that NORMAL and ECHO modes do not have the desired result.

- ECHO: The signals applied to the microphone are sent to the CMD60, delayed by one second, returned to the DUT and output at its loudspeaker. This mode permits fast qualitative testing of the DUT.

NOTE:
Not all portable parts permit audio connections in the test mode. Therefore, it may happen that NORMAL and ECHO modes do not have the desired result.

Change to the help menus providing further information on the possible inputs of the Q-packets.

HELP

Setting of the switch to determine whether the dummy bearer is to be maintained after the call setup. A few DECT systems require the dummy carriers to be maintained. However, this leads to restrictions in the selection of additional slots in the case of the fast bit error rate measurement.

DUMMY IF TRAFFIC

Entry of slot number of dummy bearer to be transmitted. Values between 0 and 11 can be entered. Please note that the slot values of the dummy bearer and the traffic bearer must not be identical. Moreover, adjacent slot values (eg 5 and 6, or 11 and 0) are permissible only if the channel numbers of the dummy bearer and the traffic bearer are identical.

DUMMY SLOT

Entry of channel number of dummy bearer to be transmitted. Channel numbers between 0 and 9 can be entered. If the dummy bearer and the traffic bearer have adjacent slot numbers, the channel numbers of the dummy bearer and the traffic bearer must be identical.

DUMMY CARRIER

Entry of slot number of traffic bearer for call setup. Values between 0 and 11 can be entered. Please note that the slot values of the dummy bearer and the traffic bearer must not be identical. Moreover, adjacent slot values (eg 5 and 6, or 11 and 0) are permissible only if the channel numbers of the dummy bearer and the traffic bearer are identical.

TRAFFIC SLOT

Entry of channel number of traffic bearer for call setup. Channel numbers between 0 and 9 can be entered. If the slot numbers of the dummy bearer and the traffic bearer are adjacent, the channel numbers of the dummy bearer and the traffic bearer must be identical.

TRAFFIC CARRIER

Selection of transmit power between -40 dBm and -100 dBm (referred to RF IN/OUT) in steps of 0.1 dB.

RF LEVEL

Selection of value for CARRIER # OFFSET between -3 and +3 in steps of 0.5. To operate a larger number of test assemblies simultaneously and/or maintain telephone communication with DECT systems, the CMD60 offers the possibility of extended channels, ie channels going beyond the DECT frequency band. By varying the CARRIER # OFFSET value, the assignment of channel numbers to frequencies can be changed at half the DECT channel spacing (see table in section 2.4.2.1). Values for CARRIER # OFFSET unequal to zero are displayed in the menus SIGNALLING FP-TEST and SIGNALLING FP-TEST.

CARRIER # OFFSET

NOTE:
To make use of the facility of extended channels offered by the CMD60, the DUTs must be capable of performing the same channel/frequency assignment (exceeding the DECT frequency band). If the value for CARRIER # OFFSET is changed accidentally, this will cause the call setup to fail.

2.6.4 Menu SIGNALLING FP-TEST CONFIGURATION

DEFAULT VALUES	SIGNALLING FP-TEST CONFIGURATION		Autotest Dec1
MODE	LOOPBACK	NORMAL ECHO	
ACCEPT RFP1	ON	OFF	
ANTENNA	0		
TRAFFIC SLOT	0		
TRAFFIC CARRIER	0		
RF LEVEL	-40.0 dBm		
CARRIER #	+0.0		
DFTSET			

Fig. 2.6-4 Menu SIGNALLING FP-TEST CONFIGURATION

This softkey permits using the default values preset for this menu.

DEFAULT VALUES

Switch for switching on and off the automatic RFP1 identification and acceptance.

ACCEPT RFP1

Different modes of connection are set:

MODE

- LOOPBACK
The DUT (device under test) is set to the loopback mode in order to return the transmitted data without modification. This is the prerequisite for modulation and bit error rate measurements.
- NORMAL
The DUT converts the received data in the CODEC and passes them on to the loudspeaker. Signals recorded via the microphone are also converted and sent to the CMD60. This mode allows for performing audio measurements (converter).

NOTE:
Not all portable parts permit audio connections in the test mode. Therefore, it may happen that NORMAL and ECHO modes do not have the desired result. The NORMAL and ECHO modes are more useful with portable parts than with fixed parts.

- ECHO
The signals applied to the FP are sent to the CMD60, delayed by one second, returned to the DUT and output at its loudspeaker. This mode permits fast qualitative testing of the DUT.

NOTE:

Not all portable parts permit audio connections in the test mode. Therefore, it may happen that NORMAL and ECHO modes do not have the desired result. The NORMAL and ECHO modes are more useful with portable parts than with fixed parts.

Setting of the antenna number between 0 and 7 to be used by the FP under test. On call setup, the FP is requested to use the antenna with the number set in this menu.

ANTENNA

NOTE:
Setting of an antenna not provided on the FP or of an antenna with an excessive path attenuation to the CMD 60 may cause a call release

Entry of the slot number of the traffic bearer to be transmitted. Permissible values are 0 to 11, however, note that the slot values of dummy bearer and traffic bearer are not identical. Besides, adjacent slot values (eg 5 and 6; 11 and 0 are adjacent, also) are only permissible if the channel numbers of dummy bearer and traffic bearer are identical.

TRAFFIC SLOT

The FP under test must be able to set up a traffic bearer at the indicated slot value. Many FPs accept even slot values, only.

NOTE:
The values of the dummy slot may vary.

Entry of the channel number of the traffic carrier with call setup. Channel numbers from 0 to 9 are possible. If the slot values of *dummy* bearer and traffic bearer are adjacent, the channel numbers of *dummy* bearer and traffic bearer must coincide. The assignment of channel numbers to used frequencies is shown in Section 2.4.2.1.

TRAFFIC CARRIER

Setting of the transmit power from -40 dBm to -100 dBm (referred to RF IN/OUT) in steps of 0.1 dB.

RF LEVEL

Selection of the value for "CARRIER # OFFSET" between -3 to +3 in steps of 0.5. To enable simultaneous operation of a larger number of test assemblies and/or to maintain the telephone operation with DECT systems the CMD 60 offers the possibility of using extended channels. By varying this value, it is possible to change the assignment of the channel numbers to the frequencies in half the DECT channel spacing (see assignment table in Section 2.4.2.1). This is an extension to DECT. Values for "CARRIER # OFFSET" unequal to zero are displayed in the SIGNALLING PP-TEST and SIGNALLING FP-TEST menus.

CARRIER # OFFSET

NOTE:
The extended channels of the CMD60 can be used only, if the devices under test are able to perform the same channel/frequency assignment (exceeding DECT). If a value for "CARRIER # OFFSET" is changed accidentally, this will cause a failure of the call setup.

2.6.5 Menu POWER RAMP CONFIGURATION

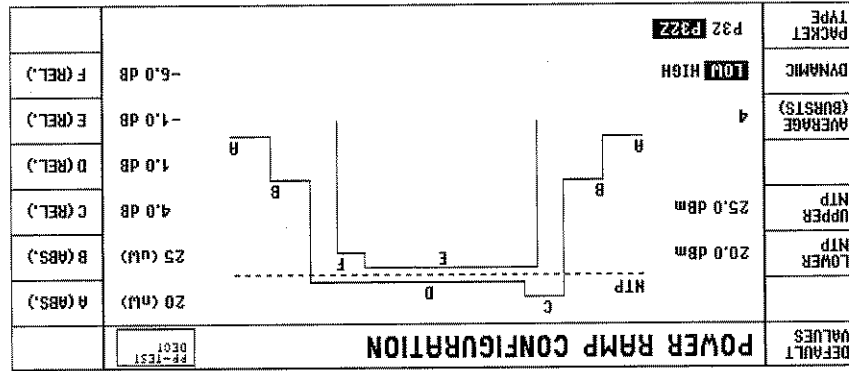

Fig. 2.6-5 Menu POWER RAMP CONFIGURATION

This softkey permits using the preset default values for the tolerance values according to the DECT test specification CTR06.

Tolerance value for the minimum absolute power of the DUT, averaged over one burst.

Tolerance value for the maximum absolute power of the DUT, averaged over one burst.

Number of bursts (1 to 200), over which the NTP value is averaged. The graphical display shows one burst only.

Selection of dynamic range:

- LOW
Display of a burst. The tolerance value A (see Fig. 2.5-13) cannot be checked.
- HIGH
Measurement and combined display of two bursts with different input sensitivity. The tolerance value A (see Fig. 2.5-13) can also be checked.

The following packet types may be selected

- P32.
- P32Z.

The P32Z packet is identical to the P32 packet, except that it has an extra four bits (the Z-field) appended which are a repeat of the last four bits of the P32 packet (the X-field). This test helps in the detection of collisions from multiple sources.

The default value after a system reset is P32Z.

The shape of the power ramp template changes according to the packet type selected.

Selection of the tolerance value for the maximum absolute power up to 27μs before bit P0 and from 27μs after the end of the packet.

DEFAULT VALUES

LOWER NTP

UPPER NTP

AVERAGE (BURSTS)

DYNAMIC

PACKET TYPE

A (ABS.)

B (ABS.)	Selection of the tolerance value for the maximum absolute power up to 10µs before bit P0 and from 10µs after the end of the packet.
C (REL.)	Selection of the tolerance value for the maximum relative power referred to the NTP between 10µs before bit P0 and 10µs after bit P0.
D (REL.)	Selection of the tolerance value for the maximum relative power referred to the NTP between 10µs after bit P0 and 10µs after the end of the packet.
E (REL.)	Selection of the tolerance value for the minimum relative power referred to the NTP between bit P0 and the end of the packet.
F (REL.)	Selection of the tolerance value for the minimum relative power referred to the NTP between the end of the packet and 0.5µs after the end of the packet.

Description of Autotest Menus **CMD60**

STOP COND.	<p>Selection of stop condition:</p> <ul style="list-style-type: none"> • NONE • The measurement is performed continuously. • OUT OF TOL • The measurement is stopped when a tolerance is exceeded. • SINGLE SHOT <p>Only one measurement is made.</p>
FREQ. OFFSET	<p>Selection of the tolerance value for the minimum and maximum frequency offset.</p>
MIN. +/- B-FIELD	<p>Selection of the tolerance value for the minimum frequency deviation, measured over the B-field of received bursts.</p>
MAX. +/- B-FIELD	<p>Selection of the tolerance value for the maximum frequency deviation, measured over the B-field of received bursts.</p>
MIN. +/- S-FIELD	<p>Selection of the tolerance value for the minimum frequency deviation measured over the sync field of received bursts.</p>
MAX. +/- S-FIELD	<p>Selection of the tolerance value for the maximum frequency deviation measured over the sync field of received bursts.</p>
FREQ. DRIFT	<p>Selection of the tolerance value for the maximum frequency drift within a received burst.</p>
F. DRIFT UNITS	<p>The units in which the frequency drift measurement and tolerance limits are displayed are selectable. The following units are available:</p> <ul style="list-style-type: none"> • KHz/ms • KHz/slot <p>When the unit KHz/slot is selected the displayed number is greater by the factor of 2.4.</p> <p>The DEFAULT VALUES softkey does not change this setting, however the default units after a system reset are KHz/ms. The default values for the frequency drift tolerance limit (after pressing the DEFAULT VALUES softkey) are:</p> <ul style="list-style-type: none"> • 13 KHz/ms (CTR06 first edition) • 15 KHz/slot. (CTR06 second edition) <p>These values are <i>not</i> equivalent.</p> <p>For each of these units, the maximum values for the frequency drift tolerance limits are:</p> <ul style="list-style-type: none"> • 100 KHz/ms • 42 KHz/slot.

2.6.7 Menu TIMING CONFIGURATION

DEFAULT VALUES	TIMING CONFIGURATION		AUTOTEST DECT
	LIMITS:		
	5.0 ppm	TIME ACCURACY	
	1.0 μ s	MAX. POS. JITTER	
	-1.0 μ s	MAX. NEG. JITTER	
	2.0 μ s	MAX. PCKT. DELAY	
	-2.0 μ s	MIN. PCKT. DELAY	
AVERAGE (BURSTS)	32		

Fig. 2.6-7 Menu TIMING CONFIGURATION

DEFAULT VALUES

This softkey permits using the preset default values for the tolerance values according to the DECT test specification CTR06.

AVERAGE (BURSTS)

Number of bursts (2 to 100), over which the time values are averaged.

Selection of the tolerance value for the time accuracy. This is the accuracy which the required number of bursts has been received in referred to the time standard of the CMD60.

TIME ACCURACY

Selection of the tolerance value for the maximum jitter. This is the maximum time interval of two successive bursts minus the average interval.

MAX. POS. JITTER

Selection of the tolerance value for the minimum jitter. This is the minimum time interval of two successive bursts minus the average interval.

MAX. NEG. JITTER

Selection of the tolerance value for the maximum time interval between bursts of the CMD60 as FP and bursts of the PP under test minus 5 ms. This softkey is not provided in the FP TEST.

MAX. PCKT. DELAY

Selection of the tolerance value for the minimum time interval between bursts of the CMD60 as FP and bursts of the PP under test minus 5 ms. This softkey is not provided in the FP TEST.

MIN. PCKT. DELAY

2.6.8 Menu BIT ERROR RATE CONFIGURATION

DEFAULT VALUES	BIT ERROR RATE CONFIGURATION	RF-TEST
DATA TYPE	PSRBS	UPPERLIMIT:
DEVIATION	288 KHZ	
EVAL. WINDOW	100 * 1320 B14] (0.50 s)	
RESULT UNIT	PPM EXP	Select additional beavers?
		0 1 2 3 4 5 6 7 8 9 10 11
		LONGTERM BER 1000 ppm
		LONGTERM FER 10000 ppm
		RF LEVEL -73.0 dbm
		MULTI BEAVER

Fig. 2.6-8 Menu BIT ERROR RATE CONFIGURATION

This softkey permits using the preset default values for the tolerance values according to the DECT test specification CTR06.

DEFAULT VALUES
DATA TYPE

The following data patterns can be selected:

- "FIG31"
128 bits with the pattern "010101...", 64 bits "1", 64 bits "0", 64 bits with the pattern "010101..."
- "01010101"
320 bits with the pattern "010101..."
- "00110011"
320 bits with the pattern "00110011..."
- "00001111"
320 bits with the pattern "00001111..."
- "PRBS"
CCITT O.153 bit sequence with the period 2¹¹-1 in accordance with CTR06 (default)
- "SPRBS"
Pseudo-random bit sequence with the period 320

For setting the transmitter frequency deviation. The transmitter deviation can take values in the range 0...510 KHZ in steps of 2 KHZ. The default value of the transmitter deviation is 288 KHZ.

DEVIATION

Entry of measurement window in bursts between 1 and 30 000 000 (one burst with 320 bits per slot. Frames are repeated with a period of 10 ms).

EVAL. WINDOW

Display of result in PPM or in exponential notation.

RESULT UNIT

Selection of tolerance for maximum bit error rate averaged over the measurement window.

LONGTERM BER

Selection of tolerance value for maximum frame erasure rate average over the measurement window.

LONGTERM FER

Setting of the transmit power from -40 dBm to -100 dBm (referred to RF IN/OUT) in steps of 0.1 dB even during the measurement. By varying the transmit power, the sensitivity limit of the receiver of the DUT can be determined.

RF LEVEL

Selection of **additional** slots to be used for fast bit error rate measurement. After activating the softkeys MULTI BEARER, the slot number is selected by means of the spinwheel and activated or deactivated with ENTER. All selected slots use the channel number (carrier) of the traffic bearers. Five additional slots can be used in the PP-TEST, one slot in the FP-TEST. Adjacent slots cannot be used.

MULTI BEARER

NOTE:
Not all DECT systems can set up and maintain calls to the same partner in several slots simultaneously.

For example, if two traffic bearers are set up and an FER of 50% is displayed, this indicates that a second slot can be set up (eg for the purpose of handover), but that this slot is not intended for data transmission.

If the dummy slot of an FP is maintained after the call setup, this may prevent a further bearer from being set up in the dummy slot and its adjacent slot. If the CMD60 operates as FP (PP-TEST), the dummy bearer can be switched off in menu SIGNALING PP-TEST CONFIGURATION (see section 2.5.2.1.).

2.6.9 Menu CONDITIONAL GOTO CONFIGURATION

CONDITIONAL GOTO CONFIGURATION		LINE NUMBER	CONDITION
		1	N
		2	IF FAILED

Fig. 2.6-9 Menu CONDITIONAL GOTO CONFIGURATION

The CONDITIONAL GOTO action is a powerful tool for the implementation of loops and jumps such as:

- Endless loops for long-term tests
- Jumps for the repetition of measurements with modified tolerance settings for the categorization of DUTs
- Repeated attempt of call setup if PP has not synchronized in order to avoid long waiting times
- Repeated attempt of call setup to an FP in another slot if call setup was not possible due to the dummy bearer of the FP
- Determination of receiver sensitivity through successive adaptation of power levels in BER test
- Reduction of measurement time for BER measurements if no bit errors have been found after a short test time so as to perform a random sample test

LINE NUMBER

N

CONDITION

Entry of jump address. The jump address is retained through automatic adaptation if actions are inserted or deleted.

Loop counter for jump condition "N TIMES".

Jump condition. The following conditions can be selected:

- ALWAYS
- Unconditional jump
- IF FAILED
- The jump is executed only if at least one result of the previous measurement is out of tolerance. Otherwise the program continues with the next action.
- IF PASSED
- The jump is executed only if all results of the previous measurement are within tolerances. Otherwise the program continues with the next action.
- N TIMES
- The jump is executed as many times as defined in field "N". Then the program continues with the next action.

This softkey is used to print out the test report. More copies can thus be generated.

This softkey is used to enter the DISPLAY RESULTS menu (see section 2.6.12) to enable paging in the test report.

DISPLAY RESULTS

PRINT RESULTS

Fig. 2.6-11 Menu AUTO TEST End

AUTO TEST 01: Short PP Test		DEVICE: Five Tons PP	PRINT RESULTS
		SERIAL NO: 39500373097	DISPLAY RESULTS
		RFFI: 6162636465	
		PMID: 00000	
TEST OK			
ALL MEASUREMENTS IN TOLERANCE			
PRINT IS OFF			
STOP PRINTING			
RESTART			

2.6.11 Menu AUTO TEST End

This softkey is displayed only during the call setup with a PP. The autotest continues if the PP indicates successful synchronization to the dummy bearer. If an automatic waiting time has been configured, the latter can be reduced.

CONTINUE

Abortion of the running autotest.

ABORT

Fig. 2.6-10 Menu AUTO TEST Active

AUTO TEST 05: Auto Test 05		Pos B-Field [1259,+403] : +288 kHz OK	ABORT
		Neg B-Field [1403,-259] : -289 kHz OK	
		Pos Sync-Field [1202,+403] : +241 kHz OK	
		Neg Sync-Field [1403,-202] : -250 kHz OK	
		(04) BEARER RELEASE	
		(05) SETUP CONNECTION PP-TEST	
		Mode : LOOPBACK	
		RF Level : -40.0 dbm	
		Q0 Proto : 000003FF0000	
		Q3 Proto : 003041108008	
		Q6 Proto : 006F0F000000	
		Traffic Slot : 2	
		Traffic Carrier : 0	
		Carrier Offset : 0.0	
		Dummy IF Traffic : OFF	
		Dummy Slot : 0	
		Press CONT key to setup connection	
CON	TINUE		

While the autotest is running, the display indicates how the measurement proceeds. The format corresponds to the log printout format.

2.6.10 Menu AUTO TEST Active

Press hardkey MENU UP to exit the menu DISPLAY RESULTS and return to the menu AUTO TEST
 End (section 2.6.11).

PAGE UP	Paging the test report up by 14 lines (in the direction of action 01).
PAGE DOWN	Paging the test report down by 14 lines (in the direction of the last action)
LINE UP	Paging the test report up by one line (in the direction of action 01).
LINE DOWN	Paging the test report down by one line (in the direction of the last action).

Fig. 2.6-12 Menu DISPLAY RESULTS

PAGE UP	LINE UP	LINE DOWN	PAGE DOWN	RESULTS (03) RF - MODULATION Data Type : FIG31 Average Burst : 4 ----- Template : NTP [+0.0,+25.0] : +0.0 dbm OK IS MATCHING RESULTS R(abs.) : 20 nV D(rel.) : +1.0 dB E(abs.) : 25.0 uV E(rel.) : -1.0 dB C(rel.) : +4.0 dB F(rel.) : -6.0 dB LIMITS Dynamic : LOW Average Burst : 100 (02) POWER RAMP AUTO TEST 04: Short pp Test
---------	---------	-----------	-----------	--

2.6.12 Menu DISPLAY RESULTS

PRINT IS ON	This indicates that a report is generated on the printer while the autotest is performed. The report can be switched off by pressing this softkey.
PRINT IS OFF	This indicates that there is no report generated while the autotest is performed. The report can be switched on by pressing this softkey.
STOP PRINTING	Abortion of output to printer
RESTART	Exit from this menu and change to the AUTO TEST menu (see Section 2.6.1) in order to restart or configure the autotest or to exit from the autotest.

2.6.13 Menu AUTO TEST COPY

This menu allows for copying autotests between internal memory locations and - if Option CMD-B62 is fitted - even to and from a memory card. The latter also allows for transferring autotests to other Testers CMD60.

The menu consists of two autotest directories. The source directory is displayed left of the menu and the target directory right of it.

Autotests in the target directory can be deleted, too. They can be copied to empty memory locations only, for reasons of operating security (the target memory location must be deleted prior to overwriting).

AUTO TEST COPY		SELECT	INTERN	-- SOURCE --	-- TARGET --	MEMCARD	SELECT
SELECT	SOURCE	SELECT	01 Short pp Test	01 Short pp Test	01 Short pp Test	01 Short pp Test	SELECT
UP	PAGE	PREV. TEST	02 Long pp Test	02 Long pp Test	02 Long pp Test	02 Long pp Test	UP
PAGE DOWN	TEST	NEXT TEST	03 Short FP Test	03 Short FP Test	03 Short FP Test	03 Short FP Test	PAGE DOWN
DELETE	TEST	TEST	04 FREE	04 FREE	04 FREE	04 FREE	DELETE
	TEST	TEST	05 FREE	05 FREE	05 FREE	05 FREE	
	TEST	TEST	06 FREE	06 FREE	06 FREE	06 FREE	
	TEST	TEST	07 FREE	07 FREE	07 FREE	07 FREE	
	TEST	TEST	08 FREE	08 FREE	08 FREE	08 FREE	
	TEST	TEST	09 FREE	09 FREE	09 FREE	09 FREE	
	TEST	TEST	10 FREE	10 FREE	10 FREE	10 FREE	
	TEST	TEST	11 FREE	11 FREE	11 FREE	11 FREE	

Fig. 2.6-13 Menu AUTO TEST COPY

This softkey is provided only if Option CMD-B62 is fitted. It switches over the autotest source directory on the left between internal and memory card.

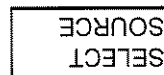

Paging up by 14 memory locations in the source and target directories (in the direction of autotest 01).

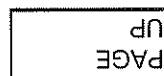

Selection of the previous autotest in the source and the target directory each.

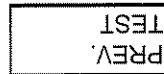

Selection of the next autotest in the source and the target directory each.

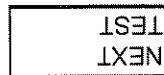

Paging down by 14 memory locations in the source and target directories (in the direction of autotest 20).

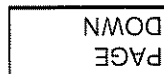

This softkey initiates the copy procedure. The framed autotest in the source directory (left) is copied to the framed memory location in the target directory (right). Copying is possible only if the selected memory location in the target directory is FREE. If not, it must be deleted prior to copying.

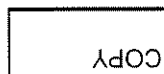

This softkey is provided only if Option CMD-B62 is fitted. It switches over the target autotest directory on the right between internal and memory card.



Deletes the framed autotest in the target directory (right).

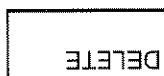

3	Remote Control	3.1
3.1	Introduction	3.1
3.2	Brief Instructions	3.1
3.3	Switchover to Remote Control	3.2
3.3.1	Setting the Device Address	3.2
3.3.2	Indications during Remote Control	3.2
3.3.3	Return to Manual Operation	3.3
3.4	IEC-Bus Messages	3.3
3.4.1	Interface Messages	3.3
3.4.2	Device Messages (Commands and Device Responses)	3.4
3.5	Structure and Syntax of the Device Messages	3.4
3.5.1	SCPI Introduction	3.4
3.5.2	Structure of a Command	3.5
3.5.3	Structure of a Command Line	3.7
3.5.4	Responses to Queries	3.7
3.5.5	Parameters	3.8
3.5.6	Overview of Syntax Elements	3.9
3.6	Description of Commands	3.10
3.6.1	Notation	3.10
3.6.2	Common Commands	3.12
3.7	Instrument Model and Command Processing	3.15
3.7.1	Input Unit	3.15
3.7.2	Command Recognition	3.16
3.7.3	Data Set and Instrument Hardware	3.16
3.7.4	Status Reporting System	3.16
3.7.5	Output Unit	3.17
3.7.6	Command Sequence and Command Synchronization	3.17
3.8	Status Reporting System	3.18
3.8.1	Structure of an SCPI Status Register	3.18
3.8.2	Overview of the Status Registers	3.20
3.8.3	Description of the Status Registers	3.21
3.8.3.1	Status Byte (STB) and Service Request Enable Register (SRE)	3.21
3.8.3.2	IST Flag and Parallel Poll Enable Register (PPE)	3.22
3.8.3.3	Event Status Register (ESR) and Event Status Enable Register (ESE)	3.22
3.8.3.4	STATUS:OPERATION Register	3.23
3.8.3.5	STATUS:QUESTIONABLE Register	3.23

Page

3.8.4	Application of the Status Reporting System.....	3.24
3.8.4.1	Service Request, Making Use of the Hierarchy Structure	3.24
3.8.4.2	Serial Poll.....	3.24
3.8.4.3	Parallel Poll.....	3.25
3.8.4.4	Query by Means of Commands.....	3.25
3.8.4.5	Error-Queue Query.....	3.25
3.8.5	Resetting Values of the Status Reporting System.....	3.26

Page

3 Remote Control

3.1 Introduction

The instrument is equipped with a serial interface (RS 232-C) as standard and, optionally, with an IEC-bus interface according to standard IEC 625.1/IEEE 488.2. The connector is located at the rear of the instrument and permits to connect a controller for remote control. The instrument supports the SCP1 version 1992.0 (Standard Commands for Programmable Instruments). The SCP1 standard is based on standard IEEE 488.2 and aims at the standardization of device-specific commands, error handling and the status registers (see Section 3.5.1).

This section assumes basic knowledge of IEC-bus programming and operation of the controller. A description of the interface commands is to be obtained from the relevant manuals. The requirements of the SCP1 standard placed on command syntax, error handling and configuration of the status registers are explained in detail in the respective sections. Tables provide a fast overview of the commands implemented in the instrument and the bit assignment in the status registers. The tables are supplemented by a comprehensive description of every command and the status registers.

3.2 Brief Instructions

The short and simple operating sequence given below permits fast putting into operation of the instrument and setting of its basic functions. Remote control via IEC bus assumes that the IEC-bus address, which is factory-set to 1, has not been changed.

1. Connect instrument and controller using IEC-bus cable.
2. Write and start the following program on the controller:

```
CALL IBFIND("DEV1", device%)
CALL IBPAD(device%, 1)
CALL IBWRT(device%, "*RST;*CLS")
CALL IBWRT(device%, "CONF:TEST:TYPE DFP")
CALL IBWRT(device%, "PROG:SEL MAN")
CALL IBWRT(device%, "PROG:CONN:SET")
CALL IBWRT(device%, "PROG:CONN:SET")
Establish a connection
Manual test
FP test
Reset instrument
Inform controller about instrument address
Open channel to the instrument
```

The CMD now attempts to establish a connection with a connected Fixed Part.

3. To return to manual control, press the [LOCAL] key at the front panel.

The CMD can also be addressed via the serial interface using the same commands. To this end, the terminal emulation of Microsoft Windows, for example, can be used on the controller.

3.3 Switchover to Remote Control

On power-on, the instrument is always in the manual operating state ("LOCAL" state) and can be operated via the front panel. It is switched to remote control ("REMOTE" state) as soon as it receives a command from a controller. During remote control, operation via the front panel is disabled. The instrument remains in the remote state until it is reset to the manual state via the front panel or via remote control (see Section 3.3.3). Switching from manual operation to remote control and vice versa does not affect the instrument settings.

3.3.1 Setting the Device Address

The IEC-bus address of the instrument is factory-set to 1. It can be changed manually in the CONFIG-MENU/IEEE-ADDRESS menu or via the remote control interfaces. Addresses 0 to 30 are permissible.

Manually:

- > Call CONFIG-MENU/IEEE-ADDRESS menu
- > Enter desired address
- > Terminate input using the [1/ENTER] key

Via IEC bus (or via the serial interface):

```
CALL IBFIND("DEV1", device%, 1)
CALL IBPAD(device%, 1)
CALL IBWRT(device%, "SYST:COMM:GPB:ADDR 20")
CALL IBPAD(device%, 20)
Inform controller about new address
Set instrument to new address
Inform controller about old address
Open channel to the instrument
```

3.3.2 Indications during Remote Control

In the REMOTE state, no menus but only the keyword REMOTE and, unless configured otherwise, the input and output strings of the remote-control interface are indicated on the display.

3.3.3 Return to Manual Operation

Return to manual operation is possible via the front panel or the IEC bus.

Manually:

➤ Press the [LOCAL] key.

Notes: Before switchover, command processing must be completed as otherwise switchover to remote control is effected immediately.

The [LOCAL] key can be disabled by the universal command LLO (see annex 3) in order to prevent unintentional switchover. In this case, switchover to manual mode is only possible via the IEC bus.

The [LOCAL] key can be enabled again by deactivating the REN line of the IEC bus (see annex A 3).

-Switchover to LOCAL is not possible via the serial interface.

Via IEC bus:

...
CALL IBLOC (device%)
...
Set instrument to manual operation

3.4 IEC-bus Messages

The messages transferred via the data lines of the IEC bus (see annex A3) can be divided into two groups:

- interface messages and
- device messages.

The serial interface only recognizes device messages.

3.4.1 Interface Messages

Interface messages are transferred on the data lines of the IEC bus, the "ATN" control line being active. They are used for communication between controller and instrument and can only be sent by a controller which has the IEC-bus control. Interface commands can be subdivided into

- universal commands and
- addressed commands.

Universal commands act on all devices connected to the IEC bus without previous addressing, addressed commands only act on devices previously addressed as listeners. The interface messages relevant to the instrument are listed in annex A3.

3.4.2 Device Messages (Commands and Device Responses)

Device messages are transferred on the data lines of the remote-control interface, the "ATN" control line not being active. ASCII code is used. A distinction is made according to the direction in which they are sent on the remote-control interface:

– Commands

are messages the controller sends to the instrument. They operate the device functions and request information.
The commands are subdivided according to two criteria:

1. According to the effect they have on the instrument:

Setting commands

cause instrument settings such as reset of the instrument or setting the output level to 1 volt.

Queries

cause data to be provided for output on the remote-control interface, e.g. for identification of the device or polling the active input.

2. According to their definition in standard IEEE 488.2:

Common Commands

are exactly defined as to their function and notation in standard IEEE 488.2. They refer to functions such as management of the standardized status registers, reset and selftest.

Device-specific commands

refer to functions depending on the features of the instrument such as frequency setting. A majority of these commands has also been standardized by the SCP1 committee (cf. Section 3.5.1).

– **Device responses** are messages the instrument sends to the controller after a query. They can contain measurement results, instrument settings and information on the instrument status (cf. Section 3.5.4).

Structure and syntax of the device messages are described in Section 3.5. The commands are listed and explained in detail in Section 3.6.

3.5 Structure and Syntax of the Device Messages

3.5.1 SCP1 Introduction

SCP1 (Standard Commands for Programmable Instruments) describes a standard command set for programming instruments, irrespective of the type of instrument or manufacturer. The goal of the SCP1 consortium is to standardize the device-specific commands to a large extent. For this purpose, a model was developed which defines the same functions inside a device or for different devices. Command systems were generated which are assigned to these functions. Thus it is possible to address the same functions with identical commands. The command systems are of a hierarchical structure. Fig. 3-1 illustrates this tree structure using a section of command system SOURce, which operates the signal sources of the devices. The other examples concerning syntax and structure of the commands are derived from this command system.
SCP1 is based on standard IEEE 488.2, i.e. it uses the same syntactic basic elements as well as the common commands defined in this standard. Part of the syntax of the device responses is defined with greater restrictions than in standard IEEE 488.2 (see Section 3.5.4, Responses to Queries).

3.5.2 Structure of a Command

The commands consist of a so-called header and, in most cases, one or more parameters. Header and parameter are separated by a "white space" (ASCII code 0 to 9, 11 to 32 decimal, e.g. blank). The headers may consist of several key words. Queries are formed by directly appending a question mark to the header.

Note: The commands of the SOURCE system used in the following examples are not implemented in the CMD.

Common commands

Common commands consist of a header preceded by an asterisk "*" and one or several parameters, if any.

Examples: *RST RESET, resets the device
 *ESE 253 EVENT STATUS ENABLE, sets the bits of the event status enable register
 *ESR? EVENT STATUS QUERY, queries the contents of the event status register.

Device-specific commands

Hierarchy:

Device-specific commands are of hierarchical structure (see Fig. 3-1). The different levels are represented by combined headers. Headers of the highest level (root level) have only one key word. This key word denotes a complete command system.

Example: source This key word denotes the command system

For commands of lower levels, the complete path has to be specified, starting on the left with the highest level, the individual key words being separated by a colon ":".

Example: source:FM:EXTERNAL:COUPLING AC

This command lies in the fourth level of the SOURCE system. It sets the coupling of the external signal source to AC.

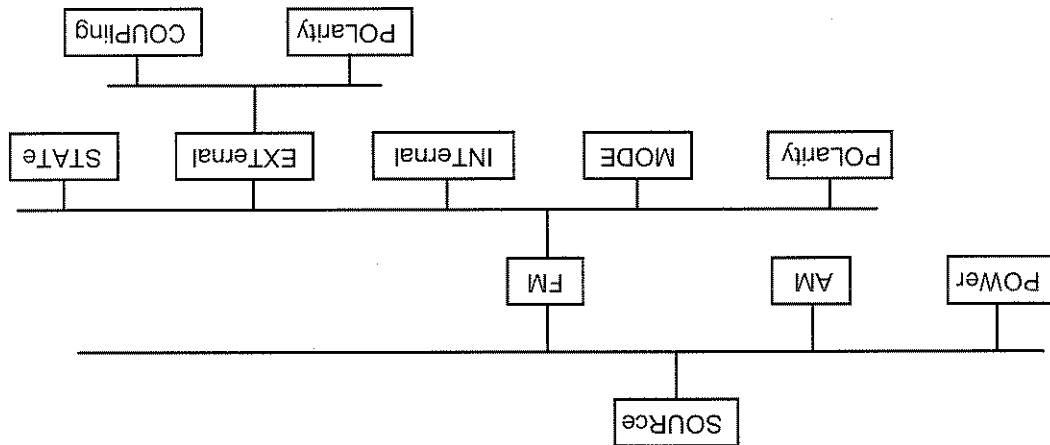

Fig. 3-1 Tree structure of the SCP1 command systems using the SOURCE system by way of example

Some key words occur in several levels within one command system. Their effect depends on the structure of the command, that is to say, at which position in the header of a command they are inserted.

Example: SOURCE:FM:POLARITY NORMAL

This command contains key word POLARITY in the third command level. It defines the polarity between modulator and modulation signal.

SOURCE:FM:EXTERNAL:POLARITY NORMAL

This command contains key word POLARITY in the fourth command level. It defines the polarity between modulation voltage and the resulting direction of the modulation only for the external signal source indicated.

Optional key words:

Some command systems permit certain key words to be optionally inserted into the header or omitted. These key words are marked by square brackets in the description. The full command length must be recognized by the instrument for reasons of compatibility with the SCP1 standard. Some commands are considerably shortened by these optional key words.

Example: [SOURCE]:POWER[:LEVEL] [:IMMEDIATE]:OFFSET 1

This command immediately sets the offset of the signal to 1 volt. The following command has the same effect:

POWER:OFFSET 1

Note:

An optional key word must not be omitted if its effect is specified in detail by a numeric suffix.

Long and short form:

The key words feature a long form and a short form. Either the short form or the long form can be entered, other abbreviations are not permissible.

Example: STATUS:QUESTIONABLE:ENABLE 1=STAT:QUES:ENAB 1

Note: The short form is marked by upper-case letters, the long form corresponds to the complete word. Upper-case and lower-case notation only serve the above purpose, the instrument itself does not make any difference between upper-case and lower-case letters.

Parameter:

The parameter must be separated from the header by a "white space". Several parameters are specified in a command, they are separated by a comma ",". A few queries permit the parameters MINIMUM, MAXIMUM and DEFAULT to be entered. For a description of the types of parameter, refer to Section 3.5.5.

Numeric suffix:

If a device features several functions or features of the same kind, e.g. inputs, the desired function can be selected by a suffix added to the command. Entries without suffix are interpreted like entries with the suffix 1.

Example: SOURCE:FM:EXTERNAL2:COUPLING AC

This command sets the coupling of the second external signal source.

3.5.3 Structure of a Command Line

A command line may consist of one or several commands. It is terminated by a <New Line>, a <New Line> with EOI or an EOI together with the last data byte. Quick BASIC automatically produces an EOI together with the last data byte.

Several commands in a command line are separated by a semicolon ";". If the next command belongs to a different command system, the semicolon is followed by a colon.

Example:

```
CALL IBWRT(device%, "SOURCE:POWER:CENTER MINIMUM;:OUTPUT:ATTENUATION 10")
```

This command line contains two commands. The first command is part of the SOURCE system and is used to specify the center frequency of the output signal. The second command is part of the OUTPUT system and sets the attenuation of the output signal.

If the successive commands belong to the same system, having one or several levels in common, the command line can be abbreviated. To this end, the second command after the semicolon starts with the level that lies below the common levels (see also Fig. 3-1). The colon following the semicolon must be omitted in this case.

Example:

```
CALL IBWRT(device%, "SOURCE:FM:MODE LOCKED;:SOURCE:FM:INT:FREQUENCY 1kHz")
```

This command line is represented in its full length and contains two commands separated from each other by the semicolon. Both commands are part of the SOURCE command system, subsystem FM, i.e. they have two common levels. When abbreviating the command line, the second command begins with the level below SOURCE:FM. The colon after the semicolon is omitted.

The abbreviated form of the command line reads as follows:

```
CALL IBWRT(device%, "SOURCE:FM:MODE LOCKED;INT:FREQUENCY 1kHz")
```

However, a new command line always begins with the complete path.

Example:

```
CALL IBWRT(device%, "SOURCE:FM:MODE LOCKED")
CALL IBWRT(device%, "SOURCE:FM:INT:FREQUENCY 1kHz")
```

3.5.4 Responses to Queries

A query is defined for each setting command unless explicitly specified otherwise. It is formed by adding a question mark to the associated setting command. According to SCPI, the responses to queries are partly subject to stricter rules than in standard IEEE 488.2.

1 The requested parameter is transmitted without header.

Example:

```
SOURCE:EXTERNAL:COUPLING?
```

Response: AC

2. Maximum values, minimum values and all further quantities, which are requested via a special text parameter are returned as numerical values.

Example:

```
FREQUENCY? MAX
```

Response: 10E3

3. Numerical values are output without a unit. Physical quantities are referred to the basic units or to the units set using the Unit command.

Example:

```
FREQUENCY?
```

Response: 1E6 for 1 MHz

4. Truth values <Boolean values> are returned as 0 (for OFF) and 1 (for ON).

Example:

```
OUTPUT:STATE?
```

Response: 1

5. Text (character data) is returned in a short form (see also Section 3.5.5).

Example:

```
SOURCE:FM:SOURCE?
```

Response: INT1

3.5.5 Parameters

Most commands require a parameter to be specified. The parameters must be separated from the header by a "white space". Permissible parameters are numerical values, Boolean parameters, text, character strings and block data. The type of parameter required for the respective command and the permissible range of values are specified in the command description (see Section 3.6).

Numerical values

Numerical values can be entered in any form, i.e. with sign, decimal point and exponent. Values exceeding the resolution of the instrument are rounded up or down. The mantissa may comprise up to 255 characters, the exponent must lie inside the value range -32000 to 32000. The exponent is introduced by an "E" or "e". Entry of the exponent alone is not permissible. In the case of physical quantities, the unit can be entered. Permissible unit prefixes are G (giga), MA (mega), MOHM and MHZ are also permissible), K (kilo), M (milli), U (micro) and N (nano). If the unit is missing, the basic unit is used.

Example:
SOURCE:FREQUENCY 1.5 kHz = SOURCE:FREQUENCY 1.5E3

Special numerical values

The texts MINIMUM, MAXIMUM, DEFAULT, UP and DOWN are interpreted as special numerical values.

In the case of a query, the numerical value is provided.

Example: Setting command: SOURCE:VOLTAGE MAXIMUM
Query: SOURCE:VOLTAGE?
Response: 15

MIN/MAX

MINIMUM and MAXIMUM denote the minimum and maximum value.

DEF

Default denotes a preset value which has been stored in the EPROM. This value conforms to the default setting, as it is called by the *RST command

UP/DOWN

UP, DOWN increases or reduces the numerical value by one step. The step width can be specified via an allocated step command (see annex C3, List of Commands) for each parameter which can be set via UP, DOWN.

INF/NINF

INFINITY, Negative INFINITY (NINF) represent the numerical values -9.9E37 or 9.9E37, respectively. INF and NINF are only sent as device responses.

NAN

Not A Number (NAN) represents the value 9.91E37. NAN is only sent as device response. This value is not defined. Possible causes are the division of zero by zero, the subtraction of infinite from infinite and the representation of missing values.

Boolean Parameters

Boolean parameters represent two states. The ON state (logically true) is represented by ON or a numerical value unequal to 0. The OFF state (logically untrue) is represented by OFF or the numerical value 0. 0 or 1 is provided in a query.

Example: Setting command: SOURCE:FM:STATE ON
Query: SOURCE:FM:STATE?
Response: 1

Text

Text parameters observe the syntactic rules for key words, i.e. they can be entered using a short or long form. Like any parameter, they have to be separated from the header by a white space. In the case of a query, the short form of the text is provided.

Example: Setting command: OUTPUT:FILTER:TYPE External
 Query: OUTPUT:FILTER:TYPE? Response EXT

Strings must always be entered in quotation marks (" or ").

Example: SYSTEM:LANGUAGE "English" or
 SYSTEM:LANGUAGE 'English'

Block data

Block data are a transmission format which is suitable for the transmission of large amounts of data. A command using a block data parameter has the following structure:

Example: HEADER:HEADER #45168xxxxxxxxxxx

ASCII character # introduces the data block. The next number indicates how many of the following digits describe the length of the data block. In the example the 4 following digits indicate the length to be 5168 bytes. The data bytes follow. During the transmission of these data bytes all End or other control signs are ignored until all bytes are transmitted. Data elements comprising more than one byte are transmitted with the byte being the first which was specified by SCP1 command "FORMAT:BORDER".

3.5.6 Overview of Syntax Elements

The following survey offers an overview of the syntax elements.

: The colon separates the key words of a command. In a command line the colon after the separating semicolon marks the uppermost command level.

; The semicolon separates two commands of a command line. It does not alter the path.

, The comma separates several parameters of a command.

? The question mark forms a query.

* The asterisk marks a common command.

" Quotation marks introduce a string and terminate it.

ASCII character # introduces block data.

A "white space (ASCII-Code 0 to 9, 11 to 32 decimal, e.g. blank) separates header and parameter.

3.6 Description of Commands

3.6.1 Notation

In the following sections, all commands implemented in the instrument are first listed in tables and then described in detail, separated according to the command system. The notation corresponds to the one of the SCP1 standards to a large extent. The SCP1 conformity information can be taken from the list of commands in annex C3.

Note: *The commands indicated by way of example are not implemented in the CMD.*

Table of Commands

In the command column, the table provides an overview of the commands and their hierarchical arrangement (see indentations).

Parameter: In the parameter column the requested parameters are indicated together with their specified range.

Unit: The unit column indicates the basic unit of the physical parameters.

Remark: In the remark column an indication is made on:
 – whether the command does not have a query form,
 – whether the command has only one query form,
 – whether this command is implemented only with a certain option of the instrument.

Indentations

The different levels of the SCP1 command hierarchy are represented in the table by means of indentations to the right. The lower the level is, the farther the indentation to the right is. Please observe that the complete notation of the command always includes the higher levels as well.

Example: SOURCE:FM:MODE is represented in the table as follows:

```

SOURCE
:FM
:MODE
first level
second level
third level
    
```

In the individual description, the hierarchy is represented in the corresponding way. That is to say, for each command all key words above up to the left-hand margin must be considered. An example for each command is written out at the end of the individual description.

Upper/lower case notation Upper/lower case letters serve to mark the long or short form of the key words of a command in the description (see Section 3.5.2). The instrument itself does not distinguish between upper and lower case letters.

Special characters |

A selection of key words with an identical effect exists for several commands. These key words are indicated in the same line, they are separated by a vertical stroke. Only one of these key words has to be indicated in the header of the command. The effect of the command is independent of which of the key words is indicated.

Example: SOURCE
:FREQUENCY
:CW|:FIXED

The two following commands of identical meaning can be formed. They set the frequency of the constantly frequent signal to 1 kHz:

SOURCE:FREQUENCY:CW 1B3 = SOURCE:FREQUENCY:FIXED 1B3

A vertical stroke in indicating the parameters marks alternative possibilities in the sense of "or". The effect of the command is different, depending on which parameter is entered.

Example: Selection of the parameters for the command
SOURCE:COUPLING AC | DC

If parameter AC is selected, only the AC content is fed through, in the case of DC, the DC as well as the AC content.

[] Key words in square brackets can be omitted when composing the header (cf. Section 3.5.2, Optional keywords). The full command length must be accepted by the instrument for reasons of compatibility with the SCPI standards.
Parameters in square brackets can optionally be incorporated in the command or omitted as well.

{ } Parameters in braces can optionally be incorporated in the command either not at all, once or several times.

The device response is for example: "Rohde&Schwarz,CMD,0,1.00 18.10.93"
 0 = serial number
 1.0 18.10.93 = Firmware version number and date of delivery

***CLS** CLEAR STATUS sets the status byte (STB), the standard event register (ESR) and the EVENT-part of the QUESTIONABLE and the OPERATION register to zero. The command does not alter the mask and transition parts of the registers. It clears the output buffer.

***ESE 0..255** EVENT STATUS ENABLE sets the event status enable register to the value indicated. Query *ESE? returns the contents of the event status enable register in decimal form.

***ESR?** STANDARD EVENT STATUS QUERY returns the contents of the event status register in decimal form (0 to 255) and subsequently sets the register to zero.

***IDN?** IDENTIFICATION QUERY queries the instrument identification.

Command	Parameter	Unit	Remark
*CLS			no query
*ESE	0..255		
*ESR?			only query
*IDN?			only query
*IST?			only query
*OPC			
*OPT?			only query
*PRE	0..255		
*PSC	0 1		
*RST			no query
*SRE	0..255		
*STB?			only query
*TST?			only query
*WAI			

Table 3-1 Common Commands

The common commands are taken from the IEEE 488.2 (IEC 625-2) standard. Same commands have the same effect on different devices. The headers of these commands consist of "*" followed by three letters. Many common commands refer to the status reporting system which is described in detail in Section 3.8.

3.6.2 Common Commands

***IST?**
INDIVIDUAL STATUS QUERY returns the contents of the IST flag in decimal form (0 | 1). The IST-flag is the status bit which is sent during a parallel poll (see section 3.8.3.2).

***OPC**
OPERATION COMPLETE sets bit 0 in the event status register when all preceding commands have been executed. This bit can be used to initiate a service request (cf. Section 3.7).

***OPC?**
OPERATION COMPLETE QUERY writes message "1" into the output buffer as soon as all preceding commands have been executed (cf. Section 3.7).

***OPT?**
OPTION IDENTIFICATION QUERY queries the options included in the instrument and returns a list of the options installed. The options are separated from each other by means of commas.

The responses have the following meaning:

- B1 OCXO Reference
- B3 Ref. Frequency In/Out
- B4 DSP
- B41 AF Unit
- B6 Option Basic Board
- B61 IEEE Bus
- B62 Memcard Interface

Example of a device response: „B4,B41,B6,B61,

***PRE 0...255**
PARALLEL POLL REGISTER ENABLE sets parallel poll enable register to the value indicated. Query *PRE? returns the contents of the parallel poll enable register in decimal form.

***PSC 0 | 1**
POWER ON STATUS CLEAR determines whether the contents of the ENABLE registers is maintained or reset in switching on.

*PSC = 0 causes the contents of the status registers to be maintained. Thus a service request can be triggered in switching on in the case of a corresponding configuration of status registers ESE and SRE.

*PSC ≠ 0 resets the registers.

Query *PSC? reads out the contents of the power-on-status-clear flag. The response can be 0 or 1.

***RST**
RESET sets the instrument to a defined default status. The command essentially corresponds to pressing the [RESET] key. The default setting is indicated in the description of commands.

***SRE 0...255**
SERVICE REQUEST ENABLE sets the service request enable register to the value indicated. Bit 6 (MSS mask bit) remains 0. This command determines under which conditions a service request is triggered. Query *SRE? reads the contents of the service request enable register in decimal form. Bit 6 is always 0.

***STB?**
READ STATUS BYTE QUERY reads the contents of the status byte in decimal form.

***TST?**
SELF TEST QUERY triggers selftests of the instrument and outputs an error code in decimal form.

WAI
WAIT-to-CONTINUE only permits the servicing of the subsequent commands after all preceding commands have been executed and all signals have settled (see also section 3.7 and "OPC").

3.7 Instrument Model and Command Processing

The instrument model shown in Fig. 3.2 has been made viewed from the standpoint of the servicing of remote-control commands. The individual components work independently of each other and simultaneously. They communicate by means of so-called "messages".

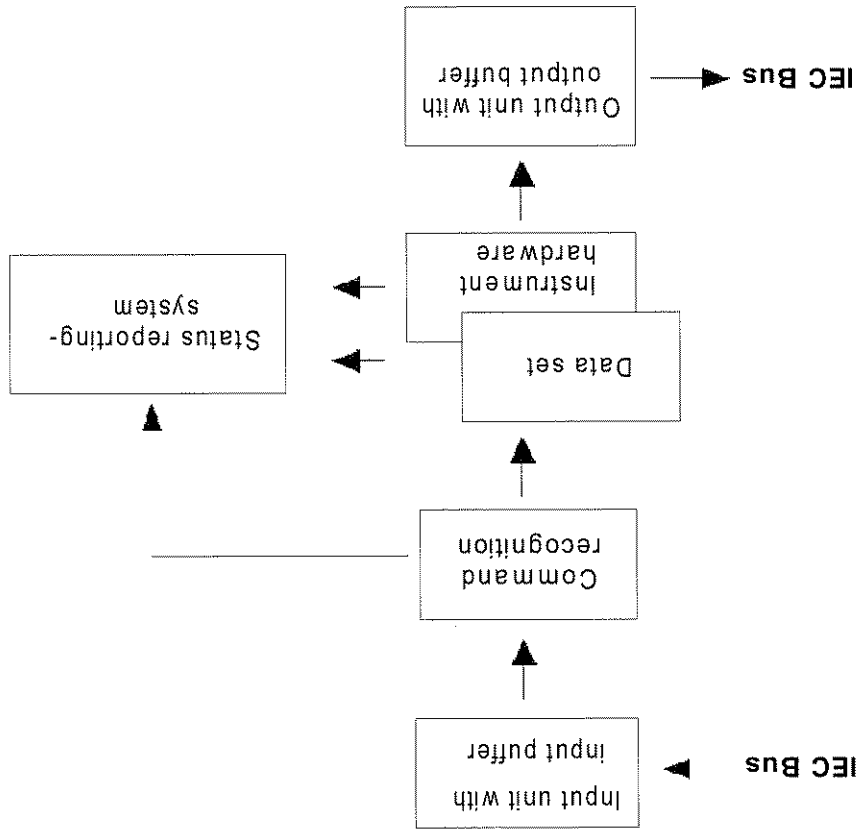

Fig. 3-2 Instrument model in the case of remote control

3.7.1 Input Unit

The input unit receives commands character by character from the remote-control interface and collects them in the input buffer. The input buffer has a size of 256 characters. The input unit sends a message to the command recognition as soon as the input buffer is full or as soon as it receives a message, <PROGRAM MESSAGE TERMINATOR>, as defined in IEEE 488.2, or the interface message DCL. If the input buffer is full, the remote-control traffic is stopped and the data received up to then are processed. Subsequently the remote-control traffic is continued. If, however, the buffer is not yet full when receiving the delimiter, the input unit can already receive the next command during command recognition and execution. The reception of a DCL clears the input buffer and immediately initiates a message to the command recognition.

3.7.2 Command Recognition

The command recognition analyses the data received from the input unit. It proceeds in the order in which it receives the data. Only a DCL is serviced with priority, a GET (Group Execute Trigger), e.g., is only executed after the commands received before as well. Each recognized command is immediately transferred to the data set but without being executed there at once.

Syntactical errors in the command are recognized here and supplied to the status reporting system. The rest of a command line after a syntax error is analysed further if possible and serviced.

If the command recognition recognizes a delimiter or a DCL, it requests the data set to set the commands in the instrument hardware as well now. Subsequently it is immediately prepared to process commands again. This means for the command servicing that further commands can already be serviced while the hardware is still being set ("overlapping execution").

3.7.3 Data Set and Instrument Hardware

Here the expression "instrument hardware" denotes the part of the instrument fulfilling the actual instrument function - signal generation, measurement etc. The controller is not included.

The data set is a detailed reproduction of the instrument hardware in the software.

Remote-control setting commands lead to an alteration in the data set. The data set management enters the new values (e.g. frequency) into the data set, however, only passes them on to the hardware when requested by the command recognition. As this is always only effected at the end of a command line, the order of the setting commands in the command line is not relevant.

The data are only checked for their compatibility among each other and with the instrument hardware immediately before they are transmitted to the instrument hardware. If the detection is made that an execution is not possible, an "execution error" is signalled to the status reporting system. All alterations of the data set are cancelled, the instrument hardware is not reset. Due to the delayed checking and hardware setting, however, it is permissible to set impermissible instrument states within one command line for a short period of time without this leading to an error message (example: simultaneous activation of FM and PM). At the end of the command line, however, a permissible instrument state must have been reached again.

Remote-control queries induce the data set management to send the desired data to the output unit.

3.7.4 Status Reporting System

The status reporting system collects information on the instrument state and makes it available to the output unit on request. The exact structure and function are described in Section 3.8

3.7.5 Output Unit

The output unit collects the information requested by the controller, which it receives from the data set management. It processes it according to the SCP1 rules and makes it available in the output buffer. The output buffer has a size of 256 characters. If the information requested is longer, it is made available "in portions" without this being recognized by the controller.

If the instrument is addressed as a talker without the output buffer containing data or awaiting data from the data set management, the output unit sends error message "Query UNTERMINATED" to the status reporting system. No data are sent on the remote-control interface, the controller waits until it has reached its time limit. This behaviour is specified by SCP1.

3.7.6 Command Sequence and Command Synchronization

What has been said above makes clear that all commands can potentially be carried out overlapping. Equally, setting commands within one command line are not absolutely serviced in the order in which they have been received.

In order to make sure that commands are actually carried out in a certain order, each command must be sent in a separate command line, that is to say, with a separate IBWRT()-call.

In order to prevent an overlapping execution of commands, one of commands *OPC, *OPC? or *WAI must be used. All three commands cause a certain action only to be carried out after the hardware has been set and has settled. By a suitable programming, the controller can be forced to wait for the respective action to occur (cf. table 3-2).

Table 3-2 Synchronisation using *OPC *OPC? and *WAI

Command	Action after the hardware has settled	Programming the controller
*OPC	Setting the operation-complete bit in the ESR	- Setting bit 0 in the ESE - Setting bit 5 in the SRE - Waiting for service request (SRQ)
*OPC?	Writing a "1" into the output buffer	Addressing the instrument as a talker
*WAI	Continuing the IEC-bus handshake	Sending the next command

3.8 Status Reporting System

The status reporting system (cf. Fig. 3-4) stores all information on the present operating state of the instrument and on errors which have occurred. This information is stored in the status registers and in the error queue. The status registers and the error queue can be queried via the remote-control interface.

The information is of a hierarchical structure. The register status byte (STB) defined in IEEE 488.2 and its associated service request enable (SRE) form the uppermost level. The STB receives its information from the standard event status register (ESR) which is also defined in IEEE 488.2 with the associated mask register standard event status enable (ESE) and registers STATUS:OPERATION and STATUS:QUESTIONABLE which are defined by SCPI and contain detailed information on the instrument.

The IST flag ("Individual Status") and the parallel poll enable register (PPE) allocated to it are also part of the status reporting system. The IST flag, like the SRQ, combines the entire instrument status in a single bit. The PPE fulfills an analog function for the IST flag as the SRE for the service request.

The output buffer contains the messages the instrument returns to the controller. It is not part of the status reporting system but determines the value of the MAV bit in the STB and thus is represented in Fig. 3.4.

3.8.1 Structure of an SCPI Status Register

Each SCPI register consists of 5 parts which each have a width of 16 bits and have different functions (cf. Fig. 3-3). The individual bits are independent of each other, i.e. each hardware status is assigned a bit number which is valid for all five parts. For example, bit 3 of the STATUS:OPERATION register is assigned to the hardware status "wait for trigger" in all five parts. Bit 15 (the most significant bit) is set to zero for all parts. Thus the contents of the register parts can be processed by the controller as positive integer.

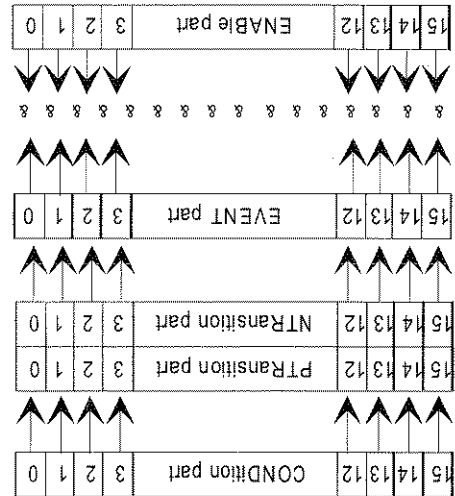

Fig. 3-3 The status-register model

⊕ = logisch OR
 of all bits

& = logisch AND

⊕ Sum bit
 ←
 to higher-order register

The CONDITION part is directly written into by the hardware or the sum bit of the next lower register. Its contents reflects the current instrument status. This register part can only be read, but not written into or cleared. Its contents is not affected by reading.

CONDITION part

The Positive-Transition part acts as an edge detector. When a bit of the CONDITION part is changed from 0 to 1, the associated PTR bit decides whether the EVENT bit is set to 1.
 PTR bit = 1: the EVENT bit is set.
 PTR bit = 0: the EVENT bit is not set.
 This part can be written into and read at will. Its contents is not affected by reading.

PTRansition part

The Negative-Transition part also acts as an edge detector. When a bit of the CONDITION part is changed from 1 to 0, the associated NTR bit decides whether the EVENT bit is set to 1.
 NTR-Bit = 1: the EVENT bit is set.
 NTR-Bit = 0: the EVENT bit is not set.
 This part can be written into and read at will. Its contents is not affected by reading.

NTRansition part

With these two edge register parts the user can define which state transition of the condition part (none, 0 to 1, 1 to 0 or both) is stored in the EVENT part.
 The EVENT part indicates whether an event has occurred since the last reading, it is the "memory" of the condition part. It only indicates events passed on by the edge filters. It is permanently updated by the instrument. This part can only be read by the user. During reading, its contents is set to zero. In linguistic usage this part is often equated with the entire register.

EVENT part

The ENABLE part determines whether the associated EVENT bit contributes to the sum bit (cf. below). Each bit of the EVENT part is ANDed with the associated ENABLE bit (symbol '&'). The results of all logical operations of this part are passed on to the sum bit via an OR function (symbol '+').
 ENAB-Bit = 1: the associated EVENT bit does not contribute to the sum bit well.
 ENAB-Bit = 0: if the associated EVENT bit is "1", the sum bit is set to "1" as well.
 This part can be written into and read by the user at will. Its contents is not affected by reading.

ENABLE part

As indicated above, the sum bit is obtained from the EVENT and ENABLE part for each register. The result is then entered into a bit of the CONDITION part of the higher-order register.
 The instrument automatically generates the sum bit for each register. Thus an event, e.g. a PLL that has not locked, can lead to a service request throughout all levels of the hierarchy.

Sum bit

Note: The service request enable register SRE defined in IEEE 488.2 can be taken as ENABLE part of the STB if the STB is structured according to SCPL. By analogy, the ESE can be taken as the ENABLE part of the ESR.

3.8.2 Overview of the Status Registers

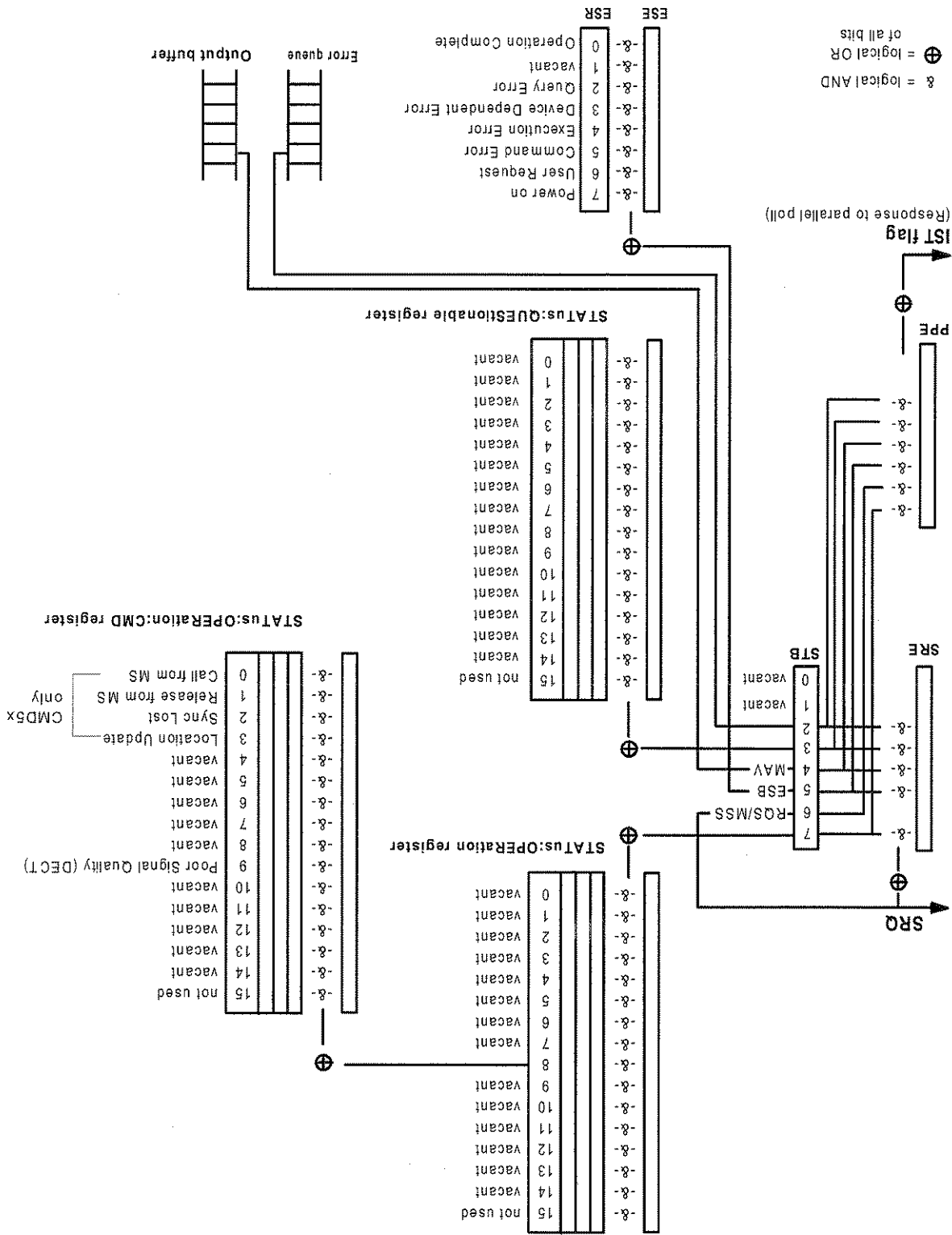

Fig. 3-4 Overview of status registers

3.8.3 Description of the Status Registers

3.8.3.1 Status Byte (STB) and Service Request Enable Register (SRE)

The STB is already defined in IEEE 488.2. It provides a rough overview of the instrument status by collecting the pieces of information of the lower registers. It can thus be compared with the CONDITION part of an SCPI register and assumes the highest level within the SCPI hierarchy. A special feature is that bit 6 acts as the sum bit of the remaining bits of the status byte.

The STATUS BYTE is read out using the command `""*STB?"` or a serial poll.

The STB includes the SRE. It corresponds to the ENABLE part of the SCPI registers as to its function. Each bit of the STB is assigned a bit in the SRE. Bit 6 of the SRE is ignored. If a bit is set in the SRE and the associated bit in the STB changes from 0 to 1, a Service Request (SRQ) is generated on the IEC bus, which triggers an interrupt in the controller if this is appropriately configured and can be further processed there. (An SRQ cannot be triggered on the serial interface, since no appropriate hardware lines are provided there).

The SRE can be set using command `""*SRE"` and read using `""*SRE?"`.

Table 3-3 Meaning of the bits used in the status byte

Bit No.	Meaning
2	Error Queue not empty The bit is set when an entry is made in the error queue. If this bit is enabled by the SRE, each entry of the error queue generates a Service Request. Thus an error can be recognized and specified in greater detail by polling the error queue. The poll provides an informative error message. This procedure is to be recommended since it considerably reduces the problems involved with remote control.
3	QUESTIONABLE status sum bit The bit is set if an EVENT bit is set in the QUESTIONABLE-Status register and the associated ENABLE bit is set to 1. A set bit indicates a questionable instrument status, which can be specified in greater detail by polling the QUESTIONABLE-Status register.
4	MAV bit (message available) The bit is set if a message is available in the output buffer which can be read. This bit can be used to enable data to be automatically read from the instrument to the controller (cf. annex D3, program examples).
5	ESB bit Sum bit of the event status register. It is set if one of the bits in the event status register is set and enabled in the event status enable register. Setting of this bit implies a serious error which can be specified in greater detail by polling the event status register.
6	MSS bit (master status smmary bit) The bit is set if the instrument triggers a service request. This is the case if one of the other bits of this registers is set together with its mask bit in the service request enable register SRE.
7	OPERATION status register sum bit The bit is set if an EVENT bit is set in the OPERATION-Status register and the associated ENABLE bit is set to 1. A set bit indicates that the instrument is just performing an action. The type of action can be determined by polling the QUESTIONABLE-Status register.

3.8.3.2 IST Flag and Parallel Poll Enable Register (PPE)

By analogy with the SRQ, the IST flag combines the entire status information in a single bit. It can be queried by means of a parallel poll (cf. Section 3.8.4.3) or using command "IST?".

The parallel poll enable register (PPE) determines which bits of the STB contribute to the IST flag. The bits of the STB are ANDed with the corresponding bits of the PPE, with bit 6 being used as well in contrast to the SRE. The 1st flag results from the ORing of all results. The PPE can be set using commands "PRE" and read using command "PRE?".

3.8.3.3 Event-Status-Register (ESR) und Event-Status-Enable-Register (ESE)

The ESR is already defined in IEEE 488.2. It can be compared with the EVENT part of an SCPI register. The event status register can be read out using command "ESR?".

The ESE is the associated ENABLE part. It can be set using command "ESE" and read using command "ESE?".

Table 3-4 Meaning of the bits used in the event status register

Bit No.	Meaning
0	Operation Complete This bit is set on reception of the command *OPC exactly when all previous commands have been executed.
2	Query Error This bit is set if either the controller wants to read data from the instrument without having sent a query, or if it does not fetch requested data and sends new instructions to the instrument instead. The cause is often a query which is faulty and hence cannot be executed.
3	Device-dependent Error This bit is set if a device-dependent error occurs. An error message with a number between -300 and -399 or a positive error number, which denotes the error in greater detail, is entered into the error queue (cf. annex B3, Error Messages).
4	Execution Error This bit is set if a received command is syntactically correct, however, cannot be performed for other reasons. An error message with a number between -200 and -300, which denotes the error in greater detail, is entered into the error queue (cf. annex B3, Error Messages).
5	Command Error This bit is set if a command which is undefined or syntactically incorrect is received. An error message with a number between -100 and -200, which denotes the error in greater detail, is entered into the error queue (cf. annex B3, Error Messages).
6	User Request This bit is set on pressing the LOCAL key, i. e., when the instrument is switched over to manual control.
7	Power On (supply voltage on) This bit is set on switching on the instrument.



This register contains information on questionable instrument states. They can occur, e.g. if the instrument is operated out of its specifications. It can be queried using the commands STATUS:QUESTIONABLE[:CONDITION? or STATUS:QUESTIONABLE[:EVENT] ?.

The CMD does not use this register.

3.8.3.5 STATUS:QUESTIONABLE Register

In the CONDITION part, this register contains information on which actions the instrument is being executing or, in the EVENT part, information on which actions the instrument has executed since the last reading. It can be read using the commands STATUS:OPERATION:CONDITION? bzw. STATUS:OPERATION[:EVENT] ?.

3.8.3.4 STATUS:OPERATION Register

3.8.4 Application of the Status Reporting System

In order to be able to effectively use the status reporting system, the information contained there must be transmitted to the controller and further processed there. There are several methods which are represented in the following.

3.8.4.1 Service Request, Making Use of the Hierarchy Structure

Under certain circumstances, the instrument can send a service request (SRQ) to the controller. Usually this service request initiates an interrupt at the controller, to which the control program can react with corresponding actions. As evident from Fig. 3.4 (Section 3.8.2), an SRQ is always initiated if one or several of bits 2, 3, 4, 5 or 7 of the status byte are set and enabled in the SRE. Each of these bits combines the information of a further register, the error queue or the output buffer. The corresponding setting of the ENABLE parts of the status registers can achieve that arbitrary bits in an arbitrary status register initiate an SRQ. In order to make use of the possibilities of the service request, all bits should be set to "1" in enable registers SRE and ESE.

Examples (cf. Fig. 3.4, Section 3.8.2):

Use of command "*OPC" to generate an SRQ

- > Set bit 0 in the ESE (Operation Complete)

- > Set bit 5 in the SRE (ESB)?

After its settings have been completed, the instrument generates an SRQ.

Indication of the end of a call setup from the mobile by means of an SRQ with the controller

- > Set bit 7 in the SRE (sum bit of the STATUS:OPERATION register)

- > Set bit 8 (CMD event) in the STATUS:OPERATION:ENABLE.

After a call setup has been completed, the instrument generates an SRQ.

The SRQ is the only possibility for the instrument to become active on its own. Each controller program should set the instrument such that a service request is initiated in the case of malfunction. The program should react appropriately to the service request.

3.8.4.2 Serial Poll

In a serial poll, as with command "*STB", the status byte of an instrument is queried. However, the query is implemented via interface messages and is thus clearly faster. The serial-poll method has already been defined in IEEE 488.1 and used to be the only standard possibility for different instruments to poll the status byte. The method also works with instruments which do not adhere to SCP1 or IEEE 488.2.

The quick-BASIC command for executing a serial poll is "IBRSP()". Serial poll is mainly used to obtain a fast overview of the state of several instruments connected to the IEC bus.

3.8.4.3 Parallel Poll

In a parallel poll, up to eight instruments are simultaneously requested by the controller by means of a single command to transmit 1 bit of information each on the data lines, i.e., to set the data line allocated to each instrument to logically "0" or "1". By analogy to the SRE register which determines under which conditions an SRQ is generated, there is a parallel poll enable register (PPE) which is ANDed with the STB bit by bit as well considering bit 6. The results are ORed, the result is then sent (possibly inverted) as a response in the parallel poll of the controller. The result can also be queried without parallel poll by means of command "IST".

The instrument first has to be set for the parallel poll using quick-BASIC command "IBPCC()". This command allocates a data line to the instrument and determines whether the response is to be inverted. The parallel poll itself is executed using "IBRPP()".

The parallel-poll method is mainly used in order to quickly find out after an SRQ which instrument has sent the service request if there are many instruments connected to the IEC bus. To this effect, SRE and PPE must be set to the same value.

3.8.4.4 Query by Means of Commands

Each part of every status register can be read by means of queries. The individual commands are indicated in the detailed description of the registers in Section 3.8.3. What is returned is always a number which represents the bit pattern of the register queried. Evaluating this number is effected by the controller program.

Queries are usually used after an SRQ in order to obtain more detailed information on the cause of the SRQ

3.8.4.5 Error-Queue Query

Each error state in the instrument leads to an entry in the error queue. The entries of the error queue are detailed plain-text error messages which can be queried via the remote control using command "SYSTEM:ERROR?". Each call of "SYSTEM:ERROR?" provides an entry from the error queue. If no error messages are stored there any more, the instrument responds with 0, "No error".

The error queue should be queried after every SRQ in the controller program as the entries describe the cause of an error more precisely than the status registers. Especially in the test phase of a controller program the error queue should be queried regularly since faulty commands from the controller to the instrument are recorded there as well.

(1) Every command being the first in a command line, i.e., immediately following a <PROGRAM MESSAGE TERMINATOR> clears the output buffer.

Event	Effect		DCL,SDC (Device Clear, Selected Device Clear)	*RST or SYSTEM:PRESet	STATUS:PRESet	*CLS
	Switching on supply voltage	Power-On-Status- Clear				
Clear STR,ESR	—	yes	—	—	—	yes
Clear SRE,ESE	—	yes	—	—	—	—
Clear PPE	—	yes	—	—	—	—
Clear EVENT1 parts of the registers	—	yes	—	—	—	yes
Clear Enable parts of all OPERation and QUESTionable registers, Fill Enable parts of all other registers with "1".	—	yes	—	—	yes	—
Clear error queue	yes	yes	—	—	—	yes
Clear output buffer	yes	yes	yes	(1)	(1)	(1)
Clear command processing and input buffer	yes	yes	yes	—	—	yes

Table 3-5 Resetting instrument functions

Table 3-5 comprises the different commands and events causing the status reporting system to be reset. None of the commands, except for *RST and SYSTEM:PRESet influences the functional instrument settings. In particular, DCL does not change the instrument settings.

3.8.5 Resetting Values of the Status Reporting System

Under normal operating conditions, regular maintenance is not required. However, we recommend to check the frequency accuracy of the reference oscillator every one to two years.

4 Maintenance

4.1 Testing of the Frequency Accuracy

If the option CMD-B1 is not fitted, check the TCXO reference oscillator.

If the option CMD-B1 is fitted, check the OCXO reference oscillator (note warm-up period).

Refer to Section 5.2.1 for checking the reference frequency.

5 Testing the Rated Specifications

5.1 Test Instruments and Utilities

Spectrum analyzer	up to 2 GHz	FSE
Signal generator	up to 2 GHz	SME03
Power meter	up to 2 GHz	URV + URV-Z2
Oscilloscope	100 MHz	BOL
Preamplifier	30 dBm at DECT frequencies	NRVD + URV-Z2

5.2 Testing the TX Specifications

5.2.1 TX Frequency Accuracy

Refer to Section 2.4 for the description of the individual operating menus. The relation between DECT frequency number and frequency can be looked up in Table 2.4-1.

Setting:

MODULE TEST	RF GEN	FREQ / RF CHAN	-3 ... 12	DEVIATION	0	CONSTANT ENVELOP (00001111)	CONNECT/EXT.ATT	RF IN/OUT	EXT.ATT	RF IN/OUT 0 dB	RF LEVEL	-40 dBm
-------------	--------	----------------	-----------	-----------	---	-----------------------------	-----------------	-----------	---------	----------------	----------	---------

Measurement:

Measure the frequency of the RF IN/OUT signal using a spectrum analyzer and compare to the set frequency.

Tolerances:

TCXO	± 3 KHz
OCXO (CMD-B1)	± 200 Hz

Adjust TCXO / OCXO, if required (see service manual).

5.2.2 TX Level Accuracy at RF IN/OUT

Setting:

MODULE TEST	RF GEN	FREQ / RF CHAN	5	DEVIATION	0	CONSTANT ENVELOP (00001111)	CONNECT/EXT. ATT	RF IN/OUT	EXT.ATT	RF IN/OUT 0 dB	RF LEVEL	-40 dBm
-------------	--------	----------------	---	-----------	---	-----------------------------	------------------	-----------	---------	----------------	----------	---------

Testing the Rated Specifications

CMD60

Measurement: Measure level at RF IN/OUT using a power meter, note measurement value M1 (e.g., M1 = -39.4 dBm).

Tolerances: < 1.5 dB

Setting: LEVEL -40 dBm

Measurement: Measure level at RF IN/OUT using a spectrum analyzer, use measured value as reference.

Setting: LEVEL -50 dBm as first nominal level

Measurement: Measure relative level -> measurement value M2 (e.g., -10.5 dB)

Tolerances: Deviation from rated value: M1 + M2 - nominal level

(e.g.: -39.4 dBm - 10.5 dB + 50 dBm = 0.1 dBm)

permitted tolerance: < 1.5 dB

Repeat measurement with different levels (down to -100 dBm) and different frequencies.

Frequency/nominal level	CHAN -3	CHAN 0	CHAN 5	CHAN 9	CHAN 12
	1902.528 MHz	1897.344 MHz	1888.704 MHz	1881.792 MHz	1876.608 MHz
-40 dBm					
-50 dBm					
-60 dBm					
-70 dBm					
-80 dBm					
-90 dBm					
-100 dBm					

5.2.3 TX Level Accuracy RF OUT2

Setting:

MODULE TEST

RF GEN

FREQ / RF CHAN

5

DEVIATION

0

CONSTANT ENVELOP (00001111)

SIGNAL

CONNECT/EXT. ATT.

RF IN 1 / RF OUT2

EXT.ATT. RF OUT2 0 dB

RF LEVEL

0 dBm

Measurement: Measure level at RF OUT2 using a power meter.

Tolerances: 0 dBm ± 5 dB

Repeat measurement with different levels and different frequencies.

5.2.4 TX Modulation

Setting:

MODULE TEST
RF GEN

FREQ / RF CHAN 5
DEVIATION 282 KHZ
SIGNAL CONSTANT ENVELOP (00001111)

CONNECT/EXT. ATT. RF IN1 / RF OUT2
EXT.ATT. RF OUT2 0 dB

RF LEVEL 0 dBm

Measurement: Measure at RF OUT2:

CENTER 1888.704 MHz
SPAN 1 MHz

Tolerances: The level of the carrier frequency (center) must be at least 25 dB lower than with DEVIATION 0.
Method: zero position of the Bessel function).

5.3 Testing the RX Specifications

5.3.1 Accuracy of Power Measurement at RF IN/OUT

Setting:

MODULE TEST
BURST ANALYSIS

EXPECTED POWER approx. 2 dB higher than applied power, respectively
(in the range +30...-10 dBm).

FREQ / RF CHAN -3 ... 12
FREE RUN
CONNECT/EXT. ATT. RF IN/OUT

EXT.ATT. RF IN/OUT 0 dB

Measurement:

Set signal generator to desired frequency (Chan -3 ... 12) and level (+30 dBm ... -50 dBm) and apply to RF IN/OUT, check level using a power meter. A power amplifier is required for generation of higher levels.

The measured power is indicated in the NTP field of the BURST ANALYSIS menu display.

Tolerances:

< 2.5 dB in the range +30 to -10 dBm
< 3 dB in the range -10 to -50 dBm

Frequency / Level	CHAN -3	CHAN 0	CHAN 5	CHAN 9	CHAN 12
	1902.528 MHz	1897.344 MHz	1888.704 MHz	1881.792 MHz	1876.608 MHz
+30 dBm					
+20 dBm					
+10 dBm					
0 dBm					
-10 dBm					
-20 dBm					
-30 dBm					
-40 dBm					
-50 dBm					

5.3.2 Accuracy of Power Measurement at RF IN2

Setting:

MODULE TEST
 BURST ANALYSIS
 EXPECTED POWER approx. 2 dB higher than applied power, respectively
 FREQ / RF CHAN -3 ... 12
 TRIGGER
 FREE RUN
 CONNECT/EXT. ATT. RF IN2 / RF OUT1
 EXT.ATT. RF IN2 0 dB

Measurement:

Set signal generator to desired frequency (Chan -3 to 12) and level (-35 dBm to -50 dBm) and apply to RF IN2, check level using a power meter.
 The measured power is indicated in the NTP field of the BURST ANALYSIS menu display.

Tolerances:

< 5 dB in the range -35 to -50 dBm

5.3.3 FM Deviation and Residual FM

Setting:

MODULE TEST
 BURST ANALYSIS
 EXPECTED POWER 10 dBm
 FREQ / RF CHAN 5
 TRIGGER
 FREE RUN
 CONNECT/EXT. ATT. RF IN/OUT
 EXT.ATT. RF IN/OUT 0 dB

Deviation measurement:

Set signal generator (1888.704 MHz, 7 dBm, FM with 100 kHz AF, FM deviation 300 kHz).
 The measured modulation (positive and negative peak deviation in the measuring time) is indicated in the MAX. \pm MODULATION field of the BURST ANALYSIS menu display.
 300 kHz \pm 15 kHz
 Measure the ac voltage at BNC connector DEMOD OUT on the rear using an Af voltmeter: with the above setting it is $U_{\text{DEMOP}} = 600 \text{ mV} \pm 30 \text{ mV}$.

Measurement of residual FM:

Set signal generator (1888.704 MHz, 7 dBm, FM modulation switched off).
 The residual FM is indicated in the MAX. \pm MODULATION field of the BURST ANALYSIS menu display:
 max. 15 kHz

Measurement of frequency offset of FM demodulator:

Set signal generator (1888.704 MHz, 7 dBm, FM modulation switched off).
 The frequency offset is indicated in the FREQ OFFSET field of the BURST ANALYSIS menu display:
 max. 5 kHz

5.4 Further Tests

5.4.1 Reference Frequency Inputs/Outputs (Option CMD-B3)

Setting:

CONFIG SYNC
 REF.FREQ. EXTERN
 MODULE TEST
 RF GEN
 FREQ / RF CHAN 5
 DEVIATION 0
 SIGNAL CONSTANT ENVELOP (00001111)
 CONNECT/EXT. ATT. RF IN/OUT
 EXT.ATT. RF IN/OUT 0 dB
 RF LEVEL -40 dbm

Measurement:

Apply an external reference frequency of 10 MHz, approx. 0 dBm to the REF IN connector on the rear panel of the instrument, measure the frequency of the RF generator using a spectrum analyzer (1888.704 MHz).

A variation of the reference frequency by ± 50 Hz must cause the frequency of the RF generator to change by ± 9.44 KHz.

The applied frequency is available again at the REF OUT1 connector.

Measurement of the synchronization signal CLK100:

Measure at BNC connector CLK100 on the rear panel:

100 Hz, TTL

using a frequency meter or oscilloscope.

5.5 Call Setup with DECT Fixed Part or Portable Part

Initiate a call setup with a Fixed Part and/or a Portable Part and check correct performance of the following functions:

- CONNECTION ESTABLISHED
- POWER RAMP
- MODULATION
- TIMING
- BER

ADDITIONAL MEASUREMENTS: audio meas. generator contained (if CMD-B4/-B41 is fitted).

Annex A3

IEC-Bus Interface

The instrument is equipped with an optional IEC/IEEE-bus connector. The mating connector according to IEEE 488 is at the rear of the instrument. A controller for remote control can be connected via the interface. The connection is effected using a shielded cable.

Characteristics of the Interface

- 8-bit parallel data transfer
- bidirectional data transfer
- three-line handshake
- high data transfer rate of max. 350 kByte/s
- up to 15 devices can be connected
- maximal length of the connecting cables 15 m (single connection 2m)
- wired OR if several instruments are connected in parallel.

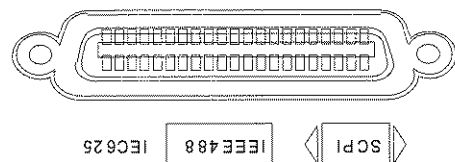

Fig. A3-1 IEC-Bus-Interface

Bus Lines

1. Data bus with 8 lines DIO 1 to DIO 8.
The transmission is bit-parallel and byte-serial in the ASCII/ISO code. DIO1 is the least significant, DIO8 the most significant bit.
2. Control bus with 5 lines.
IFC (Interface Clear),
active low resets the interfaces of the instruments connected to the default setting.
ATN (Attention),
active low signals the transmission of interface messages
inactive high signals the transmission of device-dependent messages.

Control character	Interface function
SH1	Handshake source function (source handshake)
AH1	Handshake drain function (acceptor handshake)
L4	Listener function.
T6	Talker function, ability to respond to serial poll
SR1	Service request function (Service Request)
PP1	Parallel poll function
RL1	Remote/Local switchover function
DC1	Resetting function (Device Clear)
DT1	Trigger function (Device Trigger)
C0	Controller function

Table A3-1 Interface functions

Instruments which can be remote-controlled via IEC bus can be equipped with different interface functions. Table A3-1 lists the interface functions appropriate for the instrument.

Interface Functions

NDAC (Not Data Accepted),
active low as long as the instrument connected is accepting the data present on the data bus.

NRFD (Not Ready For Data),
active low signals that one of the devices connected is not ready for data transfer.

DAV (Data Valid),
active low signals a valid data byte on the data bus.

3. Handshake bus with three lines.

EOI (End or Identify),
has two functions in connection with ATN:
active low marks the end of data transmission with ATN=high
active low triggers a parallel poll with ATN=low.

REN (Remote Enable),
active low permits the switchover to remote control.

SRQ (Service Request),
active low enables a device connected to send a service request to the controller.

Interface Messages

Interface messages are transmitted to the instrument on the data lines, with the attention line being active (LOW). They serve to communicate between instrument and controller.

Universal Commands

The universal commands are encoded in the range 10 through 1F hex. They act on all instruments connected to the bus without addressing them before.

Table A3-2 Universal Commands

Command	QuickBASIC command	Effect on the instrument
DCL (Device Clear)	IBCMD (controller%, CHR\$(20))	Aborts the processing of the commands just received and sets the command processing software to a defined initial state. Does not change the instrument setting.
IFC (Interface Clear)	IBSIC (controller%)	Resets the interfaces to the default setting.
LLO (Local Lockout)	IBCMD (controller%, CHR\$(17))	The LOC/IEC ADDR key is disabled.
SPE (Serial Poll Enable)	IBCMD (controller%, CHR\$(24))	Ready for serial poll.
SPD (Serial Poll Disable)	IBCMD (controller%, CHR\$(25))	End of serial poll.
PPU (Parallel Poll Unconfigure)	IBCMD (controller%, CHR\$(21))	End of the parallel-poll state.

Addressed Commands

The addressed commands are encoded in the range 00 through 0F hex. They are only effective for instruments addressed as listeners.

Table A3-3 Addressed Commands

Command	QuickBASIC command	Effect on the instrument
SDC (Selected Device Clear)	IBCLR (device%)	Aborts the processing of the commands just received and sets the command processing software to a defined initial state. Does not change the instrument setting.
GTL (Go to Local)	IBLOC (device%)	Transition to the "Local" state (manual control).
PPC (Parallel Poll Configure)	IBPPC (device%, data%)	Configure instrument for parallel poll. The QuickBASIC command additionally executes PPE/PPD.

Serial Interface

The instrument is equipped with a serial interface (RS-232-C) as standard. The 9-pin connector is located at the rear of the instrument. A controller for remote control can be connected via the interface. The connection is effected using a zero modem cable.

For remote control via the serial interface, an important aspect is to be noted:
 Some controllers already send characters on the serial interface during booting, causing the instrument to switch to the REMOTE state as soon as it receives these characters (since no explicit addressing is possible with the serial remote control).

Characteristics of the Interface

- serial data transfer
- bidirectional data transfer
- Software or hardware handshake
- Data transfer rate between 110 baud and 115200 baud
- Possible length of connecting cable > 20 m

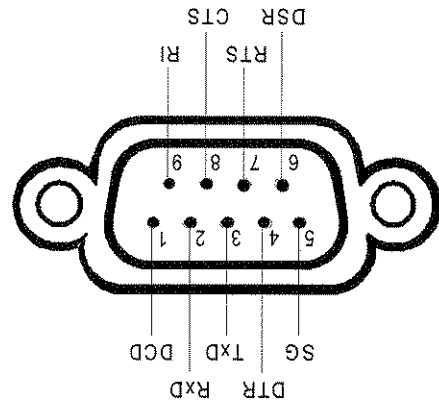

Fig. A3-2 RS232 interface

Designation	Pin (9-pin)	Pin (25-pin)
Data Carrier Detect	1	8
Receive Data	2	3
Transmit Data	3	2
Data Terminal Ready	4	20
Signal Ground	5	7
Data Set Ready	6	6
Request To Send	7	4
Clear To Send	8	5
Ring Indicator	9	21

Lines

1. Data lines

RxD (receive data) and **TxD** (transmit data)
 The transmission is bit-serial in the ASCII code starting with the LSB.
 The two lines are necessary as the minimum requirement for a transmission; however, no hardware handshake is possible, but only the XON/XOFF protocol.

2. Control lines

DCD (Data Carrier Detect), active LOW.
 Input; using this signal, the data terminal recognizes that the modem of the remote station receives valid signals with sufficient level. DCD is used to disable the receiver in the data terminal and prevent reading of false data if the modem cannot interpret the signals of the remote station.

DTR (Data Terminal Ready), active LOW.
 Output indicating that the data terminal is ready to receive data.

DSR (Data Set Ready), active LOW.
 Input indicating that the external device is ready to receive data.

RTS (Request To Send), active LOW.
 Output that can be used to indicate the readiness to receive data.

CTS (Clear To Send), active LOW.
 Input used to enable the transmission of data.

RI (Ring Indicator), active LOW.
 Input; RI is used by a modem to indicate that a remote station wants to set up a connection.

Default settings

The serial interface is set to the following values:

Table A3-4 Default setting

Parameter	Setting value
Baud rate	2400 baud
Data bits	8 bits
Stop bits	1 bits
Parity	none

Hardware handshake

In the case of the hardware handshake, the CMD indicates that it is ready to receive data via the lines DTR and RTS. A logic '0' on both lines means "ready" and a logic '1' means "not ready". The RTS line is always active (logic '0') as long as the serial interface is switched on. The DTR line thus controls the readiness of the CMD to receive data.

The readiness of the remote station to receive data is reported to the CMD via the CTS and DSR line. A logic '0' on both lines activates the data output and a logic '1' on both lines stops the data output of the CMD. The data output is effected via the TXD line.

Fig. A1-3 Wiring of the data lines for software handshake

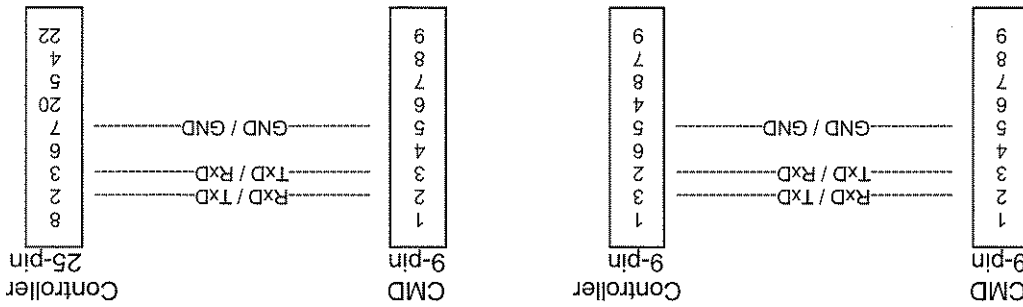

Cable for local controller coupling in the case of software handshake

The connection of the CMD with a controller in the case of software handshake is effected by crossing the data lines. The following wiring diagram applies to a controller with 9-pin or 25-pin configuration.

The controller indicates to the CMD that it is ready to receive data in the same way. The CMD uses the control character XON to indicate that it is ready to receive data. If the receive buffer is full, it sends the XOFF character via the interface to the controller. The controller then interrupts the data output until it receives another XON from the CMD.

Software handshake

In the case of the software handshake, the data transfer is controlled using the two control characters XON / XOFF.

Handshake

Cable for local controller coupling in the case of hardware handshake
 The connection of the CMD to a controller is effected with a so-called zero modem cable. In the case of this cable, the data, control and report lines must be crossed. The following wiring diagram applies to a controller with 9-pin or 25-pin configuration.

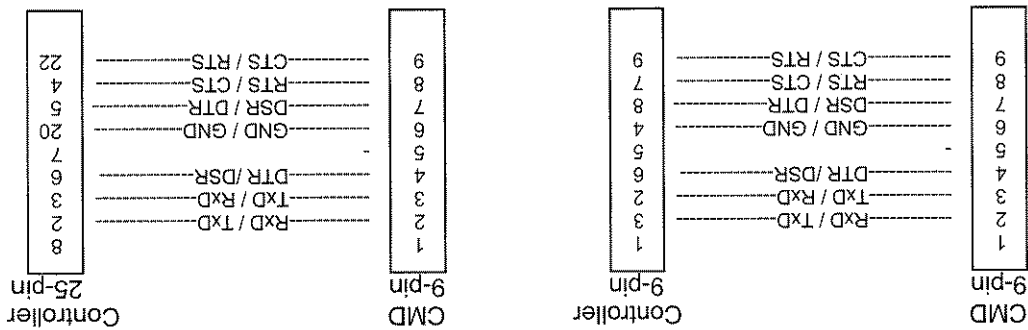

Fig. A3-4 Wiring of the data, control and report lines for hardware handshake

Annex B3

List of Error Messages

The following list contains all error messages for errors occurring in the instrument. The meaning of negative error codes is defined in SCP1, positive error codes mark errors specific of the instrument. The table contains the error code in the left-hand column. In the right-hand column the error text being entered into the error/event queue or being displayed is printed in bold face. Below the error text, there is an explanation as to the respective error.

SCP1-Specific Error Messages

No Error

Error code	Error text in the case of queue poll
0	No error This message is output if the error queue does not contain any entries.

Command Error - Faulty command; sets bit 5 in the ESR register.

Error code	Error text in the case of queue poll
-100	Command Error The command is faulty or invalid.
-101	Invalid Character The command contains an invalid sign. Example: A header contains an ampersand, "SOURCE &"
-102	Syntax error The command is invalid. Example: The command contains block data the instrument does not accept.
-103	Invalid separator The command contains an impermissible sign instead of a separator. Example: A semicolon is missing after the command.
-104	Data type error The command contains an invalid value indication. Example: ON is indicated instead of a numeric value for frequency setting.
-105	GET not allowed A Group Execute Trigger (GET) is within a command line.
-108	Parameter not allowed The command contains too many parameters. Example: Command CONFIGure:RFGen:FRFgeny permits only one frequency indication.

Error code	Error text in the case of queue poll	Error explanation
-109	Missing parameter The command contains too few parameters. Example: The command <code>CONFIGURE:RFGem:RFQemcy</code> requires a frequency indication.	
-111	Header separator error The header contains an impermissible separator. Example: the header is not followed by a "White Space", <code>"*ESB255"</code>	
-112	Program mnemonic too long The header contains more than 12 characters.	
-113	Undefined header The header is not defined for the instrument. Example: <code>*XYZ</code> is undefined for every instrument.	
-114	Header suffix out of range The header contains an impermissible numeric suffix. Example: <code>SOURCE3</code> does not exist in the instrument.	
-120	Numeric data error The command contains a faulty numeric parameter.	
-121	Invalid character in number A number contains an invalid character. Example: An "A" in a decimal number or a "9" in an octal number.	
-123	Exponent too large The absolute value of the exponent is greater than 3200.	
-124	Too many digits The number includes too many digits.	
-128	Numeric data not allowed The command includes a number which is not allowed at this position. Example: The command <code>SOURCE:RFGem:SELECT</code> requires indication of a text parameter.	
-131	Invalid suffix The suffix is invalid for this instrument. Example: <code>nHz</code> is not defined.	
-134	Suffix too long The suffix contains more than 12 characters.	
-138	Suffix not allowed A suffix is not allowed for this command or at this position of the command. Example: The command <code>*RCL</code> does not permit a suffix to be indicated.	
-141	Invalid character data The text parameter either contains an invalid character or it is invalid for this command. Example: write error with parameter indication; <code>SOURCE:RFGem:SELECT ST11</code> .	
-144	Character data too long The text parameter contains more than 12 characters.	
-148	Character data not allowed The text parameter is not allowed for this command or at this position of the command. Example: The command <code>*RCL</code> requires a number to be indicated.	

Continuation: Command Error

Error code	Error text in the case of queue poll Error explanation
-200	Execution error Error on execution of the command.
-221	Settings conflict There is a conflict between setting of parameter value and instrument state. Example: External attenuation has been set in a state other than IDLE.
-222	Data out of range The parameter value lies out of the permissible range of the instrument. Example: The command *RCL only permits entries in the range from 0 to 50.
-223	Too much data The command contains too many data. Example: The instrument does not have sufficient storage space.
-241	Hardware missing The command cannot be executed due to missing hardware. Example: An option is not fitted.

Execution Error - Error on execution of a command; sets bit 4 in the ESR register

Error code	Error text in the case of queue poll Error explanation
-151	Invalid string data The command contains a faulty string. Example: An END message has been received prior to the terminating apostrophe.
-158	String data not allowed The command contains a valid string at a position which is not allowed. Example: A text parameter is set in quotation marks, SOURCE:RFGn:SELECT "SRTTng1"
-161	Invalid block data The command contains faulty block data. Example: An END message was received prior to reception of the expected number of data.
-168	Block data not allowed The command contains valid block data at an impermissible position. Example:
-171	Invalid expression The command contains an invalid mathematical expression. Example: the expression contains mismatching parentheses.
-178	Expression data not allowed The command contains a mathematical expression at an impermissible position. Example:
-180	Macro error A faulty macro has been defined, or an error has occurred during execution of a macro.

Continuation: Command Error

Error code	Error text in the case of queue poll Error explanation
-400	Query error General error occurring when data are requested by a query.
-410	Query INTERRUPTED The query has been interrupted. Example: After a query, the instrument receives new data before the response has been sent completely.
-420	Query TERMINATED The query is incomplete. Example: The instrument is addressed as a talker and receives incomplete data.
-430	Query DEADLOCKED The query cannot be processed. Example: The input and output buffers are full, the instrument cannot continue operation.
-440	Query TERMINATED after indefinite response A query is in the same command line after a query which requests an indefinite response.

Query Error - Error in data request; sets bit 2 in the ESR register

Error code	Error text in the case of queue poll Error explanation
-300	Device-specific error Device specific error not defined in greater detail.
-350	Queue overflow This error code is entered in the queue instead of the actual error code if the queue is full. It indicates that an error has occurred but not been accepted. The queue can accept 5 entries.
-360	Communication error General error code if an allocation to error codes -361 to -363 is not possible.
-361	Parity error in program message The parity bit in the message received is not set correctly (eg at the serial interface).
-362	Framing error in program message No stop bit was found during reception (eg at the serial interface if transmitter and receiver have different baud rates).
-363	Input buffer overrun This error code indicates an overflow of the software and hardware input buffer of the serial interface.

Device Specific Error; sets bit 3 in the ESR register

Contents

CMD60

Contents

Appendix C3	1
1. General	1
States	1
Note	2
Error Recovery	2
RESET Values	2
2. Idle-Menu	3
3. Menu: Signalling PP-Test	4
4. Menu: Signalling FP-Test	6
5. Menus: Signalling PP-Test and Signalling FP-Test	9
6. Menu: Connection Established	10
Bearer Handover	10
Other commands	11
7. Menu: Power Ramp	12
8. Menu: RF-Modulation	14
9. Menu: Timing	17
10. Menu: Bit Error Rate	19
11. Configuration Menu	20
12. Menu: TX Test Configuration	21
13. Menu: Signalling PP-Test Configuration	22
14. Menu: Signalling FP-Test Configuration	24
15. Menu: Power Ramp Configuration	25
16. Menu: Modulation Configuration	27
17. Menu: Timing Configuration	29
18. Menu: Bit Error Rate Configuration	30
19. Menu: RF Connector / Ext. Attenuation	32
20. Menu: Synchronisation	33

21. AF Generator and Measurements 34
AF Generator Setting 34
AF Setting 35
AF Measurement 35
Multitone Audio Analysis 37
22. Current and Voltage Measurements 40
23. Burst Analysis 41
24. RF Generator 44
Configuration of a Generator Parameter Set 44
Setting the Current Generator Parameter Set 46
25. Miscellaneous 48
Saving and Loading of Instrument Setups 48
a) General Information 48
b) User Settings 49
c) Reset Operations 49
Remote / Local Switching 50
Calibration Mode 50
Internal Instrument state 51
Mandatory Commands 52
Optional Commands 54
STATUS Subsystem 54
SYSTEM Subsystem 55
Remarks 56
26. Summary of all Commands 57

Appendix C3

1. General

States

In the description of the commands, the following abbreviations are used for indication of the permissible states:

- IDLE: Initial state of the CMD60; is also achieved by means of PROCEDURE:SELECT[:TEST] NONE.
- DPP: DECT: Portable Part Test
- DFP: DECT: Fixed Part Test
- DCE: DECT: Connection Established
- DBAN: DECT: Burst Analysis active
- DRFG: DECT: RF Generator active
- ALL: All states (IDLE, DPP, DFP, DCE, DBAN, DRFG)

The following diagram explains the individual transitions of states:

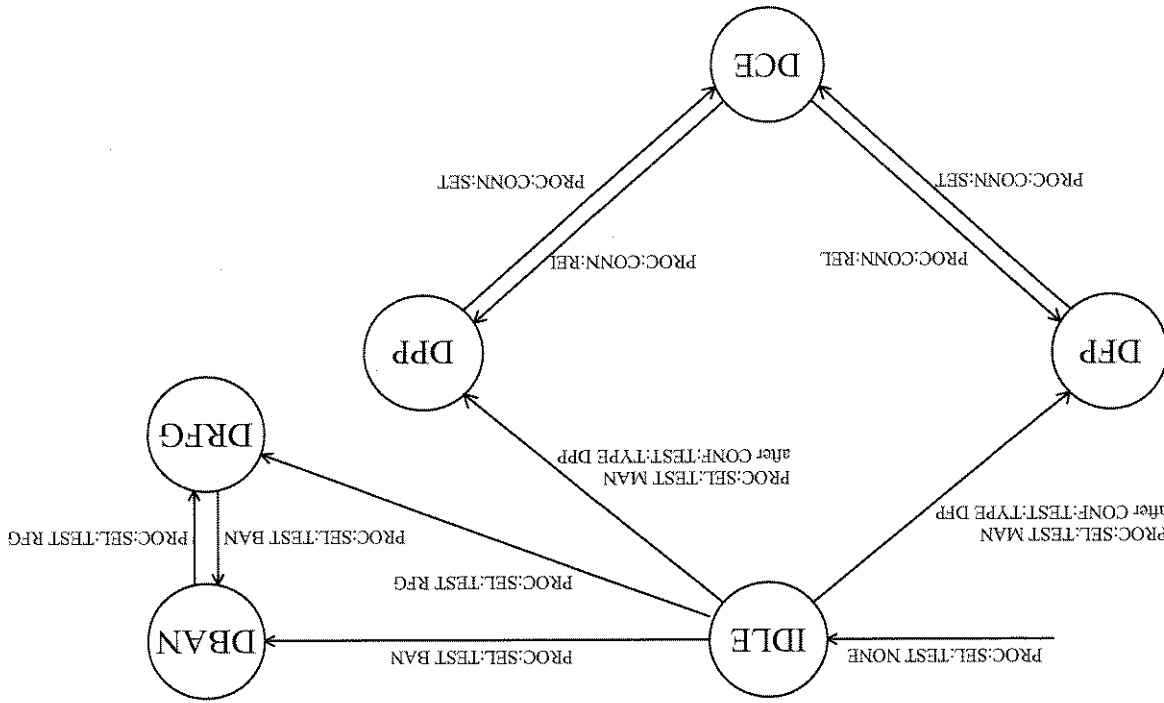

Unless otherwise specified, the values given in the column "Default" are set on RESET of the CMD60.

RESET Values

If no value is existing with queries or the value is invalid, NAN is returned instead of the value. An overflow of the value is indicated by INF, a missing input signal by means of NINF.

If the CMD60 is not in the right state to be able to carry out the command, SCP1 error -221, "Settings conflict" is generated. No value is returned in the case of queries.

The permissible state is indicated in the following table in the column "state".

If, however, an option to execute a command is missing, SCP1 error -241, "Hardware missing" is displayed. No result is returned either in the case of a query.

The option necessary to execute the command is entered in the tables under "option".

Error Recovery

All commands are structured analogously to the SCP1 description, i.e. the upper-case letters indicate the short form of the command; the CMD60 only accepts this short form as an abbreviation (according to SCP1), otherwise the long form is to be used.

<numeric_value> denotes a numeric value; MAXimum or MINimum can be indicated as well unless stated otherwise.

If <numeric_value> may contain a unit, indicating the unit is optional. The value is always returned without a unit.

<value> denotes a character data from a list; only list entries are permissible.

Note

2. Idle-Menu

Testype

Syntax:	CONFIGURE:TESTI:TYPE] <value>
Value range:	DecFP DecTP Default: DPP
State: Set: Query:	IDLE ALL Option: none With query

GAP-mode

Syntax:	CONFIGURE:GAP:MODE <value>
Value range:	ON OFF Default: OFF
State: Set: Query:	IDLE ALL Option: none With query

Testmode

Syntax:	PROCEDURE:SELECT[:TEST] <value>
Value range:	NONE MANUAL BANALYSIS RFGenerator no test mode (switch on state) DECT-Test DECT: Burst Analysis DECT: RF Generator Default: NONE
State: (NONE): ALL (MANUAL): IDLE (BANALYSIS): IDLE, DRFG (RFGenerator): IDLE, DBAN	Option: none With query

3. Menu: Signalling PP-Test

Radio Fixed Part Identity

Syntax:	CONFIGURE:PP:RFPI <string>
Value range:	10 digits in hex format
State: Set: Query: ALL, DPP	Option: none
	With query
Default: "0000000000"	

Portable Access Rights Key

Syntax:	CONFIGURE:GAP:PP:PAK <string>
Value range:	10 digits in hex format
State: Set: Query: ALL, DPP	Option: none
	With query
Default: "0000000000"	

International Portable User Identity

Syntax:	CONFIGURE:GAP:PP:PIUI <string>
Value range:	10 digits in hex format
State: Set: Query: ALL, DPP	Option: none
	With query
Default: "0000000000"	

Dummy Slot for PP Test

Syntax:	CONFIGURE:PP:DUMMY:SLOT <numeric_value>
Value range:	0 ... 11
State: Set: Query: ALL, DPP	Option: none
	With query
Note: The dummy slot must be different from the traffic slot by at least 2.	
Default: 0	

Dummy Carrier for PP Test

Syntax:	CONFIGURE:PP:DUMMY:CARRIER <numeric_value>
Value range:	0 ... 9
State: Set: Query: ALL, DPP	Option: none
	With query
Default: 0	

Traffic Slot for PP Test

Syntax:	CONFIGURE:PP:TRAFFIC:SLOT <numeric_value>
Value range:	0 ... 11 Default: 2
State: Set: IDLE, DPP Query: ALL	Option: none With query: With query Note: The dummy slot must be different from the traffic slot by at least 2.

Traffic Carrier for PP Test

Syntax:	CONFIGURE:PP:TRAFFIC:CARRIER <numeric_value>
Value range:	0 ... 9 Default: 0
State: Set: IDLE, DPP Query: ALL	Option: none With query: With query

RF Level

Syntax:	CONFIGURE:PP:RF:LEVEL <numeric_value>
Value range:	(N3) Default: -73.0 dBm
State: ALL	Option: none With query: With query

Signaling-Mode

Syntax:	CONFIGURE:PP:SIGNALLING:MODE <value>
Value range:	NORMAL LOOPBACK ECHO Default: LOOP
State: Set: IDLE, DPP Query: ALL	Option: none With query: With query

4. Menu: Signalling FP-Test

Radio Fixed Part Identity

Syntax:	CONFIGURE:FP:RFPI <string>
Value range:	10 digits in hex format
State: Set: Query: ALL, DPP	Option: none
	With query
Default: "0000000000"	

Portable Access Rights Key

Syntax:	CONFIGURE:GAP:FP:PARK <string>
Value range:	10 digits in hex format
State: Set: Query: ALL, DPP	Option: none
	With query
Default: "0000000000"	

International Portable User Identity

Syntax:	CONFIGURE:GAP:FP:IPUI <string>
Value range:	10 digits in hex format
State: Set: Query: ALL, DPP	Option: none
	With query
Default: "0000000000"	

Portable Part MAC Identity

Syntax:	CONFIGURE:FP:PMID <string>
Value range:	5 digits in hex format
State: Set: Query: ALL, DPP	Option: none
	With query
Default: "00000"	

Traffic Slot for FP Test

Syntax:	CONFIGURE:FP:TRAFIC:SLOT <numeric_value>
Value range:	0 ... 11
State: Set: Query: ALL, DPP	Option: none
	With query
Default: 0	

Traffic Carrier for FP Test

Syntax:	CONFIGURE:FP:TRAFIC:CARRIER <numeric_value>
Value range:	0 ... 9 Default: 0
State:	Set: IDLE, DFP Query: ALL Option: none With query

RF Level

Syntax:	CONFIGURE:FP:RF:LEVEL <numeric_value>
Value range:	(N3) Default: -73.0 dBm
State:	ALL Option: none With query

Signalling-Mode

Syntax:	CONFIGURE:FP:SIGNALLING:MODE <value>
Value range:	NORMAL LOOPBACK ECHO Default: LOOP
State:	Set: IDLE, DFP Query: ALL Option: none With query

Lock State

Syntax:	SENSE:SIGNALLING:STATE?
Value range:	LOCK UNL State: LOCKED State: UNLOCKED
State:	DFP Option: none Only query

Dummy Carrier of the DUT

Syntax:	SENSE:DETECTED:DUMMY:CARRIER?
Value range:	<value>
State:	DFP, DCE Option: none Only query

Dummy Slot of the DUT

Syntax:	SENSE:DETECTED:DUMMY:SLOT?
Value range:	<value>
State:	DFP, DCE Option: none Only query

Syntax:	SENSE:DETECTED:GAP];PARK?
Value range:	<string> (10 digits in hex format)
State: DFP, DCE	Option: none Only query

PARK of the DUT

Syntax:	SENSE:DETECTED:RFP?
Value range:	<string> (10 digits in hex format)
State: DFP, DCE	Option: none Only query

RFP of the DUT

Remote Control/Annex C

CMD60

5. Menus: Signalling PP-Test and Signalling FP-Test

Setup Connection

Syntax: Procedure:CONNECTION:SETup			
State: DFP, DPP	Option: none	No query	Note: Use the command STATUS:DEVICE? to check if the connection was established

6. Menu: Connection Established

Bearer Handover

Traffic Slot for PP Test

Syntax:		CONFIGURE:PP:TRAFfic:SLOT <numeric_value>	
Value range:	0 ... 11	Option: none	With query
State: Set: DCE		Query: ALL	
Value range:	0 ... 9	Option: none	With query
Syntax:		CONFIGURE:PP:TRAFfic:CARRier <numeric_value>	
Value range:	0 ... 11	Option: none	With query
State: Set: DCE		Query: ALL	
Value range:	0 ... 9	Option: none	With query
Syntax:		CONFIGURE:PP:TRAFfic:SLOT <numeric_value>	
Value range:	0 ... 11	Option: none	With query
State: Set: DCE		Query: ALL	

Traffic Carrier for PP Test

Syntax:		CONFIGURE:PP:TRAFfic:SLOT <numeric_value>	
Value range:	0 ... 11	Option: none	With query
State: Set: DCE		Query: ALL	
Value range:	0 ... 9	Option: none	With query
Syntax:		CONFIGURE:PP:TRAFfic:CARRier <numeric_value>	
Value range:	0 ... 11	Option: none	With query
State: Set: DCE		Query: ALL	
Value range:	0 ... 9	Option: none	With query
Syntax:		CONFIGURE:PP:TRAFfic:SLOT <numeric_value>	
Value range:	0 ... 11	Option: none	With query
State: Set: DCE		Query: ALL	

Traffic Slot for FP Test

Syntax:		CONFIGURE:PP:TRAFfic:SLOT <numeric_value>	
Value range:	0 ... 11	Option: none	With query
State: Set: DCE		Query: ALL	
Value range:	0 ... 9	Option: none	With query
Syntax:		CONFIGURE:PP:TRAFfic:CARRier <numeric_value>	
Value range:	0 ... 11	Option: none	With query
State: Set: DCE		Query: ALL	
Value range:	0 ... 9	Option: none	With query
Syntax:		CONFIGURE:PP:TRAFfic:SLOT <numeric_value>	
Value range:	0 ... 11	Option: none	With query
State: Set: DCE		Query: ALL	

Traffic Carrier for FP Test

Syntax:		CONFIGURE:PP:TRAFfic:SLOT <numeric_value>	
Value range:	0 ... 9	Option: none	With query
State: Set: DCE		Query: ALL	
Value range:	0 ... 9	Option: none	With query
Syntax:		CONFIGURE:PP:TRAFfic:CARRier <numeric_value>	
Value range:	0 ... 9	Option: none	With query
State: Set: DCE		Query: ALL	
Value range:	0 ... 9	Option: none	With query
Syntax:		CONFIGURE:PP:TRAFfic:SLOT <numeric_value>	
Value range:	0 ... 9	Option: none	With query
State: Set: DCE		Query: ALL	

Other commands

Connection Release

Syntax:	PROCEDURE:CONNECTION:Release
State: DCE	Option: none No query
Note: The CMD60 changes to the state DFP or DPP	

Sending of MT-Escape-sequence to DUT

Syntax:	SEND:MESSAGE:ESCAPE:MT
State: DCE	Option: none No query
Note: Refer also command CONFIGURE:MESSAGE:ESCAPE:MT	

PMID of the DUT

Syntax:	SENSE:DETECTED:PMID?
Value range:	<string> (5 digits in hex format)
State: DCE	Option: none Only query

7. Menu: Power Ramp

Pass/Fail verdict for Normal Transmit Power (NTP)

Syntax:	CALCulate:LIMIT:Power:TRANsmit:TOLerance:MATCHing?
Return:	(MATC NMAT INV)
State: DCE	Option: none Note: Returns the result of the last measurement (eg. READ:Power:TRANsmit:NORMal?), (N10), (N12)

Pass/Fail verdict for Power-Ramp

Syntax:	CALCulate:LIMIT:Power:TRANsmit:TEMPlate:MATChing?
Return:	MATC NMAT INV signal matches template signal does not match template no measurement result available
State: DCE	Option: none Note: Returns the result of the last measurement (N10), (N12)

Normal Transmit Power (NTP)

Syntax:	EXECute new measure-ment and signal result READ:SCALar:Power:TRANsmit:NORMal? FETCH:SCALar:Power:TRANsmit:NORMal?
Return:	<value> (Unit: dbm)
State: DCE	Option: none Note: (N10) Using the command READ:SCAL:NTF? there are no checks whether the measured power matches the power/time-template; therefore CALC:LIM:POW:TRAN:TEMP:MATC? will always return INV in this case.

Selection of a part of the burst power array

Syntax:	CONFigure:Power:TRANsmit:OUTPut:RANGE <numeric_value> [, <numeric_value>]
Value range:	start position: number of measurement values: -38 ... 462 1 ... 3000 (in steps of 1/6) Default: -38 3000
State: ALL	Option: none Note: • This settings are valid until a RESET (or power-off) of the device. • If the wanted number of measurement values after the start position exceeds the number of available values, it will be automatically corrected to the maximum possible number of values • Caution: This value remains active until it is explicitly changed. • Refer also to command READ:ARRay:Power:TRANsmit.

Power Ramp Signal

Syntax: Execute new measurement and signal result READ:ARRAY:Power:TRANSMIT? FETCH:ARRAY:Power:TRANSMIT?		Return: <Value> {, <Value>} (Unit: dB)	
State: DCE		Option: none	Note: Use the command CONFIGURE:Power:TRANSMIT:OUTPUT:RANGE to select the range, (N10)

8. Menu: RF-Modulation

Remote Control/Annex C

CMD60

Pass /Fail Verdict for Frequency Offset

State: DCE	Option: none	Only query	Note: Returns the result of the last measurement (eg. READ:FREQUENCY:OFFSET?), (N10), (N12)
Return:	(MATC NMAT INV)		
Syntax:	CALCULATE:LIMIT:FREQUENCY:OFFSET:TOLERANCE:MATCHING?		

Frequency Offset

State: DCE	Option: none	Only query	Note: Only available if Signalling-Mode is set to NORMAL (N10)
Return:	<Value> (Unit: Hz)		
Syntax: Execute new measurement and signal result	READ:SCALAR:FREQUENCY:OFFSET?	FETCH:SCALAR:FREQUENCY:OFFSET?	

Pass/Fail Verdict for B-Field Modulation

State: DCE	Option: none	Only query	Note: Returns the result of the last measurement, the first value is the positive value, the second is the negative one, (N10), (N12)
Return:	(MATC NMAT INV), (MATC NMAT INV)		
Syntax:	CALCULATE:LIMIT:BFIELD:TOLERANCE:MATCHING?		

B-Field Modulation

State: DCE	Option: none	Only query	Note: The first value is the positive value, the second is the negative one; (N10)
Return:	<Value>, <Value> (Unit: Hz)		
Syntax: Execute new measurement and signal result	READ:SCALAR:BFIELD?	FETCH:SCALAR:BFIELD?	

Pass/Fail verdict for Sync-Field Modulation

Syntax:	CALCULATE:LIMIT:FIELD:TOLERANCE:MATCHING?
Return:	(MATIC NMAT INV), (MATIC NMAT INV)
State: DCE	Option: none Only query
Note: Returns the result of the last measurement, the first value is the positive value, the second is the negative one, (N10), (N12)	

Sync-Field Modulation

Syntax:	READ:SCALAR:FIELD? FETCH:SCALAR:FIELD?
Return:	<Value>, <Value> (Unit: Hz)
State: DCE	Option: none Only query
Note: The first value is the positive value, the second is the negative one, (N10)	

Pass / Fail verdict for Frequency Drift

Syntax:	CALCULATE:LIMIT:FREQUENCY:DRIFT:TOLERANCE:MATCHING?
Return:	(MATIC NMAT INV)
State: DCE	Option: none Only query
Note: It's only measured, if signalling mode is set to LOOPBACK and if data type in B-Field is set to Fig31 or BS55 (otherwise returns INVALID) Returns the result of the last measurement (N10), (N12)	

Frequency Drift

Syntax:	READ:SCALAR:FREQUENCY:DRIFT? FETCH:SCALAR:FREQUENCY:DRIFT?
Return:	<Value> (Unit: Hz/s)
State: DCE	Option: none Only query
Note: It's only measured, if signalling mode is set to LOOPBACK and if data type in B-Field is set to Fig31 or BS55 (otherwise returns INVALID) (N10)	

State: DCE		Option: none	Only query	Note: Return 3000 values from bit -38 to 462 (6 values per bit), (N10)
Return:		<Value> { <Value> } (Unit: kHz)		
Syntax: Execute new measurement and signal result Only read result		READ:ARRAY:FREQUENCY:DEVIATION? FETCH:ARRAY:FREQUENCY:DEVIATION?		

FM-Demodulated Signal

State: DCE		Option: none	Only query	Note: The transmission of Z-field is only measured if the data type is set to PSRBS (otherwise returns INVALID), (N10)
Return:		(MATC NMAT INV)		
Syntax: Execute new measurement and signal result Only read result:		READ:XZField:MATCHing? FETCH:XZField:MATCHing?		

Transmission of Z-field

State: DCE		Option: none	Only query	Note: Frequency drift is only measured if the signalling mode is set to LOOPback and if the data type is set to Fig31 or BS55 (otherwise returns INVALID), (N10)
Return:		<value> (Unit: kHz/slot)		
Syntax: Execute new measurement and signal result Only read result:		READ:SCALAR:FREQUENCY:DRIFT:SLOT? FETCH:SCALAR:FREQUENCY:DRIFT:SLOT?		

Frequency Drift (kHz/slot)

State: DCE		Option: none	Only query	Note: Frequency drift is only measured if the signalling mode is set to LOOPback and if the data type is set to Fig31 or BS55 (otherwise returns INVALID), (N10)
Return:		<value> (Unit: kHz/ms)		
Syntax: Execute new measurement and signal result Only read result:		READ:SCALAR:FREQUENCY:DRIFT:MS? FETCH:SCALAR:FREQUENCY:DRIFT:MS?		

Frequency Drift (kHz/ms)

9. Menu: Timing

Pass/Fail Verdict for Time Accuracy

Syntax:	CALCULATE:LIMIT:TIME:Accuracy:Tolerance:MATCHing?
Return:	(MATCH NMAT INV)
State: DCE	Option: none Only query
Note: Returns the result of the last measurement (N10), (N12)	

Time Accuracy

Syntax:	EXECUTE:NEW:MEASUREMENT:AND:SIGNAL:RESULT READ[:SCALAR]:TIME:Accuracy?
Return:	<Value> (Unit: ppm)
State: DCE	Option: none Only query
Note: (N10)	

Pass / Fail Verdict for Jitter

Syntax:	CALCULATE:LIMIT:JITTER:Tolerance:MATCHing?
Return:	(MATCH NMAT INV), (MATCH NMAT INV)
State: DCE	Option: none Only query
Note: Returns the result of the last measurement, the first value is the positive value, the second is the negative one, (N10), (N12)	

Jitter

Syntax:	EXECUTE:NEW:MEASUREMENT:AND:SIGNAL:RESULT READ[:SCALAR]:JITTER?
Return:	<Value>, <Value> (Unit: sec)
State: DCE	Option: none Only query
Note: The first value is the positive value, the second is the negative one, (N10)	

State: DCE (PP test only)		Option: none	Only query	Note: The first value is the minimum value, the second is the maximum one, (N10)
Return:	<Value>, <Value> (Unit: sec)			
Syntax: Execute new measurement and signal result	Only read result	READ]:SCALAR]:PACKET:DELAY?	FETCH]:SCALAR]:PACKET:DELAY?	

Packet Transmission Accuracy of a PP

State: DCE (PP test only)		Option: none	Only query	Note: Returns the result of the last measurement, the first value is the result for the minimum, the second is the result for the maximum, (N10), (N12)
Return:	(MATC NMAT INV), (MATC NMAT INV)			
Syntax:	CALCULATE:LIMIT:PACKET:DELAY:TOLERANCE:MATCHING?			

Pass / Fail Verdict for Packet Transmission Accuracy of a PP

10. Menu: Bit Error Rate

RF Level

Syntax:	CONFigure:BER:RF:LEVel <numeric_value>
Value range:	(N3)
State: DCE	Option: none With query
Default: -73.0 dbm	

Control of Transmitter Deviation (BER Measurements)

Syntax:	CONFigure:BER:RF:DEviation <numeric_value>
Value range:	0 ... 510 KHZ
State: DCE	Option: none With query
Default: 288 KHZ	

Pass / Fail Verdict for LongTerm BER and FER

Syntax:	CALCulate:LIMIT:BER:LTERM:TOLerance:MATChing?
Return:	(MATC NMAT INV), (MATC NMAT INV)
State: DCE	Option: none Only query
Note:	Returns the result of the last measurement; the first value is the BER value, the second one the FER value; (N10), (N12)

LongTerm BER and FER

Syntax:	EXECute new measure-ment and signal result READ]:SCALar]:BER:LTERM?
Return:	<Value>, <Value> (Unit: BER none, FER %)
State: DCE	Option: none Only query
Note:	The first value is the BER value, the second one the FER value, (N10)

Multi Bearer

Syntax:	EXECute new measure-ment and signal result READ:ARRAY:BER:MBearer?
Return:	<Value> {, <Value>}
State: DCE	Option: none Only query
Note:	Indicates the slot(s) where successfully measurement(s) was (were) possible (N10)

11. Configuration Menu

IEEE-Bus-Address

Syntax:	SYSTEM:COMMunicate:GPiB:SELf]:ADDRESS <numeric_value>	
Value range:	0 ... 30	Default: 1
State: ALL	Option: none	With query

12. Menu: TX Test Configuration

Definition of the MT escape sequence

Syntax:	CONFIGURE:MESSAGE:ESCAPE:MT <string>		
Value range:	10 digits in hex format	State: ALL	Option: none
Default: "7000000000"		Example: The string "22<x>F0F0F0F" sets the antenna diversity to antenna <x> ∈ {0..7}	With query

13. Menu: Signalling PP-Test Configuration

Remote Control/Annex C

CMD60

Dummy Mode for PP Test

Syntax:	CONFIGURE:PP:DUMMY:MODE <value>
Value range:	ON OFF Dummy is still available after connection switch Dummy off after connection Default: OFF
State: Set: IDLE, DPP Query: ALL	Option: none With query
Note: The dummy bearer restricts the use of the multi bearer feature in the BFR measurement	

Carrier Offset for PP Test

Syntax:	CONFIGURE:PP:CARRIER:OFFSet <numeric_value>
Value range:	-3.0 ... +3.0 (in steps of 0.5) Default: 0.0
State: Set: IDLE, DPP Query: ALL	Option: none With query

Static System Info

Syntax:	CONFIGURE:PP:PROTOTYPE:SYSTEM:INFO <string>
Value range:	12 digits in hex format Default: "000003FF0000"
State: Set: IDLE, DPP Query: ALL	Option: none With query

Fixed Part Capabilities

Syntax:	CONFIGURE:PP:PROTOTYPE:FP:CAPability <string>
Value range:	12 digits in hex format Default: "00341108008"
State: Set: IDLE, DPP Query: ALL	Option: none With query

Multiframe Number

Syntax:	CONFIGURE:PP:PROTOTYPE:MULTiframe <string>
Value range:	12 digits in hex format Default: "006F0F000000"
State: Set: IDLE, DPP Query: ALL	Option: none With query

Additional Q Packet

Syntax: CONFIGURE:PP:PROTotype:QPACKet:ADDITIONal <string>	
Value range: 12 digits in hex format	State: Set: IDLE, DPP Query: ALL Option: none With query
Default: "000000000000"	

Q Packet Multiplex Sequence

Syntax: CONFIGURE:PP:TABLE:QPACKet:SEQUence <string>	
Value range: 8 digits out of 0, 3, 6, E	State: Set: IDLE, DPP Query: ALL Option: none With query
Default: "03060306"	

Scrambling Selectable (PP)

Syntax: CONFIGURE:PP:SCRAMble <value>	
Value range: ON OFF	State: Set: IDLE, DPP Query: ALL Option: none With query
Default: OFF	

14. Menu: Signalling FP-Test Configuration

Antenna of the Fix-Part

Syntax:		CONFIGure:FP:ANTenna <numeric_value>
Value range:	0 .. 7	Default: 0
State: Set:	IDLE,DFP	Option: none
Query:	ALL	With query

Carrier Offset for FP Test

Syntax:		CONFIGure:FP:CARRIER:OFFSet <numeric_value>
Value range:	-3.0 ... +3.0 (in steps of 0.5)	Default: 0.0
State: Set:	IDLE,DFP	Option: none
Query:	ALL	With query

Scrambling Selectable (FP)

Syntax:		CONFIGure:FP:SCRamble <value>
Value range:	ON OFF	Default: OFF
State: Set:	IDLE,DFP	Option: none
Query:	ALL	With query

15. Menu: Power Ramp Configuration

Reset to Default Values for Power Ramp and NTP

Syntax: CALCulate:LIMit:Power:TRANsmitt:TEMPlate:CLEar		State: ALL	Option: none	No query
--	--	------------	--------------	----------

NTP Tolerance Range

Syntax: CALCulate:LIMit:Power:TRANsmitt:TEMPlate:TOLerance:LOWer:DATA] <numeric_value>		State: ALL	Option: none	With query	Note: Lower < UPPER must be fulfilled
Value range: 0.0 ... 30.0 dbm		Default: 20.0 dbm 25.0 dbm			

Tolerance Range for Power-Time-Template

The level designations used in the power time template for the command CALCulate:LIMit:Power:TRANsmitt:TEMPlate]:DATA] can be obtained from the following illustration:

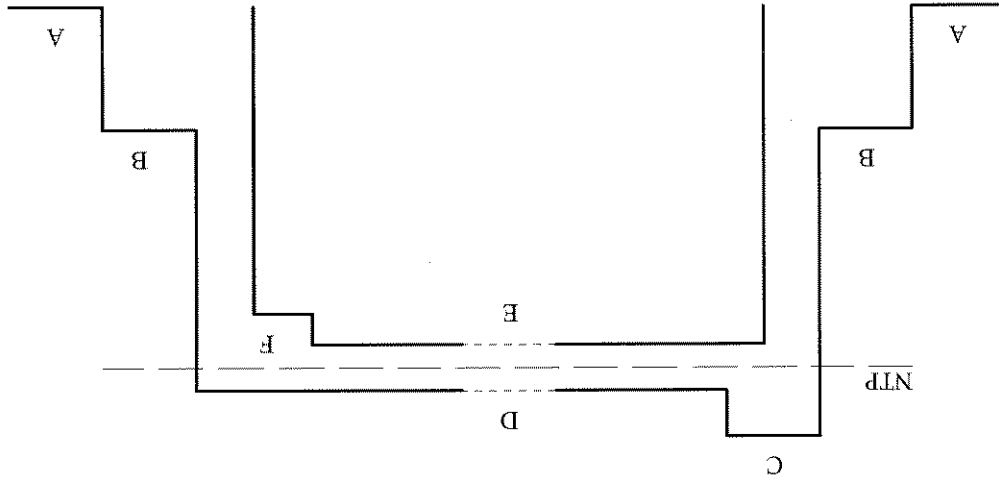

Syntax: CALCulate:LIMit:Power:TRANsmitt:TEMPlate]:DATA] <numeric_value>, <numeric_value>, <numeric_value>		State: ALL	Option: none	With query	
Value range:		0.0 ... 100.0 nW	0.0 ... 100.0 dB	Absolute level at A	
		0.0 ... 10.0 dB	0.0 ... 10.0 dB	Relative level at B	
		0.0 ... 10.0 dB	0.0 ... 10.0 dB	Relative level at C	
		0.0 ... 10.0 dB	0.0 ... 10.0 dB	Relative level at D	
		-10.0 ... 0.0 dB	-10.0 ... 0.0 dB	Relative level at E	
		-20.0 ... 0.0 dB	-20.0 ... 0.0 dB	Relative level at F	
Default: 20.0 nW 25.0 dB		+4.0 dB	+1.0 dB	-1.0 dB	-6.0 dB

State: ALL		Option: none	With query
Syntax:	CONFIGure:POWer:PACKet[:TYPe] <value>		
Value range:	P32 P32Z PP32 PP32Z (note that PP32Z needs 5 characters to be recognized properly)		
	Default: P32Z		

Packet Type (Power Ramp Measurements)

State: ALL		Option: none	With query
Syntax:	CONFIGure:AVERage:BURSt <numeric_value>		
Value range:	1 ... 12000		
	Default: 4		

Number of bursts for NTP and MAX/MIN-Modulation

State: Set: IDLE		Option: none	With query
Query: ALL			
Syntax:	CONFIGure:POWer:DYNAmic:RANGe <value>		
Value range:	HIGH LOW		
	Default: LOW		

Dynamic Range

16. Menu: Modulation Configuration

Reset to Default Value

Syntax: CALCulate:LIMIT:MODulation:CLear		State: ALL	Option: none	No query
--	--	------------	--------------	----------

Tolerance Range for Frequency Offset

Syntax: CALCulate:LIMIT:FREQuency:OFFSet:TOLerance[:DATA] <numeric_value>		Value range: 0.0 ... 500.0 KHz	State: ALL	Option: none	With query	Note: The tolerance range is symmetrical
Default: 50.0 KHz						

Tolerance Range for B-Field Modulation

Syntax: CALCulate:LIMIT:BField:TOLerance[:DATA] <numeric_value>, <numeric_value>		Value range: 0.0 ... 500.0 KHz	State: ALL	Option: none	With query	Note: The tolerance range is symmetrical. The first value is minimum, the second one is maximum tolerance
Default: 259.0 KHz						

Tolerance Range for Sync-Field

Syntax: CALCulate:LIMIT:SField:TOLerance[:DATA] <numeric_value>, <numeric_value>		Value range: 0.0 ... 500.0 KHz	State: ALL	Option: none	With query	Note: The tolerance range is symmetrical. The first value is minimum, the second one is maximum tolerance
Default: 202.0 KHz						

Selectable Units for Frequency Drift

Syntax: CONFIGure:MODulation:DRIFT:UNIT <value>		Value range: SLOT MS	State: ALL	Option: none	With query	Note: This affects the default value set for the frequency drift tolerance range.
Default: MS						

Tolerance Range for Frequency Drift

State: ALL		Option: none	With query	Note: The tolerance range is symmetrical. The default value depends upon the currently selected frequency drift units. The defaults are 13.066 Hz/s for kHz/ms (13kHz/ms) and 3.6e7 Hz/s for kHz/slot (15kHz/slot).
Syntax:	Calculate:LIMIT:FREQUENCY:DRIFT:Tolerance <numeric_value>	Value range:	0.0 ... 1.0e8 Hz/s	Default: 13.066 Hz/s 4.3e7 Hz/s

Tolerance Range for Frequency Drift (kHz/ms)

State: ALL		Option: none	With query	Note: The tolerance range is symmetrical. The default value depends upon the currently selected frequency drift units. The defaults are 13 kHz/ms for kHz/ms and 54 kHz/ms for kHz/slot (15kHz/slot).
Syntax:	Calculate:LIMIT:FREQUENCY:DRIFT:Tolerance:MS <numeric_value>	Value range:	0.0 ... 100.0 kHz/ms	Default: 13 kHz/ms 43 kHz/ms

Tolerance Range for Frequency Drift (kHz/slot)

State: ALL		Option: none	With query	Note: The tolerance range is symmetrical. The default value depends upon the currently selected frequency drift units. The defaults are 5.4 kHz/slot for kHz/slot and 15 kHz/slot for kHz/slot.
Syntax:	Calculate:LIMIT:FREQUENCY:DRIFT:Tolerance:SLOT <numeric_value>	Value range:	0.0 ... 35.0 kHz/slot	Default: 15 kHz/slot 4.5 kHz/slot

Data type in B-Field

State: ALL		Option: none	With query	
Syntax:	CONFIGure:MODulation:DATA:TYPE] <value>	Value range:	PSRbs PSRbs Static pseudo random bit sequence Pseudo random bit sequence Bit sequence 01010101 (= 55 hex) Bit sequence 00110011 (= 33 hex) Bit sequence 00001111 (= 0F hex) Fig31 See CRT 06 Fig 31	Default: Fig31

17. Menu: Timing Configuration

Number of bursts for timing measurement

Syntax: CONFIGURE:TIMING:AVERAGE:BURST <numeric_value>		Value range: 2 .. 1000	State: ALL
Default: 32			Option: none With query

Reset to Default Value

Syntax: CALCULATE:LIMIT:TIMING:CLEAR		State: ALL
	Option: none No query	

Tolerance Range for Time Accuracy

Syntax: CALCULATE:LIMIT:TIME:ACCURACY:TOLERANCE:DATA <numeric_value>		Value range: 0.0 ... 100.0 ppm	State: ALL
Default: 5.0 ppm			Option: none With query Note: The tolerance range is symmetrical

Tolerance Range for Jitter

Syntax: CALCULATE:LIMIT:JITTER:TOLERANCE:DATA <numeric_value>		Value range: -100.0 ... 0.0 ps	State: ALL
Default: Minimum: -1.0 ps Maximum: 1.0 ps			Option: none With query Note: The first value is minimum, the second one is maximum tolerance

Tolerance Range for Packet Transmission Accuracy

Syntax: CALCULATE:LIMIT:PACKET:DELAY:TOLERANCE:DATA <numeric_value>, <numeric_value>		Value range: -5.0 ... +5.0 ps	State: ALL
Default: -2.0 ps +2.0 ps	Tolerance for minimum Tolerance for maximum		Option: none With query Note: The tolerance range is symmetrical

18. Menu: Bit Error Rate Configuration

Reset to Default Value

Syntax:	CALCULATE:LIMIT:BER:LTERM:CLEAR
State: ALL	Option: none Note: No query

Tolerance Range for LongTerm BER and FER

Syntax:	CALCULATE:LIMIT:BER:LTERM:TOLERANCE[DATA] <numeric_value>; <numeric_value>
Value range:	BER: 0.0 ... 10.0 % FER: 0.0 ... 10.0 % Default: 0.1 %
State: ALL	Option: none Note: The first value is the BER range, the second one the FER range With query

PP: Get Multi Bearer Array

Syntax:	CONFIGURE:BER:PP:MBEARER?
Return:	[<value> { <value>}]
State: ALL	Option: none Note: Returns all slots currently selected in the PP multi bearer array Only query

PP: Addition of a Slot Number in Multi Bearer Array

Syntax:	CONFIGURE:BER:PP:MBEARER:SLOT <numeric_value>
Value range:	0 ... 11 Default: Traffic slot for PP test
State: ALL	Option: none Note: 5 additional slots can be selected. The neighbour slots of a selected slot must be free No query

PP: Clear Multi Bearer Array

Syntax:	CONFIGURE:BER:PP:MBEARER:CLEAR
State: ALL	Option: none Note: This command deletes all entries in the PP multi bearer array but the current PP traffic slot No query

FP: Get Multi Bearer Array

Syntax:	CONFIGURE:BER:FP:MBearer?
Return:	[<Value> {, <Value>}]
State:	ALL
Option:	none
Only query:	Yes
Note:	Returns all slots currently selected in the FP multi bearer array

FP: Addition of a Slot Number in Multi Bearer Array

Syntax:	CONFIGURE:BER:FP:MBearer:SLOT <numeric,value>
Value range:	0 ... 11
Default:	Traffic slot for FP test
State:	ALL
Option:	none
Only query:	Yes
Note:	One additional slot can be selected. The slot must not be a neighbour of the traffic slot

FP: Clear Multi Bearer Array

Syntax:	CONFIGURE:BER:FP:MBearer:CLEAR
State:	ALL
Option:	none
Only query:	Yes
Note:	This command deletes all entries in the FP multi bearer array but the current FP traffic slot

Evaluation Window

Syntax:	CONFIGURE:BER:EVALUATION:WINDOW:BITS] <numeric,value>
Value range:	1 ... 30e6 (* 320 bits)
Default:	100
State:	ALL
Option:	none
With query:	Yes

Time of evaluation window

Syntax:	CONFIGURE:BER:EVALUATION:WINDOW:TIME?
Rückgabe:	<value> (Unit: sec)
State:	ALL
Option:	none
Only query:	Yes

Data type in B-Field

Syntax:	CONFIGURE:BER:DATA[:TYPE] <value>
Value range:	PSRBs SPSPBs BS55 BS33 BSOF Fig31 Pseudo random bit sequence Static pseudo random bit sequence Bit sequence 01010101 (= 55 hex) Bit sequence 00110011 (= 33 hex) Bit sequence 00001111 (= 0F hex) See CRT 06 Fig 31
Default:	Fig31
State:	ALL
Option:	none
With query:	Yes

19. Menu: RF Connector / Ext. Attenuation

Remote Control/Annex C **CMD60**

External attenuation at RF In Out

Syntax:	SENSE1:CORREction:LOSS:INPut[:MAGNitude] <numeric_value> OR SOURCE1:CORREction:LOSS:OUTPut[:MAGNitude] <numeric_value>	Value range:	-40.0 ... +50.0 dB	State: IDLE	Option: none	with query	Note: Positive values refer to an attenuation, (N1)
Default: 0.0 dB							

External attenuation at RF In 2

Syntax:	SENSE2:CORREction:LOSS:INPut[:MAGNitude] <numeric_value>	Value range:	-40.0 ... +90.0 dB	State: IDLE	Option: none	with query	Note: Positive values refer to an attenuation, (N1)
Default: 0.0 dB							

External attenuation at RF Out 2

Syntax:	SOURCE2:CORREction:LOSS:OUTPut[:MAGNitude] <numeric_value>	Value range:	-40.0 ... +90.0 dB	State: IDLE	Option: none	with query	Note: Positive values refer to an attenuation, (N1)
Default: 0.0 dB							

Selected input and output connector

Syntax:	ROUTe:IOConnector <value>	Value Range:	1101 1102 1201 1202 Input: RF In Out Output: RF In Out 1101 1102 Input: RF In Out Output: RF In Out 1201 1202 Input: RF In 2; Output: RF In Out 1101 1102 Input: RF In Out Output: RF In Out 1201 1202 Input: RF In 2; Output: RF In Out	State: IDLE	Option: none	with query	Note: (N2)
Default: 1101							

20. Menu: Synchronisation

Reference Frequency (Input)

Syntax:		CONFIGURE:SYNC:FREQUENCY:REFERENCE <value>	
Value range:	E10M Extern, 10 MHz Intern, 10 MHz	Option: none	With query
State: IDLE			

Reference Frequency (output at connector REF OUT 3)

Syntax:		CONFIGURE:SYNC:FREQUENCY:OUTPUT:REFERENCE <value>	
Value range:	Oscillator1 Frequency: 13.825 MHz Oscillator2 Frequency: 6.912 MHz (= OS1 / 2) Oscillator4 Frequency: 3.456 MHz (= OS1 / 4) Oscillator12 Frequency: 1.152 MHz (= OS1 / 12) Oscillator24 Frequency: 576.0 KHz (= OS1 / 24) Oscillator48 Frequency: 288.0 KHz (= OS1 / 48) Oscillator96 Frequency: 144.0 KHz (= OS1 / 96)	Option: none	With query
State: IDLE			

Synchronisation Port

Syntax:		CONFIGURE:SYNC:PORT <value>	
Value range:	MASTER CMD transmits on this port SLAVE CMD's timing is synchronized on this port	Option: none	With query
State: IDLE			

21. AF Generator and Measurements

AF Generator Setting

Frequency

State: ALL		Option: B41	with query
Syntax:	CONFIGure:AFGen:FREquency:CW :FIXed] <numeric_value>		
Value range:	20.0 ... 10000.0 Hz		
Default: 1000.0 Hz			

Level

State: ALL		Option: B41	With query
Syntax:	CONFIGure:AFGen:VOLTage <numeric_value>		
Value range:	10.0 µV ... 5.0 V ON OFF (in steps of 10 µV)		
Default: 1.0 V			

Speech Coder

State: ALL		Option: B41	With query
Syntax:	CONFIGure:AFGen:ADPCM <value>		
Value range:	ON OFF The source of the speech coder is the AF generator The source of the speech coder is the multifunction connector		
Default: OFF			

Switching generator on and off

State: ALL		Option: B41	with query
Syntax:	SOURCE:AFGen:STATE <value>		
Value range:	ON OFF Switch generator on Switch generator off		
Default: OFF			

AF Setting

Distortion frequency

Syntax:		CONFIGure:AFMeas:FREQUENCY:DIStortion <numeric,value>
Value range:	50.0 ... 5000.0 Hz	
State:	ALL	Option: B41
		With query
Default:	1000.0 Hz	

Lower limit frequency (for distortion meter and voltmeter)

Syntax:		CONFIGure:AFMeas:FREQUENCY:MIInimum <numeric,value>
Value range:	10 ... 1000 Hz	
State:	ALL	Option: B41
		With query
Note: This setting also affects the duration of measurement.		
Default:	100 Hz	

AF Measurement

Display format of AF counter

Syntax:		CONFIGure:AFMeas:COUNter:FORMat <value>
Value range:	LT10kHz LT30mhz LT60mhz GT10kHz	Frequency to measure < 10 kHz Frequency to measure < 30 MHz Frequency to measure < 60 MHz same as LT60mhz
State:	ALL	Option: B41
		With query
Default:	LT10	

Display format of voltmeter

Syntax:		CONFIGure:AFMeas:VOLTage:FORMat <value>
Value range:	RMS SQRTms	
State:	ALL	Option: B41
		With query
Default:	RMS	

Input

Syntax:		CONFIGure:AFMeas:INPut <value>
Value range:	AFVoltmeter ADPCm	Connector AF-VOLTMETER Signal of speech decoder
State:	ALL	Option: B41
		With query
Default:	AFVoltmeter	

State: ALL	Option: B41	only query	Note: No default value
Return:	<value> (unit: %)		
Syntax:	Execute new measurement and signal result Only read result READ[:SCALar]:AFMeas:DISTortion? FETCH[:SCALar]:AFMeas:DISTortion?		

Distortion

State: ALL	Option: B41	only query	Note: No default value
Return:	<Value> (Unit: V)		
Syntax:	Perform new measurement and signal result Only read result READ[:SCALar]:AFMeas:VOLTage? FETCH[:SCALar]:AFMeas:VOLTage?		

AF voltage

State: ALL	Option: B41	only query	Note: No default value
Return:	<Value> (Unit: Hz)		
Syntax:	Execute new measurement and signal result Only read result READ[:SCALar]:AFMeas:COUNter? FETCH[:SCALar]:AFMeas:COUNter?		

AF counter

State: ALL	Option: B41	With query	
Value range:	500.0 ... 5000.0 Hz ON OFF		
Syntax:	CONFIGure:AFMeas:VOLTage:BPASS:FREQuency <numeric_value> Default: OFF		

Center frequency of voltmeter

State: ALL	Option: B41	With query	
Value range:	10.0 ... 1000.0 Hz		
Syntax:	CONFIGure:AFMeas:VOLTage:BPASS:WIDTh <numeric_value> Default: 300.0 Hz		

Bandwidth of voltmeter

Multitone Audio Analysis

Frequencies for the Multitone Audio Analysis

State: ALL		Option: B41 and B44	With query
Syntax: Set a single frequency: CONFfigure:MAA:FREQUENCY1[:CW]:FIXed] <numeric_value> ... CONFfigure:MAA:FREQUENCY14[:CW]:FIXed] <numeric_value> CONFfigure:MAA:FREQUENCY:ALL <numeric_value>, <numeric_value>, <numeric_value>, <numeric_value>, <numeric_value>, <numeric_value>, <numeric_value>, <numeric_value>, <numeric_value>, <numeric_value>, <numeric_value>, <numeric_value>	Value range: 50 ... 8460 Hz ON OFF	Default: Frequency (Hz): 200 250 315 400 500 630 800 1 2 3 4 5 6 7 8 9 10 11 12 13 14 1000 1250 1600 2000 2500 3150 4000	
		Set all frequencies:	

Levels for the Multitone Audio Analysis

State: ALL		Option: B41 and B44	With query
Syntax: Set a single level: CONFfigure:MAA:VOLTage1 <numeric_value> ... CONFfigure:MAA:VOLTage14 <numeric_value> CONFfigure:MAA:VOLTage:ALL <numeric_value>, <numeric_value>, <numeric_value>, <numeric_value>, <numeric_value>, <numeric_value>, <numeric_value>, <numeric_value>, <numeric_value>, <numeric_value>, <numeric_value>, <numeric_value>	Value range: 1.0 mV ... 5.0 V -57.7 dbm ... 16.1 dbm ON OFF	Note: • The sum of all levels may not exceed 5.0 V. • The conversion between Volt and dbm assumes 600 Ω	
		Set all levels:	

Reference level for the Multitone Audio Analysis

State: ALL		Option: B41 and B44	With query
Value range: 0.0 ... 9.999 V -57.7 dbm ... 22.2 dbm		Note: Valid only for result type RREF (CONF:MAA:FORM))	
Syntax: CONFfigure:MAA:VOLTage:REFERENCE <numeric_value>			

Generator Lead Time for the Multitone Audio Analysis

State: ALL		Option: B41 and B44	With query
Syntax:	CONFIGURE:MAA:TIME:LEAD <numeric_value>		
Value range:	0.0 ... 65.0 s	Default: 0.0 s	

Result Type for the Multitone Audio Analysis

State: ALL		Option: B41 and B44	With query
Syntax:	CONFIGURE:MAA:FORMAT <value>		
Value range:	AbsLIN AbsLOG RaIGEN RaIREF ReIT1 ReIT14	Default: ALIN	

Reset to Default Values

Syntax:	CALCULATE:LIMIT:MAA:CLEAR
State: ALL	Option: B41 and B44 With query

Absolute Result Tolerance Range

State: ALL		Option: B41 and B44	With query	Note: For all limits must be valid: Upper limit - lower limit ≥ 1 mV
Syntax:	Set a single limit CALCULATE:LIMIT:MAA:VOLTage1:ABSolute <numeric_value>, <numeric_value> ... CALCULATE:LIMIT:MAA:VOLTage14:ABSolute <numeric_value>, <numeric_value>			
Set all Lower Limits:	CALCULATE:LIMIT:MAA:VOLTage:ABSolute:LOWer:ALL <numeric_value>, <numeric_value>, <numeric_value>, <numeric_value>, <numeric_value>			
Set all Upper Limits:	CALCULATE:LIMIT:MAA:VOLTage:ABSolute:UPPer:ALL <numeric_value>, <numeric_value>, <numeric_value>, <numeric_value>, <numeric_value>			
Value range:	0.0 ... 9.999 V -57.7 dBm ... 22.2 dBm	Default: Lower limits: 8 mV Upper limits: 12 mV		

Relative Result Tolerance Range

Syntax: Set a single limit: CALCulate:LIMIT:MAA:VOLTage1:Relative <numeric_value>, <numeric_value> (Upper limit) ... CALCulate:LIMIT:MAA:VOLTage14:Relative <numeric_value>, <numeric_value> Set all Lower Limits: CALCulate:LIMIT:MAA:VOLTage:Relative:LOWer:ALL <numeric_value>, <numeric_value>, <numeric_value>, <numeric_value>, <numeric_value> <numeric_value>, <numeric_value>, <numeric_value>, <numeric_value>, <numeric_value> Set all Upper Limits: CALCulate:LIMIT:MAA:VOLTage:Relative:UPPer:ALL <numeric_value>, <numeric_value>, <numeric_value>, <numeric_value>, <numeric_value> <numeric_value>, <numeric_value>, <numeric_value>, <numeric_value>, <numeric_value>	Value range: -80.0 ... +80.0 dB Default: Lower limits: -3 dB Upper limits: +3 dB	State: ALL Option: B41 and B44 With query Note: For all limits must be valid: Upper limit - lower limit ≥ 1dB
	Syntax: CALCulate:LIMIT:MAA:RESult:MATCHing?	Return: (MATC NMAT INV)

Pass/Fail Verdict for the Multitone Audio Analysis

Syntax: CALCulate:LIMIT:MAA:RESult:MATCHing?	Return: (MATC NMAT INV)	State: ALL Option: B41 and B44 With query Note: Returns the result of the last measurement, (N12)
--	---------------------------------------	---

MAA-Measurement

Syntax: Execute new measurement and signal result: Only read result: FETCH:SCALar:MAA:RESult1? READ:SCALar:MAA:RESult14?	Execute new measurement and signal result: Only read result: FETCH:SCALar:MAA:RESult1? READ:SCALar:MAA:RESult14? Measurement of all tones: READ:SCALar:MAA:RESult:ALL? FETCH:SCALar:MAA:RESult:ALL?	Return: Single tone: <Value> All tones: <Value1>, ..., <Value14>	State: ALL Option: B41 and B44 Only query Note: No Default value Unit depends on the selected Result Type (CONF:MAA:FORM) Invalid results are indicated by INV
---	---	---	---

22. Current and Voltage Measurements

Remote Control/Annex C

CMD60

Current measurement

Syntax: Execute new measurement and signal result: READ[:SCALAR]:CURRENT[:DC]? READ[:SCALAR]:CURRENT[:DC]:MAXimum? (Maximum) READ[:SCALAR]:CURRENT[:DC]:MINimum? (Minimum) READ[:SCALAR]:CURRENT[:DC]:AVERAGE? (Average)		Return: <Value> (unit: A)		State: ALL	Option: none Only query	Note: No default values
Syntax: Executes zero offset adjustment. CALCulate:CURRENT[:DC]:ZERooffset		State: ALL		Option: none no query	Note: see also CONF:CURR:OFFS	

Zero offset adjustment for current measurements

Syntax: Execute new measurement and signal result: READ[:SCALAR]:CURRENT[:DC]? READ[:SCALAR]:CURRENT[:DC]:MAXimum? (Maximum) READ[:SCALAR]:CURRENT[:DC]:MINimum? (Minimum) READ[:SCALAR]:CURRENT[:DC]:AVERAGE? (Average)		Return: <Value> (unit: A)		State: ALL	Option: none Only query	Note: No default values
--	--	-------------------------------------	--	------------	----------------------------	-------------------------

Offset for current measurements

Syntax: CONFIGure:CURRent[:DC]:OFFSet		Value range: -10.0 A ... 10.0 A ON OFF Default: OFF (0.0A)		State: ALL	Option: none With query	Note: see also CALC:CURR:ZER
---	--	---	--	------------	----------------------------	------------------------------

Voltage measurement

Syntax: Execute new measurement and signal result: READ[:SCALAR]:VOLTage[:DC]? READ[:SCALAR]:VOLTage[:DC]:MAXimum? (Maximum) READ[:SCALAR]:VOLTage[:DC]:MINimum? (Minimum) READ[:SCALAR]:VOLTage[:DC]:AVERAGE? (Average)		Return: <Value> (unit: V)		State: ALL	Option: none Only query	Note: No default values
--	--	-------------------------------------	--	------------	----------------------------	-------------------------

23. Burst Analysis

Expected power (of mobile station)

Syntax: CONFigure:BAAnalysis:Power:TRANSMit:NORMat:EXPEcted <numeric_value>		State: ALL	Option: none	With query
Value range:	-10.0 ... +30.0 dbm	Default: +24.0 dbm		

Frequency / RF Channel

Syntax: CONFigure:BAAnalysis:FREQuency <numeric_value>		State: ALL	Option: none	With query
Value range:	1902.528 ... 1876.608 MHz (in steps of 0.864 MHz) -3 ... +12 (in steps of 0.5))	Default: 1897.344 MHz (Channel 0)		

Measurement Window

Syntax: CONFigure:BAAnalysis:MEASurement:WINDow <value>		State: ALL	Option: none	With query
Value range:	25 μs window 50 μs window 75 μs window 83 μs window (P00) 100 μs window 110 μs window 115 μs window 120 μs window 125 μs window 130 μs window 135 μs window 140 μs window 145 μs window 150 μs window 156 μs window (P08) 200 μs window 250 μs window 300 μs window 350 μs window 364 μs window (P32) 400 μs window 450 μs window 500 μs window 750 μs window 781 μs window (P80) 1000 μs window	Default: T350		

Trigger

Syntax: CONFigure:BAAnalysis:TRIGger <value>		State: ALL	Option: none	With query
Value range:	EXTERNAL RSLOpe FREerun Free Run Rising Slope External Trigger	Default: FRE		

Remote Control/Annex C

CMD60

Trigger Delay

Syntax:	CONFIGure:BAAnalysis:TRIGger:Delay <numeric_value>
Value range:	0 ... 10 ms Default: 0
State:	ALL Option: none With query

Modulation Measurements Reference Type (Module Test)

Syntax:	CONFIGure:BAAnalysis:MODulation:REFERENCE <value>
Value range:	MEASured NOMinal PEAK Default: MEAS
State:	ALL Option: none With query

Pass/Fail verdict for Normal Transmit Power (NTP)

Syntax:	CALCulate:BAAnalysis:LIMIT:Power:TRANSMit:TOLerance:MATCHing?
Return:	(MATC NMAT INV)
State:	DBAN Option: none Only query Note: Returns the result of the last measurement (N10), (N12)

FM-Demodulated Signal

Syntax:	EXECute new measure-ment and signal result READ:ARRAy:BAAnalysis:FREQUency:DEVIation? FETCH:ARRAy:BAAnalysis:FREQUency:DEVIation?
Return:	<Value> {, <Value>} (Unit: KHz)
State:	DBAN Option: none Only query Note: (N10)

Normal Transmit Power (NTP)

Syntax:	EXECute new measure-ment and signal result READ:SCALar:BAAnalysis:Power:TRANSMit:NORMal? FETCH:SCALar:BAAnalysis:Power:TRANSMit:NORMal?
Return:	<value> (Unit: dBm)
State:	DBAN Option: none Only query Note: (N10)

Frequency offset

State: DBAN Option: none Only query Note: (N10)		Return:	<Value> (Unit: Hz)
Syntax: Execute new measurement and signal result READ:SCALAR:BAAnalysis:FREQUENCY:OFFSet?		Only read result FETCH:SCALAR:BAAnalysis:FREQUENCY:OFFSet?	

Modulation

State: DBAN Option: none Only query Note: The first value is the positive value, the second is the negative one; (N10)		Return:	<Value>, <Value> (Unit: Hz)
Syntax: Execute new measurement and signal result READ:SCALAR:BAAnalysis:MODulation?		Only read result FETCH:SCALAR:BAAnalysis:MODulation?	

Power Ramp Signal

State: DBAN Option: none Only query Note:		Return:	<Value> {, <Value> (Unit: dbm)
Syntax: Execute new measurement and signal result READ:ARRAY:BAAnalysis:Power:TRANSMit?		Only read result FETCH:ARRAY:BAAnalysis:Power:TRANSMit?	

24. RF Generator

Configuration of a Generator Parameter Set

CONFIGURE:RFGen:SElect is used to select a parameter set on which the changes with CONFIGURE:RFGen:... are to act. These changes are maintained even if a different parameter set is selected.

Selection of the generator configuration

Syntax:	CONFIGURE:RFGen:SElect:SETting <value>
Value range:	SETting1 SETting2 SETting3 SETting4 SETting5 SETting6 SETting7 Default: SET1
State:	ALL
Option:	none
With query:	
Note:	(N6)

Frequency / RF Channel

Syntax:	CONFIGURE:RFGen:FREQuency:OUTPut[:CW]:FIXed] <numeric_value>
Value range:	(Channel: 1902.528...1876.608 MHz (in steps of 0.864 MHz) -3 ... +12 (in steps of 0.5)) Default: 1897.344 MHz (Channel 0)
State:	ALL
Option:	none
With query:	
Note:	The input value is adapted to the step size indicated when the parameter set is set, (N6)

Deviation

Syntax:	CONFIGURE:RFGen:FREQuency:DEVIation <numeric_value>
Value range:	0.0 ... 510.0 KHz (in steps of 2.0 KHz) Default: 288.0 KHz
State:	ALL
Option:	none
With query:	
Note:	The input value is adapted to the step size indicated when the parameter set is set, (N6)

State:	ALL	Option:	none	With query		Note:	(N6)
Syntax:	CONFIGURE:RFGen:SIGnAL <value>						
Value range:	B55 B33 B0F BEXtEm CE55 CE33 CE0F CEExTEm DB55 DB33 DB0F DBFig31 DBPRs DBSPrs DBUser						Burst with bit pattern 01010101 Burst with bit pattern 00110011 Burst with bit pattern 00001111 External modulated Burst Constant Envelope with bit pattern 01010101 Constant Envelope with bit pattern 00110011 Constant Envelope with bit pattern 00001111 External modulated Constant Envelope signal DECT Burst with bit pattern 01010101 DECT Burst with bit pattern 00110011 DECT Burst with bit pattern 00001111 DECT Burst with bit pattern acc. to Figure 31 DECT Burst with pseudo random bit pattern DBPRs DBSPrs DBUser
Default:	CE55						

Signal

State:	ALL	Option:	none	With query		Note:	The level is automatically adapted to the output and output connection when selecting the parameter set. (N6)
Syntax:	CONFIGURE:RFGen:RF:LEvEL <numeric_value>						
Value range:	(N3)						Default: -40.0 dBm

Rf Level

State:	ALL	Option:	none	With query		Note:	If CONF:RFGen:SIGn = DBUser then the configured pattern is used as the signal.
Syntax:	CONFIGURE:RFGen:SIGnAL:PATtEm <string>						
Value range:	100 digits in HEX-format						Default: "AAAAE98A0F0F..0F"

Signal Pattern

Setting the Current Generator Parameter Set

Setting a generator configuration

Transfers the values of the selected configuration and sets the RF generator accordingly. These values can be changed using the following commands. By calling SOURCE:RFGGen:SElect again, the modifications are lost.

Syntax:	SOURCE:RFGGen:SElect:SETTING <value>
Value range:	SETTING1 SETTING2 SETTING3 SETTING4 SETTING5 SETTING6 SETTING7 NONE (only with query; if the selected configuration has been changed) Default: NONE
State: ALL	Option: none With query Note: Power level is automatically adapted to the output and output connection, (N6)

Frequency / RF Channel

Syntax:	SOURCE:RFGGen:FREQUENCY:OUTPUT:FIXED <numeric_value>
Value range:	1902.528...1876.608 MHz (in steps of 0.864 MHz) -3 ... +12 (in steps of 0.5)) Default: 1897.344 MHz (Channel 0)
State: DRFG	Option: none With query Note: The input value is adapted to the step size indicated when the parameter set is set, (N6)

Deviation

Syntax:	SOURCE:RFGGen:FREQUENCY:Deviation <numeric_value>
Value range:	0.0 ... 510.0 kHz (in steps of 2.0 kHz) Default: 288.0 kHz
State: DRFG	Option: none With query Note: The input value is adapted to the step size indicated when the parameter set is set, (N6)

Syntax:	SOURCE:RFGen:SIGNal:PATtern <string>
Value range:	100 digits in HEX-format Default: "AAAAE98A0F0F.0F"
State: ALL	Option: none With query: With query Note: IF CONF:RFG:SIGN = DBUSer then the configured pattern is used as the signal.

Signal Pattern

Syntax:	SOURCE:RFGen:RF:LEVel <numeric_value>
Value range:	-100.0 ... -40.0 dbm Default: -40.0 dbm
State: DRFG	Option: none With query: With query Note: The level is automatically adapted to the output and output connection when selecting the parameter set. (N6)

RF Level

Syntax:	SOURCE:RFGen:SIGNal <value>																														
Value range:	<table border="0"> <tr><td>B55</td><td>Burst with bit pattern 01010101</td></tr> <tr><td>B33</td><td>Burst with bit pattern 00110011</td></tr> <tr><td>B0F</td><td>Burst with bit pattern 00001111</td></tr> <tr><td>BEXtern</td><td>External modulated Burst</td></tr> <tr><td>CE55</td><td>Constant Envelope with bit pattern 01010101</td></tr> <tr><td>CE33</td><td>Constant Envelope with bit pattern 00110011</td></tr> <tr><td>CE0F</td><td>Constant Envelope with bit pattern 00001111</td></tr> <tr><td>CEEExtern</td><td>External modulated Constant Envelope signal</td></tr> <tr><td>DB55</td><td>DECT Burst with bit pattern 01010101</td></tr> <tr><td>DB33</td><td>DECT Burst with bit pattern 00110011</td></tr> <tr><td>DB0F</td><td>DECT Burst with bit pattern 00001111</td></tr> <tr><td>DBFig31</td><td>DECT Burst with bit pattern acc. to Figure 31</td></tr> <tr><td>DBPRs</td><td>DECT Burst with pseudo random bit pattern</td></tr> <tr><td>DBSPrs</td><td>DECT Burst with static pseudo random bit pattern</td></tr> <tr><td>DBUSer</td><td>DECT Burst with User Defined Pattern</td></tr> </table>	B55	Burst with bit pattern 01010101	B33	Burst with bit pattern 00110011	B0F	Burst with bit pattern 00001111	BEXtern	External modulated Burst	CE55	Constant Envelope with bit pattern 01010101	CE33	Constant Envelope with bit pattern 00110011	CE0F	Constant Envelope with bit pattern 00001111	CEEExtern	External modulated Constant Envelope signal	DB55	DECT Burst with bit pattern 01010101	DB33	DECT Burst with bit pattern 00110011	DB0F	DECT Burst with bit pattern 00001111	DBFig31	DECT Burst with bit pattern acc. to Figure 31	DBPRs	DECT Burst with pseudo random bit pattern	DBSPrs	DECT Burst with static pseudo random bit pattern	DBUSer	DECT Burst with User Defined Pattern
B55	Burst with bit pattern 01010101																														
B33	Burst with bit pattern 00110011																														
B0F	Burst with bit pattern 00001111																														
BEXtern	External modulated Burst																														
CE55	Constant Envelope with bit pattern 01010101																														
CE33	Constant Envelope with bit pattern 00110011																														
CE0F	Constant Envelope with bit pattern 00001111																														
CEEExtern	External modulated Constant Envelope signal																														
DB55	DECT Burst with bit pattern 01010101																														
DB33	DECT Burst with bit pattern 00110011																														
DB0F	DECT Burst with bit pattern 00001111																														
DBFig31	DECT Burst with bit pattern acc. to Figure 31																														
DBPRs	DECT Burst with pseudo random bit pattern																														
DBSPrs	DECT Burst with static pseudo random bit pattern																														
DBUSer	DECT Burst with User Defined Pattern																														
State: DRFG	Option: none With query: With query Note: (N6)																														
Default: CE55																															

Signal

25. Miscellaneous

Saving and Loading of Instrument Setups

a) General Information

Selection of storage medium

Each command for storing, loading or naming an instrument setup permits to specify the storage medium as an option. This medium remains set until another one is explicitly selected.

Syntax:	MEMORY:TYPE <value>
Value range:	INTERNAL MEMCard Default: INTERNAL
State: ALL	Option: (INTERNAL): none (MEMCard): B62
	Note: The storage medium selected is valid for all MMEM:SAVE and MMEM:REC commands.

Saving an instrument setup

Syntax:	MEMORY1:SAVE ... MEMORY13:SAVE
Status: ALL	Option: none No query
	Note: The settings of the remote control interface are not saved.

Assigning a name for a saved instrument setup

Syntax:	MEMORY1:SAVE:NAME <string> ... MEMORY13:SAVE:NAME <string>
Value range:	Name for instrument setup
Status: ALL	Option: none With query

Loading a saved instrument setup

Syntax:	MEMORY1:RECALL ... MEMORY13:RECALL
Status: ALL	Option: none No query
	Note: The settings of the remote-control interface are not changed.

b) User Settings

Selecting the user

Syntax:	SYSTEM:USER:SELECT <value>
Value range::	USER1...USER14 Default: USER1
Status: ALL	Option: none With query

Assigning a user name

Syntax:	SYSTEM:USER1:NAME <string> SYSTEM:USER14:NAME <string>
Value range:	User name
Status: ALL	Option: none With query

c) Reset Operations

Two types of reset are possible in manual operation:

- Reset without remote-control setting
- Reset with remote-control setting

Reset without remote-control setting can be released via the remote control using the commands *RST or SYSTEM:PRESET.
Reset with remote-control setting is not possible in this way; the following three commands must be called:

*RST or SYSTEM:PRESET
STATUS:PRESET
SYSTEM:COMMUNICATE:GPIB[;SELF]:ADDRESS

Reset

The reset using the following two commands is identical with the actions when pressing the RESET key and the selection "reset without remote-control setting". This means that the remote control is not involved with these commands.

Syntax:	*RST
Status: ALL	Option: none No query
Note:	Sets the instrument to the default status (without considering an established call); however, it does not affect the remote-control settings

Syntax:	SYSTEM:PRESET
Status: ALL	Option: none No query
Note:	Sets the instrument to the default status (without considering an established call); however, it does not affect the remote-control settings

State: ALL		Option: none	With query
Value range:	ON OFF	Calibration active Calibration inactive	
Syntax:	CONFIGURE:CYCLIC:CALIBRATION:MODE <value>		
Default: ON			

Cyclic Calibration Mode

Note: If the automatic calibration is turned off in REMOTE mode, it will remain turned off in LOCAL mode, too.
After Power-On or Reset of the device the automatic calibration is turned on. It is executed with every modulation measurement.

Calibration Mode

State: ALL		Option: none	No query
Syntax:	SYSTEM[:STATE]:LOCAL		
Note: The command is necessary only in case of remote control via the serial interface, since for the IEC/IEEE bus it is sufficient to send the value 1 (GTL) with the ATN line set.			

Switchover to LOCAL

State: ALL		Option: none	With query
Value range:	IDLE CURRENT	Transition to the IDLE state. No state transition (current state is maintained).	
Syntax:	CONFIGURE:LOCAL:STATE <value>		
Default: IDLE			

State upon transition from REMOTE to LOCAL and vice versa

Remote / Local Switching

Status: ALL		Option: none	No query
Syntax:	STATUS:PRESET		
Note: Does not affect the transfer parameters (address, etc.) or instrument setups.			

Reset of remote-control interface

Execute Calibration

Syntax:	PROCEDURE:Calibration
State: ALL	Option: none No query

Internal instrument state

Status

Syntax:	STATUS:Device?
Return:	IDLE IDLE (initial state) DECT: Fixed Part DPP DCE: Portabel Part DCE: Connection Established DBAN DECT: Burst Analysis DRFG DECT: RF Generator
State: ALL	Option: none Only query
	Default: IDLE

Screen display of the remote-control commands and responses

Syntax:	DISPLAY:ENABLE <value>
Value range:	ON OFF Remote-control commands and responses appear on the screen No screen outputs
State: ALL	Option: none with query Note:
	Default: ON

Firmware Version

Syntax:	SYSTEM:FIRMWARE:VERSION?
Return:	String containing firmware information
State: ALL	Option: none Only query

Query of Options

Syntax:	SYSTEM:OPTIONS?
Return:	List of all existing options (as Bx, with x as number of the option), separated by means of commas; not existing options are not indicated. Example: Options B4, B41, B6, and B61 exist, then the output is: ,,B4,B41,B6,B61
State: ALL	Option: none Only query Note: No default value

Remote Control/Annex C

CMD60

Mandatory Commands

Clear Status

Syntax:	*CLS
State:	ALL
Option:	none
no query	

Standard Event Status Enable

Syntax:	*ESE <numeric_value>
Value range:	0 ... 255
Default:	0
State:	ALL
Option:	none
with query	
Note:	MAXimum and MINimum impermissible

Standard Event Status Register

Syntax:	*ESR?
Return:	0 ... 255
State:	ALL
Option:	none
only query	

Identification Query

Syntax:	*IDN?
Return:	Rohde&Schwarz,CMD60,0,x:xx yy.yy-yy (x:xx is SW version, e.g. V 1.00 yy.yy-yy is the date, e.g. 18.10.93)
State:	ALL
Option:	none
only query	

Individual Status Query

Syntax:	*IST?
Return:	0 1
State:	ALL
Option:	none
Only query	

Operation Complete

Syntax:	*OPC
Return:	1 (return only in the case of query)
State:	ALL
Option:	none
With query	
Note:	Also influences the OPC bit in the event status register

Parallel Poll Enable Register Enable

Syntax:	*PRE <numeric_value>
Value range:	0 ... 255
State:	ALL
Option:	none
With query:	With query
Note:	MAXimum and MINimum impermissible
Default:	0

Power-on Status Clear

Syntax:	*PSC <numeric_value>
Value range:	-32767 ... 32767
State:	ALL
Option:	none
With query:	With query
Note:	MAXimum and MINimum impermissible
Default:	1

Reset

Syntax:	*RST
State:	ALL
Option:	none
No query:	No query
Note:	Sets the instrument to the default state (without taking into account a connection set up)

Service Request Enable

Syntax:	*SRE <numeric_value>
Value range:	0 ... 255
State:	ALL
Option:	none
With query:	With query
Note:	MAXimum and MINimum impermissible
Default:	0

Status Byte Query

Syntax:	*STB?
Return:	0 ... 255
State:	ALL
Option:	none
Only query:	Only query

Self-Test

Syntax:	*TST?
Return:	0 ... 255
State:	ALL
Option:	none
Only query:	Only query
Note:	No error in the selftest is indicated by the value 0

Remote Control/Annex C

CMD60

Wait-to-Continue

Syntax:	*WAI	State: ALL	Option: none	No query
Return:	Identical with SYSTEM:OPTIONS?			
Syntax:	*OPT?	State: ALL	Option: none	Only query
Return:	Identical with SYSTEM:OPTIONS?			
Syntax:	Note: No default value; identical with SYSTEM:OPTIONS?			

Optional Commands

Query of options

STATUS Subsystem

Operation Event Register

Syntax:	STATUS:OPERATION:EVENT?	Return:	0 ... 32767	State: ALL	Option: none	Only query	Note: Bit 8 is used as summary bit for the CMD event register.
Return:	Default: 0						

Operation Condition Register

Syntax:	STATUS:OPERATION:CONDITION?	Return:	0 ... 32767	State: ALL	Option: none	Only query
Return:	Default: 0					

Operation Event Register Enable

Syntax:	STATUS:OPERATION:ENABLE <numeric_value>	Value range:	0 ... 32767	State: ALL	Option: none	With query	Note: MAXimum and MINimum impermissible; Bit 8 is used for the CMD event register.
Return:	Default: 0						

Questionable Event Register

Syntax:	STATUS:QUESTIONABLE:EVENT?
Return:	0 ... 32767 Default: 0
State: ALL	Option: none Only query

Questionable Condition Register

Syntax:	STATUS:QUESTIONABLE:CONDITION?
Return:	0 ... 32767 Default: 0
State: ALL	Option: none Only query

Questionable Event Register Enable

Syntax:	STATUS:QUESTIONABLE:ENABLE <numeric_value>
Value range:	0 ... 32767 Default: 0
State: ALL	Option: none With query Note: MAXimum and MINimum impermissible

Resetting the instrument

Syntax:	STATUS:PRESET
State: ALL	Option: none No query

Status queue

Syntax:	STATUS:QUEUE:NEXT?
Return:	see SCPI, section 20.8 (p. 20-6) Default: 0, "no error"
State: ALL	Option: none Only query

SYSTEM Subsystem

Next message from error queue

Syntax:	SYSTEM:ERROR?
Return:	see SCPI, section 21.7 (p. 21-10) Default: 0, "no error"
State: ALL	Option: none Only query

Remarks

- (N1) - The output power will be adapted if necessary.
- The input can be overdriven if an external amplifier is connected.

(N2)

- The level will be adapted automatically.
- Only one In- or Output can be active, that means the other In- or Output which is not selected is inactive.

(N3)

The range of the RF level depends on the external attenuation and the selected RF connector as follows:

- 100.0 - ext. att. ... -40.0 - ext. att. dBm
 - 40.0 - ext. att. ... +7.5 - ext. att. dBm
 - 20.0 - ext. att. ... +7.5 - ext. att. dBm
- when RF OUT selected when RF OUT2 and RF IN selected
 when RF OUT2 and RF IN2 selected

(N6)

CONFIGURE:RFGen:SELECT selects a generator setting which permits to configure the values (with SOURCE:RFGen:SELECT is used to load the values of the selected setting (and adapt them to the output or output connection, if necessary). SOURCE:RFGen:... permits to vary the values of the selected generator setting (they are lost if a different setting is selected).

(N10)

After calling of a READ command, all scalar measurement results (within one menu) are calculated and the desired value is returned; the remaining measurement results can be fetched using FETCH or CALCULATE. The field values cannot be obtained. However, if the measurement is made via READ:ARRAY, the scalar values are available in addition to the selected field values.

(N12)

The results of the tolerance query have the following meaning:
 MATC: The measurement result observes the configured limit values
 NMAT: The measurement result does not observe the configured limit values
 INV: No measurement result is available

State: ALL	Option: none	Only query
Return:	see SCPI, section 21.18 (p. 21-28)	Default: 1993.0
Syntax:	SYSTEM:VERSION?	

SCPI Version

26. Summary of all Commands

52	CLS
52	*ESE
52	*ESR?
52	*IDN?
52	*IST?
52	*OPC
54	*OPT?
53	*PRE
53	*PSC
53	*RST
53	*SRE
53	*STB?
53	*TST?
54	*WAI
42	CALCulate:BAAnalysis:LIMIT:POWER:TRANSMit:TOLerance:MATCHing?
40	CALCulate:CURRent[DC]:ZERooffset
30	CALCulate:LIMIT:BER:LTERM:CLear
30	CALCulate:LIMIT:BER:LTERM:TOLerance:MATCHing?
19	CALCulate:LIMIT:BER:LTERM:TOLerance[MATCHing?]
30	CALCulate:LIMIT:BER:LTERM:TOLerance[DATA]
14	CALCulate:LIMIT:BER:LTERM:TOLerance:MATCHing?
27	CALCulate:LIMIT:BER:LTERM:TOLerance[DATA]
15	CALCulate:LIMIT:FREQUENCY:DRIFT:TOLerance:MATCHing?
14	CALCulate:LIMIT:FREQUENCY:OFFSet:TOLerance:MATCHing?
27	CALCulate:LIMIT:FREQUENCY:OFFSet:TOLerance[DATA]
17	CALCulate:LIMIT:JITTER:TOLerance:MATCHing?
29	CALCulate:LIMIT:JITTER:TOLerance[DATA]
38	CALCulate:LIMIT:MAA:RESult:MATCHing?
39	CALCulate:LIMIT:MAA:CLear
39	CALCulate:LIMIT:MAA:VOLTage:RELative
39	CALCulate:LIMIT:MAA:VOLTage:RELative:LOWer[ALL]
39	CALCulate:LIMIT:MAA:VOLTage:RELative:UPPer[ALL]
38	CALCulate:LIMIT:MAA:VOLTage:ABSolute
38	CALCulate:LIMIT:MAA:VOLTage:ABSolute:LOWer[ALL]
38	CALCulate:LIMIT:MAA:VOLTage:ABSolute:UPPer[ALL]
39	CALCulate:LIMIT:MAA:VOLTage:RELative
27	CALCulate:LIMIT:MODulation:CLear
18	CALCulate:LIMIT:PACKet:DElay:TOLerance:MATCHing?
29	CALCulate:LIMIT:PACKet:DElay:TOLerance[DATA]
25	CALCulate:LIMIT:POWER:TRANSMit:TOLerance:LOWer[DATA]
25	CALCulate:LIMIT:POWER:TRANSMit:TOLerance:UPPer[DATA]
12	CALCulate:LIMIT:POWER:TRANSMit:TOLerance:MATCHing?
25	CALCulate:LIMIT:POWER:TRANSMit:TOLerance:CLear
12	CALCulate:LIMIT:POWER:TRANSMit:TOLerance[MATCHing?]
25	CALCulate:LIMIT:POWER:TRANSMit:TOLerance[DATA]
15	CALCulate:LIMIT:SField:TOLerance:MATCHing?
27	CALCulate:LIMIT:SField:TOLerance[DATA]
17	CALCulate:LIMIT:TIME:ACCuracy:TOLerance:MATCHing?
29	CALCulate:LIMIT:TIME:ACCuracy:TOLerance[DATA]
34	CALCulate:LIMIT:TIMing:CLear
34	CONFIGure:AFGEN:ADPCm
34	CONFIGure:AFGEN:FREQUENCY:FW :FIXed]
34	CONFIGure:AFGen:VOLTage
35	CONFIGure:AFMeas:COUNTer:FORMAT
35	CONFIGure:AFMeas:FREQUENCY:DISortion
35	CONFIGure:AFMeas:FREQUENCY:MINimum

CONFIGure:AFMeas:INPUT.....35
 CONFIGure:AFMeas:VOLTage:BPASS:FREQUENCY.....36
 CONFIGure:AFMeas:VOLTage:BPASS:WIDTH.....36
 CONFIGure:AFMeas:VOLTage:FORMAT.....35
 CONFIGure:AVERage:BURSt.....26
 CONFIGure:BAAnalysis:FREQUENCY.....41
 CONFIGure:BAAnalysis:MEASurement:WINDOW.....41
 CONFIGure:BAAnalysis:POWER:TRANSMit:NORMAL:EXPEcted.....41
 CONFIGure:BAAnalysis:TRIGger.....41
 CONFIGure:BAAnalysis:TRIGger:DELay.....42
 CONFIGure:BER:DATA[:TYPE].....31
 CONFIGure:BER:EVALuation:WINDOW:TIME?.....31
 CONFIGure:BER:EVALuation:WINDOW:BITS].....31
 CONFIGure:BER:FP:MBearer:CLEAR.....31
 CONFIGure:BER:FP:MBearer:SLOT.....31
 CONFIGure:BER:FP:MBearer?.....31
 CONFIGure:BER:FP:MBearer:CLEAR.....30
 CONFIGure:BER:PP:MBearer:SLOT.....30
 CONFIGure:BER:PP:MBearer?.....30
 CONFIGure:BER:RF:LEVEL.....19
 CONFIGure:CURRENT[:DC]:OFFSet.....40
 CONFIGure:CYCLic:CALibration:MODE.....50
 CONFIGure:FP:ANTenna.....24
 CONFIGure:FP:CARRIER:OFFSet.....24
 CONFIGure:FP:PMID.....6
 CONFIGure:FP:RF:LEVEL.....7
 CONFIGure:FP:RFPI.....6
 CONFIGure:FP:SIGNalling:MODE.....7
 CONFIGure:FP:TRAFfic:CARRIER.....7; 10
 CONFIGure:FP:TRAFfic:SLOT.....6; 10; 19; 23; 24; 26; 42
 CONFIGure:LOCAL:STATE.....50
 CONFIGure:MAA:VOLTage.....37
 CONFIGure:MAA:VOLTage:ALL.....37
 CONFIGure:MAA:VOLTage:FORMAT.....38
 CONFIGure:MAA:FREQUENCY:ALL.....37
 CONFIGure:MAA:FREQUENCY:CW[:FIXed].....37
 CONFIGure:MAA:TIME:LEAD.....38
 CONFIGure:MAA:VOLTage:REFERENCE.....37
 CONFIGure:MESSAGE:ESCAPE:MT.....21
 CONFIGure:MODulation:DATA[:TYPE].....28
 CONFIGure:POWER:DYNAMIC:RANGE.....26
 CONFIGure:POWER:TRANSMit:OUTPUT:RANGE.....12
 CONFIGure:CARRIER:OFFSet.....22
 CONFIGure:DUMMY:CARRIER.....4
 CONFIGure:DUMMY:MODE.....22
 CONFIGure:FP:DUMMY:SLOT.....4
 CONFIGure:FP:PROTotype:FP:CAPability.....22
 CONFIGure:FP:PROTotype:MULTiTrame.....22
 CONFIGure:FP:PROTotype:QPACket:ADDITIONal.....23
 CONFIGure:FP:PROTotype:SYSTEM:INFO.....22
 CONFIGure:FP:RF:LEVEL.....5
 CONFIGure:FP:RFPI.....4; 6
 CONFIGure:FP:SIGNalling:MODE.....5
 CONFIGure:FP:TABLE:QPACket:SEQUence.....23
 CONFIGure:FP:TRAFfic:CARRIER.....5; 10
 CONFIGure:FP:TRAFfic:SLOT.....5; 10; 27; 28
 CONFIGure:RFGen:FREQUENCY:DEVIation.....44
 CONFIGure:RFGen:FREQUENCY:OUTPUT:CW[:FIXed].....44

45.....CONFIGURE:RFGen:RF:LEVEL

44.....CONFIGURE:RFGen:SELECT:SETTING

45.....CONFIGURE:RFGen:Signal

45.....CONFIGURE:RFGen:Signal:PATTERN

33.....CONFIGURE:SYNC:OUTPUT:REFERENCE

33.....CONFIGURE:SYNC:REFERENCE

33.....CONFIGURE:SYNC:PORT

3.....CONFIGURE:TEST:TYPE]

29.....CONFIGURE:TIMING:AVERAGE:BURST

51.....DISPLAY:ENABLE

42.....FETCH:ARRAY:BANALYSIS:FREQUENCY:DEVIATION?

43.....FETCH:ARRAY:BANALYSIS:POWER:TRANSMIT?

19.....FETCH:ARRAY:BER:MBEARET?

16.....FETCH:ARRAY:FREQUENCY:DEVIATION?

13.....FETCH:ARRAY:POWER:TRANSMIT?

36.....FETCH:SCALAR:AFMeas:COUNTER?

36.....FETCH:SCALAR:AFMeas:DISTORTION?

36.....FETCH:SCALAR:AFMeas:VOLTAGE?

43.....FETCH:SCALAR:BANALYSIS:FREQUENCY:OFFSET?

43.....FETCH:SCALAR:BANALYSIS:MODULATION?

42.....FETCH:SCALAR:BANALYSIS:POWER:TRANSMIT:NORMAL?

19.....FETCH:SCALAR:BER:LTERM?

14.....FETCH:SCALAR:BFIELD?

40.....FETCH:SCALAR:CURRENT:DC:MAXIMUM?

40.....FETCH:SCALAR:CURRENT:DC:MINIMUM?

40.....FETCH:SCALAR:CURRENT:DC?

15.....FETCH:SCALAR:FREQUENCY:DRIFT?

14.....FETCH:SCALAR:FREQUENCY:OFFSET?

17.....FETCH:SCALAR:JITTER?

39.....FETCH:SCALAR:MAA:RESULT:ALL?

39.....FETCH:SCALAR:MAA:RESULT?

18.....FETCH:SCALAR:PACKET:DELAY?

12.....FETCH:SCALAR:POWER:TRANSMIT:NORMAL?

15.....FETCH:SCALAR:SFIELD?

17.....FETCH:SCALAR:TIME:ACCURACY?

40.....FETCH:SCALAR:VOLTAGE:DC?

48.....MEMORY:RECALL

48.....MEMORY:SAVE

48.....MEMORY:SAVE:NAME

48.....MEMORY:TYPE

51.....PROCEDURE:CALIBRATION

11.....PROCEDURE:CONNECTION:RELEASE

9.....PROCEDURE:CONNECTION:SETUP

3.....PROCEDURE:SELECT:TEST]

42.....READ:ARRAY:BANALYSIS:FREQUENCY:DEVIATION?

43.....READ:ARRAY:BANALYSIS:POWER:TRANSMIT?

19.....READ:ARRAY:BER:MBEARET?

16.....READ:ARRAY:FREQUENCY:DEVIATION?

13.....READ:ARRAY:POWER:TRANSMIT?

36.....READ:SCALAR:AFMeas:COUNTER?

36.....READ:SCALAR:AFMeas:DISTORTION?

36.....READ:SCALAR:AFMeas:VOLTAGE?

43.....READ:SCALAR:BANALYSIS:FREQUENCY:OFFSET?

43.....READ:SCALAR:BANALYSIS:MODULATION?

43.....READ:SCALAR:BANALYSIS:POWER:TRANSMIT:NORMAL?

42 READ]:SCALAR]:BANALYSIS:POWER:TRANSMIT:NORMAI?
19 READ]:SCALAR]:BER:L:TERM?
14 READ]:SCALAR]:BFIELD?
40 READ]:SCALAR]:CURRENT:DC]:MAXIMUM?
40 READ]:SCALAR]:CURRENT:DC]:MINIMUM?
40 READ]:SCALAR]:CURRENT:DC]
15 READ]:SCALAR]:FREQUENCY:DRIFT?
14 READ]:SCALAR]:FREQUENCY:OFFSET?
17 READ]:SCALAR]:JITTER?
39 READ]:SCALAR]:MAA:RESULT:ALL?
39 READ]:SCALAR]:MAA:RESULT?
12 READ]:SCALAR]:NTP?
18 READ]:SCALAR]:PACKET:DELAY?
12 READ]:SCALAR]:POWER:TRANSMIT:NORMAI?
15 READ]:SCALAR]:SFIELD?
17 READ]:SCALAR]:TIME:ACCURACY?
40 READ]:SCALAR]:VOLTAGE:DC]
32 ROUTE:IOCONNECTOR
11 SEND:MESSAGE:ESCAPE:MT
7 SENSE:DETECTED:DUMMY:CARRIER?
7 SENSE:DETECTED:DUMMY:SLOT?
11 SENSE:DETECTED:PMD?
8 SENSE:DETECTED:RFPI?
7 SENSE:SIGNALLING:STATE?
32 SENSE1:CORRECTION:LOSS:INPUT]:MAGNITUDE]
32 SENSE2:CORRECTION:LOSS:INPUT]:MAGNITUDE]
34 SOURCE:AFGEN:STATE
46 SOURCE:RFGEN:FREQUENCY:DEVIATION
46 SOURCE:RFGEN:FREQUENCY:OUTPUT:OUTPUI]:FIXED]
47 SOURCE:RFGEN:RF:LEVEL
46 SOURCE:RFGEN:SELECT:SETTING
47 SOURCE:RFGEN:SIGNAL
47 SOURCE:RFGEN:SIGNAL:PATTERN
47 SOURCE:RFGEN:LOSS:OUTPUT]:MAGNITUDE]
32 SOURCE2:CORRECTION:LOSS:OUTPUT]:MAGNITUDE]
32 STATUS:DEVICE?
51 STATUS:OPERATION:CONDITION?
54 STATUS:OPERATION:ENABLE
54 STATUS:OPERATION:EVENT]?
50; 55 STATUS:PRESET
55 STATUS:QUESTIONABLE:CONDITION?
55 STATUS:QUESTIONABLE:ENABLE
55 STATUS:QUESTIONABLE:EVENT]?
55 STATUS:QUEUE:NEXT]?
20 SYSTEM:COMMUNICATE:GPIB:SELF]:ADDRESS
55 SYSTEM:ERROR?
51 SYSTEM:FIRMWARE:VERSION?
51 SYSTEM:OPTIONS?
49 SYSTEM:PRESET
49 SYSTEM:USER:NAME
49 SYSTEM:USER:SELECT
56 SYSTEM:VERSION?
50 SYSTEM]:STATE]:LOCAL

Appendix D3

IEEE - Examples

The two subsequent examples show the most important command sequences for call setup, for signal analysis and for signal generation in an IEEE pseudo-language.

The IEEE commands are bold-typed in the diagrams and comments are represented in italics.

Example 1: Fast power measurement

*CLS	Deletion of the error queue, STB and ESR bytes, CMD event register and of the command input buffer.
*RST	Set default values in the CMD.
DISP:ENAB OFF	Disabling of the command display on the CMD screen entails faster processing of the IEEE-bus commands.
CONF:TEST PP	Set PP-test
CONF:PP:RFPI 'ABC1234567'	RFPI number depending on PP.
CONF:PP:DUMM:SL0T 0 CONF:PP:DUMM:CARR 0 CONF:PP:TRAF:SL0T 1 CONF:PP:TRAF:CARR 0 CONF:PP:SIGN:MODE LOOP	Channel settings and signalling in loop-back mode.
CONF:PP:RF:LEV -55.0 SOUR:CORR:LOSS 15.0	Set level and external loss.
CONF:POW:DYN:RANG LOW CONF:AVER:BURS 1	Acceleration of power measurement by averaging over one burst with low dynamic range.
PROC:SEL MAN	Changeover to manual test.
STAT:DEV? ≠ DCE	while Checking the call setup. The synchronization of the PP to the CMD cannot be checked.
PROC:CONN:SET	Request call setup.
READ:NTP?	Fast NTP measurement without calculation of the power template. Result of the NTP tolerance check.
CALC:LIM:POW:TRAN:TOL:MATC?	Start modulation measurement and read the values for frequency offset, B-field and sync field. Results of the modulation-tolerance check.
READ:FREQ:OFFS? FETC:BF1?; SF1? CALC:LIM:FREQ:OFFS:TOL:MATC? BFI:TOL:MATC? SFI:TOL:MATC?	Interrupt connection.
PROC:CONN:REL;*OPC?	Enter the idle menu.
PROC:SEL NONE	

*CLS	Deletion of the error queue, STB and ESR bytes, CMD event register and of the command input buffer.
*RST	Set default values in the CMD.
PROC:SEL RFG	Enter the RF generator mode..
SOUR:RFG:SIGN CE55	Generate constant envelope signal "01010101"
SOUR:RFG:FREQ:DEV 228 KHZ	Set modulation deviation.
SOUR:RFG:FREQ:OUTP 1902.528 MHZ	RF-frequency setting.
for <Level> := -40 dBm to -80 dBm (in steps of -10 dBm)	
SOUR:RFG:LEV <Level>	<Level> is a variable in this context, the discrete IEEE-bus commands are SOUR:RFG:LEV -40 dbm SOUR:RFG:LEV -50 dbm SOUR:RFG:LEV -60 dbm etc.
for <Level> := -80 dBm to -100 dBm (in steps of -1 dBm)	
SOUR:RFG:LEV <Level>	<Level> is a variable in this context, the discrete IEEE-bus commands are SOUR:RFG:LEV -80 dbm SOUR:RFG:LEV -81 dbm SOUR:RFG:LEV -82 dbm etc.
PROC:SEL NONE	Enter the idle menu.

Example 2: Sensitivity measurement for a receiver

Remote Control/Appendix D

CMD60

Index

A

ACCEPT RFP1 2.4; 2.6

Action 2.94

Action step 2.94

Additional Measurements 2.56

ADPCM 2.60; 2.87; 2.88

Amplifier 2.77

Antenna 2.66

Audio measurements 2.28; 2.31

Autotest 2.92

Autotest menus 2.19

AUTO TEST 2.92

AUTO TEST Active 2.109

AUTO TEST COPY 2.111

AUTO TEST EDIT 2.93

AUTO TEST END 2.109

BIT ERROR RATE CONFIGURATION 2.106

CONDITIONAL GOTO CONFIGURATION 2.110

DISPLAY RESULTS 2.110

POWER RAMP CONFIGURATION 2.101

RF MODULATION CONFIGURATION 2.103

SIGNALING FP-TEST CONFIGURATION 2.99

SIGNALING PP-TEST CONFIGURATION 2.95

TIMING CONFIGURATION 2.105

B

BACKSPACE 2.20; 2.25

Bandpass 2.87

Basic Operating Instructions 2.20

BEARER HANDOVER 2.39

BEARER RELEASE 2.40

BER 2.16; 2.17; 2.46

Bit error rate 2.17

Bit P0 2.13; 2.40

BURST 2.54

C

CARRIER # OFFSET 2.29; 2.66

CLEAR 2.20

CONDITIONAL GOTO 2.108

CONFIG 2.21

Config. Menus for Add. Measurements 2.86

Configuration menus 2.19; 2.61

ADD. MEASUREMENTS CONFIGURATION 2.86

AF GENERATOR CONFIGURATION 2.89

AF METER CONFIGURATION 2.87

BIT ERROR RATE CONFIGURATION 2.75

Configuration Main Menu 2.61

DISTORTION METER CONFIGURATION 2.88

HARDWARE OPTIONS 2.84

MULTITONE AUDIO ANALYSIS CONFIG 2.90

OTHER CONFIGURATION PARAMETERS 2.85

POWER RAMP CONFIGURATION 2.70

PRINTER 2.80

REPORT 2.83

RF CONNECTOR/EXT. ATT 2.77

RF-MODULATION CONFIGURATION 2.72

SIGNALING FP-TEST CONFIGURATION 2.66

SIGNALING PP-TEST CONFIGURATION 2.63; 2.67

SOFTWARE OPTIONS 2.84

SYNCHRONIZATION 2.78

D

Configuration Menus for Measurements 2.70

CONNECT/EXT. ATT 2.62

CONNECTION ESTABLISHED 2.12

Connection of CMD60 2.2

Connection to AC supply 2.3

CONST. ENVELOP 2.54

Contrast 2.2; 2.3

COUNTER 2.57

COUNTER MODE 2.57

CTR06 2.61

CURRENT 2.57

Current BER 2.46

Current FER 2.46

Current measurements 2.56; 2.86

E

Data pattern 2.15; 2.42; 2.46

DATA TYPE 2.14

DECT audio measurements 2.60

DECT BURST 2.54

DECT channel numbers 2.29

DECT channel spacing 2.29

DECT frequencies 2.29

DECT Measurements 2.38

DECT test mode 2.5; 2.7; 2.9; 2.11

DECT timing 2.79

DECT Transmitter Measurements 2.12

DECT Receiver Measurements 2.16

DECT-Testmode 2.7

DEVIATION 2.53

Distortion measurements 2.88

Dummy bearer 2.5; 2.7; 2.9; 2.11; 2.27; 2.28; 2.64

DYNAMIC 2.71

DYNAMIC IF TRAFFIC 2.38; 2.64

F

FER 2.16; 2.17; 2.46

FORCE TRANSMIT 2.38

Frame erasure rate 2.17

FREE RUN 2.49

Frequency accuracy 4.1

Frequency counter 2.56

Frequency drift 2.15; 2.43

Frequency offset 2.13; 2.38; 2.43; 2.48; 2.51

Front-panel view 1.1

G

General Configuration Menus 2.77

Getting Started 2.1

G

TX TEST CONFIGURATION 2.74

TX TEST CONFIGURATION 2.70

H	HARDCOPY	2.21
	Hardkeys	2.21
	HIGH DYNAMIC	2.13
I	IEEE ADDRESS	2.62
	ILLUM	2.25
J	Jitter	2.15; 2.45
K	KEY HELP	2.25
L	Lead time	2.91
	LOCAL	2.20
	LOCKED	2.32
	Longterm BER	2.46
	Longterm FER	2.46
	Loop toggle	2.20
	LOOPBACK	2.28; 2.33
M	MAC message	2.39
	Main Menu	2.26
	Main power switch	2.2
	Maintenance	4.1
	Manual Test	2.27
	MASTER	2.78
	Master/slave operation	2.79
	Max. \pm Modulation	2.48; 2.51
	Max. \pm sync field modulation	2.43
	Max. \pm B field modulation	2.43
	MEAS. WINDOW	2.49
	MEMCARD	2.23; 2.24
	Memory Card	2.23; 2.24; 2.111
	MENU HOME	2.21; 2.26
	Menu Structure	2.18
	MENU UP	2.21
Menus	ADDITIONAL MEASUREMENTS	2.56
	BIT ERROR RATE	2.46
	BURST ANALYSIS	2.48
	CONNECTION ESTABLISHED	2.38
	MULTITONE AUDIO ANALYSIS	2.58
	POWER RAMP	2.40
	POWER VERSUS TIME	2.50
	RF MODULATION	2.42
	RF SIGNAL GENERATOR	2.53
	RF-MODULATION	2.51
	SIGNALING FP-TEST	2.32
	SIGNALING PP-TEST	2.27
	TIMING	2.45
	MODULATION	2.14
	Modulation deviation	2.13; 2.38
	Module Test	2.48
	MT message	2.39
	MULTI BEARER	2.76
	Multibeaver	2.46
	Multitone measurements	2.59; 2.90
N	NORMAL	2.28; 2.31; 2.33; 2.36
	Normal transmit power	2.38
	Notch filter	2.88
	NTP	2.13; 2.38; 2.48
	Number key	2.20
	Numerical input	2.20
O	OCXO	4.1
	OCXO reference oscillator	2.3
	Operating menus	2.18; 2.26
P	Packet delay	2.15; 2.45
	Packet type	2.15
	Path attenuation	2.77
	PC-AT keyboard	2.20
	Peak value	2.87
	PMID	2.5; 2.12; 2.13; 2.32; 2.33; 2.35
	Poor Signal Quality	2.38
	Portable Part MAC Identity	2.5; 2.33
	Power cable	2.2
	Power Fuses	1.7
	POWER RAMP	2.12
	Power socket	2.2
	Preamble	2.15
	Preparation for Use	1.1
	Printer	2.110
	Putting into Operation	1.6
Q	Q packet	2.64
	Q0 packet	2.63
	Q0 PROTO	2.63
	Q3 packet	2.63
	Q3 PROTO	2.63
	Q6 packet	2.64
	Q6 PROTO	2.64
	QE PROTO	2.64
	OMUX TABLE	2.64
R	Rack 19"	1.6
	Radio Fixed Part Identity	2.5; 2.7; 2.9; 2.11; 2.27; 2.33
	Rear-panel view	1.1
	RECALL	2.24
	REF OUT 3	2.78
	REF. FREQ.	2.78
	Reference frequency	2.78
	Reference oscillator	4.1
	RESET	2.21
	RF IN 2	2.77
	RF IN/OUT	2.2; 2.77
	RF OUT2	2.77
	RF connection	2.3
	RFPI	2.5; 2.7; 2.9; 2.11; 2.27; 2.32; 2.33; 2.35
	RISING SLOPE	2.49
	RMS	2.87
	Rms values	2.87

S

SAVE..... 2.23

SAVE/RECALL functions..... 2.23

Selection with confirmation..... 2.20

Serial number of the unit..... 2.84

SETUP CONNECT..... 2.27

Signal generator..... 2.56

SIGNALLING FP TEST..... 2.4; 2.6

SIGNALLING FP TEST menu..... 2.35

SIGNALLING Menu..... 2.63

SIGNALLING PP TEST..... 2.8; 2.10

Signalling status..... 2.32

SLAVE..... 2.78

Slot..... 2.5; 2.7

Softkey..... 2.20

Spectrum analyzer..... 1.8

Standby..... 2.3

START..... 2.20

STOP BREAK..... 2.20

STOP CONDITION..... 2.13

Storage of Parameters..... 2.20

SYNC PORT..... 2.78

Synchronization..... 2.9; 2.11; 2.27; 2.32; 2.79

T

T_DATA_IN..... 2.54

TCXO..... 4.1

Test mode..... 2.32

Testing of the Frequency Accuracy..... 4.1

Testing the Rated Specifications..... 5.1

Text input..... 2.20

Time Accuracy..... 2.45

Timing accuracy..... 2.15

TIMING..... 2.14

Traffic bearer..... 2.28; 2.32; 2.35

TRIGGER..... 2.49

TRIGGER DELAY..... 2.49

U

Unit keys..... 2.20

UNLOCKED..... 2.32

USER..... 2.22; 2.24

USER DATA..... 2.55

V

Voltage measurements..... 2.56

Voltmeter..... 2.56

Z

Zero adjustment..... 2.56; 2.86

ZERO OFFSET..... 2.86

