



ROHDE & SCHWARZ

Test and
Measurement Division

Operating Manual

Digital Radio Tester

for

DECT

R&S[®] CTS60

1094.0006.60

Printed in Germany

Dear Customer,

R&S® is a registered trademark of Rohde & Schwarz GmbH & Co. KG.
Trade names are trademarks of the owners.

1094.3411.12-07-

Contents

Data Sheet
 Safety Instructions
 EC Certificate of Conformity
 Certificate of quality
 List of R&S Representatives

	Page
1 Introduction	1.1
1.1 Autotest Applications	1.1
1.1 Overview	1.1
1.2 Configurable Test Steps in Autotest	1.1
1.2 Manual Test Applications	1.1
2 Preparation for Use	2.1
2.1 Explanation of Front and Rear View	2.2
2.2 Commissioning	2.3
2.2.1 Setting up the Instrument	2.3
2.2.2 Connecting the Instrument to the AC Supply	2.4
2.2.3 Ensuring Electromagnetic Compliance (EMC)	2.5
2.2.4 Switching on the Instrument	2.5
2.2.5 Options List	2.6
2.2.6 OCXO Reference Oscillator (Option CTS-B1)	2.6
3 Getting Started With Autotest	3.1
3.1 Overview	3.1
3.2 Configuring an autotest	3.2
3.3 Running a fixed part test	3.4
3.4 Running a portable part test	3.8
3.5 Notes on configuring an autotest	3.12

4 Getting Started With Manual Test	4.1
4.1 Overview	4.1
4.2 Testing a Fixed Part	4.2
4.3 Testing a Portable Part	4.5
4.4 Transmitter Measurements	4.8
4.5 Receiver Measurements	4.12
5 RF connection	5.1
5.1 RF Connection of the Device Under Test Using an Antenna Coupler	5.1
6 Detailed Description of the Menus	6.1
6.1 Menu Structure	6.1
6.1.1 Menu Structure Overview	6.1
6.1.2 Status Labels	6.1
6.2 Field Editing	6.3
6.2.1 Multi-field Editing	6.3
6.2.2 Single Field Editing	6.4
6.3 Home Menu	6.5
6.4 Selecting and Configuring Types	6.6
6.4.1 Select FP or PP Types Menu	6.6
6.4.2 Config FP or PP Types Menu	6.7
6.4.3 Edit FP Types Menu	6.8
6.4.4 Edit PP Types Menu	6.9
6.5 Autotest Menus	6.10
6.5.1 Autotest Start Menu (Fixed Part Tests)	6.10
6.5.2 Autotest Start Menu (Portable Part Tests)	6.11
6.5.3 Autotest Select Test Menu	6.12
6.5.4 Autotest Edit Test Menu	6.13
6.5.5 Autotest Select Action Menu	6.14
6.5.6 Autotest Running Menu	6.15
6.5.7 Autotest Results Menu	6.16

6.6 Manual Test Menus	6.17
6.6.1 Synchronisation Menu (GAP Mode Fixed Part Tests)	6.17
6.6.1.1 Subscription of the Fixed Part	6.19
6.6.1.2 Subscribing the Fixed Part.....	6.20
6.6.2 Synchronisation Menu (GAP Mode Portable Part Tests).....	6.21
6.6.2.1 Subscription of the Portable Part.....	6.22
6.6.2.2 Subscribing the Portable Part.....	6.23
6.6.3 Connection Established Menu (Fixed Part Tests).....	6.24
6.6.4 Connection Established Menu (Portable Part Tests)	6.26
6.6.5 Power Ramp Menu	6.28
6.6.6 RF Modulation Menu.....	6.30
6.6.7 Timing Menu (Fixed Part)	6.32
6.6.8 Timing Menu (Portable Part).....	6.33
6.6.9 Bit Error Rate Menu	6.34
6.7 Auto and Manual Test Configuration Menus	6.35
6.7.1 Config Synchronisation Menu (Fixed Part)	6.35
6.7.2 Config Synchronisation Menu (GAP Mode Portable Part)	6.36
6.7.3 Config Synchronisation Menu (portable part for autotest)	6.39
6.7.4 Config Power Ramp Menu.....	6.40
6.7.5 Config RF Modulation Menu (Selectable frequency drift units).....	6.41
6.7.6 Config Timing Menu (Fixed Part).....	6.42
6.7.7 Config Timing Menu (Portable Part)	6.43
6.7.8 Config BER (Manual Test).....	6.44
6.7.9 Config BER (Autotest).....	6.45
6.7.10 Config Goto (Autotest only).....	6.46
6.8 General Configuration Menus	6.47
6.8.1 Config - Select.....	6.47
6.8.2 Config Date/Time	6.48
6.8.3 Config Language.....	6.49
6.8.4 Config Password.....	6.50
6.8.5 Enter Password.....	6.51
6.8.6 Com Port.....	6.52
6.8.7 Comment Menu	6.53
6.8.8 Config Keyboard Menu	6.54
6.8.9 Config - Save	6.55
6.8.10 Config - Load.....	6.56

7 Autotest Printed Reports	7.1
7.1 Overview	7.1
7.2 Header and Footer	7.2
7.2.1 First Page Header (Fixed Part)	7.2
7.2.2 First Page Header (Portable Part)	7.3
7.2.3 Standard Header	7.4
7.2.4 Test Result Footer	7.4
7.3 Measurement Results	7.5
7.3.1 Setup Connection (Fixed Part)	7.5
7.3.2 Setup Connection (Portable Part)	7.6
7.3.3 Power Ramp	7.7
7.3.4 Timing (Fixed Part)	7.8
7.3.5 Timing (Portable Part)	7.9
7.3.6 RF Modulation	7.10
7.3.7 Bit Error Rate	7.11
8 Remote Control	8.1
8.1 Introduction	8.1
8.2 Brief Instructions	8.1
8.3 Switchover to Remote Control	8.2
8.4 Device Messages (Commands and Device Responses)	8.2
8.5 Structure and Syntax of the Device Messages	8.3
8.5.1 SCPI Introduction	8.3
8.5.2 Structure of a Command	8.3
8.5.3 Structure of a Command Line	8.5
8.5.4 Responses to Queries	8.7
8.5.5 Parameters	8.8
8.5.6 Overview of Syntax Elements	8.10
8.6 Description of Commands	8.11
8.6.1 Notation	8.11
8.6.2 Common Commands	8.13
8.7 Instrument Model and Command Processing	8.16

8.8 Status Reporting System	8.17
8.8.1 Structure of an SCPI Status Register	8.17
8.8.2 Overview of the Status Registers.....	8.19
8.8.3 Description of the Status Registers.....	8.20
8.8.3.1 Status Byte (STB) and Service Request Enable Register (SRE)	8.20
8.8.3.2 Event-Status-Reg. (ESR) and Event-Status-Enable-Reg. (ESE)	8.21
8.8.4 Error-Queue Query	8.22
8.8.5 Resetting Values of the Status Reporting System	8.22
9 Software Options	9.1
9.1 Overview	9.1
9.2 Menu hierarchy	9.1
9.3 Setting the Serial Number	9.2
9.4 Setting the Code Number to enable an option	9.3
10 Performance Test (with service software)	10.1
10.1 DECT Test Program Package	10.1
10.1.1 Starting the Program.....	10.1
10.1.2 Remote Control of cmd Program	10.1
10.1.3 Special Features of cmd Operation	10.3
10.1.4 Functional Check of DECT Mode	10.4
11 Module Test	11.1
11.1 Adding Custom Mod Type Settings	11.1
11.2 Starting Module Test	11.2
11.3 Menu Burst Analysis	11.4
11.4 Menu Power vs. Time	11.6
11.5 Menu RF - Modulation	11.7
11.6 Menu RF Signal Gen.	11.9

Annex A: Interfaces

Annex B: List of Error Messages

Annex C: Remote Control (List of Commands)

Index

Supplement to Data Sheet CTS (PD0757.2509.22)

Specifications supplement:

Restricted output level range of DECT signal generator at connector RF IN/OUT, when RF IN2 DECT is active:

DECT signal generator

Output level	
RF IN/OUT	-100 dBm to -40 dBm (-80 dBm to -40 dBm if RF IN2 DECT is active)
RF OUT2 DECT	-40 dBm to 0 dBm (-20 dBm to 0 dBm if RF IN2 DECT is active) usable up to 5 dBm

**Supplement to Data Sheet CTS
(PD757.2509.22)**

Page 12:

GSM signal generator

Output level

RF OUT2 GSM

with 0 dB ext. attenuation

-20 dBm to -75 dBm

Page 13:

Analog DECT ADPCM interface

(cancelled)

General data

Operating temperature range

+5°C to +45°C



Before putting the product into operation for the first time, make sure to read the following



S a f e t y I n s t r u c t i o n s

Rohde & Schwarz makes every effort to keep the safety standard of its products up to date and to offer its customers the highest possible degree of safety. Our products and the auxiliary equipment required for them are designed and tested in accordance with the relevant safety standards. Compliance with these standards is continuously monitored by our quality assurance system. This product has been designed and tested in accordance with the EC Certificate of Conformity and has left the manufacturer's plant in a condition fully complying with safety standards. To maintain this condition and to ensure safe operation, observe all instructions and warnings provided in this manual. If you have any questions regarding these safety instructions, Rohde & Schwarz will be happy to answer them.

Furthermore, it is your responsibility to use the product in an appropriate manner. This product is designed for use solely in industrial and laboratory environments or in the field and must not be used in any way that may cause personal injury or property damage. You are responsible if the product is used for an intention other than its designated purpose or in disregard of the manufacturer's instructions. The manufacturer shall assume no responsibility for such use of the product.

The product is used for its designated purpose if it is used in accordance with its operating manual and within its performance limits (see data sheet, documentation, the following safety instructions). Using the products requires technical skills and knowledge of English. It is therefore essential that the products be used exclusively by skilled and specialized staff or thoroughly trained personnel with the required skills. If personal safety gear is required for using Rohde & Schwarz products, this will be indicated at the appropriate place in the product documentation.

Symbols and safety labels

Observe operating instructions	Weight indication for units >18 kg	Danger of electric shock	Warning! Hot surface	PE terminal	Ground	Ground terminal	Attention! Electrostatic sensitive devices

Supply voltage ON/OFF	Standby indication	Direct current (DC)	Alternating current (AC)	Direct/alternating current (DC/AC)	Device fully protected by double/reinforced insulation

Safety Instructions

Observing the safety instructions will help prevent personal injury or damage of any kind caused by dangerous situations. Therefore, carefully read through and adhere to the following safety instructions before putting the product into operation. It is also absolutely essential to observe the additional safety instructions on personal safety that appear in other parts of the documentation. In these safety instructions, the word "product" refers to all merchandise sold and distributed by Rohde & Schwarz, including instruments, systems and all accessories.

Tags and their meaning

DANGER	This tag indicates a safety hazard with a high potential of risk for the user that can result in death or serious injuries.
WARNING	This tag indicates a safety hazard with a medium potential of risk for the user that can result in death or serious injuries.
CAUTION	This tag indicates a safety hazard with a low potential of risk for the user that can result in slight or minor injuries.
ATTENTION	This tag indicates the possibility of incorrect use that can cause damage to the product.
NOTE	This tag indicates a situation where the user should pay special attention to operating the product but which does not lead to damage.

These tags are in accordance with the standard definition for civil applications in the European Economic Area. Definitions that deviate from the standard definition may also exist. It is therefore essential to make sure that the tags described here are always used only in connection with the associated documentation and the associated product. The use of tags in connection with unassociated products or unassociated documentation can result in misinterpretations and thus contribute to personal injury or material damage.

Basic safety instructions

1. The product may be operated only under the operating conditions and in the positions specified by the manufacturer. Its ventilation must not be obstructed during operation. Unless otherwise specified, the following requirements apply to Rohde & Schwarz products: prescribed operating position is always with the housing floor facing down, IP protection 2X, pollution severity 2, overvoltage category 2, use only in enclosed spaces, max. operation altitude max. 2000 m. Unless specified otherwise in the data sheet, a tolerance of $\pm 10\%$ shall apply to the nominal voltage and of $\pm 5\%$ to the nominal frequency.
2. Applicable local or national safety regulations and rules for the prevention of accidents must be observed in all work performed. The product may be opened only by authorized, specially trained personnel. Prior to performing any work on the product or opening the product, the product must be disconnected from the supply network. Any adjustments, replacements of parts, maintenance or repair must be carried out only by technical personnel authorized by Rohde & Schwarz. Only original parts may be used for replacing parts relevant to safety (e.g. power switches, power transformers, fuses). A safety test must always be performed after parts relevant to safety have been replaced (visual inspection, PE conductor test, insulation resistance measurement, leakage current measurement, functional test).
3. As with all industrially manufactured goods, the use of substances that induce an allergic reaction (allergens, e.g. nickel) such as aluminum cannot be generally excluded. If you develop an allergic reaction (such as a skin rash, frequent sneezing, red eyes or respiratory difficulties), consult a physician immediately to determine the cause.

Safety Instructions

4. If products/components are mechanically and/or thermally processed in a manner that goes beyond their intended use, hazardous substances (heavy-metal dust such as lead, beryllium, nickel) may be released. For this reason, the product may only be disassembled, e.g. for disposal purposes, by specially trained personnel. Improper disassembly may be hazardous to your health. National waste disposal regulations must be observed.
5. If handling the product yields hazardous substances or fuels that must be disposed of in a special way, e.g. coolants or engine oils that must be replenished regularly, the safety instructions of the manufacturer of the hazardous substances or fuels and the applicable regional waste disposal regulations must be observed. Also observe the relevant safety instructions in the product documentation.
6. Depending on the function, certain products such as RF radio equipment can produce an elevated level of electromagnetic radiation. Considering that unborn life requires increased protection, pregnant women should be protected by appropriate measures. Persons with pacemakers may also be endangered by electromagnetic radiation. The employer is required to assess workplaces where there is a special risk of exposure to radiation and, if necessary, take measures to avert the danger.
7. Operating the products requires special training and intense concentration. Make certain that persons who use the products are physically, mentally and emotionally fit enough to handle operating the products; otherwise injuries or material damage may occur. It is the responsibility of the employer to select suitable personnel for operating the products.
8. Prior to switching on the product, it must be ensured that the nominal voltage setting on the product matches the nominal voltage of the AC supply network. If a different voltage is to be set, the power fuse of the product may have to be changed accordingly.
9. In the case of products of safety class I with movable power cord and connector, operation is permitted only on sockets with earthing contact and protective earth connection.
10. Intentionally breaking the protective earth connection either in the feed line or in the product itself is not permitted. Doing so can result in the danger of an electric shock from the product. If extension cords or connector strips are implemented, they must be checked on a regular basis to ensure that they are safe to use.
11. If the product has no power switch for disconnection from the AC supply, the plug of the connecting cable is regarded as the disconnecting device. In such cases, it must be ensured that the power plug is easily reachable and accessible at all times (length of connecting cable approx. 2 m). Functional or electronic switches are not suitable for providing disconnection from the AC supply. If products without power switches are integrated in racks or systems, a disconnecting device must be provided at the system level.
12. Never use the product if the power cable is damaged. By taking appropriate safety measures and carefully laying the power cable, ensure that the cable cannot be damaged and that no one can be hurt by e.g. tripping over the cable or suffering an electric shock.
13. The product may be operated only from TN/TT supply networks fused with max. 16 A.
14. Do not insert the plug into sockets that are dusty or dirty. Insert the plug firmly and all the way into the socket. Otherwise this can result in sparks, fire and/or injuries.
15. Do not overload any sockets, extension cords or connector strips; doing so can cause fire or electric shocks.
16. For measurements in circuits with voltages $V_{\text{rms}} > 30 \text{ V}$, suitable measures (e.g. appropriate measuring equipment, fusing, current limiting, electrical separation, insulation) should be taken to avoid any hazards.
17. Ensure that the connections with information technology equipment comply with IEC 950/EN 60950.
18. Never remove the cover or part of the housing while you are operating the product. This will expose circuits and components and can lead to injuries, fire or damage to the product.

Safety Instructions

19. If a product is to be permanently installed, the connection between the PE terminal on site and the product's PE conductor must be made first before any other connection is made. The product may be installed and connected only by a skilled electrician.
20. For permanently installed equipment without built-in fuses, circuit breakers or similar protective devices, the supply circuit must be fused in such a way that suitable protection is provided for users and products.
21. Do not insert any objects into the openings in the housing that are not designed for this purpose. Never pour any liquids onto or into the housing. This can cause short circuits inside the product and/or electric shocks, fire or injuries.
22. Use suitable overvoltage protection to ensure that no overvoltage (such as that caused by a thunderstorm) can reach the product. Otherwise the operating personnel will be endangered by electric shocks.
23. Rohde & Schwarz products are not protected against penetration of water, unless otherwise specified (see also safety instruction 1.). If this is not taken into account, there exists the danger of electric shock or damage to the product, which can also lead to personal injury.
24. Never use the product under conditions in which condensation has formed or can form in or on the product, e.g. if the product was moved from a cold to a warm environment.
25. Do not close any slots or openings on the product, since they are necessary for ventilation and prevent the product from overheating. Do not place the product on soft surfaces such as sofas or rugs or inside a closed housing, unless this is well ventilated.
26. Do not place the product on heat-generating devices such as radiators or fan heaters. The temperature of the environment must not exceed the maximum temperature specified in the data sheet.
27. Batteries and storage batteries must not be exposed to high temperatures or fire. Keep batteries and storage batteries away from children. If batteries or storage batteries are improperly replaced, this can cause an explosion (warning: lithium cells). Replace the battery or storage battery only with the matching Rohde & Schwarz type (see spare parts list). Batteries and storage batteries are hazardous waste. Dispose of them only in specially marked containers. Observe local regulations regarding waste disposal. Do not short-circuit batteries or storage batteries.
28. Please be aware that in the event of a fire, toxic substances (gases, liquids etc.) that may be hazardous to your health may escape from the product.
29. Please be aware of the weight of the product. Be careful when moving it; otherwise you may injure your back or other parts of your body.
30. Do not place the product on surfaces, vehicles, cabinets or tables that for reasons of weight or stability are unsuitable for this purpose. Always follow the manufacturer's installation instructions when installing the product and fastening it to objects or structures (e.g. walls and shelves).
31. Handles on the products are designed exclusively for personnel to hold or carry the product. It is therefore not permissible to use handles for fastening the product to or on means of transport such as cranes, fork lifts, wagons, etc. The user is responsible for securely fastening the products to or on the means of transport and for observing the safety regulations of the manufacturer of the means of transport. Noncompliance can result in personal injury or material damage.
32. If you use the product in a vehicle, it is the sole responsibility of the driver to drive the vehicle safely. Adequately secure the product in the vehicle to prevent injuries or other damage in the event of an accident. Never use the product in a moving vehicle if doing so could distract the driver of the vehicle. The driver is always responsible for the safety of the vehicle; the manufacturer assumes no responsibility for accidents or collisions.
33. If a laser product (e.g. a CD/DVD drive) is integrated in a Rohde & Schwarz product, do not use any other settings or functions than those described in the documentation. Otherwise this may be hazardous to your health, since the laser beam can cause irreversible damage to your eyes. Never try to take such products apart, and never look into the laser beam.



Por favor lea imprescindiblemente antes de la primera puesta en funcionamiento las siguientes informaciones de seguridad



Informaciones de seguridad

Es el principio de Rohde & Schwarz de tener a sus productos siempre al día con los standards de seguridad y de ofrecer a sus clientes el máximo grado de seguridad. Nuestros productos y todos los equipos adicionales son siempre fabricados y examinados según las normas de seguridad vigentes. Nuestra sección de gestión de la seguridad de calidad controla constantemente que sean cumplidas estas normas. Este producto ha sido fabricado y examinado según el comprobante de conformidad adjunto según las normas de la CE y ha salido de nuestra planta en estado impecable según los standards técnicos de seguridad. Para poder preservar este estado y garantizar un funcionamiento libre de peligros, deberá el usuario atenerse a todas las informaciones, informaciones de seguridad y notas de alerta. Rohde&Schwarz está siempre a su disposición en caso de que tengan preguntas referentes a estas informaciones de seguridad.

Además queda en la responsabilidad del usuario utilizar el producto en la forma debida. Este producto solamente fue elaborado para ser utilizado en la industria y el laboratorio o para fines de campo y de ninguna manera deberá ser utilizado de modo que alguna persona/cosa pueda ser dañada. El uso del producto fuera de sus fines definidos o despreciando las informaciones de seguridad del fabricante queda en la responsabilidad del usuario. El fabricante no se hace en ninguna forma responsable de consecuencias a causa del maluso del producto.

Se parte del uso correcto del producto para los fines definidos si el producto es utilizado dentro de las instrucciones del correspondiente manual del uso y dentro del margen de rendimiento definido (ver hoja de datos, documentación, informaciones de seguridad que siguen). El uso de los productos hace necesarios conocimientos profundos y el conocimiento del idioma inglés. Por eso se deberá tener en cuenta de exclusivamente autorizar para el uso de los productos a personas péritas o debidamente minuciosamente instruidas con los conocimientos citados. Si fuera necesaria indumentaria de seguridad para el uso de productos de R&S, encontrará la información debida en la documentación del producto en el capítulo correspondiente.

Símbolos y definiciones de seguridad

Ver manual de instrucciones del uso	Informaciones para maquinaria con un peso de > 18kg	Peligro de golpe de corriente	¡Advertencia! Superficie caliente	Conexión a conductor protector	Conexión a tierra	Conexión a masa conductora	¡Cuidado! Elementos de construcción con peligro de carga electrostática

potencia EN MARCHA/PARADA	Indicación Stand-by	Corriente continua DC	Corriente alterna AC	Corriente continua/alterna DC/AC	El aparato está protegido en su totalidad por un aislamiento de doble refuerzo

Informaciones de seguridad

Tener en cuenta las informaciones de seguridad sirve para tratar de evitar daños y peligros de toda clase. Es necesario de que se lean las siguientes informaciones de seguridad concienzudamente y se tengan en cuenta debidamente antes de la puesta en funcionamiento del producto. También deberán ser tenidas en cuenta las informaciones para la protección de personas que encontrarán en otro capítulo de esta documentación y que también son obligatorias de seguir. En las informaciones de seguridad actuales hemos juntado todos los objetos vendidos por Rohde&Schwarz bajo la denominación de „producto“, entre ellos también aparatos, instalaciones así como toda clase de accesorios.

Palabras de señal y su significado

PELIGRO	Indica un punto de peligro con gran potencial de riesgo para el usuario. Punto de peligro que puede llevar hasta la muerte o graves heridas.
ADVERTENCIA	Indica un punto de peligro con un potencial de riesgo mediano para el usuario. Punto de peligro que puede llevar hasta la muerte o graves heridas .
ATENCIÓN	Indica un punto de peligro con un potencial de riesgo pequeño para el usuario. Punto de peligro que puede llevar hasta heridas leves o pequeñas
CUIDADO	Indica la posibilidad de utilizar mal el producto y a consecuencia dañarlo.
INFORMACIÓN	Indica una situación en la que deberían seguirse las instrucciones en el uso del producto, pero que no consecuentemente deben de llevar a un daño del mismo.

Las palabras de señal corresponden a la definición habitual para aplicaciones civiles en el ámbito de la comunidad económica europea. Pueden existir definiciones diferentes a esta definición. Por eso se debiera tener en cuenta que las palabras de señal aquí descritas sean utilizadas siempre solamente en combinación con la correspondiente documentación y solamente en combinación con el producto correspondiente. La utilización de las palabras de señal en combinación con productos o documentaciones que no les correspondan puede llevar a malinterpretaciones y tener por consecuencia daños en personas u objetos.

Informaciones de seguridad elementales

1. El producto solamente debe ser utilizado según lo indicado por el fabricante referente a la situación y posición de funcionamiento sin que se obstruya la ventilación. Si no se convino de otra manera, es para los productos R&S válido lo que sigue: como posición de funcionamiento se define principalmente la posición con el suelo de la caja para abajo , modo de protección IP 2X, grado de suciedad 2, categoría de sobrecarga eléctrica 2, utilizar solamente en estancias interiores, utilización hasta 2000 m sobre el nivel del mar.
A menos que se especifique otra cosa en la hoja de datos, se aplicará una tolerancia de $\pm 10\%$ sobre el voltaje nominal y de $\pm 5\%$ sobre la frecuencia nominal.
2. En todos los trabajos deberán ser tenidas en cuenta las normas locales de seguridad de trabajo y de prevención de accidentes. El producto solamente debe de ser abierto por personal périto autorizado. Antes de efectuar trabajos en el producto o abrirlo deberá este ser desconectado de la corriente. El ajuste, el cambio de partes, la manutención y la reparación deberán ser solamente efectuadas por electricistas autorizados por R&S. Si se reponen partes con importancia para los aspectos de seguridad (por ejemplo el enchufe, los transformadores o los fusibles), solamente podrán ser sustituidos por partes originales. Despues de cada recambio de partes elementales para la seguridad deberá ser efectuado un control de

Informaciones de seguridad

- seguridad (control a primera vista, control de conductor protector, medición de resistencia de aislamiento, medición de medición de la corriente conductora, control de funcionamiento).
3. Como en todo producto de fabricación industrial no puede ser excluido en general de que se produzcan al usarlo elementos que puedan generar alergias, los llamados elementos alergénicos (por ejemplo el níquel). Si se produjeran en el trato con productos R&S reacciones alérgicas, como por ejemplo urticaria, estornudos frecuentes, irritación de la conjuntiva o dificultades al respirar, se deberá consultar inmediatamente a un médico para averiguar los motivos de estas reacciones.
 4. Si productos / elementos de construcción son tratados fuera del funcionamiento definido de forma mecánica o térmica, pueden generarse elementos peligrosos (povos de sustancia de metales pesados como por ejemplo plomo, berilio, níquel). La partición elemental del producto, como por ejemplo sucede en el tratamiento de materias residuales, debe de ser efectuada solamente por personal especializado para estos tratamientos. La partición elemental efectuada inadecuadamente puede generar daños para la salud. Se deben tener en cuenta las directivas nacionales referentes al tratamiento de materias residuales.
 5. En el caso de que se produjeran agentes de peligro o combustibles en la aplicación del producto que debieran de ser transferidos a un tratamiento de materias residuales, como por ejemplo agentes refrigerantes que deben ser repuestos en periodos definidos, o aceites para motores, deberán ser tenidas en cuenta las prescripciones de seguridad del fabricante de estos agentes de peligro o combustibles y las regulaciones regionales para el tratamiento de materias residuales. Cuiden también de tener en cuenta en caso dado las prescripciones de seguridad especiales en la descripción del producto.
 6. Ciertos productos, como por ejemplo las instalaciones de radiación HF, pueden a causa de su función natural, emitir una radiación electromagnética aumentada. En vista a la protección de la vida en desarrollo deberían ser protegidas personas embarazadas debidamente. También las personas con un bypass pueden correr peligro a causa de la radiación electromagnética. El empresario está comprometido a valorar y señalar áreas de trabajo en las que se corra un riesgo de exposición a radiaciones aumentadas de riesgo aumentado para evitar riesgos.
 7. La utilización de los productos requiere instrucciones especiales y una alta concentración en el manejo. Debe de ponerse por seguro de que las personas que manejen los productos estén a la altura de los requerimientos necesarios referente a sus aptitudes físicas, psíquicas y emocionales, ya que de otra manera no se pueden excluir lesiones o daños de objetos. El empresario lleva la responsabilidad de seleccionar el personal usuario apto para el manejo de los productos.
 8. Antes de la puesta en marcha del producto se deberá tener por seguro de que la tensión preseleccionada en el producto equivalga a la del la red de distribución. Si es necesario cambiar la preselección de la tensión también se deberán en caso dabo cambiar los fusibles correspondientes del prodcuto.
 9. Productos de la clase de seguridad I con alimentación móvil y enchufe individual de producto solamente deberán ser conectados para el funcionamiento a tomas de corriente de contacto de seguridad y con conductor protector conectado.
 10. Queda prohibida toda clase de interrupción intencionada del conductor protector, tanto en la toma de corriente como en el mismo producto ya que puede tener como consecuencia el peligro de golpe de corriente por el producto. Si se utilizaran cables o enchufes de extensión se deberá poner al seguro, que es controlado su estado técnico de seguridad.
 11. Si el producto no está equipado con un interruptor para desconectarlo de la red, se deberá considerar el enchufe del cable de distribución como interruptor. En estos casos deberá asegurar de que el enchufe sea de fácil acceso y nabejo (medida del cable de distribución aproximadamente 2 m). Los interruptores de función o electrónicos no son aptos para el corte de la red eléctrica. Si los productos sin interruptor están integrados en construcciones o instalaciones, se deberá instalar el interruptor al nivel de la instalación.

Informaciones de seguridad

12. No utilice nunca el producto si está dañado el cable eléctrico. Asegure a través de las medidas de protección y de instalación adecuadas de que el cable de eléctrico no pueda ser dañado o de que nadie pueda ser dañado por él, por ejemplo al tropezar o por un golpe de corriente.
13. Solamente está permitido el funcionamiento en redes de distribución TN/TT aseguradas con fusibles de como máximo 16 A.
14. Nunca conecte el enchufe en tomas de corriente sucias o llenas de polvo. Introduzca el enchufe por completo y fuertemente en la toma de corriente. Si no tiene en consideración estas indicaciones se arriesga a que se originen chispas, fuego y/o heridas.
15. No sobrecargue las tomas de corriente, los cables de extensión o los enchufes de extensión ya que esto pudiera causar fuego o golpes de corriente.
16. En las mediciones en circuitos de corriente con una tensión de entrada de $U_{eff} > 30 \text{ V}$ se deberá tomar las precauciones debidas para impedir cualquier peligro (por ejemplo medios de medición adecuados, seguros, limitación de tensión, corte protector, aislamiento etc.).
17. En caso de conexión con aparatos de la técnica informática se deberá tener en cuenta que estos cumplan los requisitos de la EC950/EN60950.
18. Nunca abra la tapa o parte de ella si el producto está en funcionamiento. Esto pone a descubierto los cables y componentes eléctricos y puede causar heridas, fuego o daños en el producto.
19. Si un producto es instalado fijamente en un lugar, se deberá primero conectar el conductor protector fijo con el conductor protector del aparato antes de hacer cualquier otra conexión. La instalación y la conexión deberán ser efectuadas por un electricista especializado.
20. En caso de que los productos que son instalados fijamente en un lugar sean sin protector implementado, autointerruptor o similares objetos de protección, deberá la toma de corriente estar protegida de manera que los productos o los usuarios estén suficientemente protegidos.
21. Por favor, no introduzca ningún objeto que no esté destinado a ello en los orificios de la caja del aparato. No vierta nunca ninguna clase de líquidos sobre o en la caja. Esto puede producir corto circuitos en el producto y/o puede causar golpes de corriente, fuego o heridas.
22. Asegúrese con la protección adecuada de que no pueda originarse en el producto una sobrecarga por ejemplo a causa de una tormenta. Si no se verá el personal que lo utilice expuesto al peligro de un golpe de corriente.
23. Los productos R&S no están protegidos contra el agua si no es que exista otra indicación, ver también punto 1. Si no se tiene en cuenta esto se arriesga el peligro de golpe de corriente o de daños en el producto lo cual también puede llevar al peligro de personas.
24. No utilice el producto bajo condiciones en las que pueda producirse y se hayan producido líquidos de condensación en o dentro del producto como por ejemplo cuando se desplaza el producto de un lugar frío a un lugar caliente.
25. Por favor no cierre ninguna ranura u orificio del producto, ya que estas son necesarias para la ventilación e impiden que el producto se caliente demasiado. No pongan el producto encima de materiales blandos como por ejemplo sofás o alfombras o dentro de una caja cerrada, si esta no está suficientemente ventilada.
26. No ponga el producto sobre aparatos que produzcan calor, como por ejemplo radiadores o calentadores. La temperatura ambiental no debe superar la temperatura máxima especificada en la hoja de datos.

Informaciones de seguridad

27. Baterías y acumuladores no deben de ser expuestos a temperaturas altas o al fuego. Guardar baterías y acumuladores fuera del alcance de los niños. Si las baterías o los acumuladores no son cambiados con la debida atención existirá peligro de explosión (atención celulas de Litio). Cambiar las baterías o los acumuladores solamente por los del tipo R&S correspondiente (ver lista de piezas de recambio). Baterías y acumuladores son deshechos problemáticos. Por favor tirenlos en los recipientes especiales para este fin. Por favor tengan en cuenta las prescripciones nacionales de cada país referente al tratamiento de deshechos. Nunca sometan las baterías o acumuladores a un corto circuito.
28. Tengan en consideración de que en caso de un incendio pueden escaparse gases tóxicos del producto, que pueden causar daños a la salud.
29. Por favor tengan en cuenta que en caso de un incendio pueden desprenderse del producto agentes venenosos (gases, líquidos etc.) que pueden generar daños a la salud.
30. No sitúe el producto encima de superficies, vehículos, estantes o mesas, que por sus características de peso o de estabilidad no sean aptas para él. Siga siempre las instrucciones de instalación del fabricante cuando instale y asegure el producto en objetos o estructuras (por ejemplo paredes y estantes).
31. Las asas instaladas en los productos sirven solamente de ayuda para el manejo que solamente está previsto para personas. Por eso no está permitido utilizar las asas para la sujecion en o sobre medios de transporte como por ejemplo grúas, carretillas elevadoras de horquilla, carros etc. El usuario es responsable de que los productos sean sujetados de forma segura a los medios de transporte y de que las prescripciones de seguridad del fabricante de los medios de transporte sean tenidas en cuenta. En caso de que no se tengan en cuenta pueden causarse daños en personas y objetos.
32. Si llega a utilizar el producto dentro de un vehículo, queda en la responsabilidad absoluta del conductor que conducir el vehículo de manera segura. Asegure el producto dentro del vehículo debidamente para evitar en caso de un accidente las lesiones u otra clase de daños. No utilice nunca el producto dentro de un vehículo en movimiento si esto pudiera distraer al conductor. Siempre queda en la responsabilidad absoluta del conductor la seguridad del vehículo y el fabricante no asumirá ninguna clase de responsabilidad por accidentes o colisiones.
33. Dado el caso de que esté integrado un producto de laser en un producto R&S (por ejemplo CD/DVD-ROM) no utilice otras instalaciones o funciones que las descritas en la documentación. De otra manera pondrá en peligro su salud, ya que el rayo laser puede dañar irreversiblemente sus ojos. Nunca trate de descomponer estos productos. Nunca mire dentro del rayo laser.



Certificate No.: 98080

This is to certify that:

Equipment type	Order No.	Designation
CTS60	1094.0006.60	Digital Radio Tester

complies with the provisions of the Directive of the Council of the European Union on the approximation of the laws of the Member States

- relating to electrical equipment for use within defined voltage limits
(73/23/EEC revised by 93/68/EEC)
- relating to electromagnetic compatibility
(89/336/EEC revised by 91/263/EEC, 92/31/EEC, 93/68/EEC)

Conformity is proven by compliance with the following standards:

EN61010-1 : 1993 + A2 : 1995
EN50081-1 : 1992
EN50082-2 : 1995

Affixing the EC conformity mark as from 1998

ROHDE & SCHWARZ GmbH & Co. KG
Mühldorfstr. 15, D-81671 München

Munich, 1999-02-24

Central Quality Management FS-QZ / Becker

1 Introduction

The CTS60 tester is a value for money instrument which supports both automatic function tests and detailed service testing of DECT portable and fixed parts. It provides an easy way to perform accurate measurements in line with the ETSI recommendations detailed in TBR06.

The CTS60 supports six working languages (English, French, German, Italian, Spanish and Dutch). It also has a TFT colour display which helps to make the CTS60 easy to use.

There are two types of tests available on the CTS60; the first is a configurable automatic function test called **Autotest**, the second is a detailed service test called **Manual Test**.

1.1 Autotest Applications

1.1.1 Overview

The CTS60 Autotest provides a very flexible approach to automatic testing. All of the tests provided in Autotest are fully configurable and provide the functionality to define a complete set of automatic tests required by any service application.

The main application of Autotest is to check the operation of a DECT unit before giving it to a customer. For example during a sale (to enhance customer confidence, by demonstrating the proper functioning of the equipment to the customer), before or after a repair, or in the event a complaint is received. In the latter case, the customer's complaint can be verified immediately, avoiding unnecessary return of the mobile phone to a central service station, and thus saving time and expense.

1.1.2 Configurable Test Steps in Autotest

The following types of tests can be configured in Autotest:

- Set up a connection from the CTS60
- Release a connection from the CTS60
- Measurement of the power ramp
- Measurement of modulation frequency parameters for various data types
- Measurement of the Bit Error Rate
- Measurement of timing values

1.2 Manual Test Applications

This part of the CTS60 is designed for service testing and other situations where the user must decide which step has to be performed next. The required measurements can be selected manually, for example power ramp, modulation, timing or bit error rate. Also available in this test mode are graphical displays of the power ramp and modulation data.

2 Preparation for Use

- When unpacking the instrument, please ensure that all other items and accessories included with the CTS60 are enclosed.
- When transporting the instrument it is strongly recommended that the protective caps included in the shipping box for protection of the front and rear panel are used. This serves to prevent damage to the protruding items on the front and rear panels.

Important note:

A rechargeable battery is installed in the CTS60 which allows storage of important instrument parameters when the instrument is switched off. This battery is automatically charged during operation of the instrument. For the battery to be sufficiently charged, the CTS60 should not remain switched off for longer than three months.

2.1 Explanation of Front and Rear View

This page shows the front and rear view of the instrument, with short explanations on the controls and connectors.

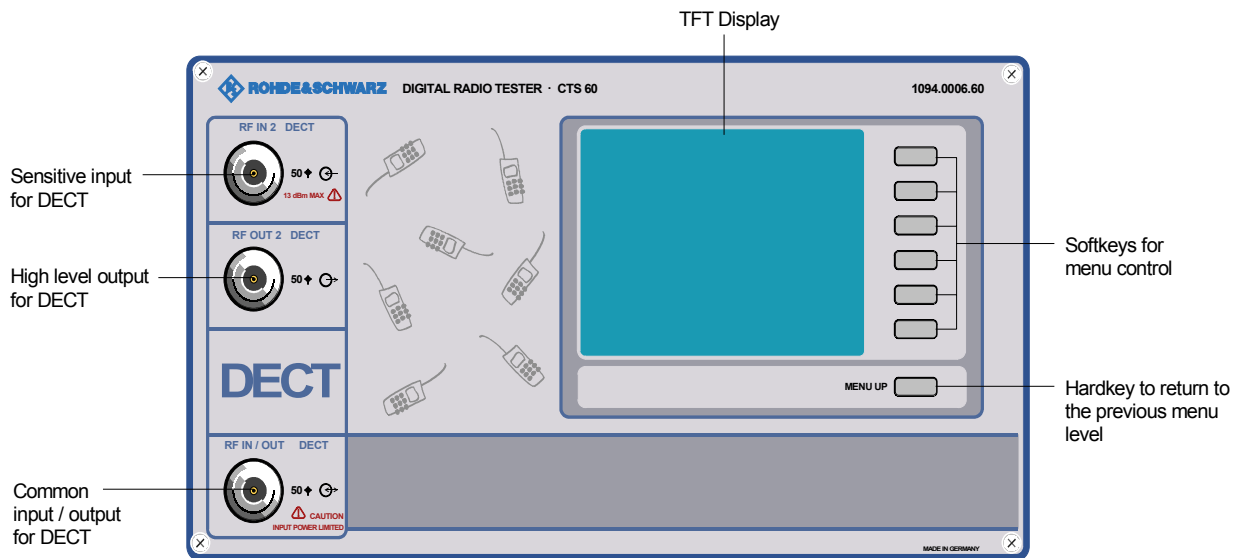

Instrument with input voltage selector

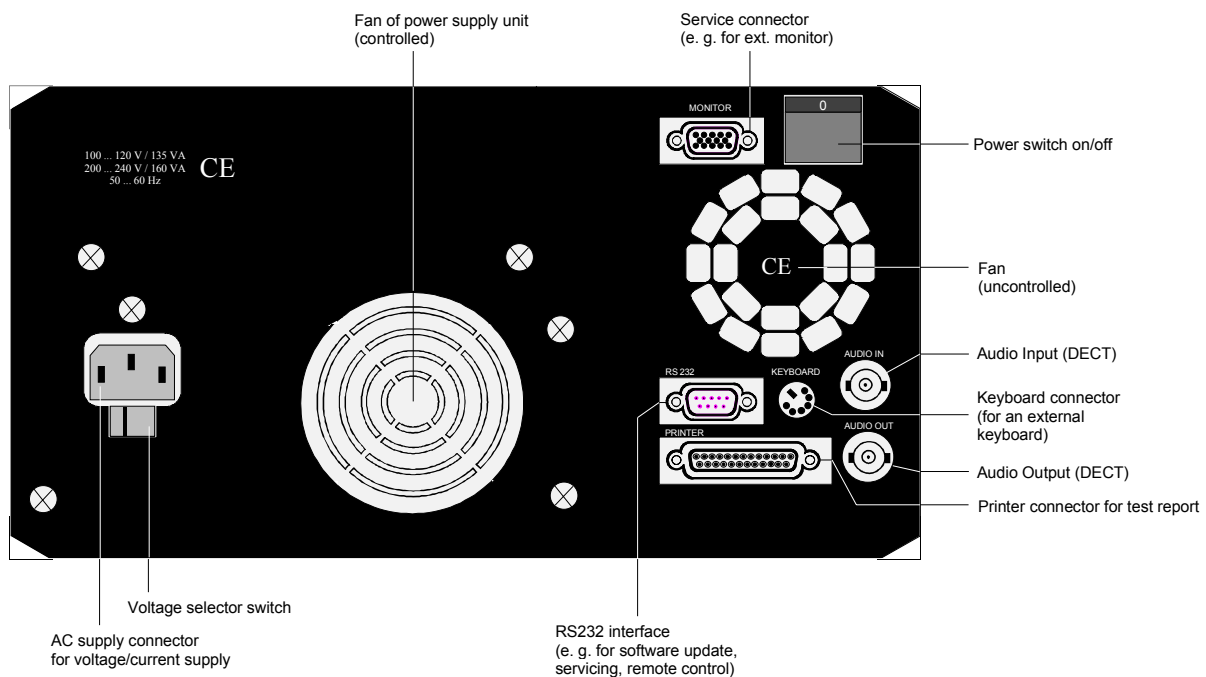

Instrument with wide-range voltage input

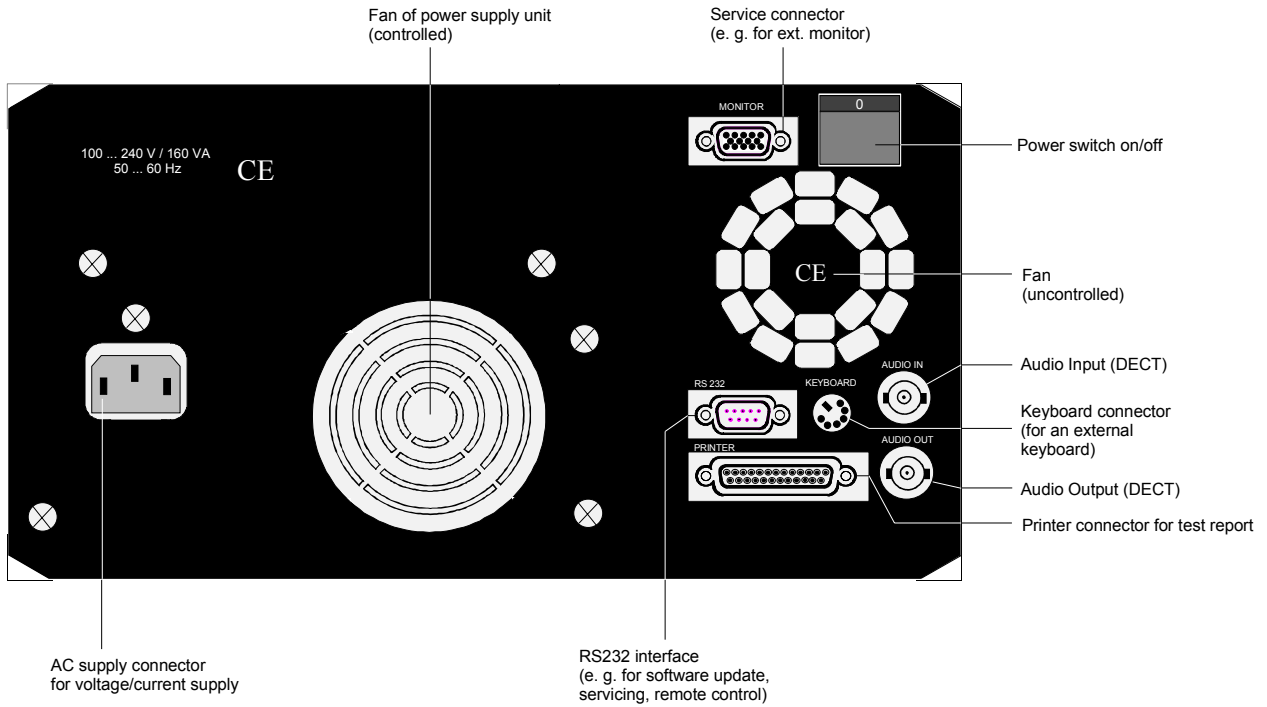

2.2 Commissioning

2.2.1 Setting up the Instrument

For bench measurements, it is recommended that the fold out feet at the bottom of the instrument are used as this improves the viewing angle of the screen.



For optimum operation of the instrument note the following:

- Do not cover the ventilation openings!
- Ambient temperature +5 to +45 °C.
- Avoid moisture and condensation, if it occurs however, the instrument must be thoroughly dried before switching on.

2.2.2 Connecting the Instrument to the AC Supply

- Check the position of the voltage selector and set it to the local AC supply voltage if necessary.
- Plug the supplied power cable into the rear power connector and connect the CTS60 to the power supply.

Instrument with input voltage selector

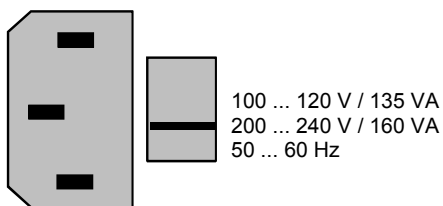

Instrument with wide-range voltage input

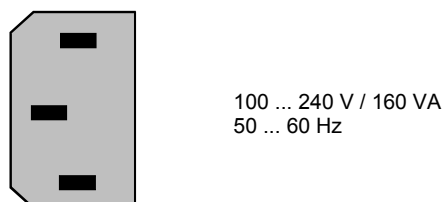

2.2.3 Ensuring Electromagnetic Compliance (EMC)

In order to avoid electromagnetic interference, the instrument may only be operated with all covers in place as they form part of the shielding for the instrument. Only appropriate shielded signal and control cables (e.g. RF connecting cables) should be used.

2.2.4 Switching on the Instrument

The CTS60 is switched on by means of the power switch at the rear.

2.2.5 Options List

After the instrument is switched on a start up screen is displayed while the instruments loads stored parameters and checks which options are installed. After a short time the options screen is displayed (see below). It is advisable to check the options after powering up the instrument for the first time to ensure that the purchased options are installed.

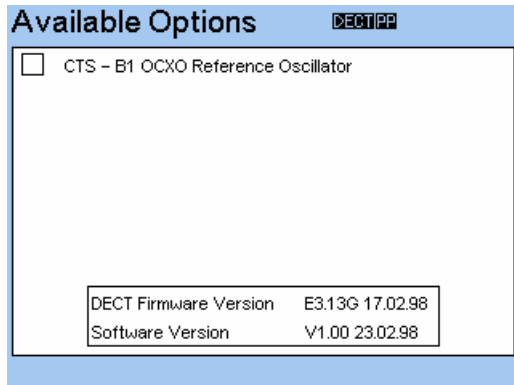

Available Options Menu

If you want to use additional available options, please contact your local Rohde & Schwarz sales representative.

2.2.6 OCXO Reference Oscillator (Option CTS-B1)

If your instrument is equipped with this option, be aware that an OCXO needs approximately 15 minutes to warm up after switching on the instrument to achieve full precision.

3 Getting Started With Autotest

3.1 Overview

In Autotest mode the CTS60 is easy and convenient to operate thanks to its clear menu structure.

If this is your first encounter with CTS60 in Autotest mode, this chapter will give you a quick survey of configuring and running an automatic test.

The autotest enables fixed and portable part tests to be configured as required. The test are stored on the CTS60 and can be selected and run at a future date. There are 10 configurable tests for both fixed and portable part tests. Each of these tests can comprise up to 50 test steps. Conditional and unconditional jumps can also be used to configure longer tests.

The following is a list of the possible actions which can be configured for a test step:

- Free - no action has been assigned to this test step (default value)
- Setup connection - set up a connection with a fixed or portable part depending on the test menu selected
- Power Ramp - perform a single power ramp measurement
- RF Modulation - perform an RF modulation measurement
- Timing - perform a timing measurement
- Bit Error Rate - perform a bit error rate measurement
- Bearer Release - release an established connection
- Pause - pause during an autotest

For further information on the individual menus and keys, refer to the menu descriptions in chapter 6.

3.2 Configuring an autotest

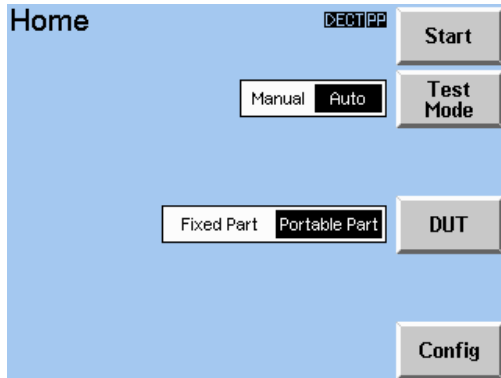

Home Menu

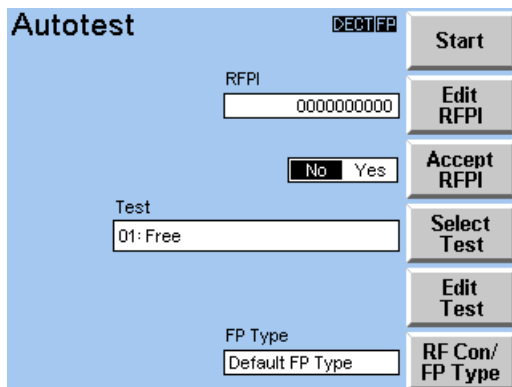

Autotest Start Menu

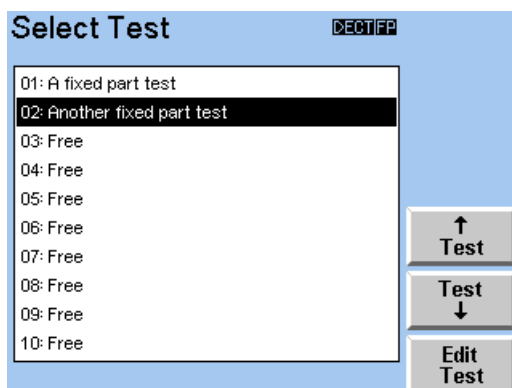

Select Test Menu

Step 1

When the CTS60 is switched on the Home Menu shown opposite appears after a few seconds. The instrument is now ready for testing. Use the "Test Mode" key to toggle between the Manual Test, and Autotest Test modes (must be set to Autotest). Use the "DUT" key to select the device to be tested either fixed part or portable part.

Press "Start" to go to the first Main menu of Autotest.

Step 2

The autotest start menu is now displayed. Press "Select Test" to select a test you wish to configure.

The select test menu is now displayed. Press the Test ↑ and Test ↓ keys to move up and down the list of tests until you have selected the test you wish to edit. Press "Edit Test" to edit the selected test.

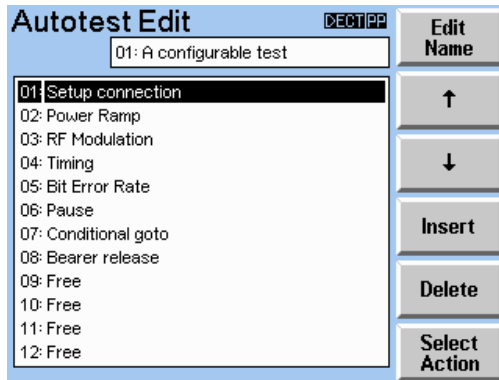
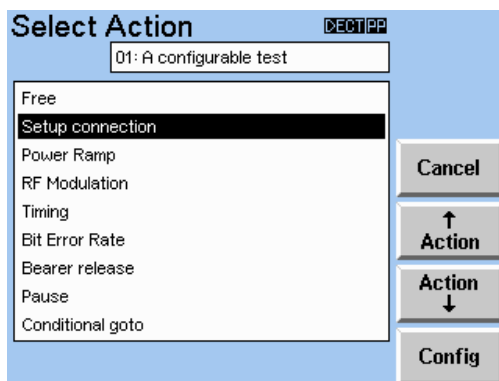
**Autotest Edit Menu****Select Action Menu****Step 3**

The autotest edit menu is now displayed. This menu will enable you to configure a particular test.

Press "Edit Name" and enter a name for this test (note that the test number is not editable). Press "Edit Name" again to accept this selection.

Use the \uparrow \downarrow arrow keys to select each test step in turn. To edit a test step press "Select Action".

Step 4

The select action menu will now be displayed. Use the "Action \uparrow " and "Action \downarrow " to select the action that you wish to configure for this test step.

Once an action has been selected it can be configured by pressing "Config".

You can make presettings and adapt the tolerance limits for OK/Not OK evaluation of the test as required.

Accept the action selected by pressing "Menu up" (or press "Cancel" to leave the previous selection unchanged).

Step 5

Configure all of the test steps to configure an entire test. Then press "Menu up" until you have returned to the autotest start menu.

3.3 Running a fixed part test

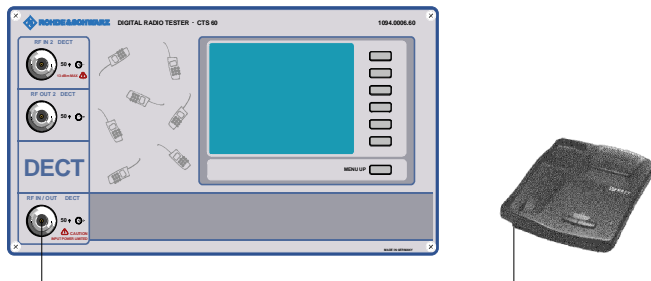

Step 1

Connect a suitable antenna to the N socket of the selected RF connector (default IN1/OUT1) of the CTS60.

Make sure that the DUT is provided with the required supply voltage (charged batteries or power supply unit) and is switched to the service mode (for information on how to activate the service mode of the fixed part please contact the manufacturer).

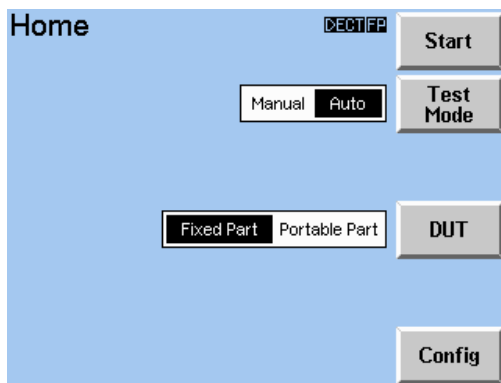

Home Menu

When the CTS60 is switched on the Home Menu shown opposite appears. The instrument is now ready for testing. Use the "Test Mode" key to toggle between the Manual Test, and Autotest Test modes (must be set to Autotest). Use the "DUT" key to select the device to be tested (fixed part).

Press "Start" to go to the first Main menu of Autotest.

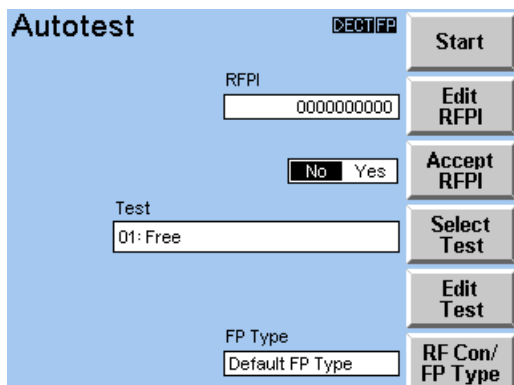

Autotest Start Menu

Step 2

The autotest start menu is now displayed. Press "Select Test" to select a test you wish to run.

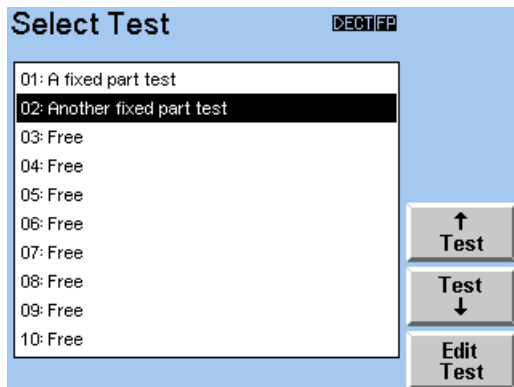

Select Test Menu

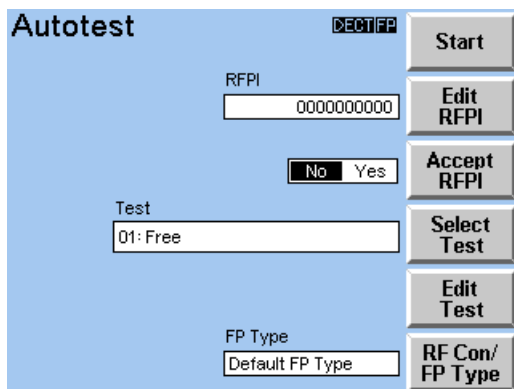

Autotest Start Menu

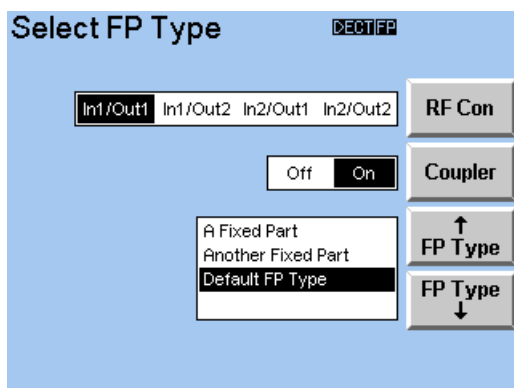

Select FP Type Menu

The select test menu is now displayed. Press the Test ↑ and Test ↓ keys to move up and down the list of tests until you have selected the test you wish to run. Press "Menu up" to accept the selection.

Step 3

The autotest start menu is now displayed.

If you know the RFPI of the fixed part you are testing press "Edit RFPI" and enter it in the RFPI field. Press "Accept RFPI" to set this selection to "No". This will ensure that a connection is set up with the entered RFPI.

If you do not know the RFPI of the fixed part you are testing press "Accept RFPI" and select "Yes". This will connect with the strongest RFPI detected.

Press "RF Con/FP Type" to select the RF connector, the coupler to use and the FP type to test. The select FP type menu is now displayed.

Use the keys "FP Type ↑" and "FP Type ↓" to select the desired type.

Use the key "RF Con" to select the combination of connectors that will be used. The combination selected is displayed.

By pressing the key "Coupler" (On), the correction values entered in the menu "Edit FP Type" (see 6.4.3) are taken into account.

Press "Menu up" to accept the selection.

The screenshot shows the 'Autotest' start menu. At the top left is the title 'Autotest' and a 'DECTFP' indicator. Below it is an 'RFPI' field with the value '0000000000'. To the right of this field are buttons for 'Start', 'Edit RFPI', 'Accept RFPI', 'Select Test', 'Edit Test', and 'RF Con/FP Type'. Below the RFPI field is a 'Test' field with the value '01: Free' and a 'No Yes' toggle. At the bottom is an 'FP Type' field with the value 'Default FP Type'.

Autotest Start Menu

Step 4

To start the test press "Start" on the autotest start menu.

The screenshot shows the 'Autotest' running menu. At the top left is the title 'Autotest' and a 'DECTFP' indicator. Below it is a field with the value '02: Another configured test' and an 'Abort' button. Below this is a table with three columns: 'Action/Parameter', 'Value', and 'Result'.

Action/Parameter	Value	Result
(01) Setup Connection:		
Detected RFPI	0002EB0E00	
Dummy Slot	0	
Dummy Carrier	0	
(02) Power Ramp:		
NTP	22 dBm	Pass
Template	Matching	Pass
(03) RF Modulation:		
Freq. Offset	-13 kHz	Pass

Autotest Running Menu

While the test is running the test results are displayed in a scrolling window. The "Action/Parameter" column displays the number of the test step, the action which was executed, and the parameter which was measured.

The "Values" column displays measured values. The "Result" column displays the results of the tolerance checks made by comparing the measured values with the configured tolerance values.

The test can be aborted at any time by pressing the "Abort" key.

At certain points during the test there may be a pause configured. In this case press the "Cont" key to continue with the test.

Autotest			Start Menu
02: Another configured test			↑ Page
Action/Parameter	Value	Result	Page ↓
(01) Setup Connection:			↑ Line
Detected RFPI	0002EB0E00		Line ↓
Dummy Slot	0		Print Report
Dummy Carrier	0		
(02) Power Ramp:			
NTP	22 dBm	Pass	
Template	Matching	Pass	
(03) RF Modulation:			
Freq. Offset	-13 kHz	Pass	
Test Passed			

Autotest Results Menu**Step 5**

Once the test has completed or been aborted the autotest results menu will be displayed. This displays the results of the test as they were displayed while the test was running. The overall result of the test is displayed at the bottom.

Press "Page ↑", "Page ↓", "Line↑", or "Line ↓" to scroll up and down through the results.

Press "Print Report" to print out a hardcopy of the test and the results.

Press "Start Menu" to return to the autotest start menu.

3.4 Running a portable part test

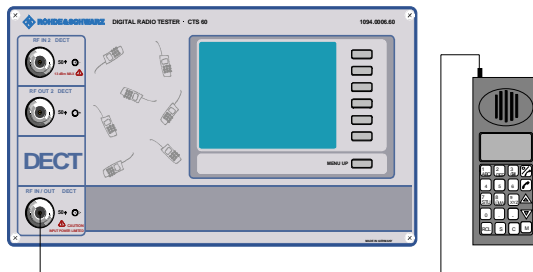

Step 1

Connect a suitable antenna to the N socket of the selected RF connector (default IN1/OUT1) of the CTS60.

Make sure that the DUT is provided with the required supply voltage (charged battery or power supply unit) and is switched to the service mode (for information on how to activate the service mode of the portable part please contact the manufacturer).

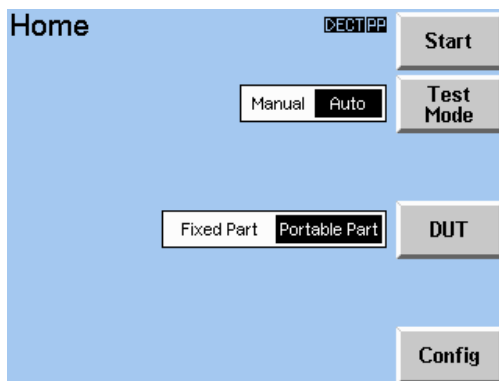

Home Menu

When the CTS60 is switched on the Home Menu shown opposite appears. The instrument is now ready for testing. Use the "Test Mode" key to toggle between the Manual Test, and Autotest Test modes (must be set to Autotest). Use the "DUT" key to select the device to be tested (portable part).

Press "Start" to go to the first Main menu of Autotest.

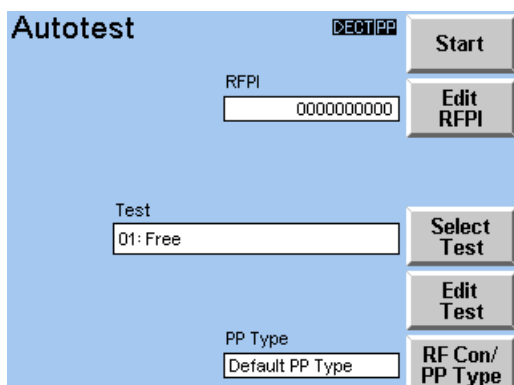

Autotest Start Menu

Step 2

The autotest start menu is now displayed. Press "Select Test" to select a test you wish to run.

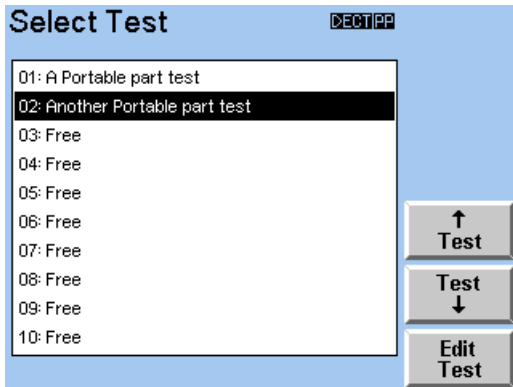

Select Test Menu

The select test menu is now displayed. Press the Test ↑ and Test ↓ keys to move up and down the list of tests until you have selected the test you wish to run. Press "Menu up" to accept the selection.

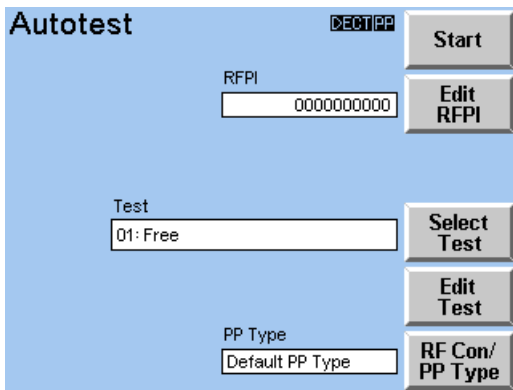

Autotest Start Menu

Step 3

The autotest start menu is now displayed.

Presss "Edit RFPI" and enter an RFPI that the portable part will synchronise to in the RFPI field. Press "Edit RFPI" again to accept this selection.

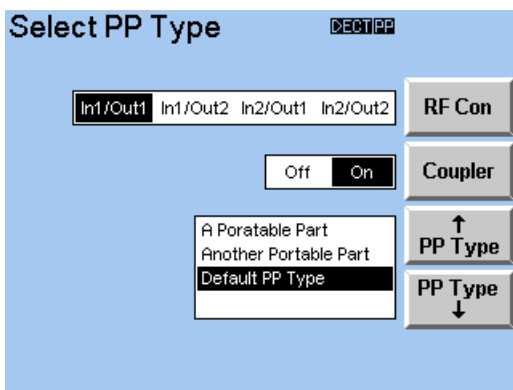

Select PP Type Menu

Press "RF Con/PP Type" to select the RF connector, the coupler to use and the PP type to test. The select PP type menu is now displayed.

Use the keys "PP Type ↑" and "PP Type ↓" to select the desired type.

Use the key "RF Con" to select the combination of connectors that will be used. The combination selected is displayed.

Use the key "Coupler" to set the coupler state. Coupler "On" means that the configured attenuation values for the selected PP type will be used on the calculations (that is, a coupler is present).

Press "Menu up" to accept the selection.

The screenshot shows the 'Autotest' start menu. At the top left is the title 'Autotest' and a 'DECTPP' indicator. Below the title is a 'Start' button. To the left of the 'Start' button is an 'RFPI' field with a text input box containing '0000000000' and an 'Edit RFPI' button. Below the 'RFPI' field is a 'Test' field with a text input box containing '01: Free' and a 'Select Test' button. Below the 'Test' field is a 'PP Type' field with a text input box containing 'Default PP Type' and an 'Edit Test' button. At the bottom right is an 'RF Con/PP Type' button.

Autotest Start Menu

The screenshot shows the 'Autotest' running menu. At the top left is the title 'Autotest' and a 'DECTPP' indicator. Below the title is a text input box containing '01: Undefined Test' and an 'Abort' button. Below the text input box is a table with three columns: 'Action/Parameter', 'Value', and 'Result'. The table contains three rows of test results. Below the table is a 'Running' indicator.

Action/Parameter	Value	Result
(01) Setup Connection: Detected PMID	EBE8D	
(02) Power Ramp: NTP Template	22 dBm Matching	Pass Pass
(03) RF Modulation: Freq. Offset Max Pos B-field Max Neg B-field	-13 kHz +349 kHz -251 kHz	Pass Pass Fail

Autotest Running Menu**Step 4**

To start the test press "Start" on the autotest start menu.

While the test is running the test results are displayed in a scrolling window. The "Action/Parameter" column displays the number of the test step, the action which was executed, and the parameter which was measured.

The "Values" column displays measured values. The "Result" column displays the results of the tolerance checks made by comparing the measured values with the configured tolerance values.

The test can be aborted at any time by pressing the "Abort" key.

At certain points during the test there may be a pause configured. In this case press the "Cont" key to continue with the test.

Autotest			Start Menu
01: Undefined Test			↑ Page
Action/Parameter	Value	Result	Page ↓
(01) Setup Connection: Detected PMID	EBE8D		↑ Line
(02) Power Ramp: NTP	22 dBm	Pass	Line ↓
Template	Matching	Pass	Print Report
(03) RF Modulation: Freq. Offset	-13 kHz	Pass	
Max Pos B-field	+349 kHz	Pass	
Max Neg B-field	-251 kHz	Fail	
Test Failed			

Autotest Results Menu**Step 5**

Once the test has completed or been aborted the autotest results menu will be displayed. This displays the results of the test as they were displayed while the test was running. The overall result of the test is displayed at the bottom.

Press "Page ↑", "Page ↓", "Line↑", or "Line ↓" to scroll up and down through the results.

Press "Print Report" to print out a hardcopy of the test and the results.

Press "Start Menu" to return to the autotest start menu.

3.5 Notes on configuring an autotest

When configuring an autotest the following points should be taken into account:

- Tests should typically start with "Setup Connection" and end with "Bearer Release". That is, in order to run measurements a connection must first be set up. Once the measurements are complete the connection must be released.
- When setting up a connection with a portable part you must configure the sync. type as manual or auto. If the sync. type is configured as auto then the sync. time must also be configured with a value of 0 to 10 seconds. This will be the time waited before the call is set up. If the sync. type is configured as manual then the user will be prompted to press the "CONT" key before the test continues.
- Configuration of measurement actions is the same as configuring manual test actions (see "Getting Started With Manual Test") except that the RF level must be configured for each BER measurement.
- Make sure to select a level sufficiently high to match the selected coupling.
- If a test step is configured as pause the CTS60 will not continue until the "CONT" key is pressed or a timeout period is reached.
- The goto action can be configured to insert conditional or unconditional loops in tests. For details of configuring loops see the config goto menu section in the "Detailed description of the menus".
- The autotest report (both on the screen and printed) will contain only the last 3000 lines of the test. When the report reaches this number the first lines will be discarded.

4 Getting Started With Manual Test

4.1 Overview

In Manual Test mode the user selects the required test by selecting an appropriate measurement menu. If this is your first encounter with CTS60 in Manual Test mode, this chapter will give you a quick survey of tests performed on DECT fixed and portable parts. You will be guided step by step through the Manual Test menus. If more detail is required for any of the menus please refer to the Menus section of this manual.

To become familiar with CTS60 in Manual Test mode and its wide variety of test functions, try out the functions described using a CTS60 and a DECT fixed or portable part. The instructions and information given in this chapter are based on the assumption that the DUT is connected to the CTS60 via an antenna.

Important notes:

Fixed parts transmit a dummy bearer on a channel, which includes the Radio Fixed Part Identifier (RFPI) which uniquely identifies the unit.

When testing a fixed part the CTS60 simulates a portable part. It synchronises to the fixed parts dummy bearer and then displays details of the channel and the RFPI. The CTS60 then requests the establishment of a traffic channel with the fixed part.

When testing a portable part the CTS60 simulates a fixed part. It transmits a dummy bearer on a configured channel with a configured RFPI. The portable part being tested will then synchronise to this dummy bearer. If the portable part is in test mode then the CTS60 can establish a traffic channel with it.

Special attention is required when using an antenna coupler. Attention should be paid to other DECT systems in the vicinity in order to ensure that the channels configured on the CTS60 for the dummy and traffic bearers do not conflict with these systems.

It is important to use the correct antenna coupler so that the input RF Level is inside the allowed range for the connector being used (refer to the technical information section for the allowed RF range). The attenuation/gain value of the coupler should then be configured for the FP (or PP) type being used (see *Selecting and Configuring Types*), so that the software can compensate for the attenuation and display the real value. Failure to do so may result in the CTS60 displaying incorrect values.

It is important that only the fixed part or the portable part be operated at a time. This is to avoid the DUT synchronizing to its own fixed or portable part instead of synchronizing to the CTS or the DUT being disturbed by its own fixed or portable part.

4.2 Testing a Fixed Part

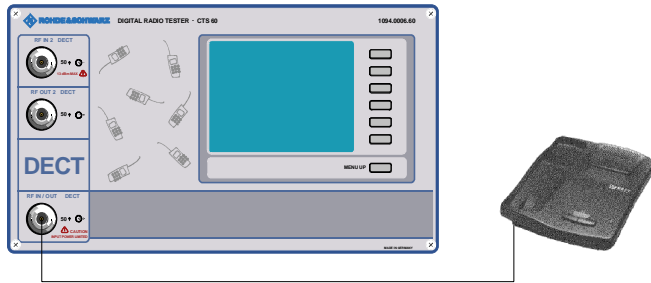

Step 1

Connect a suitable antenna to the N socket of the selected RF connector (default IN1/OUT1) of the CTS60.

Make sure that the DUT is provided with the required supply voltage (charged battery or power supply unit) and is switched to the service mode (for information on how to activate the service mode of the fixed part please contact the manufacturer).

When the CTS60 is switched on the Home Menu shown opposite appears after a few seconds. The instrument is now ready for testing. Use the "Test Mode" key to toggle between the Manual Test, and Autotest Test modes (must be set to Manual Test). Use the "DUT" key to select the device to be tested (fixed part).

Press "Start" to go to the first Main menu of Manual Test, Synchronisation.

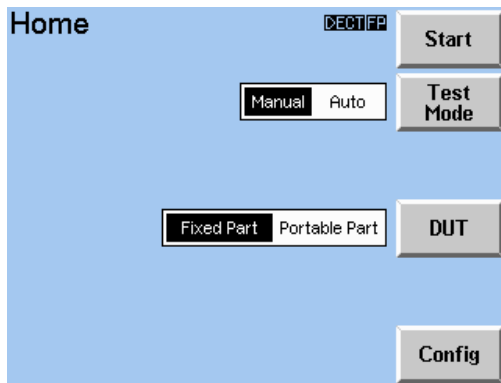

Home Menu

Step 2

After the start button is pressed in the Home menu the Synchronisation menu is displayed. The CTS60 is now waiting to synchronise with a fixed part (the text "Synchronising" blinks in a yellow box). The text "Wait for FP Synchronisation" appears in a green box at the bottom of the screen.

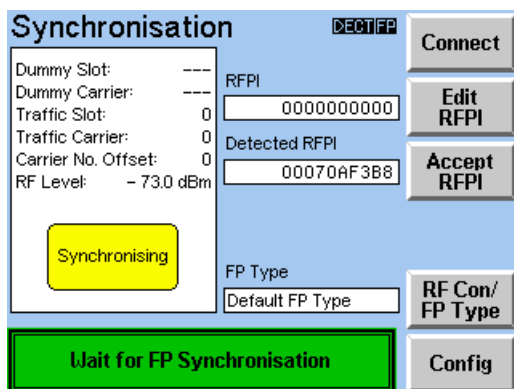

Synchronisation Menu

The fixed part to be tested should now be turned on in test mode. The method for doing this will depend on the type of fixed part. Consult the manufacturer for more details.

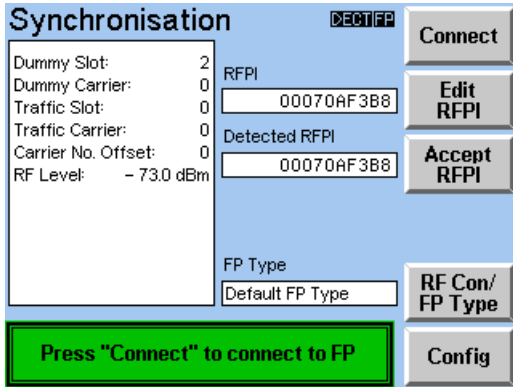

Synchronisation Menu

As soon as the CTS60 has successfully synchronised with the fixed part the "Synchronising" message will disappear. The text "Press "Connect" to connect to FP" appears in a green box at the bottom of the screen.

At this point the dummy slot and carrier fields display the values of the carrier being transmitted by the fixed part and the Radio Fixed Part Identifier (RFPI) of the fixed part is displayed in the "Detected RFPI" field. If this detected RFPI is different to the value displayed in the "RFPI" field then press the "Accept RFPI" key. This will copy the value across.

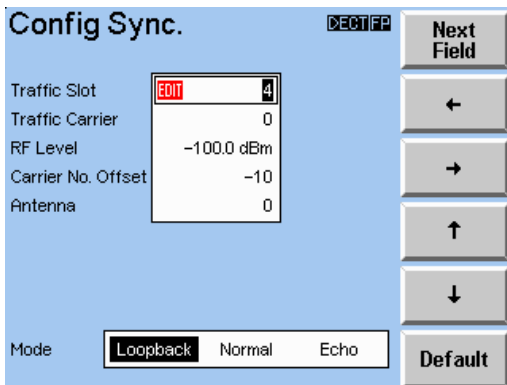

Config Sync. Menu

Step 3

Before setting up a connection press "Config" on the Synchronisation menu.

Here the traffic slot should be configured to ensure that it is not the same as the dummy slot. The RF transmit level of the CTS60 should be configured to an appropriate value. Set the desired carrier offset and antenna if required.

Finally select the required mode for the connection ("loopback", "normal", or "echo"). Note that the mode selected will affect which measurement values are displayed on some menus.

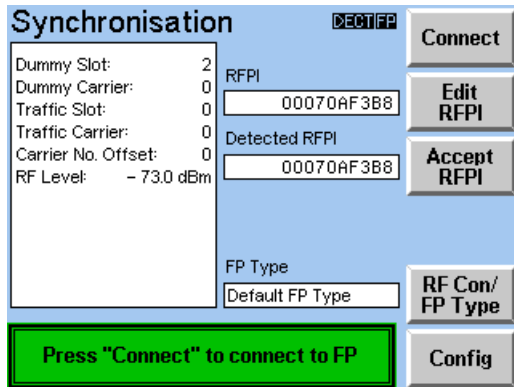

Synchronisation Menu

Step 4

Return to the Synchronisation menu and wait for the CTS60 to Synchronise with the fixed part.

Press "Connect" on the Synchronisation menu to set up the connection.

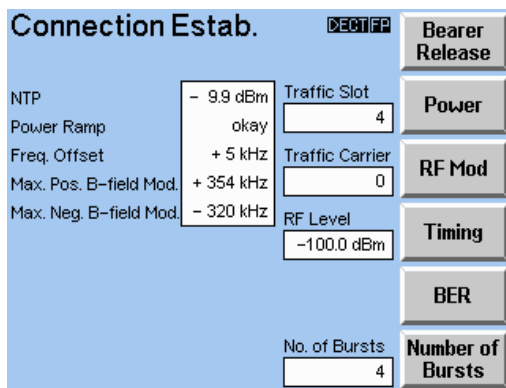

Connection Established Menu

The display will change to the Connection Established Menu.

This is the central measurement menu. It displays an overview of the power ramp and modulation measurements. Detailed transmitter and receiver measurement results can be displayed by selecting and starting the appropriate measurement.

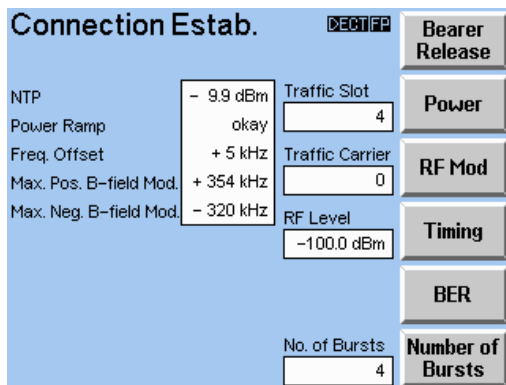

Connection Established Menu

Step 5

The connection can be released at any point by pressing the "Bearer Release" or "Menu up" keys on the Connection Established menu. The CTS60 will then return to the Synchronisation menu.

4.3 Testing a Portable Part

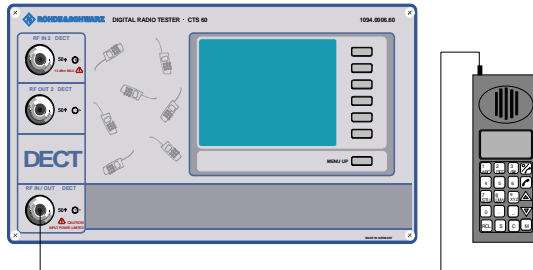

Step 1

Connect a suitable antenna to the N socket of the selected RF connector (default IN1/OUT1) of the CTS60.

Make sure that the DUT is provided with the required supply voltage (charged battery or power supply unit) and is switched to the service mode (for information on how to activate the service mode of the portable part please contact the manufacturer).

When the CTS60 is switched on the Home Menu shown opposite appears after a few seconds. The instrument is now ready for testing. Use the "Test Mode" key to toggle between the Manual Test, and Autotest Test modes (must be set to Manual Test). Use the "DUT" key to select the device to be tested (portable part).

Press "Start" to go to the first Main menu of Manual Test, Synchronisation.

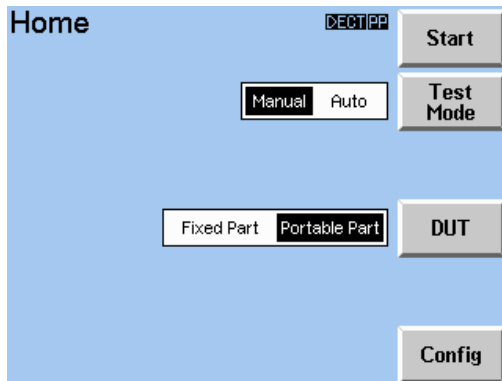

Home Menu

Step 2

After the start button is pressed in the Home menu the Synchronisation menu is displayed.

The text "Wait for PP Synchronisation then press "Connect" to connect to PP" is displayed.

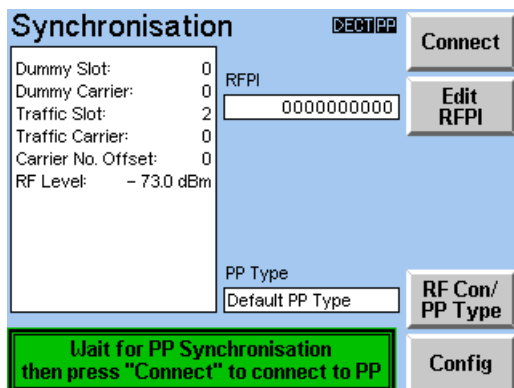

Synchronisation Menu

The portable part to be tested should now be turned on in test mode. The method for doing this will depend on the type of fixed part. Consult the manufacturer for more details.

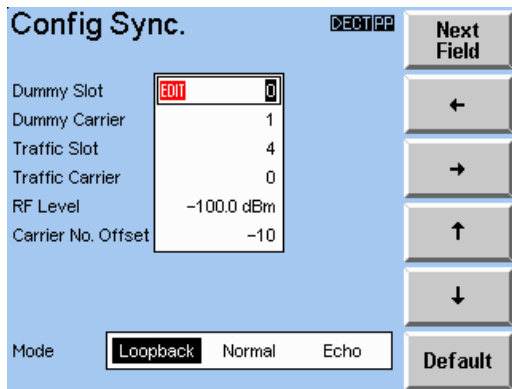

Config Sync. Menu

Step 3

Before setting up a connection press "Config" on the Synchronisation menu.

Here the traffic and dummy slots should be configured to ensure that they are not the same. The RF transmit level of the CTS60 should be configured to an appropriate value. Set the desired carrier offset if required. Finally select the required mode for the connection ("loopback", "normal", or "echo"). Note that the mode selected will affect which measurement values are displayed on some menus.

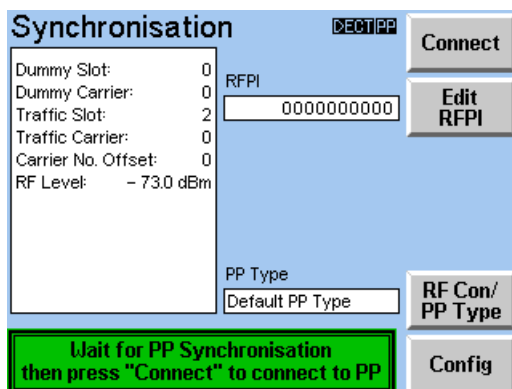

Synchronisation Menu

Step 4

Return to the Synchronisation menu and wait for the portable part to synchronise with the CTS60. Press connect on the Synchronisation menu to set up the connection.

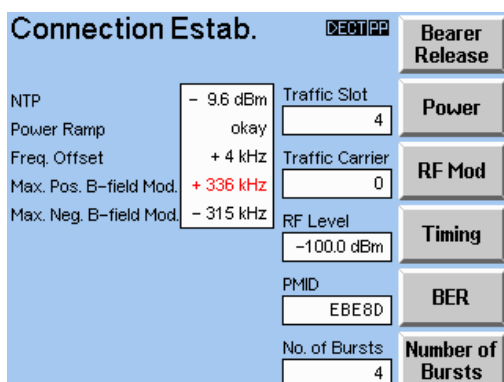

Connection Established Menu

The display will change to the Connection Established Menu.

This is the central measurement menu. It displays an overview of the power ramp and modulation measurements.

Detailed transmitter and receiver measurement results can be displayed by selecting and starting the appropriate measurement.

Connection Estab.		DECT PP	Bearer Release
NTP	- 9.6 dBm	Traffic Slot	Power
Power Ramp	okay	<input type="text" value="4"/>	RF Mod
Freq. Offset	+ 4 kHz	Traffic Carrier	Timing
Max. Pos. B-field Mod.	+ 336 kHz	<input type="text" value="0"/>	BER
Max. Neg. B-field Mod.	- 315 kHz	RF Level	Number of Bursts
		<input type="text" value="-100.0 dBm"/>	
		PMID	
		<input type="text" value="EBE8D"/>	
		No. of Bursts	
		<input type="text" value="4"/>	

Connection Established Menu**Step 5**

The connection can be released at any point by pressing the "Bearer Release" key or "Menu up" on the Connection Established menu. The CTS60 will then return to the Synchronisation menu.

4.4 Transmitter Measurements

Connection Estab.		CECTPP	Bearer Release
NTP	- 9.6 dBm	Traffic Slot	Power
Power Ramp	okay	<input type="text" value="4"/>	RF Mod
Freq. Offset	+ 4 kHz	Traffic Carrier	Timing
Max. Pos. B-field Mod.	+ 336 kHz	<input type="text" value="0"/>	BER
Max. Neg. B-field Mod.	- 315 kHz	RF Level	Number of Bursts
		<input type="text" value="-100.0 dBm"/>	
		PMID	
		<input type="text" value="EBE8D"/>	
		No. of Bursts	
		<input type="text" value="4"/>	

Connection Established Menu

In the Connection Established Menu the traffic slot and carrier of the current connection, and the transmit RF level of the CTS60 are displayed. If a portable part is being tested its PMID will also be displayed here.

It is possible to configure the number of bursts used for all transmitter measurements on this menu.

Displayed on this menu is a summary of some of the important transmitter measurements:

the NTP, power ramp tolerance check, frequency offset, and the maximum positive and negative B-field modulation.

If any of these measurements are out of tolerance they are displayed in red. Tolerance values for these measurements are set on the configuration menu for the relevant measurement.

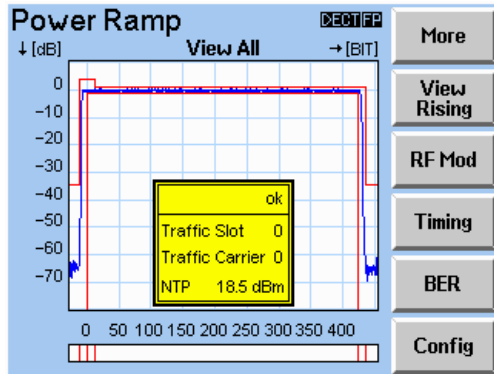

Power Ramp Menu

After selecting the power ramp by pressing the "Power" key the Power Ramp screen will be displayed.

Here the DUT's burst is displayed.

Using the "View" key different views of the ramp can be selected.

If the ramp is out of tolerance the faulty section is highlighted in red on the tolerance bar at the bottom of the display.

The yellow box in the centre of the ramp displays details of the current measurement. The overall result of the power ramp tolerance check is displayed as "Ok" or "Fail". Also displayed are the current traffic slot and carrier, and the NTP measurement.

If the NTP measurement is out of tolerance it is displayed in red. Tolerance values for the ramp and the NTP are set on the Power Ramp Configuration menu (press "Config" to enter this menu).

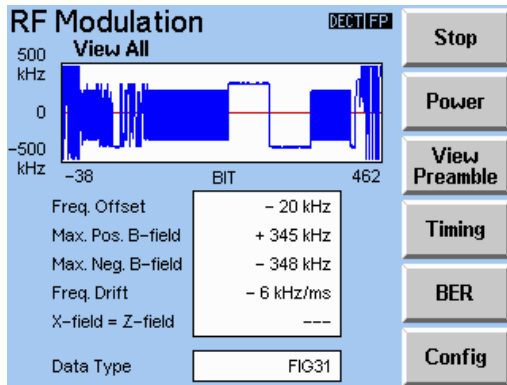

RF Modulation Menu

After selecting RF modulation by pressing the "RF Mod" key the RF Modulation menu will be displayed.

Here the modulation of the DUT's RF burst is displayed.

Using the "View" key different views of the modulation graph can be selected.

Measurements of frequency offset, maximum positive and negative B-field modulation, frequency drift, and X=Z field comparison are displayed. If any of these measurements are out of tolerance they are displayed in red. Tolerance values for these measurements are set on the RF Modulation configuration menu (press "Config" to enter this menu).

The data type at the bottom of the menu is the data pattern being transmitted to, and back from the DUT.

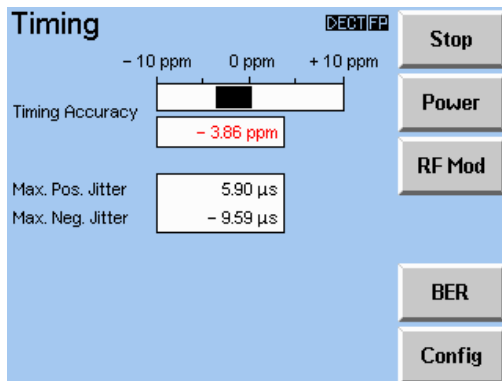

Timing Menu (Fixed Part)

After selecting Timing by pressing the "Timing" key the Timing menu will be displayed.

Different measurements will be displayed on the menu depending on the DUT selected. When the DUT selected is fixed part the menu opposite is displayed. This displays the timing accuracy measurement (both as a value and as a bar), and the maximum positive and negative jitter measurements. If any of these measurements are out of tolerance they are displayed in red. Tolerance values for these measurements are set on the Timing configuration menu (press "Config" to enter this menu).

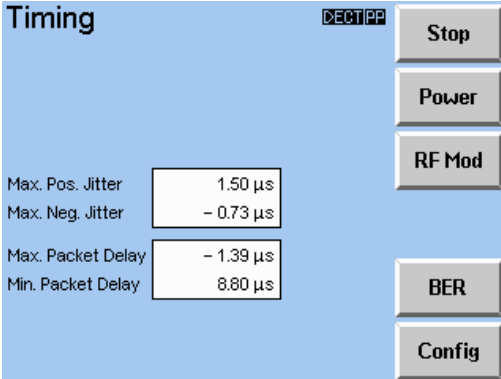

The screenshot shows a software interface titled "Timing" with a blue background. In the top right corner, there is a small icon of a portable device and the text "DECTPP". Below this, there are four buttons stacked vertically: "Stop", "Power", "RF Mod", and "BER". On the left side, there are four data entries, each with a label and a value in a white box:

Max. Pos. Jitter	1.50 μ s
Max. Neg. Jitter	- 0.73 μ s
Max. Packet Delay	- 1.39 μ s
Min. Packet Delay	8.80 μ s

At the bottom of the interface, there is a "Config" button.

Timing Menu (Portable Part)

When the DUT selected is portable part the menu opposite is displayed. This displays the maximum positive and negative jitter measurements, and the maximum and minimum packet delay measurements. If any of these measurements are out of tolerance they are displayed in red. Tolerance values for these measurements are set on the Timing configuration menu (press "Config" to enter this menu).

4.5 Receiver Measurements

Bit Error Rate			DECTFP	Stop
Samples	Current	Preset		Power
<input type="checkbox"/>	<input type="text" value="10"/>	<input type="text" value="100"/>		RF Mod
Current BER	<input type="text" value="140 ppm"/>			Timing
Current FER	<input type="text" value="19527 ppm"/>			RF Level
Longterm BER	<input type="text" value="47165 ppm"/>	RF Level		Config
Longterm FER	<input type="text" value="22955 ppm"/>	<input type="text" value="0.0 dBm"/>		

BER Menu

After selecting BER by pressing the "BER" key the BER menu will be displayed.

At the top of the menu, the current sample being measured and the preset number of samples are displayed.

It is also possible to configure the RF transmit level of the CTS60 on this menu to assess its effect on the frame and bit error rates.

Current and longterm measurements of the frame and bit error rate are displayed here. If any of these measurements are out of tolerance they are displayed in red. Tolerance values for these measurements are set on the BER configuration menu (press "Config" to enter this menu).

5 RF connection

5.1 RF Connection of the Device Under Test Using an Antenna Coupler

Manufacturers of DECT units do not normally provide an RF socket in the unit so connection with an antenna is usually the only means of testing DECT units.

In order to make accurate, reproducible measurements it is necessary to work with an accurately defined attenuation. Separate input and output attenuation values can be configured for each of the fixed and portable part user defined types.

The output attenuation value is used when setting the RF transmit level of the CTS60. The RF level configured on the CTS60 is the actual power level received by the DUT allowing for the attenuation.

The input attenuation will be applied to power measurements to ensure that these are calculated correctly allowing for the attenuation of the coupler.

It is important to set the right attenuation values as these will affect not only the calculations but also the hardware gain of the amplifiers. If the attenuation values that are set on the CTS60 are different from the real attenuation of the coupler the measurements made by the CTS60 could be incorrect.

It is also important to set a right attenuation coupler, so that the input RF level is inside the allowed range for the connector being used. Inputting an out-of-range signal will lead to incorrect measurements being made by the CTS60, or, in an extreme case, damage to the connector. Refer to the technical information section for the allowed RF level range for each connector.

6 Detailed Description of the Menus

6.1 Menu Structure

6.1.1 Menu Structure Overview

The entire menu structure is divided into four sections (see menu structure graph):

1. Menus seen immediately after power on, that is the Logo screen, the Available Options Menu and the Home Menu. From the Home Menu any of the remaining three divisions can be reached.
2. Manual Test menus including Manual Test configuration menus.
3. Autotest menus including Autotest configuration menus.
4. Configuration menus for the whole system

6.1.2 Status Labels

These are displayed at the top of every menu. They detail the network type ("DECT"). The Gap mode is combined with the device under test. If Gap mode is selected, ("GFP" or "GPP") will be displayed according to the selected device under test. If Gap mode is not selected the status label will only display the device under test ("FP" or "PP").

Menu Structure Graph

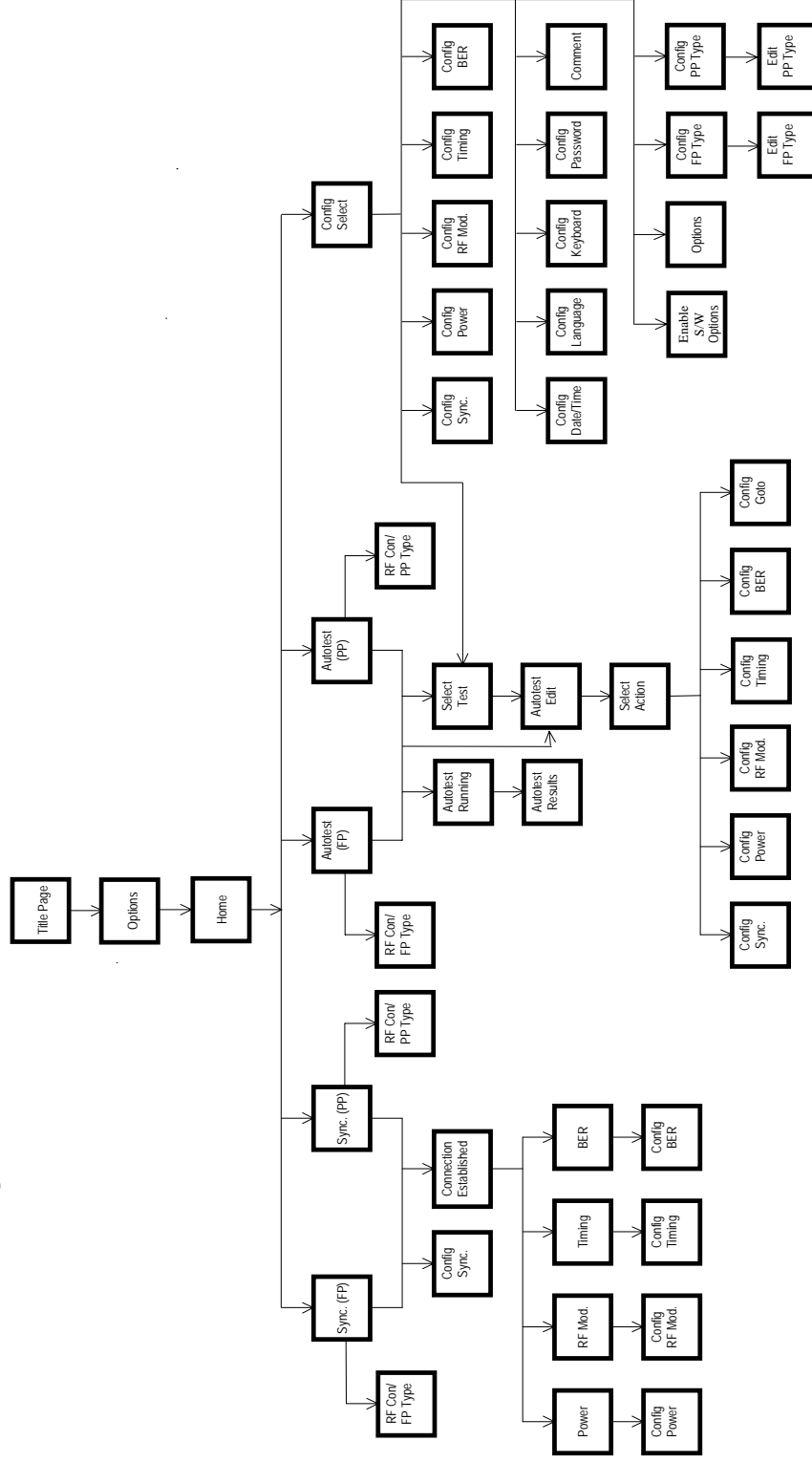

6.2 Field Editing

There are many values on the CTS60 which require configuration. Most configuration menus have several variable fields. These will use the multi-field editing approach, described below, to move between the different fields on the menu and configure their values. Some other menus that have a single field which is configurable. These normally have an edit key located next to the field which is used to edit them. In order to configure values in these fields use the single field approach described below.

6.2.1 Multi-field Editing

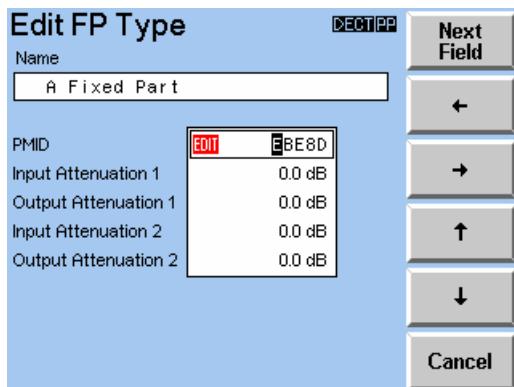

The above menu is an example of multi-field editing that is editing multiple fields on one menu. The field which is active for editing is always highlighted in red. For fields where numbers or characters are entered (for example "Name" or "Input Attenuation" above), this is shown by the red edit symbol (**EDIT**). For fields where the value is selected from a list (for example "Dummy if traffic"), this is shown by a red box around the list.

The character or digit to be changed is highlighted by a cursor. By pressing the left and the right arrows ("**<**", "**>**") the cursor is moved in the appropriate direction. The up and down arrows increase ("**↑**", "**↓**") and decrease the value highlighted by the cursor. This means that for alphabetic characters pushing the arrow keys selects the next or the previous character in alphabetical order. For numeric characters pushing the arrow keys increments or decrements the value.

Pushing the key "Next Field" selects the next field to be edited.

The changes of all the fields within one menu are stored when the menu is left by pressing the "Menu Up" hardkey.

There are two versions of this type of menu. One has a "Clear" key and the other has a "Default" key.

With "Clear" key

Pressing the "Clear" key leaves the menu without storing any changes to fields.

With "Default" key



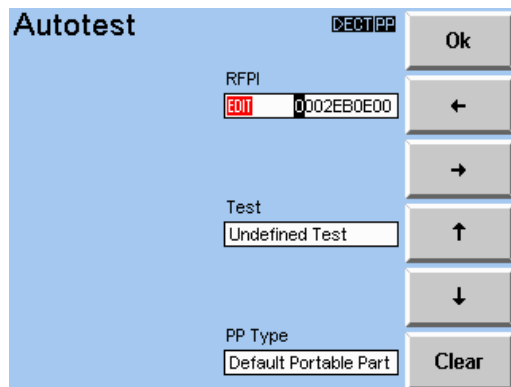

Pressing the "Default" key restores all of the fields to their default values without leaving the menu.

6.2.2 Single Field Editing



The above menu is an example of single field editing.

The field which is active for editing is shown by the edit symbol (). The field is activated for editing by pressing the key next to it (in the above example "Edit RFP"). The character or digit to be changed is highlighted by a cursor. The field is activated for editing by pressing the key to the right of it. This causes the editing buttons shown in the picture above to be displayed.

By pressing the left and the right arrows ("" , "") the cursor is moved in the appropriate direction. The up and down arrows increase ("" , "") and decrease the value highlighted by the cursor. This means that for alphabetic characters pushing the arrow keys selects the next or the previous character in alphabetical order. For numeric characters pushing the arrow keys increments or decrements the value.

Pressing the "Ok" key accepts the value entered. The field is no longer active for editing.

Pressing the "Clear" key returns the field to its original value. The field is no longer active for editing.

6.3 Home Menu

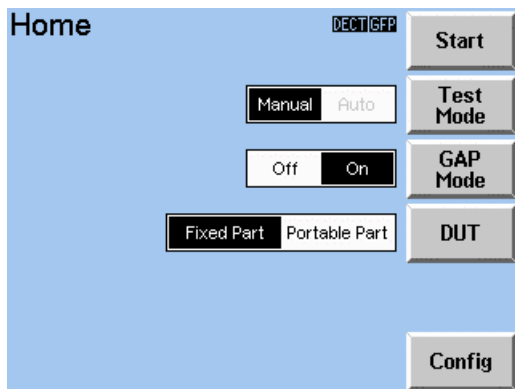

This is the Home Menu of the system. It is displayed after the system has started up and when either the Manual test, Autotest or Configuration menus are exited. From the Home Menu each part of the system can be reached (see menu structure graph).

Start

By pressing this key either Manual Test, or Autotest is activated depending on which test mode has been selected. After this key is pressed the system changes to the appropriate menu.

Test Mode

By pressing this key select either Manual Test, or Autotest test mode. The selected test is activated by pressing the Start key.

GAP Mode

If GAP Mode is "OFF" the CTS behaves as usual. If GAP Mode is "ON" Autotest will be not selectable. The DUT (Device Under Test) does not need to be in test mode in order to establish a connection.

DUT

With this key the device under test (DUT), which is either a fixed or portable part, can be selected for testing. The DUT selected here is also displayed at the top of this and every other menu as a status label.

Config

Pressing this key activates the Config Select menu.

Menu up

This key has no effect in this menu.

6.4 Selecting and Configuring Types

The CTS60 supports the definition of sets of fixed and portable part types. These can be configured with values specific to a particular DUT. The type can then be selected before performing a particular test. The configured values will then be used when performing the test.

6.4.1 Select FP or PP Types Menu

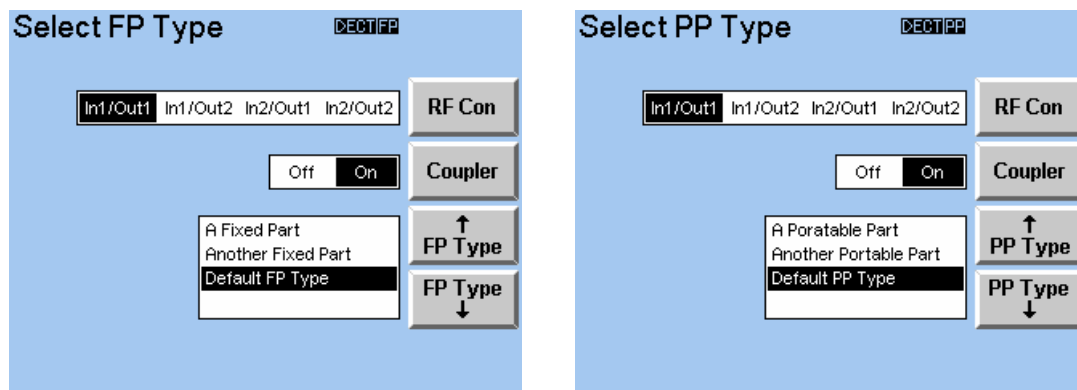

These menus allow a fixed or portable part type to be selected. They also allow selection of the combination of connectors to be used and the state of the coupler. All types in the list are displayed in alphabetical order.

RF Con

Press this key to select the combination of connectors configuration that will be used on the test. Connector 1 (input and output together) is a general purpose connector. Output connector 2 is a high gain output and input connector 2 is a more sensitive input. Connectors 2 should be used carefully as the RF level range is relatively small.

Coupler

Press this key to select the coupler state.

Coupler "on" means that a coupler, with attenuation value specified in the selected FP/PP type, is being used.

Coupler "off" means that no coupler is being used, so the attenuation values are not used.

FP/PP Type ↑, FP/PP Type ↓

Press these keys to move up and down the displayed list of configured types. The currently selected type is highlighted with a horizontal bar.

Menu up

Press this key to accept the currently highlighted selections.

6.4.2 Config FP or PP Types Menu

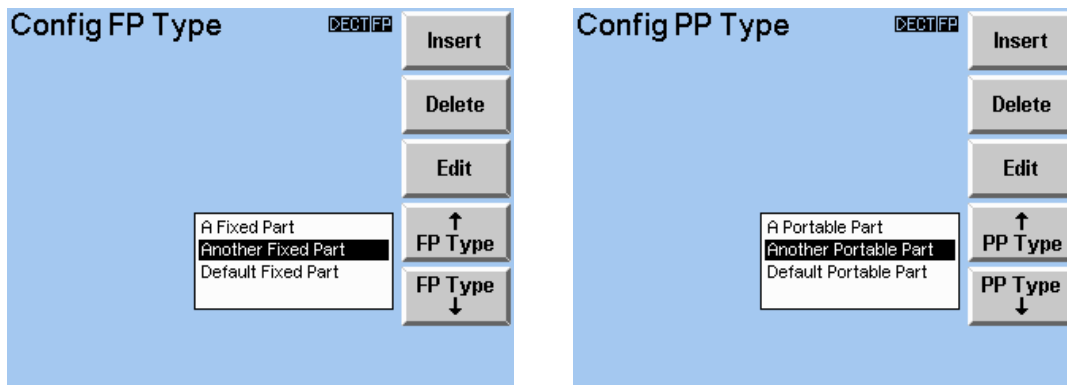

These menus allow the list of fixed or portable to be configured. It enables the insertion, deletion and editing of type definitions. All types in the list are displayed in alphabetical order. Access to this menu is only available by pressing the config key on the home menu and then selecting config FP or PP Type from the list of items available.

Insert

Press this key to insert a new fixed or portable part type in the list. This creates a new entry in the list which can then be edited.

Delete

Press this key to delete the currently highlighted fixed or portable part type from the list.

Edit

Press this key to edit the name and values of the currently highlighted type.

FP/PP Type ↑, FP/PP Type ↓

Press these keys to move up and down the displayed list of configured types. The currently selected type is highlighted with a horizontal bar.

Menu up

Press this key to return to the previous menu.

6.4.3 Edit FP Types Menu

This menu allows the configuration of the values for a selected FP type.

The first field which can be edited is the type name. This can be any alphanumeric string of up to 30 characters.

A portable part MAC identity, which will be accepted by the fixed part being tested, must be entered in the "PMID" field. Most fixed parts accept any PMID in test mode, but if necessary the PMID of a portable part corresponding to the fixed part can be obtained from the connection established menu in portable part test mode.

The packet type defines the type of packet that will be assumed for power ramp and RF modulation measurements. P32Z is a packet with 16 bits for the preamble and synchronisation fields of the burst. PP32Z is a packet with 32 bits for the preamble and synchronisation fields of the burst ie. Prolonged preamble.

Input and output attenuation values can also be entered. These specify the characteristics of the coupler used to connect the fixed part to the CTS60 and will be used when calculating power levels.

Any RF transmit level configured on the CTS60 will represent the actual level received at the fixed part after the output attenuation has been allowed for. This means that the RF level actually emitted by the CTS60 is higher than the displayed value by the magnitude of the output attenuation.

The input attenuation will be applied to power measurements to ensure that these are calculated correctly allowing for the attenuation of the coupler.

It is important to use the correct antenna coupler so that the input RF Level is inside the allowed range for the connector being used (refer to the technical information section for the allowed RF range). The attenuation/gain value of the coupler should then be configured for the FP (or PP) type being used (see *Selecting and Configuring Types*), so that the software can compensate for the attenuation and display the real value. Failure to do so may result in the CTS60 displaying incorrect values.

Cancel

Press this key to reset all values to factory default values.

Menu up

Press this key to return to the previous menu.

6.4.4 Edit PP Types Menu

This menu allows the configuration of the values for a selected PP type.

The first field which can be edited is the type name. This can be any alphanumeric string of up to 30 characters.

The "Dummy If Traffic" field specifies whether a dummy bearer should be transmitted after a connection has been established. This is required by some portable parts in order to maintain synchronisation. Configurable values for this field are "No" remove dummy bearer after connection is established, or "Yes" do not remove dummy bearer after connection is established.

The fields "Q0", "Q3", and "Q6" define values for the MAC layer Q-packets transmitted by the CTS60 when in PP test mode. Each is defined as a series of hexadecimal values which correspond to a Q-packet message, it should be noted however that not all of these are transmitted to the signalling. Further details of these messages can be found in the ETSI standard ETS 300 -175 part 3.

The packet type defines the type of packet that will be assumed for power ramp and RF modulation measurements. P32Z is a packet with 16 bits for the preamble and synchronisation fields of the burst. PP32Z is a packet with 32 bits for the preamble and synchronisation fields of the burst ie. Prolonged preamble.

Input and output attenuation values can also be entered. These specify the characteristics of the coupler used to connect the portable part to the CTS60 and will be used when calculating power levels.

Any RF transmit level configured on the CTS60 will represent the actual level received at the portable part after the output attenuation has been allowed for. This means that the RF level actually emitted by the CTS60 is higher than the displayed value by the magnitude of the output attenuation.

The input attenuation will be applied to power measurements to ensure that these are calculated correctly allowing for the attenuation of the coupler.

It is important to use the correct antenna coupler so that the input RF Level is inside the allowed range for the connector being used (refer to the technical information section for the allowed RF range). The attenuation/gain value of the coupler should then be configured for the FP (or PP) type being used (see *Selecting and Configuring Types*), so that the software can compensate for the attenuation and display the real value. Failure to do so may result in the CTS60 displaying incorrect values.

Cancel

Press this key to reset all values to factory default values.

Menu up

Press this key to return to the previous menu.

6.5 Autotest Menus

6.5.1 Autotest Start Menu (Fixed Part Tests)

The screenshot shows the 'Autotest' menu interface. At the top left, the title 'Autotest' is displayed next to a 'DECT FP' indicator. Below this, there are several input fields and a set of buttons. The 'RFPI' field contains the value '0000000000'. Below it is a radio button group for 'Accept RFPI', with 'No' selected. The 'Test' field contains '01: Free'. At the bottom, the 'FP Type' field contains 'Default FP Type'. On the right side, there is a vertical column of six buttons: 'Start', 'Edit RFPI', 'Accept RFPI', 'Select Test', 'Edit Test', and 'RF Con/FP Type'.

This menu is displayed after the Autotest test mode has been activated from the home menu and the DUT selected is "Fixed Part".

Start

Pressing this key starts the autotest.

Edit RFPI

Pressing this key enables the entered RFPI to be edited. If "Accept RFPI" is set to No (see below) the CTS60 will only synchronise to a Fixed Part with this RFPI.

Accept RFPI

Pressing this key controls the type of synchronisation used during an autotest. If Accept RFPI is set to No the CTS60 will only synchronise to a fixed part with an RFPI the same as the value entered using "Edit RFPI". If Accept RFPI is set to Yes the CTS60 does not use the entered RFPI value to synchronise. Instead the CTS60 will synchronise with whatever fixed part it detects is currently transmitting.

Select Test

Pressing this key allows one of 10 different automatic FP tests to be selected and edited.

Edit Test

Pressing this key allows the selected test to be configured.

RF Con/FP Type

Pressing this key allows the combination of connectors, the coupler state, and the type of Fixed Part being tested to be selected.

Menu up

Press this key to return to the previous menu.

6.5.2 Autotest Start Menu (Portable Part Tests)

The screenshot shows a menu titled "Autotest" with a "DECT PP" indicator. It contains four input fields and four corresponding buttons:

- RFPI:** Input field containing "0000000000", with a button labeled "Edit RFPI".
- Test:** Input field containing "01: Free", with a button labeled "Select Test".
- PP Type:** Input field containing "Default PP Type", with a button labeled "RF Con/PP Type".
- A button labeled "Start" is located at the top right of the menu.

This menu is displayed after the Autotest test mode has been activated from the home menu and the DUT selected is "Portable Part".

Start

Pressing this key starts the autotest.

Edit RFPI

Pressing this key enables the entered RFPI to be edited. This is the RFPI that will be used when transmitting a dummy bearer to the portable part being tested.

Select Test

Pressing this key allows one of 10 different automatic PP tests to be selected and edited.

Edit Test

Pressing this key allows the selected test to be configured.

RF Con/PP Type

Pressing this key allows the connectors' configuration, the coupler state, and the type of Portable Part being tested to be selected.

Menu up

Press this key to return to the previous menu.

6.5.3 Autotest Select Test Menu

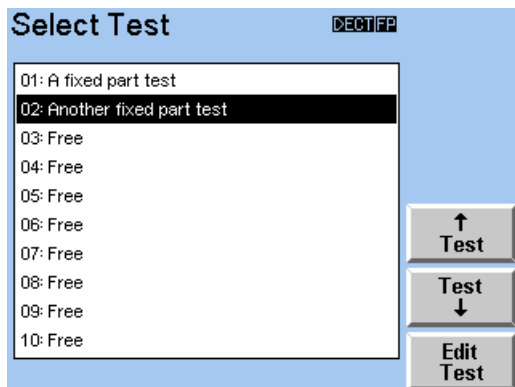

This menu is used to select one of the 10 fixed part or 10 portable part tests which can be configured. The set of tests which can be configured depends on the currently selected DUT.

Test ↑, Test ↓

These keys move up and down the list of configurable tests. The currently selected test is highlighted with a horizontal bar.

Edit Test

Pressing this key allows the selected test to be configured.

Menu up

Pressing this hardkey stores the test currently selected on this menu and returns to the previous menu.

6.5.4 Autotest Edit Test Menu

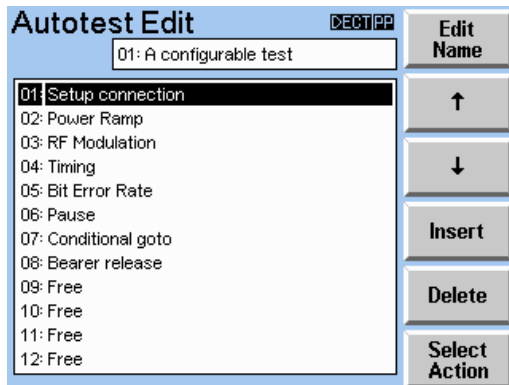

This menu is used to configure a selected test. Each test can contain up to 50 test steps each of which can be configured with a variety of different actions.

Edit Name

Pressing this key allows a test name to be entered. This can be any string up to 26 characters (the test number is not editable).



These keys move up and down the list of test steps. The currently selected test step is highlighted with a horizontal bar. The list of test steps scrolls when moving to a test step which is not currently visible.

Insert

This key is used to insert a new test step at the currently highlighted position. This test step will be created as "Free". All test steps at and below this position will be moved down one step.

Delete

This key is used to delete the test step at the currently highlighted position. All test steps below this test step will be moved up one step.

Select Action

Pressing this key allows an action to be selected for the current test step.

Menu up

Press this key to return to the previous menu.

6.5.5 Autotest Select Action Menu

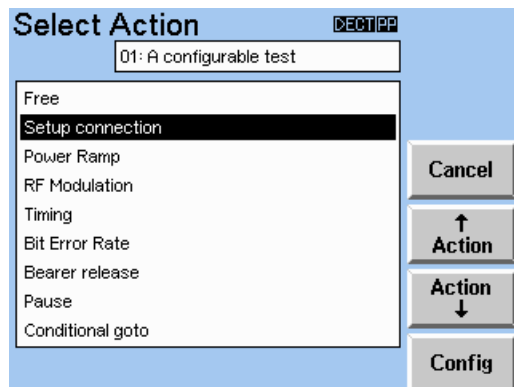

This menu is used to select an action for the currently selected test step. The available actions are:

- Free - no action defined (default value for new test steps).
- Setup connection - set up a connection with a fixed or portable part (depends on the DUT selected).
- Power Ramp - perform a power ramp measurement.
- RF Modulation - perform an RF modulation measurement.
- Timing - perform a timing measurement.
- Bit Error Rate - perform a BER measurement.
- Bearer Release - release the connection.
- Pause - pause for a fixed length of time or until the "Cont" key is pressed (see autotest running menu)
- Conditional goto - specify a conditional goto (see Config Goto menu).

Cancel

Pressing this key cancels any changes made and returns to the Autotest Edit menu.

Action ↑, Action ↓

These keys move up and down the list of selectable actions. The currently selected action is highlighted with a horizontal bar.

Config

Pressing this key allows the action to be configured. Each action for every test step can be configured with its own settings. This means that a test can contain many different tests steps, with the same action, each configured differently. For instance several power ramp tests could be configured each with a different template, or several BER measurements each with a different RF level. This key is only displayed when the action is configurable. It will not be displayed for the free, bearer release or pause actions.

Menu up

Pressing this key stores the highlighted action in the currently selected test step and returns to the previous menu.

6.5.6 Autotest Running Menu

Autotest		
05: A portable part test		
Abort		
Action/Parameter	Value	Result
NTP	3.9 dBm	Pass
Template	Matching	Pass
(03) RF Modulation:		
Freq. Offset	-8 kHz	Pass
Max. Pos. B-Field	349 kHz	Pass
Max. Neg. B-Field	-351 kHz	Pass
Freq. Drift	-6 kHz/ms	Pass
(04) Pause		
PAUSE: Press CONT key to continue.		
Cont		

In this menu the Autotest is running. This screen indicates the results of each step of the Autotest. In the Action/Parameter column the menu displays the test step number, and the action currently being performed, and a list of the measured parameters for each action. Measurement values are displayed in the value column and the result column displays pass/fail results for each measurement depending on whether it is in tolerance.

Abort

Pressing this key will abort the current test and go to the autotest results menu.

Cont

This key is displayed only when it is required by a particular test step. Pressing this key will immediately execute the next test step.

Menu up

This key performs no operation in this menu.

6.5.7 Autotest Results Menu

Autotest			Start Menu
02: Another configured test			↑ Page
Action/Parameter	Value	Result	↓ Page
(01) Setup Connection:			↑ Line
Detected RFPI	0002EB0E00		↓ Line
Dummy Slot	0		
Dummy Carrier	0		
(02) Power Ramp:			
NTP	22 dBm	Pass	
Template	Matching	Pass	
(03) RF Modulation:			
Freq. Offset	-13 kHz	Pass	
Test Passed			Print Report

When the measurement sequence has finished or has been aborted the Autotest Results menu is displayed (as shown above). From this menu it is possible to return to the Autotest Start menu, scroll up and down through the test results or to print a test report. A message at the bottom of the screen displays the overall result of the test. This will be either "Test Passed" if all of the tests have been successful, "Test Failed" if one of the tests has not been successful, or "Test Aborted" if the test was aborted before it had finished.

Start Menu

Press this key to return to the Autotest Start menu.

Page ↑, Page ↓

Scroll up and down through the test results a page at a time.

Line ↑, Line ↓

Scroll up and down through the test results a line at a time.

Print Report

Pressing this key sends a full test report to an attached printer.

Menu up

Press this key to return to the previous menu.

6.6 Manual Test Menus

6.6.1 Synchronisation Menu (GAP Mode Fixed Part Tests)

Synchronisation		DECT/GFP	Connect
Dummy Slot:	2	PARK	Edit PARK
Dummy Carrier:	5	00104EAD28	
Traffic Slot:	0	Detected PARK	Accept PARK
Traffic Carrier:	0	00104EAD28	
Carrier No. Offset:	0	IPUI	Subscribe
RF Level: - 73.0 dBm		0000000000	
		FP Type	RF Con/ FP Type
		Default FP Type	
Press "Connect" to connect to FP			Config

This menu appears when the Manual Test is activated for testing a fixed part and GAP Mode is "ON". The CTS60 tries to synchronise with a fixed part with the following characteristics:

1. the fixed part currently transmits a dummy bearer with the same PARK (Private Access Rights Key) as that specified in the field labelled "PARK".
2. a portable part with the IPUI (International Portable User Identifier) as displayed in the field "IPUI" is subscribed to the fixed part. (**Note:** The CTS can be used to accomplish the subscription process, if required. This will be described more fully in later sections.)

A yellow flashing box containing the text "Synchronising" will be displayed when the CTS60 is not synchronised to a fixed part. A message is also displayed at the bottom of the screen "Wait for FP Synchronisation". As soon as the CTS60 is synchronised the yellow flashing box will be removed and the message at the bottom of the screen will say "Press 'Connect' to connect to FP".

The box labelled "Detected PARK" on the right hand side of the screen will be updated with the PARK of the Fixed Part currently transmitting the strongest signal. Above the detected PARK box on the right-hand side of the screen is the configured PARK. This is the PARK that the CTS60 will attempt to synchronise and connect to. Below the IPUI field on the right-hand side of the screen is the selected fixed part type. This will define various configured settings specific to the fixed part being tested.

On the top left side of the menu important Manual Test settings are indicated, these are:

- the slot and carrier of the dummy bearer we are currently synchronised to.
- the slot and carrier the CTS60 is configured to establish a traffic bearer on.
- the carrier offset being used to modify all dummy and traffic carrier numbers.
- the CTS60 transmit level in dBm.

Connect

By pressing this key the CTS60 will attempt to set up a connection with the fixed part with a PARK the same as the configured PARK.

Different to non-GAP mode: the fixed part doesn't need to be in test mode.

Note that the slots for the traffic and dummy bearers must be different in order to establish a connection (see the Config Synchronisation Menu section for more details). Because most fixed parts vary the dummy slot and carrier, check that the configurable traffic slot and carrier are different to the detected dummy slot and carrier settings.

Connecting over an incoming call

Two portable parts PP1 and PP2 are subscribed to the fixed part under test. If the configured IPUI of the CTS is the same as the IPUI of PP1 and the current PARK of the CTS is the PARK of the fixed part under test, then a call from PP2 to PP1 will set up a connection from the fixed part to the CTS.

Edit PARK (Private Access Rights Key)

By pressing this key the configured PARK value can be edited.

Accept PARK

Pressing this key copies the value of the detected PARK to the configured PARK.

Subscribe

Pressing this softkey displays a further menu where subscription of the fixed part can be initiated if required.

RF Con/FP Type

Pressing this key allows the combination of connectors, the coupler state, and the type of Fixed Part being tested to be selected.

Config

Pressing this key allows the values used by the synchronisation menu to be configured.

Menu up

Press this key to return to the previous menu.

6.6.1.1 Subscription of the Fixed Part

After pressing the “Subscribe” softkey as described in section 6.6.1, the following menu will be displayed.

Synchronisation		DECT GPP	Start Subscr
Dummy Slot:	4	PARK	00104EAD28
Dummy Carrier:	8	Detected PARK	
Traffic Slot:	0	IPUI	0000000000
Traffic Carrier:	0	Access Code FP	0000FFFF
Carrier No. Offset:	0		
RF Level:	- 73.0 dBm		
<div style="border: 1px solid green; padding: 2px; color: green; font-weight: bold;"> Wait for FP Synchronisation, then press "Start Subscr" to subscribe FP </div>			
			Return

The following softkeys are present.

Start Subscr

Press this softkey to start the subscription process. The DUT, in this case the fixed part, must already be in subscribing mode and ready to be subscribed.

Edit IPUI (International Portable User Identifier)

By pressing this key the configured IPUI value can be edited. This is the identity that the CTS will assume in its simulation of the portable part during the subscription process, should it be attempted. However, if the fixed part DUT is already subscribed to a known portable part, then the IPUI of that portable part can be simply entered into the field without having to initiate the subscription process. Some fixed part DUT's will only accept subscription from certain portable parts. Consult the relevant documentation for clarification of this point.

Edit AC

By pressing this key, the configured Access Code can be edited. This Access Code corresponds directly to a user PIN entered on the DUT, which is typically only four digits in length. The Access Code field has provision for a PIN length of eight digits. In the event that the PIN is only four digits, then the remaining four characters of the Access Code field must be left at their default value of FFFF. The Access Code entered here must be acceptable as a PIN by the fixed part DUT.

Return

This will return to the Synchronisation Menu (GAP Mode Fixed Part Tests) menu described in section 6.6.1 where a connection with the fixed part can be attempted if required.

6.6.1.2 Subscribing the Fixed Part

After the subscription process has been initiated, then the following menu will be displayed. It is at this point where the fixed part DUT must already have been configured to accept subscription and must be waiting for this event to occur.

If this procedure is not followed exactly, then the results will be unpredictable and the subscription process is unlikely to succeed.

Synchronisation DECT GPP Abort Subscr

Dummy Slot: 6
 Dummy Carrier: 4
 Traffic Slot: 0
 Traffic Carrier: 0
 Carrier No. Offset: 0
 RF Level: -73.0 dBm

PARK
 00104EAD28
 Detected PARK
 00104EAD28
 IPUI
 0000000000
 Access Code FP
 0000FFFF

Subscribing

Wait for FP Subscription or press "Abort Subscr" to abort

If subscription is successful, then the menu will automatically change to the menu described in the previous section 6.6.1.1 and the fixed part will indicate that the subscription process has completed as documented.

Subscription can fail for a number of reasons of which some of the more likely explanations are now listed.

- The dummy slot and carrier, collectively referred to as the dummy bearer, which are transmitted by the fixed part DUT, may clash with the requested user configured traffic slot and carrier. This is likely to occur after a connection has previously been established with the same fixed part DUT. The fixed part DUT can sometimes transmit its dummy bearer using the same slot and carrier as what was previously used for the traffic bearer during its last connection. If this problem occurs, then the user configurable traffic slot and carrier must be set to alternative non conflicting values.
- The RF output level of the CTS may be set too low to be correctly interpreted by the fixed part DUT.
- The user defined IPUI may not be acceptable for use by the fixed part DUT. Consult the relevant documentation to ascertain the validity of the IPUI being used.
- The Access Code may not be appropriate for the fixed part DUT. Consult the relevant documentation to ascertain what Access Codes may be used with the fixed part DUT.

Subscription can be aborted at any time from this menu by pressing the "Abort Subscr" softkey.

6.6.2 Synchronisation Menu (GAP Mode Portable Part Tests)

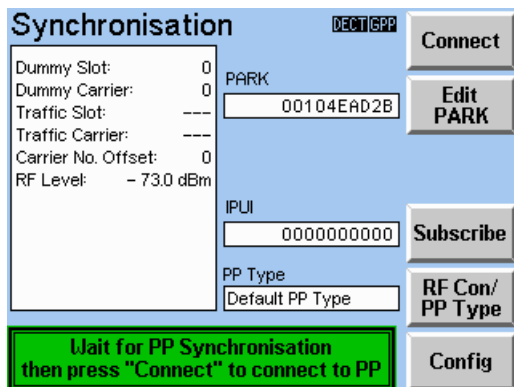

This menu appears when the Manual Test is activated for testing a portable part and GAP Mode is "ON".

On the top right-hand side of the screen is the configured PARK (Private Access Rights Key). This is the PARK that the CTS60 will transmit. In order for the portable part to synchronise to the CTS60, it needs to be subscribed to a fixed part with this PARK.

Note: The CTS can, if required, be used to accomplish the subscription of the portable part and this will be described later in the chapter.

On the lower centre right-hand side of the screen is the configured IPUI (International Portable User Identifier) of the portable part to be tested.

On the bottom right-hand side of the screen is the selected portable part. This will define various configured settings specific to the portable part being tested.

On the top left side of the menu important Manual Test settings are indicated, these are:

- the slot and carrier of the dummy bearer we are currently transmitting.
- the carrier offset being used to modify all dummy and traffic carrier numbers.
- the CTS60 transmit level in dBm.

Connect

By pressing this key the CTS60 will make a call to the portable part. If you take the portable part off hook the CTS60 will attempt to set up a connection.

Note: 1. You can setup a connection only by taking the portable part off hook.
2. Different to non GAP Mode: the portable part doesn't need to be in test mode.

Edit PARK (Private Access Rights Key)

By pressing this key the configured PARK value can be edited.

Subscribe

Pressing this softkey displays a further menu where subscription of the portable part can be initiated if required.

RF Con/PP Type

Pressing this key allows the combination of connectors, the coupler state, and the type of Portable Part being tested to be selected.

Config

Pressing this key allows the values used by the synchronisation menu to be configured.

Menu up

Press this key to return to the previous menu.

6.6.2.1 Subscription of the Portable Part

After pressing the "Subscribe" softkey as described in section 6.6.2, the following menu will be displayed.

Synchronisation DECT GPP

Dummy Slot: 0
 Dummy Carrier: 0
 Traffic Slot: --- 00104EAD2B
 Traffic Carrier: --- PARK
 Carrier No. Offset: 0
 RF Level: - 73.0 dBm

IPUI
 0000000000

Access Code PP
 0000FFFF

Start Subscr
 Edit IPU
 Edit AC
 Return

Wait for PP Synchronisation, then press "Start Subscr" to subscribe PP

The following softkeys are present.

Start Subscr

Press this softkey to start the subscription process. The DUT, in this case the portable part, must already be in subscribing mode and ready to be subscribed.

Edit IPU (International Portable User Identifier)

By pressing this key the configured IPU value can be edited. Editing this field is typically only required if the IPU of the portable part DUT is known and is already subscribed to the fixed part which is to be simulated by the CTS. If subscription is to be attempted, then the field should be left unmodified but will be automatically updated at a later stage, in the event that the subscription process completes successfully.

Edit AC

By pressing this key, the configured Access Code can be edited. This Access Code corresponds directly to a user PIN, which is required for entry during the subscription process of the portable part DUT. This PIN, will typically only four digits in length. The Access Code field however has provision for a PIN length of eight digits. In the event that the PIN is only four digits, then the remaining four characters of the Access Code field must be left at their default value of FFFF.

The portable part DUT may not accept all combinations of PIN and this point should be clarified in the appropriate documentation, if there is any doubt.

Return

This will return to the Synchronisation Menu (GAP Mode Portable Part Tests) menu described in section 6.6.2 where a connection with the portable part can be attempted if required.

6.6.2.2 Subscribing the Portable Part

After the subscription process has been initiated, then the following menu will be displayed. It is at this point where the portable part DUT must already have been configured to accept subscription and must be waiting for this event to occur.

If this procedure is not followed exactly, then the results will be unpredictable and the subscription process is unlikely to succeed.

If subscription is successful, then the menu will automatically change to the menu described in the previous section 6.6.2.1 and the portable part will indicate that the process has completed as documented. The IPUI field in that same menu will be updated with the identity of the newly subscribed portable part DUT.

Subscription can fail for a number of reasons of which some of the more likely explanations are now listed.

- The RF output level of the CTS may be set too low to be interpreted correctly by the portable part DUT.
- The user defined PARK may not be acceptable for use by the portable part DUT. Consult the relevant documentation to ascertain the validity of the PARK being used with the portable part DUT.
- The PIN entered on the portable part DUT may not match the configurable Access Code described in the previous menu.
- The PIN entered on the portable part DUT, may not be appropriate for the portable part DUT. Consult the relevant documentation to ascertain what PINs may be used with the portable part DUT.

Subscription can be aborted at any time from this menu by pressing the “Abort Subscr” softkey.

6.6.3 Connection Established Menu (Fixed Part Tests)

Measurement/Parameter	Value
NTP	- 9.9 dBm
Power Ramp	okay
Freq. Offset	+ 5 kHz
Max. Pos. B-field Mod.	+ 354 kHz
Max. Neg. B-field Mod.	- 320 kHz
Traffic Slot	4
Traffic Carrier	0
RF Level	-100.0 dBm
No. of Bursts	4

The Connection Established menu appears after a connection on the Traffic Channel is established between the CTS60 and the fixed part. This menu is the central menu for the CTS60 in Manual Test mode.

While maintaining the connection with the fixed part the CTS60 carries out several measurements on the transmitted signal and displays the results in this menu. The following results are displayed on the left-hand side of the menu:

- NTP (Normal Transmit Power)
- Power Ramp pass/fail
- Frequency Offset (only valid for loopback test mode)
- Maximum positive B field modulation
- Maximum negative B field modulation

Results exceeding the configured tolerances are shown in red.

More detailed measurements can also be started from this menu. Power ramp, RF modulation and timing measurements can be selected which test the fixed part's transmitter. Tolerance values configured for any of these measurements will also be applied to the measurement values displayed in this menu. To test the fixed part's receiver, bit error rate (BER) measurements can be selected.

On the right-hand side of the menu are displayed the slot and carrier values for the current traffic connection with the fixed part, the transmit level of the CTS60, and the number of bursts over which the displayed measurement results are being taken. The number of bursts value can be configured from this menu.

At any time the connection can be cleared by a bearer release initiated by the CTS60 or as a result of a loss of the traffic connection with the fixed part (usually due to poor signal quality or removal of power from the fixed part). In both cases the CTS60 will return to the synchronisation menu, from where a new connection can be established.

Bearer Release

By pressing this key the connection will be released by the CTS60.

Power

This key allows the power ramp measurement to be selected.

CTS60**Description of the Menus**

RF Mod

This key allows the RF modulation measurement to be selected.

Timing

This key allows the timing measurement to be selected.

BER

This key allows the bit error rate measurement to be selected.

Number of Bursts

Pressing this key allows the number of bursts measurements are taken over to be configured.

Menu up

Press this key to return to the previous menu.

6.6.4 Connection Established Menu (Portable Part Tests)

Connection Estab.		DECTPP		Bearer Release	
NTP	- 9.6 dBm	Traffic Slot	4	Power	
Power Ramp	okay	Traffic Carrier	0	RF Mod	
Freq. Offset	+ 4 kHz	RF Level	-100.0 dBm	Timing	
Max. Pos. B-field Mod.	+ 336 kHz	PMID	EBE8D	BER	
Max. Neg. B-field Mod.	- 315 kHz	No. of Bursts	4	Number of Bursts	

The Connection Established menu appears after a connection on the Traffic Channel is established between the CTS60 and the portable part. This menu is the central menu for the CTS60 in Manual Test mode.

While maintaining the connection with the portable part the CTS60 carries out several measurements on the transmitted signal and displays the results in this menu. The following results are displayed on the left-hand side of the menu:

- NTP (Normal Transmit Power)
- Power Ramp pass/fail
- Frequency Offset (only valid for loopback test mode)
- Maximum positive B field modulation
- Maximum negative B field modulation

Results exceeding the configured tolerances are shown in red.

More detailed measurements can also be started from this menu. Power ramp, RF modulation and timing measurements can be selected which test the fixed part's transmitter. Tolerance values configured for any of these measurements will also be applied to the measurement values displayed in this menu. To test the fixed part's receiver, bit error rate (BER) measurements can be selected.

On the right-hand side of the menu are displayed the slot and carrier values for the current traffic connection with the fixed part, the transmit level of the CTS60, the PMID of the portable part being tested, and the number of bursts over which the displayed measurement results are being taken. The number of bursts value can be configured from this menu.

At any time the connection can be cleared by a bearer release initiated by the CTS60 or as a result of a loss of the traffic connection with the fixed part (usually due to poor signal quality or removal of power from the fixed part). In both cases the CTS60 will return to the synchronisation menu, from where a new connection can be established.

Bearer Release

By pressing this key the connection will be released by the CTS60.

Power

This key allows the power ramp measurement to be selected.

CTS60**Description of the Menus**

RF Mod

This key allows the RF modulation measurement to be selected.

Timing

This key allows the timing measurement to be selected.

BER

This key allows the bit error rate measurement to be selected.

Number of Bursts

Pressing this key allows the number of bursts measurements are taken over to be configured.

Menu up

Press this key to return to the previous menu.

6.6.5 Power Ramp Menu

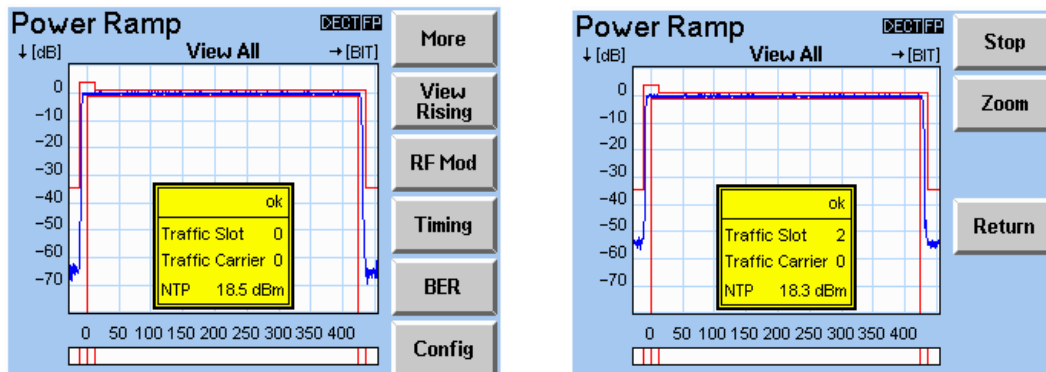

In this screen the Power Ramp of the signal transmitted by the DUT is displayed as a function of time. The tolerance template for the power ramp is also displayed. This must not be exceeded by the ramp. The template and the calculated NTP takes into account the configured packet type (P32Z or PP32Z) for this FP or PP type.

A yellow box is displayed in the centre of the power ramp graph which gives other information about the measurement. This is displayed in all of the power ramp views.

The first field of the yellow box displayed within any diagram shows the overall result of the power ramp. If the measured ramp exceeds the template at only one sample the burst has "failed". It has also failed if the average power is not within the configured tolerance limits. Below this is displayed the slot and carrier of the current traffic bearer and the measured value of normal transmit power (NTP). If the NTP exceeds the configured tolerance values it is shown in red.

The bar below the power ramp graph indicates where the ramp exceeds or stays below the template. For any area of the ramp where the template limits are exceeded, the corresponding section of the bar is highlighted in red.

More

Pressing this key selects a further menu where the measurement can be started and stopped. Furthermore you can switch to full screen mode for the ramp for a better assessment of the power curve.

View Rising/Useful/Falling/All

By pressing this key different views of the ramp display can be selected. The views available are the rising edge, the useful part (middle section), the falling edge, and all of the burst. The text on the key indicates the next view of the ramp which will be displayed when the key is pressed.

RF Mod

This key allows the RF modulation measurement to be selected.

Timing

This key allows the timing measurement to be selected.

BER

This key allows the bit error rate measurement to be selected.

Config

Press this key to access the configuration menu for the power ramp.

Stop/Cont

Press this key to stop or continue the power ramp measurement. The text on the key will be "Stop" or "Cont" depending on whether or not the measurement is currently stopped.

Zoom

Press this key to switch to full screen mode. The section of the ramp currently being displayed will be enlarged to fill the whole screen. Note that "Menu up" is the only way to return to the normal display.

Return

Press this key to return to the main power ramp menu.

Menu up

Press this key to return to the previous menu.

6.6.6 RF Modulation Menu

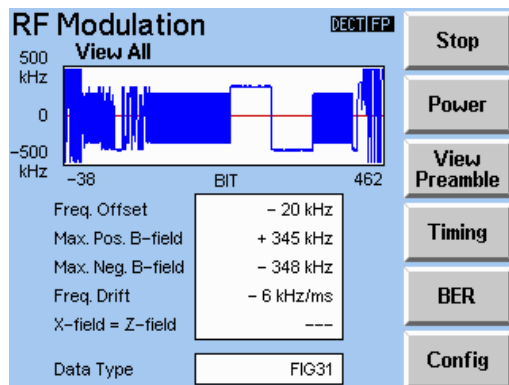

In this menu, the modulated signal received by the CTS60 from the DUT is displayed as a function of time. In addition to this the measured values of frequency offset, maximum positive and negative B-field modulation, frequency drift, and an X=Z field comparison are displayed. If any of these measurements exceed their configured tolerance values then they are displayed in red. The measurement results displayed are the following:

- Frequency offset is obtained by comparing the average of the demodulated signal over the B-field for the configured number of bursts with the expected carrier frequency. This measurement is only valid in loopback mode.
- Maximum positive and negative B-field modulation measurements are the peak values of modulation deviation measured over the B-field. These are given as deviations from the frequency offset measurement.
- Frequency drift is the frequency variation across one burst. The frequency drift can only be measured by means of data patterns ending with "zero-one sequences" namely "FIG31" and "01010101". This measurement is only valid in loopback mode.
- The X-field = Z-field compares the values of these two CRCs. If these are not the same for any burst of the configured number of bursts then the measurement result is "FAIL". Otherwise the measurement result is "PASS". This measurement is only valid when the data pattern selected is "PSRBS".

In loopback mode the data type which is currently being transmitted in the B-field to the DUT is displayed at the bottom of the menu. This data is transmitted back (looped back) to the CTS60 by the DUT and displayed on the modulation graph. Frequency offset and frequency drift measurements will only be displayed in this mode since they require looped back data. In echo and normal modes these two measurements will be displayed as invalid and the data type will not be displayed.

Stop/Cont

With this key the measurement can be stopped and started again.

Power

This key allows the power ramp measurement to be selected.

View preamble/A-field/B-field/all

By pressing this key it is possible to toggle the between different views of the RF modulation graph. The areas displayed are the preamble, the A-field, the B-field, and all of the graph. The text on the key indicates the next view of the modulation graph which will be displayed when the key is pressed.

Timing

This key allows the timing measurement to be selected.

BER

This key allows the bit error rate measurement to be selected.

Config

Press this key to access the configuration menu for the RF modulation measurement.

Menu up

Press this key to return to the previous menu.

6.6.7 Timing Menu (Fixed Part)

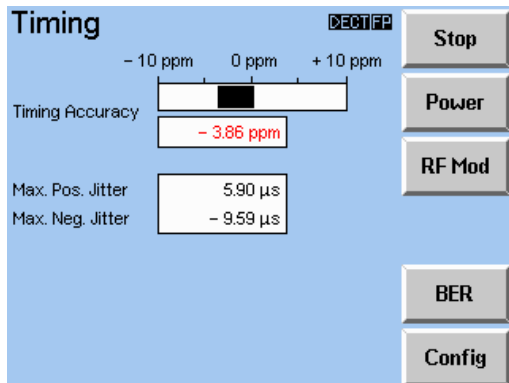

This menu displays timing measurements made on the fixed part. If any of these measurements exceed their tolerance values then they are displayed in red. The following measurement results are displayed:

- Timing accuracy, is the accuracy of the time period of the configured number of bursts with respect to the timer on the CTS60. This measurement is displayed with both a value and an indicator bar.
- Maximum positive jitter is the maximum positive time interval between two successive bursts minus the average time period.
- Maximum negative jitter is the maximum negative time interval between two successive bursts minus the average time period.

Stop/Cont

With this key the measurement can be stopped and started again.

Power

This key allows the power ramp measurement to be selected.

RF Mod

This key allows the RF modulation measurement to be selected.

BER

This key allows the bit error rate measurement to be selected.

Config

Press this key to access the configuration menu for the timing measurement.

Menu up

Press this key to return to the previous menu.

6.6.8 Timing Menu (Portable Part)

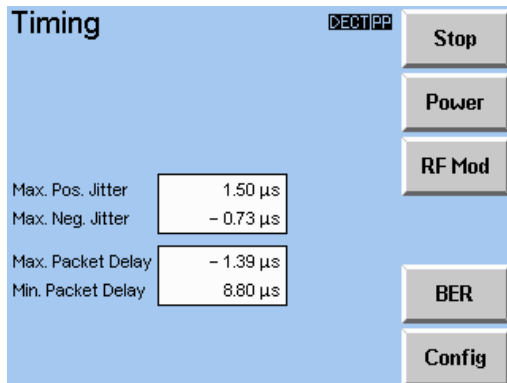

This menu displays timing measurements made on the portable part. If any of these measurements exceed their tolerance values then they are displayed in red. The following measurement results are displayed:

- Maximum positive jitter is the maximum positive time interval between two successive bursts minus the average time period.
- Maximum negative jitter is the maximum negative time interval between two successive bursts minus the average time period.
- Maximum packet delay is the maximum time interval between the CTS60 bursts (transmitting as a fixed part) and bursts from the portable part under test minus 5ms (half a frame).
- Minimum packet delay is the minimum time interval between the CTS60 bursts (transmitting as a fixed part) and bursts from the portable part under test minus 5ms (half a frame).

Stop/Cont

With this key the measurement can be stopped and started again.

Power

This key allows the power ramp measurement to be selected.

RF Mod

This key allows the RF modulation measurement to be selected.

BER

This key allows the bit error rate measurement to be selected.

Config

Press this key to access the configuration menu for the timing measurement.

Menu up

Press this key to return to the previous menu.

6.6.9 Bit Error Rate Menu

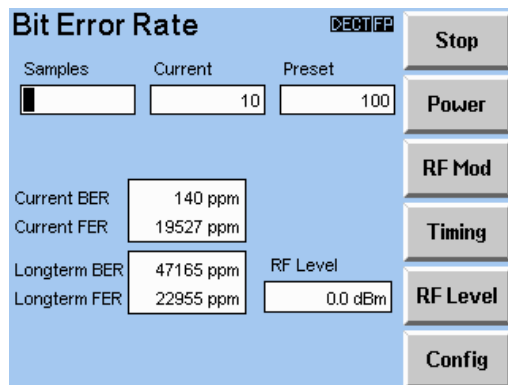

In this menu the results of bit error rate measurements are displayed. In contrast to other tests the bit error rate test is used to measure the receiver of the DUT. A pseudo random number sequence is sent as a data pattern (CCITT 0.153 sequence with period $2^{11}-1$ according to CTR06). The received bits are compared with the transmitted bits. The number of bits detected to be faulty compared to the total number of received bits results in the bit error rate (BER). However, if at least 25% of all bits of a frame are detected to be faulty then this is considered to be a frame error. The faulty bits are not counted in the BER but in the frame error rate (FER) which is the ratio of faulty frames to received frames.

At the top of the menu the current sample box displays the number of the current sample being measured. To the left of this a bar displays the current sample being measured. To the right the "preset" field displays the total number of samples to be used when calculating each longterm value. This value can be configured in the BER configuration menu.

Below these on the left-hand side of the menu "Current BER" and "Current FER" display the current values for these measurements. "Longterm BER" and "Longterm FER" are calculated from current values averaged over the preset number of samples. Out of tolerance values are displayed in red.

At the bottom right-hand side of the menu the "RF level" field indicates the configured transmit level of the CTS60 for this measurement. This configured value is specific to BER measurements and is different to the RF level on the connection established menu.

Stop/Cont

With this key the measurement can be stopped and started again.

Power

This key allows the power ramp measurement to be selected.

RF Mod

This key allows the RF modulation measurement to be selected.

Timing

This key allows the timing measurement to be selected.

RF Level

By pressing this the CTS60 transmit level for BER measurements can be configured. The RF level value will be sent to the hardware as it is changed. This enables the effects on the BER and FER measurements to be monitored in real-time.

Config

Press this key to access the configuration menu for the timing measurement.

Menu up

Press this key to return to the previous menu.

6.7 Auto and Manual Test Configuration Menus

6.7.1 Config Synchronisation Menu (Fixed Part)

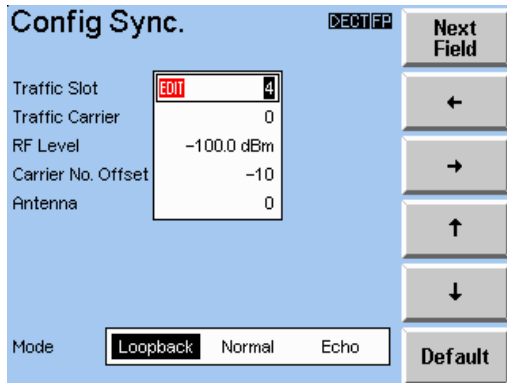

This menu is used to define the configuration for the synchronisation menu when testing fixed parts.

The traffic slot and carrier values define the slot and carrier number of the traffic bearer used on call set up. Permissible values of traffic slot are 0 to 11. Permissible values of traffic carrier are 0 to 9. The slot values for the traffic and dummy bearers must not be identical if a connection set up is to succeed. Selecting adjacent slot values (e.g. 5 and 6 or 11 and 0) will only result in a successful traffic connection if the channel numbers of the traffic and dummy bearer are the same.

The RF level value is the transmit power of the CTS60. It can be configured to any value from -100dBm to -40dBm if connector IN1/OUT1 is used, or -40dBm to 0dBm if connectors IN1 and OUT2 are used, or -20dBm to 0dBm if connectors IN2 and OUT2 are used. The RF level value can set be in steps of 0.1dBm. The actual output level will be adjusted by the output attenuation level configured for the selected fixed part (see FP type configuration menu) when the coupler selection is "on".

The carrier number offset value defines the offset value applied to all carrier numbers configured. It can take any integer value from 3 to -22. This enables extended channels to be used allowing out of band testing of fixed parts.

The antenna value defines the antenna number the CTS60 will be requested to use when setting up a connection. Antenna number is defined as a value from 0 to 7.

The mode value defines the mode of the connection which will be set up:

- Loopback: the fixed part will be set into loopback mode in order to return data, transmitted by the CTS60, without modification. This is a prerequisite for bit error rate and some modulation measurements.
- Normal: in this mode no loopback of the data is performed.
- Echo: audio signals sent to the CTS60 by the fixed part are delayed by one second and sent back to the fixed part.

Default

Press this key to reset all values to factory default values.

Menu up

Press this key to return to the previous menu.

6.7.2 Config Synchronisation Menu (GAP Mode Portable Part)

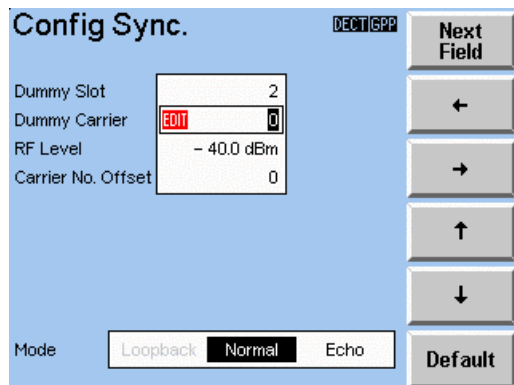

Note: in GAP mode only the connection Modes "Normal" and "Echo" available. This applies to both test modes fixed part and portable part test.

This menu is used to define the configuration for the synchronisation menu when testing portable parts.

The dummy slot and carrier values define the slot and carrier number of the dummy transmitted while in the synchronisation menu. The traffic slot and carrier values define the slot and carrier number of the traffic bearer used for call set up. Permissible values of traffic slot are 0 to 11. Permissible values of traffic carrier are 0 to 9. The slot values for the traffic and dummy bearers must not be identical. Adjacent slot values (e.g. 5 and 6 or 11 and 0) are only permissible if the channel numbers of the traffic and dummy bearer are the same.

The RF level value is the transmit power of the CTS60. It can be configured to any value from -100dBm to -40dBm if connector IN1/OUT1 is used, or -40dBm to 0dBm if connectors IN1 and OUT2 are used, or -20dBm to 0dBm if connectors IN2 and OUT2 are used. The RF level value can set be in steps of 0.1dBm. The actual output level will be adjusted by the output attenuation level configured for the selected portable part (see PP type configuration menu) when the coupler selection is "on".

The carrier number offset value defines the offset value applied to all carrier numbers configured. It can take any integer value from 3 to -22. This enables extended channels to be used allowing out of band testing of portable parts (see channel/frequency table below).

The mode value defines the mode of the connection which will be set up:

- Loopback: the portable part will be set into loopback mode in order to return data, transmitted by the CTS60, without modification. This is a prerequisite for bit error rate and some modulation measurements.
- Normal: in this mode no loopback of the data is performed.
- Echo: audio signals sent to the CTS60 by the portable part are delayed by one second and sent back to the portable part.

Default

Press this key to reset all values to factory default values.

Menu up

Press this key to return to the previous menu.

Channel / Frequency Table

The following table shows the allocation of DECT channel numbers to frequencies as a function of the channel offset.

For a channel offset of -17 for example, the DECT channel 0 corresponds to a frequency of 1926.720 MHz and channel 9 to a frequency of 1911.168 MHz.

Channel	0	1	2	3	4	5	6	7	8	9
Offset -22.0	1935.360	1933.632	1931.904	1930.176	1928.448	1926.720	1924.992	1923.264	1921.536	1919.808
-21.5	1934.496	1932.768	1931.040	1929.312	1927.584	1925.856	1924.128	1922.400	1920.672	1918.944
-21.0	1933.632	1931.904	1930.176	1928.448	1926.720	1924.992	1923.264	1921.536	1919.808	1918.080
-20.5	1932.768	1931.040	1929.312	1927.584	1925.856	1924.128	1922.400	1920.672	1918.944	1917.216
-20.0	1931.904	1930.176	1928.448	1926.720	1924.992	1923.264	1921.536	1919.808	1918.080	1916.352
-19.5	1931.040	1929.312	1927.584	1925.856	1924.128	1922.400	1920.672	1918.944	1917.216	1915.488
-19.0	1930.176	1928.448	1926.720	1924.992	1923.264	1921.536	1919.808	1918.080	1916.352	1914.624
-18.5	1929.312	1927.584	1925.856	1924.128	1922.400	1920.672	1918.944	1917.216	1915.488	1913.760
-18.0	1928.448	1926.720	1924.992	1923.264	1921.536	1919.808	1918.080	1916.352	1914.624	1912.896
-17.5	1927.584	1925.856	1924.128	1922.400	1920.672	1918.944	1917.216	1915.488	1913.760	1912.032
-17.0	1926.720	1924.992	1923.264	1921.536	1919.808	1918.080	1916.352	1914.624	1912.896	1911.168
-16.5	1925.856	1924.128	1922.400	1920.672	1918.944	1917.216	1915.488	1913.760	1912.032	1910.304
-16.0	1924.992	1923.264	1921.536	1919.808	1918.080	1916.352	1914.624	1912.896	1911.168	1909.440
-15.5	1924.128	1922.400	1920.672	1918.944	1917.216	1915.488	1913.760	1912.032	1910.304	1908.576
-15.0	1923.264	1921.536	1919.808	1918.080	1916.352	1914.624	1912.896	1911.168	1909.440	1907.712
-14.5	1922.400	1920.672	1918.944	1917.216	1915.488	1913.760	1912.032	1910.304	1908.576	1906.848
-14.0	1921.536	1919.808	1918.080	1916.352	1914.624	1912.896	1911.168	1909.440	1907.712	1905.984
-13.5	1920.672	1918.944	1917.216	1915.488	1913.760	1912.032	1910.304	1908.576	1906.848	1905.120
-13.0	1919.808	1918.080	1916.352	1914.624	1912.896	1911.168	1909.440	1907.712	1905.984	1904.256
-12.5	1918.944	1917.216	1915.488	1913.760	1912.032	1910.304	1908.576	1906.848	1905.120	1903.392
-12.0	1918.080	1916.352	1914.624	1912.896	1911.168	1909.440	1907.712	1905.984	1904.256	1902.528
-11.5	1917.216	1915.488	1913.760	1912.032	1910.304	1908.576	1906.848	1905.120	1903.392	1901.664
-11.0	1916.352	1914.624	1912.896	1911.168	1909.440	1907.712	1905.984	1904.256	1902.528	1900.800
-10.5	1915.488	1913.760	1912.032	1910.304	1908.576	1906.848	1905.120	1903.392	1901.664	1899.936
-10.0	1914.624	1912.896	1911.168	1909.440	1907.712	1905.984	1904.256	1902.528	1900.800	1899.072
-9.5	1913.760	1912.032	1910.304	1908.576	1906.848	1905.120	1903.392	1901.664	1899.936	1898.208
-9.0	1912.896	1911.168	1909.440	1907.712	1905.984	1904.256	1902.528	1900.800	1899.072	1897.344
-8.5	1912.032	1910.304	1908.576	1906.848	1905.120	1903.392	1901.664	1899.936	1898.208	1896.480
-8.0	1911.168	1909.440	1907.712	1905.984	1904.256	1902.528	1900.800	1899.072	1897.344	1895.616
-7.5	1910.304	1908.576	1906.848	1905.120	1903.392	1901.664	1899.936	1898.208	1896.480	1894.752
-7.0	1909.440	1907.712	1905.984	1904.256	1902.528	1900.800	1899.072	1897.344	1895.616	1893.888
-6.5	1908.576	1906.848	1905.120	1903.392	1901.664	1899.936	1898.208	1896.480	1894.752	1893.024
-6.0	1907.712	1905.984	1904.256	1902.528	1900.800	1899.072	1897.344	1895.616	1893.888	1892.160
-5.5	1906.848	1905.120	1903.392	1901.664	1899.936	1898.208	1896.480	1894.752	1893.024	1891.296
-5.0	1905.984	1904.256	1902.528	1900.800	1899.072	1897.344	1895.616	1893.888	1892.160	1890.432
-4.5	1905.120	1903.392	1901.664	1899.936	1898.208	1896.480	1894.752	1893.024	1891.296	1889.568
-4.0	1904.256	1902.528	1900.800	1899.072	1897.344	1895.616	1893.888	1892.160	1890.432	1888.704

*Description of the Menus***CTS60**

Channel	0	1	2	3	4	5	6	7	8	9	
Offset	-3.5	1903.392	1901.664	1899.936	1898.208	1896.480	1894.752	1893.024	1891.296	1889.568	1887.840
	-3.0	1902.528	1900.800	1899.072	1897.344	1895.616	1893.888	1892.160	1890.432	1888.704	1886.976
	-2.5	1901.664	1899.936	1898.208	1896.480	1894.752	1893.024	1891.296	1889.568	1887.840	1886.112
	-2.0	1900.800	1899.072	1897.344	1895.616	1893.888	1892.160	1890.432	1888.704	1886.976	1885.248
	-1.5	1899.936	1898.208	1896.480	1894.752	1893.024	1891.296	1889.568	1887.840	1886.112	1884.384
	-1.0	1899.072	1897.344	1895.616	1893.888	1892.160	1890.432	1888.704	1886.976	1885.248	1883.520
	-0.5	1898.208	1896.480	1894.752	1893.024	1891.296	1889.568	1887.840	1886.112	1884.384	1882.656
	0.0	1897.344	1895.616	1893.888	1892.160	1890.432	1888.704	1886.976	1885.248	1883.520	1881.792
	0.5	1896.480	1894.752	1893.024	1891.296	1889.568	1887.840	1886.112	1884.384	1882.656	1880.928
	1.0	1895.616	1893.888	1892.160	1890.432	1888.704	1886.976	1885.248	1883.520	1881.792	1880.064
	1.5	1894.752	1893.024	1891.296	1889.568	1887.840	1886.112	1884.384	1882.656	1880.928	1879.200
	2.0	1893.888	1892.160	1890.432	1888.704	1886.976	1885.248	1883.520	1881.792	1880.064	1878.336
	2.5	1893.024	1891.296	1889.568	1887.840	1886.112	1884.384	1882.656	1880.928	1879.200	1877.472
	3.0	1892.160	1890.432	1888.704	1886.976	1885.248	1883.520	1881.792	1880.064	1878.336	1876.608

6.7.3 Config Synchronisation Menu (portable part for autotest)

Parameter	Value
Dummy Slot	0
Dummy Carrier	1
Traffic Slot	4
Traffic Carrier	0
RF Level	-100.0 dBm
Carrier No. Offset	-10
Sync. Type	Automatic
Sync. Time	10 s
Mode	Loopback

This menu is used to define the configuration for the synchronisation menu when testing portable parts in autotest.

The sync. type and time values are used to define the method of waiting for synchronisation of the portable part. When the sync. type is manual the user is prompted to press the continue key when the portable part has synchronised. When the sync. type is automatic the CTS60 will wait the number of seconds defined by sync. time before setting up the connection. Time values can be configured from 0 to 10 seconds.

Configuration of the other parameters is analogous to that described in section 6.7.2 for the menu "Config Sync" (Portable Part).

6.7.4 Config Power Ramp Menu

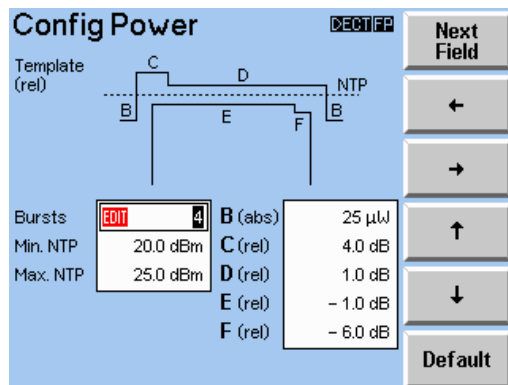

In this menu the configuration for the power ramp measurement is defined. The template is shown at the top of the screen. The various ranges of the template are identified with the letters B to F. The tolerance values for these ranges are shown below the template. The limit B is defined as an absolute level in μ W. The limits C to F are defined in dB and define levels relative to the normal transmit power.

Apart from the template the limits for the normal transmit power (NTP) of the DUT are also defined. These are defined as absolute values in dBm and define the limits for NTP averaged over a burst.

The number of bursts (1 to 200) over which the NTP is averaged can also be configured in this menu. The graphical display shows only one burst. The value set here is effective in the measurement menus "Connection Established", "Power Ramp", and "RF Modulation".

Default

Press this key to reset all values to factory default values.

Menu up

Press this key to return to the previous menu.

6.7.5 Config RF Modulation Menu (Selectable frequency drift units)

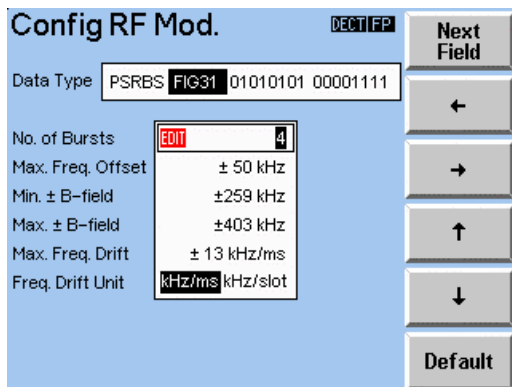

This menu is used to define the configuration for the RF modulation measurement.

The first field defines the data type transmitted to the DUT. The following types can be selected:

- "PSRBS": Pseudo Random Bit Sequence, random numbers similar to the data sent in real operation.
- "FIG31": this data pattern is best suited for the modulation measurement. Selecting this data type is a prerequisite for performing the frequency drift measurement.
- "01010101": this is the data sequence with the smallest frequency deviation.
- "00001111": this data sequence is interpreted by converters (CODECs) as silence. Drift measurements are not possible.

The number of bursts (1 to 200) over which the modulation values are averaged can also be configured in this menu. The graphical display shows only one burst. The value set here is effective in the measurement menus "Connection Established", "Power Ramp", and "RF Modulation".

The following tolerance values can also be configured:

- Maximum absolute value for the frequency offset.
- Minimum absolute values for B-field modulation.
- Maximum absolute values for the B-field modulation.
- Maximum absolute values for frequency drift.

The units in which the frequency drift measurement and tolerance limits are displayed are selectable. The following units are available for Manual and Auto Test:

- kHz/ms
- kHz/slot

The relation between both units is given through $1 \frac{\text{kHz}}{\text{ms}} = \frac{1}{2.4} \frac{\text{kHz}}{\text{slot}}$.

The default setting for the Frequency Drift Units is kHz/ms.

Default

Press this key to reset all values to factory default values.

Menu up

Press this key to return to the previous menu.

6.7.6 Config Timing Menu (Fixed Part)

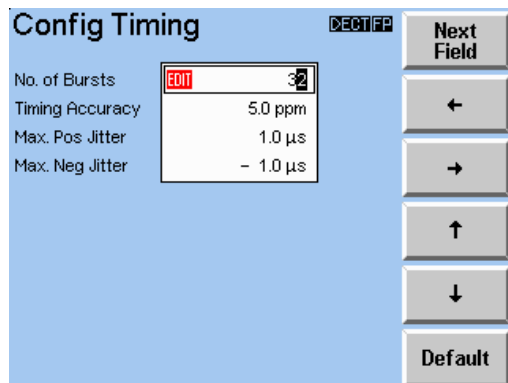

This menu is used to define the configuration for the timing measurement of fixed parts.

The number of bursts (2 to 1000) over which the timing values are averaged can be configured in this menu.

The following tolerance values can also be configured:

- Maximum value for the timing accuracy measurement.
- Maximum value for the positive jitter.
- Maximum value for the negative jitter.

Default

Press this key to reset all values to factory default values.

6.7.7 Config Timing Menu (Portable Part)

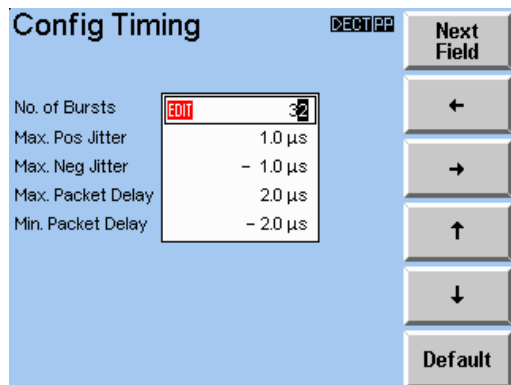

This menu is used to define the configuration for the timing measurement of portable parts.

The number of bursts (2 to 1000) over which the timing values are averaged can be configured in this menu.

The following tolerance values can also be configured:

- Maximum value for the positive jitter.
- Maximum value for the negative jitter.
- Maximum value for the packet delay.
- Maximum value for the packet delay.

Default

Press this key to reset all values to factory default values.

Menu up

Press this key to return to the previous menu.

6.7.8 Config BER (Manual Test)

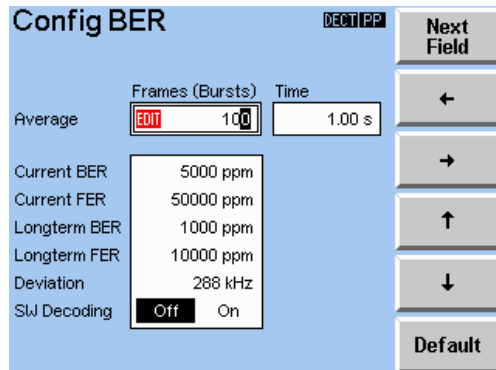

This menu is used to define the tolerances for the bit error rate measurement in manual test.

In this menu the number of bursts in the measurement window can be configured. This value can be between 1 and 30 000 000. Displayed next to this value is the time window that this represents.

The following tolerance values can also be configured:

- Maximum value for the current bit error rate.
- Maximum value for the current frame error rate.
- Maximum value for the longterm average bit error rate.
- Maximum value for the longterm average frame error rate.

The SW Decoding radiobutton switches BER measurement into the Software Decoding mode. The Software Decoding mode allows to avoid the hardware decoding compatibility problems. It is more reliable, but it is slower than the hardware decoding mode. The default setting for the SW Decoding is OFF.

Default

Press this key to reset all values to factory default values.

Menu up

Press this key to return to the previous menu.

6.7.9 Config BER (Autotest)

Config BER DECT PP

Next Field

Average Frames (Bursts) Time

Current BER 5000 ppm

Current FER 50000 ppm

Longterm BER 1000 ppm

Longterm FER 10000 ppm

Deviation 288 kHz

SW Decoding Off On

Default

This menu is used to define the tolerances for the bit error rate measurement in autotest.

In this menu the number of bursts in the measurement window can be configured. This value can be between 1 and 30 000 000. Displayed next to this value is the time window that this represents.

The following longterm tolerance values can also be configured :

- Maximum value for the longterm average bit error rate.
- Maximum value for the longterm average frame error rate.

The SW Decoding radiobutton switches BER measurement into the Software Decoding mode. The Software Decoding mode allows to avoid the hardware decoding compatibility problems. It is more reliable, but it is slower than the hardware decoding mode. The default setting for the SW Decoding is OFF.

In this menu the RF transmit level of the CTS60 during this test step can also be configured.

Default

Press this key to reset all values to factory default values.

Menu up

Press this key to return to the previous menu.

6.7.10 Config Goto (Autotest only)

The screenshot shows the 'Config Goto' menu interface. It includes a 'Next Field' button, a left arrow button, a right arrow button, an up arrow button, and a down arrow button. The main configuration area has three input fields: 'Line Number' (with an 'EDIT' button and value '1'), 'No. of Loops (N)' (with value '1'), and a 'Condition' box with four radio button options: 'Always' (selected), 'If failed', 'If passed', and 'N times'. A 'Default' button is located at the bottom right of the menu.

In this menu an autotest conditional loop can be configured.

Line number allows the test step to jump to to be configured.

The no. of Loops (N) field is used by the N times condition to define the number of loops to perform. This can only be selected if "Condition" has been selected as "N times".

The condition box allows the condition for performing the loop to be configured. The following types of conditions can be defined:

- Always. always jump to the configured line number.
- If failed. only jump to the configured line number if the previous test step failed.
- If passed. only jump to the configured line number if the previous test step passed.
- N times. jump to the configured line number N times. N is the value configured in the No. of loops field.

Default

Press this key to reset all values to factory default values.

Menu up

Press this key to return to the previous menu.

6.8 General Configuration Menus

6.8.1 Config - Select

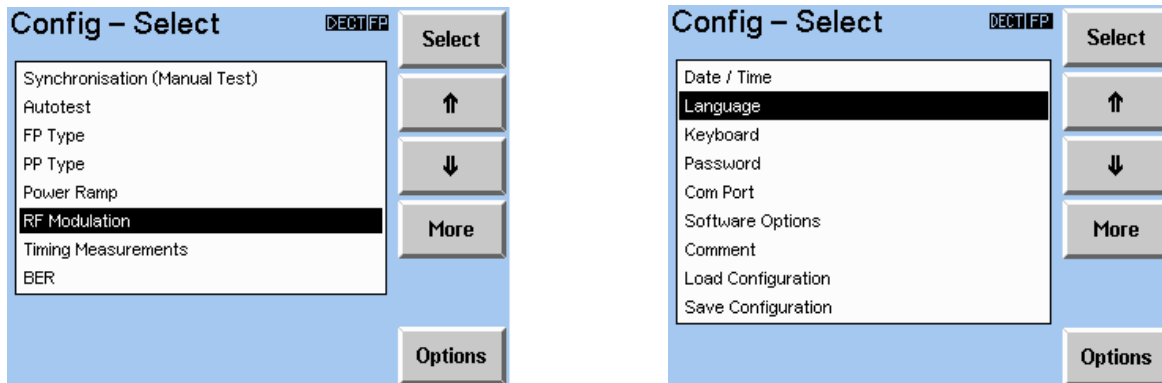

This menu is the selection menu for configuring the CTS60; nearly all of the configuration menus available from other parts of the CTS60 can also be accessed from here. The configuration menus listed can be selected by highlighting them and then pressing the "Select" key. The available options can be displayed by pressing the "Options" key.

Access to this menu can be protected by a password (see Config Password later in this chapter). If the password protection is activated, the password has to be typed in correctly before access to this menu is granted.

It should be noted that for some of the measurement related menus the menu displayed will depend on the DUT selected on the home menu. For example different timing configuration menus will be displayed depending on whether fixed or portable part has been selected.

Select

After pressing this key the currently highlighted configuration menu will be displayed.

↑ ↓

Press these keys to move up and down the displayed list of configuration menus. The currently selected type is highlighted with a horizontal bar.

More

Press this key to toggle between the two lists of configuration menus.

Options

Pressing this key shows the available hardware and software options.

6.8.2 Config Date/Time

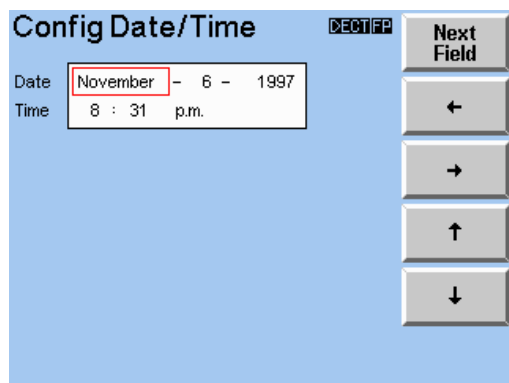

With this menu the date and time of the system can be changed.

Menu up (hardkey)

Pressing this key stores the configured date and time and returns to the config select menu.

6.8.3 Config Language

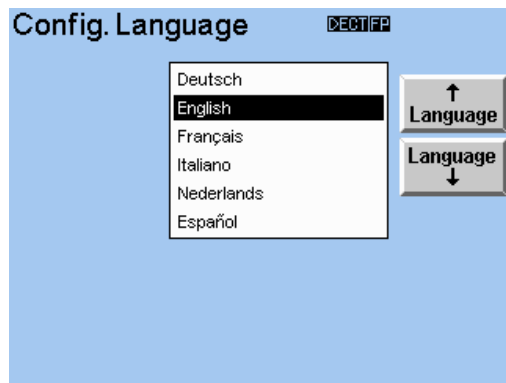

With this menu the language of the system can be selected: all text shown in all menus is changed according to the selected language.

Language ↑, Language ↓

These keys move up and down the list of languages. The currently selected language is highlighted with a horizontal bar.

Menu up (hardkey)

Pressing this key stores the highlighted language and returns to the config select menu.

6.8.4 Config Password

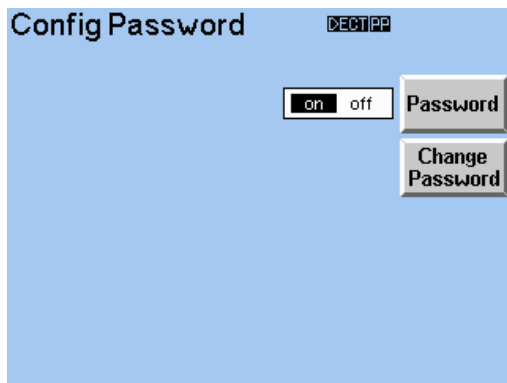

In this menu the password protection of the configuration menus can be activated and deactivated. Also by pressing the "Change Password" key a new password can be entered.

Password

Press this key to toggle the password protection on or off. If a password has already been supplied then this must be entered before this setting can be changed.

Change Password

This key enables an existing password to be changed or a new password to be entered. If a password has already been supplied then this must be entered before this setting can be changed.

6.8.5 Enter Password

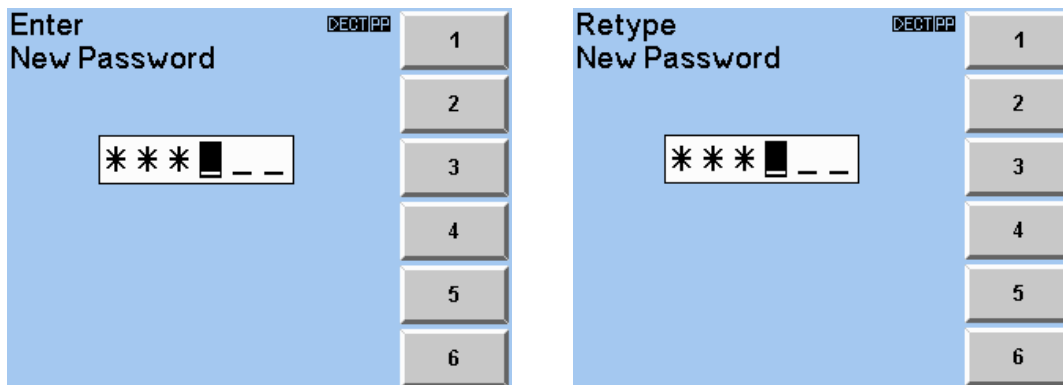

The menu on the left is displayed when the "Change Password" key is pressed on the config password menu. The password consists of six digits entered by pressing one of the softkeys "1" to "6". When these digits are entered they are not displayed on the screen; stars are displayed instead. When all six digits of the password have been entered, the menu on the right will be displayed so that the password can be re-entered. This is a check that the first password entered was correct. The menu will be exited when all six digits have been entered twice or when the "Menu Up" hardkey is pressed. In the latter case the previous value of password will remain unchanged.

6.8.6 Com Port

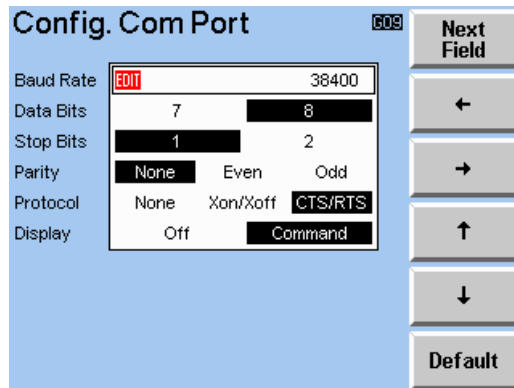

This menu allows the serial port to be configured for remote control. It also allows the type of display used for remote control to be configured.

The standard RS232 settings which can be configured on this menu are the following:

- Baud rate.
- Number of data bits to be used (7 or 8).
- Number of stop bits (1 or 2).
- Parity check to be used (none, even or odd).
- Flow control protocol to use (none, xon/xoff, or cts/rts).

The type of display used while in remote control operation can also be defined:

- Off: a blank menu is displayed while in remote control.
- Command: all remote control commands are displayed as they are received from the serial port. Any results are also displayed.

6.8.7 Comment Menu

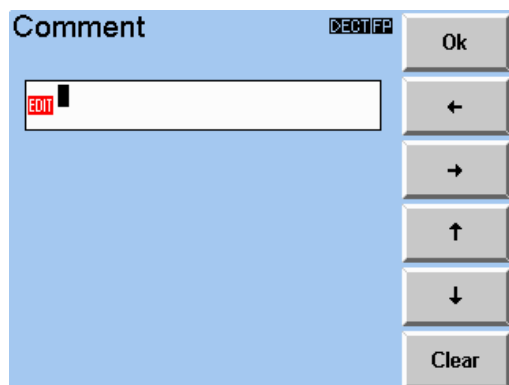

The screenshot shows a menu titled "Comment" with a blue background. At the top right of the menu is a small icon of a document with a pencil. Below the title is a text input field with a red "EDIT" button on the left and a black cursor. To the right of the input field is a vertical stack of six buttons: "Ok", a left arrow, a right arrow, an up arrow, a down arrow, and "Clear".

In this menu a comment can be entered which is printed in the first line of the comment field of the Autotest report. An alphanumeric sequence of max. 56 characters can be entered.

6.8.8 Config Keyboard Menu

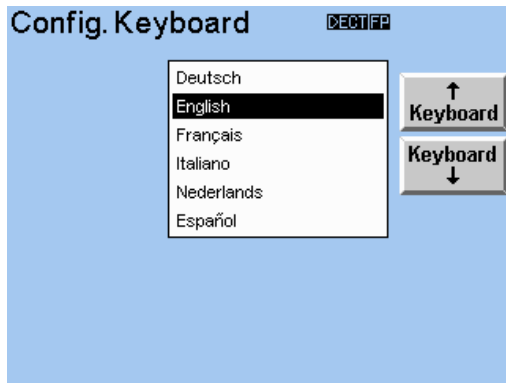

This menu is used to define which country specific keyboard is been connected to the CTS60.

Keyboard ↑, Keyboard ↓

These keys move up and down the list of country specific keyboards. The currently selected keyboard is highlighted with a horizontal bar.

Menu up (hardkey)

Pressing this key stores the highlighted keyboard and returns to the config select menu.

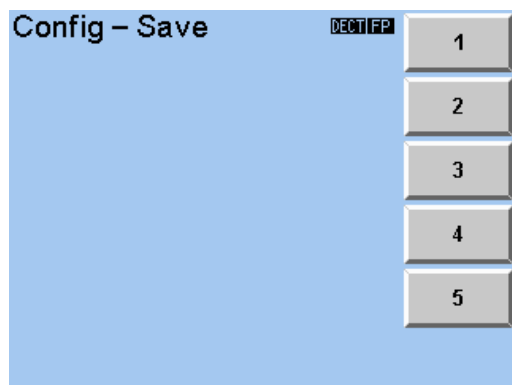
6.8.9 Config - Save

This menu is used to save the current configuration of the instrument. Note that for the CTS60 this does not apply to autotest.

1, 2, 3, 4, 5

Select one of the five possible configurations which can be saved.

Menu up

Return to the previous menu.

6.8.10 Config - Load

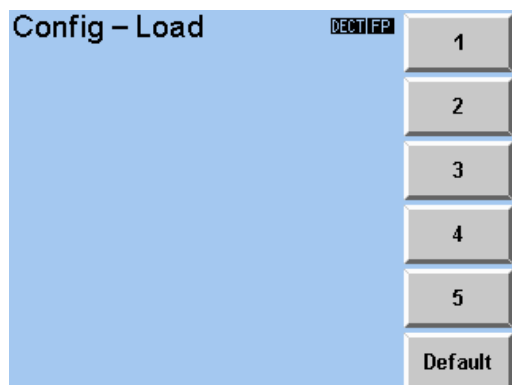

This menu is used to load a previously save instrument configuration. It can also be used to load up the factory settings. Note that for the CTS60 this does not apply to autotest.

1, 2, 3, 4, 5

Load one of the five saved configurations.

Default

Load up the factory default settings.

Menu up

Return to the previous menu.

7 Autotest Printed Reports

7.1 Overview

From the autotest results menu it is possible to print out a report of the displayed results. The following sections describe each of the different parts of the report in detail.

The header at the top of the first page describes details of the test and its configuration. On subsequent pages a smaller header is displayed. At the end of the test report after the last measurement result a footer is printed with the results of the entire test.

Since the autotest is configurable autotest actions can be executed in any order and each test step could be executed several times if a conditional goto is used. Every action, with the exception of bearer release, pause and goto has its own section of the report. These sections will be printed in the order that the test steps are executed and each section details the number of the test step which was executed.

Important notes:

The overall test will have a result as "FAILED" if any of the individual tests had failed.

The autotest report (both on the screen and printed) will contain only the last 3000 screen lines of the test. When the report reaches this number the first lines will be discarded.

7.2 Header and Footer

7.2.1 First Page Header (Fixed Part)

DECT FP Test Report 01: Standard Test			
Date:	11/03/1998	Time:	11:24 AM Page: 1 of 10
Test Station: CTS60 Rohde & Schwarz			
Comment: This test should be successful			
<hr/>			
FP Type:	A DECT fixed part		
RFPI:	0001234567	Packet Type:	P32Z
Accept RFPI:	Yes		
PMID:	FEDCB		
Input Attenuation:	0.0 dB		
Output Attenuation:	0.0 dB		

This header is printed at the top of the first page of every fixed part autotest printed report. The first line specifies that it is a fixed part test report and gives the number and name of the test.

Date and Time

Date and time of the test.

Page

Details the current page and the total number of pages in the report.

Test Station

Name and manufacturer of the test equipment from which this test report was produced.

Comment

Comment which has been defined in the configuration menu.

FP Type

Name of the FP Type selected on the autotest start menu.

RFPI

This field details the RFPI used for this test. This will be either the RFPI configured on the autotest start menu if accept RFPI has been configured as "Yes" or the detected RFPI is the accept RFPI has been configured as "No".

Accept RFPI

The value of accept RFPI configured on the autotest start menu.

PMID

Value of PMID configured for the selected FP Type.

Input and Output Attenuation

Input and output attenuation values configured for the selected connectors and FP type.

Packet Type

Packet type as defined in the selected FP type configuration.

7.2.2 First Page Header (Portable Part)

DECT PP Test Report: 01: Standard Test	
Date: 11/03/1998	Time: 11:24 AM Page: 1 of 10
Test Station: CTS60 Rohde & Schwarz	
Comment: This test should be successful	
<hr/>	
PP Type:	A DECT portable part
RFPI:	0001234567 Packet Type: P32Z
Dummy if Traffic:	No Q3: 000003FF0000
Input Attenuation:	0.0 dB Q6: 003041108008
Output Attenuation:	0.0 dB Q6: 006F0F000000
	QMUX: 03060306

This header is printed at the top of the first page of every portable part autotest printed report. The first line specifies that it is a portable part test report and gives the number and name of the test.

Date and Time

Date and time of the test.

Page

Details the current page and the total number of pages in the report.

Test Station

Name and manufacturer of the test equipment from which this test report was produced.

Comment

Comment which has been defined in the configuration menu.

PP Type

Name of the PP Type selected on the autotest start menu.

RFPI

This field details the RFPI used for this test which is the value configured on the autotest start menu.

Dummy if traffic

Details whether a dummy was transmitted after the traffic connection was established as defined in the selected PP type configuration.

Input and Output Attenuation

Input and output attenuation values configured for the selected connectors and PP type.

Q0, Q3, Q6, QMUX

Q-packet values as defined in the selected PP type configuration.

Packet Type

Packet type as defined in the selected PP type configuration.

7.2.3 Standard Header

```
DECT PP Test Report: 01: Standard Test  
Date: 11/03/1998    Time: 11:24 AM    Page: 2 of 10
```

This header is printed at the top of the second and subsequent pages of every portable and fixed part autotest printed report. The first line specifies whether it is a fixed or portable part test report and gives the number and name of the test.

Date and Time

Date and time of the test.

Page

Details the current page and the total number of pages in the report.

7.2.4 Test Result Footer

```
Overall Test Result: PASSED
```

The test result footer is printed at the end of every autotest printed report. It details the overall result of the test and is the same as the result displayed at the bottom of the autotest results menu. The values displayed here will be "PASSED", "FAILED" or "ABORTED".

7.3 Measurement Results

7.3.1 Setup Connection (Fixed Part)

(01)	Setup Connection:			
	RF Level:	-40.0 dBm	Detected RFPI:	0001234567
	Carrier No. Offset:	2	Dummy Slot:	2
	Antenna:	0	Dummy Carrier:	0
	Mode:	Loopback	Traffic Slot:	4
			Traffic Carrier:	0

This section of the report is displayed when the action "Setup Connection" is selected in a fixed part test. The first line details the test step number in brackets followed by Setup Connection the action which was executed.

RF Level

The configured CTS60 transmit level for this test step in dBm.

Carrier No. Offset

The carrier number offset configured for this test step.

Antenna

The fixed part antenna number configured for this test step.

Mode

The configured mode for this test step: loopback, normal or echo.

Detected RFPI

The RFPI which has been synchronised to.

Dummy slot and carrier

Slot and carrier of the dummy transmitted by the fixed part.

Traffic slot and carrier

Slot and carrier of the traffic connection established.

7.3.2 Setup Connection (Portable Part)

(01)	Setup Connection:			
	RF Level:	-40.0 dBm	Detected PMID:	FEDCB
	Carrier No. Offset:	2	Dummy Slot:	2
	Synchronisation:	5 s	Dummy Carrier:	0
	Mode:	Loopback	Traffic Slot:	4
			Traffic Carrier:	0

This section of the report is displayed when the action "Setup Connection" is selected in a portable part test. The first line details the test step number in brackets followed by Setup Connection the action which was executed.

RF Level

The configured CTS60 transmit level for this test step in dBm.

Carrier No. Offset

The carrier number offset configured for this test step.

Synchronisation

The type of synchronisation used to set up the connection. If manual synchronisation has been used "Manual" will be displayed here. If automatic synchronisation has been used then the time waited before continuing will be displayed here.

Mode

The configured mode for this test step: loopback, normal or echo.

Detected RFPI

The RFPI which has been synchronised to.

Dummy slot and carrier

Slot and carrier of the dummy transmitted by the fixed part.

Traffic slot and carrier

Slot and carrier of the traffic connection established.

7.3.3 Power Ramp

(02) Power Ramp (Bursts = 4) :		Value	Limits		Result
			Min.	Max.	
NTP	(dBm)	22.0	20.0	25.0	OK
B (abs)	(uW)	PASS		25	OK
C (rel)	(dB)	PASS		4.0	OK
D (rel)	(dB)	PASS		1.0	OK
E (rel)	(dB)	PASS	-1.0		OK
F (rel)	(dB)	PASS	-6.0		OK

This section of the report displays the results of the power ramp measurement. The first line details the test step number in brackets, and the title "Power Ramp" to show that this is a power ramp measurement. After this, in brackets, is the number of bursts configured for this measurement.

Below this is a table of the configured values and measured results for the measurements. The first column details what was measured and its unit in brackets. Under "Value" is listed all of the measured values for this measurement. The column "Limits" has been split into two columns "Min." and "Max.". This display the minimum and maximum configured tolerance limits for each of the measurements. The final column "Result" gives a result as to whether the measurement has passed the tolerance check.

NTP

This line details the Normal Transmit Power value measured for this test step in dBm.

Template levels (B-F)

These measurements detail whether each of these sections of the power ramp have passed or failed the tolerance check indicated by "PASS" or "FAIL" in the "Value" column.

7.3.4 Timing (Fixed Part)

(03) Timing (Bursts = 32):					
		Value	Limits		Result
			Min.	Max.	
Timing Accuracy	(ppm)	2.24		5.0	OK
Max. Pos. Jitter	(us)	0.03		1.0	OK
Max. Neg. Jitter	(us)	-0.84	-1.0		OK

This section of the report displays the results of the fixed part timing measurement. The first line details the test step number in brackets, and the title "Timing" to show that this is a timing measurement. After this, in brackets, is the number of bursts configured for this measurement.

Below this is a table of the configured values and measured results for the measurements. The first column details what was measured and its unit in brackets. Under "Value" is listed all of the measured values for this measurement. The column "Limits" displays the configured tolerance limits for each of the measurements. The final column "Result" gives a result as to whether the measurement has passed the tolerance check.

Timing Accuracy

This line details the timing accuracy value measured for this test step in ppm. To be in tolerance this value must be less than the limit specified under the "Limits" column.

Max. Pos. Jitter

This line details the maximum positive jitter value measured for this test step in μs . To be in tolerance this value must be less than the limit specified under the "Limits" column.

Max. Neg. Jitter

This line details the maximum negative jitter value measured for this test step in μs . To be in tolerance this value must be greater than the limit specified under the "Limits" column.

7.3.5 Timing (Portable Part)

	Value	Limits		Result
		Min.	Max.	
(03) Timing (Bursts = 32):				
Max. Pos. Jitter (us)	0.03		1.0	OK
Max. Neg. Jitter (us)	-0.84	-1.0		OK
Max. Packet Delay (us)	0.53		2.0	OK
Min. Packet Delay (us)	-0.31	-2.0		OK

This section of the report displays the results of the portable part timing measurement. The first line details the test step number in brackets, and the title "Timing" to show that this is a timing measurement. After this, in brackets, is the number of bursts configured for this measurement.

Below this is a table of the configured values and measured results for the measurements. The first column details what was measured and its unit in brackets. Under "Value" is listed all of the measured values for this measurement. The column "Limits" displays the configured tolerance limits for each of the measurements. The final column "Result" gives a result as to whether the measurement has passed the tolerance check.

Max. Pos. Jitter

This line details the maximum positive jitter value measured for this test step in μs . To be in tolerance this value must be less than the limit specified under the "Limits" column.

Max. Neg. Jitter

This line details the maximum negative jitter value measured for this test step in μs . To be in tolerance this value must be greater than the limit specified under the "Limits" column.

Max. Packet Delay

This line details the maximum packet delay value measured for this test step in μs . To be in tolerance this value must be less than the limit specified under the "Limits" column.

Min. Packet Delay

This line details the minimum packet delay value measured for this test step in μs . To be in tolerance this value must be greater than the limit specified under the "Limits" column.

7.3.6 RF Modulation

(04) RF Modulation (Bursts = 100, Data Type = 01010101):					
		Value	Limits		Result
			Min.	Max.	
Freq. Offset	(kHz)	-13	-50	50	OK
Max. Pos. B-field	(kHz)	+349	259	403	OK
Max. Neg. B-field	(kHz)	-351	-403	-259	OK
Freq. Drift	(kHz/ms)	+3	-13	13	OK
X-Field = Z-Field		---			

This section of the report displays the results of the RF modulation measurement. The first line details the test step number in brackets, and the title "RF Modulation" to show that this is an RF modulation measurement. After this, in brackets, is the number of bursts configured for this measurement and the configured data type.

Below this is a table of the configured values and measured results for the measurements. The first column details what was measured and its unit in brackets. Under "Value" is listed all of the measured values for this measurement. The column "Limits" displays the configured tolerance limits for each of the measurements. The final column "Result" gives a result as to whether the measurement has passed the tolerance check.

Freq. Offset

This line details the results of the frequency offset measurement in kHz/ms.

Max. Pos. B-field

This line details the maximum positive modulation frequency in the B-field part of the transmitted burst in kHz.

Max. Neg. B-field

This line details the maximum negative modulation frequency in the B-field part of the transmitted burst in kHz.

Freq. Drift

This line details the frequency drift measurement value in kHz/ms.

X-Field = Z-Field

This line details the X- and Z-Field comparison. The possible values are PASS and FAIL. This measurement is only available for Test Mode LOOPBACK and Data Type PSRBS, otherwise "----" shall appear in the Value column.

7.3.7 Bit Error Rate

(05) Bit Error Rate (Bursts = 30000000, RF Level = -100.0 dBm):					
		Value	Limits		Result
			Min.	Max.	
Longterm BER	(ppm)	5649		1000	FAIL
Longterm FER	(ppm)	9452		10000	OK

This section of the report displays the results of the portable part timing measurement. The first line details the test step number in brackets, and the title "Timing" to show that this is a timing measurement. After this, in brackets, is the number of bursts configured for this measurement.

Below this is a table of the configured values and measured results for the measurements. The first column details what was measured and its unit in brackets. Under "Value" is listed all of the measured values for this measurement. The column "Limits" displays the configured tolerance limits for each of the measurements. The final column "Result" gives a result as to whether the measurement has passed the tolerance check.

Longterm BER

This line details a longterm average value for the BER measurement. This is an average of the BER measurements over the number of bursts specified.

Longterm FER

This line details a longterm average value for the FER measurement. This is an average of the FER measurements over the number of bursts specified.

8 Remote Control

8.1 Introduction

The instrument is equipped with a serial interface (RS 232-C). The connector is located at the rear of the instrument and permits to connect a controller for remote control. The instrument supports the SCPI version 1992.0 (Standard Commands for Programmable Instruments). The SCPI standard is based on standard IEEE 488.2 and aims at the standardization of device-specific commands, error handling and the status registers (see Section 8.5.1).

This section assumes basic knowledge of SCPI conform programming and operation of the controller. A description of the interface commands is to be obtained from the relevant manuals.

The requirements of the SCPI standard placed on command syntax, error handling and configuration of the status registers are explained in detail in the respective sections. Tables provide a fast overview of the commands implemented in the instrument and the bit assignment in the status registers. The tables are supplemented by a comprehensive description of every command and the status registers.

8.2 Brief Instructions

The short and simple operating sequence given below permits fast putting into operation of the instrument and setting of its basic functions.

1. Connect CTS and controller using a serial cable (see section 2.1 and annex A).
2. Use a terminal emulation on the controller with the same parameters, as configured on the CTS.
For example 9600 baud, no parity, 8 bits, 1 stop bit and hardware-handshake.
The character strings must be terminated by a delimiter (linefeed).
3. Send the following strings to the CTS:

```
"CONF:NETW DECT <LF>"  
"CONF:TEST:TYPE DPP <LF>"  
"PROC:SEL MAN <LF>"           Choose Manual test
```

The Portable Part synchronizes to the CTS. If the Portable Part is synchronized, the CTS is ready to set up a connection with the Portable Part.

4. To return to manual control, press any key at the front panel.

8.3 Switchover to Remote Control

On power-on, the instrument is always in the manual operating state ("LOCAL" state) and can be operated via the front panel. It is switched to remote control ("REMOTE" state) as soon as it receives a command from a controller. During remote control, operation via the front panel is disabled. The instrument remains in the remote state until it is reset to the manual state via pressing the key "MENU UP". Switching from manual operation to remote control and vice versa does not affect the instrument settings.

Indications during Remote Control

In the REMOTE state, the display at the CTS can be configured:

1. Nothing is indicated on the display to increase the speed.
2. The actual remote command, the state of the testset and possibly occurred errors are shown.
3. The display changes to the selected menu in a fullscreen-view.

8.4 Device Messages (Commands and Device Responses)

– **Commands** are messages the controller sends to the instrument. They operate the device functions and request information.

The commands are subdivided according to two criteria:

1. According to the effect they have on the instrument:

Setting commands cause instrument settings such as reset of the instrument or setting the output level to 1 volt.

Queries cause data to be provided for output on the remote-control interface, e.g. for identification of the device or polling the active input.

2. According to their definition in standard IEEE 488.2:

Common Commands are exactly defined as to their function and notation in standard IEEE 488.2. They refer to functions such as management of the standardized status registers, reset and selftest.

Device-specific commands refer to functions depending on the features of the instrument such as frequency setting. A majority of these commands has also been standardized by the SCPI committee (cf. Section 8.5.1).

– **Device responses** are messages the instrument sends to the controller after a query. They can contain measurement results, instrument settings and information on the instrument status (cf. Section 8.5.4).

Structure and syntax of the device messages are described in Section 8.5. The commands are listed and explained in detail in Section 8.6.

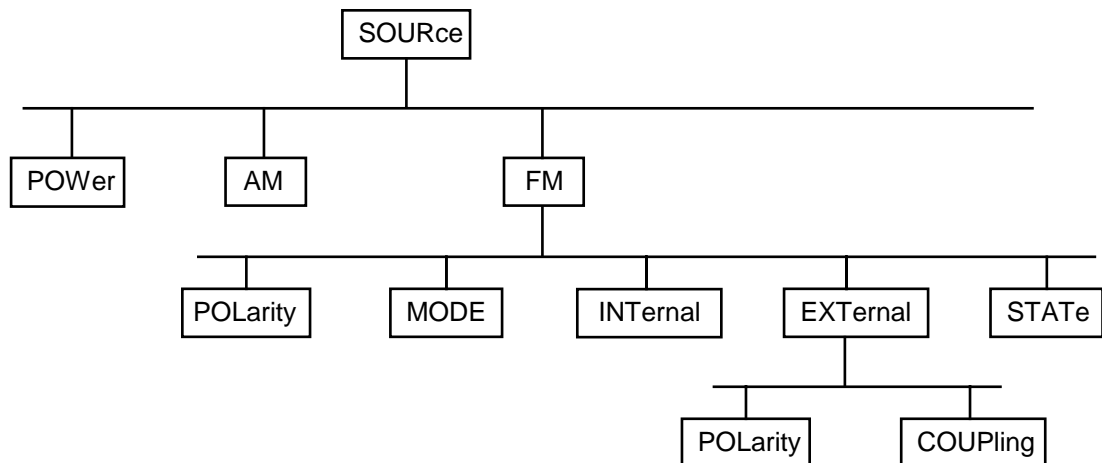

Fig. 8-1 Tree structure of the SCPI command systems using the SOURce system by way of example

Some key words occur in several levels within one command system. Their effect depends on the structure of the command, that is to say, at which position in the header of a command they are inserted.

Example: `SOURce:FM:POLarity NORMal`

This command contains key word POLarity in the third command level. It defines the polarity between modulator and modulation signal.

`SOURce:FM:EXTernal:POLarity NORMal`

This command contains key word POLarity in the fourth command level. It defines the polarity between modulation voltage and the resulting direction of the modulation only for the external signal source indicated.

Optional key words: Some command systems permit certain key words to be optionally inserted into the header or omitted. These key words are marked by square brackets in the description. The full command length must be recognized by the instrument for reasons of compatibility with the SCPI standard. Some commands are considerably shortened by these optional key words.

Example: `[SOURce]:POWer[:LEVel][:IMMediate]:OFFSet 1`

This command immediately sets the offset of the signal to 1 volt. The following command has the same effect:

`POWer:OFFSet 1`

Note: An optional key word must not be omitted if its effect is specified in detail by a numeric suffix.

Long and short form: The key words feature a long form and a short form. Either the short form or the long form can be entered, other abbreviations are not permissible.

Example: `STATus:QUESTionable:ENABle 1= STAT:QUES:ENAB 1`

Note: *The short form is marked by upper-case letters, the long form corresponds to the complete word. Upper-case and lower-case notation only serve the above purpose, the instrument itself does not make any difference between upper-case and lower-case letters.*

Parameter: The parameter must be separated from the header by a "white space". If several parameters are specified in a command, they are separated by a comma ",". A few queries permit the parameters MINimum, MAXimum and DEFault to be entered. For a description of the types of parameter, refer to Section 8.5.5.

Example: `SOURce:POWer:ATTenuation? MAXimum` Response: 60
This query requests the maximal value for the attenuation.

Numeric suffix: If a device features several functions or features of the same kind, e.g. inputs, the desired function can be selected by a suffix added to the command. Entries without suffix are interpreted like entries with the suffix 1.

Example: `SOURce:FM:EXTernal2:COUPling AC`
This command sets the coupling of the second external signal source.

8.5.3 Structure of a Command Line

A command line may consist of one or several commands. It is terminated by a <New Line>, a <New Line> with EOI or an EOI together with the last data byte. Quick BASIC automatically produces an EOI together with the last data byte.

Several commands in a command line are separated by a semicolon ";". If the next command belongs to a different command system, the semicolon is followed by a colon.

Example:

`"SOURce:POWer:CENTer MINimum;:OUTPut:ATTenuation 10"`

This command line contains two commands. The first command is part of the SOURce system and is used to specify the center frequency of the output signal. The second command is part of the OUTPut system and sets the attenuation of the output signal.

If the successive commands belong to the same system, having one or several levels in common, the command line can be abbreviated. To this end, the second command after the semicolon starts with the level that lies below the common levels (see also Fig. 8-1). The colon following the semicolon must be omitted in this case.

Example:

```
"SOURce:FM:MODE LOCKed;:SOURce:FM:INT:FREQuency 1kHz"
```

This command line is represented in its full length and contains two commands separated from each other by the semicolon. Both commands are part of the SOURce command system, subsystem FM, i.e. they have two common levels.

When abbreviating the command line, the second command begins with the level below SOURce:FM. The colon after the semicolon is omitted.

The abbreviated form of the command line reads as follows:

```
"SOURce:FM:MODE LOCKed;INT:FREQuency 1kHz"
```

However, a new command line always begins with the complete path.

```
Example: "SOURce:FM:MODE LOCKed"  
"SOURce:FM:INT:FREQuency 1kHz"
```

8.5.4 Responses to Queries

A query is defined for each setting command unless explicitly specified otherwise. It is formed by adding a question mark to the associated setting command. According to SCPI, the responses to queries are partly subject to stricter rules than in standard IEEE 488.2.

1. The requested parameter is transmitted without header.
Example: `SOURce:EXTernal:COUPling?` Response: `AC`
2. Maximum values, minimum values and all further quantities, which are requested via a special text parameter are returned as numerical values.
Example: `FREQuency? MAX` Response: `10E3`
3. Numerical values are output without a unit. Physical quantities are referred to the basic units or to the units set using the Unit command.
Example: `FREQuency?` Response: `1E6` for 1 MHz
4. Truth values <Boolean values> are returned as 0 (for OFF) and 1 (for ON).
Example: `OUTPut:STATe?` Response: `1`
5. Text (character data) is returned in a short form (see also Section 8.5.5).
Example: `SOURce:FM:SOURce?` Response: `INT1`

8.5.5 Parameters

Most commands require a parameter to be specified. The parameters must be separated from the header by a "white space". Permissible parameters are numerical values, Boolean parameters, text, character strings and block data. The type of parameter required for the respective command and the permissible range of values are specified in the command description (see Section 8.6).

Numerical values Numerical values can be entered in any form, i.e. with sign, decimal point and exponent. Values exceeding the resolution of the instrument are rounded up or down. The mantissa may comprise up to 255 characters, the exponent must lie inside the value range -32000 to 32000. The exponent is introduced by an "E" or "e". Entry of the exponent alone is not permissible. In the case of physical quantities, the unit can be entered. Permissible unit prefixes are G (giga), MA (mega), MOHM and MHZ are also permissible), K (kilo), M (milli), U (micro) and N (nano). If the unit is missing, the basic unit is used.

Example:

SOURCE:FREQUENCY 1.5 kHz = SOURCE:FREQUENCY 1.5E3

Special numerical values

The texts MINimum, MAXimum, DEFault, UP and DOWN are interpreted as special numerical values.

In the case of a query, the numerical value is provided.

Example: Setting command: SOURCE:VOLTage MAXimum

Query: SOURCE:VOLTage? Response: 15

MIN/MAX	MINimum and MAXimum denote the minimum and maximum value.
DEF	DEFault denotes a preset value which has been stored in the EPROM. This value conforms to the default setting, as it is called by the *RST command
UP/DOWN	UP, DOWN increases or reduces the numerical value by one step. The step width can be specified via an allocated step command (see annex C, List of Commands) for each parameter which can be set via UP, DOWN.
INF/NINF	INFinity, Negative INFinity (NINF) Negative INFinity (NINF) represent the numerical values -9.9E37 or 9.9E37, respectively. INF and NINF are only sent as device responses.
NAN	Not A Number (NAN) represents the value 9.91E37. NAN is only sent as device response. This value is not defined. Possible causes are the division of zero by zero, the subtraction of infinite from infinite and the representation of missing values.

Boolean Parameters Boolean parameters represent two states. The ON state (logically true) is represented by ON or a numerical value unequal to 0. The OFF state (logically untrue) is represented by OFF or the numerical value 0. 0 or 1 is provided in a query.

Example: Setting command: SOURCE:FM:STATE ON

Query: SOURCE:FM:STATE? Response: 1

Text

Text parameters observe the syntactic rules for key words, i.e. they can be entered using a short or long form. Like any parameter, they have to be separated from the header by a white space. In the case of a query, the short form of the text is provided.

Example: Setting command: `OUTPut:FiLTeR:TYPE` `EXTeRnAl`
Query: `OUTPut:FiLTeR:TYPE?` Response `EXT`

Strings

Strings must always be entered in quotation marks (' or ").

Example: `SYSTem:LANGUage` "English" or
 `SYSTem:LANGUage` 'English'

Block data

Block data are a transmission format which is suitable for the transmission of large amounts of data. A command using a block data parameter has the following structure:

Example: `HEADer:HEADer` #45168xxxxxxxx

ASCII character # introduces the data block. The next number indicates how many of the following digits describe the length of the data block. In the example the 4 following digits indicate the length to be 5168 bytes. The data bytes follow. During the transmission of these data bytes all End or other control signs are ignored until all bytes are transmitted. Data elements comprising more than one byte are transmitted with the byte being the first which was specified by SCPI command "FORMat:BORDer".

8.5.6 Overview of Syntax Elements

The following survey offers an overview of the syntax elements.

- :** The colon separates the key words of a command.
In a command line the colon after the separating semicolon marks the uppermost command level.
- ;** The semicolon separates two commands of a command line. It does not alter the path.
- ,** The comma separates several parameters of a command.
- ?** The question mark forms a query.
- *** The asterix marks a common command.
- "** Quotation marks introduce a string and terminate it.
- #** ASCII character # introduces block data.
- A "white space (ASCII-Code 0 to 9, 11 to 32 decimal, e.g.blank) separates header and parameter.

8.6 Description of Commands

8.6.1 Notation

In the following sections, all commands implemented in the instrument are first listed in tables and then described in detail, separated according to the command system. The notation corresponds to the one of the SCPI standards to a large extent. The SCPI conformity information can be taken from the list of commands in annex C.

Note: *The commands indicated by way of example are not implemented in the CTS.*

Table of Commands

Command:	In the command column, the table provides an overview of the commands and their hierarchical arrangement (see indentations).
Parameter:	In the parameter column the requested parameters are indicated together with their specified range.
Unit:	The unit column indicates the basic unit of the physical parameters.
Remark:	In the remark column an indication is made on: <ul style="list-style-type: none"> – whether the command does not have a query form, – whether the command has only one query form , – whether this command is implemented only with a certain option of the instrument.

Indentations

The different levels of the SCPI command hierarchy are represented in the table by means of indentations to the right. The lower the level is, the farther the indentation to the right is. Please observe that the complete notation of the command always includes the higher levels as well.

Example: `SOURce:FM:MODE` is represented in the table as follows:

<code>SOURce</code>	first level
<code>:FM</code>	second level
<code>:MODE</code>	third level

In the individual description, the hierarchy is represented in the corresponding way. That is to say, for each command all key words above up to the left-hand margin must be considered. An example for each command is written out at the end of the individual description.

Upper/lower case notation Upper/lower case letters serve to mark the long or short form of the key words of a command in the description (see Section 8.5.2). The instrument itself does not distinguish between upper and lower case letters.

Special characters |

A selection of key words with an identical effect exists for several commands. These key words are indicated in the same line, they are separated by a vertical stroke. Only one of these key words has to be indicated in the header of the command. The effect of the command is independent of which of the key words is indicated.

Example: SOURce
 :FREQuency
 :CW|:FIXed

The two following commands of identical meaning can be formed. They set the frequency of the constantly frequent signal to 1 kHz:

SOURce:FREQuency:CW 1E3 = SOURce:FREQuency:FIXed 1E3

A vertical stroke in indicating the parameters marks alternative possibilities in the sense of "or". The effect of the command is different, depending on which parameter is entered.

Example: Selection of the parameters for the command
 SOURce:COUPling AC | DC

If parameter AC is selected, only the AC content is fed through, in the case of DC, the DC as well as the AC content.

- [] Key words in square brackets can be omitted when composing the header (cf. Section 8.5.2, Optional Keywords). The full command length must be accepted by the instrument for reasons of compatibility with the SCPI standards.
 Parameters in square brackets can optionally be incorporated in the command or omitted as well.
- { } Parameters in braces can optionally be incorporated in the command either not at all, once or several times.

8.6.2 Common Commands

The common commands are taken from the IEEE 488.2 (IEC 625-2) standard. Some commands have the same effect on different devices. The headers of these commands consist of "*" followed by three letters. Many common commands refer to the status reporting system which is described in detail in Section 8.8.

Table 8-1 Common Commands

Command	Parameter	Unit	Remark
*CLS			no query
*ESE	0...255		
*ESR?			only query
*IDN?			only query
*IST?			only query
*OPC			
*OPT?			only query
*PRE	0...255		
*PSC	0 1		
*RST			no query
*SRE	0...255		
*STB?			only query
*TST?			only query
*WAI			

*CLS

CLEAR STATUS sets the status byte (STB), the standard event register (ESR) and the EVENT-part of the QUESTIONable and the OPERATION register to zero. The command does not alter the mask and transition parts of the registers. It clears the output buffer.

*ESE 0...255

EVENT STATUS ENABLE sets the event status enable register to the value indicated. Query *ESE? returns the contents of the event status enable register in decimal form.

*ESR?

STANDARD EVENT STATUS QUERY returns the contents of the event status register in decimal form (0 to 255) and subsequently sets the register to zero.

***IDN?**

IDENTIFICATION QUERY queries the instrument identification.

The device response is for example:

ROHDE&SCHWARZ,CTSzz,sssss/sss,x.xx yy.yy.yy

(zz is the model no., eg 55 or 65

sssss/sss is the serial no., eg 101183/005

x.xx is the software version, eg V 1.00

yy.yy.yy is the date, eg 18.10.93)

***IST?**

INDIVIDUAL STATUS QUERY returns the contents of the IST flag in decimal form (0 | 1). The IST-flag is the status bit which is sent during a parallel poll.

***OPC**

OPERATION COMPLETE sets bit 0 in the event status register when all preceding commands have been executed. This bit can be used to initiate a service request (cf. Section 8.7).

***OPC?**

OPERATION COMPLETE QUERY writes message "1" into the output buffer as soon as all preceding commands have been executed (cf. Section 8.7).

***OPT?**

OPTION IDENTIFICATION QUERY queries the options included in the instrument and returns a list of the options installed. The options are separated from each other by means of commas.

The responses have the following meaning:

B1	OCXO Reference
B7	Module Test
K6	Remote Control

Example of a device response: B1,,B7,,K6

***PRE 0...255**

PARALLEL POLL REGISTER ENABLE sets parallel poll enable register to the value indicated. Query *PRE? returns the contents of the parallel poll enable register in decimal form.

***PSC 0 | 1**

POWER ON STATUS CLEAR determines whether the contents of the ENABLE registers is maintained or reset in switching on.

*PSC = 0 causes the contents of the status registers to be maintained. Thus a service request can be triggered in switching on in the case of a corresponding configuration of status registers ESE and SRE.

*PSC \neq 0 resets the registers.

Query *PSC? reads out the contents of the power-on-status-clear flag. The response can be 0 or 1.

***RST**

RESET sets the instrument to a defined default status. The default setting is indicated in the description of commands. Note: language and keyboard settings are unaffected by this command.

***SRE 0...255**

SERVICE REQUEST ENABLE sets the service request enable register to the value indicated. Bit 6 (MSS mask bit) remains 0. This command determines under which conditions a service request is triggered. Query *SRE? reads the contents of the service request enable register in decimal form. Bit 6 is always 0.

***STB?**

READ STATUS BYTE QUERY reads the contents of the status byte in decimal form.

***TST?**

SELF TEST QUERY triggers selftests of the instrument and outputs an error code in decimal form.

WAI

WAIT-to-CONTINUE only permits the servicing of the subsequent commands after all preceding commands have been executed and all signals have settled (see also section 8.7 and "*OPC").

8.7 Instrument Model and Command Processing

The instrument model shown in Fig. 8-2 has been made viewed from the standpoint of the servicing of remote-control commands. The individual components work independently of each other and simultaneously. They communicate by means of so-called "messages".

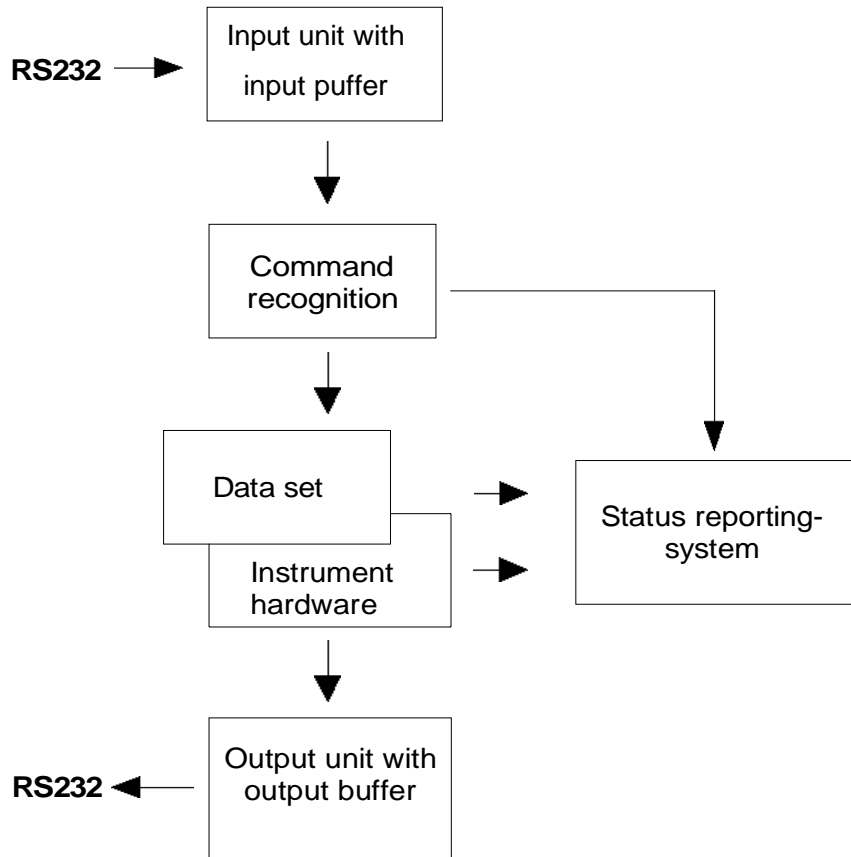

Fig. 8-2 Instrument model in the case of remote control

8.8 Status Reporting System

The status reporting system (cf. Fig. 8-4) stores all information on the present operating state of the instrument and on errors which have occurred. This information is stored in the status registers and in the error queue. The status registers and the error queue can be queried via the remote-control interface.

The information is of a hierarchical structure. The register status byte (STB) defined in IEEE 488.2 and its associated mask register service request enable (SRE) form the uppermost level. The STB receives its information from the standard event status register (ESR) which is also defined in IEEE 488.2 with the associated mask register standard event status enable (ESE) and registers STATus:OPERation and STATus:QUEStionable which are defined by SCPI and contain detailed information on the instrument.

The IST flag ("Individual STatus") and the parallel poll enable register (PPE) allocated to it are also part of the status reporting system. The IST flag, like the SRQ, combines the entire instrument status in a single bit. The PPE fulfills an analog function for the IST flag as the SRE for the service request.

The output buffer contains the messages the instrument returns to the controller. It is not part of the status reporting system but determines the value of the MAV bit in the STB and thus is represented in Fig. 8-4.

8.8.1 Structure of an SCPI Status Register

Each SCPI register consists of 5 parts which each have a width of 16 bits and have different functions (cf. Fig. 8-3). The individual bits are independent of each other, i.e. each hardware status is assigned a bit number which is valid for all five parts. For example, bit 3 of the STATus:OPERation register is assigned to the hardware status "wait for trigger" in all five parts. Bit 15 (the most significant bit) is set to zero for all parts. Thus the contents of the register parts can be processed by the controller as positive integer.

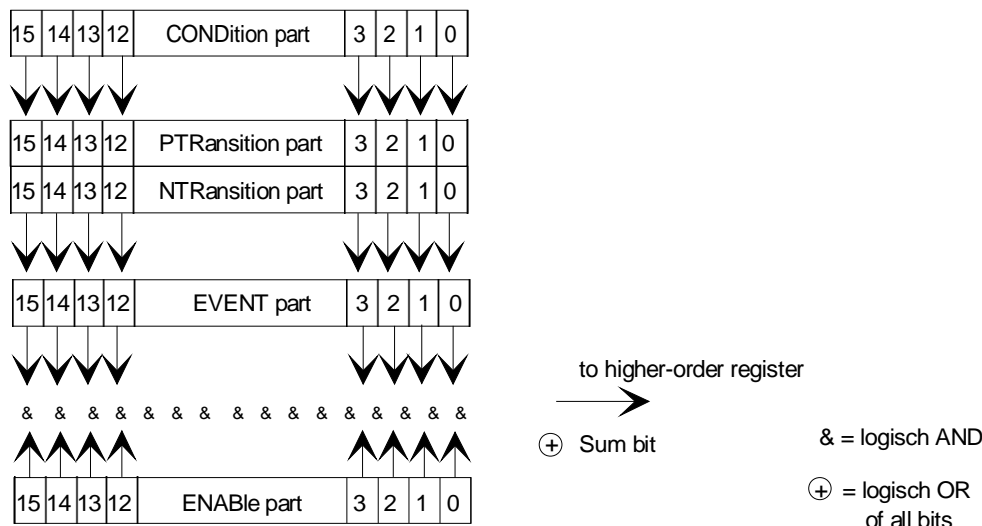

Fig. 8-3 The status-register model

CONDition part	The CONDition part is directly written into by the hardware or the sum bit of the next lower register. Its contents reflects the current instrument status. This register part can only be read, but not written into or cleared. Its contents is not affected by reading.
PTRansition part	The Positive-TRansition part acts as an edge detector. When a bit of the CONDition part is changed from 0 to 1, the associated PTR bit decides whether the EVENT bit is set to 1. PTR bit =1: the EVENT bit is set. PTR bit =0: the EVENT bit is not set. This part can be written into and read at will. Its contents is not affected by reading.
NTRansition part	The Negative-TRansition part also acts as an edge detector. When a bit of the CONDition part is changed from 1 to 0, the associated NTR bit decides whether the EVENT bit is set to 1. NTR-Bit = 1: the EVENT bit is set. NTR-Bit = 0: the EVENT bit is not set. This part can be written into and read at will. Its contents is not affected by reading.
With these two edge register parts the user can define which state transition of the condition part (none, 0 to 1, 1 to 0 or both) is stored in the EVENT part.	
EVENT part	The EVENT part indicates whether an event has occurred since the last reading, it is the "memory" of the condition part. It only indicates events passed on by the edge filters. It is permanently updated by the instrument. This part can only be read by the user. During reading, its contents is set to zero. In linguistic usage this part is often equated with the entire register.
ENABLE part	The ENABLE part determines whether the associated EVENT bit contributes to the sum bit (cf. below). Each bit of the EVENT part is ANDed with the associated ENABLE bit (symbol '&'). The results of all logical operations of this part are passed on to the sum bit via an OR function (symbol '+'). ENAB-Bit = 1: the associated EVENT bit does not contribute to the sum bit ENAB-Bit = 0: if the associated EVENT bit is "1", the sum bit is set to "1" as well. This part can be written into and read by the user at will. Its contents is not affected by reading.
Sum bit	As indicated above, the sum bit is obtained from the EVENT and ENABLE part for each register. The result is then entered into a bit of the CONDition part of the higher-order register. The instrument automatically generates the sum bit for each register. Thus an event, e.g. a PLL that has not locked, can lead to a service request throughout all levels of the hierarchy.

Note: *The service request enable register SRE defined in IEEE 488.2 can be taken as ENABLE part of the STB if the STB is structured according to SCPI. By analogy, the ESE can be taken as the ENABLE part of the ESR.*

8.8.2 Overview of the Status Registers

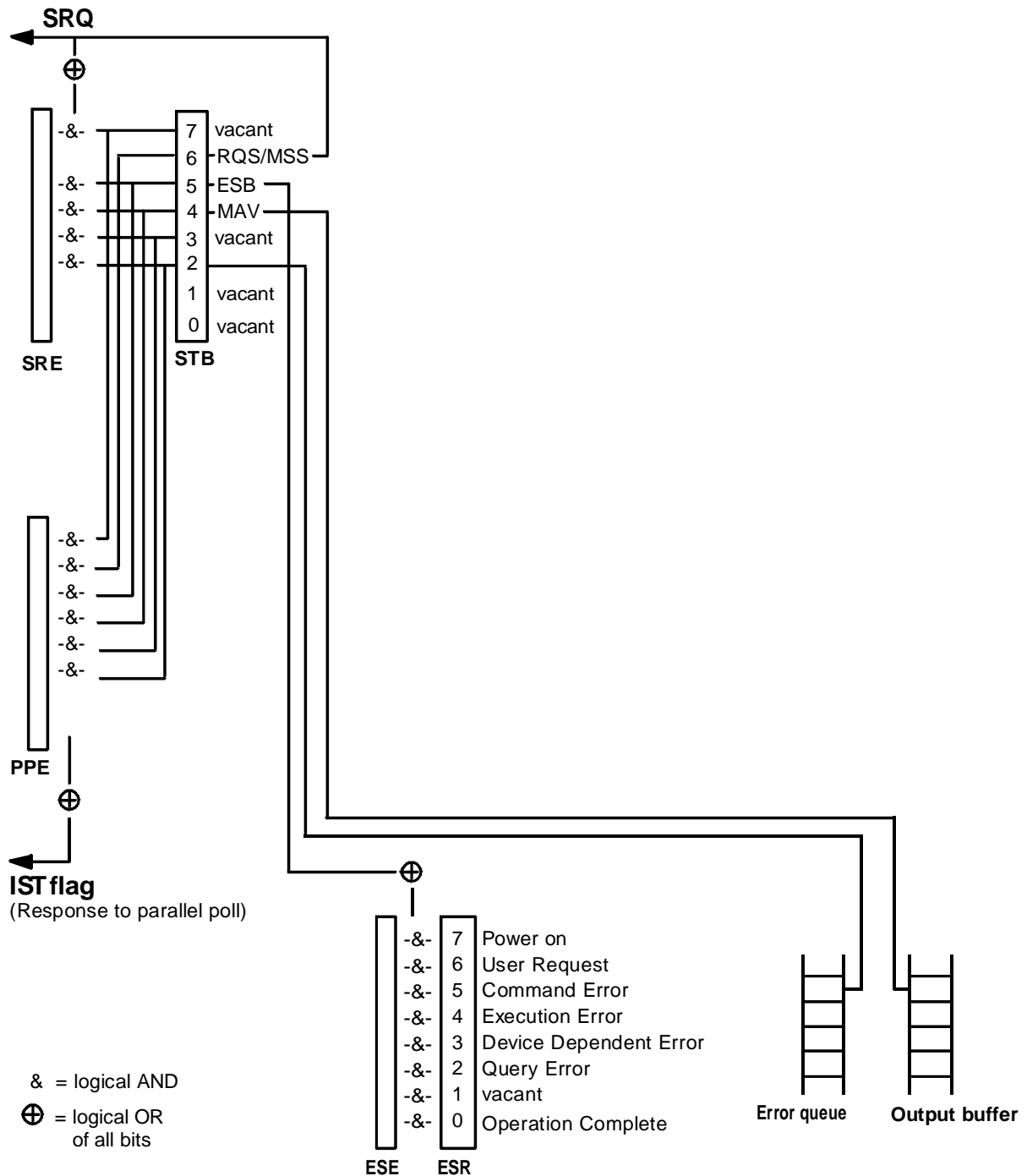

Fig. 8-4 Overview of status registers

8.8.3 Description of the Status Registers

8.8.3.1 Status Byte (STB) and Service Request Enable Register (SRE)

The STB is already defined in IEEE 488.2. It provides a rough overview of the instrument status by collecting the pieces of information of the lower registers. It can thus be compared with the CONDition part of an SCPI register and assumes the highest level within the SCPI hierarchy. A special feature is that bit 6 acts as the sum bit of the remaining bits of the status byte.

The STATUS BYTE is read out using the command "*STB?".

Table 8-2 Meaning of the bits used in the status byte

Bit No.	Meaning
2	<p>Error Queue not empty</p> <p>The bit is set when an entry is made in the error queue. If this bit is enabled by the SRE, each entry of the error queue generates a Service Request. Thus an error can be recognized and specified in greater detail by polling the error queue. The poll provides an informative error message. This procedure is to be recommended since it considerably reduces the problems involved with remote control.</p>
4	<p>MAV bit (message available)</p> <p>The bit is set if a message is available in the output buffer which can be read. This bit can be used to enable data to be automatically read from the instrument to the controller.</p>
5	<p>ESB bit</p> <p>Sum bit of the event status register. It is set if one of the bits in the event status register is set and enabled in the event status enable register. Setting of this bit implies a serious error which can be specified in greater detail by polling the event status register.</p>
6	<p>MSS bit (master status summary bit)</p> <p>The bit is set if the instrument triggers a service request. This is the case if one of the other bits of this registers is set together with its mask bit in the service request enable register SRE.</p>

8.8.3.2 Event-Status-Reg. (ESR) and Event-Status-Enable-Reg. (ESE)

The ESR is already defined in IEEE 488.2. It can be compared with the EVENT part of an SCPI register. The event status register can be read out using command "*ESR?".

The ESE is the associated ENABLE part. It can be set using command "*ESE" and read using command "*ESE?".

Table 8-3 Meaning of the bits used in the event status register

Bit No.	Meaning
0	<p>Operation Complete</p> <p>This bit is set on reception of the command *OPC exactly when all previous commands have been executed.</p>
2	<p>Query Error</p> <p>This bit is set if either the controller wants to read data from the instrument without having sent a query, or if it does not fetch requested data and sends new instructions to the instrument instead. The cause is often a query which is faulty and hence cannot be executed.</p>
3	<p>Device-dependent Error</p> <p>This bit is set if a device-dependent error occurs. An error message with a number between -300 and -399 or a positive error number, which denotes the error in greater detail, is entered into the error queue (cf. annex B, Error Messages).</p>
4	<p>Execution Error</p> <p>This bit is set if a received command is syntactically correct, however, cannot be performed for other reasons. An error message with a number between -200 and -300, which denotes the error in greater detail, is entered into the error queue (cf. annex B, Error Messages).</p>
5	<p>Command Error</p> <p>This bit is set if a command which is undefined or syntactically incorrect is received. An error message with a number between -100 and -200, which denotes the error in greater detail, is entered into the error queue (cf. annex B, Error Messages).</p>
6	<p>User Request</p> <p>This bit is set on pressing the LOCAL key, i. e., when the instrument is switched over to manual control.</p>
7	<p>Power On (supply voltage on)</p> <p>This bit is set on switching on the instrument.</p>

8.8.4 Error-Queue Query

Each error state in the instrument leads to an entry in the error queue. The entries of the error queue are detailed plain-text error messages which can be queried via the remote control using command "SYSTem:ERRor?". Each call of "SYSTem:ERRor?" provides an entry from the error queue. If no error messages are stored there any more, the instrument responds with 0, "No error".

The error queue should be queried after every SRQ in the controller program as the entries describe the cause of an error more precisely than the status registers. Especially in the test phase of a controller program the error queue should be queried regularly since faulty commands from the controller to the instrument are recorded there as well.

8.8.5 Resetting Values of the Status Reporting System

Table 8-5 comprises the different commands and events causing the status reporting system to be reset. None of the commands, except for *RST and SYSTem:PRESet influences the functional instrument settings. In particular, DCL does not change the instrument settings.

Table 8-5 Resettting instrument functions

Event	Switching on supply voltage		*RST or SYSTem:PRESet	STATus:PRESet	*CLS
	Power-On-Status-Clear				
	0	1			
Clear STB,ESR	—	yes	—	—	yes
Clear ESE	—	yes	—	—	—
Clear EVENTt parts of the registers	—	yes	—	—	yes
Clear error queue	yes	yes	—	—	yes
Clear output buffer	yes	yes	1)	1)	1)
Clear command processing and input buffer	yes	yes	—	—	yes

1) Every command being the first in a command line, i.e., immediately following a <PROGRAM MESSAGE TERMINATOR> clears the output buffer.

9 Software Options

9.1 Overview

Software options is a way of turning on extra facilities of the CTS via the softkeys. An option can be enabled either permanently or for a limited period of time.

To use software options, two pieces of information are required, these being the CTS's serial number and a code number for the required software option. When this information is entered the option will be enabled.

To enter this numbers an external keyboard is recommended.

9.2 Menu hierarchy

The diagram below shows the menu structure of Software Options, which is in addition to the standard menus on the CTS.

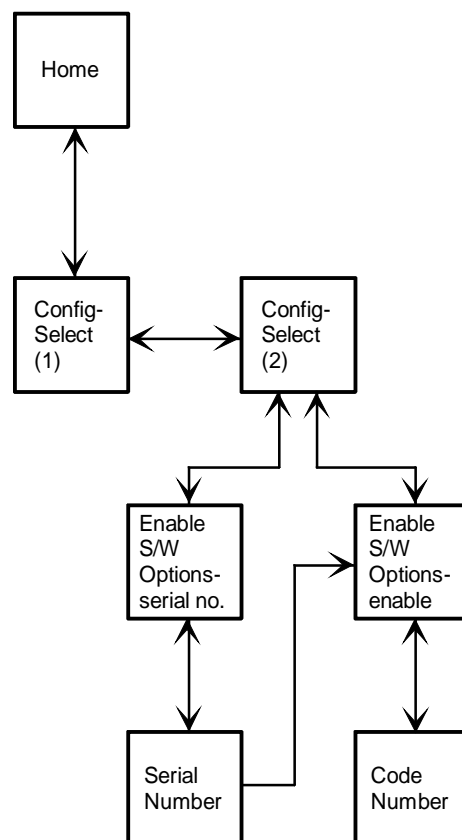

The menu entered is dependant on whether the serial number is available or not.

9.3 Setting the Serial Number

To set the serial number, firstly enter the "Enable S/W Options" menu via the main configuration menu.

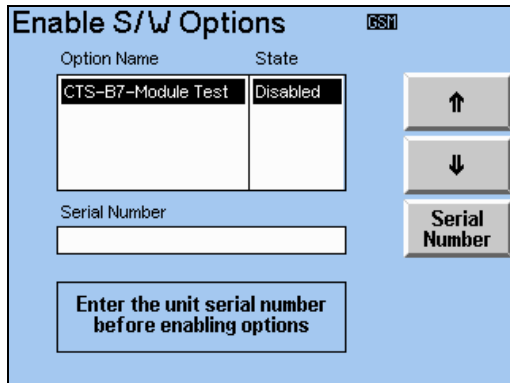

Enable S/W Options Menu

The serial number is normally entered into the CTS on the production line and can be seen on the "Enable S/W Options" menu. If this is not the case there will be a softkey labelled "Serial Number" present. There is no need to enter the serial number again if it is already set.

To enter the serial number, press the "Serial Number" softkey which will move the system into the "Serial Number" menu.

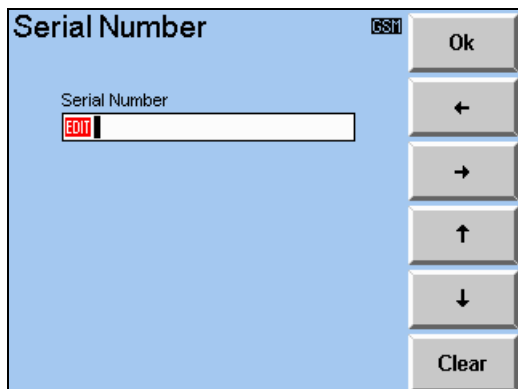

Serial Number Menu

The serial number can be found on the rear panel of the CTS and uses the format of <xxxxxx/xxx>, for example <123456/789>. Enter this serial number using the softkeys. If the format of the entered serial number is wrong you will be informed via a message.

Important: The serial number can only be entered once and thereafter cannot be edited.

9.4 Setting the Code Number to enable an option

First enter the "Enable S/W Options" menu via the main configuration menu. If you have just set the serial number you will already be in this menu.

If the serial number is available then it will be shown on the menu, as below. If it is not available then you must enter it as described in section 9.3.

Option Name	State
CTS-K9-GSM 900	Enabled
CTS-K18-GSM 1800	Enabled
CTS-K19-GSM 1900	Enabled
CTS-K62-DECT GAP	Disabled

Serial Number
123456/789

Enable S/W Options Menu (Test Disabled)

Choose the software option you want to enable using the arrow softkeys. Press the "Enable" button to enter the "Code Number" menu for that particular option.

Option Name
CTS-B7-Module Test

Code Number
EDIT

Code Number Menu

The code number required can be obtained from your local Rohde & Schwarz sales office. The number supplied should be entered via the softkeys.

Once the code number has been successfully entered, the state of the option will be "Enabled" in the "Enable S/W Options" menu and the "Enable" button will disappear.

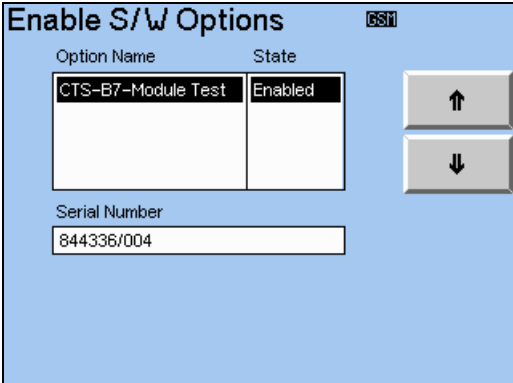

Enable S/W Options CSI

Option Name	State
CTS-B7-Module Test	Enabled

Serial Number
844336/004

↑
↓

Enable S/W Options Menu (Test Enabled)

The new option is now available for use. If the option has been enabled for a limited period of time the option will disappear from use after the time period has elapsed.

10 Performance Test (with service software)

10.1 DECT Test Program Package

The program `cmd.exe` is a command line interpreter and allows setting and measurement of the DECT unit. After the start of `cmd.exe` the list of commands can be called up by typing "h" or "?". The commands range from simple settings of output frequency channel and output level through to complete measurements of RF level, frequency offset and modulation deviation.

10.1.1 Starting the Program

- Booting in DOS:
All service programs of CTS are only accessible under DOS. Since only part of the VGA picture is displayed on the internal LCD, an external VGA-compatible monitor has to be connected to the rear SERVICE connector before booting. An external keyboard must be connected to the CTS to enter the DOS level. After switching on the CTS, a short tone and then three short tones are heard. The keys <Alt>, <Control> and <E> must now be pressed within 1.5 seconds. Make sure not to press the key <E> before the two other keys have been pressed.

Once the controller startup is completed, the DOS prompt is displayed on the external monitor.

If switchover fails, switch off the CTS and repeat the procedure.

Note:

Files must not be modified or deleted. This would impair compliance with specifications and proper functioning of the CTS.

SW_CRT or SW_LCD switches between external monitor and LC display.

- Change directory: `cd\cmd\fw`
- Call performance test program: `cmd`

10.1.2 Remote Control of `cmd` Program

As `cmd.exe` is a DOS program, it can be remote-controlled via the COM interface, eg via a terminal program on the controller.

Note for use of CTS65:

CHECK program must be called up beforehand to ensure that the analog unit is initialized.

Hardware

A null-modem cable with hardware handshake is used.

Settings

CTS	mode com1:2400,n,8,1,p	parameter of COM1 interface
	ctty com1	input and output via COM1

10.1.3 Special Features of cmdd Operation

- Some parameters are input in hexadecimal format, others in decimal format (see command overview).
- In case of combinational RF measurement the DECT transmitter should be set to another frequency channel than the test frequency using the command tc <channel> to prevent transmitter crosstalk in the receive unit (performed by the device software whenever a measurement takes place).
- Prior to combinational RF measurement the FM demodulator offset should be calibrated by means of the command meas_calibrate (cyclically performed by the device software).
- cmdd.exe does not initialize the control of the 10 MHz reference frequency on the GSM analog unit nor the control of the 10 MHz OCXO (option CTS-B1). Initialization has to be performed beforehand by the GSM service software, for example.

Command Overview cmdd.exe (DECT Performance Test)

Command	Value range	Response	Notes
sc <code>	0,1,2,3	status: 0	RF connectors 0: IN1, OUT1 1: IN2, OUT1 2: IN1, OUT2 3: IN2, OUT2
rc <channel>	-22, -21 to 12		setting of rx frequency channel
rx <attenuation>	0, 1 to 30		setting of rx attenuator -> expected power 0 3 dBm IN1, -38 dBm IN2 1 4 dBm IN1, -37 dBm IN2 30 30 dBm IN1, -11 dBm IN2
tc <channel>	-22, -21 to 12		setting of tx frequency channel
tx <attenuation>	0, 1 to 600		setting of tx attenuator -> output level 0 -40.0 dBm OUT1, 7.5 dBm OUT2 1 -40.1 dBm OUT1, 7.4 dBm OUT2 600 -100.0 dBm OUT1, -52.5 dBm OUT2
mod_set_dev <deviation>	0 to 0x100	status: 0	setting of FM deviation: 0x0: 0 kHz 0x1: 2 kHz 0x90: 288 kHz 0xff: 510 kHz
mod_set_sig <half chan> <burst> <data type>	0x-2C, 0x-2B to 0x18 0,1,2 0,1,2	status: 0	setting of TX signal: channel = <half chan> / 2 <burst>: 0: CW, 1: burst, 2: DECT burst <data type>: 0: 0101, 1: 0011, 2: 00001111
mod_rel_sig		status: 0	release TX signal
mod_exp_power <power>	0x3, 0x4 to 0x1E	status: 0	set expected power for measurement <power> dBm
meas_calibrate		status : 0 FREQOFFS:	calibrate offset of FM demodulator
mod_rf_combi <half chan> <duration> <trigger> <delay>	0x-2C, 0x-2B to 0x18 0 to 1000 0,1 0 to 1000	status: 0 NTP: FREQOFFS: MAXMODU: MINMODU:	measuring of NTP, frequency offset and FM deviation channel = <half chan> / 2 <duration> of measurement in µs <trigger>: 0: immediately, 1: rising RF <delay> after trigger in µs
mod_end_combi			cancel mod_rf_combi

10.1.4 Functional Check of DECT Mode

1) Transmitter frequency accuracy

- Measure tx frequency at connector RF OUT 2 DECT with frequency counter, power 0 dBm
- Common cmdd settings:
 - > sc 2
 - > tx 75

cmdd setting	output	frequency	tolerance
-> mod_set_sig 18 0 0	RF OUT 2 DECT	1876.608 MHz	< +- 90 Hz
-> mod_set_sig 0 0 0	RF OUT 2 DECT	1897.344 MHz	< +- 90 Hz
-> mod_set_sig -2C 0 0	RF OUT 2 DECT	1935.360 MHz	< +- 90 Hz

2) RF IN/OUT transmitter frequency response

- Measure output power at connector RF IN/OUT with power meter, expected power -40 dBm
- Common cmdd settings
 - > sc 0
 - > tx 0

cmdd setting	frequency	level	tolerance
-> mod_set_sig 18 0 0	1876.608 MHz	-40 dBm	< +- 1.5 dB
-> mod_set_sig 0 0 0	1897.344 MHz	-40 dBm	< +- 1.5 dB
-> mod_set_sig -2C 0 0	1935.360 MHz	-40 dBm	< +- 1.5 dB

3) RF IN/OUT transmitter level, step attenuator

- Measure output power at connector RF IN/OUT with spectrum analyzer, expected power -40 dBm to -100 dBm
- Common cmdd settings
 - > sc 0

cmdd setting	frequency	level	tolerance
-> mod_set_sig 0 0 0 -> tx 0	1897.344 MHz	-40 dBm	< +- 1.5 dB
-> tx 100	1897.344 MHz	-50 dBm	< +- 1.5 dB
-> tx 200	1897.344 MHz	-60 dBm	< +- 1.5 dB
-> tx 300	1897.344 MHz	-70 dBm	< +- 1.5 dB
-> tx 400	1897.344 MHz	-80 dBm	< +- 1.5 dB
-> tx 500	1897.344 MHz	-90 dBm	< +- 1.5 dB
-> tx 550	1897.344 MHz	-95 dBm	< +- 1.5 dB
-> tx 600	1897.344 MHz	-100 dBm	< +- 1.5 dB
-> mod_set_sig 18 0 0 -> tx 600	1876.608 MHz	-100 dBm	< +- 1.5 dB
-> mod_set_sig -2C 0 0 -> tx 600	1935.360 MHz	-100 dBm	< +- 1.5 dB

CTS60**Performance Test**

4) RF OUT 2 DECT transmitter frequency response

- Measure output power at connector RF OUT 2 DECT with power meter, expected power 0 dBm
- Common cmdd settings
 - > sc 2
 - > tx 75

cmdd setting	frequency	level	tolerance
-> mod_set_sig 18 0 0	1876.608 MHz	0 dBm	< +- 2 dB
-> mod_set_sig 0 0 0	1897.344 MHz	0 dBm	< +- 2 dB
-> mod_set_sig -2C 0 0	1935.360 MHz	0 dBm	< +- 2 dB

5) RF OUT 2 DECT transmitter level, step attenuator

- Measure output power at connector RF OUT 2 DECT with power meter, expected power 0 dBm to -40 dBm
- Common cmdd settings
 - > sc 2
 - > mod_set_sig 0 0 0

cmdd setting	frequency	level	tolerance
-> tx 75	1897.344 MHz	0 dBm	< +- 2 dB
-> tx 175	1897.344 MHz	-10 dBm	< +- 2 dB
-> tx 275	1897.344 MHz	-20 dBm	< +- 2 dB
-> tx 375	1897.344 MHz	-30 dBm	< +- 2 dB
-> tx 475	1897.344 MHz	-40 dBm	< +- 2 dB
-> mod_set_sig 18 0 0 -> tx 475	1876.608 MHz	-40 dBm	< +- 2 dB
-> mod_set_sig -2C 0 0 -> tx 475	1935.360 MHz	-40 dBm	< +- 2 dB

6) RF IN/OUT harmonics

- Measure harmonic at connector RF IN/OUT with spectrum analyzer
- Common cmdd settings
 - > sc 0
 - > tx 0

cmdd setting	frequency	harmonic	tolerance
-> mod_set_sig 18 0 0	1876.608 MHz, -40 dBm	3753.360 MHz	< -20 dBc
-> mod_set_sig 0 0 0	1897.344 MHz, -40 dBm	3794.688 MHz	< -20 dBc
-> mod_set_sig -2C 0 0	1935.360 MHz, -40 dBm	3870.720 MHz	< -20 dBc

Performance Test**CTS60**

7) Transmitter FM modulation

- Measure FM modulation with modulation analyzer at RF OUT 2 DECT, power 0 dBm
- Common cmdd settings
 - > sc 2
 - > tx 75
 - > mod_set_dev 90

cmdd setting	frequency	data type	expected deviation	tolerance
-> mod_set_sig 18 0 2	1876.608 MHz	00001111	305 kHz	< +-15 kHz
-> mod_set_sig 0 0 2	1897.344 MHz	00001111	305 kHz	< +-15 kHz
-> mod_set_sig -2C 0 2	1935.360 MHz	00001111	305 kHz	< +-15 kHz
-> mod_set_sig 18 0 1	1876.608 MHz	00110011	295 kHz	< +-14 kHz
-> mod_set_sig 0 0 1	1897.344 MHz	00110011	295 kHz	< +-14 kHz
-> mod_set_sig -2C 0 1	1935.360 MHz	00110011	295 kHz	< +-14 kHz
-> mod_set_sig 18 0 0	1876.608 MHz	01010101	262 kHz	< +-13 kHz
-> mod_set_sig 0 0 0	1897.344 MHz	01010101	262 kHz	< +-13 kHz
-> mod_set_sig -2C 0 0	1935.360 MHz	01010101	262 kHz	< +-13 kHz

8) RF IN/OUT power meter frequency response

- Connect RF generator to RF IN/OUT, power = 24 dBm
- Common cmdd settings
 - > sc 0
 - > tc -10
 - > meas_calibrate
 - > mod_exp_power 1B

cmdd setting	frequency	NTP (level)	tolerance
-> mod_rf_combi 18 1000 0 0	1876.608 MHz	24 dBm	< +-1 dB
-> mod_rf_combi 0 1000 0 0	1897.344 MHz	24 dBm	< +-1 dB
-> mod_rf_combi -2C 1000 0 0	1935.360 MHz	24 dBm	< +-1 dB

CTS60**Performance Test**

9) RF IN/OUT power meter dynamic

- Connect RF generator to RF IN/OUT, power = 26 to -30 dBm
- Common cmd settings
 - > sc 0
 - > tc -10
 - > meas_calibrate
 - > mod_exp_power 1B

cmd setting	frequency	NTP	tolerance
-> mod_rf_combi 0 1000 0 0	1897.344 MHz	26 dBm	< +-1 dB
-> mod_rf_combi 0 1000 0 0	1897.344 MHz	24 dBm	< +-1 dB
-> mod_rf_combi 0 1000 0 0	1897.344 MHz	22 dBm	< +-1 dB
-> mod_rf_combi 0 1000 0 0	1897.344 MHz	20 dBm	< +-1 dB
-> mod_rf_combi 0 1000 0 0	1897.344 MHz	10 dBm	< +-1 dB
-> mod_rf_combi 0 1000 0 0	1897.344 MHz	0 dBm	< +-2 dB
-> mod_rf_combi 0 1000 0 0	1897.344 MHz	-10 dBm	< +-2 dB
-> mod_rf_combi 0 1000 0 0	1897.344 MHz	-20 dBm	< +-2 dB
-> mod_rf_combi 0 1000 0 0	1897.344 MHz	-30 dBm	< +-2 dB
-> mod_rf_combi 18 1000 0 0	1876.608 MHz	-30 dBm	< +-2 dB
-> mod_rf_combi -2C 1000 0 0	1935.360 MHz	-30 dBm	< +-2 dB
-> mod_rf_combi 0 1000 0 0	power off	noise floor	< -38 dBm
-> mod_rf_combi 18 1000 0 0	power off	noise floor	< -38 dBm
-> mod_rf_combi -2C 1000 0 0	power off	noise floor	< -38 dBm

10) RF IN 2 DECT power meter frequency response

- Connect RF generator to RF IN 2 DECT, power = -35 dBm
- Common cmd settings
 - > sc 1
 - > tc -10
 - > meas_calibrate
 - > mod_exp_power 5

cmd setting	frequency	NTP (level)	tolerance
-> mod_rf_combi 18 1000 0 0	1876.608 MHz	-35 dBm	< +-2 dB
-> mod_rf_combi 0 1000 0 0	1897.344 MHz	-35 dBm	< +-2 dB
-> mod_rf_combi -2C 1000 0 0	1935.360 MHz	-35 dBm	< +-2 dB

Performance Test**CTS60**

11) RF IN 2 DECT power meter dynamic

- Connect RF generator to RF IN 2 DECT, power = -35 to -55 dBm
- Common cmdd settings
 - > sc 1
 - > tc -10
 - > meas_calibrate
 - > mod_exp_power 5

cmdd setting	frequency	NTP	tolerance
-> mod_rf_combi 0 1000 0 0	1897.344 MHz	-35 dBm	< +-2 dB
-> mod_rf_combi 0 1000 0 0	1897.344 MHz	-40 dBm	< +-2 dB
-> mod_rf_combi 0 1000 0 0	1897.344 MHz	-50 dBm	< +-2 dB
-> mod_rf_combi 0 1000 0 0	1897.344 MHz	-55 dBm	< +-2.5 dB
-> mod_rf_combi 18 1000 0 0	1876.608 MHz	-55 dBm	< +-2.5 dB
-> mod_rf_combi -2C 1000 0 0	1935.360 MHz	-55 dBm	< +-2.5 dB
-> mod_rf_combi 0 1000 0 0	power off	noise floor	< -80 dBm
-> mod_rf_combi 18 1000 0 0	power off	noise floor	< -80 dBm
-> mod_rf_combi -2C 1000 0 0	power off	noise floor	< -80 dBm

12) RF IN/OUT FM modulation meter

- Connect RF generator to RF IN/OUT, power = 24 to -30 dBm, FM = on, AF = 10 kHz
- Common cmdd settings
 - > sc 0
 - > tc -10
 - > meas_calibrate
 - > mod_exp_power 1B

cmdd setting	frequency	level, FM deviation	MAXMODU:	MINMODU:	tolerance
-> mod_rf_combi 0 1000 0 0	1897.344 MHz	24 dBm, 400 kHz	+ 405 kHz	-405 kHz	< +- 20 kHz
-> mod_rf_combi 0 1000 0 0	1897.344 MHz	24 dBm, 300 kHz	+ 305 kHz	-305 kHz	< +- 15 kHz
-> mod_rf_combi 0 1000 0 0	1897.344 MHz	24 dBm, 200 kHz	+ 205 kHz	-205 kHz	< +- 10 kHz
-> mod_rf_combi 0 1000 0 0	1897.344 MHz	24 dBm, 100 kHz	+ 105 kHz	-105 kHz	< +- 5 kHz
-> mod_rf_combi 0 1000 0 0	1897.344 MHz	15 dBm, 0 kHz	+ 0 kHz	-0 kHz	< +- 5 kHz
-> mod_rf_combi 0 1000 0 0	1897.344 MHz	5 dBm, 0 kHz	+ 0 kHz	-0 kHz	< +- 15 kHz

13) RF IN 2 DECT modulation meter

- Connect RF generator to RF IN 2 DECT, power = -35 to -51 dBm, FM = on, AF = 10 kHz
- Common cmdd settings
 - > sc 1
 - > tc -10
 - > meas_calibrate
 - > mod_exp_power 5

cmdd setting	frequency	level, FM deviation	MAXMODU:	MINMODU:	tolerance
-> mod_rf_combi 0 1000 0 0	1897.344 MHz	-35 dBm, 450 kHz	+ 455 kHz	-455 kHz	< +- 22 kHz
-> mod_rf_combi 0 1000 0 0	1897.344 MHz	-35 dBm, 300 kHz	+ 305 kHz	-305 kHz	< +- 15 kHz
-> mod_rf_combi 0 1000 0 0	1897.344 MHz	-35 dBm, 200 kHz	+ 205 kHz	-205 kHz	< +- 10 kHz
-> mod_rf_combi 0 1000 0 0	1897.344 MHz	-35 dBm, 100 kHz	+ 105 kHz	-105 kHz	< +- 5 kHz
-> mod_rf_combi 0 1000 0 0	1897.344 MHz	-40 dBm, 0 kHz	+ 0 kHz	-0 kHz	< +- 5 kHz
-> mod_rf_combi 0 1000 0 0	1897.344 MHz	-55 dBm, 0 kHz	+ 0 kHz	-0 kHz	< +- 15 kHz

CTS60**Performance Test**

14) Modulation meter: frequency offset

- Connect RF generator to RF IN/OUT, power = 24 dBm, FM = on, AF =10 kHz
- Common cmdd settings
 - > sc 0
 - > tc -10
 - > mod_exp_power 1B

cmdd setting	frequency	level, FM deviation	FREQ OFFS	tolerance
-> meas_calibrate -> mod_rf_combi 0 1000 0 0	1897.344 MHz	24 dBm, 450 kHz	0 kHz	< +- 3 kHz
-> meas_calibrate -> mod_rf_combi 0 1000 0 0	1897.344 MHz	24 dBm, 0 kHz	0 kHz	< +- 3 kHz

11 Module Test

In this mode, measurements on modules or DECT systems can be performed without call setup and signalling.

11.1 Adding Custom Mod Type Settings

From within the main configuration selection menu “Config – Select”, there is provision to define a number of different user defined Module Test Types. To configure the list of currently available Module Test Types, select “Module Test Type” from the list within the “Config – Select” menu.

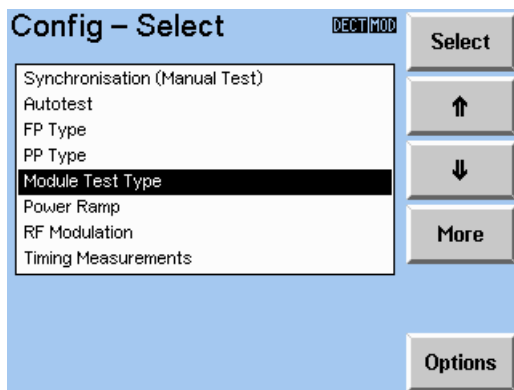

The following menu is then displayed which allows new Mod Test types to be inserted, deleted and edited as required. The selected entry will be used as the starting configuration on entry into Module Test.

There will always be at least one entry present in the list.

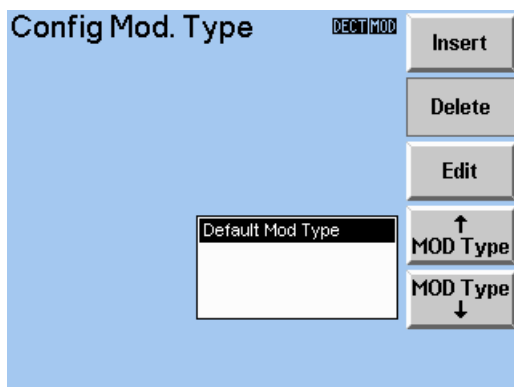

To insert a new entry, press the “Insert” softkey. Similarly, to select an entry for editing, press the “Edit” softkey to preload each field with the corresponding settings that relate to the selected “Module Test Type” .

If a new entry is added, or an existing entry is edited, then the following menu will be displayed.

Menu Ed.Mod.Test Type

This menu allows RF Signal Generator Settings in addition to external input and output attenuation settings to be defined and associated against a particular “Module Test Type” entry. The settings for a particular entry can be used at a later stage when Module Test is activated.

Any known attenuation settings that apply to the defined Mod Type should be defined at this stage. Input and output attenuation settings can be associated with both RF connectors on an individual basis. The fields relating to the RF Signal Generator setup within this menu will be discussed in more detail later in this chapter.

11.2 Starting Module Test

Selecting DECT Module Test from the home menu, by pressing the “Start” softkey will display the following menu. This is the basic starting menu for Module Test and allows some configuration settings to be set prior to the activation of Module Test.

Menu Module Test

The “Burst Analysis” menu can be activated by pressing the “Start” softkey.

The front panel RF connector that is to be used with the device under test (DUT) can be set by pressing the “RF Con” softkey.

Any custom input and output attenuation values associated with the individual RF Connector in use, can be activated or deactivated using the “Coupler” softkey.

The user defined Module Test Type that will form the basis of the configuration data used for initialising the Signal RF Generator in addition to any connector attenuation settings described above, can be selected by traversing the list. The selected entry within the list will become the active configuration when Module Test is started.

General Configuration information for Module Test can be displayed by pressing the “Config” softkey. The following menu is then displayed.

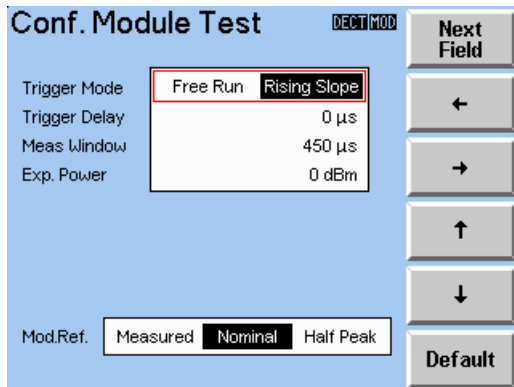

Menu Conf. Module Test

Configuration information can be modified by selecting the desired field with the “Next Field” softkey and editing its value.

The following fields are available for modification:

Trigger Mode

- Free Run. The measurement is restarted again without any trigger condition being present.
- Rising Slope. The measurement is started with rising power as the trigger event.

Trigger Delay

Setting of time values for the measurement delay after the trigger event from 0 to 10 ms in steps of 1 μ s. If the trigger mode is set to “Free Run”, then the value set for “Trigger Delay” is irrelevant. “Trigger Delay” also allows displaying the rising edge of a periodical signal triggered with the condition “Rising Slope”.

Meas. Window

Setting of discrete values between 25 μ s and 1000 μ s for the measurement window.

Exp Power

Setting of the maximum expected power between -10 dBm and 30 dBm in steps of 1 dB for fully utilising the dynamic range of the test receiver of the CTS60.

Note:

If a value below the power of the measured signal is selected, the measured NTP value is not correct.

Mod.Ref

The reference frequency against which the modulation is measured can be selected. The values are:

- Measured. The mean frequency of the measured signal. This mode is also used in manual test.
- Nominal. The exact centre frequency of the carrier, as selected by the user.
- Half Peak. The mid-point between the measured minimum and maximum measured peaks.

The default value is Measured.

11.3 Menu Burst Analysis

In this menu, a combined power/modulation measurement can be performed for investigating transmitter units. The time range for the measurements is determined by the parameters Meas. Window (time window), Trigger Delay (delay of the measurement after the trigger event) and Trigger Mode (selected trigger mode).

Burst Analysis DECT MOD

MOD Type
Default Mod Type

Input Att 0.0 dB

Trigger Mode
Free Run

Trigger Delay
0 μs

Exp. Power
24 dBm

RF Channel
0.0

Mod.Ref. Measured
Meas Window 350 μs

NTP - 49.0 dBm
Freq. Offset + 139 kHz
Max.Pos.Mod + 343 kHz
Max.Neg.Mod - 655 kHz

Frequency
1897.344 MHz

Power
RF Mod
RF Gen
Exp Power
RF Chan
Config

Menu Burst Analysis

The following measured values are displayed:

- NTP Average power for selected measurement window in dBm. Since the average power does not correspond to the average of the dBm values (logarithm), the high power values are preferably considered in an intelligent averaging procedure.
- Freq. Offset This value is obtained as the average of the demodulated signal in the measurement window. If the number of modulated "zeroes" and "ones" is the same (eg with data pattern "010101"), the measured value corresponds to the frequency offset.
- Max. Pos./Neg.Mod. The positive and negative peak values of the demodulated signal compared with the frequency offset. The measurement of the maximum positive and negative modulation requires a signal with an even distribution of "zeroes" and "ones" in the measurement window. Moreover, the values set for the external attenuation are displayed in the menu.

The following softkeys are present on this menu and will now be described.

Power

By pressing this softkey, the power measurement is started as a function of time. The menu changes to the display for this measurement.

RF Mod

By pressing this softkey, the modulation measurement is started within the Module Test. The menu changes to the display for this measurement.

RF Gen

By pressing this softkey the RF Signal Generator menu for investigating receive units will be displayed.

Exp Power

Setting of the maximum expected power between -10 dBm and 30 dBm in steps of 1 dB for fully utilising the dynamic range of the test receiver of the CTS60.

Note:

If a value below the power of the measured signal is selected, the measured NTP value is not correct.

RF Chan

Input of the channel number of the signal to be received. Channel numbers between -3 and 12 at half the DECT channel spacing (864 kHz) are possible.

Config

Pressing the "Config" softkey allows some of the static configuration information displayed on this menu to be modified. The modification of this configuration information is described in section 11.1.

The following static configuration information is displayed to which the following explanations apply.

Input. Att.

The RF input connector correction value for external path attenuation currently in use, is displayed in this field.

Trigger Mode

- Free Run. No trigger condition is currently present.
- Rising Slope. The rising power is the current trigger event.

Trigger Delay

This is the measurement delay after the trigger event from 0 to 10 ms in steps of 1 μ s that is currently in use. If the trigger mode is set to "Free Run", then the value set for "Trigger Delay" is irrelevant. "Trigger Delay" can also be used to display the rising edge of a periodical signal triggered with the condition "Rising Slope".

Meas. Window

The currently selected measurement window of discrete values between 25 μ s and 1000 μ s

Mod.Ref

The current reference frequency against which the modulation is measured. The values are:

- Measured. The mean frequency of the measured signal. This mode is also used in manual test.
- Nominal. The exact centre frequency of the carrier, as selected by the user.
- Half Peak. The mid-point between the measured minimum and maximum measured peaks.

11.4 Menu Power vs. Time

In this menu, the power ramp versus time can be displayed. This type of measurement, too, can be used for testing transmitter units without requiring a call to be set up. The time range for the measurements is determined by the parameters “Meas. Window” (time window), “Trigger Delay” (delay of the measurement after the trigger event) and “Trigger Mode” (selected trigger mode).

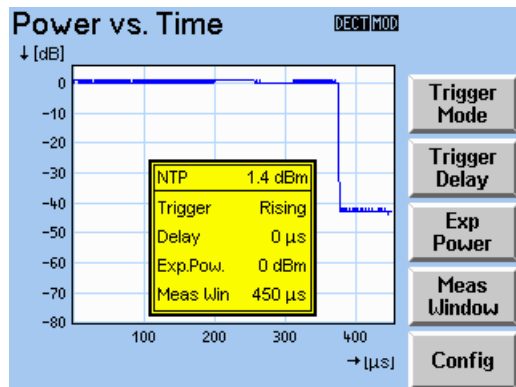

Menu Power vs. Time

The following softkeys are available and their current settings are displayed in the yellow box.

Trigger Mode

Selection of one of the following trigger modes:

- Free Run
The measurement is restarted again without any trigger condition being present.
- Rising Slope
The measurement is started with rising power as the trigger event.

Trigger Delay

Setting of time values for the measurement delay after the trigger event from 0 to 10 ms in steps of 1 μs. In the trigger mode “Free Run”, the value set for “Trigger Delay” is irrelevant. “Trigger Delay” also allows displaying the rising edge of a periodical signal triggered with the condition “Rising Slope”.

Exp.Power

Setting of the maximum expected power between -10 dBm and 30 dBm in steps of 1 dB for fully utilising the dynamic range of the test receiver of the CTS60.

Note:

If a value below the power of the measured signal is selected, the measured curve is not correct.

Meas.Window

Setting of discrete values between 25 μs and 1000 μs for the measurement window. The selected value considerably influences the repetition rate of the measurement.

Config

Pressing the “Config” softkey enters the general Conf. Module Test menu. The modification of this configuration information is described in section 11.1.

11.5 Menu RF - Modulation

In this menu, the demodulated signal versus time can be displayed. This type of measurement, too, can be used for testing transmitter units without requiring a call to be set up. The time range for the measurements is determined by the parameters "Meas. Window" (time window), "Trigger Delay" (delay of the measurement after the trigger event) and "Trigger Mode" (selected trigger mode).

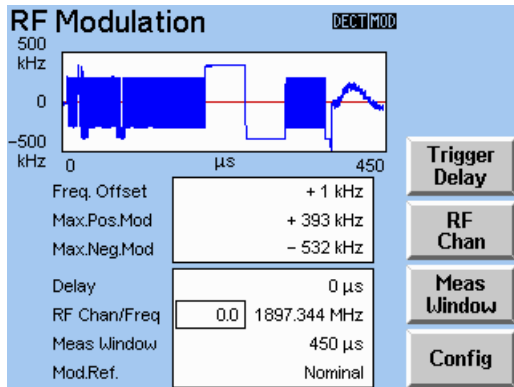

Menu RF - Modulation

The following measured values are displaced in addition to the measurement curve:

- **Freq.Offset** This value is obtained as the average of the demodulated signal in the measurement window. To measure the frequency offset, a signal with an equal number of "zeroes" and "ones" (eg "010101") is required.
- **Max. Pos./Neg.Mod.** The positive and negative peak values of the demodulated signal compared with the frequency offset. To measure the maximum positive and negative modulation, a signal with an even distribution of "zeroes" and "ones" in the measurement window is required.

The following static configuration information displayed and can be modified by the appropriate softkey.

Delay

This is the measurement delay after the trigger event from 0 to 10 ms in steps of 1 μs that is currently in use. If the trigger mode is set to "Free Run", then the value set for "Trigger Delay" is irrelevant. "Trigger Delay" can also be used to display the rising edge of a periodical signal triggered with the condition "Rising Slope".

RF Chan/ Freq

The current frequency and associated channel number of the input signal to be received. Channel numbers between -3 and 12 at half the DECT channel spacing (864 kHz) are possible.

Meas.Window

The currently selected measurement window of discrete values between 25 μs and 1000 μs

Mod.Ref

The current reference frequency against which the modulation is measured. The values are:

- Measured. The mean frequency of the measured signal. This mode is also used in manual test.
- Nominal. The exact centre frequency of the carrier, as selected by the user.
- Half Peak. The mid-point between the measured minimum and maximum measured peaks.

The following softkeys are present on this menu and will now be described.

Trigger Delay

Setting of time values for the measurement delay after the trigger event from 0 to 10 ms in steps of 1 μ s. In the trigger mode "Free Run", the value set for "Trigger Delay" is irrelevant. "Trigger Delay" also allows displaying the rising edge of a periodical signal triggered with the condition "Rising Slope".

RF Chan

Input of the channel number of the signal to be received. Channel numbers between -3 and 12 at half the DECT channel spacing (864 kHz) are possible.

Meas. Window

Setting of discrete values between 25 μ s and 1000 μ s for the measurement window.

Config

Pressing the "Config" softkey allows some of the static configuration information displayed on this menu to be modified. The modification of this configuration information is described in section 11.1.

11.6 Menu RF Signal Gen.

Selecting this menu automatically activates RF Signal Generator output within the CTS hardware. When the menu is exited from, then the RF Generator output is automatically deactivated.

The initial settings used for the RF Generator are taken from the selected MOD Type. The generator output can be modified from within this menu, by changing various settings, but this will not overwrite the settings for the currently selected MOD Type. Any changes made to the settings displayed on this menu will be indicated by the selection of "(modified)" being present in the "MOD Type" field.

Menu RF Signal Gen.

The following fields can be selected for modification using the "Next Field" softkey. Any modifications will have an immediate effect on the RF Generator output.

RF Level

Setting of the transmit power between -40 dBm and -100 dBm (referred to RF IN/OUT) in steps of 0.1 dB.

RF Chan/ Freq

Input of the channel number of the signal to be transmitted. Channel numbers between -3 and 12 at half the DECT channel spacing (864 kHz) are possible. The frequency associated with the selected channel will also be displayed alongside.

Deviation

Input of the modulation deviation between 0 and 510 kHz in multiples of 2 kHz. For an unmodulated signal, 0 must be entered.

Signal

This is the current type of signal modulation in effect. A new type of signal modulation can be selected from the menu "Select Signal Type" by pressing the softkey "Select Signal".

The following menu is then displayed.

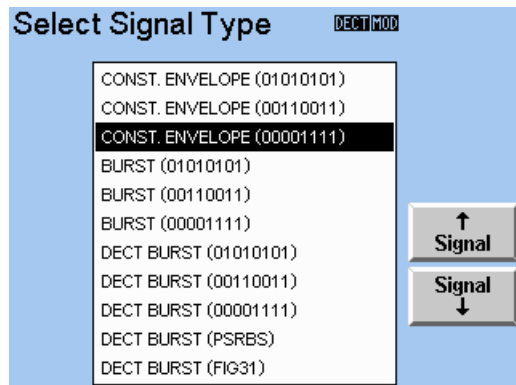

Menu Select Signal Type

Selection of one of the following modulation data patterns is possible from the above menu:

- **CONST.ENVELOP (01010101)**
Non-pulsed signal with a modulation frequency of 576 kHz corresponding to the data sequence "01010101".
- **CONST.ENVELOP (00110011)**
Non-pulsed signal with a modulation frequency of 288 kHz corresponding to the data sequence "00110011".
- **CONST.ENVELOP (00001111)**
Non-pulsed signal with a modulation frequency of 144 kHz corresponding to a data sequence of "00001111".
- **BURST (01010101)**
Pulsed signal with a modulation frequency of 576 kHz corresponding to the data sequence "01010101". The burst lasts approx. 370 μ s and is repeated every 10 ms.
- **BURST (00110011)**
Pulsed signal with a modulation frequency of 288 kHz corresponding to the data sequence "00110011". The burst lasts approx. 370 μ s and is repeated every 10 ms.
- **BURST (00001111)**
Pulsed signal with a modulation frequency of 144 kHz corresponding to the data sequence "00001111". The burst lasts approx. 370 μ s and is repeated every 10 ms.
- **DECT BURST (01010101)**
Burst DECT signal consisting of sync word, preamble, CRC and A and B field modulation with the data sequence "01010101" (packet P32).
- **DECT BURST (00110011)**
Burst DECT signal consisting of sync word, preamble, CRC and A and B field modulation with the data sequence "00110011" (packet P32).
- **DECT BURST (00001111)**
Burst DECT signal consisting of sync word, preamble, CRC and A and B field modulation with the data sequence "00001111" (packet P32).
- **DECT BURST (PSRBS)**
Burst DECT signal consisting of sync word, preamble, CRC and A and B field modulation with random numbers (packet P32).
- **DECT BURST (FIG31)**
Burst DECT signal consisting of sync word, preamble, CRC, A and B field modulation with the data sequence "01010101" and 64 bits of successive "ones" and 64 bits of successive "zeroes" (packet P32).

Serial Interface

The instrument is equipped with a serial interface (RS-232-C) as standard. The 9-pin connector is located at the rear of the instrument. A controller for remote control can be connected via the interface. The connection is effected using a zero modem cable.

For remote control via the serial interface, an important aspect is to be noted:

Some controllers already send characters on the serial interface during booting, causing the instrument to switch to the REMOTE state as soon as it receives these characters (since no explicit addressing is possible with the serial remote control).

Characteristics of the Interface

- serial data transfer
- bidirectional data transfer
- Data transfer rate 9600 baud
- Possible length of connecting cable > 20 m
- Parameters: 9600, N, 8, 1

XON/XOFF handshake

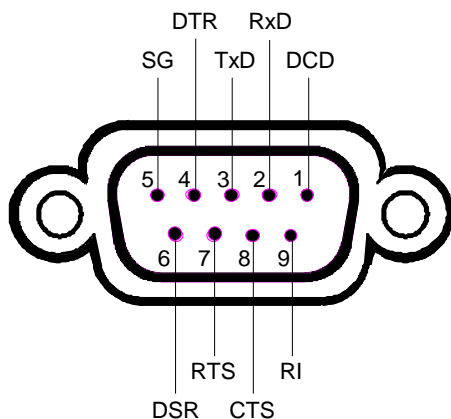

Fig. A3-1 RS232 interface

Designation		Pin (9-pin)	Pin (25-pin)
Data Carrier Detect	DCD	1	8
Receive Data	RxD	2	3
Transmit Data	TxD	3	2
Data Terminal Ready	DTR	4	20
Signal Ground	SG	5	7
Data Set Ready	DSR	6	6
Request To Send	RTS	7	4
Clear To Send	CTS	8	5
Ring Indicator	RI	9	21

Lines

1. Data lines

RxD (receive data) and **TxD** (transmit data)

The transmission is bit-serial in the ASCII code starting with the LSB.

The two lines are necessary as the minimum requirement for a transmission; however, no hardware handshake is possible, but only the XON/XOFF protocol.

2. Control lines

DCD (Data Carrier Detect),
active LOW.

Input; using this signal, the data terminal recognizes that the modem of the remote station receives valid signals with sufficient level. DCD is used to disable the receiver in the data terminal and prevent reading of false data if the modem cannot interpret the signals of the remote station.

DTR (Data Terminal Ready),
active LOW,

Output indicating that the data terminal is ready to receive data.

DSR (Data Set Ready),
active LOW,

Input indicating that the external device is ready to receive data.

RTS (Request To Send),
active LOW.

Output that can be used to indicate the readiness to receive data.

CTS (Clear To Send),
active LOW.

Input used to enable the transmission of data.

RI (Ring Indicator),
active LOW.

Input; RI is used by a modem to indicate that a remote station wants to set up a connection.

Default settings

The serial interface is set to the following values:

Table A3-1 Default setting

Parameter	Setting value
Baud rate	9600 baud
Data bits	8 bits
Stop bits	1 bits
Parity	none

Handshake

Software handshake

In the case of the software handshake, the data transfer is controlled using the two control characters XON / XOFF.

The CTS uses the control character XON to indicate that it is ready to receive data.

If the receive buffer is full, it sends the XOFF character via the interface to the controller. The controller then interrupts the data output until it receives another XON from the CTS.

The controller indicates to the CTS that it is ready to receive data in the same way.

Cable for local controller coupling in the case of software handshake

The connection of the CTS with a controller in the case of software handshake is effected by crossing the data lines. The following wiring diagram applies to a controller with 9-pin or 25-pin configuration.

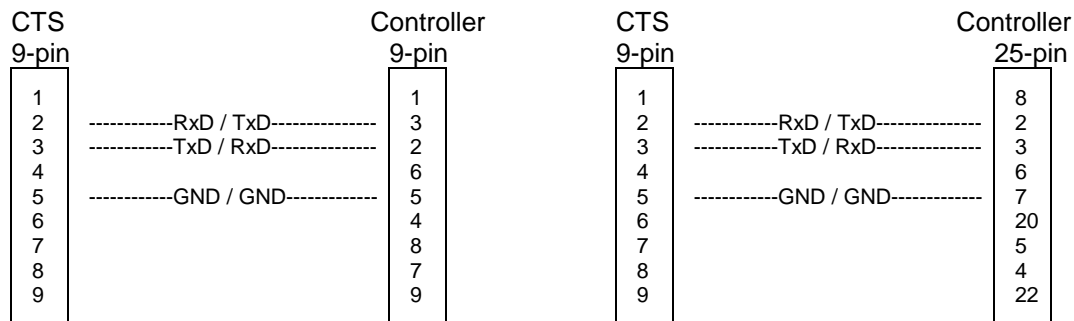

Fig. A3-2 Wiring of the data lines for software handshake

Hardware handshake

In the case of the hardware handshake, the CTS indicates that it is ready to receive data via the lines DTR and RTS. A logic '0' on both lines means "ready" and a logic '1' means "not ready". The RTS line is always active (logic '0') as long as the serial interface is switched on. The DTR line thus controls the readiness of the CTS to receive data.

The readiness of the remote station to receive data is reported to the CTS via the CTS and DSR line. A logic '0' on both lines activates the data output and a logic '1' on both lines stops the data output of the CTS. The data output is effected via the TxD line.

Cable for local controller coupling in the case of hardware handshake

The connection of the CTS to a controller is effected with a so-called zero modem cable. In the case of this cable, the data, control and report lines must be crossed. The following wiring diagram applies to a controller with 9-pin or 25-pin configuration.

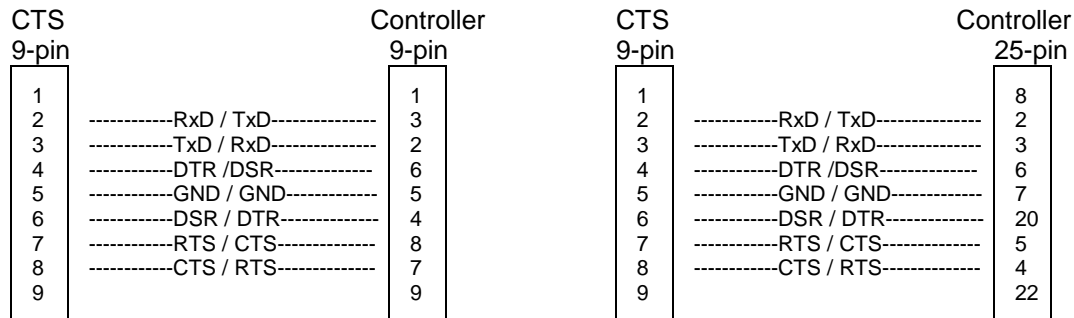

Fig. A3-3 Wiring of the data, control and report lines for hardware handshake

List of Error Messages

The following list contains all error messages for errors occurring in the instrument. The meaning of negative error codes is defined in SCPI, positive error codes mark errors specific of the instrument.

The table contains the error code in the left-hand column. In the right-hand column the error text being entered into the error/event queue or being displayed is printed in bold face. Below the error text, there is an explanation as to the respective error.

SCPI-Specific Error Messages

No Error

Error code	Error text in the case of queue poll Error explanation
0	No error This message is output if the error queue does not contain any entries.

Command Error - Faulty command; sets bit 5 in the ESR register.

Error code	Error text in the case of queue poll Error explanation
-100	Command Error The command is faulty or invalid.
-101	Invalid Character The command contains an invalid sign. Example: A header contains an ampersand, "SOURCE &".
-102	Syntax error The command is invalid. Example: The command contains block data the instrument does not accept.
-103	Invalid separator The command contains an impermissible sign instead of a separator. Example: A semicolon is missing after the command.
-104	Data type error The command contains an invalid value indication. Example: ON is indicated instead of a numeric value for frequency setting.
-105	GET not allowed A Group Execute Trigger (GET) is within a command line.
-108	Parameter not allowed The command contains too many parameters. Example: Command <code>CONFigure:REGen:FREQency</code> permits only one frequency indication.

List of Error Messages/Annex B

CTS60

Continuation: Command Error

Error code	Error text in the case of queue poll Error explanation
-109	Missing parameter The command contains too few parameters. Example: The command <code>CONFigure:RFGen:FREQuency</code> requires a frequency indication.
-111	Header separator error The header contains an impermissible separator. Example: the header is not followed by a "White Space", <code>"*ESE255"</code>
-112	Program mnemonic too long The header contains more than 12 characters.
-113	Undefined header The header is not defined for the instrument. Example: <code>*XYZ</code> is undefined for every instrument.
-114	Header suffix out of range The header contains an impermissible numeric suffix. Example: <code>SOURce3</code> does not exist in the instrument.
-120	Numeric data error The command contains a faulty numeric parameter.
-121	Invalid character in number A number contains an invalid character. Example: An "A" in a decimal number or a "9" in an octal number.
-123	Exponent too large The absolute value of the exponent is greater than 32000.
-124	Too many digits The number includes too many digits.
-128	Numeric data not allowed The command includes a number which is not allowed at this position. Example: The command <code>SOURce:RFGen:SElect</code> requires indication of a text parameter.
-131	Invalid suffix The suffix is invalid for this instrument. Example: <code>nHz</code> is not defined.
-134	Suffix too long The suffix contains more than 12 characters.
-138	Suffix not allowed A suffix is not allowed for this command or at this position of the command. Example: The command <code>*RCL</code> does not permit a suffix to be indicated.
-141	Invalid character data The text parameter either contains an invalid character or it is invalid for this command. Example: write error with parameter indication; <code>SOURce:RFGen:SElect STT1.</code>
-144	Character data too long The text parameter contains more than 12 characters.
-148	Character data not allowed The text parameter is not allowed for this command or at this position of the command. Example: The command <code>*RCL</code> requires a number to be indicated.

Continuation: Command Error

Error code	Error text in the case of queue poll Error explanation
-151	Invalid string data The command contains a faulty string. Example: An END message has been received prior to the terminating apostrophe.
-158	String data not allowed The command contains a valid string at a position which is not allowed. Example: A text parameter is set in quotation marks, <code>SOURce:RFGen:SElect "SETting1"</code>
-161	Invalid block data The command contains faulty block data. Example: An END message was received prior to reception of the expected number of data.
-168	Block data not allowed The command contains valid block data at an impermissible position. Example:
-171	Invalid expression The command contains an invalid mathematical expression. Example: the expression contains mismatching parentheses.
-178	Expression data not allowed The command contains a mathematical expression at an impermissible position. Example:
-180	Macro error A faulty macro has been defined, or an error has occurred during execution of a macro.

Execution Error - Error on execution of a command; sets bit 4 in the ESR register

Error code	Error text in the case of queue poll Error explanation
-200	Execution error Error on execution of the command.
-221	Settings conflict There is a conflict between setting of parameter value and instrument state. Example: External attenuation has been set in a state other than IDLE.
-222	Data out of range The parameter value lies out of the permissible range of the instrument. Example: The command <code>*RCL</code> only permits entries in the range from 0 to 50.
-223	Too much data The command contains too many data. Example: The instrument does not have sufficient storage space.
-241	Hardware missing The command cannot be executed due to missing hardware. Example: An option is not fitted.

List of Error Messages/Annex B**CTS60**

Device Specific Error; sets bit 3 in the ESR register

Error code	Error test in the case of queue poll Error explanation
-300	Device-specific error SM3-specific error not defined in greater detail.
-350	Queue overflow This error code is entered in the queue instead of the actual error code if the queue is full. It indicates that an error has occurred but not been accepted. The queue can accept 5 entries.

Query Error - Error in data request; sets bit 2 in the ESR register

Error code	Error text in the case of queue poll Error explanation
-400	Query error General error occurring when data are requested by a query.
-410	Query INTERRUPTED The query has been interrupted. Example: After a query, the instrument receives new data before the response has been sent completely.
-420	Query UNTERMINATED The query is incomplete. Example: The instrument is addressed as a talker and receives incomplete data.
-430	Query DEADLOCKED The query cannot be processed. Example: The input and output buffers are full, the instrument cannot continue operation.
-440	Query UNTERMINATED after indefinite response A query is in the same command line after a query which requests an indefinite response.

List of CTS60 Remote Control Commands

1. General

States

In the description of the commands, the following abbreviations are used to indicate the permitted states:

IDLE: Initial state of the CTS60; is also achieved by means of PROCEDURE:SELEct[:TEST] NONE.
 DPP: DECT: Portable Part Test
 DFP: DECT: Fixed Part Test
 DCE: DECT: Connection Established
 ALL: All states (IDLE, DPP, DFP, DCE)

The following diagram explains the state transitions:

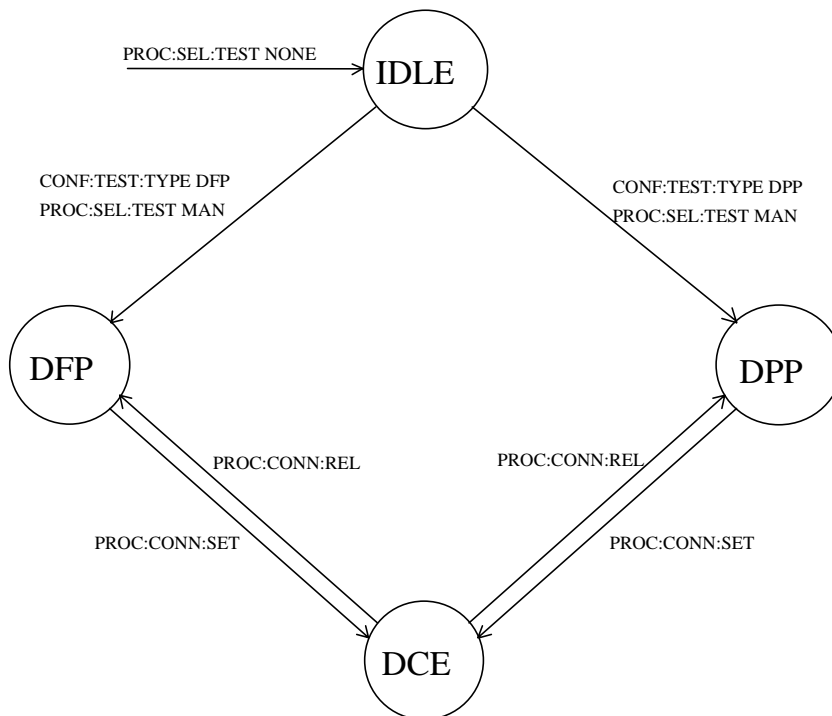

Command Structure

All commands are structured according to the SCPI specification, i.e. the upper-case letters indicate the short form of the command; the CTS60 only accepts abbreviations in this short form (according to SCPI), otherwise the long form is to be used.

Command Parameters

<value> denotes a character string from a list; only list entries are permissible.

<numeric_value> denotes a numeric value; MAXimum or MINimum can also be used unless stated otherwise.

If <numeric_value> has a unit, supplying the unit is optional. If no unit is supplied the Base Unit will be used. Unless stated otherwise the value is always returned in the Base Unit.

Supported Units

Unitgroup	Units	Base Unit
Decibel	DB	DB
Decibel per 1000V	DBM	DBM
Hertz	HZ, KHZ, MHZ	HZ
Second	S, MS, US	S
Hertz/Second	HZ/S, KHZ/MS	HZ/S
Watt	W, MW, UW, NW	W
Percent	PCT [1e-2], PML [1e-3], PPM [1e-6]	PCT <=> %

Error Recovery

If the value is invalid INV is returned instead of the value.

If the CTS60 is not in the right state to be able to carry out the command, SCPI error -221, "Settings conflict" is generated. No value is returned in the case of queries.

The permitted state for a command is indicated in the following table in the column "state".

RESET Values

Unless otherwise specified, the values given in the column "Default:" are set on RESET (*RST) of the CTS60.

2. Idle-Menu

Testtype

Syntax:	CONFigure:TEST[:TYPE] <value>		
Value range:	DectFP DectPP		Default: DPP
State:	Set: IDLE Query: ALL	Option: none	With query

Testmode

Syntax:	PROCedure:SElect[:TEST] <value>		
Value range:	NONE MANual MOD BAN RFG	 	No test mode (initial state) DECT-Test DECT Module Test DECT Burst Analysis DECT RF Signal Generator
State:	(NONE): ALL (MANual): IDLE (MODule): IDLE (BANalysis): MOD (RFGenerator): BAN	Option: none	With query
		Note: Setting of NONE followed by a query will return IDLE. Use the command STATus:DEvice? to query the state of the CTS60.	

Gap Mode

Syntax:	CONFigure:GAP:MODE<value>		
Value range:	OFF ON		Default: OFF
State:	Set: IDLE Query: ALL	Option: none	With query

3. Menu: Signalling PP-Test

Radio Fixed Part Identity

Syntax:	CONFigure:PP:RFPI <string>		
Value range:	10 digits in hex format	Default: "0000000000"	
State:	Set: IDLE, DPP Query: ALL	Option: none	With query

Dummy Slot for PP Test

Syntax:	CONFigure:PP:DUMMy:SLOT <numeric_value>		
Value range:	0 ... 11	Default: 0	
State:	Set: IDLE, DPP Query: ALL	Option: none	With query Note: The dummy slot must be different from the traffic slot by at least 2 slots.

Dummy Carrier for PP Test

Syntax:	CONFigure:PP:DUMMy:CARRier <numeric_value>		
Value range:	0 ... 9	Default: 0	
State:	Set: IDLE, DPP Query: ALL	Option: none	With query

Dummy Mode for PP Test

Syntax:	CONFigure:PP:DUMMy:MODE <value>		
Value range:	ON OFF	Default: OFF	
State:	Set: IDLE, DPP Query: ALL	Option: none	With query

Traffic Slot for PP Test

Syntax:	CONFigure:PP:TRAFfic:SLOT <numeric_value>		
Value range:	0 ... 11	Default: 2	
State:	Set: IDLE, DPP Query: ALL	Option: none	With query Note: The dummy slot must be different from the traffic slot by at least 2 slots.

CTS60

Remote Control/Annex C

Traffic Carrier for PP Test

Syntax:	CONFigure:PP:TRAFfic:CARRier <numeric_value>		
Value range:	0 ...9	Default: 0	
State:	Set: IDLE, DPP Query: ALL	Option: none	With query

RF Level

Syntax:	CONFigure:PP:RF:LEVel <numeric_value>		
Value range:	-100.0 dBm to -40.0 dBm (in steps of 0.1 dBm)	Default: -73.0 dBm	
State:	Set: IDLE, DPP Query: ALL	Option: none	With query

Carrier Offset for PP Test

Syntax:	CONFigure:PP:CARRier:OFFSet <numeric_value>		
Value range:	-23 ... +3 (in steps of 1)	Default: 0	
State:	Set: IDLE, DPP Query: ALL	Option: none	With query

Signalling-Mode

Syntax:	CONFigure:PP:SIGNalling:MODE <value>		
Value range:	NORMal LOOPback ECHo	Default: LOOP	
State:	Set: IDLE, DPP Query: ALL	Option: none	With query

PP IPUI (International Portable User Identifier)

Syntax:	CONFigure:GAP:PP:IPUI<string>		
Value range:	10 digits in hex format	Default: „0000000000,“	
State:	Set: IDLE, DPP Query: ALL	Option: none	With query Note: only available in Gap Mode

PP PARK (Private Access Rights Key)

Syntax:	CONFigure:GAP:PP:PARK<string>		
Value range:	10 digits in hex format	Default: „0000000000,“	
State:	Set: IDLE, DPP Query: ALL	Option: none	With query Note: only available in Gap Mode

PP GAP Lock State

Syntax:	SENSe:PP:SIGNalling:STATe?		
Value range:	LOCK UNL SBSC_READY SBSC SBSC_ABORTED SBSC_FAILED SBSC_SUCCEEDED	State: LOCKED State: UNLOCKED State: Subscription Ready State: Subscribing State: Subscription aborted State: Subscription failed State: Subscription succeeded	Default:
State: DPP	Option: GAP	Only query	Note:

PP GAP Subscription

Syntax:	PROCedure:GAP:PP:SUBScription		
State: DPP	Option: GAP	No query	Note: the timeout interval for this command is approximately 20 sec

PP GAP Configure Access Code

Syntax:	CONFigure:GAP:PP:AC?		
Value range:	<string> 8 digits in hex format (from 00000000 to FFFFFFFF)	Default: 0000FFFF	
State: DPP	Option: GAP	With query	Note:

4. Menu: Signalling FP-Test

Antenna of the Fix-Part

Syntax:	CONFigure:FP:ANTenna <numeric_value>		
Value range:	0 ... 7	Default: 0	
State:	Set: IDLE, DFP Query: ALL	Option: none	With query

Radio Fixed Part Identity

Syntax:	CONFigure:FP:RFPI <string>		
Value range:	10 digits in hex format	Default: "0000000000"	
State:	Set: IDLE, DFP Query: ALL	Option: none	With query

Portable Part MAC Identity

Syntax:	CONFigure:FP:PMID <string>		
Value range:	5 digits in hex format	Default: "EBE8D"	
State:	Set: IDLE, DFP Query: ALL	Option: none	With query Note: The default value is different from the CMD60 default value which is "00000"

Traffic Slot for FP Test

Syntax:	CONFigure:FP:TRAFfic:SLOT <numeric_value>		
Value range:	0 ... 11	Default: 0	
State:	Set: IDLE, DFP Query: ALL	Option: none	With query

Traffic Carrier for FP Test

Syntax:	CONFigure:FP:TRAFfic:CARRier <numeric_value>		
Value range:	0 ... 9	Default: 0	
State:	Set: IDLE, DFP Query: ALL	Option: none	With query

Carrier Offset for FP Test

Syntax:	CONFigure:FP:CARRier:OFFSet <numeric_value>		
Value range:	-3.0 ... +3.0 (in steps of 0.5)	Default: 0.0	
State:	Set: IDLE, DFP Query: ALL	Option: none	With query

RF Level

Syntax:	CONFigure:FP:RF:LEVel <numeric_value>		
Value range:	-100.0 dBm to -40.0 dBm (in steps of 0.1 dBm)	Default: -73.0 dBm	
State:	Set: IDLE, DFP Query: ALL	Option: none	With query

Signalling-Mode

Syntax:	CONFigure:FP:SIGNalling:MODE <value>		
Value range:	NORMal LOOPback ECHo	Default: LOOP	
State:	Set: IDLE, DFP Query: ALL	Option: none	With query

Lock State

Syntax:	SENSe:SIGNalling:STATe?		
Value range:	LOCK UNL	State: LOCKED State: UNLOCKED	
State:	DFP	Option: none	Only query

Dummy Carrier of the DUT

Syntax:	SENSe:DETEcted:DUMMy:CARRier?		
Value range:	<value>		
State:	DFP, DCE	Option: none	Only query

Dummy Slot of the DUT

Syntax:	SENSe:DETEcted:DUMMy:SLOT?		
Value range:	<value>		
State:	DFP, DCE	Option: none	Only query

CTS60

Remote Control/Annex C

RFPI of the DUT

Syntax:	SENSe:DETEcted:RFPI?		
Value range:	<string> (10 digits in hex format)		
State: DFP, DCE	Option: none	Only query	

FP IPUI (International Portable User Identifier)

Syntax:	CONFigure:GAP:FP:IPUI<string>		
Value range:	10 digits in hex format	Default: „0000000000,„	
State: Set: IDLE, DFP Query: ALL	Option: none	With query	Note: only available in Gap Mode

FP PARK (Private Access Rights Key)

Syntax:	CONFigure:GAP:FP:PARK<string>		
Value range:	10 digits in hex format	Default: „0000000000,„	
State: Set: IDLE, DFP Query: ALL	Option: none	With query	Note: only available in Gap Mode

DETECTED PARK (Private Access Rights Key) of the FP DUT

Syntax:	SENSe:DETEcted:PARK?		
Value range:	<string> (10 digits in hex format)		
State: DFP, DCE	Option: none	Only query	Note: only available in Gap Mode

FP GAP Lock State

Syntax:	SENSe:FP:SIGNalling:STATe?		
Value range:	LOCK UNL SBSC_READY SBSC SBSC_ABORTED SBSC_FAILED SBSC_SUCCEDED	State: LOCKED State: UNLOCKED State: Subscription Ready State: Subscribing State: Subscription aborted State: Subscription failed State: Subscription succeeded	Default:
State: DFP	Option: GAP	Only query	Note:

FP GAP Subscription

Syntax:	PROCedure:GAP:FP:SUBScription		
State: DFP	Option: GAP	No query	Note: the timeout interval for this command is approximately 20 sec

FP GAP Configure Access Code

Syntax:	CONFigure:GAP:FP:AC?		
Value range:	<string> 8 digits in hex format (from 00000000 to FFFFFFFF)	Default: 0000FFFF	
State: DFP	Option: GAP	With query	Note:

5. Menus: Signalling PP-Test and Signalling FP-Test

Setup Connection

Syntax:	PROCedure:CONNection:SETup		
State: DFP, DPP	Option: none	No query	Note: Use the command STATus:DEVIce? to check if the connection was established

6. Menu: Connection Established

Connection Release

Syntax:	PROCedure:CONNection:RELease		
State: DCE	Option: none	No query	Note: The CTS60 changes to state DFP or DPP

PMID of the DUT

Syntax:	SENSe:DETEcted:PMID?		
Value range:	<string> (5 digits in hex format)		
State: DCE	Option: none	Only query	Note: For PP only

7. Menu: Power Ramp

Pass/Fail verdict for Normal Transmit Power (NTP)

Syntax:	CALCulate:LIMit:POWer:TRANsmit:TOLerance:MATCHing?		
Return:	(MATC NMAT INV)		
State: DCE	Option: none	Only query	Note: Returns the result of the last measurement (eg. READ:POWer:TRANsmit NORMal?), (N10), (N12)

Pass/Fail verdict for Power-Ramp

Syntax:	CALCulate:LIMit:POWer:TRANsmit[:TEMPlate]:MATCHing?		
Return:	MATC		signal matches template
	NMAT		signal does not match template
	INV		no measurement result available
State: DCE	Option: none	Only query	Note: Returns the result of the last measurement (N10), (N12)

Normal Transmit Power (NTP)

Syntax: Execute new measurement and signal result	READ[:SCALar]:POWer:TRANsmit:NORMal? READ[:SCALar]:NTP? (refer to Note)		
Only read result	FETCh[:SCALar]:POWer:TRANsmit:NORMal?		
Return:	<value>	(Unit: dBm)	
State: DCE	Option: none	Only query	Note: (N10) Using the command READ[:SCAL]:NTP? there are no checks as to whether the measured power matches the power/time-template; therefore CALC:LIM:POW:TRAN[:TEMP]:MATC? will always return INV in this case.

Selection of a part of the burst power array

Syntax:	CONFigure:POWer:TRANsmit:OUTPut:RANGe <numeric_value> [, <numeric_value>]		
Value range:	start position:	-38 ... 462	(in steps of 1/6)
	number of measurement values:	1 1000	Default: --38 1000
State: ALL	Option: none	With query	Note: <ul style="list-style-type: none"> This settings are valid until the device is powered off. They are unaffected by reset (*RST). If the wanted number of measurement values after the start position exceeds the number of available values, it will be automatically corrected to the maximum possible number of values Caution: This value remains active until it is explicitly changed. <ul style="list-style-type: none"> Refer also to command READ:ARRay:POWer:TRANsmit.

Power Ramp Signal

Syntax: Execute new measurement and signal result	READ:ARRay:POWer:TRANsmit?		
Only read result	FETCh:ARRay:POWer:TRANsmit?		
Return:	<Value> {, <Value>}		(Unit: dB/100)
State: DCE	Option: none	Only query	Note: The CTS60 uses the unit dB/100 which differs from the CMD60 which uses dB. The CTS60 returns only 1000 values at maximum. Use the command CONFigure:POWer:TRANsmit:OUTPut:RANGe to select the range, (N10)

8. Menu: RF-Modulation

Pass /Fail Verdict for Frequency Offset

Syntax:	CALCulate:LIMit:FREQuency:OFFSet:TOLerance:MATChing?		
Return:	(MATC NMAT INV)		
State: DCE	Option: none	Only query	Note: Returns the result of the last measurement (eg. READ:FREQuency:OFFSet?), (N10), (N12)

Frequency Offset

Syntax: Execute new measurement and signal result	READ[:SCALar]:FREQuency:OFFSet?		
Only read result	FETCh[:SCALar]:FREQuency:OFFSet?		
Return:	<Value> (Unit: Hz)		
State: DCE	Option: none	Only query	

Pass/Fail Verdict for B-Field Modulation

Syntax:	CALCulate:LIMit:BFieLd:TOLerance:MATChing?		
Return:	(MATC NMAT INV) , (MATC. NMAT INV)		
State: DCE	Option: none	Only query	Note: Returns the result of the last measurement,the first value is the positive value, the second is the negative one, (N10), (N12)

B-Field Modulation

Syntax: Execute new measurement and signal result	READ[:SCALar]:BFieLd?		
Only read result	FETCh[:SCALar]:BFieLd?		
Return:	<Value>, <Value> (Unit: Hz)		
State: DCE	Option: none	Only query	Note: The first value is the positive value, the second is the negative one; (N10)

Pass / Fail verdict for Frequency Drift

Syntax:	CALCulate:LIMit:FREQuency:DRIFt:TOLerance:MATChing?		
Return:	(MATC NMAT INV)		
State: DCE	Option: none	Only query	Note: It's only measured, if signalling mode is set to LOOPback and if data type in B-Field is set to Fig31 or BS55 (otherwise returns INValid) Returns the result of the last measurement (N10), (N12)

Frequency Drift

Syntax: Execute new measurement and signal result Only read result	READ[:SCALar]:FREQuency:DRIFt? FETCh[:SCALar]:FREQuency:DRIFt?		
Return:	<Value> (Unit: Hz/s)		
State: DCE	Option: none	Only query	Note: It's only measured, if signalling mode is set to LOOPback and if data type in B-Field is set to Fig31 or BS55 (otherwise returns INValid) (N10)

The relations between the occurring frequency drift units are $10^6 \frac{\text{Hz}}{\text{s}} = 1 \frac{\text{kHz}}{\text{ms}} = \frac{1}{2.4} \frac{\text{kHz}}{\text{slot}}$.

Frequency Drift (kHz/ms)

Syntax: Execute new measurement and signal result: Only read result:	READ[:SCALar]:FREQuency:DRIFt:MS? FETCh[:SCALar]:FREQuency:DRIFt:MS?		
Return:	<value> (Unit: kHz/ms)		
State: DCE	Option: none	Only query	Note: Frequency drift is only measured if the signalling mode is set to LOOPback and if the data type is set to Fig31 or BS55 (otherwise returns INValid).

Frequency Drift (kHz/slot)

Syntax: Execute new measurement and signal result: Only read result:		READ[:SCALar]:FREQuency:DRIFt:SLOT? FETCh[:SCALar]:FREQuency:DRIFt:SLOT?	
Return:	<value> (Unit: kHz/slot)		
State: DCE	Option: none	Only query	Note: Frequency drift is only measured if the signalling mode is set to LOOPback and if the data type is set to Fig31 or BS55 (otherwise returns INValid).

Transmission of Z-field

Syntax: Execute new measurement and signal result: Only read result:		READ:XZField:MATChing? FETCh:XZField:MATChing?	
Return:	(MATC NMat INV)		
State: DCE	Option: none	Only query	Note: The transmission of Z-field is only measured if the data type is set to PSRBS (otherwise returns INValid). (N10)

FM-Demodulated Signal

Syntax: Execute new measurement and signal result: Only read result		READ:ARRay:FREQuency:DEViation? FETCh:ARRay:FREQuency:DEViation?	
Return:	<Value> {, <Value>} (Unit: kHz)		
State: DCE	Option: none	Only query	Note: Return 3000 values from bit -38 to 462 (6 values per bit), (N10)

9. Menu: Timing

Pass/Fail Verdict for Time Accuracy

Syntax:	CALCulate:LIMit:TIME:ACCuracy:TOLerance:MATCHing?		
Return:	(MATC NMAT INV)		
State: DCE	Option: none	Only query	Note: Returns the result of the last measurement (N10), (N12)

Time Accuracy

Syntax: Execute new measurement and signal result Only read result	READ[:SCALar]:TIME:ACCuracy? FETCh[:SCALar]:TIME:ACCuracy?		
Return:	<Value> (Unit: ppm)		
State: DCE	Option: none	Only query	Note: (N10)

Pass / Fail Verdict for Jitter

Syntax:	CALCulate:LIMit:JITTer:TOLerance:MATCHing?		
Return:	(MATC NMAT INV), (MATC NMAT INV)		
State: DCE	Option: none	Only query	Note: Returns the result of the last measurement, the first value is the positive value, the second is the negative one, (N10), (N12)

Jitter

Syntax: Execute new measurement and signal result Only read result	READ[:SCALar]:JITTer? FETCh[:SCALar]:JITTer?		
Return:	<Value>, <Value> (Unit: sec)		
State: DCE	Option: none	Only query	Note: The first value is the positive value, the second is the negative one, (N10)

Pass / Fail Verdict for Packet Transmission Accuracy of a PP

Syntax:	CALCulate:LIMit:PACKet:DELAy:TOLerance:MATChing?		
Return:	(MATC NMAT INV), (MATC NMAT INV)		
State: DCE (PP test only)	Option: none	Only query	Note: Returns the result of the last measurement, the first value is the result for the minimum, the second is the result for the maximum, (N10), (N12)

Packet Transmission Accuracy of a PP

Syntax: Execute new measurement and signal result Only read result	READ[:SCALar]:PACKet:DELAy? FETCh[:SCALar]:PACKet:DELAy?		
Return:	<Value>, <Value> (Unit: sec)		
State: DCE (PP test only)	Option: none	Only query	Note: The first value is the minimum value, the second is the maximum one, (N10)

10. Menu: Bit Error Rate

RF Level

Syntax:	CONFigure:BER:RF:LEVel <numeric_value>		
Value range:	-100.0 dBm to -40.0 dBm (in steps of 0.1 dBm)		Default: -73.0 dBm
State: DCE	Option: none	With query	

Pass / Fail Verdict for LongTerm BER and FER

Syntax:	CALCulate:LIMit:BER:LTERM:TOLerance:MATCHing?		
Return:	(MATC NMAT INV), (MATC NMAT INV)		
State: DCE	Option: none	Only query	Note: Returns the result of the last measurement; the first value is the BER value, the second one the FER value; (N10), (N12)

LongTerm BER and FER

Syntax: Execute new measurement and signal result Only read result	READ[:SCALar]:BER:LTERM? FETCh[:SCALar]:BER:LTERM?		
Return:	<Value>, <Value> (Unit: BER %, FER %)		
State: DCE	Option: none	Only query	Note: The first value is the BER value, the second one the FER value, (N10)

Enable/disable BER Software Decoding

Syntax:	CONFigure:BER:RF:SWDEcoding?		
Value range:	ON, OFF	Default: OFF	
State: DCE	Option: none	With query	Note:

11. Menu: Signalling PP-Test Configuration

Static System Info

Syntax:	CONFigure:PP:PROTOtype:SYSTem:INFO <string>		
Value range:	12 digits in hex format	Default: "000003FF0000"	
State:	Set: IDLE, DPP Query: ALL	Option: none	With query

Fixed Part Capabilities

Syntax:	CONFigure:PP:PROTOtype:FP:CAPability <string>		
Value range:	12 digits in hex format	Default: "003041108008"	
State:	Set: IDLE, DPP Query: ALL	Option: none	With query

Multiframe Number

Syntax:	CONFigure:PP:PROTOtype:MULTiframe <string>		
Value range:	12 digits in hex format	Default: "006F0F000000"	
State:	Set: IDLE, DPP Query: ALL	Option: none	With query

Q Packet Multiplex Sequence

Syntax:	CONFigure:PP:TABLE:QPACket:SEquence <string>		
Value range:	8 digits out of 0, 3, 6	Default: "03030303"	
State:	Set: IDLE, DPP Query: ALL	Option: none	With query Note: The default value is different from the CMD60 default value which is "03060306"

12. Common Measurement Configuration

Number of bursts

Syntax:	CONFigure:AVERage:BURSt <numeric_value>		
Value range:	1 ... 200	Default: 4	
State: ALL	Option: none	With query	Note: This command applies to Power, Modulation and Timing Measurements

FP Packet Type

Syntax:	CONFigure:FP[:POWer]:PACKet[:TYPe] <value>		
Value range:	P32Z PP32Z	Default: P32Z	
State: ALL	Option: none	With query	Note: The command Syntax is different to the CMD60 This command applies to Power and Modulation Measurements

PP Packet Type

Syntax:	CONFigure:PP[:POWer]:PACKet[:TYPe] <value>		
Value range:	P32Z PP32Z	Default: P32Z	
State: ALL	Option: none	With query	Note: The command Syntax is different to the CMD60 This command applies to Power and Modulation Measurements

13. Menu: Power Ramp Configuration

Reset to Default Values for Power Ramp and NTP

Syntax:	CALCulate:LIMit:POWer:TRANsmit[:TEMPlate]:CLEar		
State: ALL	Option: none	No query	

NTP Tolerance Range

Syntax:	CALCulate:LIMit:POWer:TRANsmit:TEMPlate:TOLerance:LOWer[:DATA] <numeric_value> CALCulate:LIMit:POWer:TRANsmit:TEMPlate:TOLerance:UPPer[:DATA] <numeric_value>		
Value range:	0.0 ... 30.0 dBm (in steps of 0.1dBm)		Default: 20.0 dBm 25.0 dBm
State: ALL	Option: none	With query	Note: LOWer < UPPer must be fulfilled

Tolerance Range for Power-Time-Template

The level designations used in the power time template for the command `CALCulate:LIMit:POWer:TRANsmit[:TEMPlate][:DATA]` can be obtained from the following illustration:

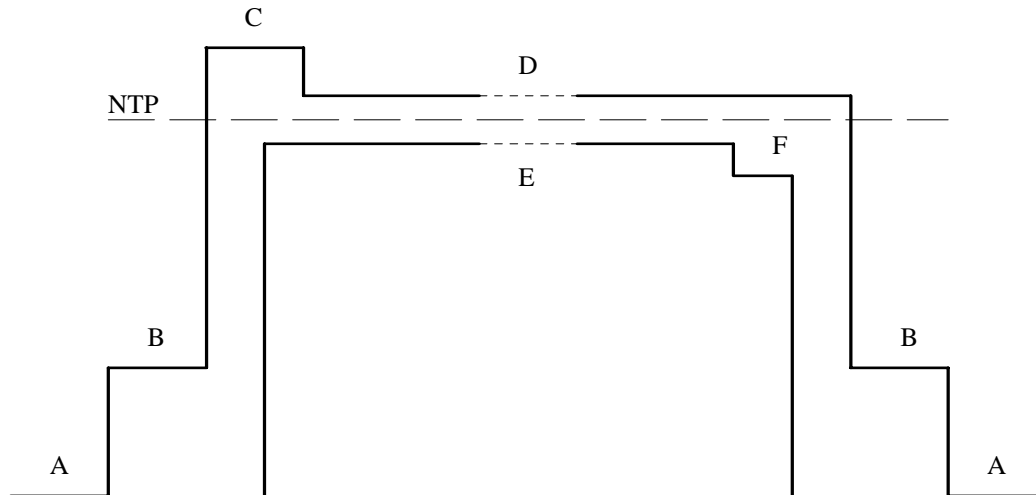

Syntax:	<code>CALCulate:LIMit:POWer:TRANsmit[:TEMPlate][:DATA]</code> <code><numeric_value>, <numeric_value></code> , <code><numeric_value>, <numeric_value>, <numeric_value>, <numeric_value></code>		
Value range:	0.0 ... 100.0 nW 0.0 ... 100.0 uW 0.0 ... 10.0 dB 0.0 ... 10.0 dB -10.0 ... 0.0 dB -20.0 ... 0.0 dB	Absolute level at A Absolute level at B Relative level at C Relative level at D Relative level at E Relative level at F	Default: 20.0 nW 25.0 uW +4.0 dB +1.0 dB -1.0 dB -6.0 dB
State: ALL	Option: none	With query	Note: The A-level is retained for compatibility reasons. The CTS60 doesn't support it. It is a dummy argument.

14. Menu: Modulation Configuration

Reset to Default Value

Syntax:	CALCulate:LIMit:MODulation:CLEar		
State: ALL	Option: none	No query	

Tolerance Range for Frequency Offset

Syntax:	CALCulate:LIMit:FREquency:OFFSet:TOLerance[:DATA] <numeric_value>		
Value range:	0.0 ... 500.0 kHz	Default: 50.0 kHz	
State: ALL	Option: none	With query	Note: The tolerance range is symmetrical

Tolerance Range for B-Field Modulation

Syntax:	CALCulate:LIMit:BFieLd:TOLerance[:DATA] <numeric_value>, <numeric_value>		
Value range:	0.0 ... 500.0 kHz	Default: 259.0 kHz 403.0 kHz	
State: ALL	Option: none	With query	Note: The tolerance range is symmetrical. The first value is minimum, the second one is maximum tolerance

Data type in B-Field

Syntax:	CONFigure:MODulation:DATA[:TYPE] <value>		
Value range:	PSRBs Pseudo random bit sequence BS55 Bit sequence 01010101 (= 55 hex) BS0F Bit sequence 00001111 (= 0F hex) Fig31 See CRT 06 Fig 31	Default: Fig31	
State: ALL	Option: none	With query	

Possible units for the frequency drift tolerance commands:

Hz/s
kHz/ms
kHz/Slot

Note the default unit differs for each command.

Tolerance Range for Frequency Drift

Syntax:	CALculate:LIMit:FREQuency:DRIFt:TOLerance <numeric_value>		
Value range:	0.0 ... 1.0e8 Hz/s	Default: 13.0e6 Hz/s	
State: ALL	Option: none	With query	Note: The default unit is Hz/s i.e. if the value has no unit, the CTS assumes Hz/s. The returned value has the unit Hz/s.

Tolerance Range for Frequency Drift (kHz/ms)

Syntax:	CALculate:LIMit:FREQuency:DRIFt:TOLerance:MS <numeric_value>		
Value range:	0.0 ... 100.0 kHz/ms	Default: 13 kHz/ms	
State: ALL	Option: none	With query	Note: The default unit is kHz/ms i.e. if the value has no unit, the CTS assumes kHz/ms. The returned value has the unit kHz/ms.

Tolerance Range for Frequency Drift (kHz/slot)

Syntax:	CALculate:LIMit:FREQuency:DRIFt:TOLerance:SLOT <numeric_value>		
Value range:	0.0 ... 41.6 kHz/slot	Default: 5.4 kHz/slot	
State: ALL	Option: none	With query	Note: The default unit is kHz/slot i.e. if the value has no unit, the CTS assumes kHz/slot. The returned value has the unit kHz/slot.

15. Menu: Timing Configuration

Number of bursts for timing measurement

Syntax:	CONFigure:TIMing:AVERage:BURSt <numeric_value>		
Value range:	2 .. 1000	Default: 32	
State: ALL	Option: none	With query	

Reset to Default Value

Syntax:	CALCulate:LIMit:TIMing:CLEar		
State: ALL	Option: none	No query	

Tolerance Range for Time Accuracy

Syntax:	CALCulate:LIMit:TIME:ACCuracy:TOLerance[:DATA] <numeric_value>		
Value range:	0.0 ... 100.0 ppm	Default: 5.0 ppm	
State: ALL	Option: none	With query	Note: The tolerance range is symmetrical

Tolerance Range for Jitter

Syntax:	CALCulate:LIMit:JITTer:TOLerance[:DATA] <numeric_value>, <numeric_value>		
Value range:	-100.0 ... 0.0 μ s 0.0 ... 100.0 μ s	Default: Minimum: -1.0 μ s Maximum: 1.0 μ s	
State: ALL	Option: none	With query	Note: The first value is minimum, the second one is maximum tolerance

Tolerance Range for Packet Transmission Accuracy

Syntax:	CALCulate:LIMit:PACKet:DELay:TOLerance[:DATA] <numeric_value>, <numeric_value>		
Value range:	-10.0 ... +10.0 μ s -10.0 ... +10.0 μ s	Tolerance for minimum Tolerance for maximum	Default: -2.0 μ s +2.0 μ s
State: ALL	Option: none	With query	Note: The tolerance range is symmetrical

16. Menu: Bit Error Rate Configuration

Reset to Default Value

Syntax:	CALCulate:LIMit:BER:LTERm:CLEar		
State: ALL	Option: none	No query	Note: Resets BER and FER tolerances

Tolerance Range for LongTerm BER and FER

Syntax:	CALCulate:LIMit:BER:LTERM:TOLerance[:DATA] <numeric_value>, <numeric_value>		
Value range:	BER: 0.0 ... 10.0 % FER: 0.0 ... 10.0 %	Default: 0.1 % 1.0 %	
State: ALL	Option: none	With query	Note: The first value is the BER range, the second one the FER range

Evaluation Window

Syntax:	CONFigure:BER:EVALuation:WINDow[:BITS] <numeric_value>		
Value range:	1 ... 30e6 (* 320 bits)	Default: 100	
State: ALL	Option: none	With query	

Time of evaluation window

Syntax:	CONFigure:BER:EVALuation:WINDow:TIME?		
Rückgabe	<value>	(Unit: sec)	
State: ALL	Option: none	Only query	

17. Menu: RF Connector / Ext. Attenuation

External FP attenuation at RF In Out

Syntax:	SENSe1:FP:CORRection:LOSS[:INPut][:MAGNitude] <numeric_value> or SOURce1:FP:CORRection:LOSS[:OUTPut][:MAGNitude] <numeric_value>		
Value range:	-40.0 ... +50.0 dB		Default: 0.0 dB
State: IDLE	Option: none	with query	Note: The command Syntax is different to the CMD60 Positive values refer to an attenuation; (N1)

External FP attenuation at RF In 2

Syntax:	SENSe2:FP:CORRection:LOSS[:INPut][:MAGNitude] <numeric_value>		
Value range:	-40.0 ... +50.0 dB		Default: 0.0 dB
State: IDLE	Option: none	with query	Note: The command Syntax is different to the CMD60 Positive values refer to an attenuation; (N1)

External FP attenuation at RF Out 2

Syntax:	SOURce2:FP:CORRection:LOSS[:OUTPut][:MAGNitude] <numeric_value>		
Value range:	-40.0 ... +50.0 dB		Default: 0.0 dB
State: IDLE	Option: none	with query	Note: The command Syntax is different to the CMD60 Positive values refer to an attenuation; (N1)

External PP attenuation at RF In Out

Syntax:	SENSe1:PP:CORRection:LOSS[:INPut][:MAGNitude] <numeric_value> or SOURce1:PP:CORRection:LOSS[:OUTPut][:MAGNitude] <numeric_value>		
Value range:	-40.0 ... +50.0 dB		Default: 0.0 dB
State: IDLE	Option: none	with query	Note: The command Syntax is different to the CMD60 Positive values refer to an attenuation; (N1)

CTS60

Remote Control/Annex C

External PP attenuation at RF In 2

Syntax:	SENSe2:PP:CORRection:LOSS[:INPut][:MAGNitude] <numeric_value>		
Value range:	-40.0 ... +50.0 dB		Default: 0.0 dB
State: IDLE	Option: none	with query	Note: The command Syntax is different to the CMD60 Positive values refer to an attenuation; (N1)

External PP attenuation at RF Out 2

Syntax:	SOURce2:PP:CORRection:LOSS[:OUTPut][:MAGNitude] <numeric_value>		
Value range:	-40.0 ... +50.0 dB		Default: 0.0 dB
State: IDLE	Option: none	with query	Note: The command Syntax is different to the CMD60 Positive values refer to an attenuation; (N1)

Selected input and output connector

Syntax:	ROUTe:IOConnector <value>		
Value Range:	I1O1	Input: RF In Out;	Output: RF In Out
	I1O2	Input: RF In Out;	Output: RF Out 2
	I2O1	Input: RF In 2;	Output: RF In Out
	I2O2	Input: RF In 2;	Output: RF Out 2
State: IDLE	Option: none	with query	Note.: (N2)

State of Coupler

Syntax:	SOURce:DECT:CORRection:LOSS:COUPler <value>		
Value range:	OFF ON		Default: ON
State: IDLE	Option: none	With query	

18. DECT Module Test remote control

Burst Analysis

Expected power (of mobile station)

Syntax:	CONFigure:BANalysis:POWer:TRANsmit:NORMAl:EXPeCted <numeric_value>		
Return:	-10.0 ... +30.0 dBm	Default: +24.0 dBm	
State: ALL	Option: none	With query	

Frequency / RF Channel

Syntax:	CONFigure:BANalysis:FREQuency <numeric_value>		
Return:	1902.528 ... 1876.608 MHz (in steps of 0.864 MHz) (Channel: -3 ... +12 (in steps of 0.5))	Default: 1897.344 MHz (Channel 0)	
State: ALL	Option: none	With query	

Measurement Window

Syntax:	CONFigure:BANalysis:MEASurement:WINDow <value>		
Return:	T25 25 µs window T50 50 µs window T75 75 µs window T83 83 µs window (P00) T100 100 µs window T150 150 µs window T156 156 µs window (P08) T200 200 µs window T250 250 µs window T300 300 µs window T350 350 µs window T364 364 µs window (P32) T400 400 µs window T450 450 µs window T500 500 µs window T750 750 µs window T781 781 µs window (P80) T1K 1000 µs window	Default: T350	
State: ALL	Option: none	With query	

Trigger

Syntax:	CONFigure:BANalysis:TRIGger <value>		
Return:	RSLope Rising Slope FREerun Free Run	Default: FRE	
State: ALL	Option: none	With query	

Trigger Delay

Syntax:	CONFigure:BANalysis:TRIGger:DElay <numeric_value>		
Return:	0 ... 10 ms	Default: 0	
State: ALL	Option: none	With query	

Power Ramp Signal

Syntax: Execute new measurement and signal result Only read result	READ:ARRay:BANalysis:POWer:TRANsmit? FETCh:ARRay:BANalysis:POWer:TRANsmit?		
Return:	<Value> {, <Value>} (Unit: dBm)		
State: BAN	Option: none	Only query	Note:

Normal Transmit Power (NTP)

Syntax: Execute new measurement and signal result Only read result	READ[:SCALar]:BANalysis:POWer:TRANsmit:NORMal? FETCh[:SCALar]:BANalysis:POWer:TRANsmit:NORMal?		
Return:	<value> (Unit: dBm)		
State: BAN	Option: none	Only query	Note: (N10)

FM-Demodulated Signal

Syntax: Execute new measurement and signal result Only read result	READ:ARRay:BANalysis:FREQuency:DEViation? FETCh:ARRay:BANalysis:FREQuency:DEViation?		
Return:	<Value> {, <Value>} (Unit: kHz)		
State: BAN	Option: none	Only query	Note: Return 1000 values from bit -38 to 462 (6 values per bit), (N10)

Frequency offset

Syntax:			
Execute measurement and signal result	new	READ[:SCALar]:BANalysis:FREQuency:OFFSet?	
Only read result		FETCh[:SCALar]:BANalysis:FREQuency:OFFSet?	
Return:		<Value> (Unit: Hz)	
State: BAN	Option: none	Only query	Note: (N10)

Modulation

Syntax:			
Execute new measurement and signal result		READ[:SCALar]:BANalysis:MODulation?	
Only read result		FETCh[:SCALar]:BANalysis:MODulation?	
Return:		<Value>, <Value> (Unit: Hz)	
State: BAN	Option: none	Only query	Note: The first value is the positive value, the second is the negative one; (N10)

Modulation Measurements Reference Type (Module Test)

Syntax:		CONFigure:BANalysis:MODulation:REFErence <value>	
Return:		MEASured NOMinal PEAK	Default: MEAS
State: ALL	Option: none	Only query	

RF Signal Generator

Frequency

Syntax:	SOURce:RFGen:FREQuency:OUTPut[:CW] <numeric_value>		
Return:	1902.528 ... 1876.608 MHz (in steps of 0.864 MHz)	Default: 1897.344 MHz	
State: RFG	Option: none	With query	Note: The input value is adapted to the step size indicated when the Parameter set is set, (N6)

Channel

Syntax:	SOURce:RFGen:FREQuency:CHANnel:OUTPut[:CW] <numeric_value>		
Return:	(Channel: -3 ... +12 (in steps of 0.5))	Default: (Channel 0)	
State: RFG	Option: none	With query	Note: The input value is adapted to the step size indicated when the Parameter set is set, (N6)

Deviation

Syntax:	SOURce:RFGen:FREQuency:DEViation <numeric_value>		
Return:	0.0 ... 510.0 kHz (in steps of 2.0 kHz)	Default: 288.0 kHz	
State: RFG	Option: none	Only query	Note: The input value is adapted to the step size indicated when the parameter set is set, (N6)

Signal

Syntax:	SOURce:RFGen:SIGNAL <value>		
Return:	B55 Burst with bit pattern 01010101 B33 Burst with bit pattern 00110011 B0F Burst with bit pattern 00001111 CE55 Constant Envelope with bit pattern 01010101 CE33 Constant Envelope with bit pattern 00110011 CE0F Constant Envelope with bit pattern 00001111 DB55 DECT Burst with bit pattern 01010101 DB33 DECT Burst with bit pattern 00110011 DB0F DECT Burst with bit pattern 00001111 DBFig31 DECT Burst with bit pattern acc. to Figure 31 DBPRs DECT Burst with pseudo random bit pattern	Default: CE55	
State: RFG	Option: none	Only query	Note: (N6)

RF Level

Syntax:	SOURce:RFGen:RF:LEVel <numeric_value>		
Return:	-100.0 ... -40.0 dBm		Default: -40.0 dBm
State: RFG	Option: none	Only query	Note:

19. Miscellaneous

Current instrument state

Syntax:	STATus:DEVIce?		
Return:	IDLE	Idle (initial state)	Default: IDLE
	DPP	DECT: Portable Part	
	DFP	DECT: Fixed Part	
	DCE	DECT: Connection Established DCE	
	BAN	DECT: Burst Analysis	
	MOD	DECT: Module Test	
	RFG	DECT: RF Signal Generator	
State: ALL	Option: none	Query only	

Firmware Version

Syntax:	SYSTem:FIRMWare:VERSion?		
Return:	String containing firmware information		
State: ALL	Option: none	Only query	

Specified Commands

Mandatory Commands

Clear Status

Syntax:	*CLS		
State: ALL	Option: none	No Query	

Standard Event Status Enable

Syntax:	*ESE <numeric_value>		
Value range:	0 ... 255		Default: 0
State: ALL	Option: none	With Query	Note: MAXimum and MINimum impermissible

Standard Event Status Register

Syntax:	*ESR?		
Return:	0 ... 255		
State: ALL	Option: none	Query only	

Identification Query

Syntax:	*IDN?		
Return:	ROHDE&SCHWARZ, CTSzz, .sssss/sss, xx.xx yy.yy.yy (zz is the model no., eg 55, 60 or 65 sssss/sss is the serial number of the testset, eg 123456/789 xx.xx is the software version, eg V 1.00 yy.yy.yy is the date, eg 18.10.93)		
State: ALL	Option: none	Query only	

Individual Status Query

Syntax:	*IST?		
Return:	0 1		
State: ALL	Option: none	Query only	

Operation Complete

Syntax:	*OPC		
Return:	1 (return only in the case of query)		
State: ALL	Option: none	With Query	Note: Also influences the OPC bit in the event status register

Parallel Poll Enable Register Enable

Syntax:	*PRE <numeric_value>		
Value range:	0 ... 255		Default: 0
State: ALL	Option: none	With Query	Note: MAXimum and MINimum impermissible

Power-on Status Clear

Syntax:	*PSC <numeric_value>		
Value range:	-32767 ... 32767		Default: 1
State: ALL	Option: none	With Query	Note: MAXimum and MINimum impermissible

Reset

Syntax:	*RST		
Status: ALL	Option: none	No query	Note: Sets the instrument to the default status (without considering an established call); however, it does not affect the remote-control settings

CTS60**Remote Control/Annex C****Service Request Enable**

Syntax:	*SRE <numeric_value>		
Value range:	0 ... 255	Default: 0	
State: ALL	Option: none	With Query	Note: MAXimum and MINimum impermissible

Status Byte Query

Syntax:	*STB?		
Return:	0 ... 255		
State: ALL	Option: none	Query only	

Wait-to-Continue

Syntax:	*WAI		
State: ALL	Option: none	No Query	

Optional Commands

Query of options

Syntax:	*OPT?		
Return:	Identical with SYSTem:OPTions?		
State: ALL	Option: none	Only query	

Remarks

(N1)

- The output power will be adapted if necessary.
- The input can be overdriven if an external amplifier is connected.

(N2)

- The level will be adapted automatically.
- Only one In- or Output can be active, that means the other In- or Output which is not selected is inactive.

(N3)

The range of the RF level depends on the external attenuation and the selected RF connector as follows:

-100.0 - ext. att. ... -40.0 - ext. att. dBm	when RF OUT selected
-40.0 - ext. att. ... +7.5 - ext. att. dBm	when RF OUT2 and RF IN selected
-20.0 - ext. att. ... +7.5 - ext. att. dBm	when RF OUT2 and RF IN2 selected

(N10)

After calling of a READ command, all scalar measurement results (within one menu) are calculated and the desired value is returned; the remaining measurement results can be fetched using FETCh or CALCulate. The field values cannot be obtained.

However, if the measurement is made via READ:ARRay, the scalar values are available in addition to the selected field values.

(N12)

The results of the tolerance query have the following meaning:

MATC:	The measurement result observes the configured limit values
NMAT:	The measurement result does not observe the configured limit values
INV:	No measurement result is available

20. Summary of all Commands

*

*CLS	35
*ESE	35
*ESR?	35
*IDN?	36
*IST?	36
*OPC	36
*OPT?	38
*PRE	36
*PSC	36
*RST	36
*SRE	37
*STB?	37
*WAI	37

C

CALCulate:LIMit:BER:LTERm:CLEar	27
CALCulate:LIMit:BER:LTERM:TOLerance:MATCHing?	19
CALCulate:LIMit:BER:LTERM:TOLerance[:DATA]	27
CALCulate:LIMit:BField:TOLerance:MATCHing?	14
CALCulate:LIMit:BField:TOLerance[:DATA]	24
CALCulate:LIMit:FREQuency:DRIFt:TOLerance	25
CALCulate:LIMit:FREQuency:DRIFt:TOLerance:MATCHing?	15
CALCulate:LIMit:FREQuency:DRIFt:TOLerance:MS	25
CALCulate:LIMit:FREQuency:DRIFt:TOLerance:SLOT	25
CALCulate:LIMit:FREQuency:OFFSet:TOLerance:MATCHing?	14
CALCulate:LIMit:FREQuency:OFFSet:TOLerance[:DATA]	24
CALCulate:LIMit:JITTer:TOLerance:MATCHing?	17
CALCulate:LIMit:JITTer:TOLerance[:DATA]	26
CALCulate:LIMit:MODulation:CLEar	24
CALCulate:LIMit:PACKet:DELay:TOLerance:MATCHing?	18
CALCulate:LIMit:PACKet:DELay:TOLerance[:DATA]	26
CALCulate:LIMit:POWer:TRANsmit:TEMPlate:TOLerance:LOWer[:DATA]	22
CALCulate:LIMit:POWer:TRANsmit:TEMPlate:TOLerance:UPPer[:DATA]	22
CALCulate:LIMit:POWer:TRANsmit:TOLerance:MATCHing?	12
CALCulate:LIMit:POWer:TRANsmit[:TEMPlate]:CLEar	22
CALCulate:LIMit:POWer:TRANsmit[:TEMPlate]:MATCHing?	12
CALCulate:LIMit:POWer:TRANsmit[:TEMPlate][:DATA]	23
CALCulate:LIMit:TIME:ACCuracy:TOLerance:MATCHing?	17
CALCulate:LIMit:TIME:ACCuracy:TOLerance[:DATA]	26
CALCulate:LIMit:TIMing:CLEar	26
CONFigure:AVERage:BURSt	21
CONFigure:BER:EVALuation:WINDow:TIME?	27
CONFigure:BER:EVALuation:WINDow[:BITS]	27
CONFigure:BER:RF:LEVel	19
CONFigure:FP:ANTenna	7
CONFigure:FP:CARRier:OFFSet	8
CONFigure:FP:PMID	7
CONFigure:FP:RF:LEVel	8
CONFigure:FP:RFPI	7
CONFigure:FP:SIGNalling:MODE	8
CONFigure:FP:TRAFfic:CARRier	7
CONFigure:FP:TRAFfic:SLOT	7
CONFigure:FP[:POWer]:PACKet[:TYPE]	21
CONFigure:MODulation:DATA[:TYPE]	24

CONFigure:POWer:TRANsmit:OUTPut:RANGe	13
CONFigure:PP:CARRier:OFFSet	5
CONFigure:PP:DUMMy:CARRier	4
CONFigure:PP:DUMMy:MODE	4
CONFigure:PP:DUMMy:SLOT	4
CONFigure:PP:PROTOtype:FP:CAPability	20
CONFigure:PP:PROTOtype:MULTiframe	20
CONFigure:PP:PROTOtype:SYSTEM:INFO	20
CONFigure:PP:RF:LEVel	5
CONFigure:PP:RFPI	4
CONFigure:PP:SIGNalling:MODE	5
CONFigure:PP:TABLE:QPACket:SEQuence	20
CONFigure:PP:TRAFfic:CARRier	5
CONFigure:PP:TRAFfic:SLOT	4
CONFigure:PP[:POWer]:PACKet[:TYPE]	21
CONFigure:TEST[:TYPE]	3
CONFigure:TIMing:AVERAge:BURSt	26

F

FETCh:ARRAy:FREQuency:DEViation?	16, 31
FETCh:ARRAy:POWer:TRANsmit?	13
FETCh:XZField:MATChing?	16
FETCh[:SCALar]:BER:LTERm?	19
FETCh[:SCALar]:BFieLd?	14
FETCh[:SCALar]:FREQuency:DRIFt:MS?	15
FETCh[:SCALar]:FREQuency:DRIFt:SLOT?	16
FETCh[:SCALar]:FREQuency:DRIFt?	15
FETCh[:SCALar]:FREQuency:OFFSet?	14
FETCh[:SCALar]:JITTer?	17
FETCh[:SCALar]:PACKet:DELay?	18
FETCh[:SCALar]:POWer:TRANsmit:NORMAl?	12
FETCh[:SCALar]:TIME:ACCuracy?	17

P

PROCedure:CONNection:RELease	11
PROCedure:CONNection:SETup	11
PROCedure:SELEct[:TEST]	3

R

READ:ARRAy:FREQuency:DEViation?	16, 31
READ:ARRAy:POWer:TRANsmit?	13
READ:XZField:MATChing?	16
READ[:SCALar]:BER:LTERm?	19
READ[:SCALar]:BFieLd?	14
READ[:SCALar]:FREQuency:DRIFt:MS?	15
READ[:SCALar]:FREQuency:DRIFt:SLOT?	16
READ[:SCALar]:FREQuency:DRIFt?	15
READ[:SCALar]:FREQuency:OFFSet?	14
READ[:SCALar]:JITTer?	17
READ[:SCALar]:NTP?	12
READ[:SCALar]:PACKet:DELay?	18
READ[:SCALar]:POWer:TRANsmit:NORMAl?	12
READ[:SCALar]:TIME:ACCuracy?	17
ROUTe:IOConnector	29

S

SENSe:DETEcted:DUMMy:CARRier?	8
SENSe:DETEcted:DUMMy:SLOT?	8

SENSe:DETEcted:RFPI?	9
SENSe:SIGNalling:STATe?	8
SENSe1:FP:CORRection:LOSS[:INPut][:MAGNitude]	28
SENSe1:PP:CORRection:LOSS[:INPut][:MAGNitude]	28
SENSe2:FP:CORRection:LOSS[:INPut][:MAGNitude]	28
SENSe2:PP:CORRection:LOSS[:INPut][:MAGNitude]	29
SOURce:DECT:CORRection:LOSS:COUPler	29
SOURce1:FP:CORRection:LOSS[:OUTPut][:MAGNitude]	28
SOURce1:PP:CORRection:LOSS[:OUTPut][:MAGNitude]	28
SOURce2:FP:CORRection:LOSS[:OUTPut][:MAGNitude]	28
SOURce2:PP:CORRection:LOSS[:OUTPut][:MAGNitude]	29
STATus:DEVice?	35
SYSTem:FIRMware:VERSion?	35

Index

A

Antenna Coupler	5.1
Autotest.....	3.1
Configuring an autotest.....	3.2
Running a fixed part test.....	3.4
Running a portable part test.....	3.8
Autotest Applications.....	1.1
Autotest Menus	
Autotest Edit Test Menu.....	6.13
Autotest Results Menu.....	6.16
Autotest Running Menu.....	6.15
Autotest Select Action Menu.....	6.14
Autotest Select Test Menu.....	6.12
Autotest Start Menu (Fixed Part Tests).....	6.10
Autotest Start Menu (Portable Part Tests).....	6.11
Autotest Printed Reports	7.1

C

Channel / Frequency Table	6.37
Commands.....	Annex C
Commissioning.....	2.3
Common Commands.....	8.13
Configuration Menus	
Config BER (Autotest).....	6.45
Config BER (Manual Test)	6.44
Config Goto (Autotest only).....	6.46
Config Power Ramp Menu	6.40
Config RF Modulation Menu.....	6.41
Config Synchr. Menu (port. part for autotest)	6.39
Config Synchronisation Menu (Fixed Part).....	6.35
Config Synchronisation Menu (Portable Part).....	6.36
Config Timing Menu (Fixed Part).....	6.42
Config Timing Menu (Portable Part)	6.43
Connecting the Instrument to the AC Supply.....	2.3

D

Description of Commands	8.11
Description of the Status Registers	8.20
Device Messages.....	8.2

E

Ensuring Electromagnetic Compliance (EMC).....	2.3
Error Messages.....	Annex B
Error-Queue Query.....	8.22
Event-Status-Enable-Register ESE.....	8.21
Event-Status-Register ESR.....	8.21

F

Field Editing	
Multi-field Editing.....	6.3
Single Field Editing	6.4
Front View.....	2.2

G

General Configuration Menus	
Com Port	6.52
Comment Menu	6.53
Config - Select.....	6.47
Config Date/Time.....	6.48
Config Keyboard Menu.....	6.54
Config Language	6.49
Config Load	6.56
Config Password	6.50
Config Save.....	6.55
Enter Password	6.51

H

Home Menu.....	6.5
----------------	-----

I

Interfaces.....	Annex A
-----------------	---------

L

List of Commands.....	Annex C
-----------------------	---------

M

Manual Test Menus	
Bit Error Rate Menu.....	6.34
Manual Test.....	4.1
Receiver Measurements.....	4.12
Testing a Fixed Part	4.2
Testing a Portable Part.....	4.5
Transmitter Measurements	4.8
Manual Test Applications.....	1.1
Manual Test Menus	
Connection Established Menu (Fixed Part Tests).....	6.24
Connection Established Menu (Portable Part Tests).....	6.26
Power Ramp Menu	6.28
RF Modulation Menu	6.30
Synchronisation Menu (Fixed Part Tests).....	6.17
Synchronisation Menu (Portable Part Tests).....	6.21
Timing Menu (Fixed Part)	6.32
Timing Menu (Portable Part).....	6.33
Menu Structure	
Overview	6.1
Status Labels.....	6.1
Menu Structure Graph	6.2

N

Notes on configuring an autotest	3.12
--	------

O

OCXO Reference Oscillator.....	2.4
Options List.....	2.4
Overview of Syntax Elements	8.10
Overview of the Status Registers.....	8.19

P

Preparation for Use.....	2.1
--------------------------	-----

R

<i>Rear View</i>	2.2
<i>Rechargeable battery</i>	2.1
<i>Remote Control</i>	8.1
<i>Responses to Queries</i>	8.7
<i>RF connection</i>	5.1

S

<i>SCPI Introduction</i>	8.3
<i>Selecting Menus</i>	
<i>Config FP Type</i>	6.7
<i>Config PP Type</i>	6.7
<i>Edit FP Type</i>	6.8
<i>Edit PP Type</i>	6.9
<i>Select FP Type</i>	6.6
<i>Select PP Type</i>	6.6
<i>Setting the Code Number to enable an option</i>	9.3
<i>Setting the Serial Number</i>	9.2
<i>Setting up the Instrument</i>	2.3
<i>Software Options</i>	9.1
<i>Structure of a Command</i>	8.3
<i>Structure of a Command Line</i>	8.5
<i>Structure of an SCPI Status Register</i>	8.17
<i>Switching on the Instrument</i>	2.3
<i>Switchover to Remote Control</i>	8.2