

Noise Figure Measurements User Manual



1173.9270.02 – 13

This manual applies to the following R&S®FSW models with firmware version 2.40 and higher:

- R&S®FSW8 (1312.8000K08)
- R&S®FSW13 (1312.8000K13)
- R&S®FSW26 (1312.8000K26)
- R&S®FSW43 (1312.8000K43)
- R&S®FSW50 (1312.8000K50)
- R&S®FSW67 (1312.8000K67)
- R&S®FSW85 (1312.8000K85)

The following firmware options are described:

- R&S FSW-K30 (1313.1380.02)

© 2016 Rohde & Schwarz GmbH & Co. KG
Mühldorfstr. 15, 81671 München, Germany
Phone: +49 89 41 29 - 0
Fax: +49 89 41 29 12 164
Email: info@rohde-schwarz.com
Internet: www.rohde-schwarz.com

Subject to change – Data without tolerance limits is not binding.

R&S® is a registered trademark of Rohde & Schwarz GmbH & Co. KG.

Trade names are trademarks of the owners.

The following abbreviations are used throughout this manual: R&S®FSW is abbreviated as R&S FSW.

Contents

1	Preface	7
1.1	About this Manual.....	7
1.2	Documentation Overview.....	8
1.3	Conventions Used in the Documentation.....	9
1.3.1	Typographical Conventions.....	9
1.3.2	Conventions for Procedure Descriptions.....	10
1.3.3	Notes on Screenshots.....	10
2	Welcome to the Noise Figure Measurement Application	11
2.1	Starting the Application.....	11
2.2	Understanding the Display Information.....	12
3	Measurements and Result Displays	15
4	Measurement Basics	24
4.1	Tuning Modes.....	24
4.1.1	Swept Measurements.....	25
4.1.2	Frequency Table Measurements.....	25
4.1.3	Single Frequency Measurements.....	25
4.2	Measurement Modes.....	26
4.3	DUT Types.....	28
4.3.1	Measurements on Linear DUTs (Direct Measurement).....	28
4.3.2	Measurements on Frequency Converting DUTs.....	28
4.4	External Generator Control.....	29
4.5	Image Frequency Rejection.....	31
4.6	Calibration (2nd Stage Correction).....	33
4.7	Separating Signals by Selecting an Appropriate Resolution Bandwidth.....	36
4.8	Analyzing Several Traces - Trace Mode.....	36
4.9	Using Markers.....	37
5	Configuration	40
5.1	Configuration Overview.....	40
5.2	Defining the Measurement Frequency.....	42
5.2.1	Defining a Frequency Set.....	42

5.2.2	Configuring Single Frequency Measurements.....	45
5.2.3	Using a Frequency Table.....	46
5.3	Selecting DUT Characteristics.....	47
5.4	Configuring the Noise Source.....	48
5.4.1	Selecting the Type of Noise Source.....	49
5.4.2	Defining the Noise Source Characteristics.....	49
5.4.3	Using an ENR or Temperature Table.....	52
5.5	Configuring Additional Loss.....	54
5.5.1	Defining Loss.....	55
5.5.2	Using a Loss Table.....	56
5.6	Configuring the Analyzer.....	57
5.6.1	Configuring the Measurement.....	57
5.6.2	Configuring Level Characteristics.....	59
5.7	Using the Uncertainty Calculator.....	61
5.7.1	Configuring Noise Source Characteristics.....	62
5.7.2	Configuring DUT Characteristics.....	63
5.7.3	Configuring Analyzer Characteristics.....	64
5.7.4	Guidelines and Results.....	65
5.8	Performing Measurements.....	66
5.9	Configuring Inputs and Outputs of the R&S FSW.....	68
5.9.1	Radio Frequency (RF) Input.....	68
5.9.2	External Mixer Settings.....	69
5.9.3	External Generator.....	80
6	Analysis.....	84
6.1	Configuring the Display.....	84
6.1.1	Configuring Graphical Results.....	84
6.1.2	Configuring Numerical Results.....	86
6.2	Working with Traces.....	86
6.3	Using Markers.....	88
6.3.1	Marker Configuration.....	88
6.3.2	Marker Positioning.....	90
6.4	Limit Line Settings and Functions.....	92
6.4.1	Limit Line Management.....	92

6.4.2	Limit Line Details.....	95
7	Remote Control Commands for Noise Measurements.....	97
7.1	Common Suffixes.....	97
7.2	Introduction.....	98
7.2.1	Conventions used in Descriptions.....	98
7.2.2	Long and Short Form.....	99
7.2.3	Numeric Suffixes.....	99
7.2.4	Optional Keywords.....	100
7.2.5	Alternative Keywords.....	100
7.2.6	SCPI Parameters.....	100
7.3	Controlling the Noise Figure Measurement Channel.....	103
7.4	Working with Windows in the Display.....	107
7.5	General Window Commands.....	113
7.6	Measurement Results.....	114
7.7	Defining the Measurement Frequency.....	116
7.8	Selecting DUT Characteristics.....	120
7.9	Configuring the Noise Source.....	121
7.10	Configuring Additional Loss.....	129
7.11	Configuring the Analyzer.....	133
7.12	Using the Uncertainty Calculator.....	137
7.13	Performing Measurements.....	145
7.14	Configuring the Inputs and Outputs.....	150
7.14.1	Radio Frequency (RF) Input.....	150
7.14.2	External Mixer.....	152
7.14.3	External Generator.....	163
7.15	Configuring the Display.....	166
7.16	Working with Traces.....	169
7.17	Working with Limit Lines.....	173
7.17.1	Defining General Characteristics of a Limit Line.....	174
7.17.2	Defining Horizontal Data Points.....	175
7.17.3	Controlling Lower Limit Lines.....	177
7.17.4	Controlling Upper Limit Lines.....	178
7.17.5	Managing Limit Lines.....	179

7.17.6	Controlling Limit Checks.....	180
7.18	Working with Markers.....	182
7.18.1	Using Markers.....	183
7.18.2	Using Delta Markers.....	185
7.18.3	Configuring Markers.....	188
7.18.4	Positioning Markers.....	189
7.18.5	Positioning Delta Markers.....	192
7.19	Using the Status Register.....	194
7.19.1	Status Registers for Noise Figure Measurements.....	194
7.20	Deprecated Remote Commands for Noise Figure Measurements.....	200
	List of Remote Commands (Noise Figure).....	202
	Index.....	208

1 Preface

1.1 About this Manual

This User Manual provides all the information **specific to the application**. All general instrument functions and settings common to all applications and operating modes are described in the main R&S FSW User Manual.

The main focus in this manual is on the measurement results and the tasks required to obtain them. The following topics are included:

- **Welcome to the Noise Figure Application**
Introduction to and getting familiar with the application
- **Typical applications**
Example measurement scenarios in which the application is frequently used.
- **Measurements and Result Displays**
Details on supported measurements and their result types
- **Noise Figure Measurement Basics**
Background information on basic terms and principles in the context of the measurement
- **Noise Figure Measurement Configuration + Analysis**
A concise description of all functions and settings available to configure measurements and analyze results with their corresponding remote control command
- **How to Perform Measurements with the Noise Figure Application**
The basic procedure to perform each measurement and step-by-step instructions for more complex tasks or alternative methods
- **Measurement Examples**
Detailed measurement examples to guide you through typical measurement scenarios and allow you to try out the application immediately
- **Optimizing and Troubleshooting the Measurement**
Hints and tips on how to handle errors and optimize the test setup
- **Remote Commands for Noise Figure Measurements**
Remote commands required to configure and perform noise figure measurements in a remote environment, sorted by tasks
(Commands required to set up the environment or to perform common tasks on the instrument are provided in the main R&S FSW User Manual)
Programming examples demonstrate the use of many commands and can usually be executed directly for test purposes
- **Annex**
Reference material
- **List of remote commands**
Alphabetical list of all remote commands described in the manual
- **Index**

1.2 Documentation Overview

The user documentation for the R&S FSW consists of the following parts:

- "Getting Started" printed manual
- Online Help system on the instrument
- User manuals and online manual for base unit and options provided on the product page
- Service manual provided on the internet for registered users
- Instrument security procedures provided on the product page
- Release notes provided on the product page
- Data sheet and brochures provided on the product page
- Application notes provided on the Rohde & Schwarz website



You find the user documentation on the R&S FSW product page mainly at:

<http://www.rohde-schwarz.com/product/FSW> > "Downloads" > "Manuals"

Additional download paths are stated directly in the following abstracts of the documentation types.

Getting Started

Introduces the R&S FSW and describes how to set up and start working with the product. Includes basic operations, typical measurement examples, and general information, e.g. safety instructions, etc.

Online Help

Offers quick, context-sensitive access to the information needed for operation and programming. It contains the description for the base unit and the software options. The Online Help is embedded in the instrument's firmware; it is available using the ? icon on the toolbar of the R&S FSW.

User Manuals and Online Manual

Separate manuals are provided for the base unit and the software options:

- **Base unit manual**
Contains the description of the graphical user interface, an introduction to remote control, the description of all SCPI remote control commands, programming examples, and information on maintenance, instrument interfaces and error messages. Includes the contents of the **Getting Started** manual.
- **Software option manuals**
Describe the specific functions of the option. Basic information on operating the R&S FSW is not included.

The **online manual** provides the contents of the user manuals for the base unit and all software options for immediate display on the internet.

Service Manual

Describes the performance test for checking the rated specifications, module replacement and repair, firmware update, troubleshooting and fault elimination, and contains mechanical drawings and spare part lists.

The service manual is available for registered users on the global Rohde & Schwarz information system (GLORIS).

Instrument Security Procedures

Deals with security issues when working with the R&S FSW in secure areas.

Data Sheet and Brochures

The data sheet contains the technical specifications of the R&S FSW. Brochures provide an overview of the instrument and deal with the specific characteristics, see:

<http://www.rohde-schwarz.com/product/FSW> > "Downloads" > "Brochures and Data Sheets"

Release Notes

Describes the firmware installation, new and modified features and fixed issues according to the current firmware version. You find the latest version at:

<http://www.rohde-schwarz.com/product/FSW> > "Firmware"

Application Notes, Application Cards, White Papers, etc.

These documents deal with special applications or background information on particular topics, see:

<http://www.rohde-schwarz.com/> > "Downloads" > "Applications".

1.3 Conventions Used in the Documentation

1.3.1 Typographical Conventions

The following text markers are used throughout this documentation:

Convention	Description
"Graphical user interface elements"	All names of graphical user interface elements on the screen, such as dialog boxes, menus, options, buttons, and softkeys are enclosed by quotation marks.
KEYS	Key names are written in capital letters.
File names, commands, program code	File names, commands, coding samples and screen output are distinguished by their font.
<i>Input</i>	Input to be entered by the user is displayed in italics.

Convention	Description
Links	Links that you can click are displayed in blue font.
"References"	References to other parts of the documentation are enclosed by quotation marks.

1.3.2 Conventions for Procedure Descriptions

When describing how to operate the instrument, several alternative methods may be available to perform the same task. In this case, the procedure using the touchscreen is described. Any elements that can be activated by touching can also be clicked using an additionally connected mouse. The alternative procedure using the keys on the instrument or the on-screen keyboard is only described if it deviates from the standard operating procedures.

The term "select" may refer to any of the described methods, i.e. using a finger on the touchscreen, a mouse pointer in the display, or a key on the instrument or on a keyboard.

1.3.3 Notes on Screenshots

When describing the functions of the product, we use sample screenshots. These screenshots are meant to illustrate as much as possible of the provided functions and possible interdependencies between parameters.

The screenshots usually show a fully equipped product, that is: with all options installed. Thus, some functions shown in the screenshots may not be available in your particular product configuration.

2 Welcome to the Noise Figure Measurement Application

The R&S FSW-K30 is a firmware application that adds functionality to perform noise figure measurements to the R&S FSW.

This user manual contains a description of the functionality that the application provides, including remote control operation.

Functions that are not discussed in this manual are the same as in the Spectrum application and are described in the R&S FSW User Manual. The latest versions of the manuals are available for download at the product homepage.

<http://www2.rohde-schwarz.com/product/FSW.html>.

Installation

Find detailed installing instructions in the Getting Started or the release notes of the R&S FSW.



Noise Source Control

The Noise Source Control connector on the R&S FSW is a prerequisite for the R&S FSW Noise measurements application.

- [Starting the Application](#)..... 11
- [Understanding the Display Information](#)..... 12

2.1 Starting the Application

The noise figure measurement application adds a new type of measurement to the R&S FSW.

To activate the Noise Figure application

1. Select the MODE key.

A dialog box opens that contains all operating modes and applications currently available on your R&S FSW.

2. Select the "Noise" item.



The R&S FSW opens a new measurement channel for the noise figure measurement application.

All settings specific to noise figure measurements are in their default state.

Multiple Measurement Channels and Sequencer Function

When you enter an application, a new measurement channel is created which determines the measurement settings for that application. The same application can be activated with different measurement settings by creating several channels for the same application.

The number of channels that can be configured at the same time depends on the available memory on the instrument.

Only one measurement can be performed at any time, namely the one in the currently active channel. However, in order to perform the configured measurements consecutively, a Sequencer function is provided.

If activated, the measurements configured in the currently active channels are performed one after the other in the order of the tabs. The currently active measurement is indicated by a  symbol in the tab label. The result displays of the individual channels are updated in the tabs (as well as the "MultiView") as the measurements are performed. Sequential operation itself is independent of the currently *displayed* tab.

For details on the Sequencer function see the R&S FSW User Manual.

2.2 Understanding the Display Information

The following figure shows the display as it looks for noise figure measurements. All different information areas are labeled. They are explained in more detail in the following sections.

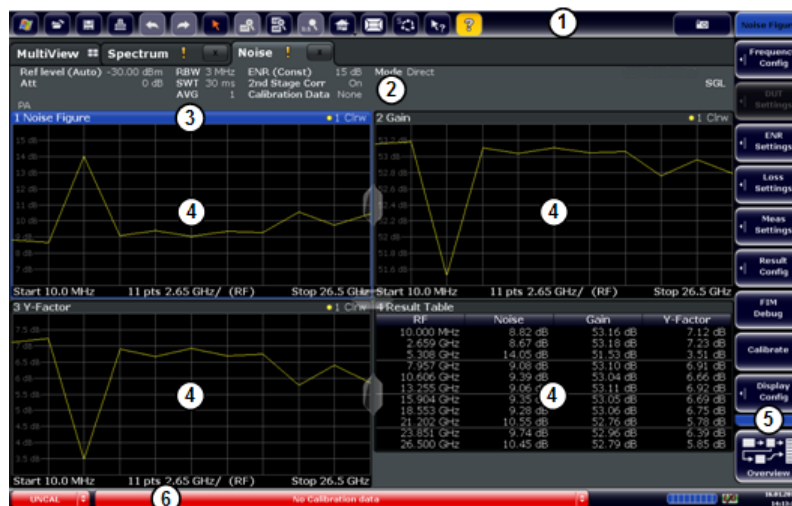

Figure 2-1: Screen layout of the noise figure measurement application

- 1 = Toolbar
- 2 = Channel bar
- 3 = Diagram header
- 4 = Result display
- 5 = Softkey bar
- 6 = Status bar

Channel bar information

The channel bar contains information about the current measurement setup, progress and results.

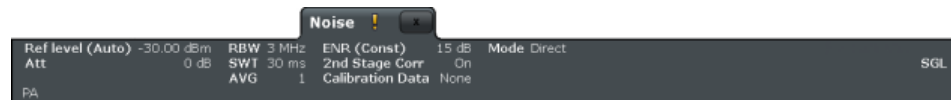

Figure 2-2: Channel bar of the Noise Figure application

Ref Level	Reference level of the R&S FSW.
Att	Attenuation of the R&S FSW.
RBW	Resolution bandwidth
SWT	Sweep time
AVG	Number of averages
ENR	Excess noise ratio
2nd Stage Corr	State of the 2nd stage correction.
Calibration Data	Date and time of the current calibration data.
Mode	Currently selected measurement mode.

Window title bar information

For each diagram, the header provides the following information:



Figure 2-3: Window title bar information for the Noise Figure application

- 1 = Window number
- 2 = Window type
- 3 = Trace color and number
- 4 = Trace mode

Status bar information

Global instrument settings, the instrument status and any irregularities are indicated in the status bar beneath the diagram. Furthermore, the progress of the current operation is displayed in the status bar.

NOTICE**Risk of damaging the instrument**

Make sure not to overload the input mixer during calibration and the measurement. An overload condition may damage or destroy the input mixer.

If an overload condition occurs, the R&S FSW shows a corresponding message in the status line ("RF OVLD" or "IF OVLD").

To avoid an overload during calibration or measurement

- check and adjust the DUT gain settings,
- check and adjust the ENR settings
or
- increase the reference level.

3 Measurements and Result Displays

The R&S FSW-K30 measures the noise figure of a DUT and displays the results graphically and numerically. Each graphical result display shows the noise figure from a different perspective that may be relevant. In the default configuration, the application shows the Noise Figure of the DUT, the Gain of the DUT and the corresponding Y-Factor. In addition it shows the numerical results of the measurement.

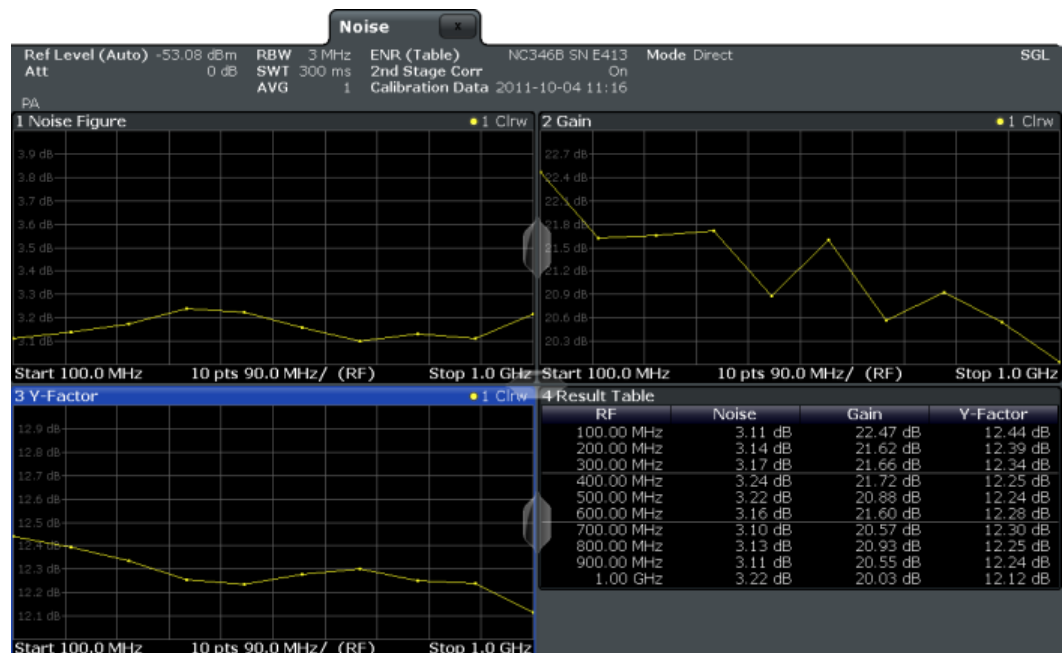

The scale of the horizontal axis depends on the tuning mode.

Frequency list and swept measurements

In all graphical result displays, the horizontal axis represents the frequency. The displayed frequency is either the RF (radio frequency) or the IF (intermediate frequency). The range depends on the frequency set you have currently defined. Because the application only measures selected frequencies, it connects the results to draw a trace.



Negative noise figure and noise temperature

From a physical point of view, the noise figure and the noise temperature levels have a positive range (including zero).

Because of the mathematical operations the application performs, it may also show negative values in some cases. This may be due to incorrect calibration or variance of measurement values.

Single frequency measurements

In all graphical result displays, the horizontal axis represents a chronological order of measurement results for the frequency you are testing. The axis has no unit, but is made up out of several index values that represent time. Each index value represents

one measurement point and therefore one measurement on the single frequency you are analyzing. The size of the index (and thus number of results) depends on the number of (Measurement) Points that you have defined. Because the application only measures at certain points in time, it connects the results to draw a trace.

The right diagram border represents the present (index = 0), values to the left represent past measurement results (index = -<x>). As soon as the application finishes a single measurement, the measurement points are moved to the left, the new result is added on the right. All other measurement points are moved down one position with the most obsolete result falling out of the diagram (like in the roll mode of an oscilloscope).

Selecting the result display

- ▶ Select the  icon in the toolbar or press the MEAS key.

The application enters the SmartGrid configuration mode.

For more information on the SmartGrid functionality see the R&S FSW Getting Started.

Noise Figure.....	16
Gain.....	17
Noise Temperature.....	17
Y-Factor.....	18
Power (Hot).....	19
Power (Cold).....	19
Cal Y-Factor.....	20
Cal Power (Hot).....	20
Cal Power (Cold).....	21
Result Table.....	21
Current Values.....	22
Marker Table.....	22

Noise Figure

Shows the noise figure of the DUT.

The noise figure is the ratio of the signal-to-noise ratio at the DUT input to that at the DUT output.

$$\text{Noise Figure} = \frac{SNR_{in}}{SNR_{out}}$$

The vertical axis shows the level of the noise figure in dB. The scale depends on the settings in the "Display Configuration" dialog box.

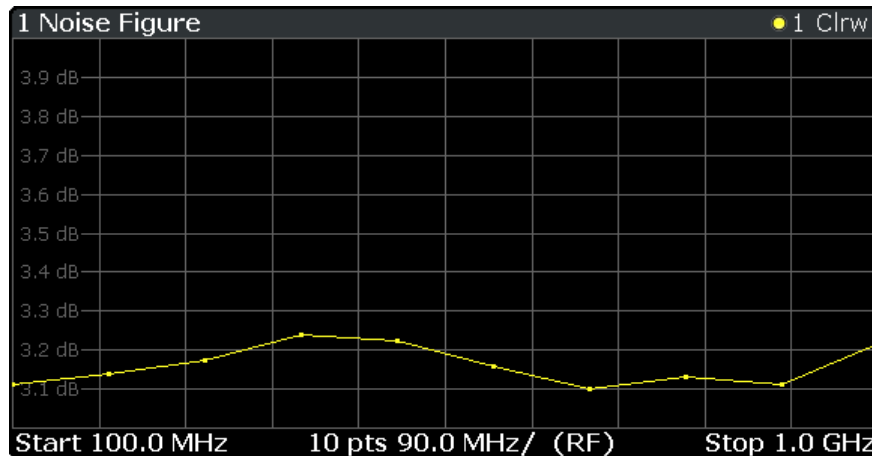

Remote command:

LAY:ADD:WIND '2',RIGH,NOIS see [LAYout:ADD\[:WINDow\]?](#) on page 107

Results: [TRACe<t>\[:DATA\] NFIGure](#)

Gain

Shows the gain characteristics of the DUT.

The vertical axis shows the level of the gain in dB. The scale depends on the settings in the "Display Configuration" dialog box.

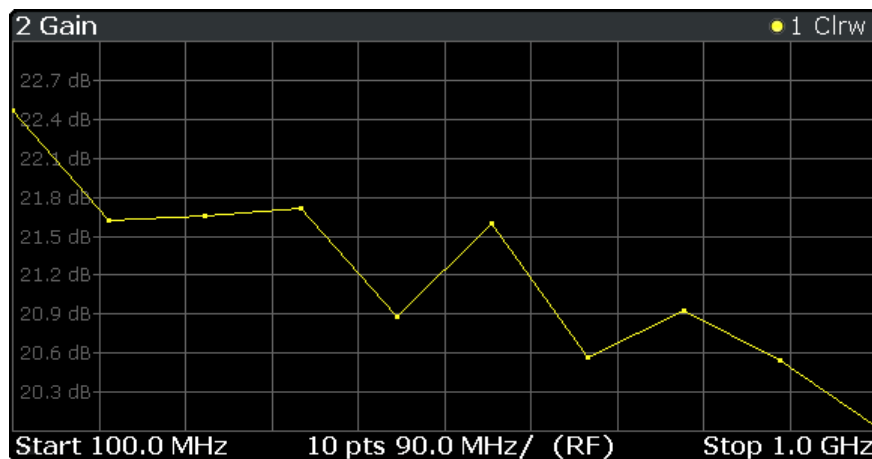

Remote command:

LAY:ADD:WIND '2',RIGH,GAIN see [LAYout:ADD\[:WINDow\]?](#) on page 107

Results: [TRACe<t>\[:DATA\] GAIN](#)

Noise Temperature

Shows the noise temperature characteristics of the DUT.

$$\text{Noise Temperature} = \frac{P}{B \cdot k}$$

with

P = Power

B = Bandwidth

k = Boltzmann constant

The vertical axis shows the noise temperature in Kelvin. The scale depends on the settings in the "Display Configuration" dialog box.

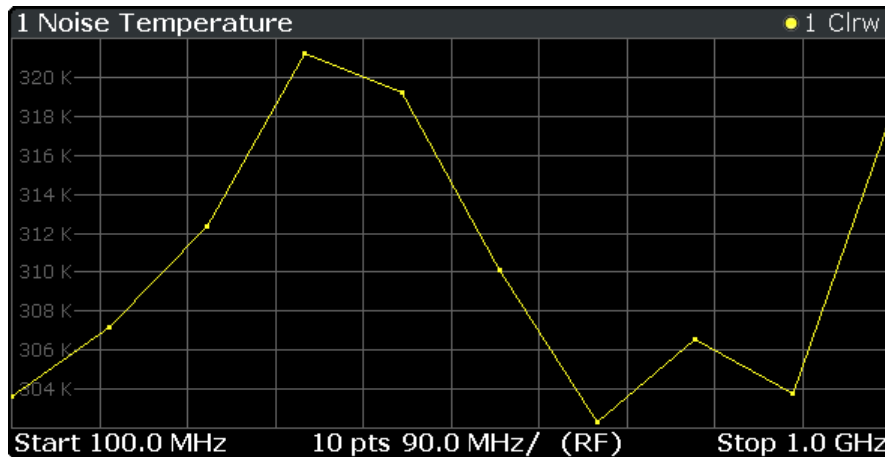

Remote command:

LAY:ADD:WIND '2', RIGH, TEMP see [LAYout:ADD\[:WINDow\]?](#) on page 107

Results: [TRACe<t>\[:DATA\] TEMPerature](#)

Y-Factor

Shows the ratio of the hot and the cold power of the DUT.

The Y-factor indicates the quality of measurement tolerances and uncertainties. To get the result, the application measures the DUT power with the noise source turned on (hot power) and the noise source turned off (cold power).

$$Y\text{-Factor} = \frac{N_{on}}{N_{off}}$$

with

N_{on} = Noise power [dB] with noise source on

N_{off} = Noise power [dB] with noise source off

The vertical axis shows the linear relation. The scale depends on the settings in the "Display Configuration" dialog box.

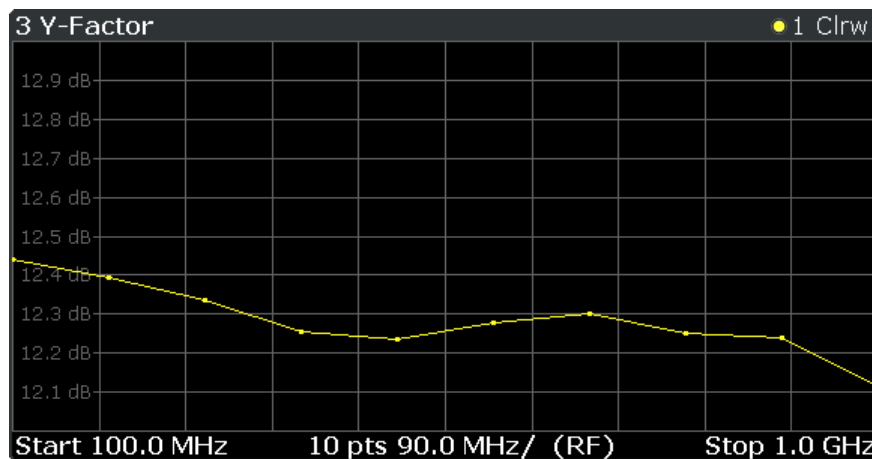

Remote command:

LAY:ADD:WIND '2',RIGH,YFAC see [LAYout:ADD\[:WINDow\]?](#) on page 107

Results: [TRACe<t>\[:DATA\] YFACTOR](#)

Power (Hot)

Shows the absolute power characteristics at the instrument input. The noise source is turned on.

The vertical axis shows the power in dBm. The scale depends on the settings in the "Display Configuration" dialog box.

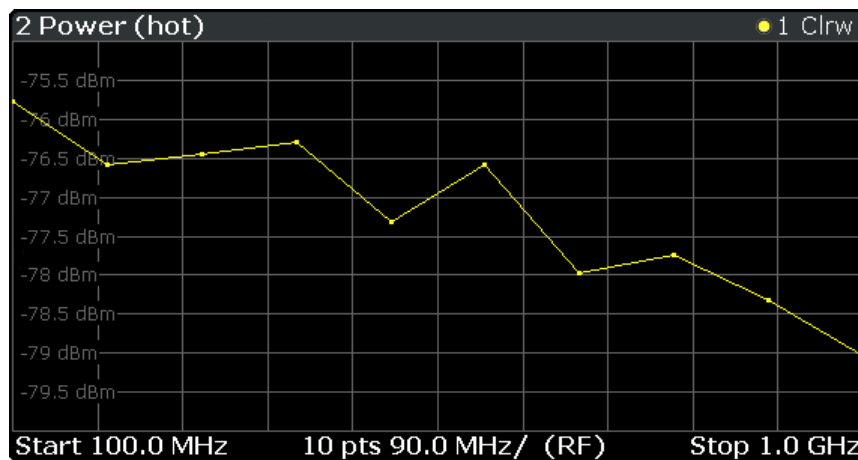

Remote command:

LAY:ADD:WIND '2',RIGH,PHOT see [LAYout:ADD\[:WINDow\]?](#) on page 107

Results: [TRACe<t>\[:DATA\] PHOT](#)

Power (Cold)

Shows the absolute power characteristics at the instrument input. The noise source is turned off.

The vertical axis shows the power in dBm. The scale depends on the settings in the "Display Configuration" dialog box.

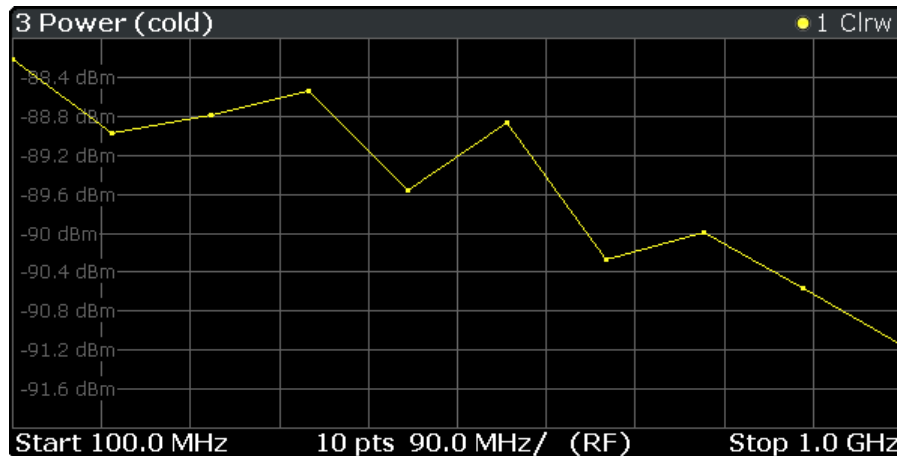

Remote command:

LAY:ADD:WIND '2', RIGH, PCOL see LAYout:ADD[:WINDow] ? on page 107

Results: TRACe<t>[:DATA] PCOLd

Cal Y-Factor

Shows the ratio of the hot and the cold power measured during calibration.

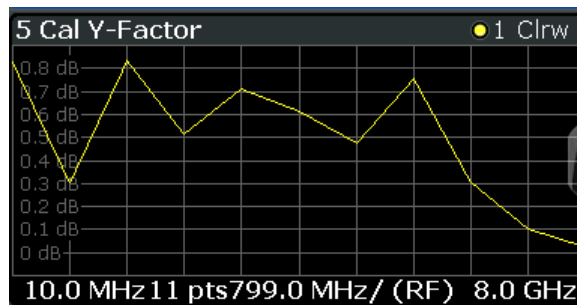

The Y-factor indicates the quality of measurement tolerances and uncertainties. To get the result, the application measures the power with the noise source turned on (hot power) and the noise source turned off (cold power), but without the DUT inserted.

$$Y\text{-Factor} = \frac{N_{on}}{N_{off}}$$

with

N_{on} = Noise power [dB] with noise source on

N_{off} = Noise power [dB] with noise source off

The vertical axis shows the linear relation. The scale depends on the settings in the "Display Configuration" dialog box.

Remote command:

LAY:ADD:WIND '2', RIGH, CYF see LAYout:ADD[:WINDow] ? on page 107

Results: TRACe<t>[:DATA] CYFactor

Cal Power (Hot)

Shows the absolute power characteristics at the instrument input during the calibration measurement. The noise source is turned on, the DUT is not inserted.

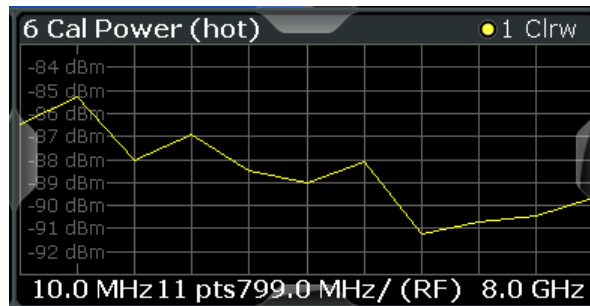

The vertical axis shows the power in dBm. The scale depends on the settings in the "Display Configuration" dialog box.

Remote command:

LAY:ADD:WIND '2',RIGH,CPH see [LAYout:ADD\[:WINDow\]?](#) on page 107

Results: [TRACe<t>\[:DATA\] CPHot](#)

Cal Power (Cold)

Shows the absolute power characteristics at the instrument input during the calibration measurement. The noise source is turned off, the DUT is not inserted.

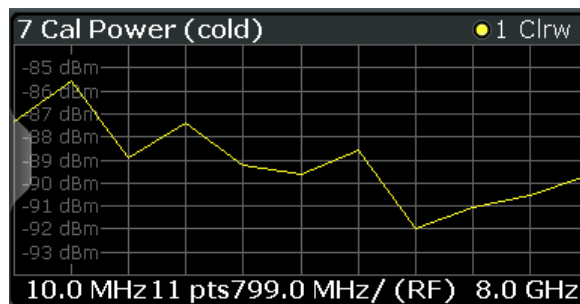

The vertical axis shows the power in dBm. The scale depends on the settings in the "Display Configuration" dialog box.

Remote command:

LAY:ADD:WIND '2',RIGH,CPC see [LAYout:ADD\[:WINDow\]?](#) on page 107

Results: [TRACe<t>\[:DATA\] CPCold](#)

Result Table

Shows the measurement results in numerical form in a table.

The contents of the table depend on the "Display Settings". By default it shows the results for the Noise Figure, Gain and Y-Factor result type. Each row represents one measurement point. Each column represents one result type. The first column shows the measurement frequency.

If you display the uncertainty result, it is displayed in the Noise column next to the Noise Figure result. Note that the uncertainty is displayed only after you have turned on the uncertainty calculation and also include the result in the display.

The result table shows either the RF or the IF, depending on you selection.

For more information see [Chapter 6.1.2, "Configuring Numerical Results"](#), on page 86.

RF	Noise	Gain	Y-Factor
100.00 MHz	3.11 dB	22.47 dB	12.44 dB
200.00 MHz	3.14 dB	21.62 dB	12.39 dB
300.00 MHz	3.17 dB	21.66 dB	12.34 dB
400.00 MHz	3.24 dB	21.72 dB	12.25 dB
500.00 MHz	3.22 dB	20.88 dB	12.24 dB
600.00 MHz	3.16 dB	21.60 dB	12.28 dB
700.00 MHz	3.10 dB	20.57 dB	12.30 dB
800.00 MHz	3.13 dB	20.93 dB	12.25 dB
900.00 MHz	3.11 dB	20.55 dB	12.24 dB
1.00 GHz	3.22 dB	20.03 dB	12.12 dB

Remote command:

LAY:ADD:WIND '2',RIGH,RES see [LAYout:ADD\[:WINDOW\]?](#) on page 107

Results: [TRACe<n>\[:DATA\]?](#) on page 114

Table items: [DISPlay\[:WINDOW<n>\]:TABLE:ITEM](#) on page 167

Current Values

Shows the result at the current measurement point.

The contents of the "Current" result display are updated as soon as a new measurement point is analyzed.

The result types shown in the table depend on the "Display Settings". By default it shows the results for the Noise Figure, Gain and Y-Factor result type. Each row represents one result type. The first column shows the result type, the second column shows the result.

For more information see [Chapter 6.1.2, "Configuring Numerical Results"](#), on page 86.

Marker Table

Shows the marker characteristics in numerical form in a table.

The size of the table depends on the number of active markers and the way you have configured the table in the "Result Config" dialog box. For more information see [Chapter 6.3, "Using Markers"](#), on page 88 and [Chapter 6.1.2, "Configuring Numerical Results"](#), on page 86.

Type	Ref	Trc	Stimulus	Noise	Gain
N1		1	400.00 MHz	3.24 dB	21.72 dB
D2	N1	1	100.00 MHz	-0.01 dB	-0.84 dB
D3	N1	1	200.00 MHz	-0.08 dB	-0.12 dB

The first four columns of the table are fix.

- Type
Shows the marker type. 'M' represents a normal marker, 'D' represents a delta marker.
- Ref
Shows the reference marker for relative delta markers.
- Trc
Shows the trace the marker is positioned on.
- X-value
Shows the horizontal position (frequency) of the marker.

In case of normal markers, the position is an absolute value. The position of delta markers are relative to another marker.

- <Result>

Shows the measurement result at the marker position.

In case of normal markers, the result is an absolute value. Results for delta markers are relative to another marker.

Remote command:

LAY:ADD:WIND '2',RIGH,MTAB see [LAYout:ADD\[:WINDow\]?](#) on page 107

Results:

[CALCulate<n>:MARKer<m>:Y?](#) on page 184

[CALCulate<n>:DELTAmarker<m>:Y?](#) on page 187

4 Measurement Basics

The measurement basics contain background information on the terminology and principles of noise measurements.

Noise figure measurements determine the noise that a device under test (DUT) adds to a signal as that signal passes through the DUT.

- [Tuning Modes](#)..... 24
- [Measurement Modes](#)..... 26
- [DUT Types](#)..... 28
- [External Generator Control](#)..... 29
- [Image Frequency Rejection](#)..... 31
- [Calibration \(2nd Stage Correction\)](#)..... 33
- [Separating Signals by Selecting an Appropriate Resolution Bandwidth](#)..... 36
- [Analyzing Several Traces - Trace Mode](#)..... 36
- [Using Markers](#)..... 37

4.1 Tuning Modes

Basically, the application calculates the noise figure of a DUT based on the characteristics of the DUT that have been measured and a noise source whose properties are known. Therefore, the Noise Source Control connector on the R&S FSW is a prerequisite for the R&S FSW Noise measurements application.

In addition to the noise characteristics of a DUT, the application is also able to determine several more DUT characteristics like its gain or its noise temperature characteristics.

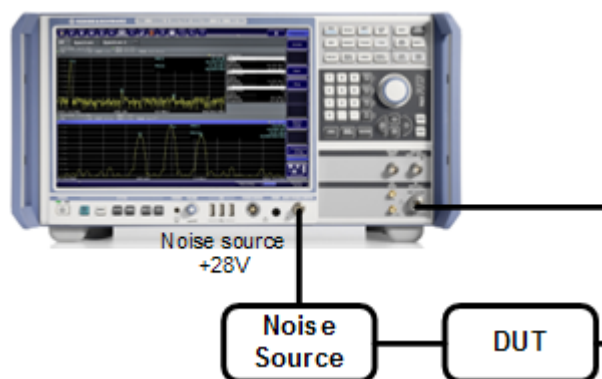

The application provides several measurement modes or **tuning modes**.

- [Swept Measurements](#)..... 25
- [Frequency Table Measurements](#)..... 25
- [Single Frequency Measurements](#)..... 25

4.1.1 Swept Measurements

The **sweep** tuning mode performs measurements on a set of discrete frequencies based on the frequency parameters. Each measurement analyzes the noise characteristics of the corresponding frequency or measurement point.

For swept measurements, the application automatically determines the measurement frequencies and combines them in a frequency list.

Such a frequency set is the result of the frequency and span information that you have provided. The frequency and span information is made up out of the center frequency, the span, the start and the stop frequency. In combination with the measurement points or the frequency table step size, the application calculates the contents of the frequency table.

The **center frequency** is the frequency in the center of the frequency band you are measuring. Thus, it is defined either by the span or the start and stop frequencies.

The **measurement points** is the number of entries in a frequency list and thus the number of measurements that the application performs during a noise figure measurement.

The **stepsize** defines the distance between two measurement points. It is constant for all measurement points.



If the stepsize is larger than the distance between start and stop frequency, the frequency table consists of the start and stop frequencies only.

4.1.2 Frequency Table Measurements

The **frequency table** tuning mode also performs measurements on a set of frequencies based on the contents of a frequency list. Each measurement analyzes the noise characteristics of the corresponding frequency.

Compared to a swept measurement, you can customize the contents of the frequency list. Thus, you can add frequencies that are independent of the frequency stepsize and the number of measurement points.

4.1.3 Single Frequency Measurements

The **single frequency** tuning mode performs one or several consecutive measurements on a single frequency. You can perform the measurement on any frequency that is supported by the hardware you are using.

Single frequency measurements are a way to facilitate manual adjustments for noise figure measurements. They also allow you to get an idea about how the noise figure at a particular frequency change over time.

Note that sweep lists or frequency tables are not considered in this measurement mode.

Single frequency measurement results

For single frequency measurements, the same set of graphical result displays is available as for frequency list measurements (Noise Figure, Gain etc.). Note, however, that the x-axis has no unit, but shows a series of results taken for a single frequency. The number of displayed results depends on the number of measurement points you have defined.

For more information see [Chapter 3, "Measurements and Result Displays"](#), on page 15.

In addition, you can also view the results in the Result Table in numerical form.

Single frequency measurements are not available when you are using a resistor as a noise source.

4.2 Measurement Modes

In some cases, the Power (Hot) and Power (Cold) results require two different noise sources with different temperature characteristics (cold and hot). An example are measurements with a resistor that is used as a noise source.

Usually, noise sources with diode characteristics are used for Noise Figure measurements. These noise sources have two states, on and off. When they are supplied with power (state = on), the application measures the hot power, when they are not supplied with power (state = off), it measures the cold power. Turning the noise source on and off is automatically done by the application, so that you can get the hot and cold power characteristics in a single step.

This **automatic measurement mode** is the default measurement mode of the Noise Figure Measurements application.

When you are using resistor as a noise source, however, this is not possible, because two resistors, one hot and one cold, are required, and you have to substitute the hot resistor with the cold resistor to measure the hot and cold power respectively. For these cases, the application provides a **manual measurement mode**. This measurement mode is automatically selected when you select a noise source with [resistor characteristics](#), but is not restricted to those cases.

The manual measurement mode is available for measurements and the calibration stage.

Performing a manual measurement

In manual measurement mode, you have to measure (or calibrate) the hot and cold power characteristics of the DUT separately. When you start the measurement, the application opens a dialog box that allows you to select the type of measurement to perform next.



Recommended order of measurements

Note that it is recommended, and in case of uncalibrated measurements required, to begin with the hot power measurement.

Furthermore, calibration always begins with the hot power measurement.

In case the hot power has to be measured first, the cold power measurement is unavailable:

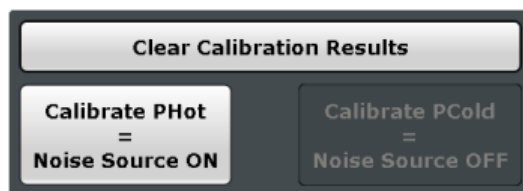

When the first measurement is done, you can change the test setup by connecting the other resistor and start the second measurement (hot or cold, depending on which measurement you have done first).

In the dialog box, the measurement stage that is already done is labeled green.

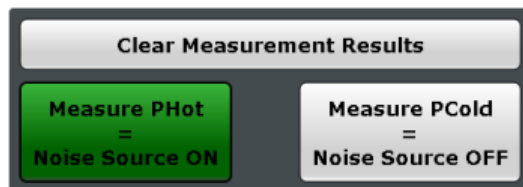

In addition, the application shows the missing calibration and measurement steps in the channel bar.

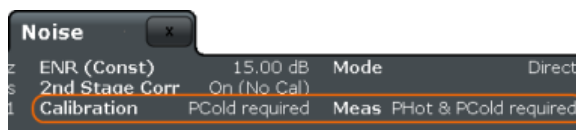

Clearing results

If you have to replace the previous calibration or measurement results, you can clear the currently stored data with the "Clear Calibration Results" or "Clear Measurement Results" button that is also available in the dialog box.



Returning to automatic measurement mode

When you are in automatic measurement mode and select a noise source with resistor characteristics, the application automatically selects the manual measurement mode.

When you are in manual measurement mode and select a noise source with diode characteristics, you have to select the automatic measurement mode deliberately in the "Sweep" menu.

4.3 DUT Types

Noise figure measurements are possible on DUTs with a wide variety of characteristics. The DUT characteristics are important to know because they not only have an effect on the test setup, but also determine the way the application populates the frequency list in case of swept measurements.

The Noise Figure Measurements application supports measurements on DUTs that work on a fixed frequency as well as measurements on frequency-converting DUTs.

- [Measurements on Linear DUTs \(Direct Measurement\)](#)..... 28
- [Measurements on Frequency Converting DUTs](#).....28

4.3.1 Measurements on Linear DUTs (Direct Measurement)

In case of a linear DUT, the RF frequency remains the same between its input and output. For measurements on such DUTs, it is sufficient to measure the signal's RF frequency without any additional equipment (like a local oscillator). A typical linear DUT is, for example, an amplifier.

The test setup for measurements on such DUTs usually consists of the noise source, the DUT and an analyzer. If necessary, the measurement also considers loss that might occur somewhere in the measurement path.

If you are measuring linear DUTs, the contents and layout of the "Overview" dialog box represents the configuration of a typical test setup.



4.3.2 Measurements on Frequency Converting DUTs

A frequency converting DUT converts the RF frequency to an intermediate frequency (IF) using the local oscillator (LO). A frequency-converting DUT either converts the RF frequency to a lower IF (down-conversion) or a higher IF (up-conversion).

The conversion process requires a local oscillator in the test setup. You can generate the LO signal in two ways.

- An external generator controlled by the analyzer via IEC bus.

- A VCO controlled by a voltage source.

If you have selected a frequency-converting DUT measurement mode, the layout of the "Overview" dialog box adds the local oscillator to the test setup.

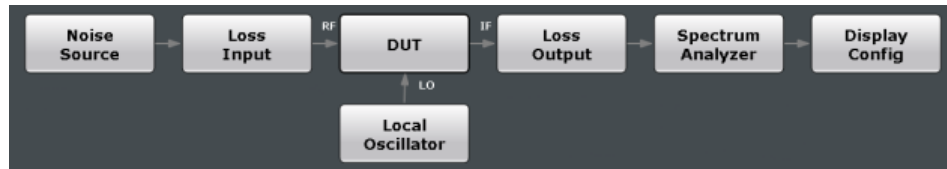

The local oscillator can have a fixed or a variable frequency. If the LO frequency is fixed, the intermediate frequency (IF) resulting from the conversion process is variable (depending on the input signal). If the LO frequency is variable, the IF has to be fixed. The application provides measurement for both measurement scenarios.

Fixed intermediate frequency

If you select one of the fixed IF measurement modes, the IF is the same for all entries in the frequency list. The LO frequency for each entry is variable and is the result of the equation the selected mode is based on.

- $f_{RF} - f_{IF}$ for up-converters
- $f_{RF} + f_{IF}$ for down-converters

The fixed IF measurement modes are, for example, useful for measurements on mixers.

Note that fixed IF measurements are only possible if the R&S FSW is equipped with the optional External Generator Control hardware. For more information see [Chapter 4.4, "External Generator Control"](#), on page 29.

Fixed LO frequency

If you select one of the fixed LO measurement modes, the LO frequency is the same for all entries in the frequency list. The IF frequency for each entry is variable and is the result of the equation the selected mode is based on.

- $f_{RF} + f_{LO}$ for up-converters
- $f_{RF} - f_{LO}$ for down-converters

The fixed LO measurement modes are, for example, required for measurements on satellite converters.

4.4 External Generator Control

To perform fixed IF measurements with the Noise Figure application, you have to install the optional External Generator Control hardware. This option allows you to control an external generator and the type of signal it generates.

The typical measurement setup for such measurements includes the R&S FSW equipped with the optional Noise Figure Measurements application, a signal generator and

the DUT. The signal generator is controlled either via the the LAN connection or the GPIB interface. The GPIB interface is part of the optional External Generator Control hardware.

To enhance the measurement accuracy, it is recommended to use a common reference frequency for both R&S FSW and signal generator in the measurement setup.

If you have no 10 MHz reference frequency on hand, you can use the internal reference signal of the R&S FSW or signal generator. For more information see the documentation of the R&S FSW or the signal generator.

Signal generator support

The R&S FSW-B10 supports various signal generators. A list is available in the user interface (see [Generator Type](#)) and in the documentation of the R&S FSW.

Note that you have to specifically select the generator for the Noise Figure Measurements application. It does not inherit the generator settings from other applications.

It is also possible to add new signal generators to that list. To do so, you have to copy a custom signal generator setup file with the file extension `.gen` to the R&S FSW. The setup file defines the frequency and power ranges supported by the generator, as well as information required for communication. You can use a setup file of the signal generators already supported as a template. After you copy it to the R&S FSW, the new generator model is added to the dropdown menu.

The existing setup files can be displayed in an editor in read-only mode directly from the [Interface Configuration](#) dialog box.

Make sure to adhere to the required syntax and commands and only change the values of the parameters. Errors are only detected and displayed when you try to use the custom generator.

Error and status messages

The following status and error messages may occur during external generator control.

Message	Description
"Ext. Generator GPIB Handshake Error!" / "Ext. Generator TCPIP Handshake Error!" / "Ext. Generator TTL Handshake Error!"	Connection to the generator is not possible, e.g. due to a cable damage or loose connection or wrong address.
"Ext. Generator Limits Exceeded!"	The allowed frequency or power ranges for the generator were exceeded.
"Reverse Sweep via min. Ext. Generator Frequency!"	Reverse sweep is performed; frequencies are reduced to the minimum frequency, then increased again.
"Ext. Generator File Syntax Error!"	Syntax error in the generator setup file.
"Ext. Generator Command Error!"	Missing or wrong command in the generator setup file.
"Ext. Generator Visa Error!!"	Error with Visa driver provided with installation (very unlikely).

NOTICE**Risk of damage to the instrument**

For yielding highest sensitivity during the measurement, the Noise Figure Measurements application automatically sets the input attenuation to 0 dB.

Because this configuration minimizes the overrange reserve, make sure that the signal you have applied does not cause to an overload condition (pay attention to the LO feedthrough). An overload condition may damage or destroy the input mixer.

The R&S FSW shows a corresponding message in the status line if an overload occurs ("RF OVLD" or "IF OVLD").

To avoid an overload

- reduce the LO feedthrough of the mixer device
or
- increase the reference level.

4.5 Image Frequency Rejection

Frequency converting DUTs convert a radio frequency (RF) to an intermediate frequency (IF). The IF is lower than the RF in case of down-converting DUTs and higher than the RF in case of up-converting DUTs.

In a basic test setup, the image frequency of the RF signal is also converted to the IF. Depending on the DUT, this effect may be wanted or even necessary, or not. To avoid measurement errors of the noise figure and gain of up to 3 dB, make sure to use the appropriate measurement configuration.

Basically, you can distinguish between single sideband (SSB) mixers and double sideband (DSB) mixers or those that partly suppress a sideband. If a sideband is not needed or only partly needed, you can reject the image frequency. If you do so, the application activates a filter that suppresses the image frequency to a certain extent.

The following illustrations help you to configure the measurement in order to measure correctly.

For more information on how to configure image rejection see "[Image Rejection](#)" on page 48.

Double sideband measurements

Double sideband mixers use both sidebands to the same extent. Both RF and image frequency should be converted. In that case, you have to turn image rejection off.

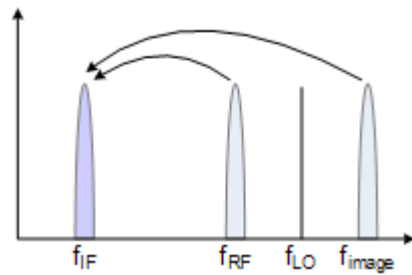

f_{LO} = frequency of the local oscillator
 f_{IF} = intermediate frequency = $f_{RF} \pm f_{LO}$
 f_{RF} = lower sideband = $f_{LO} - f_{IF}$
 f_{image} = upper sideband = $f_{LO} + f_{IF}$

If image rejection is on, the results have a 3 dB error - noise figure results are 3 dB lower than they should be, gain results are 3 dB higher than in reality.

Single sideband measurements

Single sideband mixers use a single sideband only. In that case, you have to suppress the sideband that is not required. If you do so, the measurement is pretty straightforward and works like a measurement on an amplifier.

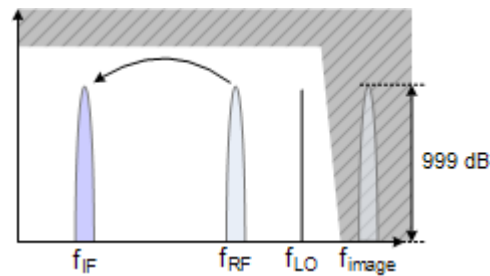

To suppress a sideband completely, it is best to set the image rejection to the maximum amount possible (999.99 dB).

Partial sideband suppression

For measurements on mixers with a low image frequency rejection, there are two test scenarios.

- Mixers whose image rejection is known.
- Mixers whose image rejection is unknown.

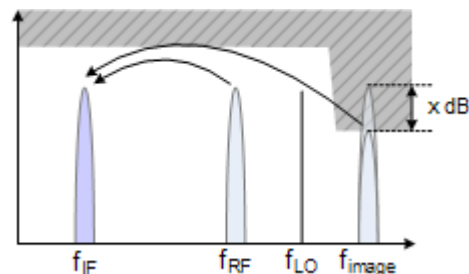

In case of mixers whose image rejection is known, define the magnitude of image rejection in dB as accurate as possible. Else, measurement results (noise figure and gain) will deviate between 0 dB to 3 dB.

For accurate measurements on mixers whose image rejection characteristics are unknown a custom test setup including an additional filter is required. You also have to know the gain characteristics of the DUT.

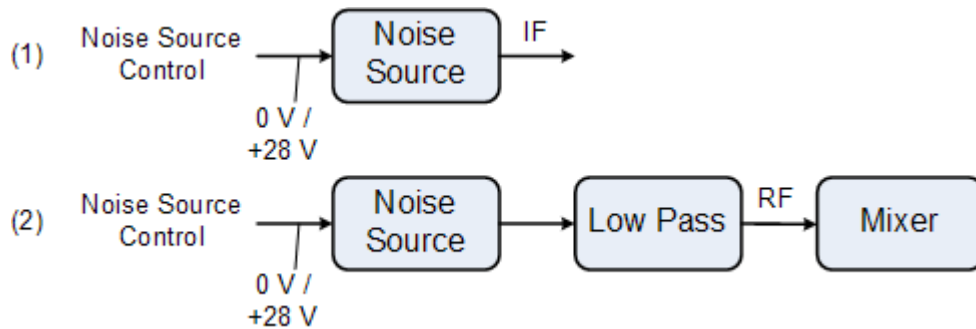

- (1) = Test setup for calibration
 (2) = Test setup for noise measurement

In the test setup shown above, a lowpass filter prevents unwanted noise from being fed in at the image frequency.

Depending on the position of the frequency bands, a highpass or bandpass filter may also be necessary for the RF frequency instead of the lowpass filter. The important point is that unwanted noise is not converted by a further receive path of the mixer. The unwanted noise at the receive frequency must not be reduced. The insertion loss must be considered, if applicable.

With this test setup, the measurement on a mixer without sideband suppression is the same as SSB measurements.

To take the characteristics of the filter into account, include the insertion loss of the filter at the RF. To consider the actual filter suppression at the image frequency, include the actual attenuation for the image rejection.

Harmonics mixer measurement

For a harmonics mixer, the input signals are not only converted to the IF by the wanted harmonic, but also by the harmonic of the LO signal produced in the mixer. In many cases, the mixer even features a lower conversion loss in the case of unwanted harmonics. For measurements on this type of mixer, you have to use a bandpass filter to make sure that there is only noise at the desired input frequency at the input of the DUT. This measurement is similar to measurements on a mixer with an average sideband suppression.

4.6 Calibration (2nd Stage Correction)

The calibration procedure of the application measures the inherent noise of the R&S FSW you are using. Performing calibration therefore is recommended as it increases the accuracy of measurement results. The results get more accurate because the

application takes the inherent noise of the analyzer into account while it calculates the results.

Calibration for noise figure measurements is also known as 2nd stage correction. This term is used because in a typical noise figure test setup, the DUT represents the first stage and the analyzer the second stage in the test setup.



The 2nd stage correction is a calibration that is specific to noise figure measurements. It is independent of the overall calibration state of the analyzer and does not calibrate the analyzer.

For successful calibration, you need additional equipment.

- Noise source
The noise source is like a calibration standard. It provides a reference with known noise characteristics that allows the application to determine the inherent noise of the analyzer you are using.

During the calibration, the application measures the inherent noise characteristics of the analyzer at the set of measurement frequencies.

Thus, the 2nd stage correction is valid for a particular instrument configuration, the room temperature and the instrument temperature. As long as this configuration stays the same, calibration data remains valid.



Calibrating single frequency measurements

Like all other measurements of the Noise Figure application, single frequency measurements should be performed in a calibrated state for increased accuracy.

Note that there is an easy way to calibrate single frequency measurements, if you have calibrated the application for swept or list measurements and the single frequency is part of the frequency list. In that case the measurement is already calibrated for that frequency and no more steps are necessary. The application recalls the last calibration values when you switch back to sweep mode or frequency table mode.

Only if you use a single frequency that is not part of the frequency list (or use a completely different frequency outside the calibrated range) will calibration become invalid and you should calibrate this frequency point.

- Interpolation
If you change the frequency and the frequency span stays the same or gets smaller, the application interpolates the correction data for the new measurement points instead of requesting a new calibration.
Measurements based on interpolated data might result in an increased measurement uncertainty. Highly accurate measurements that conform to the values specified in the data sheet are only possible at calibrated measurement points.
Note that useful interpolation is possible only if essential calibration parameters (e.g. impedance or attenuation) change only slightly. This is the case if the distance between the original calibration points has been sufficiently small.
If the span increases compared to the span during calibration, a new calibration is necessary.

If the application interpolates the calibration data, it shows a corresponding label in the channel bar and a warning message in the status bar.

- Invalid calibration

If you change one of the amplitude parameters (e.g. the attenuation), calibration is labeled invalid. In that case, calibration is not accurate, because the settings are not in line with the settings at the time the R&S FSW has been calibrated. If calibration is invalid, repeat the calibration or restore the settings as they were during the calibration.



Saving calibration data

If you save the current configuration or measurement results to a data set, calibration data is part of that data set.

For more information on saving and restoring data sets see chapter "Storing and Recalling Instrument Settings and Measurement Data" in the user manual of the R&S FSW.

The picture below shows a typical calibration setup that includes a noise source.

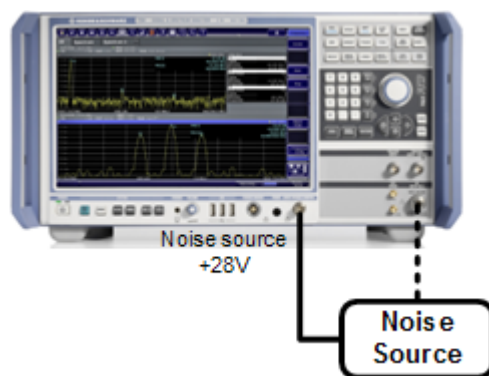

Figure 4-1: Noise figure calibration setup

1. Connect the noise source directly and without a cable to the RF input of the analyzer.
2. Connect the noise source to the +28 V voltage supply (Noise Source interface) on the back of the R&S FSW.
To connect the noise source to the voltage supply, you need a coaxial cable.

After you have set up calibration, there are several ways to start calibration.

- In the "Noise Overview" dialog box, press the "Calibrate" button.
- In the "Sweep" menu, press the "Calibrate" softkey.

4.7 Separating Signals by Selecting an Appropriate Resolution Bandwidth

The resolution bandwidth defines the 3 dB bandwidth of the resolution filter to be used. An RF sinusoidal signal is displayed according to the passband characteristic of the resolution filter (RBW), i.e. the signal display reflects the shape of the filter.

The highest sensitivity is obtained at the smallest bandwidth (1 Hz). If the bandwidth is increased, the reduction in sensitivity is proportional to the change in bandwidth. Increasing the bandwidth by a factor of 3 increases the displayed noise by approx. 5 dB (4.77 dB precisely). If the bandwidth is increased by a factor of 10, the displayed noise increases by a factor of 10, i.e. 10 dB.

The higher spectral resolution with smaller bandwidths is won by longer sweep times for the same span. The sweep time has to allow the resolution filters to settle during a sweep at all signal levels and frequencies to be displayed.

If the RBW is too large, signal parts that are very far away (e.g. from a different signal) are considered in the measurement and distort the results. The displayed noise increases.

If the RBW is too small, the measurement time increases.

4.8 Analyzing Several Traces - Trace Mode

The trace mode determines the way the data is processed and displayed. The application provides the following trace modes.

Table 4-1: Overview of available trace modes

Trace Mode	Description
Blank	Hides the selected trace.
Clear Write	Overwrite mode: the trace is overwritten by each sweep. This is the default setting.
View	The current contents of the trace memory are frozen and displayed.



Each time the trace mode is changed, the selected trace memory is cleared.

The default trace mode for the first trace is Clear/Write. For trace 2-4, the default trace mode is Blank. If you require another mode, you have to set it manually.

As you can have up to four traces simultaneously, you can compare the results with different measurement configurations, e.g. if you freeze a trace and use it as a memory trace.

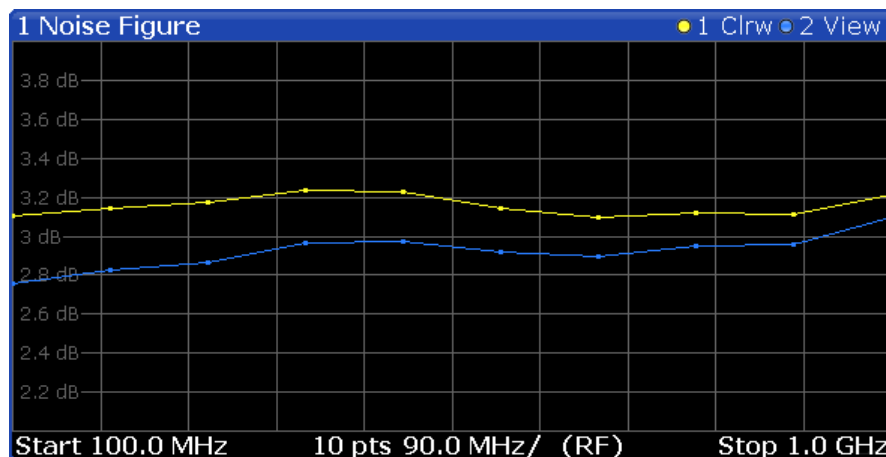

If you change the scaling of the y-axis, the R&S FSW automatically adapts the trace data to the changed display range. This allows an amplitude zoom to be made after the measurement in order to show details of the trace.

4.9 Using Markers

Markers are used to mark points on traces, to read out the results of a particular measurement point or compare results of different traces. The noise application provides four markers.

When you activate a marker, the application automatically positions it on the first measurement point (left border of the diagram) of trace 1, regardless of how many traces are active. A marker is always positioned on the same horizontal position in all active measurement windows. If you change the position of a marker in one window, the application adjusts the position of that marker in all other measurement windows. Thus, the marker results for a specific marker are always for the same frequency, which makes it easier to compare results.



Markers in single frequency mode

When you use a marker for single frequency measurements, the marker is positioned on a particular index value and not a particular measurement point. This means that during continuous measurements, the marker remains on the index value you have put it on and will not move down the line with the results.

To move a marker, you can use several methods.

- Enter a particular measurement frequency in the input field that opens when you activate a marker.
- Move the marker around with the rotary knob or the cursor keys.
- Drag the marker around using the touchscreen.

All markers can be used either as normal markers or delta markers. A normal marker indicates the absolute signal value at the defined position in the diagram. A delta

marker indicates the value of the marker relative to the specified reference marker (by default marker 1).

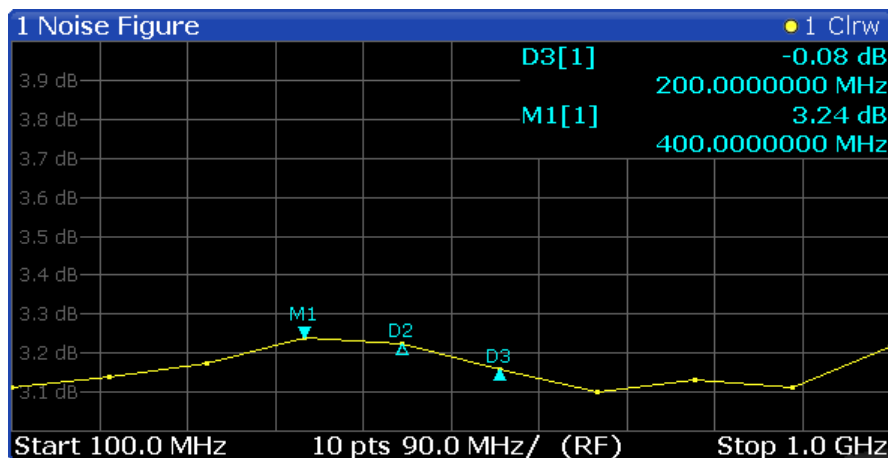

The application always positions the marker on the trace with the lowest number that is in Clear/Write trace mode. To set the marker on another trace, use the Marker to Trace function. With this function, you can also position a marker on a trace that is in View trace mode, e.g. to compare measurement results. Note that at least one active marker has to be a normal marker.

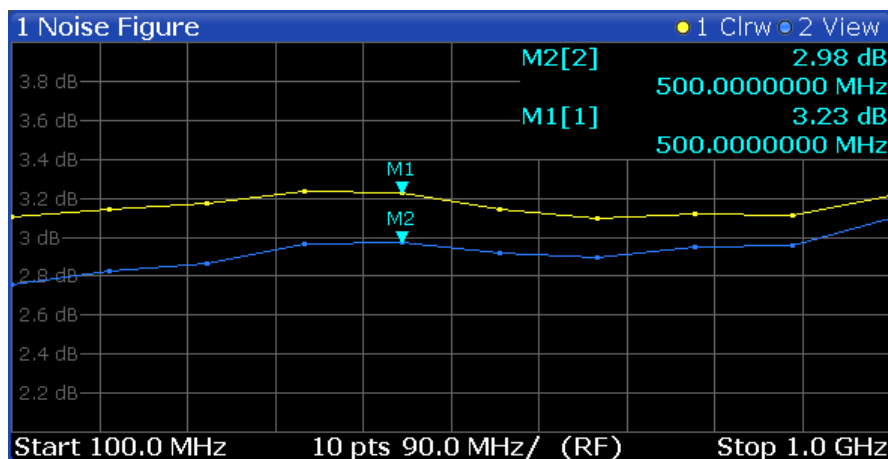

The application shows the results at the marker position directly in the diagram area (up to two markers) or in the marker table (if you use more than two markers).

Marker information in diagram area

By default, the results of the last two markers or delta markers that were activated are displayed in the diagram area.



The following information is displayed there:

- The marker type (M for normal, D for delta, or special function name)
- The marker number (1 to 4)
- The assigned trace number in square brackets []
- The marker value on the y-axis
- The marker position on the x-axis

Marker information in marker table

In addition to the marker information displayed within the diagram area, a separate marker table may be displayed in a separate window. For more information on the contents of the marker table see "[Marker Table](#)" on page 22.

5 Configuration

Noise figure measurements require a special application on the R&S FSW, which you activate using the MODE key.



The Noise Source Control connector on the R&S FSW is also a prerequisite for the R&S FSW Noise measurements application. Without this connector, no measurement can be performed.

When you activate a measurement channel in the Noise application, a measurement for the input signal is started automatically with the default configuration. The "Noise Figure" menu is displayed and provides access to the most important configuration functions.



Unavailable hardkeys

Note that the AMPT, AUTO SET, BW, TRIG and MKR FUNC keys have no contents and no function in the Noise Figure application.

• Configuration Overview	40
• Defining the Measurement Frequency	42
• Selecting DUT Characteristics	47
• Configuring the Noise Source	48
• Configuring Additional Loss	54
• Configuring the Analyzer	57
• Using the Uncertainty Calculator	61
• Performing Measurements	66
• Configuring Inputs and Outputs of the R&S FSW	68

5.1 Configuration Overview



Throughout the measurement channel configuration, an overview of the most important currently defined settings is provided in the "Overview". The "Overview" is displayed when you select the "Overview" icon, which is available at the bottom of all softkey menus.

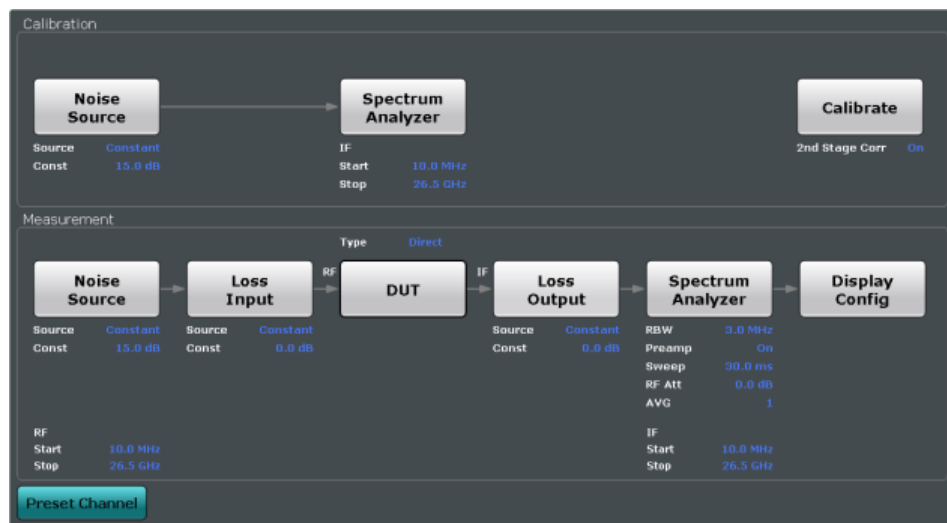

In addition to the main measurement settings, the "Overview" provides quick access to the main settings dialog boxes. The individual configuration steps are displayed in the order of the data flow. Thus, you can easily configure an entire measurement channel from input over processing to output and analysis by stepping through the dialog boxes as indicated in the "Overview".

In particular, the "Overview" provides quick access to the following configuration dialog boxes (listed in the recommended order of processing):

1. Noise Source
See [Chapter 5.4, "Configuring the Noise Source"](#), on page 48.
2. Spectrum Analyzer
See [Chapter 5.6, "Configuring the Analyzer"](#), on page 57.
3. Input and Output Losses
See [Chapter 5.5, "Configuring Additional Loss"](#), on page 54.

To configure settings

- ▶ Select any button in the "Overview" to open the corresponding dialog box.
Select a setting in the channel bar (at the top of the measurement channel tab) to change a specific setting.

Preset Channel

Select the "Preset Channel" button in the lower lefthand corner of the "Overview" to restore all measurement settings **in the current channel** to their default values.

Note that the PRESET key restores the entire instrument to its default values and thus closes **all measurement channels** on the R&S FSW (except for the default Spectrum application channel)!

Remote command:

`SYSTem:PRESet:CHANnel[:EXECute]` on page 106

Specifics for

The measurement channel may contain several windows for different results. Thus, the settings indicated in the "Overview" and configured in the dialog boxes vary depending on the selected window.

Select an active window from the "Specifics for" selection list that is displayed in the "Overview" and in all window-specific configuration dialog boxes.

The "Overview" and dialog boxes are updated to indicate the settings for the selected window.

5.2 Defining the Measurement Frequency

The "DUT" button or the "Frequency Settings" softkey open a dialog to configure the measurement frequencies.

- [Defining a Frequency Set](#).....42
- [Configuring Single Frequency Measurements](#).....45
- [Using a Frequency Table](#).....46

5.2.1 Defining a Frequency Set

Access: "Overview" > "DUT" > "Frequency Config" > "Tuning Mode: Sweep"

The "Frequency Config" tab in the "Frequency Settings" dialog box contains settings that define the frequency characteristics for the measurement.

The information in this tab is also the basis for an automatic population of the frequency table. All parameters of this dialog are interdependent. If you change one parameter, at least one other parameter will be changed by the application.



In order to get accurate results, changing a frequency set may require a new calibration.



Preamplifier

If a preamplifier is used, make sure the defined (and possibly upconverted) IF frequencies for the measurement stay below the maximum frequency the preamplifier supports. For the R&S FSW-B22 option, the maximum frequency is 7 GHz. However, the preamplifier can be activated or deactivated individually for different tuning modes. For example, for a sweep mode which requires a span above 7 GHz it is deactivated, while for a single frequency measurement at 1 GHz it can be activated.

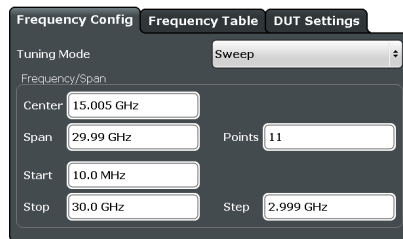

Tuning Mode.....	43
Center.....	43
Span.....	44
Start and Stop Frequency.....	44
(Measurement) Points.....	44
Step.....	44

Tuning Mode

Selects the tuning or measurement mode.

For more information see [Chapter 4.1, "Tuning Modes"](#), on page 24.

Tuning mode selection is also available via softkeys ("Sweep Mode", "Frequency Table Mode", "Single Frequency Mode") in the "Sweep" menu.

Note: A preamplifier can be activated or deactivated individually for different tuning modes. When you switch tuning modes, the defined preamplifier state is adapted.

"Sweep"	The measurement is based on an automatically generated frequency set.
"Frequency Table"	The measurement is based on a customized frequency table. For more information see Chapter 5.2.3, "Using a Frequency Table" , on page 46.
"Single Frequency"	The measurement measures a single frequency only. For more information see Chapter 5.2.2, "Configuring Single Frequency Measurements" , on page 45.

Remote command:

Frequency list measurement:

[\[SENSe:\]CONFigure:LIST:CONTInuous](#) on page 117

[\[SENSe:\]CONFigure:LIST:SINGLE](#) on page 117

Single frequency measurement:

[\[SENSe:\]CONFigure:FREQuency:CONTInuous](#) on page 116

[\[SENSe:\]CONFigure:FREQuency:SINGLE](#) on page 116

Center

Defines the center of the measurement frequency range.

If you change the center frequency, the application will change the start and stop frequency according to the span you have set.

The "Center" setting is also available via the **FREQ** key.

Remote command:

Frequency list measurement:

[\[SENSe:\]FREQuency:CENter](#) on page 117

Single frequency measurement:

[\[SENSe:\] FREQuency: SINGLe](#) on page 118

Span

Defines the measurement span.

If you change the span, the application will change the start frequency, the stop frequency and the stepsize according to the center frequency and the measurement points.

The "Span" setting is also available via the SPAN key.

Remote command:

[\[SENSe:\] FREQuency: SPAN](#) on page 118

Start and Stop Frequency

Defines the start and stop frequencies.

If you change the start or stop frequency, the application will change the center frequency, the span and the measurement points according to the stop or start frequency and the stepsize.

The "Start" and "Stop" settings are also available via the FREQ key.

Remote command:

Start frequency:

[\[SENSe:\] FREQuency: START](#) on page 119

Stop frequency:

[\[SENSe:\] FREQuency: STOP](#) on page 119

(Measurement) Points

Defines the measurement points.

In case of frequency list measurements, the number of measurement points corresponds to the number of entries in the frequency table and therefore the number of measurements displayed in the graphical results.

If you change the measurement points, the application will change the stepsize according to the span.

The "Points" setting is also available via the SPAN key.

Remote command:

[\[SENSe:\] SWEep: POINTs](#) on page 118

Step

Defines the frequency step size in the frequency table.

The stepsize corresponds to the distance between two consecutive measurement points.

If you change the stepsize, the application will change the measurement point according to the span.

The "Stepsize" setting is also available via the FREQ key.

Remote command:

[\[SENSe:\] FREQuency: STEP](#) on page 119

5.2.2 Configuring Single Frequency Measurements

Access: "Overview" > "DUT" > "Frequency Config" > "Tuning Mode: Single Frequency"

The "Frequency Config" tab in the "Frequency Settings" dialog box contains settings that define the frequency characteristics for the measurement.



In order to get accurate results, changing the frequency may require a new calibration.

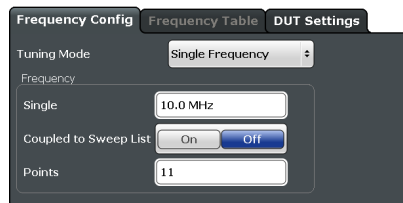

Single (Frequency).....	45
Coupled to Sweep List.....	45
(Measurement) Points.....	45

Single (Frequency)

Defines the frequency that the single frequency measurement is performed on.

The "Single" setting is also available via the FREQ key.

Remote command:

[SENSe:]FREQuency:SINGle on page 118

Coupled to Sweep List

Couples or decouples frequency selection to the contents of a sweep list.

If you couple the frequency to the sweep list, the application allows you to select only the frequencies currently part of the frequency list. If you enter another frequency, the application automatically selects the nearest frequency of the frequency list. If the frequency list has been calibrated previously, calibration remains valid for those frequencies when you change the tuning mode.

If you turn the coupling off, you can define any frequency for single frequency measurements. Note however, that it may become necessary to calibrate the measurement for that frequency.

Remote command:

[SENSe:]FREQuency:SINGle:COUPling on page 118

(Measurement) Points

Defines the number of measurement points for single frequency measurements.

In case of single frequency measurements, the number of measurement points corresponds to the number of measurements (index values) performed on a single frequency.

For more information see "Single frequency measurements" on page 15.

The "Points" setting is also available via the SPAN key.

Remote command:

[SENSe:] SWEep: POINTs on page 118

5.2.3 Using a Frequency Table

Access: "Overview" > "DUT" > "Frequency Config" > "Tuning Mode: Frequency Table"

The "Frequency Table" tab in the "Frequency Settings" dialog box contains functionality to manage the measurement frequencies.

The application populates the table according to the information you have entered in the "Frequency Config" tab if you press the "Populate Table" button.

Note that changes to the frequency table take effect only if you have selected the "Frequency Table" tuning mode.

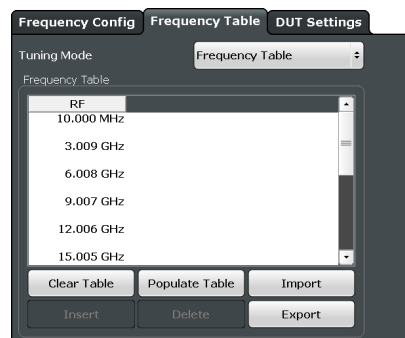

Frequency Table.....	46
Clear Table.....	46
Populate Table.....	47
Insert.....	47
Delete.....	47
Import / Export.....	47

Frequency Table

Shows the current measurement points.

The table is made up of one column that represents the measurement frequency. Each frequency corresponds to one measurement point. The length of the table is variable.

When you perform measurements in "Sweep" or "Single Frequency" tuning mode, the contents of the table have no effect on the measurement.

When you select a table entry in "Frequency Table" tuning mode, you can edit it or add a new frequency below the selected frequency. A new frequency has to be greater than the last table entry and smaller than the next table entry.

Clear Table

Deletes the contents of the table.

Populate Table

Populates or restores the measurement frequencies based on the center frequency, the start and stop frequencies, the span, the stepsize and the number of measurement points.

Remote command:

[SENSe:] FREQuency: TABLE: DATA on page 117

Insert

Inserts a new measurement point above the one you have selected.

Delete

Deletes the currently selected measurement point.

Import / Export

Opens a dialog box to select an ENR table to import or export.

An import copies the ENR table into the default ENR table directory. An export copies the table to a location outside the default ENR table directory, e.g. a memory stick. The file extension has to be *.freq.

5.3 Selecting DUT Characteristics

Access: "Overview" > ""

The "DUT" button opens a dialog box to configure the characteristics of the DUT you are testing. The dialog box contains a schematic overview of the DUT input and output characteristics and the way it is integrated into the test setup.

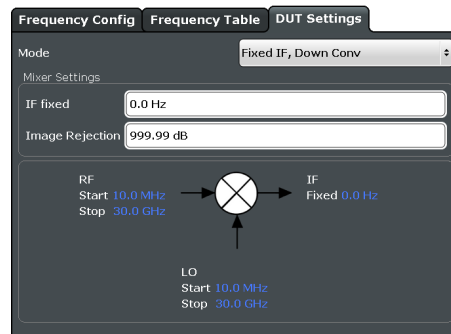

Mode.....	47
LO Fixed.....	48
IF Fixed.....	48
Image Rejection.....	48

Mode

Selects the measurement mode.

The measurement mode you should use depends on the type of DUT you are testing. For more information see [Chapter 4.3, "DUT Types"](#), on page 28.

Note: For upconverting measurements, if a preamplifier is used, make sure the upconverted frequencies for the measurement stay below the maximum frequency the preamplifier supports.

Remote command:

DUT Type: [\[SENSe:\]CONFigure:MODE:DUT](#) on page 121

LO Type: [\[SENSe:\]CONFigure:MODE:SYSTem:LO](#) on page 120

LO Fixed

Defines a fixed LO frequency for measurements on frequency-converting DUTs with a fixed LO.

After you have defined the LO frequency, the application updates the frequency list accordingly.

The "LO" setting is also available via the **FREQ** key.

Remote command:

[\[SENSe:\]CONFigure:MODE:SYSTem:LO:FREQuency](#) on page 120

IF Fixed

Defines a fixed intermediary frequency (IF) for measurements on frequency-converting DUTs with a fixed IF.

After you have defined the intermediary frequency, the application updates the frequency list accordingly.

The "IF" setting is also available via the **FREQ** key.

Remote command:

[\[SENSe:\]CONFigure:MODE:SYSTem:IF:FREQuency](#) on page 120

Image Rejection

Turns image rejection of the DUT on and off.

If you set an image rejection of 0 dB, the image frequency passes completely. If you set a high image rejection (up to 999.99 dB), the image frequency is suppressed completely. For DUTs that have a partial image rejection, define the amount of suppression.

For more information see [Chapter 4.5, "Image Frequency Rejection"](#), on page 31.

Remote command:

[\[SENSe:\]CORRection:IREJection](#) on page 121

5.4 Configuring the Noise Source

It is necessary to specify characteristics of the noise source you are using as close as possible in order to get accurate measurement results. The noise source characteristics are used to calculate the effective noise temperature of the noise source. The noise source characteristics should be supplied by its manufacturer.

- [Selecting the Type of Noise Source](#).....49
- [Defining the Noise Source Characteristics](#).....49
- [Using an ENR or Temperature Table](#).....52

5.4.1 Selecting the Type of Noise Source

Access: "Overview" > "Noise Source" > "ENR / Temp Settings" > "Noise Source"

The application allows you to use different kinds of noise sources, depending on the type of measurement you would like to perform.

- Diode
Selects a noise source with diode characteristics. The frequency characteristics of the noise source are defined by the Excess Noise ratio (ENR).
- Resistor
Selects a test setup that uses two resistors which act as a noise source. One of the resistors has a low noise or ambient temperature (a cold resistor), the other has a high noise or ambient temperature (a hot resistor). The noise characteristics of the resistor are defined by its noise temperatures T_{hot} and T_{cold} .
 T_{hot} is temperature of the resistor when it is turned on. T_{cold} is the temperature of the resistor when it is turned off.

You can select the type of noise source and its characteristics independently for the [Calibration](#) and the [Measurement](#). When you select the resistor noise source, the application automatically starts the [manual measurement mode](#) and communicates that fact with a message at the bottom of the dialog box.

Measurement mode was toggled to manual
(it can be changed in the Sweep menu)

Remote command:

Measurement: `[SENSe:]CORRection:ENR[:MEASurement]:TYPE` on page 128

Calibration: `[SENSe:]CORRection:ENR:CALibration:TYPE` on page 124

5.4.2 Defining the Noise Source Characteristics

Access: "Overview" > "Noise Source" > "ENR / Temp Settings"

The noise characteristics of noise sources with diode characteristics are usually defined by their ENR (Excess Noise Ratio). The noise characteristics of noise sources with resistor characteristics are defined by their noise (or ambient) temperatures (T_{hot} and T_{cold}). T_{cold} is typically at a very low temperature of liquid nitrogen or liquid helium.

Both noise source types may have different ENR values during the calibration and the measurement stage. You can use either the same type of noise source for both calibration and measurement, or use different types of noise sources for calibration and measurement.

Measurement.....	50
Common Noise Source.....	50
Calibration.....	51
Temperature.....	51

Measurement

Selects the source of the ENR or temperature values.

The frequency characteristics may be approximated by a constant or be based on a ENR or temperature table.

If the ENR or temperature is a constant, the same values are used for all frequencies in the frequency table. If you have selected a constant ENR, you have to define its magnitude in the input field next to the radio button. If you have selected a constant temperature, you have to define the temperatures of the resistor in the input fields next to the radio button. T_{hot} is the temperature of a resistor with a low noise or ambient temperature; T_{cold} is the temperature of a resistor with a high noise or ambient temperature.

If the noise characteristics are based on a table, the ENR level and temperatures typically depend on the measurement frequency. You can select an existing table from the dropdown menu next to the radio button, if it is active. For more information on ENR and temperature tables see [Chapter 5.4.3, "Using an ENR or Temperature Table"](#), on page 52.

When "Common Noise Source" is on, the ENR is used for both measurement and calibration.

Remote command:

ENR mode: `[SENSe:]CORRection:ENR[:MEASurement]:MODE` on page 127

Constant ENR: `[SENSe:]CORRection:ENR[:MEASurement]:SPOT` on page 127

Select table: `[SENSe:]CORRection:ENR[:MEASurement]:TABLE:SElect` on page 126

Constant temperature: `[SENSe:]CORRection:ENR[:MEASurement]:SPOT:COLD` on page 128

Constant temperature: `[SENSe:]CORRection:ENR[:MEASurement]:SPOT:HOT` on page 129

Common Noise Source

Turns the use of a common ENR on and off.

Common ENRs have the same characteristics for the measurement and calibration. If you turn common ENR off, you can define an additional ENR to be used during calibration.

This is recommended in case of measurements on frequency converting DUTs, if one noise source does not cover the frequency range at the DUT input (RF) and the frequency range for calibration (IF).

Remote command:

`[SENSe:]CORRection:ENR:COMMon` on page 124

Calibration

Selects the source of the ENR or temperature values used during calibration.

The frequency characteristics may be a constant or be based on a ENR or temperature table.

If the ENR or temperature is a constant, the same value is used for all frequencies in the frequency table. If you have selected a constant ENR, you can also define its value in the input field next to the radio button. If you have selected a constant temperature, you have to define the temperatures of the resistor in the input fields next to the radio button. T_{hot} is the temperature of a resistor with a low noise or ambient temperature; T_{cold} is the temperature of a resistor with a high noise or ambient temperature.

If the noise source characteristics are based on a table, the ENR level and temperature depend on the measurement frequency. In that case, the values are interpolated to the measurement points. You can select a table from the dropdown menu next to the radio button, if it is active. For more information on ENR tables see [Chapter 5.4.3, "Using an ENR or Temperature Table"](#), on page 52.

The calibration settings are available if the "Common Noise Source" is off.

Remote command:

ENR mode: `[SENSe:]CORRection:ENR:CALibration:MODE` on page 123

Constant ENR: `[SENSe:]CORRection:ENR:CALibration:SPOT` on page 123

Select table: `[SENSe:]CORRection:ENR:CALibration:TABLE:SElect` on page 123

Constant temperature: `[SENSe:]CORRection:ENR:CALibration:SPOT:COLD` on page 122

Constant temperature: `[SENSe:]CORRection:ENR:CALibration:SPOT:HOT` on page 122

Temperature

Defines the absolute room temperature in degree Celsius or Fahrenheit.

The room temperature is required for the calculation of the real ENR of the noise source, because an ENR table is based on a temperature of 290K.

To change the unit of the temperature from Celsius to Fahrenheit, change the date format from "DE" to "US" in the "General" display settings.

- Press the SETUP key.
- Press the "Display" softkey.
- Select the "General" tab.
- Select "DE" for Celsius or "US" for Fahrenheit.

Note: If you define the temperature via remote control, the unit is degree Kelvin.

Remote command:

[\[SENSe:\]CORRection:TEMPerature](#) on page 129

5.4.3 Using an ENR or Temperature Table

Access: "Overview" > "Noise Source" > "Table Settings"

The "Table Settings" tab in the "ENR/TEMP Settings" dialog box contains the functionality to create and edit ENR or temperature tables.

ENR or temperature tables contain the noise source characteristics for particular frequencies. If the table does not contain ENR or temperature values for one of the measurement frequencies, the application will interpolate between the values.

The "Table Settings" tab contains a list of ENR and temperature tables currently available on the R&S FSW and shows the table currently in use if the "ENR/TEMP Settings" are enabled.

In addition, the tab contains functionality to create new tables and modify existing ones.

Noise Source	52
New	52
Edit	53
Copy To	53
Delete	53
Import / Export Table	53
Edit Table	53

Noise Source

Selects the type of noise source you are using for the measurement.

The noise source type affects the data type that the table contains. In case of a "Noise Diode", the table contains the ENR values of the noise source you are using. In case of a "Resistor", the table contains the noise temperatures of the resistors (T_{hot} and T_{cold}).

For more information on the noise source types see [Chapter 5.4.1, "Selecting the Type of Noise Source"](#), on page 49.

Remote command:

[\[SENSe:\]CORRection:ENR\[:MEASurement\]:TYPE](#) on page 128

New

Opens the [Edit Table](#) dialog box to create a new table.

The contents of the dialog box are empty.

Remote command:

Table selection: [\[SENSe:\]CORRection:ENR:CALibration:TABLE:SElect](#)
on page 123

and: [\[SENSe:\]CORRection:ENR\[:MEASurement\]:TABLE:SElect](#) on page 126

Diode: [\[SENSe:\]CORRection:ENR\[:MEASurement\]:TABLE:DATA](#) on page 124

Resistor: [\[SENSe:\]CORRection:ENR\[:MEASurement\]:TABLE:TEMPerature\[:DATA\]](#) on page 126

Edit

Opens the [Edit Table](#) dialog box to modify the selected table.

Remote command:

Table selection: `[SENSe:]CORRection:ENR:CALibration:TABLE:SElect`

on page 123

and: `[SENSe:]CORRection:ENR[:MEASurement]:TABLE:SElect` on page 126

Diode: `[SENSe:]CORRection:ENR[:MEASurement]:TABLE:DATA` on page 124

Resistor: `[SENSe:]CORRection:ENR[:MEASurement]:TABLE:TEMPerature[:DATA]` on page 126

Copy To

Opens the [Edit Table](#) dialog box to modify the selected table and save it under a new name.

Delete

Deletes the selected table.

Remote command:

Diode: `[SENSe:]CORRection:ENR[:MEASurement]:TABLE:DElete`

on page 125

Resistor: `[SENSe:]CORRection:ENR[:MEASurement]:TABLE:TEMPerature:DElete` on page 127

Import / Export Table

Opens a dialog box to select a table to import or export.

An import copies the ENR or temperature table into the default table directory. An export copies the table to a location outside the default table directory, for example a memory stick. The file extension has to be *.enr.

Edit Table

Defines the noise source characteristics of a irregular noise source or the loss characteristics of additional measurement equipment.

The noise source and loss tables are made up of up to 500 data points. A data point consists of a frequency and its corresponding ENR, temperature or loss value. The ENR and temperature values should be supplied by the manufacturer of the noise source or resistor. The loss characteristics of measurement equipment should also be supplied by the manufacturer.

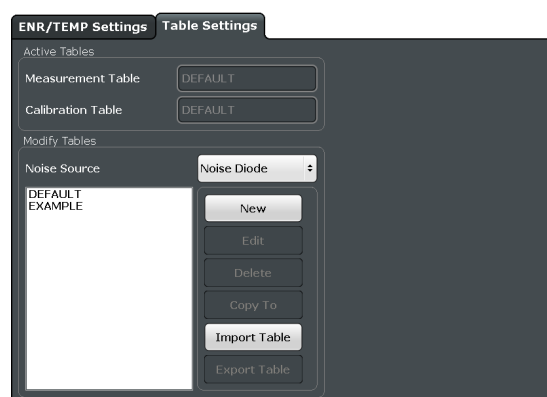

"Name"	Name of the ENR, temperature or loss table.
"Comment"	Comment for the ENR, temperature or loss table.
"Frequency"	Frequency of a particular ENR, temperature or loss value.
"Value"	ENR value or loss in dB. In case of a resistor, the characteristics of the resistor are defined by the noise temperatures T_{hot} and T_{cold} instead of a single value. The unit in that case is Kelvin (degrees).
"Clear Table"	Deletes the contents of the table (frequencies and values) or the loss table.
"Insert"	Inserts a new data point above the selected one.
"Delete"	Deletes the selected data point.
"Save"	Saves the table.
"Cancel"	Exits the "Edit Table" dialog box and returns to the result diagram.

Remote command:

Edit ENR table: `[SENSe:]CORRection:ENR[:MEASurement]:TABLE:DATA`

on page 124

Edit temperature table: `[SENSe:]CORRection:ENR[:MEASurement]:TABLE:TEMPerature[:DATA]` on page 126

Edit input loss table: `[SENSe:]CORRection:LOSS:INPut:TABLE` on page 130

Edit output loss table: `[SENSe:]CORRection:LOSS:OUTPut:TABLE` on page 132

5.5 Configuring Additional Loss

The "Loss Input"/"Loss Output" buttons or the "Loss Settings" softkey open a dialog to configure the loss characteristics of additional equipment in the test setup like cables or attenuators at the DUT input or output. The characteristics of these should be supplied by the manufacturer.

Note that loss is only taken into account during the measurement and not during calibration because the noise source is connected directly to the analyzer input.



Treatment of losses in case of resistor noise sources

When you are using a resistor as a noise source, it is not possible to change the loss characteristics.

When you change back to using a diode as a noise source, the previous loss settings are **not** restored. In that case, the best way to handle loss settings is to store them in a loss table to still have them available later on.

- [Defining Loss](#)..... 55
- [Using a Loss Table](#)..... 56

5.5.1 Defining Loss

Access: "Overview" > "Loss Input" / "Loss Output" > "Loss Settings"

The "Loss Settings" tab in the "Loss Settings" dialog box contains settings to define the loss characteristics of miscellaneous equipment in the test setup.

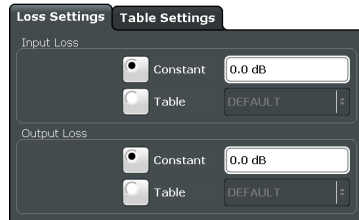

You can define the loss characteristics of the signal path to the DUT input and the signal path from the DUT output to the analyzer.



Input Loss	55
Output Loss	55

Input Loss

Selects the source of losses between the noise source and the DUT input.

The input loss is the sum of all losses caused by the measurement equipment. The loss may be constant or be based on a loss table.

If the loss is constant, the same loss is used for all frequencies in the frequency table. If you have selected a constant loss, you can also define its value in the input field next to the radio button.

If the loss is based on a table, the loss values are interpolated to the measurement frequencies. You can select a table from the dropdown menu next to the radio button, if it is active. For more information on loss tables see [Chapter 5.5.2, "Using a Loss Table"](#), on page 56.

Remote command:

Loss mode:

[\[SENSe:\]CORRection:LOSS:INPut:MODE](#) on page 130

Constant loss:

[\[SENSe:\]CORRection:LOSS:INPut:SPOT](#) on page 130

Select loss table:

[\[SENSe:\]CORRection:LOSS:INPut:TABLE:SELeCt](#) on page 131

Output Loss

Selects the source of loss between the DUT output and the RF input of the analyzer.

The output loss is the sum of all losses caused by the measurement equipment (e.g. connectors, cables or attenuators). The loss may be constant or be based on a loss table.

If the loss is constant, the same loss is used for all frequencies in the frequency table. If you have selected a constant loss, you can also define its value in the input field next to the radio button.

If the loss is based on a table, the loss values are interpolated to the measurement frequencies. You can select a table from the dropdown menu next to the radio button, if it is active. For more information on loss tables see [Chapter 5.5.2, "Using a Loss Table"](#), on page 56.

Remote command:

Loss mode:

[\[SENSe:\]CORRection:LOSS:OUTPut:MODE](#) on page 131

Constant loss:

[\[SENSe:\]CORRection:LOSS:OUTPut:SPOT](#) on page 131

Select loss table:

[\[SENSe:\]CORRection:LOSS:OUTPut:TABLE:SElect](#) on page 133

5.5.2 Using a Loss Table

Access: "Overview" > "Loss Input" / "Loss Output" > "Table Settings"

The "Table Settings" tab in the "Loss Settings" dialog box contains the functionality to create and edit loss tables.

Loss table contain the loss characteristics of additional frequency dependent equipment in the test setup. If you are using a loss table, the loss values may be different on each frequency that is measured. If the table does not contain a loss for one of the measurement frequencies, the application will interpolate between values.

The "Table Settings" tab contains a list of loss tables currently available on the R&S FSW and shows the tables you are currently using if you have selected one in the "Loss Settings" tab.

In addition, the tab contains functionality to create new tables and modify existing ones.

New	56
Edit	57
Copy To	57
Delete	57
Import / Export Table	57

New

Opens the [Edit Table](#) dialog box to create a new loss table.

The contents of the dialog box are empty.

Remote command:

Create input loss table:

[\[SENSe:\]CORRection:LOSS:INPut:TABLE](#) on page 130

Create output loss table:

[\[SENSe:\]CORRection:LOSS:OUTPut:TABLE](#) on page 132

Edit

Opens the [Edit Table](#) dialog box to modify the selected table.

Remote command:

Edit input loss table:

[\[SENSe:\]CORRection:LOSS:INPut:TABLE](#) on page 130

Edit output loss table:

[\[SENSe:\]CORRection:LOSS:OUTPut:TABLE](#) on page 132

Copy To

Opens the [Edit Table](#) dialog box to modify the selected table and save it under a new name.

Delete

Deletes the selected table.

Remote command:

Delete input loss table:

[\[SENSe:\]CORRection:LOSS:INPut:TABLE:DELeTe](#) on page 131

Delete output loss table:

[\[SENSe:\]CORRection:LOSS:OUTPut:TABLE:DELeTe](#) on page 132

Import / Export Table

Opens a dialog box to select a loss table to import or export.

An import copies the loss table into the default loss table directory. An export copies the table to a location outside the default loss table directory, e.g. a memory stick. The file extension has to be *.loss.

5.6 Configuring the Analyzer

The "Spectrum Analyzer" button or the "Meas Settings" softkey open the "Measurement Settings" dialog box to set up general measurement characteristics.

- [Configuring the Measurement](#).....57
- [Configuring Level Characteristics](#)..... 59

5.6.1 Configuring the Measurement

Access: "Overview" > "Spectrum Analyzer"

The measurement settings include parameters directly related to the measurement itself.

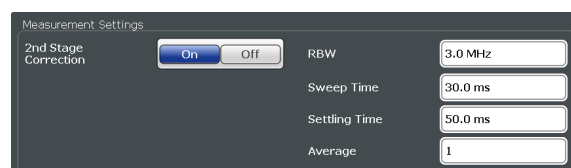

2nd Stage Correction.....	58
Resolution Bandwidth (RBW).....	58
Sweep Time.....	58
Settling Time.....	58
Average.....	58

2nd Stage Correction

Turns 2nd stage correction on and off.

If 2nd stage correction is on, the application excludes the inherent noise of the analyzer from the measurement results.

If 2nd stage correction is off, the application does not correct the measurement results, even if a valid calibration has been performed. Note that correction data does not get lost if you turn off the 2nd stage correction.

For more information see [Chapter 4.6, "Calibration \(2nd Stage Correction\)"](#), on page 33.

Remote command:

[\[SENSe:\]CONFigure:CORRection](#) on page 133

Resolution Bandwidth (RBW)

Defines the resolution bandwidth for the measurement.

For more information on the resolution bandwidth see [Chapter 4.7, "Separating Signals by Selecting an Appropriate Resolution Bandwidth"](#), on page 36.

Remote command:

[\[SENSe:\]BANDwidth\[:RESolution\]](#) on page 135

Sweep Time

Defines the sweep time for the measurement.

The sweep time is the time it takes the analyzer to perform a measurement at one measurement frequency.

Note that noise measurements perform two measurements during one sweep. One with the noise source turned on, one with the noise source turned off.

Remote command:

[\[SENSe:\]SWEep:TIME](#) on page 136

Settling Time

Defines the settling time of the DUT and the noise source.

Most noise sources need a certain amount of time to settle after you turn them on.

Low-frequency DUTs may require a certain time until its coupling capacitors have been charged or discharged. Both are defined as the settling time. For details on the settling time refer to the datasheet of the noise source.

Remote command:

[SYSTem:CONFigure:DUT:STIME](#) on page 137

Average

Defines the number of measurements that are used to average the results.

The more measurements you include in the averaging, the more accurate and stable the results will be. However, accuracy and stability comes at the price of measurement speed.

Remote command:

[SENSe:] SWEp:COUNT on page 136

5.6.2 Configuring Level Characteristics

Access: "Overview" > "Spectrum Analyzer"

The level and range settings configure all parameters related to the vertical diagram axis.



Ref Level.....	59
Auto Level Range.....	60
RF Attenuation.....	60
Preamplifier.....	60

Ref Level

Turns automatic determination of the reference level on and off.

The reference level is the power level the R&S FSW expects at the RF input. Keep in mind that the noise signal has a high crest factor. Thus, the reference level has to be set at the peak envelope power of the noise signal, not the mean power in order to avoid an instrument overload.

The reference level should be about 5 to 15 dB above the noise display that occurs with the DUT connected and the noise source activated.

To get the best dynamic range, you have to set the reference level as low as possible. At the same time, make sure that the maximum signal level does not exceed the reference level. If it does, it may overload the RF and IF stages of the analyzer, regardless of the signal power. Measurement results may deteriorate.

Note that the signal level at the A/D converter may be stronger than the level the R&S FSW displays, depending on the current resolution bandwidth. This is because the resolution bandwidths are implemented digitally after the A/D converter.

If automatic detection of the reference level is on, the application performs a measurement to determine the ideal reference level. The time of this measurement depends on the state of the "2nd Stage Correction".

- 2nd Stage Correction is on
The application determines the reference level before the calibration starts. The reference level is based on several test measurements on the start frequency. For more information see "Auto Level Range" on page 60.
- 2nd Stage Correction is off

The application determines the reference level before the measurement begins. The reference level is based on the measurement of the first frequency that is measured. After this measurement is done, the application resumes the measurement.

If manual selection of the reference level is on, you can define the reference level in the corresponding input field.

Note: Reference level. Even for DUTs with a high-ripple frequency response it might be useful to enter the reference level manually, because determining the reference level automatically might not always result in optimal settings.

Remote command:

Manual reference level:

`DISPlay[:WINDow<n>]:TRACe<t>:Y[:SCALe]:RLEVel` on page 133

Automatic reference level:

`DISPlay[:WINDow<n>]:TRACe<t>:Y[:SCALe]:RLEVel:AUTO` on page 134

Auto Level Range

Defines the maximum expected gain of the DUT.

The application uses the auto level range to determine the reference level automatically if the 2nd stage correction is on.

Note that the range should not exceed the actual gain of the DUT by more than 10 dB.

Remote command:

`SYSTem:CONFigure:DUT:GAIN` on page 136

RF Attenuation

Defines the RF attenuation of the analyzer.

The attenuation is applied to the signal at the RF input.

Attenuation affects the quality of the noise measurement results. For a low noise figure of the analyzer (and thus more accurate measurement results), you should keep the attenuation as low as possible. No attenuation is best. However, some high power DUTs require attenuation to avoid an overload of the analyzer. An attenuation of 10 dB will give better input VSWR of the analyzer, but will result in a deteriorating noise figure.

Remote command:

`INPut:ATTenuation` on page 134

Preamplifier

Turns the preamplifier on and off.

The preamplifier should be turned on for a low inherent noise of the analyzer.

For R&S FSW26 or higher models, the gain is 30 dB if the preamplifier is activated.

For the other models, you can select a gain of 15 dB or 30 dB.

Remote command:

`INPut:GAIN:STATe` on page 135

5.7 Using the Uncertainty Calculator

Access: MEAS CONFIG > "Uncertainty Calculation"

Noise figure measurements are subject to uncertainty. This measurement uncertainty has to be considered when making a noise figure measurement. The noise figure measurement will be meaningless if the measurement uncertainty is too large. Knowing the uncertainty of the noise figure measurement adds value especially when comparing measurement results.

Note that the noise figure uncertainty is not calculated for frequencies above 67 GHz because input VSWR values are not specified.

Guidelines (repeatability)	ENR - SA NF	[> 3 dB]	= 8.99 dB
	ENR - DUT NF	[> 5 dB]	= 15.0 dB
	DUT (NF+Gain) - SA NF	[> 1 dB]	= -6.01 dB

NF Uncert +/- **0.57 dB**



Uncertainty values and systematic error recognition

Note that the uncertainty calculation only takes systematic measurement inaccuracies into account.

The most significant inaccuracies are:

- uncertainties of the noise source and the analyzer
- input and output matching
- noise figure and gain of the DUT
- noise figure of the analyzer

The accuracy of the measurement may be additionally affected by insufficient repeatability during calibration or measurement.

The repeatability is mainly affected by:

- signal-to-noise ratio during calibration and measurement
- measurement time (if it is too short)
- environmental conditions (e.g. a change in the temperature between measurements)
- mechanical stability of the test setup

For more background information on noise figure measurement uncertainty refer to the application note "The Y-Factor Technique for Noise Figure Measurement" available for download on the Rohde & Schwarz homepage (<http://www.rohde-schwarz.com/en/>)

[applications/the-y-factor-technique-for-noise-figure-measurements-application-note_56280-15484.html](#)).

In addition to the parameters described here, the application also considers several parameters from the general measurement configuration when calculating the uncertainty.

- [Measurement mode](#)
- [2nd Stage Correction](#)
If 2nd stage correction is on, but no calibration data is available, uncertainty is calculated without the 2nd stage correction data.
- [Internal preamplification](#)
- [RF Attenuation](#)
- [Temperature](#)
- [ENR values](#)
- [Configuring Noise Source Characteristics](#)..... 62
- [Configuring DUT Characteristics](#).....63
- [Configuring Analyzer Characteristics](#)..... 64
- [Guidelines and Results](#)..... 65

5.7.1 Configuring Noise Source Characteristics

Access: MEAS CONFIG > "Uncertainty Calculation"

The Uncertainty Calculator supports individual characteristics for a noise source used during calibration and the measurement.

If you are using a Common ENR, the application assumes that the [Output Match](#) and [ENR Uncert\(ainty\)](#) are the same during calibration and measurement. Only the "Measurement Noise Source" parameters are displayed.

If you are using a different noise source during calibration and measurement, the Uncertainty Calculator adds an additional [Output Match](#) and [ENR Uncert\(ainty\)](#) required for uncertainty calculation during calibration.

Note that you have to turn off the [Common Noise Source](#) if you have to define the values of the noise source used during calibration.

Common Source for Meas and Cal	62
Output Match	63
ENR Uncert(ainty)	63
Temperature Uncert(ainty)	63

Common Source for Meas and Cal

Controls the way the application calculates the uncertainty for the noise source.

Turn on the switch when you use the same noise source during calibration and measurement. Only one set of fields to define the noise source characteristics is available. The application calculates the uncertainty according to the values you have entered in there.

Turn the switch off when you use different noise sources during calibration and measurement. The application shows an additional set of fields to define the noise source characteristics. The uncertainty calculation also includes these values.

The switch is available if you have turned on [Common Noise Source](#).

Remote command:

[CALCulate:UNCertainty:COMMON](#) on page 138

Output Match

Defines the output match of the noise source you are using.

You can define the output match either as the VSWR or as the return loss (RL).

Refer to the datasheet of the noise source for these values.

Remote command:

[CALCulate:UNCertainty:MATCH:SOURCE\[:VSWR\]](#) on page 143

[CALCulate:UNCertainty:MATCH:SOURCE:RL](#) on page 143

[CALCulate:UNCertainty:MATCH:SOURCE:CALibration\[:VSWR\]](#) on page 142

[CALCulate:UNCertainty:MATCH:SOURCE:CALibration:RL](#) on page 143

ENR Uncert(ainty)

Defines the uncertainty of the excess noise ratio of the noise source you are using.

Refer to the datasheet of the noise source for this value.

Available for noise sources with diode characteristics.

Remote command:

[CALCulate:UNCertainty:ENR:UNCertainty](#) on page 140

[CALCulate:UNCertainty:ENR:CALibration:UNCertainty](#) on page 139

Temperature Uncert(ainty)

Defines the uncertainty of the hot and cold temperatures of the noise source you are using.

Refer to the datasheet of the noise source for these values.

Available for resistor noise sources.

Remote command:

[CALCulate:UNCertainty:ENR:UNCertainty:COLD](#) on page 140

[CALCulate:UNCertainty:ENR:UNCertainty:HOT](#) on page 141

[CALCulate:UNCertainty:ENR:CALibration:UNCertainty:COLD](#) on page 139

[CALCulate:UNCertainty:ENR:CALibration:UNCertainty:HOT](#) on page 140

5.7.2 Configuring DUT Characteristics

Access: MEAS CONFIG > "Uncertainty Calculation"

Input / Output Match	63
Use Measurement Values	64

Input / Output Match

Defines the match at the DUT input and output.

You can define the match either as the VSWR or as the return loss (RL). If you define the VSWR or the return loss, the application automatically calculates the other.

If these values are not defined in the DUT datasheet, determine these values, for example, with a network analyzer.

Remote command:

[CALCulate:UNCertainty:MATCH:DUT:IN:\[VSWR\]](#) on page 141

[CALCulate:UNCertainty:MATCH:DUT:IN:RL](#) on page 141

[CALCulate:UNCertainty:MATCH:DUT:OUT:\[VSWR\]](#) on page 142

[CALCulate:UNCertainty:MATCH:DUT:OUT:RL](#) on page 142

Use Measurement Values

Turns automatic determination of the DUT characteristics used for the uncertainty calculation on and off.

If on, the application calculates the uncertainty with the DUT characteristics (noise figure, gain and frequency) resulting from the noise figure measurement. In case of this method, the application calculates the uncertainty for each measurement point (or frequency) based on the noise figure and gain results of the last measurement.

If you have selected automatic determination of the DUT characteristics, the application does not show a result in the "NF Uncertainty +/-" field in the dialog box. Instead, to view the uncertainty at all measurement points, use the "Result Table".

If off, define the gain, noise figure and frequency of the DUT manually for a single frequency. With this manual determination of the DUT characteristics, the application only calculates the uncertainty for that frequency and shows the result in the "NF Uncertainty +/-" field in the dialog box.

- Noise Figure of the DUT
- Gain of the DUT
- Frequency of the DUT

Remote command:

Control automatic DUT characteristics determination:

[CALCulate:UNCertainty:DATA:RESULTS](#) on page 139

Manual definition of DUT characteristics:

[CALCulate:UNCertainty:DATA:NOISE](#) on page 138

[CALCulate:UNCertainty:DATA:GAIN](#) on page 138

[CALCulate:UNCertainty:DATA:FREQUENCY](#) on page 138

5.7.3 Configuring Analyzer Characteristics

Access: MEAS CONFIG > "Uncertainty Calculation"

For the analyzer characteristics, the application always uses the data specified in the datasheet of the R&S FSW model you are using. Thus, it is not possible to change or adjust the analyzer characteristics in any way. The uncertainty calculation takes several analyzer characteristics into account. Of those, it shows the following as read only fields in the user interface.

- Input match (VSWR and return loss)
- Gain uncertainty

- Noise figure uncertainty
- Noise figure of the analyzer

However, if you are using an external preamplifier in the test setup, you have to specify its characteristics in order to get a valid uncertainty result. If you specify an external preamplifier, the application automatically calculates and updates the analyzer characteristics based on the characteristics of the preamplifier.

SCPI command:

[CALCulate:UNCertainty:PREamp:STATe](#) on page 144

Refer to the datasheet of the preamplifier you are using for the values you have to enter.

If you are using a preamplifier, you have to define the following characteristics.

Preamplifier noise figure (PA NF)

Defines the noise figure of the preamplifier.

SCPI command:

[CALCulate:UNCertainty:PREamp:NOISe](#) on page 144

Preamplifier Gain (PA Gain)

Defines the gain of the preamplifier.

SCPI command:

[CALCulate:UNCertainty:PREamp:GAIN](#) on page 144

Net spectrum analyzer noise figure

Shows the noise figure of the analyzer.

If you are using an external preamplifier, the application calculates the noise figure of the analyzer including the noise figure of the preamplifier and shows the result here.

If you do not use an external preamplifier, this value is the same as the noise figure of the analyzer shown in the "SA NF" field.

SCPI commands:

[CALCulate:UNCertainty:SANalyzer:GAIN:UNCertainty?](#) on page 145

[CALCulate:UNCertainty:SANalyzer:NOISe:UNCertainty?](#) on page 145

5.7.4 Guidelines and Results

Access: MEAS CONFIG > "Uncertainty Calculation"

The lower part of the dialog box contains measurement guidelines that provide information on the quality of measurement and the actual noise figure uncertainty.



Guidelines

The guidelines are an indicator of the quality of the measurement and an indicator the repeatability of the measurement.

The three guidelines are:

- Make sure that the noise figure of the DUT and the gain of the DUT is greater than the noise figure of the analyzer plus 1 dB.
- Make sure that the ENR of the noise source is greater than the noise figure of the DUT plus 5 dB.
- Make sure that the ENR of the noise source is greater than the noise figure of the analyzer plus 3 dB.

A short form of these guidelines is indicated in the "Uncertainty Calculation" dialog box. The dialog box also indicates if the guidelines have been met or not by a colored dot.

- Green light : guideline condition met.
- Yellow light : guideline condition not met, but within 1 dB of being met.
- Red light : guideline condition not met.

Note that the guidelines have no effect on the actual uncertainty that has been calculated and that they are only considered for measurements with 2nd Stage Correction.

Uncertainty

The "Uncertainty" result is shown only if you define the noise figure and gain characteristics of the DUT manually on a single frequency. In that case, the uncertainty shown in the "Uncertainty Calculation" dialog box is valid only for the DUT frequency you have defined.

The "Measurement Offset" evaluates the internal noise of the R&S FSW that is added to the noise figure results. The measurement offset result is displayed when 2nd stage correction is turned off. When you turn on 2nd stage correction, the internal noise is automatically removed from the uncertainty results, so the measurement offset is not shown.

If you are using the noise figure and gain that has been determined during a measurement, the uncertainty is displayed only in the result table.

For more information see ["Use Measurement Values"](#) on page 64.

SCPI command:

`CALCulate:UNCertainty[:RESult]?` on page 144

5.8 Performing Measurements

Access: SWEEP

Access (calibration): "Overview" > "Calibrate"

This chapter contains all functionality necessary to control and perform noise figure measurements.

Continuous Sweep/RUN CONT.....	67
Single Sweep/ RUN SINGLE.....	67
Calibrate.....	67
Sweep Time.....	67
Meas Mode (Auto Manual).....	68

Continuous Sweep/RUN CONT

Initiates a measurement and repeats it continuously until stopped. If necessary, the application automatically determines the reference level before starting the actual measurement.

While the measurement is running, the "Continuous Sweep" softkey and the RUN CONT key are highlighted. The running measurement can be aborted by selecting the highlighted softkey or key again. The results are not deleted until a new measurement is started.

Note: Sequencer. Furthermore, the RUN CONT key controls the Sequencer, not individual sweeps. RUN CONT starts the Sequencer in continuous mode. For details on the Sequencer, see the R&S FSW User Manual.

Remote command:

`INITiate<n>:CONTinuous` on page 146

Single Sweep/ RUN SINGLE

Initiates a single measurement. The measurement is finished after all frequencies in the frequency list have been measured. If necessary, the application automatically determines the reference level before starting the actual measurement.

While the measurement is running, the "Single Sweep" softkey and the RUN SINGLE key are highlighted. The running measurement can be aborted by selecting the highlighted softkey or key again.

Note: Sequencer. Furthermore, the RUN SINGLE key controls the Sequencer, not individual sweeps. RUN SINGLE starts the Sequencer in single mode. If the Sequencer is off, only the evaluation for the currently displayed measurement channel is updated.

Remote command:

`INITiate<n>[:IMMediate]` on page 147

Calibrate

Initiates a calibration measurement.

For more information see [Chapter 4.6, "Calibration \(2nd Stage Correction\)"](#), on page 33.

Remote command:

`INITiate<n>[:IMMediate]` on page 147
when `[SENSe:]CONFigure:CORRection` is on.

Sweep Time

Defines the sweep time.

For more information see ["Sweep Time"](#) on page 58.

Meas Mode (Auto Manual)

Selects the measurement mode for the hot and cold power measurements.

For more information about the measurement modes see [Chapter 4.2, "Measurement Modes"](#), on page 26.

In manual measurement mode, the application opens a dialog box when you start a measurement. For more information about its contents see ["Performing a manual measurement"](#) on page 26.

Remote command:

[\[SENSe:\]CONFigure:CONTRol](#) on page 149

[\[SENSe:\]CONFigure:MEASurement](#) on page 149

5.9 Configuring Inputs and Outputs of the R&S FSW

The application supports several input sources and outputs. These are the same as in Spectrum mode.

For a comprehensive description of the supported input sources (including the Digital Baseband In- and Output), refer to the documentation of the R&S FSW.

5.9.1 Radio Frequency (RF) Input

Access: INPUT/OUTPUT > "Input Source Config" > "Input Source" > "Radio Frequency"

The RF input is the default input of the R&S FSW.

Input Coupling	68
Impedance	69
High-Pass Filter 1...3 GHz	69
YIG-Preselector	69

Input Coupling

The RF input of the R&S FSW can be coupled by alternating current (AC) or direct current (DC).

AC coupling blocks any DC voltage from the input signal. This is the default setting to prevent damage to the instrument. Very low frequencies in the input signal may be distorted.

However, some specifications require DC coupling. In this case, you must protect the instrument from damaging DC input voltages manually. For details, refer to the data sheet.

Remote command:

[INPut:COUPling](#) on page 150

Impedance

For some measurements, the reference impedance for the measured levels of the R&S FSW can be set to 50 Ω or 75 Ω .

Select 75 Ω if the 50 Ω input impedance is transformed to a higher impedance using a 75 Ω adapter of the RAZ type. (That corresponds to 25 Ω in series to the input impedance of the instrument.) The correction value in this case is 1.76 dB = 10 log (75 Ω /50 Ω).

Remote command:

[INPut:IMPedance](#) on page 151

High-Pass Filter 1...3 GHz

Activates an additional internal high-pass filter for RF input signals from 1 GHz to 3 GHz. This filter is used to remove the harmonics of the analyzer to measure the harmonics for a DUT, for example.

This function requires an additional hardware option.

(Note: for RF input signals outside the specified range, the high-pass filter has no effect. For signals with a frequency of approximately 4 GHz upwards, the harmonics are suppressed sufficiently by the YIG-preselector, if available.)

Remote command:

[INPut:FILTer:HPASs\[:STATe\]](#) on page 151

YIG-Preselector

Activates or deactivates the YIG-preselector, if available on the R&S FSW.

An internal YIG-preselector at the input of the R&S FSW ensures that image frequencies are rejected. However, this is only possible for a restricted bandwidth. To use the maximum bandwidth for signal analysis you can deactivate the YIG-preselector at the input of the R&S FSW, which can lead to image-frequency display.

Note that the YIG-preselector is active only on frequencies greater than 8 GHz. Therefore, switching the YIG-preselector on or off has no effect if the frequency is below that value.

Remote command:

[INPut:FILTer:YIG\[:STATe\]](#) on page 152

5.9.2 External Mixer Settings

Access: INPUT/OUTPUT > "External Mixer Config"

If installed, the optional external mixer can be configured from the R&S FSW Noise measurements application.

- [Mixer Settings](#)..... 70
- [Basic Settings](#)..... 73
- [Managing Conversion Loss Tables](#)..... 75
- [Creating and Editing Conversion Loss Tables](#)..... 76

5.9.2.1 Mixer Settings

Access: INPUT/OUTPUT > "External Mixer Config" > "Mixer Settings"

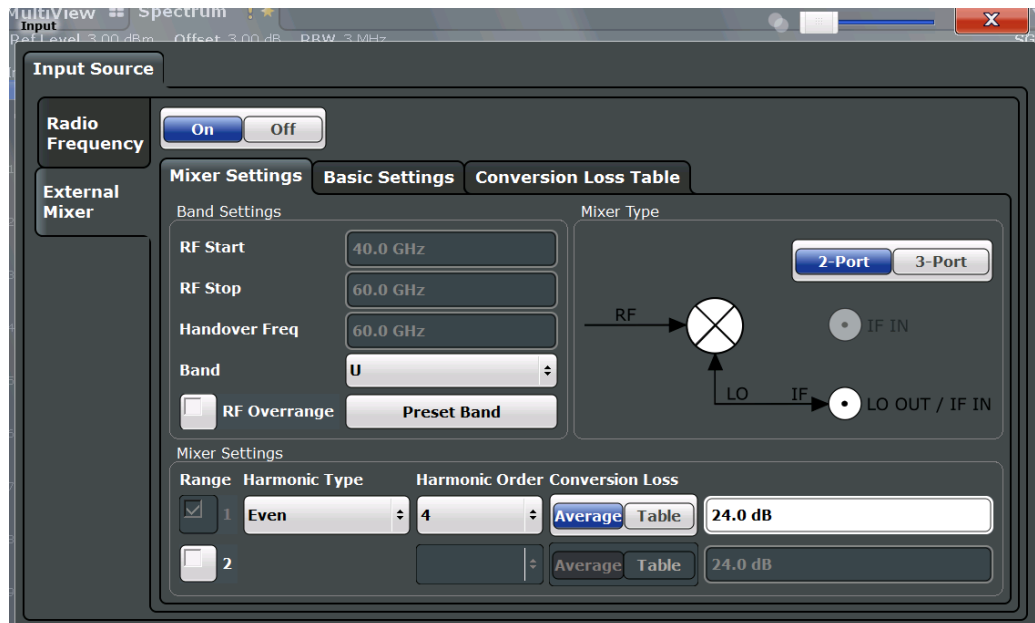

External Mixer State.....	70
RF Start / RF Stop.....	70
Handover Freq.....	71
Band.....	71
RF Overrange.....	71
Preset Band.....	71
Mixer Type.....	72
Mixer Settings (Harmonics Configuration).....	72
└ Range 1/2.....	72
└ Harmonic Type.....	72
└ Harmonic Order.....	72
└ Conversion loss.....	72

External Mixer State

Activates or deactivates the external mixer for input. If activated, "ExtMix" is indicated in the channel bar of the application, together with the used band (see "Band" on page 71).

Remote command:

[SENSe:]MIXer[:STATe] on page 162

RF Start / RF Stop

Displays the start and stop frequency of the selected band (read-only).

The frequency range for the user-defined band is defined via the harmonics configuration (see "Range 1/2" on page 72).

For details on available frequency ranges, see [table 7-4 on page 158](#).

Remote command:

[SENSe:]MIXer:FREQuency:START? on page 157

[SENSe:]MIXer:FREQuency:STOP? on page 158

Handover Freq.

If due to the LO frequency the conversion of the input signal is not possible using one harmonic, the band must be split. An adjacent, partially overlapping frequency range can be defined using different harmonics (see "[Mixer Settings \(Harmonics Configuration\)](#)" on page 72). In this case, the sweep begins using the harmonic defined for the first range. At the specified "handover frequency" in the overlapping range, it switches to the harmonic for the second range.

The handover frequency can be selected freely within the overlapping frequency range.

Remote command:

[SENSe:]MIXer:FREQuency:HANDOver on page 157

Band

Defines the waveguide frequency band or user-defined frequency band to be used by the mixer.

The start and stop frequencies of the selected band are displayed in the "RF Start" and "RF Stop" fields.

For a definition of the frequency range for the pre-defined bands, see [table 7-4 on page 158](#).

The mixer settings for the user-defined band can be selected freely. The frequency range for the user-defined band is defined via the harmonics configuration (see "[Range 1/2](#)" on page 72).

Remote command:

[SENSe:]MIXer:HARMonic:BAND[:VALue] on page 158

RF Overage

In some cases, the harmonics defined for a specific band allow for an even larger frequency range than the band requires. By default, the pre-defined range is used. However, you can take advantage of the extended frequency range by overriding the defined "RF Start" and "RF Stop" frequencies by the maximum values.

If "RF Overage" is enabled, the frequency range is not restricted by the band limits ("RF Start" and "RF Stop"). In this case, the full frequency range that can be reached using the selected harmonics is used.

Remote command:

[SENSe:]MIXer:RFOVerrange[:STATe] on page 162

Preset Band

Restores the presettings for the selected band.

Note: changes to the band and mixer settings are maintained even after using the PRESET function. This function allows you to restore the original band settings.

Remote command:

[SENSe:]MIXer:HARMonic:BAND:PRESet on page 158

Mixer Type

The External Mixer option supports the following external mixer types:

- "2 Port" LO and IF data use the same port
- "3 Port" LO and IF data use separate ports

Remote command:

[\[SENSe:\]MIXer:PORTs](#) on page 162

Mixer Settings (Harmonics Configuration)

The harmonics configuration determines the frequency range for user-defined bands (see "Band" on page 71).

Range 1/2 ← Mixer Settings (Harmonics Configuration)

Enables the use of one or two frequency ranges, where the second range is based on another harmonic frequency of the mixer to cover the band's frequency range.

For each range, you can define which harmonic to use and how the [Conversion loss](#) is handled.

Remote command:

[\[SENSe:\]MIXer:HARMonic:HIGH:STATe](#) on page 159

Harmonic Type ← Mixer Settings (Harmonics Configuration)

Defines if only even, only odd, or even and odd harmonics can be used for conversion. Depending on this selection, the order of harmonic to be used for conversion changes (see "Harmonic Order" on page 72). Which harmonics are supported depends on the mixer type.

Remote command:

[\[SENSe:\]MIXer:HARMonic:TYPE](#) on page 159

Harmonic Order ← Mixer Settings (Harmonics Configuration)

Defines which order of the harmonic of the LO frequencies is used to cover the frequency range.

By default, the lowest order of the specified harmonic type is selected that allows conversion of input signals in the whole band. If due to the LO frequency the conversion is not possible using one harmonic, the band is split.

For the "USER" band, you define the order of harmonic yourself. The order of harmonic can be between 2 and 61, the lowest usable frequency being 26.5 GHz.

Remote command:

[\[SENSe:\]MIXer:HARMonic\[:LOW\]](#) on page 160

[\[SENSe:\]MIXer:HARMonic:HIGH\[:VALue\]](#) on page 159

Conversion loss ← Mixer Settings (Harmonics Configuration)

Defines how the conversion loss is handled. The following methods are available:

- "Average" Defines the average conversion loss for the entire frequency range in dB.

"Table" Defines the conversion loss via the table selected from the list. Pre-defined conversion loss tables are often provided with the external mixer and can be imported to the R&S FSW. Alternatively, you can define your own conversion loss tables. Imported tables are checked for compatibility with the current settings before being assigned. Conversion loss tables are configured and managed in the [Conversion Loss Table](#) tab. For details on importing tables, see ["Import Table"](#) on page 76.

Remote command:

Average for range 1:

[SENSe:]MIXer:LOSS[:LOW] on page 161

Table for range 1:

[SENSe:]MIXer:LOSS:TABLE[:LOW] on page 161

Average for range 2:

[SENSe:]MIXer:LOSS:HIGH on page 161

Table for range 2:

[SENSe:]MIXer:LOSS:TABLE:HIGH on page 161

5.9.2.2 Basic Settings

Access: INPUT/OUTPUT > "External Mixer Config" > "Basic Settings"

The basic settings concern general use of an external mixer. They are only available if the [External Mixer State](#) is "On".

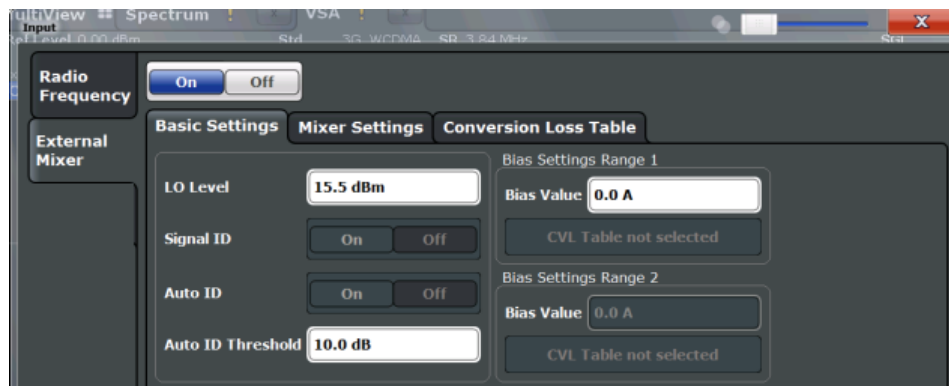

LO Level.....	73
Signal ID.....	74
Auto ID.....	74
Auto ID Threshold.....	74
Bias Settings.....	74
L Write to <CVL table name>.....	75

LO Level

Defines the LO level of the external mixer's LO port. Possible values are from 13.0 dBm to 17.0 dBm in 0.1 dB steps. Default value is 15.5 dB.

Remote command:

[SENSe:]MIXer:LOPower on page 160

Signal ID

Activates or deactivates visual signal identification. Two sweeps are performed alternately. Trace 1 shows the trace measured on the upper side band (USB) of the LO (the test sweep). Trace 2 shows the trace measured on the lower side band (LSB), i.e. the reference sweep.

Note that automatic signal identification is only available for measurements that perform frequency sweeps (not in the VSA, the I/Q Analyzer, or the Real-Time Spectrum application, for instance).

Mathematical functions with traces and trace copy cannot be used with the Signal ID function.

Remote command:

[\[SENSe:\]MIXer:SIGNal](#) on page 160

Auto ID

Activates or deactivates automatic signal identification.

Auto ID basically functions like [Signal ID](#). However, the test and reference sweeps are converted into a single trace by a comparison of maximum peak values of each sweep point. The result of this comparison is displayed in trace 3 if "Signal ID" is active at the same time. If "Signal ID" is not active, the result can be displayed in any of the traces 1 to 3. Unwanted mixer products are suppressed in this calculated trace.

Note that automatic signal identification is only available for measurements that perform frequency sweeps (not in vector signal analysis or the I/Q Analyzer, for instance).

Remote command:

[\[SENSe:\]MIXer:SIGNal](#) on page 160

Auto ID Threshold

Defines the maximum permissible level difference between test sweep and reference sweep to be corrected during automatic comparison ("[Auto ID](#)" on page 74 function). The input range is between 0.1 dB and 100 dB. Values of about 10 dB (i.e. default setting) generally yield satisfactory results.

Remote command:

[\[SENSe:\]MIXer:THReshold](#) on page 162

Bias Settings

Define the bias current for each range, which is required to set the mixer to its optimum operating point. It corresponds to the short-circuit current. The bias current can range from -10 mA to 10 mA. The actual bias current is lower because of the forward voltage of the mixer diode(s).

Tip: The trace in the currently active result display (if applicable) is adapted to the settings immediately so you can check the results.

To store the bias setting in the currently selected conversion loss table, select the [Write to <CVL table name>](#) button.

Remote command:

[\[SENSe:\]MIXer:BIAS\[:LOW\]](#) on page 157

[\[SENSe:\]MIXer:BIAS:HIGH](#) on page 157

Write to <CVL table name> ← Bias Settings

Stores the bias setting in the currently selected "Conversion loss table" for the range (see [Chapter 5.9.2.3, "Managing Conversion Loss Tables"](#), on page 75). If no conversion loss table is selected yet, this function is not available ("CVL Table not selected").

Remote command:

[SENSe:]CORRection:CVL:BIAS on page 153

5.9.2.3 Managing Conversion Loss Tables

Access: INPUT/OUTPUT > "External Mixer Config" > "Conversion Loss Table"

In this tab, you configure and manage conversion loss tables. Conversion loss tables consist of value pairs that describe the correction values for conversion loss at certain frequencies. The correction values for frequencies between the reference points are obtained via interpolation.

The currently selected table for each range is displayed at the top of the dialog box. All conversion loss tables found in the instrument's C:\R_S\INSTR\USER\cvl\ directory are listed in the "Modify Tables" list.

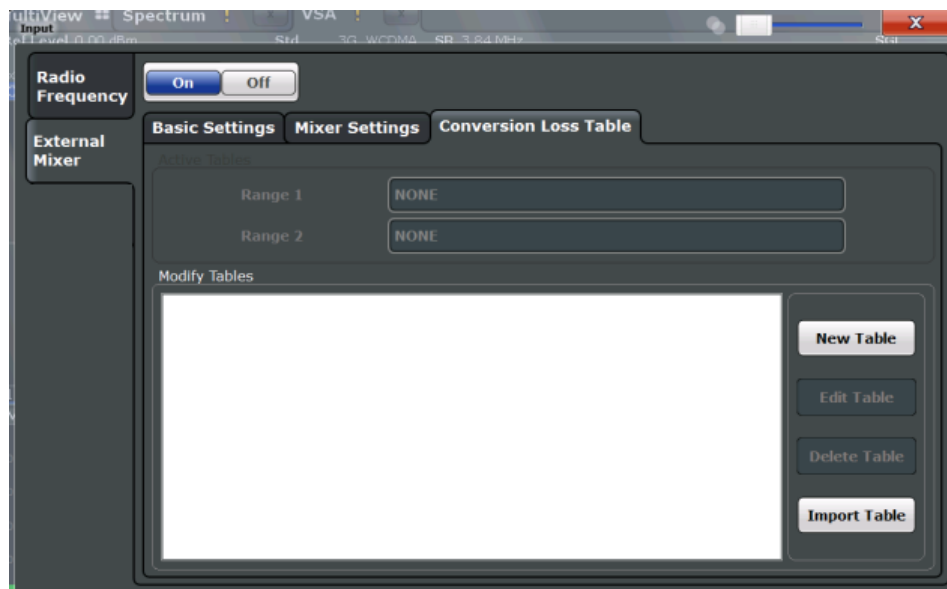

New Table	75
Edit Table	76
Delete Table	76
Import Table	76

New Table

Opens the "Edit Conversion loss table" dialog box to configure a new conversion loss table. For details on table configuration, see [Chapter 5.9.2.4, "Creating and Editing Conversion Loss Tables"](#), on page 76.

Remote command:

[SENSe:]CORRection:CVL:SElect on page 156

Edit Table

Opens the "Edit Conversion loss table" dialog box to edit the selected conversion loss table. For details on table configuration, see [Chapter 5.9.2.4, "Creating and Editing Conversion Loss Tables"](#), on page 76.

Remote command:

`[SENSe:]CORRection:CVL:SElect` on page 156

Delete Table

Deletes the currently selected conversion loss table after you confirm the action.

Remote command:

`[SENSe:]CORRection:CVL:CLEAr` on page 154

Import Table

Imports a stored conversion loss table from any directory and copies it to the instrument's `C:\R_S\INSTR\USER\cv1\` directory. It can then be assigned for use for a specific frequency range (see ["Conversion loss"](#) on page 72).

5.9.2.4 Creating and Editing Conversion Loss Tables

Access: INPUT/OUTPUT > "External Mixer Config" > "Conversion Loss Table" > "New Table" / "Edit Table"

Conversion loss tables can be newly defined and edited.

A preview pane displays the current configuration of the conversion loss function as described by the position/value entries.

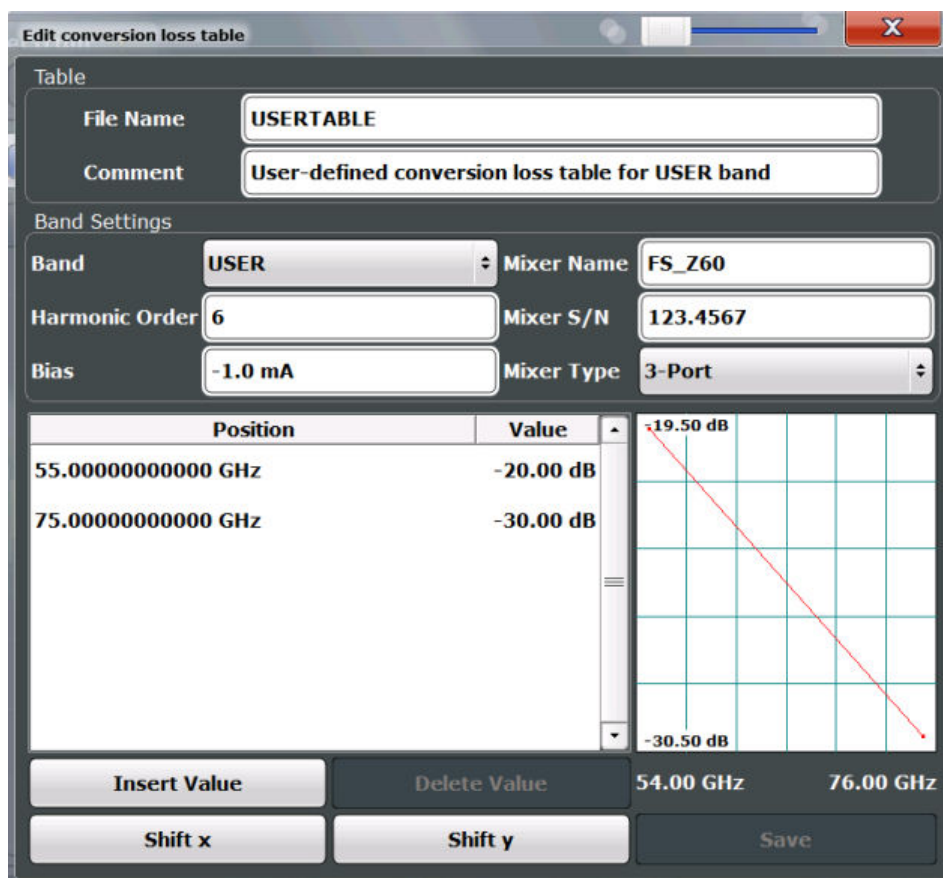

File Name.....77

Comment.....78

Band.....78

Harmonic Order.....78

Bias.....78

Mixer Name.....78

Mixer S/N.....78

Mixer Type.....79

Position/Value.....79

Insert Value.....79

Delete Value.....79

Shift x.....79

Shift y.....79

Save.....79

File Name

Defines the name under which the table is stored in the C:\R_S\INSTR\USER\cv1\ directory on the instrument. The name of the table is identical with the name of the file (without extension) in which the table is stored. This setting is mandatory. The .ACL extension is automatically appended during storage.

Remote command:

[SENSe:]CORRection:CVL:SELeCt on page 156

Comment

An optional comment that describes the conversion loss table. The comment is user-definable.

Remote command:

`[SENSe:]CORRection:CVL:COMMeNt` on page 154

Band

The waveguide or user-defined band to which the table applies. This setting is checked against the current mixer setting before the table can be assigned to the range.

For a definition of the frequency range for the pre-defined bands, see [table 7-4 on page 158](#).

Remote command:

`[SENSe:]CORRection:CVL:BAND` on page 153

Harmonic Order

The harmonic order of the range to which the table applies. This setting is checked against the current mixer setting before the table can be assigned to the range.

Remote command:

`[SENSe:]CORRection:CVL:HARMONic` on page 155

Bias

The bias current which is required to set the mixer to its optimum operating point. It corresponds to the short-circuit current. The bias current can range from -10 mA to 10 mA. The actual bias current is lower because of the forward voltage of the mixer diode(s).

Tip: You can also define the bias interactively while a preview of the trace with the changed setting is displayed, see "[Bias Settings](#)" on page 74.

Remote command:

`[SENSe:]CORRection:CVL:BIAS` on page 153

Mixer Name

Specifies the name of the external mixer to which the table applies. This setting is checked against the current mixer setting before the table can be assigned to the range.

Remote command:

`[SENSe:]CORRection:CVL:MIXer` on page 155

Mixer S/N

Specifies the serial number of the external mixer to which the table applies.

The specified number is checked against the currently connected mixer number before the table can be assigned to the range.

Remote command:

`[SENSe:]CORRection:CVL:SNUMber` on page 156

Mixer Type

Specifies whether the external mixer to which the table applies is a two-port or three-port type. This setting is checked against the current mixer setting before the table can be assigned to the range.

Remote command:

[\[SENSe:\]CORRection:CVL:PORTs](#) on page 156

Position/Value

Each position/value pair defines the conversion loss value in dB for a specific frequency. The reference values must be entered in order of increasing frequencies. A maximum of 50 reference values can be entered. To enter a new value pair, select an empty space in the "Position/Value" table, or select the [Insert Value](#) button.

Correction values for frequencies between the reference values are interpolated. Linear interpolation is performed if the table contains only two values. If it contains more than two reference values, spline interpolation is carried out. Outside the frequency range covered by the table, the conversion loss is assumed to be the same as that for the first and last reference value.

The current configuration of the conversion loss function as described by the position/value entries is displayed in the preview pane to the right of the table.

Remote command:

[\[SENSe:\]CORRection:CVL:DATA](#) on page 154

Insert Value

Inserts a new position/value entry in the table.

If the table is empty, a new entry at 0 Hz is inserted.

If entries already exist, a new entry is inserted above the selected entry. The position of the new entry is selected such that it divides the span to the previous entry in half.

Delete Value

Deletes the currently selected position/value entry.

Shift x

Shifts all positions in the table by a specific value. The value can be entered in the edit dialog box. The conversion loss function in the preview pane is shifted along the x-axis.

Shift y

Shifts all conversion loss values by a specific value. The value can be entered in the edit dialog box. The conversion loss function in the preview pane is shifted along the y-axis.

Save

The conversion loss table is stored under the specified file name in the `C:\R_S\INSTR\USER\cv1\` directory of the instrument.

5.9.3 External Generator

Access: INPUT/OUTPUT > "Input Source Config" > "External Generator"

- [Interface Configuration Settings](#).....80
- [Measurement Configuration](#).....81

5.9.3.1 Interface Configuration Settings

Access: "Overview" > "Local Oscillator" > "External Generator" > "Measurement Configuration"

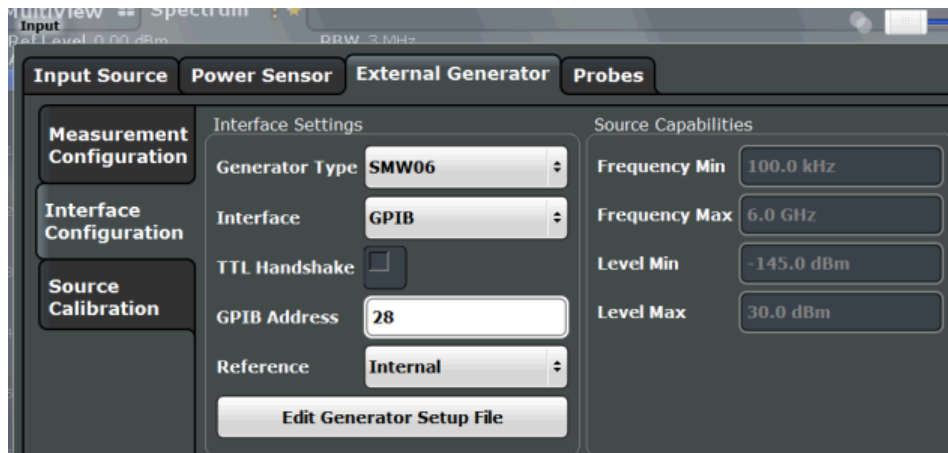

Generator Type	80
Interface	80
TTL Handshake	81
GPIB Address / TCP/IP Address	81
Reference	81
Edit Generator Setup File	81
Frequency Min. / Frequency Max.	81
Level Min. / Level Max.	81

Generator Type

Selects the generator type and thus defines the generator setup file to use.

Remote command:

`SYSTem:COMMunicate:RDEvice:GENerator:TYPE` on page 165

Interface

Type of interface connection used. The following interfaces are currently supported:

- GPIB
- TCP/IP (not by all generators)

For details on which signal generators support which interfaces, see the documentation of the corresponding signal generator.

Remote command:

`SYSTem:COMMunicate:RDEvice:GENerator:INTerface` on page 165

TTL Handshake

Turning the TTL handshake on and off has no effect for Noise Figure measurements.

GPIO Address / TCP/IP Address

For LAN connections: TCP/IP address of the signal generator

For GPIB connections: GPIB address of the signal generator.

Remote command:

`SYSTem:COMMunicate:GPIO:RDEvice:GENerator:ADDress` on page 164

`SYSTem:COMMunicate:TCPIP:RDEvice:GENerator:ADDress` on page 165

Reference

Selects the internal R&S FSW or an external frequency reference to synchronize the R&S FSW with the generator (default: internal).

Remote command:

`SOURce:EXTernal:ROSCillator[:SOURce]` on page 164

Edit Generator Setup File

Displays the setup file for the currently selected [Generator Type](#) in read-only mode in an editor.

Although the existing setup files are displayed in read-only mode in the editor, they can be saved under a different name (using "File > SaveAs").

For more information, see [Chapter 4.4, "External Generator Control"](#), on page 29.

Frequency Min. / Frequency Max.

For reference only: Lower and upper frequency limit for the generator.

Level Min. / Level Max.

For reference only: Lower and upper power limit for the generator.

5.9.3.2 Measurement Configuration

Access: "Overview" > "Local Oscillator" > "External Generator" > "Measurement Configuration"

The screenshot displays the 'External Generator' configuration window with the 'Measurement Configuration' tab selected. The interface includes the following elements:

- Measurement Configuration:**
 - Automatic Control: On (selected) / Off
 - Init Before Meas: On (selected) / Off
- Interface Configuration:**
 - Auto Switch Off: On (selected) / Off
 - Source Power: -20.0 dBm
- Frequency Coupling:**
 - Numerator: 1
 - Denominator: 1
 - Source Freq = (LO + Offset1) * $\frac{\text{Numerator}}{\text{Denominator}}$ + Offset2
 - Offset1: 0.0 Hz
 - Offset2: 0.0 Hz
 - Result Frequency Start: 10.0 MHz
 - Result Frequency Stop: 30.0 GHz

Automatic Control.....	82
Init Before Meas.....	82
Auto Switch Off.....	82
Source Power.....	83
Frequency Coupling.....	83
Init External Generator.....	83

Automatic Control

Turns automatic control of the external generator on and off.

If on, the application controls the configuration of the external generator during measurements by transmitting the required remote commands. The connection is established automatically before a measurement if [Init Before Meas](#) is on. To establish the connection manually at any time, use the [Init External Generator](#) function.

Otherwise, you have to control the generator manually. The application assumes that the generator is configured correctly for the measurement. The remote connection to the generator is automatically terminated.

Note that you have to turn automatic control on if you want to perform Fixed IF measurements in order to keep the LO frequency tuned to the current measurement (RF) frequency. Manual control is recommended only for measurements whose generator settings remain the same during the measurement.

Remote command:

`SYSTEM:CONFIGure:GENerator:CONTROL:STATE` on page 165

Init Before Meas

Turns automatic transmission of the external generator configuration on and off.

If on, the application transmits a sequence of remote commands that configures the generator and turns on its RF output before each measurement. Configuring the generator this way allows you to make sure that the generator runs with the configuration you need and is in a state to receive remote control commands during a measurement. Using automatic initialization of the generator results in a slightly longer measurement time because of the time required to transmit the commands and configure the generator.

If off, you have to initialize the generator manually with [Init External Generator](#).

Note that you have to establish the connection in order to be able to perform a measurement with the external generator.

Remote command:

`SYSTEM:CONFIGure:GENerator:INITialise:AUTO` on page 166

Auto Switch Off

Turns automatic deactivation of the generator's RF output on and off.

If on, the application transmits a sequence of remote commands to turn off the RF output of the generator when a measurement is over. A measurement is over after a single sweep or if the measurement is aborted. The sequence of commands also ends the remote control session.

If off, you have to turn the RF output and remote control session off manually.

Note that exiting the Noise Figure Measurement application always turns off the generator's RF output and terminates the remote session.

Remote command:

[SYSTem:CONFIgure:GENerator:SWITCh:AUTO](#) on page 166

Source Power

Defines the output power of the external generator.

The range depends on the generator you are using and is defined in its data sheet.

Remote command:

[SOURce:EXTernal:POWer\[:LEVel\]](#) on page 164

Frequency Coupling

Defines frequency correction characteristics.

The generator frequency is calculated as follows.

$$f_{\text{Generator}} = \left[(f_{\text{LO}} + \text{Offset} < 1 >) * \frac{\text{Numerator}}{\text{Denominator}} \right] + \text{Offset} < 2 >$$

with:

- $f_{\text{Generator}}$ = generator frequency
- f_{LO} = frequency of the analyzer's LO
- $f_{\text{offset}<1>}$ = offset frequency of the analyzer
- $f_{\text{offset}<2>}$ = offset frequency of other components

You can use the factors and offsets to compensate one or more components in the test setup that may change the frequency between the generator and the DUT. Make sure, however, that the result does not exceed the frequency range of the generator.

The application calculates the resulting start and stop frequency based on the values you apply and displays them below the equation.

Remote command:

[SOURce:EXTernal:FREQuency\[:FACTor\]:DENominator](#) on page 163

[SOURce:EXTernal:FREQuency\[:FACTor\]:NUMerator](#) on page 163

[SOURce:EXTernal:FREQuency:OFFSet<offset>](#) on page 163

Init External Generator

Establishes a connection to generator and turns on its RF output.

You can establish the connection automatically before a measurement if [Init Before Meas](#) is on.

Note that you have to establish the connection in order to be able to perform a measurement with the external generator.

Remote command:

[SYSTem:CONFIgure:GENerator:INITialise:IMMediate](#) on page 166

6 Analysis

This chapter contains all settings and parameters that the application provides to analyze and evaluate measurement results.

- [Configuring the Display](#)..... 84
- [Working with Traces](#).....86
- [Using Markers](#)..... 88
- [Limit Line Settings and Functions](#)..... 92

6.1 Configuring the Display

Access: MEAS CONFIG > "Result Config"

Display configuration settings configure the way the results are displayed in the diagram.

The contents depend on whether you want to configure a graphical result display or a numerical result display.

Specifics for

The settings you make apply to the results you have selected in the "Specifics for" dropdown menu. If more than one window is on, "Specifics for" also puts the focus on the corresponding window.

- [Configuring Graphical Results](#)..... 84
- [Configuring Numerical Results](#).....86

6.1.1 Configuring Graphical Results

Access: MEAS CONFIG > "Result Config" > "Graph"

When configuring graphical results, the dialog box contains functionality to scale and set up the diagram axes.



Y-Axis.....	85
Auto Scale / Min / Max.....	85
Symbols.....	85
Uncertainty.....	85
X-Axis.....	85

Y-Axis

Selects the result display and thus the scaling of the vertical axis.

For more information see [Chapter 3, "Measurements and Result Displays"](#), on page 15.

Auto Scale / Min / Max

Turns automatic scaling of the vertical axis on and off.

If on, the application optimizes the scaling of the vertical axis after each measurement for ideal viewing of the results.

If off, you can define the scaling manually. The "Min" and "Max" input fields become available. These two input fields define the values at the top and bottom of the vertical axis.

Remote command:

Automatic scaling:

`DISPlay[:WINDow<n>]:TRACe:Y[:SCALe]:AUTO` on page 168

Manual minimum value:

`DISPlay[:WINDow<n>]:TRACe<t>:Y[:SCALe]:BOTTom` on page 168

Manual maximum value

`DISPlay[:WINDow<n>]:TRACe<t>:Y[:SCALe]:TOP` on page 169

Symbols

Turns symbols that represent a measurement point on the trace on and off.

Remote command:

`DISPlay[:WINDow<n>]:TRACe:SYMBOLs` on page 167

Uncertainty

Currently undocumented feature.

X-Axis

Selects the frequency data that is displayed on the x-axis.

For measurements on frequency converting DUTs with a variable intermediary frequency, you can display either the RF frequency or the IF frequency.

Note that a change of the x-axis scale applies to all result displays.

The "Frequency Axis" scale is also available via the FREQ key.

Remote command:

`DISPlay[:WINDow<n>]:TRACe:X[:SCALe]` on page 167

6.1.2 Configuring Numerical Results

When configuring numerical results, the dialog box selects the type of results you want to display in the result table. The results in the table are based on a particular trace that you can select in the corresponding input field.

You can add an aspect of the measurement by placing a checkmark in front of the corresponding result on and remove it by removing the checkmark.

For more information on each result see [Chapter 3, "Measurements and Result Displays"](#), on page 15.

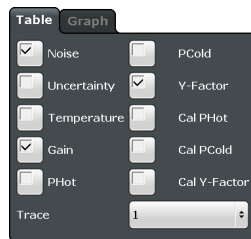

Remote command:

`DISPlay[:WINDow<n>]:TABLE:ITEM` on page 167

6.2 Working with Traces

Access (trace configuration): TRACE > "Trace Config" > "Traces"

Access (trace export): TRACE > "Trace Config" > "Trace / Data Export"

Access (copy trace): TRACE > "Trace Config" > "Trace Copy"

A trace is the graphical representation of a set of measurement results in a diagram. Each measurement window that contains graphical results supports up to four individual traces. Each trace has a different color. Trace settings determine how the measured data is analyzed and displayed on the screen. The trace information, including a color map and trace mode is summarized in the diagram header.

The trace settings are combined in the "Trace Configuration" dialog box. You can access this dialog box with the "Trace Config" softkey or directly access one of the tabs via one of the softkeys in the "Trace" menu.

Traces	86
Copy Trace	87
Preset Traces	87
Trace Config	87
Trace Export	87

Traces

The "Trace 1 to 4" softkeys open the "Traces" tab of the "Trace Configuration" dialog box.

The "Traces" tab contains functionality to configure a trace.

"Trace Selection" The "Trace 1" to "Trace 4" buttons select a trace. If a trace is selected, it is highlighted orange.

Note that you cannot select a trace if its trace mode is "Blank".

"Trace Mode" Selects the trace mode for the corresponding trace.
For more information see [Chapter 4, "Measurement Basics"](#), on page 24.

Remote command:

Trace mode:

`DISPlay[:WINDow<n>]:TRACe<t>:MODE` on page 170

Copy Trace

Access: "Overview" > "Analysis" > "Traces" > "Copy Trace"

Or: TRACE > "Copy Trace"

Copies trace data to another trace.

The first group of buttons (labeled "Trace 1" to "Trace 4") selects the source trace. The second group of buttons (labeled "Copy to Trace 1" to "Copy to Trace 4") selects the destination.

Remote command:

`TRACe<n>:COPY` on page 173

Preset Traces

Restores the default configuration for all traces in a window.

Trace Config

Opens a dialog box made up out of three tabs to configure traces.

The first tab contains functionality to configure a trace. For more information see ["Traces"](#) on page 86.

The second tab contains functionality to export trace data. For more information see ["Trace Export"](#) on page 87.

The third tab contains functionality to copy traces. For more information see ["Copy Trace"](#) on page 87.

Trace Export

The "Trace Export" tab contains functionality to export trace data.

"Export all traces and all table results" Turns the export of all measurement results (traces and numerical results) on and off.
If on, selecting a particular trace to export in the "Trace to Export" dropdown menu is unavailable.

"Include Instrument Measurement Settings" Includes or excludes the measurement configuration as shown in the channel bar from the export.

"Trace to Export" Selects the trace that will be exported to a file.

"Decimal Separator" Selects the decimal separator for floating-point numerals for the ASCII Trace export. Evaluation programs require different separators in different languages.

"Export Trace to ASCII File" Opens a file selection dialog box and saves the selected trace in ASCII format to the specified file and directory.

Remote command:

Decimal separator:

[FORMat:DEXPort:DSEParator](#) on page 171

Export trace to ASCII file:

[MMEMory:STORe<n>:TRACe](#) on page 172

Selecting a trace:

[FORMat:DEXPort:TRACes](#) on page 172

Export the header:

[FORMat:DEXPort:HEADer](#) on page 171

6.3 Using Markers

Markers help you to read out measurement results for particular frequencies or mark a particular point on a trace. The noise figure application features four markers. Markers in the noise figure application are linked. If you use more than one measurement window and activate a marker in one window, it also appears in all other measurement windows on the same horizontal position.

- [Marker Configuration](#).....88
- [Marker Positioning](#)..... 90

6.3.1 Marker Configuration

Access (marker configuration): MKR > "Marker Config" > "Marker"

Access (marker settings): MKR > "Marker Config" > "Marker Settings"

The "Marker Configuration" dialog box and the "Marker" menu contain all functionality necessary to control markers.

The "Marker Configuration" dialog box consists of two tabs.

The "Markers" tab contains functionality to define characteristics for each marker.

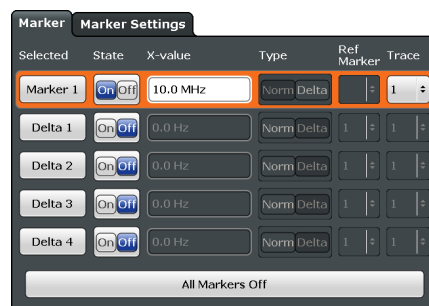

The "Marker Settings" tab contains general marker functionality.

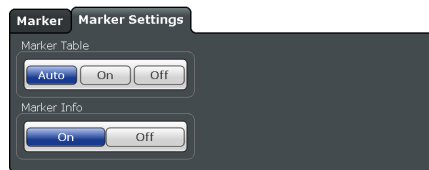

Marker (1...4).....	89
Marker Type.....	89
Marker to Trace.....	89
All Markers Off.....	89
Marker Config.....	89
Marker Table Display.....	90
Marker Info.....	90

Marker (1...4)

Selects or turns the corresponding marker on and off.

Turning on a marker also opens an input field to define the horizontal position of the marker.

By default, the first marker you turn on is a normal marker, all others are delta markers.

Marker Type

Toggles the marker type.

The type for marker 1 is always "Normal", the type for delta marker 1 is always "Delta". These types cannot be changed.

Note: If normal marker 1 is the active marker, switching the "Mkr Type" activates an additional delta marker 1. For any other marker, switching the marker type does not activate an additional marker, it only switches the type of the selected marker.

"Normal" A normal marker indicates the absolute value at the defined position in the diagram.

"Delta" A delta marker defines the value of the marker relative to the specified reference marker (marker 1 by default).

Remote command:

[CALCulate<n>:MARKer<m>\[:STATe\]](#) on page 183

[CALCulate<n>:DELTAmarker<m>\[:STATe\]](#) on page 186

Marker to Trace

Opens an input field to assign the marker to a particular trace if you are using more than one trace.

All Markers Off

Deactivates all markers in one step.

Remote command:

[CALCulate<n>:MARKer<m>:AOFF](#) on page 183

Marker Config

Opens the "Marker Configuration" dialog box.

The "Marker Configuration" dialog box contains all marker functions necessary to set up the four markers supported by the application.

- Selected
Highlights the currently selected marker.
- State
Turns a marker on and off.
- X-value
Defines the marker position on the horizontal axis.
- Type
Selects the marker type. For more information see "Marker Type" on page 89.
- Trace
Selects the trace the marker is positioned on.

Marker Table Display

Defines how the marker information is displayed.

- "On" Displays the marker information in a table in a separate area beneath the diagram.
- "Off" Displays the marker information within the diagram area. No separate marker table is displayed.

Remote command:

`DISPlay:MTABLE` on page 189

Marker Info

Turns the marker information displayed in the diagram on and off.

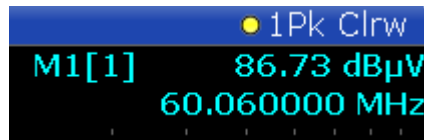

Remote command:

`DISPlay:MINFo[:STAT]` on page 189

6.3.2 Marker Positioning

If you are using more than one measurement window, the application performs the peak search in the currently selected measurement window. The currently selected measurement window has a blue border. Because the markers are linked in the noise figure application, the frequency position of the marker in the other window is updated accordingly, even if it means that the marker is on a peak in one window only.

Select Marker <x>.....	91
Peak Search.....	91
Search Next Peak.....	91
Search Minimum.....	91
Search Next Minimum.....	92
Marker to Single Frequency.....	92

Select Marker <x>

Opens a dialog box to select and activate or deactivate one or more markers.

The number in the softkey label (<x>) shows the number of the currently selected marker.



Remote command:

Marker selected via suffix <m> in remote commands.

Peak Search

Sets the selected marker/delta marker to the maximum of the trace. If no marker is active, marker 1 is activated.

Remote command:

[CALCulate<n>:MARKer<m>:MAXimum\[:PEAK\]](#) on page 190

[CALCulate<n>:DELTAmarker<m>:MAXimum\[:PEAK\]](#) on page 192

Search Next Peak

Sets the selected marker/delta marker to the next (lower) maximum of the assigned trace. If no marker is active, marker 1 is activated.

Remote command:

[CALCulate<n>:MARKer<m>:MAXimum:NEXT](#) on page 190

[CALCulate<n>:MARKer<m>:MAXimum:RIGHT](#) on page 190

[CALCulate<n>:MARKer<m>:MAXimum:LEFT](#) on page 190

[CALCulate<n>:DELTAmarker<m>:MAXimum:NEXT](#) on page 192

[CALCulate<n>:DELTAmarker<m>:MAXimum:RIGHT](#) on page 193

[CALCulate<n>:DELTAmarker<m>:MAXimum:LEFT](#) on page 192

Search Minimum

Sets the selected marker/delta marker to the minimum of the trace. If no marker is active, marker 1 is activated.

Remote command:

[CALCulate<n>:MARKer<m>:MINimum\[:PEAK\]](#) on page 191

[CALCulate<n>:DELTAmarker<m>:MINimum\[:PEAK\]](#) on page 194

Search Next Minimum

Sets the selected marker/delta marker to the next (higher) minimum of the selected trace. If no marker is active, marker 1 is activated.

Remote command:

`CALCulate<n>:MARKer<m>:MINimum:NEXT` on page 191
`CALCulate<n>:MARKer<m>:MINimum:LEFT` on page 191
`CALCulate<n>:MARKer<m>:MINimum:RIGHT` on page 191
`CALCulate<n>:DELTamarker<m>:MINimum:NEXT` on page 193
`CALCulate<n>:DELTamarker<m>:MINimum:LEFT` on page 193
`CALCulate<n>:DELTamarker<m>:MINimum:RIGHT` on page 194

Marker to Single Frequency

Starts a single frequency measurement on the current marker position.

When you use this function, the application changes the tuning mode and automatically adjusts the single frequency to that of the current marker position.

For more information see [Chapter 4.1.3, "Single Frequency Measurements"](#), on page 25.

6.4 Limit Line Settings and Functions

Access: LINES

The noise figure measurement application supports up to eight active limit lines in each active measurement window.

**Stored limit line settings**

When storing and recalling limit line settings, consider the information provided in the Data Management chapter of the R&S FSW User Manual.

- [Limit Line Management](#).....92
- [Limit Line Details](#).....95

6.4.1 Limit Line Management

Access: "Overview" > "Analysis" > "Lines" > "Limit Lines"

or: LINES > "Line Config" > "Limit Lines"

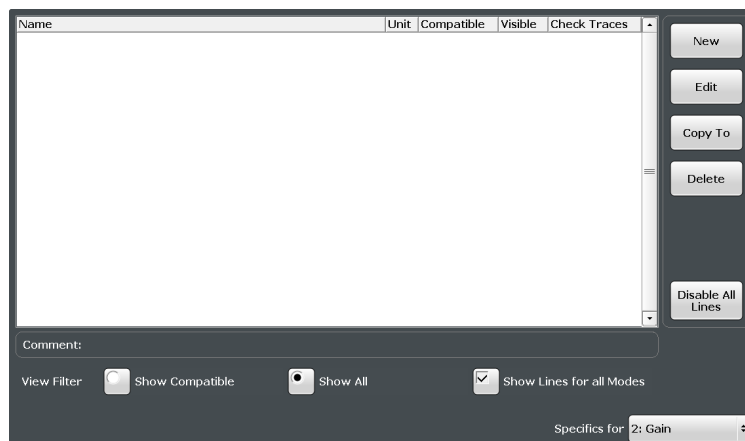

For the limit line overview, the R&S FSW searches for all stored limit lines with the file extension `.LIN` in the `limits` subfolder of the main installation folder. The overview allows you to determine which limit lines are available and can be used for the current measurement.

For details on settings for individual lines see [Chapter 6.4.2, "Limit Line Details"](#), on page 95.

Name	93
Unit	93
Compatibility	93
Visibility	93
Traces to be Checked	94
Comment	94
Show compatible limit lines	94
Show lines for noise	94
Create New Line	94
Edit Line	94
Copy Line	94
Delete Line	94
Disable All Lines	94

Name

The name of the stored limit line.

Unit

The unit in which the y-values of the data points of the limit line are defined.

Compatibility

Indicates whether the limit line definition is compatible with the current measurement settings.

Visibility

Displays or hides the limit line in the diagram. Up to 8 limit lines can be visible at the same time. Inactive limit lines can also be displayed in the diagram.

Remote command:

[CALCulate<n>:LIMit<k>:LOWer:STATe](#) on page 177

[CALCulate<n>:LIMit<k>:UPPer:STATe](#) on page 179

[CALCulate<n>:LIMit<k>:ACTive?](#) on page 179

Traces to be Checked

Defines which traces are automatically checked for conformance with the limit lines. As soon as a trace to be checked is defined, the assigned limit line is active. One limit line can be activated for several traces simultaneously. If any of the "Traces to be Checked" violate any of the active limit lines, a message is indicated in the diagram.

Remote command:

[CALCulate<n>:LIMit<k>:TRACe<t>:CHECK](#) on page 182

Comment

An optional description of the limit line.

Show compatible limit lines

Defines which of the stored limit lines are included in the overview.

If active, only limit lines that are compatible to the result display currently in focus are displayed.

Show lines for noise

If activated (default), only limit lines created for noise figure measurements are displayed. Otherwise, all limit lines are displayed.

Create New Line

Creates a new limit line.

Edit Line

Edit an existing limit line configuration.

Copy Line

Copy the selected limit line configuration to create a new line.

Remote command:

[CALCulate<n>:LIMit<k>:COPY](#) on page 179

Delete Line

Delete the selected limit line configuration.

Remote command:

[CALCulate<n>:LIMit<k>:DELeTe](#) on page 180

Disable All Lines

Disable all limit lines in one step.

Remote command:

[CALCulate<n>:LIMit<k>:STATe](#) on page 181

6.4.2 Limit Line Details

Access: "Overview" > "Analysis" > "Lines" > "Limit Lines" > "New" / "Edit" / "Copy To"
or: LINES > "Line Config" > "Limit Lines" > "New" / "Edit" / "Copy To"

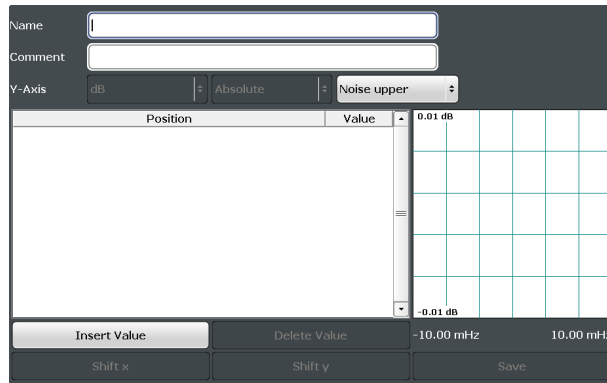

Name.....	95
Comment.....	95
Y-Axis.....	95
Data points.....	96
Insert Value.....	96
Delete Value.....	96
Shift x.....	96
Shift y.....	96
Save.....	96

Name

Defines the limit line name. All names must be compatible with Windows conventions for file names. The limit line data is stored under this name (with a `.LIN` extension).

Remote command:

`CALCulate<n>:LIMit<k>:NAME` on page 175

Comment

Defines an optional comment for the limit line. The text may contain up to 40 characters.

Remote command:

`CALCulate<n>:LIMit<k>:COMMeNt` on page 174

Y-Axis

Describes the vertical axis on which the data points of the limit line are defined.

You can select the type of limit line (upper or lower) for each type of result. From that information, the application sets the level unit and y-axis scaling. Both are then fix parameters because the unit depends on the result and the scaling is always absolute in case of noise figure measurements.

Data points

Each limit line is defined by a minimum of 2 and a maximum of 200 data points. Each data point is defined by its position (x-axis) and value (y-value). Data points must be defined in ascending order. The same position can have two different values.

Remote command:

`CALCulate<n>:LIMit<k>:CONTrol[:DATA]` on page 176

`CALCulate<n>:LIMit<k>:LOWer[:DATA]` on page 177

`CALCulate<n>:LIMit<k>:UPPer[:DATA]` on page 178

Insert Value

Inserts a data point in the limit line above the selected one in the "Edit Limit Line" dialog box.

Delete Value

Deletes the selected data point in the "Edit Limit Line" dialog box.

Shift x

Shifts the x-value of each data point horizontally by the defined shift width.

Remote command:

`CALCulate<n>:LIMit<k>:CONTrol:SHIFt` on page 176

Shift y

Shifts the y-value of each data point vertically by the defined shift width.

Remote command:

`CALCulate<n>:LIMit<k>:LOWer:SHIFt` on page 177

`CALCulate<n>:LIMit<k>:UPPer:SHIFt` on page 178

Save

Saves the currently edited limit line under the name defined in the "Name" field.

7 Remote Control Commands for Noise Measurements

The following remote control commands are required to configure and perform noise figure measurements in a remote environment. The R&S FSW must already be set up for remote operation in a network as described in the base unit manual.



Universal functionality

Note that basic tasks that are also performed in the base unit in the same way are not described here. For a description of such tasks, see the R&S FSW User Manual.

In particular, this includes:

- Managing Settings and Results, i.e. storing and loading settings and result data.
- Basic instrument configuration, e.g. checking the system configuration, customizing the screen layout, or configuring networks and remote operation.
- Using the common status registers (specific status registers for Pulse measurements are not used).

• Common Suffixes	97
• Introduction	98
• Controlling the Noise Figure Measurement Channel	103
• Working with Windows in the Display	107
• General Window Commands	113
• Measurement Results	114
• Defining the Measurement Frequency	116
• Selecting DUT Characteristics	120
• Configuring the Noise Source	121
• Configuring Additional Loss	129
• Configuring the Analyzer	133
• Using the Uncertainty Calculator	137
• Performing Measurements	145
• Configuring the Inputs and Outputs	150
• Configuring the Display	166
• Working with Traces	169
• Working with Limit Lines	173
• Working with Markers	182
• Using the Status Register	194
• Deprecated Remote Commands for Noise Figure Measurements	200

7.1 Common Suffixes

In the R&S FSW Noise measurements application, the following common suffixes are used in remote commands:

Table 7-1: Common suffixes used in remote commands in the R&S FSW Noise measurements application

Suffix	Value range	Description
<m>	1 to 4	Marker
<n>	1 to 16	Window (in the currently selected measurement channel)
<t>	1 to 4	Trace
<k>	1 to 8	Limit line

7.2 Introduction

Commands are program messages that a controller (e.g. a PC) sends to the instrument or software. They operate its functions ('setting commands' or 'events') and request information ('query commands'). Some commands can only be used in one way, others work in two ways (setting and query). If not indicated otherwise, the commands can be used for settings and queries.

The syntax of a SCPI command consists of a header and, in most cases, one or more parameters. To use a command as a query, you have to append a question mark after the last header element, even if the command contains a parameter.

A header contains one or more keywords, separated by a colon. Header and parameters are separated by a "white space" (ASCII code 0 to 9, 11 to 32 decimal, e.g. blank). If there is more than one parameter for a command, these are separated by a comma from one another.

Only the most important characteristics that you need to know when working with SCPI commands are described here. For a more complete description, refer to the User Manual of the R&S FSW.



Remote command examples

Note that some remote command examples mentioned in this general introduction may not be supported by this particular application.

7.2.1 Conventions used in Descriptions

Note the following conventions used in the remote command descriptions:

- Command usage**
 If not specified otherwise, commands can be used both for setting and for querying parameters.
 If a command can be used for setting or querying only, or if it initiates an event, the usage is stated explicitly.
- Parameter usage**
 If not specified otherwise, a parameter can be used to set a value and it is the result of a query.
 Parameters required only for setting are indicated as **Setting parameters**.

Parameters required only to refine a query are indicated as **Query parameters**. Parameters that are only returned as the result of a query are indicated as **Return values**.

- **Conformity**

Commands that are taken from the SCPI standard are indicated as **SCPI confirmed**. All commands used by the R&S FSW follow the SCPI syntax rules.

- **Asynchronous commands**

A command which does not automatically finish executing before the next command starts executing (overlapping command) is indicated as an **Asynchronous command**.

- **Reset values (*RST)**

Default parameter values that are used directly after resetting the instrument (*RST command) are indicated as *RST values, if available.

- **Default unit**

This is the unit used for numeric values if no other unit is provided with the parameter.

- **Manual operation**

If the result of a remote command can also be achieved in manual operation, a link to the description is inserted.

7.2.2 Long and Short Form

The keywords have a long and a short form. You can use either the long or the short form, but no other abbreviations of the keywords.

The short form is emphasized in upper case letters. Note however, that this emphasis only serves the purpose to distinguish the short from the long form in the manual. For the instrument, the case does not matter.

Example:

`SENSe:FREQuency:CENTer` is the same as `SENS:FREQ:CENT`.

7.2.3 Numeric Suffixes

Some keywords have a numeric suffix if the command can be applied to multiple instances of an object. In that case, the suffix selects a particular instance (e.g. a measurement window).

Numeric suffixes are indicated by angular brackets (<n>) next to the keyword.

If you don't quote a suffix for keywords that support one, a 1 is assumed.

Example:

`DISPlay[:WINDow<1...4>]:ZOOM:STATe` enables the zoom in a particular measurement window, selected by the suffix at `WINDow`.

`DISPlay:WINDow4:ZOOM:STATe ON` refers to window 4.

7.2.4 Optional Keywords

Some keywords are optional and are only part of the syntax because of SCPI compliance. You can include them in the header or not.

Note that if an optional keyword has a numeric suffix and you need to use the suffix, you have to include the optional keyword. Otherwise, the suffix of the missing keyword is assumed to be the value 1.

Optional keywords are emphasized with square brackets.

Example:

Without a numeric suffix in the optional keyword:

```
[SENSe:]FREQuency:CENTer is the same as FREQuency:CENTer
```

With a numeric suffix in the optional keyword:

```
DISPlay[:WINDow<1...4>]:ZOOM:STATe
```

DISPlay:ZOOM:STATe ON enables the zoom in window 1 (no suffix).

DISPlay:WINDow4:ZOOM:STATe ON enables the zoom in window 4.

7.2.5 Alternative Keywords

A vertical stroke indicates alternatives for a specific keyword. You can use both keywords to the same effect.

Example:

```
[SENSe:]BANDwidth|BWIDth[:RESolution]
```

In the short form without optional keywords, BAND 1MHZ would have the same effect as BWID 1MHZ.

7.2.6 SCPI Parameters

Many commands feature one or more parameters.

If a command supports more than one parameter, these are separated by a comma.

Example:

```
LAYout:ADD:WINDow Spectrum,LEFT,MTABLE
```

Parameters may have different forms of values.

- [Numeric Values](#)..... 101
- [Boolean](#)..... 101
- [Character Data](#)..... 102
- [Character Strings](#)..... 102
- [Block Data](#)..... 102

7.2.6.1 Numeric Values

Numeric values can be entered in any form, i.e. with sign, decimal point or exponent. In case of physical quantities, you can also add the unit. If the unit is missing, the command uses the basic unit.

Example:

with unit: `SENSe:FREQuency:CENTer 1GHZ`

without unit: `SENSe:FREQuency:CENTer 1E9` would also set a frequency of 1 GHz.

Values exceeding the resolution of the instrument are rounded up or down.

If the number you have entered is not supported (e.g. in case of discrete steps), the command returns an error.

Instead of a number, you can also set numeric values with a text parameter in special cases.

- **MIN/MAX**
Defines the minimum or maximum numeric value that is supported.
- **DEF**
Defines the default value.
- **UP/DOWN**
Increases or decreases the numeric value by one step. The step size depends on the setting. In some cases you can customize the step size with a corresponding command.

Querying numeric values

When you query numeric values, the system returns a number. In case of physical quantities, it applies the basic unit (e.g. Hz in case of frequencies). The number of digits after the decimal point depends on the type of numeric value.

Example:

Setting: `SENSe:FREQuency:CENTer 1GHZ`

Query: `SENSe:FREQuency:CENTer?` would return `1E9`

In some cases, numeric values may be returned as text.

- **INF/NINF**
Infinity or negative infinity. Represents the numeric values 9.9E37 or -9.9E37.
- **NAN**
Not a number. Represents the numeric value 9.91E37. NAN is returned in case of errors.

7.2.6.2 Boolean

Boolean parameters represent two states. The "ON" state (logically true) is represented by "ON" or a numeric value 1. The "OFF" state (logically untrue) is represented by "OFF" or the numeric value 0.

Querying boolean parameters

When you query boolean parameters, the system returns either the value 1 ("ON") or the value 0 ("OFF").

Example:

Setting: `DISPlay:WINDow:ZOOM:STATe ON`

Query: `DISPlay:WINDow:ZOOM:STATe?` would return 1

7.2.6.3 Character Data

Character data follows the syntactic rules of keywords. You can enter text using a short or a long form. For more information see [Chapter 7.2.2, "Long and Short Form"](#), on page 99.

Querying text parameters

When you query text parameters, the system returns its short form.

Example:

Setting: `SENSe:BANDwidth:RESolution:TYPE NORMal`

Query: `SENSe:BANDwidth:RESolution:TYPE?` would return `NORM`

7.2.6.4 Character Strings

Strings are alphanumeric characters. They have to be in straight quotation marks. You can use a single quotation mark (') or a double quotation mark (").

Example:

`INSTRument:DElete 'Spectrum'`

7.2.6.5 Block Data

Block data is a format which is suitable for the transmission of large amounts of data.

The ASCII character # introduces the data block. The next number indicates how many of the following digits describe the length of the data block. In the example the 4 following digits indicate the length to be 5168 bytes. The data bytes follow. During the transmission of these data bytes all end or other control signs are ignored until all bytes are transmitted. #0 specifies a data block of indefinite length. The use of the indefinite format requires an `NL^END` message to terminate the data block. This format is useful when the length of the transmission is not known or if speed or other considerations prevent segmentation of the data into blocks of definite length.

7.3 Controlling the Noise Figure Measurement Channel

The following commands are necessary to control the measurement channel.

INSTrument:CREate:DUPLicate	103
INSTrument:CREate[:NEW]	103
INSTrument:CREate:REPLace	104
INSTrument:DELeTe	104
INSTrument:LIST?	104
INSTrument:REName	106
INSTrument[:SELeCt]	106
SYSTem:PRESet:CHANnel[:EXECute]	106

INSTrument:CREate:DUPLicate

This command duplicates the currently selected measurement channel, i.e. creates a new measurement channel of the same type and with the identical measurement settings. The name of the new channel is the same as the copied channel, extended by a consecutive number (e.g. "IQAnalyzer" -> "IQAnalyzer2").

The channel to be duplicated must be selected first using the `INST:SEL` command.

Example:

```
INST:SEL 'IQAnalyzer'
```

```
INST:CRE:DUPL
```

Duplicates the channel named 'IQAnalyzer' and creates a new measurement channel named 'IQAnalyzer2'.

Usage: Event

INSTrument:CREate[:NEW] <ChannelType>, <ChannelName>

This command adds an additional measurement channel.

The number of measurement channels you can configure at the same time depends on available memory.

Parameters:

<ChannelType> Channel type of the new channel.
For a list of available channel types see [INSTrument:LIST?](#) on page 104.

<ChannelName> String containing the name of the channel. The channel name is displayed as the tab label for the measurement channel.
Note: If the specified name for a new channel already exists, the default name, extended by a sequential number, is used for the new channel (see [INSTrument:LIST?](#) on page 104).

Example:

```
INST:CRE IQ, 'IQAnalyzer2'
```

Adds an additional I/Q Analyzer channel named "IQAnalyzer2".

INSTRument:CREate:REPLace <ChannelName1>,<ChannelType>,<ChannelName2>

This command replaces a measurement channel with another one.

Setting parameters:

- <ChannelName1> String containing the name of the measurement channel you want to replace.
- <ChannelType> Channel type of the new channel.
For a list of available channel types see [INSTRument:LIST?](#) on page 104.
- <ChannelName2> String containing the name of the new channel.
Note: If the specified name for a new channel already exists, the default name, extended by a sequential number, is used for the new channel (see [INSTRument:LIST?](#) on page 104).

Example: `INST:CRE:REPL 'IQAnalyzer2',IQ,'IQAnalyzer'`
Replaces the channel named 'IQAnalyzer2' by a new measurement channel of type 'IQ Analyzer' named 'IQAnalyzer'.

Usage: Setting only

INSTRument:DELeTe <ChannelName>

This command deletes a measurement channel.

If you delete the last measurement channel, the default "Spectrum" channel is activated.

Parameters:

- <ChannelName> String containing the name of the channel you want to delete.
A measurement channel must exist in order to be able delete it.

Example: `INST:DEL 'IQAnalyzer4'`
Deletes the channel with the name 'IQAnalyzer4'.

Usage: Event

INSTRument:LIST?

This command queries all active measurement channels. This is useful in order to obtain the names of the existing measurement channels, which are required in order to replace or delete the channels.

Return values:

- <ChannelType>,
<ChannelName> For each channel, the command returns the channel type and channel name (see tables below).
Tip: to change the channel name, use the [INSTRument:REName](#) command.

Example: `INST:LIST?`
 Result for 3 measurement channels:
 'ADEM', 'Analog Demod', 'IQ', 'IQ
 Analyzer', 'IQ', 'IQ Analyzer2'

Usage: Query only

Table 7-2: Available measurement channel types and default channel names in Signal and Spectrum Analyzer mode

Application	<ChannelType> Parameter	Default Channel Name*)
Spectrum	SANALYZER	Spectrum
1xEV-DO BTS (R&S FSW-K84)	BDO	1xEV-DO BTS
1xEV-DO MS (R&S FSW-K85)	MDO	1xEV-DO MS
3GPP FDD BTS (R&S FSW-K72)	BWCD	3G FDD BTS
3GPP FDD UE (R&S FSW-K73)	MWCD	3G FDD UE
802.11ad (R&S FSW-K95)	WIGIG	802.11ad
Amplifier Measurements (R&S FSW-K18)	AMPLifier	Amplifier
Analog Demodulation (R&S FSW-K7)	ADEM	Analog Demod
Avionics (R&S FSW-K15)	AVIonics	Avionics
cdma2000 BTS (R&S FSW-K82)	BC2K	CDMA2000 BTS
cdma2000 MS (R&S FSW-K83)	MC2K	CDMA2000 MS
DOCSIS 3.1 (R&S FSW-K192/193)	DOCSis	DOCSIS 3.1
GSM (R&S FSW-K10)	GSM	GSM
I/Q Analyzer	IQ	IQ Analyzer
LTE (R&S FSW-K10x)	LTE	LTE
Multi-Carrier Group Delay (R&S FSW-K17)	MCGD	MC Group Delay
Noise (R&S FSW-K30)	NOISE	Noise
Phase Noise (R&S FSW-K40)	PNOISE	Phase Noise
Pulse (R&S FSW-K6)	PULSE	Pulse
Real-Time Spectrum (R&S FSW-B160R/- K160RE)	RTIM	Real-Time Spectrum
Spurious Measurements (R&S FSW-K50)	SPUR	Spurious
TD-SCDMA BTS (R&S FSW-K76)	BTDS	TD-SCDMA BTS
TD-SCDMA UE (R&S FSW-K77)	MTDS	TD-SCDMA UE
Transient Analysis (R&S FSW-K60)	TA	Transient Analysis
*) the default channel name is also listed in the table. If the specified name for a new channel already exists, the default name, extended by a sequential number, is used for the new channel.		

Application	<ChannelType> Parameter	Default Channel Name*)
VSA (R&S FSW-K70)	DDEM	VSA
WLAN (R&S FSW-K91)	WLAN	WLAN
*) the default channel name is also listed in the table. If the specified name for a new channel already exists, the default name, extended by a sequential number, is used for the new channel.		

INSTrument:REName <ChannelName1>, <ChannelName2>

This command renames a measurement channel.

Parameters:

- <ChannelName1> String containing the name of the channel you want to rename.
- <ChannelName2> String containing the new channel name.
Note that you cannot assign an existing channel name to a new channel; this will cause an error.

Example: `INST:REN 'IQAnalyzer2', 'IQAnalyzer3'`
Renames the channel with the name 'IQAnalyzer2' to 'IQAnalyzer3'.

Usage: Setting only

INSTrument[:SElect] <ChannelType> | <ChannelName>

This command activates a new measurement channel with the defined channel type, or selects an existing measurement channel with the specified name.

Also see

- [INSTrument:CREate\[:NEW\]](#) on page 103

Parameters:

- <ChannelType> Channel type of the new channel.
For a list of available channel types see [INSTrument:LIST?](#) on page 104.
- <ChannelName> String containing the name of the channel.

Example: `INST IQ`
Activates a measurement channel for the I/Q Analyzer application (evaluation mode).
`INST 'MyIQSpectrum'`
Selects the measurement channel named 'MyIQSpectrum' (for example before executing further commands for that channel).

Usage: SCPI confirmed

SYSTem:PRESet:CHANnel[:EXECute]

This command restores the default instrument settings in the current channel.

Use `INST:SEL` to select the channel.

Example: `INST:SEL 'Spectrum2'`
 Selects the channel for "Spectrum2".
`SYST:PRES:CHAN:EXEC`
 Restores the factory default settings to the "Spectrum2" channel.

Usage: Event

Manual operation: See "Preset Channel" on page 41

7.4 Working with Windows in the Display

The following commands are required to change the evaluation type and rearrange the screen layout for a measurement channel as you do using the SmartGrid in manual operation. Since the available evaluation types depend on the selected application, some parameters for the following commands also depend on the selected measurement channel.

<code>LAYout:ADD[:WINDow]?</code>	107
<code>LAYout:CATalog[:WINDow]?</code>	109
<code>LAYout:IDENtify[:WINDow]?</code>	109
<code>LAYout:REMove[:WINDow]</code>	109
<code>LAYout:REPLace[:WINDow]</code>	110
<code>LAYout:SPLitter</code>	110
<code>LAYout:WINDow<n>:ADD?</code>	112
<code>LAYout:WINDow<n>:IDENtify?</code>	112
<code>LAYout:WINDow<n>:REMove</code>	113
<code>LAYout:WINDow<n>:REPLace</code>	113

`LAYout:ADD[:WINDow]?` <WindowName>,<Direction>,<WindowType>

This command adds a window to the display in the active measurement channel.

This command is always used as a query so that you immediately obtain the name of the new window as a result.

To replace an existing window, use the `LAYout:REPLace[:WINDow]` command.

Parameters:

<WindowName> String containing the name of the existing window the new window is inserted next to.
 By default, the name of a window is the same as its index. To determine the name and index of all active windows, use the `LAYout:CATalog[:WINDow]?` query.

<Direction> LEFT | RIGHT | ABOVE | BELOW
 Direction the new window is added relative to the existing window.

<WindowType> text value
 Type of result display (evaluation method) you want to add.
 See the table below for available parameter values.

Return values:

<NewWindowName> When adding a new window, the command returns its name (by default the same as its number) as a result.

Example:

```
LAY:ADD? '1', LEFT, MTAB
```

Result:

```
'2'
```

Adds a new window named '2' with a marker table to the left of window 1.

Usage: Query only

Manual operation: See "Noise Figure" on page 16
 See "Gain" on page 17
 See "Noise Temperature" on page 17
 See "Y-Factor" on page 18
 See "Power (Hot)" on page 19
 See "Power (Cold)" on page 19
 See "Cal Y-Factor" on page 20
 See "Cal Power (Hot)" on page 20
 See "Cal Power (Cold)" on page 21
 See "Result Table" on page 21
 See "Marker Table" on page 22

Table 7-3: <WindowType> parameter values for Noise Figure application

Parameter value	Window type
CPCold	Cal Power (Cold)
CPHot	Cal Power (Hot)
CYFactor	Cal Y-Factor
GAIN	Gain result display
MTABle	Marker table
NOISe	Noise figure result display
PCOLd	Power cold result display
PHOT	Power hot result display
RESults	Result table
TEMPerature	Noise temperature result display
YFACtor	Y-Factor result display

LAYout:CATalog[:WINDow]?

This command queries the name and index of all active windows in the active measurement channel from top left to bottom right. The result is a comma-separated list of values for each window, with the syntax:

<WindowName_1>,<WindowIndex_1>..<WindowName_n>,<WindowIndex_n>

Return values:

<WindowName> string
Name of the window.
In the default state, the name of the window is its index.

<WindowIndex> **numeric value**
Index of the window.

Example:

LAY:CAT?

Result:

'2',2,'1',1

Two windows are displayed, named '2' (at the top or left), and '1' (at the bottom or right).

Usage: Query only

LAYout:IDENtify[:WINDow]? <WindowName>

This command queries the **index** of a particular display window in the active measurement channel.

Note: to query the **name** of a particular window, use the [LAYout:WINDow<n>:IDENtify?](#) query.

Query parameters:

<WindowName> String containing the name of a window.

Return values:

<WindowIndex> Index number of the window.

Example:

LAY:WIND:IDEN? '2'

Queries the index of the result display named '2'.

Response:

2

Usage: Query only

LAYout:REMOve[:WINDow] <WindowName>

This command removes a window from the display in the active measurement channel.

Parameters:

<WindowName> String containing the name of the window.
In the default state, the name of the window is its index.

Example:

LAY:REM '2'

Removes the result display in the window named '2'.

Usage: Event

LAYout:REPLace[:WINDow] <WindowName>,<WindowType>

This command replaces the window type (for example from "Diagram" to "Result Summary") of an already existing window in the active measurement channel while keeping its position, index and window name.

To add a new window, use the [LAYout:ADD\[:WINDow\]?](#) command.

Parameters:

<WindowName> String containing the name of the existing window. By default, the name of a window is the same as its index. To determine the name and index of all active windows in the active measurement channel, use the [LAYout:CATalog\[:WINDow\]?](#) query.

<WindowType> Type of result display you want to use in the existing window. See [LAYout:ADD\[:WINDow\]?](#) on page 107 for a list of available window types.

Example: `LAY:REPL:WIND '1',MTAB`
Replaces the result display in window 1 with a marker table.

LAYout:SPLitter <Index1>,<Index2>,<Position>

This command changes the position of a splitter and thus controls the size of the windows on each side of the splitter.

Compared to the [DISPlay\[:WINDow<n>\]:SIZE](#) on page 114 command, the `LAYout:SPLitter` changes the size of all windows to either side of the splitter permanently, it does not just maximize a single window temporarily.

Note that windows must have a certain minimum size. If the position you define conflicts with the minimum size of any of the affected windows, the command will not work, but does not return an error.

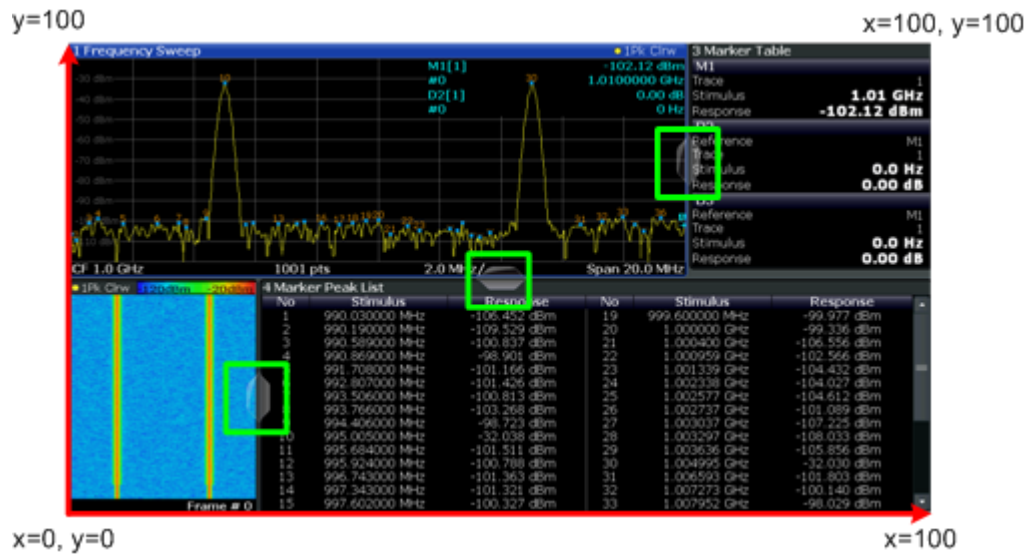

Figure 7-1: SmartGrid coordinates for remote control of the splitters

Parameters:

- <Index1> The index of one window the splitter controls.
- <Index2> The index of a window on the other side of the splitter.
- <Position> New vertical or horizontal position of the splitter as a fraction of the screen area (without channel and status bar and softkey menu).
The point of origin (x = 0, y = 0) is in the lower left corner of the screen. The end point (x = 100, y = 100) is in the upper right corner of the screen. (See Figure 7-1.)
The direction in which the splitter is moved depends on the screen layout. If the windows are positioned horizontally, the splitter also moves horizontally. If the windows are positioned vertically, the splitter also moves vertically.

Range: 0 to 100

Example:

LAY:SPL 1, 3, 50

Moves the splitter between window 1 ('Frequency Sweep') and 3 ('Marker Table') to the center (50%) of the screen, i.e. in the figure above, to the left.

Example:

LAY:SPL 1, 4, 70

Moves the splitter between window 1 ('Frequency Sweep') and 3 ('Marker Peak List') towards the top (70%) of the screen.

The following commands have the exact same effect, as any combination of windows above and below the splitter moves the splitter vertically.

LAY:SPL 3, 2, 70

LAY:SPL 4, 1, 70

LAY:SPL 2, 1, 70

LAYout:WINDow<n>:ADD? <Direction>,<WindowType>

This command adds a measurement window to the display. Note that with this command, the suffix <n> determines the existing window next to which the new window is added, as opposed to [LAYout:ADD\[:WINDow\]?](#), for which the existing window is defined by a parameter.

To replace an existing window, use the [LAYout:WINDow<n>:REPLace](#) command.

This command is always used as a query so that you immediately obtain the name of the new window as a result.

Suffix:

<n> [Window](#)

Parameters:

<Direction> LEFT | RIGHT | ABOVE | BELOW

<WindowType> Type of measurement window you want to add.
See [LAYout:ADD\[:WINDow\]?](#) on page 107 for a list of available window types.

Return values:

<NewWindowName> When adding a new window, the command returns its name (by default the same as its number) as a result.

Example:

LAY:WIND1:ADD? LEFT,MTAB

Result:

'2'

Adds a new window named '2' with a marker table to the left of window 1.

Usage:

Query only

LAYout:WINDow<n>:IDENTify?

This command queries the **name** of a particular display window (indicated by the <n> suffix) in the active measurement channel.

Note: to query the **index** of a particular window, use the [LAYout:IDENTify\[:WINDow\]?](#) command.

Suffix:

<n> [Window](#)

Return values:

<WindowName> String containing the name of a window.
In the default state, the name of the window is its index.

Example:

LAY:WIND2:IDEN?

Queries the name of the result display in window 2.

Response:

'2'

Usage:

Query only

LAYout:WINDow<n>:REMOve

This command removes the window specified by the suffix <n> from the display in the active measurement channel.

The result of this command is identical to the `LAYout:REMOve[:WINDow]` command.

Suffix:

<n> [Window](#)

Example:

`LAY:WIND2:REM`

Removes the result display in window 2.

Usage:

Event

LAYout:WINDow<n>:REPLace <WindowType>

This command changes the window type of an existing window (specified by the suffix <n>) in the active measurement channel.

The result of this command is identical to the `LAYout:REPLace[:WINDow]` command.

To add a new window, use the `LAYout:WINDow<n>:ADD?` command.

Suffix:

<n> [Window](#)

Parameters:

<WindowType> Type of measurement window you want to replace another one with.
See `LAYout:ADD[:WINDow]?` on page 107 for a list of available window types.

Example:

`LAY:WIND2:REPL MTAB`

Replaces the result display in window 2 with a marker table.

7.5 General Window Commands

The following commands are required to configure general window layout, independent of the application.

<code>DISPlay:FORMat</code>	113
<code>DISPlay[:WINDow<n>]:SIZE</code>	114

DISPlay:FORMat <Format>

This command determines which tab is displayed.

Parameters:

<Format>

SPLit

Displays the MultiView tab with an overview of all active channels

SINGle

Displays the measurement channel that was previously focused.

*RST: SING

Example:

DISP:FORM SPL

DISPlay[:WINDow<n>]:SIZE <Size>

This command maximizes the size of the selected result display window *temporarily*. To change the size of several windows on the screen permanently, use the `LAY:SPL` command (see [LAYout:SPLitter](#) on page 110).

Suffix:

<n>

Window

Parameters:

<Size>

LARGe

Maximizes the selected window to full screen. Other windows are still active in the background.

SMALI

Reduces the size of the selected window to its original size. If more than one measurement window was displayed originally, these are visible again.

*RST: SMALI

Example:

DISP:WIND2:SIZE LARG

7.6 Measurement Results

The following commands are necessary to query measurement results.

[TRACe<n>\[:DATA\]?.....](#) 114

TRACe<n>[:DATA]? <Trace>, <Result>

This command queries the noise measurement results.

Suffix:

<n>

Window

Query parameters:

<Trace>	Selects the trace to be read out. TRACE1 TRACE2 TRACE3 TRACE4
<Result>	Selects the result display to be read out. CPCold Queries calibration power (cold) results. CPHot Queries calibration power (hot) results. CYFactor Queries calibration y-factor results. GAIN Queries gain results. NOISe Queries noise figure results. NUNCertainty Queries noise figure uncertainty results. PCOLd Queries power (cold) results. PHOT Queries power (hot) results. TEMPerature Queries noise temperature results. YFACTOR Queries y-factor results.

Return values:

<TraceData>	For any graphical result display, the command returns one result for each measurement point. The unit depends on the result you are querying.
-------------	--------------------------------------------------------------------------------------------------------------------------------------------------

Example:

TRAC? TRACE1, GAIN
Queries the gain results for the first trace.

Usage:

Query only

Manual operation:

See ["Noise Figure"](#) on page 16
See ["Gain"](#) on page 17
See ["Noise Temperature"](#) on page 17
See ["Y-Factor"](#) on page 18
See ["Power \(Hot\)"](#) on page 19
See ["Power \(Cold\)"](#) on page 19
See ["Cal Y-Factor"](#) on page 20
See ["Cal Power \(Hot\)"](#) on page 20
See ["Cal Power \(Cold\)"](#) on page 21
See ["Result Table"](#) on page 21

7.7 Defining the Measurement Frequency

The following commands are necessary to define the frequency characteristics of the noise figure measurement.

[SENSe:]CONFigure:FREQuency:CONTInuous.....	116
[SENSe:]CONFigure:FREQuency:SINGle.....	116
[SENSe:]CONFigure:LIST:CONTInuous.....	117
[SENSe:]CONFigure:LIST:SINGle.....	117
[SENSe:]FREQuency:CENter.....	117
[SENSe:]FREQuency:TABLE:DATA.....	117
[SENSe:]SWEep:POINts.....	118
[SENSe:]FREQuency:SINGle.....	118
[SENSe:]FREQuency:SINGle:COUPling.....	118
[SENSe:]FREQuency:SPAN.....	118
[SENSe:]FREQuency:STARt.....	119
[SENSe:]FREQuency:STEP.....	119
[SENSe:]FREQuency:STOP.....	119

[SENSe:]CONFigure:FREQuency:CONTInuous

This command configures the software to perform a single frequency measurement in continuous sweep mode.

Example:

```
FREQ:SING 20MHz
Defines a measurement frequency of 20 MHz.
CONF:FREQ:CONT
INIT
Selects and initiates a single frequency measurement.
```

Usage: Event

Manual operation: See "[Tuning Mode](#)" on page 43

[SENSe:]CONFigure:FREQuency:SINGle

This command configures the software to perform a single frequency measurement in single sweep mode.

Example:

```
FREQ:SING 20MHz
Defines a measurement frequency of 20 MHz.
CONF:FREQ:SING
INIT
Selects and initiates a single frequency measurement.
```

Usage: Event

Manual operation: See "[Tuning Mode](#)" on page 43

[SENSe:]CONFigure:LIST:CONTinuous

This command configures the software to perform a frequency list measurement in continuous sweep mode.

Example: CONF:LIST:CONT
 INIT
 Selects and initiates a frequency list measurement.

Usage: Event

Manual operation: See "[Tuning Mode](#)" on page 43

[SENSe:]CONFigure:LIST:SINGLE

This command configures the software to perform a frequency list measurement in single sweep mode.

Example: CONF:LIST:SING
 INIT
 Selects and initiates a single frequency list measurement.

Usage: Event

Manual operation: See "[Tuning Mode](#)" on page 43

[SENSe:]FREQuency:CENter <Frequency>

This command defines the center frequency.

Parameters:
<Frequency> Range: see datasheet
 *RST: fmax/2
 Default unit: Hz

Example: FREQ:CENT 1GHZ
 Defines a center frequency of 1 GHz.

Manual operation: See "[Center](#)" on page 43

[SENSe:]FREQuency:TABLE:DATA <Frequency>

This command defines the contents of the frequency table.

The command overwrites the current contents of the frequency table.

Parameters:
<Frequency> Defines a frequency for each entry in the frequency table. A frequency table can contain up to 501 entries.
Range: 0 Hz to fmax

Example: FREQ:TABL:DATA 100MHZ,200MHZ,300MHZ,400MHZ,
 500MHZ
 Creates a frequency table with five entries.

Manual operation: See ["Populate Table"](#) on page 47

[SENSe:]SWEep:POINTs <SweepPoints>

This command defines the number of measurement points analyzed during a sweep.

Parameters:

<SweepPoints> Range: 1 to 500
 *RST: 20

Example: SWE:POIN 100
 Defines 100 measurement points.

Manual operation: See ["\(Measurement\) Points"](#) on page 44
 See ["\(Measurement\) Points"](#) on page 45

[SENSe:]FREQuency:SINGle <Frequency>

This command defines the frequency for single frequency measurements.

Parameters:

<Frequency> The minimum and maximum frequency depend on the hardware. Refer to the datasheet for details.
 *RST: 100 MHz

Example: FREQ:SING 200MHZ
 Defines a measurement frequency of 200 MHz.

Manual operation: See ["Center"](#) on page 43
 See ["Single \(Frequency\)"](#) on page 45

[SENSe:]FREQuency:SINGle:COUPling <State>

This command couples or decouples the frequency to the contents of the sweep list.

Parameters:

<State> **ON**
 Only frequencies in the frequency list can be selected for single frequency measurements.
 OFF
 Any frequency can be defined for single frequency measurements.
 *RST: OFF

Example: FREQ:SING:COUP ON
 Couples single frequency measurements to the frequency list.

Manual operation: See ["Coupled to Sweep List"](#) on page 45

[SENSe:]FREQuency:SPAN

This command defines the frequency span.

If you change the span, the application creates a new frequency list.

Parameters:

 This parameter is
*RST: RST value

Example: `FREQ:SPAN 500MHZ`
Defines a span of 500 MHz.

Manual operation: See "[Span](#)" on page 44

[SENSe:]FREQuency:STARt <Frequency>

This command defines the start frequency.

If you change the start frequency, the application creates a new frequency list.

Parameters:

<Frequency> *RST: RST value

Example: `FREQ:STAR 900MHZ`
Defines a start frequency of 900 MHz.

Manual operation: See "[Start and Stop Frequency](#)" on page 44

[SENSe:]FREQuency:STEP <Stepsize>

This command defines the frequency stepsize in the frequency table.

The stepsize corresponds to the distance from one measurement point to another.

If you change the stepsize, the application creates a new frequency list.

Parameters:

<Stepsize> Range: 0 Hz to span
*RST: 100 MHz

Example: `FREQ:STEP 100MHZ`
Defines a stepsize of 100 MHz.

Manual operation: See "[Step](#)" on page 44

[SENSe:]FREQuency:STOP <Frequency>

This command defines the stop frequency.

If you change the stop frequency, the application creates a new frequency list.

Parameters:

<Frequency> *RST: RST value

Example: `FREQ:STOP 900MHZ`
Defines a stop frequency of 900 MHz.

Manual operation: See "[Start and Stop Frequency](#)" on page 44

7.8 Selecting DUT Characteristics

The following commands are necessary to define DUT characteristics.

[SENSe:]CONFigure:MODE:SYSTem:IF:FREQuency.....	120
[SENSe:]CONFigure:MODE:SYSTem:LO.....	120
[SENSe:]CONFigure:MODE:SYSTem:LO:FREQuency.....	120
[SENSe:]CONFigure:MODE:DUT.....	121
[SENSe:]CORRection:IREJection.....	121

[SENSe:]CONFigure:MODE:SYSTem:IF:FREQuency <Frequency>

This command defines the frequency for DUTs with a fixed IF.

Parameters:

<Frequency>	Range:	0 Hz to 100 GHz
	*RST:	10 MHz, if frequency converting mode has been selected

Example: CONF:MODE:SYST:IF:FREQ 1GHZ
 Defines a fixed IF of 1 GHz.

Manual operation: See "IF Fixed" on page 48

[SENSe:]CONFigure:MODE:SYSTem:LO <LOType>

This command selects the type of local oscillator you are using.

The command is available for measurements on frequency converting DUTs ([SENSe:]CONFigure:MODE:DUT).

Parameters:

<LOType>	FIXed
	The local oscillator is used as a fixed frequency source. The IF is variable.
	VARIable
	The local oscillator is used as a variable frequency source. The IF is fixed.

Example: CONF:MODE:DUT DOWN
 CONF:MODE:SYST:LO FIX
 CONF:MODE:SYST:LO:FREQ 1GHZ
 Selects a fixed LO frequency (= 1 GHz) on a down converting DUT.

Manual operation: See "Mode" on page 47

[SENSe:]CONFigure:MODE:SYSTem:LO:FREQuency <LOFrequency>

This command defines the frequency for DUTs with a fixed LO.

Parameters:

<LOFrequency> Range: 0 Hz to 100 GHz
 *RST: 10 MHz, if frequency converting mode has been selected

Example:

CONF:MODE:SYST:LO:FREQ 1GHZ
 Defines a fixed LO frequency of 1 GHz.

Manual operation: See "[LO Fixed](#)" on page 48

[SENSe:]CONFigure:MODE:DUT <DUTType>

This command selects the type of DUT you are testing.

Note that you have to use `[SENSe:]CONFigure:MODE:SYSTem:LO` to select if the LO or IF are fixed.

Parameters:

<DUTType> **AMPLifier**
 Measurements on fixed frequency DUTs.
 DOWNconv
 Measurements on down-converting DUTs.
 UPConv
 Measurements on up-converting DUTs.
 *RST: AMPLifier

Example:

CONF:MODE:DUT DOWN
 Selects the measurement mode for a down-converting DUT.

Manual operation: See "[Mode](#)" on page 47

[SENSe:]CORRection:IREJection <ImageRejection>

This command defines the image frequency rejection for the DUT.

Parameters:

<ImageRejection> Range: 0 to 999.99
 *RST: 999.99
 Default unit: dB

Example:

CORR:IREJ 0
 Turns image rejection off.

Manual operation: See "[Image Rejection](#)" on page 48

7.9 Configuring the Noise Source

The following commands are necessary to define the noise source characteristics.

[SENSe:]CORRection:ENR:CALibration:SPOT:COLD.....	122
[SENSe:]CORRection:ENR:CALibration:SPOT:HOT.....	122
[SENSe:]CORRection:ENR:CALibration:MODE.....	123
[SENSe:]CORRection:ENR:CALibration:SPOT.....	123
[SENSe:]CORRection:ENR:CALibration:TABLE:SElect.....	123
[SENSe:]CORRection:ENR:CALibration:TYPE.....	124
[SENSe:]CORRection:ENR:COMMon.....	124
[SENSe:]CORRection:ENR[:MEASurement]:TABLE:DATA.....	124
[SENSe:]CORRection:ENR[:MEASurement]:TABLE:DELeTe	125
[SENSe:]CORRection:ENR[:MEASurement]:TABLE:LIST?.....	125
[SENSe:]CORRection:ENR[:MEASurement]:TABLE:SElect.....	126
[SENSe:]CORRection:ENR[:MEASurement]:TABLE:TEMPerature[:DATA].....	126
[SENSe:]CORRection:ENR[:MEASurement]:TABLE:TEMPerature:DELeTe.....	127
[SENSe:]CORRection:ENR[:MEASurement]:TABLE:TEMPerature:LIST?.....	127
[SENSe:]CORRection:ENR[:MEASurement]:MODE.....	127
[SENSe:]CORRection:ENR[:MEASurement]:SPOT.....	127
[SENSe:]CORRection:ENR[:MEASurement]:TYPE.....	128
[SENSe:]CORRection:ENR[:MEASurement]:SPOT:COLD.....	128
[SENSe:]CORRection:ENR[:MEASurement]:SPOT:HOT.....	129
[SENSe:]CORRection:TEMPerature.....	129

[SENSe:]CORRection:ENR:CALibration:SPOT:COLD <Temperature>

This command defines a constant temperature of a resistor not supplied with power (T_{cold}) used during calibration.

The command is available when you have selected a noise source with resistor characteristics with [SENSe:]CORRection:ENR:CALibration:TYPE.

Parameters:

<Temperature> Temperature in degrees Kelvin.
 *RST: 77 K

Example:

```
CORR:ENR:CAL:TYPE RES
CORR:ENR:CAL:SPOT:COLD 100
Defines a cold temperature of 100 K.
```

Manual operation: See "Calibration" on page 51

[SENSe:]CORRection:ENR:CALibration:SPOT:HOT <Temperature>

This command defines a constant temperature of a resistor supplied with power (T_{hot}) used during calibration.

The command is available when you have selected a noise source with resistor characteristics with [SENSe:]CORRection:ENR:CALibration:TYPE.

Parameters:

<Temperature> Temperature in degrees Kelvin.
 *RST: 77 K

Example: CORR:ENR:TYPE RES
 CORR:ENR:CAL:SPOT:HOT 300
 Defines a cold temperature of 300 K.

Manual operation: See "[Calibration](#)" on page 51

[SENSe:]CORRection:ENR:CALibration:MODE <Mode>

This command selects the ENR mode for the calibration.

This command is available when you use different noise sources for calibration and measurement ([\[SENSe:\]CORRection:ENR:COMMOn OFF](#)).

Parameters:

<Mode> **SPOT**
 Uses a constant ENR value for all measurement points (see [\[SENSe:\]CORRection:ENR:CALibration:SPOT](#)).

TABLE
 Uses the contents of the ENR table.

*RST: SPOT

Example: CORR:ENR:CAL:MODE SPOT
 Uses a constant ENR value for all measurement points.

Manual operation: See "[Calibration](#)" on page 51

[SENSe:]CORRection:ENR:CALibration:SPOT <ENR>

This command defines the constant ENR for all measurement points during calibration.

This command is available when you use different noise sources for calibration and measurement ([\[SENSe:\]CORRection:ENR:COMMOn OFF](#)).

Parameters:

<ENR> Range: -999.99 to 999.99
 *RST: 15
 Default unit: dB

Example: CORR:ENR:CAL:MODE SPOT
 CORR:ENR:CAL:SPOT 30
 Selects constant ENR value mode and defines an ENR of 30 dB for all measurement points.

Manual operation: See "[Calibration](#)" on page 51

[SENSe:]CORRection:ENR:CALibration:TABLE:SElect <TableName>

This command selects an ENR or temperature table for calibration.

Note that the contents of the table are independent of whether you use it for calibration or the actual measurement. When you want to edit a table, regardless if you want to use it later for a measurement or for calibration, you have to use `[SENSe:]CORRection:ENR[:MEASurement]:TABLE:SElect`. This command only selects a table for calibration.

This command is available when you use different noise sources for calibration and measurement (`[SENSe:]CORRection:ENR:COMMOn OFF`).

Parameters:

<TableName> String containing the table name.

Example:

```
CORR:ENR:MEAS:TABL:SEL 'ENRTable'
```

Selects a table called 'ENRTable'.

Manual operation: See "Calibration" on page 51
See "New" on page 52
See "Edit" on page 53

[SENSe:]CORRection:ENR:CALibration:TYPE <Type>

This command selects the type of noise source you are using for the calibration.

Parameters:

<Type>

DIODE

Selects a noise source with diode characteristics.

RESistor

Selects a noise source with resistor characteristics. When you select this noise source type, the application automatically selects the manual measurement mode (see `[SENSe:]CONFigure:CONTRol`).

```
*RST: DIODE
```

Example:

```
CORR:ENR:CAL:TYPE RES
```

Selects a noise source with resistor characteristics.

[SENSe:]CORRection:ENR:COMMOn <State>

This command turns the use of a common ENR on or off.

For more information see "Common Noise Source" on page 50.

Parameters:

<State> ON | OFF

Example:

```
CORR:ENR:COMM ON
```

Turns the use of a common ENR on.

Manual operation: See "Common Noise Source" on page 50

[SENSe:]CORRection:ENR[:MEASurement]:TABLE:DATA <Frequency>, <ENR>

This command defines the contents of the currently selected ENR table.

The ENR table should contain an ENR for all measurement points.

If you create a new table with this command, it will overwrite the current entries of the frequency list.

To select the ENR table you want to edit, use `[SENSe:]CORRection:ENR[:MEASurement]:TABLE:SElect`.

Parameters:

<Frequency>, <ENR> Each entry of the ENR table consists of one measurement point and the corresponding ENR.

The table can contain up to 500 entries.

<Frequency>

Frequency of the measurement point.

The range is from 0 Hz to 999.99 GHz.

<ENR>

ENR of the measurement point.

The range is from -999.99 dB to 999.99 dB.

Example:

```
CORR:ENR:MEAS:TABL:DATA 1MHZ,10,2MHZ,12
```

Defines a new ENR table with two measurement points.

Manual operation:

See "New" on page 52

See "Edit" on page 53

See "Edit Table" on page 53

`[SENSe:]CORRection:ENR[:MEASurement]:TABLE:DELeTe <TableName>`

This command deletes an ENR table.

Parameters:

<TableName> String containing the name of the table.

Example:

```
CORR:ENR:MEAS:TABL:DEL 'ENRTable'
```

Deletes the table with the name 'ENRTable'.

Usage:

Event

Manual operation:

See "Delete" on page 53

`[SENSe:]CORRection:ENR[:MEASurement]:TABLE:LIST?`

This command queries all ENR tables available in the application.

Return values:

<Tables> String containing the names of the tables as a comma separated list.

Example:

```
CORR:ENR:TABL:LIST
```

would return, e.g.

```
'Table1,Table2,Table3'
```

Usage:

Query only

[SENSe:]CORRection:ENR[:MEASurement]:TABLe:SElect <TableName>

This command selects an ENR or temperature table for the actual measurement.

When you want to edit a table, regardless if you want to use it later for a measurement or for calibration, you have to use this command. `[SENSe:]CORRection:ENR:CALibration:TABLe:SElect` only selects a table for calibration.

Parameters:

<TableName> String containing the table name.

Example:

```
CORR:ENR:MEAS:TABL:SEL 'ENRTable'
```

Selects a table called 'ENRTable'.

Manual operation:

See "Measurement" on page 50

See "New" on page 52

See "Edit" on page 53

**[SENSe:]CORRection:ENR[:MEASurement]:TABLe:TEMPerature[:DATA]
<Frequency>, <Thot>, <Tcold>**

This command defines the contents of the currently selected temperature table.

The temperature table should contain an two temperature values for all measurement points.

If you create a new table with this command, it will overwrite the current entries of the frequency list.

To select the temperature table you want to edit, use `[SENSe:]CORRection:ENR[:MEASurement]:TABLe:SElect`.

Parameters:

<Frequency>, <Thot>, <Tcold> Each entry of the temperature table consists of one measurement point and the corresponding temperature values.

The table can contain up to 500 entries.

<Frequency>

Frequency of the measurement point.

The range is from 0 Hz to 999.99 GHz.

<Thot>

Temperature of the noise source when it is off for the corresponding measurement point.

The range is from 0 K to 100000 K.

<Tcold>

Temperature of the noise source when it is on for the corresponding measurement point.

The range is from 0 K to 100000 K.

Example:

```
CORR:ENR:MEAS:TABL:TEMPDATA 1MHZ,10,100,2MHZ,12,150
```

Defines a new temperature table with two measurement points.

Manual operation: See "New" on page 52
 See "Edit" on page 53
 See "Edit Table" on page 53

[SENSe:]CORRection:ENR[:MEASurement]:TABLE:TEMPerature:DELeTe
 <TableName>

This command deletes a temperature table.

Parameters:

<TableName> String containing the name of the table.

Example:

`CORR:ENR:MEAS:TABL:TEMP:DEL 'TemperatureTable'`
 Deletes the table with the name 'TemperatureTable'.

Manual operation: See "Delete" on page 53

[SENSe:]CORRection:ENR[:MEASurement]:TABLE:TEMPerature:LIST?

This command queries all temperature tables available in the application.

Return values:

<Tables> String containing the names of the tables as a comma separated list.

Example:

`CORR:ENR:TABL:TEMP:LIST`
 would return, e.g.
 'Table1,Table2,Table3'

Usage: Query only

[SENSe:]CORRection:ENR[:MEASurement]:MODE <Mode>

This command selects the ENR mode for the actual measurement.

Parameters:

<Mode> **SPOT**
 Uses a constant ENR value for all measurement points (see
[\[SENSe:\]CORRection:ENR\[:MEASurement\]:SPOT](#)).

TABLE

Uses the contents of the ENR table.

*RST: SPOT

Example:

`CORR:ENR:MODE SPOT`
 Uses a constant ENR value for all measurement points.

Manual operation: See "Measurement" on page 50

[SENSe:]CORRection:ENR[:MEASurement]:SPOT <ENR>

This command defines the constant ENR for all measurement points during the actual measurement.

Parameters:

<ENR> Range: -999.99 to 999.99
 *RST: 15
 Default unit: dB

Example:

```
CORR:ENR:MODE SPOT
CORR:ENR:SPOT 30
```

Selects constant ENR value mode and defines an ENR of 30 dB for all measurement points.

Manual operation: See "[Measurement](#)" on page 50

[SENSe:]CORRection:ENR[:MEASurement]:TYPE <Type>

This command selects the type of noise source you are using for the measurement.

Parameters:

<Type>

DIODE
 Selects a noise source with diode characteristics.

RESistor
 Selects a noise source with resistor characteristics.
 When you select this noise source type, the application automatically selects the manual measurement mode (see [\[SENSe:\]CONFigure:CONTRol](#)).

*RST: DIODE

Example:

```
CORR:ENR:TYPE RES
```

Selects a noise source with resistor characteristics.

Manual operation: See "[Noise Source](#)" on page 52

[SENSe:]CORRection:ENR[:MEASurement]:SPOT:COLD <Temperature>

This command defines a constant temperature of a resistor not supplied with power (T_{cold}) used during measurements.

The command is available when you have selected a noise source with resistor characteristics with [\[SENSe:\]CORRection:ENR\[:MEASurement\]:TYPE](#).

Parameters:

<Temperature> Temperature in degrees Kelvin.
 *RST: 77 K

Example:

```
CORR:ENR:TYPE RES
CORR:ENR:SPOT:COLD 100
```

Defines a cold temperature of 100 K.

Manual operation: See "[Measurement](#)" on page 50

[SENSe:]CORRection:ENR[:MEASurement]:SPOT:HOT <Temperature>

This command defines a constant temperature of a resistor supplied with power (T_{hot}) used during measurements.

The command is available when you have selected a noise source with resistor characteristics with `[SENSe:]CORRection:ENR[:MEASurement]:TYPE`.

Parameters:

<Temperature> Temperature in degrees Kelvin.
*RST: 77 K

Example:

```
CORR:ENR:TYPE RES
CORR:ENR:SPOT:HOT 300
Defines a cold temperature of 300 K.
```

Manual operation: See "[Measurement](#)" on page 50

[SENSe:]CORRection:TEMPerature <Temperature>

This command defines the room temperature of the measurement environment. The temperature is taken into account when calculating noise results.

Parameters:

<Temperature> Range: 278.15 to 318.15
*RST: 293
Default unit: K

Example:

```
CORR:TEMP 291.50
Specifies a room temperature of 291.50 Kelvin (18.5 C).
```

Manual operation: See "[Temperature](#)" on page 51

7.10 Configuring Additional Loss

The following commands are necessary to define loss resulting from equipment in the measurement setup.

[SENSe:]CORRection:LOSS:INPut:MODE	130
[SENSe:]CORRection:LOSS:INPut:SPOT	130
[SENSe:]CORRection:LOSS:INPut:TABLE	130
[SENSe:]CORRection:LOSS:INPut:TABLE:DELeTe	131
[SENSe:]CORRection:LOSS:INPut:TABLE:SELeCt	131
[SENSe:]CORRection:LOSS:OUTPut:MODE	131
[SENSe:]CORRection:LOSS:OUTPut:SPOT	131
[SENSe:]CORRection:LOSS:OUTPut:TABLE	132
[SENSe:]CORRection:LOSS:OUTPut:TABLE:DELeTe	132
[SENSe:]CORRection:LOSS:OUTPut:TABLE:SELeCt	133

[SENSe:]CORRection:LOSS:INPut:MODE <Mode>

This command selects the input loss mode.

Parameters:

<Mode>

SPOT

Uses a constant input loss value for all measurement points (see [SENSe:]CORRection:LOSS:INPut:SPOT on page 130).

TABLE

Uses the contents of the input loss table.

*RST: SPOT

Example:

CORR:LOSS:INP:MODE SPOT

Selects constant input loss.

Manual operation: See "Input Loss" on page 55

[SENSe:]CORRection:LOSS:INPut:SPOT <Loss>

This command defines a constant input loss for all measurement points.

Parameters:

<Loss>

Range: -999.99 to 999.99

*RST: 0 dB

Default unit: dB

Example:

CORR:LOSS:INP:MODE SPOT

CORR:LOSS:INP:SPOT 10

Selects constant input loss mode and defines an input loss of 10 dB for all measurement points.

Manual operation: See "Input Loss" on page 55

[SENSe:]CORRection:LOSS:INPut:TABLE <Frequency>, <Loss>

This command defines the contents of the currently selected input loss table.

The table should contain an input loss for all measurement points.

If you create a new table with this command, it will overwrite the current entries of the loss table.

Parameters:

<Frequency>, <ENR> Each entry of the loss table consists of one measurement point and the corresponding loss.

The table can contain up to 500 entries.

<Frequency>

Frequency of the measurement point.

The range is from 0 Hz to 999.99 GHz.

<Loss>

Loss of the measurement point.

The range is from -999.99 dB to 999.99 dB.

Example: `CORR:LOSS:INP:TABL 1MHz,10,2MHz,12`
Defines a new input loss table with two measurement points.

Manual operation: See ["Edit Table"](#) on page 53
See ["New"](#) on page 56
See ["Edit"](#) on page 57

[SENSe:]CORRection:LOSS:INPut:TABLE:DELeTe <TableName>

This command deletes an input loss table.

Parameters:

<TableName> String containing the name of the table.

Example: `CORR:LOSS:INP:TABL:DEL 'InputLoss'`
Deletes the table with the name 'InputLoss'.

Manual operation: See ["Delete"](#) on page 57

[SENSe:]CORRection:LOSS:INPut:TABLE:SELeCt <TableName>

This command selects an input loss table.

Parameters:

<TableName> String containing the table name.

Example: `CORR:LOSS:INP:TABL:SEL 'InputLoss'`
Selects a table called 'InputLoss'.

Manual operation: See ["Input Loss"](#) on page 55

[SENSe:]CORRection:LOSS:OUTPut:MODE <Mode>

This command selects the output loss mode.

Parameters:

<Mode> **SPOT**
Uses a constant output loss value for all measurement points (see [\[SENSe:\]CORRection:LOSS:OUTPut:SPOT](#) on page 131).

TABLE
Uses the contents of the output loss table.

*RST: SPOT

Example: `CORR:LOSS:OUTP:MODE SPOT`
Selects constant output loss.

Manual operation: See ["Output Loss"](#) on page 55

[SENSe:]CORRection:LOSS:OUTPut:SPOT <Loss>

This command defines a constant output loss for all measurement points.

Parameters:

<Loss> Range: -999.99 to 999.99
 *RST: 0 dB
 Default unit: dB

Example:

```
CORR:LOSS:OUTP:MODE SPOT
CORR:LOSS:OUTP:SPOT 10
```

Selects constant output loss mode and defines an output loss of 10 dB for all measurement points.

Manual operation: See ["Output Loss"](#) on page 55

[SENSe:]CORRection:LOSS:OUTPut:TABLE <Frequency>, <Loss>

This command defines the contents of the currently selected output loss table.

The table should contain an output loss for all measurement points.

If you create a new table with this command, it will overwrite the current entries of the frequency list.

Parameters:

<Frequency>, <ENR> Each entry of the loss table consists of one measurement point and the corresponding loss.
 The table can contain up to 500 entries.

<Frequency>

Frequency of the measurement point.
 The range is from 0 Hz to 999.99 GHz.

<Loss>

Loss of the measurement point.
 The range is from -999.99 dB to 999.99 dB.

Example:

```
CORR:LOSS:OUTP:TABL 1MHz,10,2MHz,12
```

Defines a new output loss table with two measurement points.

Manual operation: See ["Edit Table"](#) on page 53
 See ["New"](#) on page 56
 See ["Edit"](#) on page 57

[SENSe:]CORRection:LOSS:OUTPut:TABLE:DELeTe <TableName>

This command deletes an output loss table.

Parameters:

<TableName> String containing the name of the table.

Example:

```
CORR:LOSS:OUTP:TABL:DEL 'OutputLoss'
```

Deletes the table with the name 'OutputLoss'.

Manual operation: See ["Delete"](#) on page 57

[SENSe:]CORRection:LOSS:OUTPut:TABLE:SElect <TableName>

This command selects an output loss table.

Parameters:

<TableName> String containing the table name.

Example: CORR:LOSS:OUTP:TABL:SEL 'OutputLoss'
Selects a table called 'OutputLoss'.

Manual operation: See "Output Loss" on page 55

7.11 Configuring the Analyzer

The following commands are necessary to configure the analyzer.

[SENSe:]CONFigure:CORRection.....	133
DISPlay[:WINDow<n>]:TRACe<t>:Y[:SCALe]:RLEVel.....	133
DISPlay[:WINDow<n>]:TRACe<t>:Y[:SCALe]:RLEVel:AUTO.....	134
INPut:ATTenuation.....	134
INPut:GAIN[:VALue].....	134
INPut:GAIN:STATe.....	135
[SENSe:]BANDwidth[:RESolution].....	135
[SENSe:]CORRection[:STATe].....	135
[SENSe:]SWEep:COUNT.....	136
[SENSe:]SWEep:TIME.....	136
SYSTem:CONFigure:DUT:GAIN.....	136
SYSTem:CONFigure:DUT:STIME.....	137

[SENSe:]CONFigure:CORRection

This command configures the software to perform a calibration measurement.

If you initiate a measurement with `INITiate<n>[:IMMEDIATE]`, the software initiates a calibration instead of the actual measurement.

Example: CONF:CORR
Configures to run calibration.
INIT
Initiates the calibration.

Usage: Event

Manual operation: See "2nd Stage Correction" on page 58
See "Calibrate" on page 67

DISPlay[:WINDow<n>]:TRACe<t>:Y[:SCALe]:RLEVel <ReferenceLevel>

This command defines the reference level (for all traces in all windows).

Suffix:

<n>, <t> irrelevant

Parameters:

<ReferenceLevel> Range: see datasheet
 *RST: -30 dBm
 Default unit: dBm

Example:

DISP:TRAC:Y:RLEV -60dBm

Usage:

SCPI confirmed

Manual operation: See "[Ref Level](#)" on page 59

DISPlay[:WINDow<n>]:TRACe<t>:Y[:SCALe]:RLEV:AUtO <State>

This command turns automatic determination of the reference level on and off.

Suffix:

<n>, <t> irrelevant

Parameters:

<State> ON | OFF

Example:

DISP:TRAC:Y:RLEV:AUTO ON
 Turns on automatic level detection.

Usage:

SCPI confirmed

Manual operation: See "[Ref Level](#)" on page 59

INPut:ATTenuation <Attenuation>

This command defines the total attenuation for RF input.

If you set the attenuation manually, it is no longer coupled to the reference level, but the reference level is coupled to the attenuation. Thus, if the current reference level is not compatible with an attenuation that has been set manually, the command also adjusts the reference level.

Parameters:

<Attenuation> Range: see data sheet
 Increment: 5 dB
 *RST: 10 dB (AUTO is set to ON)

Example:

INP:ATT 30dB
 Defines a 30 dB attenuation and decouples the attenuation from the reference level.

Usage:

SCPI confirmed

Manual operation: See "[RF Attenuation](#)" on page 60

INPut:GAIN[:VALue] <Gain>

This command selects the gain if the preamplifier is activated (INP:GAIN:STAT ON, see [INPut:GAIN:STATe](#) on page 135).

The command requires the additional preamplifier hardware option.

Parameters:

<Gain> 15 dB | 30 dB

The availability of gain levels depends on the model of the R&S FSW.

R&S FSW8/13: 15dB and 30 dB
 R&S FSW26 or higher: 30 dB
 All other values are rounded to the nearest of these two.

*RST: OFF

Example:

```
INP:GAIN:STAT ON
INP:GAIN:VAL 30
```

Switches on 30 dB preamplification.

Usage: SCPI confirmed

INPut:GAIN:STATe <State>

This command turns the preamplifier on and off. It requires the optional preamplifier hardware.

For R&S FSW 26 or higher models, the input signal is amplified by 30 dB if the preamplifier is activated.

For R&S FSW 8 or 13 models, the preamplification is defined by `INPut:GAIN[:VALue]`.

Parameters:

<State> ON | OFF

*RST: OFF

Example:

```
INP:GAIN:STAT ON
```

Switches on 30 dB preamplification.

Usage: SCPI confirmed

Manual operation: See "[Preamplifier](#)" on page 60

[SENSe:]BANDwidth[:RESolution] <Bandwidth>

This command defines the resolution bandwidth and decouples the resolution bandwidth from the span.

Example:

```
BAND 1 MHz
```

Sets the resolution bandwidth to 1 MHz

Usage: SCPI confirmed

Manual operation: See "[Resolution Bandwidth \(RBW\)](#)" on page 58

[SENSe:]CORRection[:STATe] <State>

This command includes or excludes calibration data in the actual measurement.

Parameters:

<State> ON | OFF
 *RST: OFF

Example:

CORR ON
 Includes calibration data in the measurement.

[SENSe:]SWEep:COUNT <Averages>

This command defines the number of measurements that are used to average the results.

Parameters:

<Averages> Number of measurements that are performed at a single frequency before average results are displayed.
 If you set an average of 0 or 1, the application performs a single measurement at each frequency.
 Range: 0 to 32767
 *RST: 1

Example:

SWE:COUN 10
 The application averages 10 measurements before it displays the results.

Manual operation: See "[Average](#)" on page 58

[SENSe:]SWEep:TIME <Time>

This command defines the sweep time.

Parameters:

<Time> refer to data sheet
 *RST: depends on current settings (determined automatically)

Example:

SWE:TIME 10s

Usage:

SCPI confirmed

Manual operation: See "[Sweep Time](#)" on page 58

SYSTem:CONFigure:DUT:GAIN <Gain>

This command defines the expected gain of the DUT.

The application uses the gain for automatic reference level detection.

Parameters:

<Gain> Range: 10 to 1000
 *RST: 30
 Default unit: dB

Example: `SYST:CONF:DUT:GAIN 25`
 Defines gain of 25 dB.

Manual operation: See "Auto Level Range" on page 60

SYSTem:CONFigure:DUT:STIme <SettlingTime>

This command defines the settling time of the noise source.

Parameters:

<SettlingTime> Range: 0 s to 20 s
 *RST: 50 ms

Example: `SYST:CONF:DUT:STIM 1 s`
 Defines a settling time of 1 second.

Manual operation: See "Settling Time" on page 58

7.12 Using the Uncertainty Calculator

The following commands are necessary to work with the measurement uncertainty calculator.

<code>CALCulate:UNCertainty:COMMon</code>	138
<code>CALCulate:UNCertainty:DATA:FREQUency</code>	138
<code>CALCulate:UNCertainty:DATA:GAIN</code>	138
<code>CALCulate:UNCertainty:DATA:NOISe</code>	138
<code>CALCulate:UNCertainty:DATA:RESuLts</code>	139
<code>CALCulate:UNCertainty:ENR:CALibration:UNCertainty</code>	139
<code>CALCulate:UNCertainty:ENR:CALibration:UNCertainty:COLD</code>	139
<code>CALCulate:UNCertainty:ENR:CALibration:UNCertainty:HOT</code>	140
<code>CALCulate:UNCertainty:ENR:UNCertainty</code>	140
<code>CALCulate:UNCertainty:ENR:UNCertainty:COLD</code>	140
<code>CALCulate:UNCertainty:ENR:UNCertainty:HOT</code>	141
<code>CALCulate:UNCertainty:MATCH:DUT:IN:RL</code>	141
<code>CALCulate:UNCertainty:MATCH:DUT:IN:[VSWR]</code>	141
<code>CALCulate:UNCertainty:MATCH:DUT:OUT:RL</code>	142
<code>CALCulate:UNCertainty:MATCH:DUT:OUT:[VSWR]</code>	142
<code>CALCulate:UNCertainty:MATCH:PREamp:RL</code>	142
<code>CALCulate:UNCertainty:MATCH:PREamp:[VSWR]</code>	142
<code>CALCulate:UNCertainty:MATCH:SOURce:CALibration:[VSWR]</code>	142
<code>CALCulate:UNCertainty:MATCH:SOURce:CALibration:RL</code>	143
<code>CALCulate:UNCertainty:MATCH:SOURce:RL</code>	143
<code>CALCulate:UNCertainty:MATCH:SOURcef:[VSWR]</code>	143
<code>CALCulate:UNCertainty:PREamp:GAIN</code>	144
<code>CALCulate:UNCertainty:PREamp:NOISe</code>	144
<code>CALCulate:UNCertainty:PREamp:STATe</code>	144
<code>CALCulate:UNCertainty[:RESuLt]?</code>	144
<code>CALCulate:UNCertainty:SANalyzer:GAIN:UNCertainty?</code>	145
<code>CALCulate:UNCertainty:SANalyzer:NOISe:UNCertainty?</code>	145

CALCulate:UNCertainty:COMMOn <State>

This command turns matching of the noise source characteristics used during calibration and measurement on and off.

This command is available when you use different noise sources for calibration and measurement ([\[SENSe:\]CORRection:ENR:COMMOn OFF](#)).

Parameters:

<State> ON | OFF
*RST: unavailable

Example:

`CALC:UNC:COMM ON`
Applies the values of the calibration noise source to those of the measurement noise source.

Manual operation: See ["Common Source for Meas and Cal"](#) on page 62

CALCulate:UNCertainty:DATA:FREQuency <Frequency>

This command defines the frequency for which the uncertainty should be calculated.

This command is available if you have turned automatic determination of the DUT characteristics off with [CALCulate:UNCertainty:DATA:RESults](#).

Parameters:

<Frequency> Frequency of the DUT.
*RST: 1 GHz

Example:

`CALC:UNC:DATA:FREQ 100MHZ`
Defines a frequency of 100 MHz.

Manual operation: See ["Use Measurement Values"](#) on page 64

CALCulate:UNCertainty:DATA:GAIN <Gain>

This command defines the gain of the DUT.

This command is available if you have turned automatic determination of the DUT characteristics off with [CALCulate:UNCertainty:DATA:RESults](#).

Parameters:

<Gain> Gain of the DUT.
*RST: 0 dB

Example:

`CALC:UNC:DATA:GAIN -5DB`
Defines a DUT gain of -5 dB.

Manual operation: See ["Use Measurement Values"](#) on page 64

CALCulate:UNCertainty:DATA:NOISe <NoiseLevel>

This command defines the noise level of the DUT.

This command is available if you have turned automatic determination of the DUT characteristics off with `CALCulate:UNCertainty:DATA:RESults`.

Parameters:

<NoiseLevel> Noise level of the DUT.
*RST: 0 dB

Example:

`CALC:UNC:DATA:NOIS 10DB`
Defines a DUT noise level of 10 dB.

Manual operation: See "Use Measurement Values" on page 64

CALCulate:UNCertainty:DATA:RESults <State>

This command turns automatic determination of the DUT characteristics for the calculation of the uncertainty on and off.

Parameters:

<State> **ON**
The application calculates the uncertainty with the DUT characteristics (noise figure, gain and frequency) resulting from the noise figure measurement.

OFF

The application calculates the uncertainty with the DUT characteristics (noise figure, gain and frequency) based on the values you have defined manually.

Example:

`CALC:UNC:DATA:RES ON`
Includes the uncertainty in the results displays.

Manual operation: See "Use Measurement Values" on page 64

CALCulate:UNCertainty:ENR:CALibration:UNCertainty <Uncertainty>

This command defines the uncertainty of a calibration noise source.

This command is available when `[SENSe:]CORRection:ENR:COMMon` and `CALCulate:UNCertainty:COMMon` are off.

Parameters:

<Uncertainty> Uncertainty value of the noise source.
Refer to the data sheet of the noise source to determine its uncertainty.
*RST: 0.1 dB

Example:

`CALC:UNC:ENR:CAL:UNC 0.05`
Defines an uncertainty of 0.05 dB.

Manual operation: See "ENR Uncert(ainty)" on page 63

CALCulate:UNCertainty:ENR:CALibration:UNCertainty:COLD <Uncertainty>

This command defines the uncertainty of a calibration noise source.

This command is available when `[SENSe:]CORRection:ENR:COMMon` and `CALCulate:UNCertainty:COMMon` are off.

Parameters:

`<Uncertainty>` Cold temperature uncertainty value of the noise source. Refer to the data sheet of the noise source to determine its uncertainty.
*RST: 0 K

Example: `CALC:UNC:ENR:CAL:UNC:COLD 5 K`
Defines a low temperature uncertainty of 5 K.

Manual operation: See "[Temperature Uncert\(ainty\)](#)" on page 63

CALCulate:UNCertainty:ENR:CALibration:UNCertainty:HOT `<Uncertainty>`

This command defines the uncertainty of a calibration noise source.

This command is available when `[SENSe:]CORRection:ENR:COMMon` and `CALCulate:UNCertainty:COMMon` are off.

Parameters:

`<Uncertainty>` Hot temperature uncertainty value of the noise source. Refer to the data sheet of the noise source to determine its uncertainty.
*RST: 0 K

Example: `CALC:UNC:ENR:CAL:UNC:COLD 5 K`
Defines a high temperature uncertainty of 5 K.

Manual operation: See "[Temperature Uncert\(ainty\)](#)" on page 63

CALCulate:UNCertainty:ENR:UNCertainty `<Uncertainty>`

This command defines the uncertainty of a noise source.

If the noise sources during calibration and measurement are different, the command defines the uncertainty of the measurement noise source.

Parameters:

`<Uncertainty>` Uncertainty value of the noise source. Refer to the data sheet of the noise source to determine its uncertainty.
*RST: 0.1 dB

Example: `CALC:UNC:ENR:UNC 0.05`
Defines an uncertainty of 0.05 dB.

Manual operation: See "[ENR Uncert\(ainty\)](#)" on page 63

CALCulate:UNCertainty:ENR:UNCertainty:COLD `<Uncertainty>`

This command defines the uncertainty of a resistor.

If the noise sources during calibration and measurement are different, the command defines the uncertainty of the measurement noise source.

Parameters:

<Uncertainty> Cold temperature uncertainty value of the noise source.
Refer to the data sheet of the noise source to determine its uncertainty.
*RST: 0 K

Example:

CALC:UNC:ENR:UNC:COLD 10
Defines an low temperature uncertainty of 10 K.

Manual operation: See "[Temperature Uncert\(ainty\)](#)" on page 63

CALCulate:UNCertainty:ENR:UNCertainty:HOT <Uncertainty>

This command defines the uncertainty of a resistor.

If the noise sources during calibration and measurement are different, the command defines the uncertainty of the measurement noise source.

Parameters:

<Uncertainty> Hot temperature uncertainty value of the noise source.
Refer to the data sheet of the noise source to determine its uncertainty.
*RST: 0 K

Example:

CALC:UNC:ENR:UNC:HOT 10
Defines an high temperature uncertainty of 10 K.

Manual operation: See "[Temperature Uncert\(ainty\)](#)" on page 63

CALCulate:UNCertainty:MATCh:DUT:IN:RL <ReturnLoss>

This command defines the return loss at the DUT input.

Parameters:

<ReturnLoss> *RST: 50.0 dB

Example:

CALC:UNC:MATC:DUT:IN:RL 25DB
Defines a return loss of 25 dB.

Manual operation: See "[Input / Output Match](#)" on page 63

CALCulate:UNCertainty:MATCh:DUT:IN:[VSWR] <VSWR>

This command defines the VSWR at the DUT input.

Parameters:

<VSWR> *RST: 1.0

Example:

CALC:UNC:MATC:DUT:IN 1.1
Defines a VSWR of 1.1 at the DUT input.

Manual operation: See ["Input / Output Match"](#) on page 63

CALCulate:UNCertainty:MATCh:DUT:OUT:RL <ReturnLoss>

This command defines the returns loss at the DUT output.

Parameters:

<ReturnLoss> *RST: 50.0 dB

Example:

CALC:UNC:MATC:DUT:OUT:RL 40DB
 Defines a return loss of 40 dB at the DUT output.

Manual operation: See ["Input / Output Match"](#) on page 63

CALCulate:UNCertainty:MATCh:DUT:OUT:[VSWR] <VSWR>

This command defines the VSWR at the DUT output.

Parameters:

<VSWR> *RST: 1.0

Example:

CALC:UNC:MATC:DUT:OUT 2.0
 Defines a VSWR of 2.0 at the DUT output.

Manual operation: See ["Input / Output Match"](#) on page 63

CALCulate:UNCertainty:MATCh:PREamp:RL <ReturnLoss>

This command defines the return loss at the input of the preamplifier.

Parameters:

<ReturnLoss> *RST: 13.98 dB

Example:

CALC:UNC:MATC:PRE:RL 14.5DB
 Defines a return loss of 14.5 dB.

CALCulate:UNCertainty:MATCh:PREamp:[VSWR] <VSWR>

This command defines the VSWR at the input of the preamplifier.

The command is available if you have turned on the preamplifier with [CALCulate:UNCertainty:PREamp:STATe](#) on page 144.

Parameters:

<VSWR> *RST: 1.5

Example:

CALC:UNC:MATC:PRE 1.8
 Defines a VSWR of 1.8.

CALCulate:UNCertainty:MATCh:SOURce:CALibration[:VSWR] <VSWR>

This command defines the VSWR at the calibration noise source output.

This command is available when `[SENSe:]CORRection:ENR:COMMon` and `CALCulate:UNCertainty:COMMon` are off.

Parameters:

<VSWR> *RST: 1.15

Example:

`CALC:UNC:MATC:SOUR:CAL 1.4`
Defines a VSWR of 1.4.

Manual operation: See "Output Match" on page 63

CALCulate:UNCertainty:MATCh:SOURce:CALibration:RL <ReturnLoss>

This command defines the return loss at the calibration noise source output.

This command is available when `[SENSe:]CORRection:ENR:COMMon` and `CALCulate:UNCertainty:COMMon` are off.

Parameters:

<ReturnLoss> *RST: 23.13 dB

Example:

`CALC:UNC:MATC:SOUR:CAL:RL 20DB`
Defines a return loss of 20 dB.

Manual operation: See "Output Match" on page 63

CALCulate:UNCertainty:MATCh:SOURce:RL <ReturnLoss>

This command defines the return loss at the noise source output.

If the noise sources during calibration and measurement are different, the command defines the uncertainty of the measurement noise source.

Parameters:

<ReturnLoss> *RST: 23.13 dB

Example:

`CALC:UNC:MATC:SOUR:RL 20DB`
Defines a return loss of 20 dB.

Manual operation: See "Output Match" on page 63

CALCulate:UNCertainty:MATCh:SOURce[:VSWR] <VSWR>

This command defines the VSWR at the noise source output.

If the noise sources during calibration and measurement are different, the command defines the uncertainty of the measurement noise source.

Parameters:

<VSWR> *RST: 1.15

Example:

`CALC:UNC:MATC:SOUR 1.4`
Defines a VSWR of 1.4.

Manual operation: See "Output Match" on page 63

CALCulate:UNCertainty:PREamp:GAIN <Gain>

This command define the gain of an external preamplifier that may be part of the test setup.

Parameters:

<Gain>

Gain of the preamplifier.

Refer to the data sheet of the preamplifier to determine its gain.

*RST: 20 dB

Example:

CALC:UNC:PRE:GAIN 15DB

Defines a gain of 15 dB.

CALCulate:UNCertainty:PREamp:NOISe <NoiseLevel>

This command defines the noise level of an external preamplifier that may be part of the test setup.

Parameters:

<NoiseLevel>

Noise level of the preamplifier.

Refer to the data sheet of the preamplifier to determine its noise level.

*RST: 5 dB

Example:

CALC:UNC:PRE:NOIS 10DB

Defines a noise level of 10 dB.

CALCulate:UNCertainty:PREamp:STATe <State>

This command includes or excludes an external preamplifier from the uncertainty calculation.

If the test setup uses an external preamplifier, you also have to define its noise figure and gain values.

Parameters:

<State>

ON | OFF

*RST: OFF

Example:

CALC:UNC:PRE:STAT ON

Turns the preamplifier on.

CALCulate:UNCertainty[:RESult]?

This command queries the uncertainty of noise figure results.

Return values:

<Uncertainty>

Measurement uncertainty in dB.

Example:

CALC:UNC?

Queries the uncertainty.

Usage:

Query only

CALCulate:UNCertainty:SANalyzer:GAIN:UNCertainty?

This command queries the uncertainty value of the spectrum analyzer's internal gain.

Return values:

<Uncertainty> Gain uncertainty of the spectrum analyzer in dB.

Example:

CALC:UNC:SAN:GAIN:UNC?
Queries the gain uncertainty.

Usage:

Query only

CALCulate:UNCertainty:SANalyzer:NOISe:UNCertainty?

This command queries the uncertainty value of the spectrum analyzer's internal noise.

Return values:

<Uncertainty> Noise figure uncertainty of the spectrum analyzer in dB.

Example:

CALC:UNC:SAN:NOIS:UNC?
Queries the noise figure uncertainty.

Usage:

Query only

7.13 Performing Measurements

The following commands are necessary to perform noise figure measurements.

Example: perform calibration and subsequent single sweep measurement

```
//Perform calibration:
CONF:CORR
INIT;*OPC?
//Perform single sweep measurement and use 2nd stage correction:
CORR:STAT ON
CONF:LIST:SING
INIT
```



You can also perform a sequence of measurements using the Sequencer (see "[Multiple Measurement Channels and Sequencer Function](#)" on page 12).

ABORT.....	146
INITiate<n>:CONTInuous.....	146
INITiate<n>:[IMMEDIATE].....	147
INITiate<n>:SEQuencer:ABORt.....	147
INITiate<n>:SEQuencer:IMMEDIATE.....	147
INITiate<n>:SEQuencer:MODE.....	148
[SENSe:]CONFigure:CONTRol.....	149
[SENSe:]CONFigure:MEASurement.....	149
SYSTem:SEQuencer.....	150

ABORt

This command aborts the measurement in the current measurement channel and resets the trigger system.

To prevent overlapping execution of the subsequent command before the measurement has been aborted successfully, use the `*OPC?` or `*WAI` command after `ABOR` and before the next command.

For details see the "Remote Basics" chapter in the R&S FSW User Manual.

Note on blocked remote control programs:

If a sequential command cannot be completed, for example because a triggered sweep never receives a trigger, the remote control program will never finish and the remote channel to the R&S FSW is blocked for further commands. In this case, you must interrupt processing on the remote channel first in order to abort the measurement.

To do so, send a "Device Clear" command from the control instrument to the R&S FSW on a parallel channel to clear all currently active remote channels. Depending on the used interface and protocol, send the following commands:

- **Visa:** `viClear()`
- **GPIB:** `ibclr()`
- **RSIB:** `RSDLlibclr()`

Now you can send the `ABORt` command on the remote channel performing the measurement.

Example: `ABOR; :INIT:IMM`
Aborts the current measurement and immediately starts a new one.

Example: `ABOR; *WAI`
`INIT:IMM`
Aborts the current measurement and starts a new one once abortion has been completed.

Usage: Event
SCPI confirmed

INITiate<n>:CONTInuous <State>

This command controls the sweep mode for an individual measurement channel.

Note that in single sweep mode, you can synchronize to the end of the measurement with `*OPC`, `*OPC?` or `*WAI`. In continuous sweep mode, synchronization to the end of the measurement is not possible. Thus, it is not recommended that you use continuous sweep mode in remote control, as results like trace data or markers are only valid after a single sweep end synchronization.

For details on synchronization see the "Remote Basics" chapter in the R&S FSW User Manual.

Suffix:

<n> irrelevant

Parameters:

<State> ON | OFF | 0 | 1
ON | 1
 Continuous sweep
OFF | 0
 Single sweep
 *RST: 1

Example:

```
INIT:CONT OFF
Switches the sweep mode to single sweep.
INIT:CONT ON
Switches the sweep mode to continuous sweep.
```

Manual operation: See "[Continuous Sweep/RUN CONT](#)" on page 67

INITiate<n>[:IMMEDIATE]

This command starts a (single) new measurement.

You can synchronize to the end of the measurement with *OPC, *OPC? or *WAI.

For details on synchronization see the "Remote Basics" chapter in the R&S FSW User Manual.

Suffix:

<n> irrelevant

Usage:

Event

Manual operation: See "[Single Sweep/ RUN SINGLE](#)" on page 67
 See "[Calibrate](#)" on page 67

INITiate<n>:SEQuencer:ABORT

This command stops the currently active sequence of measurements. The Sequencer itself is not deactivated, so you can start a new sequence immediately using [INITiate<n>:SEQuencer:IMMEDIATE](#) on page 147.

To deactivate the Sequencer use [SYSTEM:SEQuencer](#) on page 150.

Suffix:

<n> irrelevant

Usage:

Event

INITiate<n>:SEQuencer:IMMEDIATE

This command starts a new sequence of measurements by the Sequencer.

Its effect is similar to the [INITiate<n>\[:IMMEDIATE\]](#) command used for a single measurement.

Before this command can be executed, the Sequencer must be activated (see [SYSTem:SEQuencer](#) on page 150).

Suffix:

<n> irrelevant

Example:

SYST:SEQ ON

Activates the Sequencer.

INIT:SEQ:MODE SING

Sets single sequence mode so each active measurement will be performed once.

INIT:SEQ:IMM

Starts the sequential measurements.

Usage:

Event

INITiate<n>:SEQuencer:MODE <Mode>

This command selects the way the R&S FSW application performs measurements sequentially.

Before this command can be executed, the Sequencer must be activated (see [SYSTem:SEQuencer](#) on page 150).

A detailed programming example is provided in the "Operating Modes" chapter in the R&S FSW User Manual.

Note: In order to synchronize to the end of a sequential measurement using *OPC, *OPC? or *WAI you must use `SINGle` Sequence mode.

For details on synchronization see the "Remote Basics" chapter in the R&S FSW User Manual.

Suffix:

<n> irrelevant

Parameters:

<Mode>

SINGle

Each measurement is performed once (regardless of the channel's sweep mode), considering each channels' sweep count, until all measurements in all active channels have been performed.

CONTInuous

The measurements in each active channel are performed one after the other, repeatedly (regardless of the channel's sweep mode), in the same order, until the Sequencer is stopped.

CDEFined

First, a single sequence is performed. Then, only those channels in continuous sweep mode (`INIT:CONT ON`) are repeated.

*RST: CONTInuous

Example:

```

SYST:SEQ ON
Activates the Sequencer.
INIT:SEQ:MODE SING
Sets single sequence mode so each active measurement will be
performed once.
INIT:SEQ:IMM
Starts the sequential measurements.

```

[SENSe:]CONFigure:CONTRol <Mode>

This command selects the measurement mode for the hot and cold power measurements.

Note that selecting a noise source with resistor characteristics with [SENSe:]CORRection:ENR:CALibration:TYPE or [SENSe:]CORRection:ENR[:MEASurement]:TYPE automatically selects manual measurement mode.

Parameters:

<Mode>

AUTO
Performs the Power (Hot) and Power (Cold) measurement in one step.

MANual
Performs the Power (Hot) and Power (Cold) measurement in two separate steps.

Example:

```

CONF:CONT AUTO
Selects the automatic measurement mode.

```

Manual operation: See "[Meas Mode \(Auto Manual\)](#)" on page 68

[SENSe:]CONFigure:MEASurement <Measurement>

This command selects the type of power measurement to perform next.

The command is available for manual measurements (see [SENSe:]CONFigure:CONTRol).

Parameters:

<Measurement>

COLD
Performs the Power (Cold) measurement next.

HOT
Performs the Power (Hot) measurement next.

Example:

```

CONF:CONT MAN
CONF:MEAS HOT
Performs the hot power measurement.

```

Manual operation: See "[Meas Mode \(Auto Manual\)](#)" on page 68

SYSTem:SEQuencer <State>

This command turns the Sequencer on and off. The Sequencer must be active before any other Sequencer commands (`INIT:SEQ...`) are executed, otherwise an error will occur.

A detailed programming example is provided in the "Operating Modes" chapter in the R&S FSW User Manual.

Parameters:

<State>

ON | OFF | 0 | 1

ON | 1

The Sequencer is activated and a sequential measurement is started immediately.

OFF | 0

The Sequencer is deactivated. Any running sequential measurements are stopped. Further Sequencer commands (`INIT:SEQ...`) are not available.

*RST: 0

Example:

SYST:SEQ ON

Activates the Sequencer.

INIT:SEQ:MODE SING

Sets single Sequencer mode so each active measurement will be performed once.

INIT:SEQ:IMM

Starts the sequential measurements.

SYST:SEQ OFF

7.14 Configuring the Inputs and Outputs

- [Radio Frequency \(RF\) Input](#)..... 150
- [External Mixer](#)..... 152
- [External Generator](#)..... 163

7.14.1 Radio Frequency (RF) Input

[INPut:COUPling](#)..... 150[INPut:IMPedance](#)..... 151[INPut:FILTer:HPASs\[:STATe\]](#)..... 151[INPut:FILTer:YIG\[:STATe\]](#)..... 152**INPut:COUPling** <CouplingType>

This command selects the coupling type of the RF input.

Parameters:

<CouplingType> **AC**
 AC coupling
DC
 DC coupling
 *RST: AC

Example: INP:COUP DC

Usage: SCPI confirmed

Manual operation: See "[Input Coupling](#)" on page 68

INPut:IMPedance <Impedance>

This command selects the nominal input impedance of the RF input. In some applications, only 50 Ω are supported.

75 Ω should be selected if the 50 Ω input impedance is transformed to a higher impedance using a matching pad of the RAZ type (= 25 Ω in series to the input impedance of the instrument). The power loss correction value in this case is 1.76 dB = 10 log (75Ω/50Ω).

Parameters:

<Impedance> 50 | 75
 *RST: 50 Ω

Example: INP:IMP 75

Usage: SCPI confirmed

Manual operation: See "[Impedance](#)" on page 69

INPut:FILTer:HPASs[:STATe] <State>

Activates an additional internal high-pass filter for RF input signals from 1 GHz to 3 GHz. This filter is used to remove the harmonics of the R&S FSW in order to measure the harmonics for a DUT, for example.

This function requires an additional high-pass filter hardware option.

(Note: for RF input signals outside the specified range, the high-pass filter has no effect. For signals with a frequency of approximately 4 GHz upwards, the harmonics are suppressed sufficiently by the YIG-preselector, if available.)

Parameters:

<State> ON | OFF
 *RST: OFF

Example: INP:FILT:HPAS ON
 Turns on the filter.

Usage: SCPI confirmed

Manual operation: See "[High-Pass Filter 1...3 GHz](#)" on page 69

INPut:FILTer:YIG[:STATe] <State>

This command turns the YIG-preselector on and off.

Note the special conditions and restrictions for the YIG-preselector described in "[YIG-Preselector](#)" on page 69.

Parameters:

<State> ON | OFF | 0 | 1
 *RST: 1 (0 for I/Q Analyzer, GSM, VSA, Pulse, Amplifier, Transient Analysis, DOCSIS and MC Group Delay measurements)

Example: INP:FILT:YIG OFF
 Deactivates the YIG-preselector.

Manual operation: See "[YIG-Preselector](#)" on page 69

7.14.2 External Mixer

[SENSe:]CORRection:CVL:BAND.....	153
[SENSe:]CORRection:CVL:BIAS.....	153
[SENSe:]CORRection:CVL:CATAlog?.....	154
[SENSe:]CORRection:CVL:CLEAr.....	154
[SENSe:]CORRection:CVL:COMMeNt.....	154
[SENSe:]CORRection:CVL:DATA.....	154
[SENSe:]CORRection:CVL:HARMonic.....	155
[SENSe:]CORRection:CVL:MIXer.....	155
[SENSe:]CORRection:CVL:PORTs.....	156
[SENSe:]CORRection:CVL:SElect.....	156
[SENSe:]CORRection:CVL:SNUMber.....	156
[SENSe:]MIXer:BIAS:HIGH.....	157
[SENSe:]MIXer:BIAS[:LOW].....	157
[SENSe:]MIXer:FREQuency:HANDOver.....	157
[SENSe:]MIXer:FREQuency:STARt?.....	157
[SENSe:]MIXer:FREQuency:STOP?.....	158
[SENSe:]MIXer:HARMonic:BAND:PRESet.....	158
[SENSe:]MIXer:HARMonic:BAND[:VALue].....	158
[SENSe:]MIXer:HARMonic:HIGH:STATe.....	159
[SENSe:]MIXer:HARMonic:HIGH[:VALue].....	159
[SENSe:]MIXer:HARMonic:TYPE.....	159
[SENSe:]MIXer:HARMonic[:LOW].....	160
[SENSe:]MIXer:LOPower.....	160
[SENSe:]MIXer:SIGNal.....	160
[SENSe:]MIXer:LOSS:HIGH.....	161
[SENSe:]MIXer:LOSS:TABLE:HIGH.....	161
[SENSe:]MIXer:LOSS:TABLE[:LOW].....	161
[SENSe:]MIXer:LOSS[:LOW].....	161
[SENSe:]MIXer:PORTs.....	162

[SENSe:]MIXer:RFOVerrange[:STATe].....	162
[SENSe:]MIXer:THReshold.....	162
[SENSe:]MIXer[:STATe].....	162

[SENSe:]CORRection:CVL:BAND <Type>

This command defines the waveguide band for which the conversion loss table is to be used. This setting is checked against the current mixer setting before the table can be assigned to the range.

Before this command can be performed, the conversion loss table must be selected (see [SENSe:]CORRection:CVL:SELEct on page 156).

This command is only available with option B21 (External Mixer) installed.

Parameters:

<Band>

K | A | KA | Q | U | V | E | W | F | D | G | Y | J | USER

Standard waveguide band or user-defined band.

Note: The band formerly referred to as "A" is now named "KA"; the input parameter "A" is still available and refers to the same band as "KA".

For a definition of the frequency range for the pre-defined bands, see [Table 7-4](#)).

*RST: F (90 GHz - 140 GHz)

Example:

```
CORR:CVL:SEL 'LOSS_TAB_4'
```

Selects the conversion loss table.

```
CORR:CVL:BAND KA
```

Sets the band to KA (26.5 GHz - 40 GHz).

Manual operation: See "[Band](#)" on page 78

[SENSe:]CORRection:CVL:BIAS <BiasSetting>

This command defines the bias setting to be used with the conversion loss table.

Before this command can be performed, the conversion loss table must be selected (see [SENSe:]CORRection:CVL:SELEct on page 156).

This command is only available with option B21 (External Mixer) installed.

Parameters:

<BiasSetting>

numeric value

*RST: 0.0 A

Default unit: A

Example:

```
CORR:CVL:SEL 'LOSS_TAB_4'
```

Selects the conversion loss table.

```
CORR:CVL:BIAS 3A
```

Manual operation: See "[Write to <CVL table name>](#)" on page 75
See "[Bias](#)" on page 78

[SENSe:]CORRection:CVL:CATAlog?

This command queries all available conversion loss tables saved in the C:\r_s\instr\user\cvl\ directory on the instrument.

This command is only available with option B21 (External Mixer) installed.

Usage: Query only

[SENSe:]CORRection:CVL:CLEAR

This command deletes the selected conversion loss table. Before this command can be performed, the conversion loss table must be selected (see [\[SENSe:\]CORRection:CVL:SElect](#) on page 156).

This command is only available with option B21 (External Mixer) installed.

Example: CORR:CVL:SEL 'LOSS_TAB_4'
Selects the conversion loss table.
CORR:CVL:CLEAR

Usage: Event

Manual operation: See "[Delete Table](#)" on page 76

[SENSe:]CORRection:CVL:COMMeNT <Text>

This command defines a comment for the conversion loss table. Before this command can be performed, the conversion loss table must be selected (see [\[SENSe:\]CORRection:CVL:SElect](#) on page 156).

This command is only available with option B21 (External Mixer) installed.

Parameters:

<Text>

Example: CORR:CVL:SEL 'LOSS_TAB_4'
Selects the conversion loss table.
CORR:CVL:COMM 'Conversion loss table for
FS_Z60'

Manual operation: See "[Comment](#)" on page 78

[SENSe:]CORRection:CVL:DATA <Freq>,<Level>

This command defines the reference values of the selected conversion loss tables. The values are entered as a set of frequency/level pairs. A maximum of 50 frequency/level pairs may be entered. Before this command can be performed, the conversion loss table must be selected (see [\[SENSe:\]CORRection:CVL:SElect](#) on page 156).

This command is only available with option B21 (External Mixer) installed.

Parameters:

<Freq> numeric value

The frequencies have to be sent in ascending order.

<Level>

Example:

CORR:CVL:SEL 'LOSS_TAB_4'

Selects the conversion loss table.

CORR:CVL:DATA 1MHZ,-30DB,2MHZ,-40DB

Manual operation: See "[Position/Value](#)" on page 79**[SENSe:]CORRection:CVL:HARMonic <HarmOrder>**

This command defines the harmonic order for which the conversion loss table is to be used. This setting is checked against the current mixer setting before the table can be assigned to the range.

Before this command can be performed, the conversion loss table must be selected (see [\[SENSe:\]CORRection:CVL:SElect](#) on page 156).

This command is only available with option B21 (External Mixer) installed.

Parameters:

<HarmOrder> numeric value

Range: 2 to 65

Example:

CORR:CVL:SEL 'LOSS_TAB_4'

Selects the conversion loss table.

CORR:CVL:HARM 3

Manual operation: See "[Harmonic Order](#)" on page 78**[SENSe:]CORRection:CVL:MIXer <Type>**

This command defines the mixer name in the conversion loss table. This setting is checked against the current mixer setting before the table can be assigned to the range.

Before this command can be performed, the conversion loss table must be selected (see [\[SENSe:\]CORRection:CVL:SElect](#) on page 156).

This command is only available with option B21 (External Mixer) installed.

Parameters:

<Type> string

Name of mixer with a maximum of 16 characters

Example:

CORR:CVL:SEL 'LOSS_TAB_4'

Selects the conversion loss table.

CORR:CVL:MIX 'FS_Z60'

Manual operation: See "[Mixer Name](#)" on page 78

[SENSe:]CORRection:CVL:PORTs <PortNo>

This command defines the mixer type in the conversion loss table. This setting is checked against the current mixer setting before the table can be assigned to the range.

Before this command can be performed, the conversion loss table must be selected (see [\[SENSe:\]CORRection:CVL:SElect](#) on page 156).

This command is only available with option B21 (External Mixer) installed.

Parameters:

<PortType> 2 | 3
*RST: 2

Example:

```
CORR:CVL:SEL 'LOSS_TAB_4'
Selects the conversion loss table.
CORR:CVL:PORT 3
```

Manual operation: See ["Mixer Type"](#) on page 79

[SENSe:]CORRection:CVL:SElect <FileName>

This command selects the conversion loss table with the specified file name. If <file_name> is not available, a new conversion loss table is created.

This command is only available with option B21 (External Mixer) installed.

Parameters:

<FileName> String containing the path and name of the file.

Example:

```
CORR:CVL:SEL 'LOSS_TAB_4'
```

Manual operation: See ["New Table"](#) on page 75
See ["Edit Table"](#) on page 76
See ["File Name"](#) on page 77

[SENSe:]CORRection:CVL:SNUMber <SerialNo>

This command defines the serial number of the mixer for which the conversion loss table is to be used. This setting is checked against the current mixer setting before the table can be assigned to the range.

Before this command can be performed, the conversion loss table must be selected (see [\[SENSe:\]CORRection:CVL:SElect](#) on page 156).

This command is only available with option B21 (External Mixer) installed.

Parameters:

<SerialNo> Serial number with a maximum of 16 characters

Example:

```
CORR:CVL:SEL 'LOSS_TAB_4'
Selects the conversion loss table.
CORR:CVL:MIX '123.4567'
```

Manual operation: See ["Mixer S/N"](#) on page 78

[SENSe:]MIXer:FREQuency:STOP?

This command queries the frequency at which the external mixer band stops.

Example: MIX:FREQ:STOP?
Queries the stop frequency of the band.

Usage: Query only

Manual operation: See "RF Start / RF Stop" on page 70

[SENSe:]MIXer:HARMonic:BAND:PRESet

This command restores the preset frequency ranges for the selected standard waveguide band.

Note: Changes to the band and mixer settings are maintained even after using the PRESET function. Use this command to restore the predefined band ranges.

Example: MIX:HARM:BAND:PRESet
Prestes the selected waveguide band.

Usage: Event

Manual operation: See "Preset Band" on page 71

[SENSe:]MIXer:HARMonic:BAND[:VALue] <Band>

This command selects the external mixer band. The query returns the currently selected band.

This command is only available if the external mixer is active (see [SENSe:]MIXer[:STATe] on page 162).

Parameters:

<Band> KA|Q|U|V|E|W|F|D|G|Y|J|USER
Standard waveguide band or user-defined band.

Manual operation: See "Band" on page 71

Table 7-4: Frequency ranges for pre-defined bands

Band	Frequency start [GHz]	Frequency stop [GHz]
KA (A) *)	26.5	40.0
Q	33.0	50.0
U	40.0	60.0
V	50.0	75.0
E	60.0	90.0
W	75.0	110.0
F	90.0	140.0

*) The band formerly referred to as "A" is now named "KA".

Band	Frequency start [GHz]	Frequency stop [GHz]
D	110.0	170.0
G	140.0	220.0
J	220.0	325.0
Y	325.0	500.0
USER	32.18 (default)	68.22 (default)

*) The band formerly referred to as "A" is now named "KA".

[SENSe:]MIXer:HARMonic:HIGH:STATe <State>

This command specifies whether a second (high) harmonic is to be used to cover the band's frequency range.

Parameters:

<State> ON | OFF
 *RST: OFF

Example: MIX:HARM:HIGH:STAT ON

Manual operation: See "[Range 1/2](#)" on page 72

[SENSe:]MIXer:HARMonic:HIGH[:VALue] <HarmOrder>

This command specifies the harmonic order to be used for the high (second) range.

Parameters:

<HarmOrder> numeric value
 Range: 2 to 61 (USER band); for other bands: see band definition

Example: MIX:HARM:HIGH 2

Manual operation: See "[Harmonic Order](#)" on page 72

[SENSe:]MIXer:HARMonic:TYPE <OddEven>

This command specifies whether the harmonic order to be used should be odd, even, or both.

Which harmonics are supported depends on the mixer type.

Parameters:

<OddEven> **ODD | EVEN | EODD**
 *RST: EVEN

Example: MIX:HARM:TYPE ODD

Manual operation: See "[Harmonic Type](#)" on page 72

[SENSe:]MIXer:HARMonic[:LOW] <HarmOrder>

This command specifies the harmonic order to be used for the low (first) range.

Parameters:

<HarmOrder> numeric value
 Range: 2 to 61 (USER band); for other bands: see band definition
 *RST: 2 (for band F)

Example: MIX:HARM 3

Manual operation: See "[Harmonic Order](#)" on page 72

[SENSe:]MIXer:LOPower <Level>

This command specifies the LO level of the external mixer's LO port.

Parameters:

<Level> numeric value
 Range: 13.0 dBm to 17.0 dBm
 Increment: 0.1 dB
 *RST: 15.5 dBm

Example: MIX:LOP 16.0dBm

Manual operation: See "[LO Level](#)" on page 73

[SENSe:]MIXer:SIGNal <State>

This command specifies whether automatic signal detection is active or not.

Note that automatic signal identification is only available for measurements that perform frequency sweeps (not in vector signal analysis or the I/Q Analyzer, for instance).

Parameters:

<State> **OFF | ON | AUTO | ALL**
OFF
 No automatic signal detection is active.
ON
 Automatic signal detection (Signal ID) is active.
AUTO
 Automatic signal detection (Auto ID) is active.
ALL
 Both automatic signal detection functions (Signal ID+Auto ID) are active.
 *RST: OFF

Manual operation: See "[Signal ID](#)" on page 74
 See "[Auto ID](#)" on page 74

[SENSe:]MIXer:LOSS:HIGH <Average>

This command defines the average conversion loss to be used for the entire high (second) range.

Parameters:

<Average> numeric value
 Range: 0 to 100
 *RST: 24.0 dB
 Default unit: dB

Example: MIX:LOSS:HIGH 20dB

Manual operation: See "[Conversion loss](#)" on page 72

[SENSe:]MIXer:LOSS:TABLE:HIGH <FileName>

This command defines the file name of the conversion loss table to be used for the high (second) range.

Parameters:

<FileName> String containing the path and name of the file.

Example: MIX:LOSS:TABLE:HIGH 'MyCVLTable'

Manual operation: See "[Conversion loss](#)" on page 72

[SENSe:]MIXer:LOSS:TABLE[:LOW] <FileName>

This command defines the file name of the conversion loss table to be used for the low (first) range.

Parameters:

<FileName> String containing the path and name of the file.

Example: MIX:LOSS:TABLE 'mix_1_4'
 Specifies the conversion loss table *mix_1_4*.

Manual operation: See "[Conversion loss](#)" on page 72

[SENSe:]MIXer:LOSS[:LOW] <Average>

This command defines the average conversion loss to be used for the entire low (first) range.

Parameters:

<Average> numeric value
 Range: 0 to 100
 *RST: 24.0 dB
 Default unit: dB

Example: MIX:LOSS 20dB

Manual operation: See "[Conversion loss](#)" on page 72

[SENSe:]MIXer:PORTs <PortType>

This command specifies whether the mixer is a 2-port or 3-port type.

Parameters:

<PortType> **2 | 3**
 *RST: 2

Example: MIX:PORT 3

Manual operation: See "[Mixer Type](#)" on page 72

[SENSe:]MIXer:RFOVerrange[:STATe] <State>

If enabled, the band limits are extended beyond "RF Start" and "RF Stop" due to the capabilities of the used harmonics.

Parameters:

<State> ON | OFF
 *RST: OFF

Manual operation: See "[RF Overrange](#)" on page 71

[SENSe:]MIXer:THReshold <Value>

This command defines the maximum permissible level difference between test sweep and reference sweep to be corrected during automatic comparison (see [\[SENSe:\]MIXer:SIGNal](#) on page 160).

Parameters:

<Value> <numeric value>
 Range: 0.1 dB to 100 dB
 *RST: 10 dB

Example: MIX:PORT 3

Manual operation: See "[Auto ID Threshold](#)" on page 74

[SENSe:]MIXer[:STATe] <State>

Activates or deactivates the use of a connected external mixer as input for the measurement. This command is only available if the optional External Mixer is installed and an external mixer is connected.

Parameters:

<State> ON | OFF
 *RST: OFF

Example: MIX ON

Manual operation: See "[External Mixer State](#)" on page 70

7.14.3 External Generator

SOURce:EXTernal:FREQUency[:FACTor]:DENominator.....	163
SOURce:EXTernal:FREQUency[:FACTor]:NUMerator.....	163
SOURce:EXTernal:FREQUency:OFFSet<offset>.....	163
SOURce:EXTernal:POWer[:LEVel].....	164
SOURce:EXTernal:ROSCillator[:SOURce].....	164
SYSTem:COMMunicate:GPIB:RDEvice:GENerator:ADDResS.....	164
SYSTem:COMMunicate:RDEvice:GENerator:INTerface.....	165
SYSTem:COMMunicate:RDEvice:GENerator:TYPE.....	165
SYSTem:COMMunicate:TCPIP:RDEvice:GENerator:ADDResS.....	165
SYSTem:CONFigure:GENerator:CONTRol:STATe.....	165
SYSTem:CONFigure:GENerator:INITialise:AUTO.....	166
SYSTem:CONFigure:GENerator:INITialise:IMMEDIATE.....	166
SYSTem:CONFigure:GENerator:SWITCh:AUTO.....	166

SOURce:EXTernal:FREQUency[:FACTor]:DENominator <Denominator>

SOURce:EXTernal:FREQUency[:FACTor]:NUMerator <Numerator>

SOURce:EXTernal:FREQUency:OFFSet<offset> <Offset>

These commands define the frequency correction characteristics for the generator.

The commands are available with option R&S FSW-B10.

Frequency correction is calculated according to the following equation:

$$f_{\text{Generator}} = \left[(f_{\text{LO}} + \text{Offset} < 1 >) * \frac{\text{Numerator}}{\text{Denominator}} \right] + \text{Offset} < 2 >$$

with:

- $f_{\text{Generator}}$ = generator frequency
- f_{LO} = frequency of the analyzer's LO
- $f_{\text{offset}<1>}$ = offset frequency of the analyzer
- $f_{\text{offset}<2>}$ = offset frequency of other components

Suffix:

<offset> 1 | 2
offset frequencies as described above

Parameters:

<Denominator> Correction factor without a unit.
*RST: 1

<Numerator> Correction factor without a unit.
*RST: 1

<Offset> Frequency offset.
*RST: 0
Default unit: Hz

Example: SOUR:EXT:FREQ:FACT:NOM 2
 SOUR:EXT:FREQ:FACT:DEN 2.5
 Defines a frequency correction factor of 2/2.5.
 SOUR:EXT:FREQ:OFFS2 100HZ
 Defines 100 Hz as the second frequency offset.

Manual operation: See "[Frequency Coupling](#)" on page 83

SOURce:EXTernal:POWer[:LEVel] <Level>

This command sets the output power of the selected generator.

Parameters:

<Level> <numeric value>
 *RST: -20 dBm

Example: SOUR:EXT:POW -30dBm
 Sets the generator level to -30 dBm

Manual operation: See "[Source Power](#)" on page 83

SOURce:EXTernal:ROSCillator[:SOURce] <Source>

This command controls selection of the reference oscillator for the external generator.

If the external reference oscillator is selected, the reference signal must be connected to the rear panel of the instrument.

Parameters:

<Source> **INTernal**
 the internal reference is used
 EXTernal
 the external reference is used; if none is available, an error flag is displayed in the status bar
 *RST: INT

Example: SOUR:EXT:ROSC EXT
 Switches to external reference oscillator

Manual operation: See "[Reference](#)" on page 81

SYSTem:COMMunicate:GPIB:RDEvice:GENerator:ADDRess <Number>

Changes the IEC/IEEE-bus address of the external generator.

Parameters:

<Number> Range: 0 to 30
 *RST: 28

Example: SYST:COMM:GPIB:RDEV:GEN:ADDR 15

Manual operation: See "[GPIB Address / TCP/IP Address](#)" on page 81

SYSTem:COMMunicate:RDEvice:GENerator:INTerface <Type>

Defines the interface used for the connection to the external generator.

Parameters:

<Type> GPIB | TCPip
*RST: GPIB

Example: SYST:COMM:RDEV:GEN:INT TCP

Manual operation: See "[Interface](#)" on page 80

SYSTem:COMMunicate:RDEvice:GENerator:TYPE <Type>

This command selects the type of external generator.

Parameters:

<Name> <Generator name as string value>
*RST: SMU02

Example: SYST:COMM:RDEV:GEN:TYPE 'SMW06'
Selects SMW06 as an external generator

Manual operation: See "[Generator Type](#)" on page 80

SYSTem:COMMunicate:TCPip:RDEvice:GENerator:ADDRess <Address>

Configures the TCP/IP address for the external generator.

Parameters:

<Address> TCP/IP address between 0.0.0.0 and 0.255.255.255
*RST: 0.0.0.0

Example: SYST:COMM:TCP:RDEV:GEN:ADDR 130.094.122.195

Manual operation: See "[GPIB Address / TCP/IP Address](#)" on page 81

SYSTem:CONFigure:GENerator:CONTRol:STATe <State>

This command turns automatic control of an external generator on and off.

The command is available with option R&S FSW-B10.

Parameters:

<State> ON | OFF
*RST: OFF

Example: SYST:CONF:GEN:CONT:STAT ON
Turns on automatic generator control.

Manual operation: See "[Automatic Control](#)" on page 82

SYSTem:CONFigure:GENerator:INITialise:AUTO <State>

This command turns automatic connection to the generator on and off.

If on, the application automatically configures the generator before each measurement and turns on its RF output. Note that you have to establish a connection to the generator before you can perform the measurement.

The command is available with option R&S FSW-B10.

Parameters:

<State> ON | OFF
*RST: OFF

Example:

SYST:CONF:GEN:INIT:AUTO ON
Turns automatic generator configuration on.

Manual operation: See ["Init Before Meas"](#) on page 82

SYSTem:CONFigure:GENerator:INITialise:IMMediate

This command establishes a connection to the external generator.

When you send the command, the application configures the generator once and turns on its RF output. Note that you have to establish a connection to the generator before you can perform the measurement.

The command is available with option R&S FSW-B10.

Usage: Event

Manual operation: See ["Init External Generator"](#) on page 83

SYSTem:CONFigure:GENerator:SWITCh:AUTO <State>

This command turns automatic deactivation of the generator's RF output after a measurement is done on and off.

The command is available with option R&S FSW-B10.

Parameters:

<State> ON | OFF
*RST: OFF

Example:

SYST:CONF:GEN:SWIT:AUTO ON
Turns on automatic deactivation of the RF output.

Manual operation: See ["Auto Switch Off"](#) on page 82

7.15 Configuring the Display

The following commands are necessary to configure and scale the result displays.

DISPlay[:WINDow<n>]:TABLe:ITEM.....	167
DISPlay[:WINDow<n>]:TRACe:SYMBols.....	167
DISPlay[:WINDow<n>]:TRACe:X[:SCALe].....	167
DISPlay[:WINDow<n>]:TRACe<t>:Y[:SCALe]:BOTTom.....	168
DISPlay[:WINDow<n>]:TRACe:Y[:SCALe]:AUTO.....	168
DISPlay[:WINDow<n>]:TRACe<t>:Y[:SCALe]:TOP.....	169

DISPlay[:WINDow<n>]:TABLe:ITEM <Item>,<State>

This command selects the items displayed in the Result Table.

Suffix:

<n> Window

Parameters:

<Items> For a list of possible parameter values (table items) see the parameter description of the `TRACe<n>[:DATA]?` command.

<State> ON | OFF

Example:

`DISP:WIND2:TABL:ITEM NOIS,OFF`

Removes the Noise result from the Result Table.

Manual operation: See "Result Table" on page 21

DISPlay[:WINDow<n>]:TRACe:SYMBols <State>

This command turns symbols that represent the measurement points on a trace on and off.

Suffix:

<n> Window

Parameters:

<State> ON | OFF

*RST: OFF

Example:

`DISP:WIND2:TRAC:SYMB ON`

Switches on the display of symbols in window 2..

Manual operation: See "Symbols" on page 85

DISPlay[:WINDow<n>]:TRACe:X[:SCALe] <Frequency>

This command selects the type of frequency displayed on the x-axis.

Suffix:

<n> Window

Parameters:

<Frequency>

IF

Intermediary frequency, e.g. for measurements on frequency converting DUTs.

RF

Radio frequency.

*RST: RF

Example:

CONF:MODE:DUT DOWN

The DUT converts the input frequency to a lower output frequency.

DISP:TRAC:X RF

Shows the RF frequency on the x-axis.

Manual operation: See "[X-Axis](#)" on page 85**DISPlay[:WINDow<n>]:TRACe<t>:Y[:SCALe]:BOTTom <Level>**

This command defines the bottom value of the y-axis.

Suffix:

<n>

[Window](#)

<t>

[Trace](#)**Parameters:**

<Level>

The value ranges depend on the result display.

Noise figure

-75 dB to 75 dB

Noise temperature

-999990000 K to 999990000 K

Y-factor

-200 dB to 200 dB

Gain

-75 dB to 75 dB

Power (hot)

-200 dBm to 200 dBm

Power (cold)

-200 dBm to 200 dBm

Example:

DISP:WIND2:TRAC:Y:SCAL:AUTO OFF

DISP:WIND2:TRAC:Y:BOTT

Usage:

SCPI confirmed

Manual operation: See "[Auto Scale / Min / Max](#)" on page 85**DISPlay[:WINDow<n>]:TRACe:Y[:SCALe]:AUTO <State>**

This command turns automatic scaling of the y-axis on and off.

Suffix:	
<n>	Window
Parameters:	
<State>	ON OFF
	*RST: ON
Example:	DISP:WIND2:TRAC:Y:AUTO ON Turns on automatic scaling for measurement window 2.
Usage:	SCPI confirmed
Manual operation:	See "Auto Scale / Min / Max" on page 85

DISPlay[:WINDow<n>]:TRACe<t>:Y[:SCALe]:TOP <Level>

This command defines the top value of the y-axis.

Suffix:	
<n>	Window
<t>	Trace
Parameters:	
<Level>	The value ranges depend on the result display.
	Noise figure -75 dB to 75 dB
	Noise temperature -999990000 K to 999990000 K
	Y-factor -200 dB to 200 dB
	Gain -75 dB to 75 dB
	Power (hot) -200 dBm to 200 dBm
	Power (cold) -200 dBm to 200 dBm
Example:	DISP:WIND2:TRAC:Y:SCAL:AUTO OFF DISP:WIND2:TRAC:Y:TOP
Usage:	SCPI confirmed
Manual operation:	See "Auto Scale / Min / Max" on page 85

7.16 Working with Traces

The following commands are necessary to define trace characteristics.

DISPlay[:WINDow<n>]:TRACe<t>:MODE.....	170
DISPlay[:WINDow<n>]:TRACe<t>[:STATe].....	170
FORMat[:DATA].....	171
FORMat:DEXPort:DSEParator.....	171
FORMat:DEXPort:HEADer.....	171
FORMat:DEXPort:TRACes.....	172
MMEMory:STORe<n>:TRACe.....	172
TRACe<n>:COPY.....	173

DISPlay[:WINDow<n>]:TRACe<t>:MODE <Mode>

This command selects the trace mode.

Suffix:

<n> Window

<t> Trace

Parameters:

<Mode> BLANK | VIEW | WRITe

*RST: Trace 1: WRITe, Trace 2-4: BLANK

Example:

INIT:CONT OFF

Switching to single sweep mode.

SWE:COUN 16

Sets the number of measurements to 16.

DISP:TRAC3:MODE WRIT

Selects clear/write mode for trace 3.

INIT;*WAI

Starts the measurement and waits for the end of the measurement.

Manual operation: See "Traces" on page 86

DISPlay[:WINDow<n>]:TRACe<t>[:STATe] <State>

This command turns a trace on and off.

The measurement continues in the background.

Suffix:

<n> Window

<t> Trace

Parameters:

<State> ON | OFF | 1 | 0

*RST: Trace 1: 1, Trace 2-4: 0

Example:

DISP:TRAC3 ON

Usage:

SCPI confirmed

FORMat[:DATA] <Format>

This command selects the data format that is used for transmission of trace data from the R&S FSW to the controlling computer.

Note that the command has no effect for data that you send to the R&S FSW. The R&S FSW automatically recognizes the data it receives, regardless of the format.

Parameters:

<Format>

AScii

AScii format, separated by commas.

This format is almost always suitable, regardless of the actual data format. However, the data is not as compact as other formats may be.

REAL,32

32-bit IEEE 754 floating-point numbers in the "definite length block format".

In the Spectrum application, the format setting `REAL` is used for the binary transmission of trace data.

For I/Q data, 8 bytes per sample are returned for this format setting.

*RST: ASCII

Example:

```
FORM REAL, 32
```

Usage:

SCPI confirmed

FORMat:DEXPort:DSEParator <Separator>

This command selects the decimal separator for data exported in ASCII format.

Parameters:

<Separator>

COMMa

Uses a comma as decimal separator, e.g. `4,05`.

POINT

Uses a point as decimal separator, e.g. `4.05`.

*RST: *RST has no effect on the decimal separator.
Default is POINT.

Example:

```
FORM:DEXP:DSEP POIN
```

Sets the decimal point as separator.

Manual operation:

See "[Trace Export](#)" on page 87

FORMat:DEXPort:HEADer <State>

If enabled, additional instrument and measurement settings are included in the header of the export file for result data. If disabled, only the pure result data from the selected traces and tables is exported.

Parameters:

<State> ON | OFF | 0 | 1
 *RST: 1

Usage: SCPI confirmed

Manual operation: See ["Trace Export"](#) on page 87

FORMat:DEXPort:TRACes <Selection>

This command selects the data to be included in a data export file (see [MMEMory:STORe<n>:TRACe](#) on page 172).

Parameters:

<Selection> **SINGLE**
 Only a single trace is selected for export, namely the one specified by the [MMEMory:STORe<n>:TRACe](#) command.

ALL
 Selects all active traces and result tables (e.g. Result Summary, marker peak list etc.) in the current application for export to an ASCII file.
 The <trace> parameter for the [MMEMory:STORe<n>:TRACe](#) command is ignored.

*RST: SINGLE

Usage: SCPI confirmed

Manual operation: See ["Trace Export"](#) on page 87

MMEMory:STORe<n>:TRACe <Trace>, <FileName>

This command exports trace data from the specified window to an ASCII file.

Secure User Mode

In secure user mode, settings that are stored on the instrument are stored to volatile memory, which is restricted to 256 MB. Thus, a "Memory full" error can occur although the hard disk indicates that storage space is still available.

To store data permanently, select an external storage location such as a USB memory device.

For details, see "Protecting Data Using the Secure User Mode" in the "Data Management" section of the R&S FSW User Manual.

Suffix:

<n> [Window](#)

Parameters:

<Trace> Number of the trace to be stored
 <FileName> String containing the path and name of the target file.

Example: `M MEM:STOR1:TRAC 3, 'C:\TEST.ASC'`
Stores trace 3 from window 1 in the file TEST.ASC.

Usage: SCPI confirmed

Manual operation: See "Trace Export" on page 87

TRACe<n>:COPY <TraceNumber>, <TraceNumber>

This command copies data from one trace to another.

Suffix:
<n> [Window](#)

Parameters:
<TraceNumber>, **TRACE1 | TRACE2 | TRACE3 | TRACE4**
<TraceNumber> The first parameter is the destination trace, the second parameter is the source.
(Note the 'e' in the parameter is required!)

Example: `TRAC:COPY TRACE1, TRACE2`
Copies the data from trace 2 to trace 1.

Usage: SCPI confirmed

Manual operation: See "Copy Trace" on page 87

7.17 Working with Limit Lines

The following commands are necessary to set up limit lines and checks.

When configuring limit lines for the noise figure application via remote control, you have to send some commands in a defined order.

1. Select the limit line you want to configure by name or create a new limit line name.
2. Select the result type you want to apply the limit line to.
The application automatically selects the unit and scale to make the line compatible to the result type.
3. Define the horizontal data points of the limit line.
4. Define the vertical data points of the limit line. Depending on the command syntax you are using, the shape also defines if the limit line is an upper or lower limit line (`CALCulate:LIMit:UPPer:...` or `CALCulate:LIMit:LOWer:...`).

Example: Configure an upper limit line for the Noise Figure result type

```
//Select or create the limit line by name.
CALC:LIM:NAME 'NoiseFigure'
//Comment on the limit line.
CALC:LIM:COMM 'Limit line to test noise figure results'
```

```

//Select the result type (here: Noise Figure) to apply the limit line to.
CALC:LIM:TYPE NOIS
//Define the horizontal data points of the limit line.
CALC:LIM:CONT 100MHZ,850MHZ
//Shift the limit line 50 MHz to the left.
CALC:LIM:CONT:SHIF -50MHZ
//Define the vertical data points of an (upper) limit line.
//The unit is fix according to the result type you have selected.
CALC:LIM:UPP 10,10
//Shift the limit line 5 dB down.
CALC:LIM:UPP:SHIF -5
//Turn the limit line on.
CALC:LIM:UPP:STAT ON
//Select the trace to check.
CALC:LIM:TRAC 1
//Turn on the limit check.
CALC:LIM:STAT ON
//Query the limit check results.
CALC:LIM:FAIL?

```

- [Defining General Characteristics of a Limit Line](#)..... 174
- [Defining Horizontal Data Points](#)..... 175
- [Controlling Lower Limit Lines](#)..... 177
- [Controlling Upper Limit Lines](#)..... 178
- [Managing Limit Lines](#)..... 179
- [Controlling Limit Checks](#)..... 180

7.17.1 Defining General Characteristics of a Limit Line

CALCulate<n>:LIMit<k>:COMMent	174
CALCulate<n>:LIMit<k>:NAME	175
CALCulate:LIMit<k>:TYPE	175

CALCulate<n>:LIMit<k>:COMMent <Comment>

This command defines a comment for a limit line.

Suffix:

<n> irrelevant

<k> [Limit line](#)

Parameters:

<Comment> String containing the description of the limit line. The comment may have up to 40 characters.

Manual operation: See "[Comment](#)" on page 95

CALCulate<n>:LIMit<k>:NAME <Name>

This command selects a limit line that already exists or defines a name for a new limit line.

Suffix:

<n> [Window](#)

<k> [Limit line](#)

Parameters:

<Name> String containing the limit line name.

*RST: REM1 to REM8 for lines 1 to 8

Manual operation: See "[Name](#)" on page 95

CALCulate:LIMit<k>:TYPE <Result>

This command configures a limit line for a particular result type.

Suffix:

<k> [Limit line](#)

Parameters:

<Result>

GAIN

Assigns the limit line to gain results.

NOISe

Assigns the limit line to noise figure results.

PCOLd

Assigns the limit line to power (cold) results.

PHOT

Assigns the limit line to power (hot) results.

TEMPerature

Assigns the limit line to noise temperature results.

YFACTOR

Assigns the limit line to y-factor results.

Example:

```
CALC:LIM2:TYPE GAIN
```

Assigns limit line 2 to the gain result display.

7.17.2 Defining Horizontal Data Points

Note that the number of data points on the horizontal axis should be the same as the number of data points on the vertical axis. Otherwise the limit line may take on an unintended shape.

Example: Number of vertical data points < number of horizontal data points

```
CALC:LIM:CONT 100MHZ,200MHZ,300MHZ,400MHZ,500MHZ
```

```
CALC:LIM:UPP 0,5,0
```

⇒ the application dumps 400 and 500 MHz.

Example: Number of vertical data points > number of horizontal data points

```
CALC:LIM:CONT 100MHZ,200MHZ,300MHZ,400MHZ,500MHZ
```

```
CALC:LIM:UPP 0,5,0,5,0,5,0
```

⇒ the application adds new horizontal data points (500.00000100 MHz and 500.00000200 MHz).

CALCulate<n>:LIMit<k>:CONTrol[:DATA]..... 176

CALCulate<n>:LIMit<k>:CONTrol:SHIFt..... 176

CALCulate<n>:LIMit<k>:CONTrol[:DATA] <LimitLinePoints>

This command defines the horizontal definition points of a limit line.

Suffix:

<n> irrelevant

<k> [Limit line](#)

Parameters:

<LimitLinePoints> Variable number of x-axis values.
Note that the number of horizontal values has to be the same as the number of vertical values set with [CALCulate<n>:LIMit<k>:LOWer\[:DATA\]](#) or [CALCulate<n>:LIMit<k>:UPPer\[:DATA\]](#). If not, the R&S FSW either adds missing values or ignores surplus values.

*RST: -

Usage: SCPI confirmed

Manual operation: See "[Data points](#)" on page 96

CALCulate<n>:LIMit<k>:CONTrol:SHIFt <Distance>

This command moves a complete limit line horizontally.

Compared to defining an offset, this command actually changes the limit line definition points by the value you define.

Suffix:

<n> irrelevant

<k> [Limit line](#)

Parameters:

<Distance> Numeric value.
The unit depends on the scale of the x-axis.

Manual operation: See "[Shift x](#)" on page 96

7.17.3 Controlling Lower Limit Lines

CALCulate<n>:LIMit<k>:LOWer[:DATA]	177
CALCulate<n>:LIMit<k>:LOWer:SHIFt	177
CALCulate<n>:LIMit<k>:LOWer:STATe	177

CALCulate<n>:LIMit<k>:LOWer[:DATA] <LimitLinePoints>

This command defines the vertical definition points of a lower limit line.

Suffix:

<n>	irrelevant
<k>	Limit line

Parameters:

<LimitLinePoints>	Variable number of level values. Note that the number of vertical values has to be the same as the number of horizontal values set with CALCulate<n>:LIMit<k>:CONTRol[:DATA] . If not, the R&S FSW either adds missing values or ignores surplus values. *RST: Limit line state is OFF
-------------------	--------------------------------------------------------------------------------------------------------------------------------------------------------------------------------------------------------------------------------------------------------------------------------------------------------------------------

Usage: SCPI confirmed

Manual operation: See "[Data points](#)" on page 96

CALCulate<n>:LIMit<k>:LOWer:SHIFt <Distance>

This command moves a complete lower limit line vertically.

Compared to defining an offset, this command actually changes the limit line definition points by the value you define.

Suffix:

<n>	Window
<k>	Limit line

Parameters:

<Distance>	Defines the distance that the limit line moves.
------------	-------------------------------------------------

Manual operation: See "[Shift y](#)" on page 96

CALCulate<n>:LIMit<k>:LOWer:STATe <State>

This command turns a lower limit line on and off.

Before you can use the command, you have to select a limit line with [CALCulate<n>:LIMit<k>:NAME](#) on page 175.

Suffix:

<n>	irrelevant
<k>	Limit line

Parameters:

<State> ON | OFF
 *RST: OFF

Usage: SCPI confirmed

Manual operation: See "[Visibility](#)" on page 93

7.17.4 Controlling Upper Limit Lines

CALCulate<n>:LIMit<k>:UPPer[:DATA]	178
CALCulate<n>:LIMit<k>:UPPer:SHIFt	178
CALCulate<n>:LIMit<k>:UPPer:STATe	179

CALCulate<n>:LIMit<k>:UPPer[:DATA] <LimitLinePoints>

This command defines the vertical definition points of an upper limit line.

Suffix:

<n> irrelevant
 <k> [Limit line](#)

Parameters:

<LimitLinePoints> Variable number of level values.
 Note that the number of vertical values has to be the same as the number of horizontal values set with [CALCulate<n>:LIMit<k>:CONTRol\[:DATA\]](#). If not, the R&S FSW either adds missing values or ignores surplus values.
 *RST: Limit line state is OFF

Usage: SCPI confirmed

Manual operation: See "[Data points](#)" on page 96

CALCulate<n>:LIMit<k>:UPPer:SHIFt <Distance>

This command moves a complete upper limit line vertically.

Compared to defining an offset, this command actually changes the limit line definition points by the value you define.

Suffix:

<n> irrelevant
 <k> [Limit line](#)

Parameters:

<Distance> Defines the distance that the limit line moves.

Usage: Event

Manual operation: See "[Shift y](#)" on page 96

CALCulate<n>:LIMit<k>:UPPer:STATe <State>

This command turns an upper limit line on and off.

Before you can use the command, you have to select a limit line with [CALCulate<n>:LIMit<k>:NAME](#) on page 175.

Suffix:

<n> irrelevant

<k> [Limit line](#)

Parameters:

<State> ON | OFF

*RST: OFF

Usage: SCPI confirmed

Manual operation: See "[Visibility](#)" on page 93

7.17.5 Managing Limit Lines

[CALCulate<n>:LIMit<k>:ACTive?](#)..... 179

[CALCulate<n>:LIMit<k>:COPY](#)..... 179

[CALCulate<n>:LIMit<k>:DELeTe](#)..... 180

CALCulate<n>:LIMit<k>:ACTive?

This command queries the names of *all* active limit lines.

Suffix:

<n>, <k> irrelevant

Return values:

<LimitLines> String containing the names of all active limit lines in alphabetical order.

Example: `CALC:LIM:ACT?`

Queries the names of all active limit lines.

Usage: Query only

Manual operation: See "[Visibility](#)" on page 93

CALCulate<n>:LIMit<k>:COPY <Line>

This command copies a limit line.

Suffix:

<n> [Window](#)

<k> [Limit line](#)

Parameters:

<Line> **1 to 8**
 number of the new limit line

<name>
 String containing the name of the limit line.

Example:

```
CALC:LIM1:COPY 2
Copies limit line 1 to line 2.
CALC:LIM1:COPY 'FM2'
Copies limit line 1 to a new line named FM2.
```

Manual operation: See "[Copy Line](#)" on page 94

CALCulate<n>:LIMit<k>:DELeTe

This command deletes a limit line.

Suffix:

<n> [Window](#)

<k> [Limit line](#)

Usage: Event

Manual operation: See "[Delete Line](#)" on page 94

7.17.6 Controlling Limit Checks

CALCulate<n>:LIMit<k>:CLEar[:IMMediate]	180
CALCulate<n>:LIMit<k>:FAIL?	180
CALCulate<n>:LIMit<k>:STATe	181
CALCulate<n>:LIMit<k>:TRACe	181
CALCulate<n>:LIMit<k>:TRACe<t>:CHECK	182

CALCulate<n>:LIMit<k>:CLEar[:IMMediate]

This command deletes the result of the current limit check.

The command works on *all* limit lines in *all* measurement windows at the same time.

Suffix:

<n>, <k> irrelevant

Example:

```
CALC:LIM:CLE
Deletes the result of the limit check.
```

Usage: SCPI confirmed

CALCulate<n>:LIMit<k>:FAIL?

This command queries the result of a limit check in the specified window.

To get a valid result, you have to perform a complete measurement with synchronization to the end of the measurement before reading out the result. This is only possible for single sweep mode.

See also [INITiate<n>:CONTInuous](#) on page 146.

Suffix:

<n> [Window](#)

<k> [Limit line](#)

Return values:

<Result> **0**
 PASS
 1
 FAIL

Example:

INIT;*WAI

Starts a new sweep and waits for its end.

CALC2:LIM3:FAIL?

Queries the result of the check for limit line 3 in window 2.

Usage:

Query only
 SCPI confirmed

CALCulate<n>:LIMit<k>:STATe <State>

This command turns the limit check for a specific limit line on and off.

To query the limit check result, use [CALCulate<n>:LIMit<k>:FAIL?](#).

Note that a new command exists to activate the limit check and define the trace to be checked in one step (see [CALCulate<n>:LIMit<k>:TRACe<t>:CHECK](#) on page 182).

Suffix:

<n> irrelevant

<k> [Limit line](#)

Parameters:

<State> ON | OFF
 *RST: OFF

Example:

CALC:LIM:STAT ON

Switches on the limit check for limit line 1.

Usage:

SCPI confirmed

Manual operation: See "[Disable All Lines](#)" on page 94

CALCulate<n>:LIMit<k>:TRACe <TraceNumber>

This command links a limit line to one or more traces.

Note that this command is maintained for compatibility reasons only. Limit lines no longer need to be assigned to a trace explicitly. The trace to be checked can be defined directly (as a suffix) in the new command to activate the limit check (see [CALCulate<n>:LIMit<k>:TRACe<t>:CHECK](#) on page 182).

Suffix:`<n>` [Window](#)`<k>` [Limit line](#)**Parameters:**`<TraceNumber>` 1 to 4`*RST:` 1**Example:**`CALC:LIM2:TRAC 3`

Assigns limit line 2 to trace 3.

CALCulate<n>:LIMit<k>:TRACe<t>:CHECK <State>

This command turns the limit check for a specific trace on and off.

To query the limit check result, use [CALCulate<n>:LIMit<k>:FAIL?](#).

Note that this command replaces the two commands from previous signal and spectrum analyzers (which are still supported, however):

- [CALCulate<n>:LIMit<k>:TRACe](#) on page 181
- [CALCulate<n>:LIMit<k>:STATe](#) on page 181

Suffix:`<n>` [Window](#)`<k>` [Limit line](#)`<t>` [Trace](#)**Parameters:**`<State>` ON | OFF`*RST:` OFF**Example:**`CALC:LIM3:TRAC2:CHEC ON`

Switches on the limit check for limit line 3 on trace 2.

Manual operation: See "[Traces to be Checked](#)" on page 94

7.18 Working with Markers

The following commands are necessary to work with markers.

- [Using Markers](#)..... 183
- [Using Delta Markers](#)..... 185
- [Configuring Markers](#)..... 188
- [Positioning Markers](#)..... 189
- [Positioning Delta Markers](#)..... 192

7.18.1 Using Markers

Note that the suffix at `CALCulate` has an effect only if you query the characteristics of a marker. If you set a marker, you can ignore the suffix because the markers are linked to each other over all measurement windows and will always be on the same frequency.

<code>CALCulate<n>:MARKer<m>:AOFF</code>	183
<code>CALCulate<n>:MARKer<m>[:STATe]</code>	183
<code>CALCulate<n>:MARKer<m>:TRACe</code>	183
<code>CALCulate<n>:MARKer<m>:X</code>	184
<code>CALCulate<n>:MARKer<m>:Y?</code>	184

`CALCulate<n>:MARKer<m>:AOFF`

This command turns all markers off.

Suffix:

<n> Window

<m> Marker

Example: `CALC:MARK:AOFF`
Switches off all markers.

Usage: Event

Manual operation: See "[All Markers Off](#)" on page 89

`CALCulate<n>:MARKer<m>[:STATe] <State>`

This command turns markers on and off. If the corresponding marker number is currently active as a deltamarker, it is turned into a normal marker.

Suffix:

<n> Window

<m> Marker

Parameters:

<State> ON | OFF

*RST: OFF

Example: `CALC:MARK3 ON`
Switches on marker 3.

Manual operation: See "[Marker Type](#)" on page 89

`CALCulate<n>:MARKer<m>:TRACe <Trace>`

This command selects the trace the marker is positioned on.

Note that the corresponding trace must have a trace mode other than "Blank".

If necessary, the command activates the marker first.

Suffix:<n> [Window](#)<m> [Marker](#)**Parameters:**<Trace> **1 to 4**

Trace number the marker is assigned to.

Example:`CALC:MARK3:TRAC 2`

Assigns marker 3 to trace 2.

CALCulate<n>:MARKer<m>:X <Position>

This command moves a marker to a particular coordinate on the x-axis.

If necessary, the command activates the marker.

If the marker has been used as a delta marker, the command turns it into a normal marker.

Note that markers have to be positioned on a discrete frequency that is part of the frequency list. If you set the marker on a frequency not included in the frequency list, the application positions the marker to the nearest frequency in the list (rounding up or down).

Suffix:<m> [Marker](#) (query: 1 to 16)<n> [Window](#)**Parameters:**<Position> Numeric value that defines the marker position on the x-axis.
The unit is Hz.

Range: The range depends on the current x-axis range.

Example:`CALC:MARK2:X 1.7MHz`

Positions marker 2 to frequency 1.7 MHz.

CALCulate<n>:MARKer<m>:Y? <Result>

This command queries the position of a marker on the y-axis.

If necessary, the command activates the marker first.

To get a valid result, you have to perform a complete measurement with synchronization to the end of the measurement before reading out the result. This is only possible for single sweep mode.

See also [INITiate<n>:CONTinuous](#) on page 146.

Suffix:<n> [Window](#)<m> [Marker](#)

Parameters:

<Result>	Selects the result.
CPCold	Queries calibration power (cold) results.
CPHot	Queries calibration power (hot) results.
CYFactor	Queries calibration y-factor results.
GAIN	Queries gain results.
NOISe	Queries noise figure results.
NUNCertainty	Queries the noise figure uncertainty results.
PCOLd	Queries power (cold) results.
PHOT	Queries power (hot) results.
TEMPerature	Queries noise temperature results.
YFACTOR	Queries y-factor results.

Return values:

<Result>	Result at the marker position.
----------	--------------------------------

Example:

```
INIT:CONT OFF
Switches to single measurement mode.
CALC:MARK2 ON
Switches marker 2.
INIT;*WAI
Starts a measurement and waits for the end.
CALC:MARK2:Y?
Outputs the measured value of marker 2.
```

Usage: Query only

Manual operation: See "[Marker Table](#)" on page 22

7.18.2 Using Delta Markers

Note that the suffix at `CALCulate` has an effect only if you query the characteristics of a marker. If you set a marker, you can ignore the suffix because the markers are linked to each other over all measurement windows and will always be on the same frequency.

<code>CALCulate<n>:DELTamarker<m>:AOFF</code>	186
<code>CALCulate<n>:DELTamarker<m>:MREF</code>	186
<code>CALCulate<n>:DELTamarker<m>[:STATE]</code>	186

CALCulate<n>:DELTamarker<m>:TRACe.....	187
CALCulate<n>:DELTamarker<m>:X.....	187
CALCulate<n>:DELTamarker<m>:Y?.....	187

CALCulate<n>:DELTamarker<m>:AOFF

This command turns *all* delta markers off.

Suffix:

<n> Window

<m> irrelevant

Example:

CALC:DELT:AOff
Turns all delta markers off.

Usage: Event

CALCulate<n>:DELTamarker<m>:MREF <Reference>

This command selects a reference marker for a delta marker other than marker 1.

The reference may be another marker or the fixed reference.

Suffix:

<n> Window

<m> Marker

Parameters:

<Reference> **1 to 16**
Selects markers 1 to 16 as the reference.

FIXed

Selects the fixed reference as the reference.

Example:

CALC:DELT3:MREF 2
Specifies that the values of delta marker 3 are relative to marker 2.

CALCulate<n>:DELTamarker<m>[:STATE] <State>

This command turns delta markers on and off.

If necessary, the command activates the delta marker first.

No suffix at DELTmarker turns on delta marker 1.

Suffix:

<n> Window

<m> Marker

Parameters:

<State> ON | OFF
*RST: OFF

Example: `CALC:DELT2 ON`
Turns on delta marker 2.

Manual operation: See "[Marker Type](#)" on page 89

CALCulate<n>:DELTaMarker<m>:TRACe <Trace>

This command selects the trace a delta marker is positioned on.

Note that the corresponding trace must have a trace mode other than "Blank".

If necessary, the command activates the marker first.

Suffix:

<n> [Window](#)

<m> [Marker](#)

Parameters:

<Trace> Trace number the marker is assigned to.

Example: `CALC:DELT2:TRAC 2`
Positions delta marker 2 on trace 2.

CALCulate<n>:DELTaMarker<m>:X <Position>

This command moves a delta marker to a particular coordinate on the x-axis.

If necessary, the command activates the delta marker and positions a reference marker to the peak power.

Suffix:

<m> [Marker](#)

<n> [Window](#)

Parameters:

<Position> Numeric value that defines the marker position on the x-axis.

Range: The value range and unit depend on the measurement and scale of the x-axis.

Example: `CALC:DELT:X?`
Outputs the absolute x-value of delta marker 1.

CALCulate<n>:DELTaMarker<m>:Y? <Result>

This command queries the relative position of a delta marker on the y-axis.

If necessary, the command activates the delta marker first.

To get a valid result, you have to perform a complete measurement with synchronization to the end of the measurement before reading out the result. This is only possible for single sweep mode.

See also [INITiate<n>:CONTinuous](#) on page 146.

The unit depends on the application of the command.

Suffix:

<m> [Marker](#)
 <n> [Window](#)

Parameters:

<Result> Selects the result.

CPCold
 Queries calibration power (cold) results.

CPHot
 Queries calibration power (hot) results.

CYFactor
 Queries calibration y-factor results.

GAIN
 Queries gain results.

NOISe
 Queries noise figure results.

PCOLd
 Queries power (cold) results.

PHOT
 Queries power (hot) results.

TEMPerature
 Queries noise temperature results.

YFACTOR
 Queries y-factor results.

Return values:

<Position> Position of the delta marker in relation to the reference marker or the fixed reference.

Example:

```
INIT:CONT OFF
Switches to single sweep mode.
INIT;*WAI
Starts a sweep and waits for its end.
CALC:DELT2 ON
Switches on delta marker 2.
CALC:DELT2:Y?
Outputs measurement value of delta marker 2.
```

Usage: Query only

Manual operation: See "[Marker Table](#)" on page 22

7.18.3 Configuring Markers

[DISPlay:MINFo\[:STAT\]](#)..... 189
[DISPlay:MTABLE](#)..... 189

DISPlay:MINFo[:STAT] <DisplayMode>

This command turns the marker information in all diagrams on and off.

Parameters:

<DisplayMode> **ON**
 Displays the marker information in the diagrams.

OFF
 Hides the marker information in the diagrams.

*RST: ON

Example: DISP:MINF OFF
 Hides the marker information.

Manual operation: See "[Marker Info](#)" on page 90

DISPlay:MTABLE <DisplayMode>

This command turns the marker table on and off.

Parameters:

<DisplayMode> **ON**
 Turns the marker table on.

OFF
 Turns the marker table off.

AUTO
 Turns the marker table on if 3 or more markers are active.

*RST: AUTO

Example: DISP:MTAB ON
 Activates the marker table.

Manual operation: See "[Marker Table Display](#)" on page 90

7.18.4 Positioning Markers

If you are using more than one window, the application performs the peak search in the window that you have selected with the suffix at `CALCulate` only. Because the markers are linked, the frequency position of the marker in the other windows is adjusted accordingly, even if it means that the marker is on a peak in the selected window only.

<code>CALCulate<n>:MARKer<m>:MAXimum:LEFT</code>	190
<code>CALCulate<n>:MARKer<m>:MAXimum:NEXT</code>	190
<code>CALCulate<n>:MARKer<m>:MAXimum[:PEAK]</code>	190
<code>CALCulate<n>:MARKer<m>:MAXimum:RIGHT</code>	190
<code>CALCulate<n>:MARKer<m>:MINimum:NEXT</code>	191
<code>CALCulate<n>:MARKer<m>:MINimum:LEFT</code>	191
<code>CALCulate<n>:MARKer<m>:MINimum[:PEAK]</code>	191
<code>CALCulate<n>:MARKer<m>:MINimum:RIGHT</code>	191

CALCulate<n>:MARKer<m>:MAXimum:LEFT

This command moves a marker to the next lower peak.

The search includes only measurement values to the left of the current marker position.

Suffix:

<n> [Window](#)

<m> [Marker](#)

Usage: Event

Manual operation: See "[Search Next Peak](#)" on page 91

CALCulate<n>:MARKer<m>:MAXimum:NEXT

This command moves a marker to the next lower peak.

Suffix:

<n> [Window](#)

<m> [Marker](#)

Usage: Event

Manual operation: See "[Search Next Peak](#)" on page 91

CALCulate<n>:MARKer<m>:MAXimum[:PEAK]

This command moves a marker to the highest level.

If the marker is not yet active, the command first activates the marker.

Suffix:

<n> [Window](#)

<m> [Marker](#)

Usage: Event

Manual operation: See "[Peak Search](#)" on page 91

CALCulate<n>:MARKer<m>:MAXimum:RIGHT

This command moves a marker to the next lower peak.

The search includes only measurement values to the right of the current marker position.

Suffix:

<n> [Window](#)

<m> [Marker](#)

Usage: Event

Manual operation: See ["Search Next Peak"](#) on page 91

CALCulate<n>:MARKer<m>:MINimum:NEXT

This command moves a marker to the next minimum value.

Suffix:

<n> [Window](#)

<m> [Marker](#)

Usage: Event

Manual operation: See ["Search Next Minimum"](#) on page 92

CALCulate<n>:MARKer<m>:MINimum:LEFT

This command moves a marker to the next minimum value.

The search includes only measurement values to the right of the current marker position.

Suffix:

<n> [Window](#)

<m> [Marker](#)

Usage: Event

Manual operation: See ["Search Next Minimum"](#) on page 92

CALCulate<n>:MARKer<m>:MINimum[:PEAK]

This command moves a marker to the minimum level.

If the marker is not yet active, the command first activates the marker.

Suffix:

<n> [Window](#)

<m> [Marker](#)

Usage: Event

Manual operation: See ["Search Minimum"](#) on page 91

CALCulate<n>:MARKer<m>:MINimum:RIGHT

This command moves a marker to the next minimum value.

The search includes only measurement values to the right of the current marker position.

Suffix:

<n> [Window](#)

<m>	Marker
Usage:	Event
Manual operation:	See " Search Next Minimum " on page 92

7.18.5 Positioning Delta Markers

If you are using more than one window, the application performs the peak search in the window that you have selected with the suffix at `CALCulate` only. Because the markers are linked, the frequency position of the marker in the other windows is adjusted accordingly, even if it means that the marker is on a peak in the selected window only.

CALCulate<n>:DELTamarker<m>:MAXimum:LEFT	192
CALCulate<n>:DELTamarker<m>:MAXimum:NEXT	192
CALCulate<n>:DELTamarker<m>:MAXimum[:PEAK]	192
CALCulate<n>:DELTamarker<m>:MAXimum:RIGHT	193
CALCulate<n>:DELTamarker<m>:MINimum:LEFT	193
CALCulate<n>:DELTamarker<m>:MINimum:NEXT	193
CALCulate<n>:DELTamarker<m>:MINimum[:PEAK]	194
CALCulate<n>:DELTamarker<m>:MINimum:RIGHT	194

CALCulate<n>:DELTamarker<m>:MAXimum:LEFT

This command moves a delta marker to the next higher value.

The search includes only measurement values to the left of the current marker position.

Suffix:	
<n>	Window
<m>	Marker
Usage:	Event
Manual operation:	See " Search Next Peak " on page 91

CALCulate<n>:DELTamarker<m>:MAXimum:NEXT

This command moves a marker to the next higher value.

Suffix:	
<n>	Window
<m>	Marker
Usage:	Event
Manual operation:	See " Search Next Peak " on page 91

CALCulate<n>:DELTamarker<m>:MAXimum[:PEAK]

This command moves a delta marker to the highest level.

If the marker is not yet active, the command first activates the marker.

Suffix:

<n> [Window](#)

<m> [Marker](#)

Usage: Event

Manual operation: See "[Peak Search](#)" on page 91

CALCulate<n>:DELTamarker<m>:MAXimum:RIGHT

This command moves a delta marker to the next higher value.

The search includes only measurement values to the right of the current marker position.

Suffix:

<n> [Window](#)

<m> [Marker](#)

Usage: Event

Manual operation: See "[Search Next Peak](#)" on page 91

CALCulate<n>:DELTamarker<m>:MINimum:LEFT

This command moves a delta marker to the next higher minimum value.

The search includes only measurement values to the right of the current marker position.

Suffix:

<n> [Window](#)

<m> [Marker](#)

Usage: Event

Manual operation: See "[Search Next Minimum](#)" on page 92

CALCulate<n>:DELTamarker<m>:MINimum:NEXT

This command moves a marker to the next higher minimum value.

Suffix:

<n> [Window](#)

<m> [Marker](#)

Usage: Event

Manual operation: See "[Search Next Minimum](#)" on page 92

CALCulate<n>:DELTamarker<m>:MINimum[:PEAK]

This command moves a delta marker to the minimum level.

If the marker is not yet active, the command first activates the marker.

Suffix:

<n> [Window](#)

<m> [Marker](#)

Usage: Event

Manual operation: See "[Search Minimum](#)" on page 91

CALCulate<n>:DELTamarker<m>:MINimum:RIGHT

This command moves a delta marker to the next higher minimum value.

The search includes only measurement values to the right of the current marker position.

Suffix:

<n> [Window](#)

<m> [Marker](#)

Usage: Event

Manual operation: See "[Search Next Minimum](#)" on page 92

7.19 Using the Status Register

The status reporting system stores information about the current state of the R&S FSW. This includes, for example, information about errors during operation or information about limit checks. The R&S FSW stores this information in the status registers and in the error queue. You can query the status register and error queue via IEC bus.

The R&S FSW-K30 features several status registers that are specific to noise figure measurements. Here is a description of those, including the corresponding remote commands.

- [Status Registers for Noise Figure Measurements](#)..... 194

7.19.1 Status Registers for Noise Figure Measurements

The figure below shows the status registers of the noise figure application.

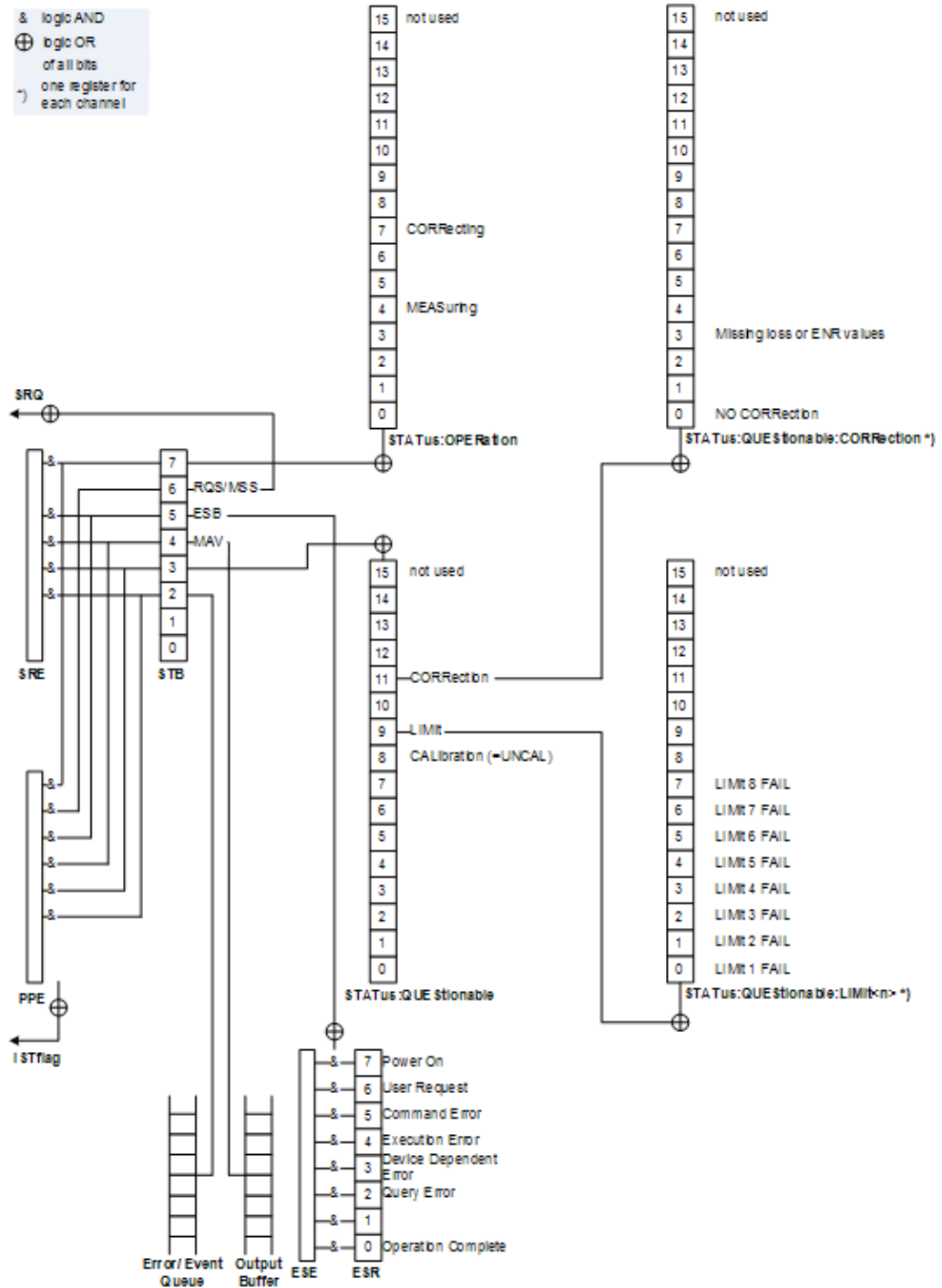

Figure 7-2: Status registers for noise figure measurements

The R&S FSW structures the information hierarchically, with the Status Byte register (STB) and the Service Request Enable mask register (SRE) being on the highest level. The STB gets its information from the standard Event Status Register (ESR) and the Event Status Enable mask register (ESE). The STB and ESR are both defined by IEEE 488.2. In addition to the ESR, the STB also gets information from the STATUS:OPERation and STATUS:QUEStionable registers. These are the link to the lower levels of the

status register and are defined by SCPI. They contain information about the state of the instrument.

For a more comprehensive description of the status registers not mentioned here and status register functionality in general see the manual of the base unit.

7.19.1.1 STATus:OPERation Register

The STATus:OPERation register contains information on current activities of the R&S FSW. It also contains information on activities that have been executed since the last read out.

Bit no	Meaning
0 to 3	Unavailable for noise figure measurements.
4	MEASuring This bit is set if a measurement is in progress.
5 to 6	Unavailable for noise figure measurements.
7	CORReCting This bit is set if a 2nd stage correction is in progress.
8	HCOPy This bit is set if a hardcopy is created.
9 - 14	Unavailable for noise figure measurements.
15	This bit is always 0.

7.19.1.2 STATus:QUEStionable Register

The STATus:QUEStionable register contains information about indefinite states which may occur if the unit is operated without meeting the specifications.

Bit no	Meaning
0 to 7	Unavailable for noise figure measurements.
8	CALibration This bit is set if the R&S FSW is not calibrated.
9	LIMit This bit is set if a limit line is violated.
10	Unavailable for noise figure measurements.
11	CORRection This bit is set if the noise figure calibration is questionable.
14	Unavailable for noise figure measurements.
15	This bit is always 0.

7.19.1.3 STATus:QUEStionable:LIMit Register

The `STATus:QUEStionable:LIMit` register contains information about limit lines and the results of a limit checks.

The number of LIMit registers depends on the number of measurement windows available in any application.

Bit no	Meaning
0	LIMit 1 FAIL This bit is set if limit line 1 is violated.
1	LIMit 2 FAIL This bit is set if limit line 2 is violated.
2	LIMit 3 FAIL This bit is set if limit line 3 is violated.
3	LIMit 4 FAIL This bit is set if limit line 4 is violated.
4	LIMit 5 FAIL This bit is set if limit line 5 is violated.
5	LIMit 6 FAIL This bit is set if limit line 6 is violated.
6	LIMit 7 FAIL This bit is set if limit line 7 is violated.
7	LIMit 8 FAIL This bit is set if limit line 8 is violated.
8 to 14	Unavailable for noise figure measurements.
15	This bit is always 0.

7.19.1.4 STATus:QUEStionable:CORRection Register

The `STATus:QUEStionable:CORRection` register contains information about the calibration status of noise figure measurements.

Bit no	Meaning
0	NO CORRection This bit is set if calibration is required.
1 to 2	Unavailable for noise figure measurements.
3	Missing Loss or ENR values This bit is set if loss or ENR values are missing for one or more measurement frequencies.

Bit no	Meaning
4 to 14	Unavailable for noise figure measurements.
15	This bit is always 0.

7.19.1.5 Status Register Remote Commands

STATus:OPERation[:EVENT]?	198
STATus:QUESTionable[:EVENT]?	198
STATus:QUESTionable:CORRection[:EVENT]?	198
STATus:QUESTionable:LIMit[:EVENT]?	198
STATus:OPERation:CONDition?	198
STATus:QUESTionable:CONDition?	198
STATus:QUESTionable:CORRection:CONDition?	198
STATus:QUESTionable:LIMit:CONDition?	198
STATus:OPERation:ENABle	199
STATus:QUESTionable:ENABle	199
STATus:QUESTionable:CORRection:ENABle	199
STATus:QUESTionable:LIMit:ENABle	199
STATus:OPERation:NTRansition	199
STATus:QUESTionable:NTRansition	199
STATus:QUESTionable:CORRection:NTRansition	199
STATus:QUESTionable:LIMit:NTRansition	199
STATus:OPERation:PTRansition	199
STATus:QUESTionable:PTRansition	199
STATus:QUESTionable:CORRection:PTRansition	199
STATus:QUESTionable:LIMit:PTRansition	199

STATus:OPERation[:EVENT]?

STATus:QUESTionable[:EVENT]?

STATus:QUESTionable:CORRection[:EVENT]? <ChannelName>

STATus:QUESTionable:LIMit[:EVENT]? <ChannelName>

These commands read out the EVENT section of the status register.

The commands at the same time delete the contents of the EVENT section.

Query parameters:

<ChannelName> String containing the name of the channel.
The parameter is optional. If you omit it, the command works for the currently active channel.

Usage: Query only

STATus:OPERation:CONDition?

STATus:QUESTionable:CONDition?

STATus:QUESTionable:CORRection:CONDition? <ChannelName>

STATus:QUESTionable:LIMit:CONDition? <ChannelName>

These commands read out the CONDition section of the status register.

The commands do not delete the contents of the EVENT section.

Query parameters:

<ChannelName> String containing the name of the channel.
The parameter is optional. If you omit it, the command works for the currently active channel.

Usage: Query only

STATus:OPERation:ENABLE <SumBit>,<ChannelName>

STATus:QUESTionable:ENABLE <SumBit>,<ChannelName>

STATus:QUESTionable:CORRection:ENABLE <SumBit>,<ChannelName>

STATus:QUESTionable:LIMit:ENABLE <SumBit>,<ChannelName>

These commands control the ENABLE part of a register.

The ENABLE part allows true conditions in the EVENT part of the status register to be reported in the summary bit. If a bit is 1 in the enable register and its associated event bit transitions to true, a positive transition will occur in the summary bit reported to the next higher level.

Parameters:

<SumBit> Range: 0 to 65535

<ChannelName> String containing the name of the channel.
The parameter is optional. If you omit it, the command works for the currently active channel.

STATus:OPERation:NTRansition <SumBit>,<ChannelName>

STATus:QUESTionable:NTRansition <SumBit>,<ChannelName>

STATus:QUESTionable:CORRection:NTRansition <SumBit>,<ChannelName>

STATus:QUESTionable:LIMit:NTRansition <SumBit>,<ChannelName>

These commands control the Negative TRansition part of a register.

Setting a bit causes a 1 to 0 transition in the corresponding bit of the associated register. The transition also writes a 1 into the associated bit of the corresponding EVENT register.

Parameters:

<SumBit> Range: 0 to 65535

<ChannelName> String containing the name of the channel.
The parameter is optional. If you omit it, the command works for the currently active channel.

STATus:OPERation:PTRansition <SumBit>,<ChannelName>

STATus:QUESTionable:PTRansition <SumBit>,<ChannelName>

STATus:QUESTionable:CORRection:PTRansition <SumBit>,<ChannelName>

STATus:QUESTionable:LIMit:PTRansition <SumBit>,<ChannelName>

These commands control the Positive TRansition part of a register.

Setting a bit causes a 0 to 1 transition in the corresponding bit of the associated register. The transition also writes a 1 into the associated bit of the corresponding EVENT register.

Parameters:

<SumBit> Range: 0 to 65535

<ChannelName> String containing the name of the channel.
The parameter is optional. If you omit it, the command works for the currently active channel.

7.20 Deprecated Remote Commands for Noise Figure Measurements

Following is a list of deprecated remote commands. The remote commands are still supported to maintain compatibility to previous versions of noise figure measurements (like the R&S FSV-K30), but it is strongly recommended to use the command system in the way it is meant to be used in the R&S FSW-K30.

Legacy command	Replaced by	Comment
CALCulate:LIMit:TRACe	CALCulate:LIMit:TYPE	Parameters NFIGure, TEFFective and GAIN were supported to assign a limit line to a result and thus the trace because trace and result type were fix. CALCulate:LIMit:TRACe now assigns the limit line to a trace (1 to 4).
CALCulate:MARKer:TRACe CALCulate:DELTaMarker:TRACe		The parameters NOISe, GAIN, NMEM1-3 and GMEM1-3 have been replaced by 1 2 3 4 because no distinction is made between memory and live trace.
CONFigure:ARRay:MEMory	TRACe:COPI	No more distinction between memory and live traces.
CONFigure:SINGle	CONFigure:FREQuency:SINGle	
DISPlay:ARRay:MEMory:STATe DISPlay:CURREnt:DATA:STATe	DISPlay:WINDow:TRACe:STATe	No more distinction between memory and live traces.
DISPlay:DATA:TRACe	LAYout system	
DISPlay:FORMat	---	Functionality not supported any more.
DISPlay:WINDow:TABLe	LAYout:WINDow:REPLace / LAYout:REPLace:WINDow	
FETCH: command system	TRACe:DATA	
SENSe:SWEp:POINTs	SENSe:FREQuency:POINTs	
SENSe:FREQuency:CW:FIXed	SENSe:FREQuency:SINGle	
SENSe:FREQuency:LIST:DATA	SENSe:FREQuency:TABLe:DATA	Frequency table only requires RF frequencies on R&S FSW.

Deprecated Remote Commands for Noise Figure Measurements

Legacy command	Replaced by	Comment
SENSe:CONFigure:MODE:SYSTem: LOSCillator	SENSe:CONFigure:MODE: SYSTem:LO	
SENSe:CONFigure:MODE:SYSTem: LOSCillator:FREQuency	SENSe:CONFigure:MODE: SYSTem:LO:FREQuency	

List of Remote Commands (Noise Figure)

[SENSe:]BANDwidth[:RESolution].....	135
[SENSe:]CONFigure:CONTRol.....	149
[SENSe:]CONFigure:CORRection.....	133
[SENSe:]CONFigure:FREQuency:CONTInuous.....	116
[SENSe:]CONFigure:FREQuency:SINGLE.....	116
[SENSe:]CONFigure:LIST:CONTInuous.....	117
[SENSe:]CONFigure:LIST:SINGLE.....	117
[SENSe:]CONFigure:MEASurement.....	149
[SENSe:]CONFigure:MODE:DUT.....	121
[SENSe:]CONFigure:MODE:SYSTem:IF:FREQuency.....	120
[SENSe:]CONFigure:MODE:SYSTem:LO.....	120
[SENSe:]CONFigure:MODE:SYSTem:LO:FREQuency.....	120
[SENSe:]CORRection:CVL:BAND.....	153
[SENSe:]CORRection:CVL:BIAS.....	153
[SENSe:]CORRection:CVL:CATAlog?.....	154
[SENSe:]CORRection:CVL:CLEAr.....	154
[SENSe:]CORRection:CVL:COMMeNt.....	154
[SENSe:]CORRection:CVL:DATA.....	154
[SENSe:]CORRection:CVL:HARMonic.....	155
[SENSe:]CORRection:CVL:MIXer.....	155
[SENSe:]CORRection:CVL:PORTs.....	156
[SENSe:]CORRection:CVL:SELeCt.....	156
[SENSe:]CORRection:CVL:SNUMber.....	156
[SENSe:]CORRection:ENR:CALibration:MODE.....	123
[SENSe:]CORRection:ENR:CALibration:SPOT.....	123
[SENSe:]CORRection:ENR:CALibration:SPOT:COLD.....	122
[SENSe:]CORRection:ENR:CALibration:SPOT:HOT.....	122
[SENSe:]CORRection:ENR:CALibration:TABLE:SELeCt.....	123
[SENSe:]CORRection:ENR:CALibration:TYPE.....	124
[SENSe:]CORRection:ENR:COMMon.....	124
[SENSe:]CORRection:ENR[:MEASurement]:MODE.....	127
[SENSe:]CORRection:ENR[:MEASurement]:SPOT.....	127
[SENSe:]CORRection:ENR[:MEASurement]:SPOT:COLD.....	128
[SENSe:]CORRection:ENR[:MEASurement]:SPOT:HOT.....	129
[SENSe:]CORRection:ENR[:MEASurement]:TABLE:DATA.....	124
[SENSe:]CORRection:ENR[:MEASurement]:TABLE:DELeTe.....	125
[SENSe:]CORRection:ENR[:MEASurement]:TABLE:LIST?.....	125
[SENSe:]CORRection:ENR[:MEASurement]:TABLE:SELeCt.....	126
[SENSe:]CORRection:ENR[:MEASurement]:TABLE:TEMPerature:DELeTe.....	127
[SENSe:]CORRection:ENR[:MEASurement]:TABLE:TEMPerature:LIST?.....	127
[SENSe:]CORRection:ENR[:MEASurement]:TABLE:TEMPerature[:DATA].....	126
[SENSe:]CORRection:ENR[:MEASurement]:TYPE.....	128
[SENSe:]CORRection:IREJection.....	121
[SENSe:]CORRection:LOSS:INPut:MODE.....	130
[SENSe:]CORRection:LOSS:INPut:SPOT.....	130
[SENSe:]CORRection:LOSS:INPut:TABLE.....	130
[SENSe:]CORRection:LOSS:INPut:TABLE:DELeTe.....	131

[SENSe:]CORRection:LOSS:INPut:TABLE:SElect.....	131
[SENSe:]CORRection:LOSS:OUTPut:MODE.....	131
[SENSe:]CORRection:LOSS:OUTPut:SPOT.....	131
[SENSe:]CORRection:LOSS:OUTPut:TABLE.....	132
[SENSe:]CORRection:LOSS:OUTPut:TABLE:DELeTe.....	132
[SENSe:]CORRection:LOSS:OUTPut:TABLE:SElect.....	133
[SENSe:]CORRection:TEMPerature.....	129
[SENSe:]CORRection[:STATe].....	135
[SENSe:]FREQuency:CENTer.....	117
[SENSe:]FREQuency:SINGle.....	118
[SENSe:]FREQuency:SINGle:COUPling.....	118
[SENSe:]FREQuency:SPAN.....	118
[SENSe:]FREQuency:STARt.....	119
[SENSe:]FREQuency:STEP.....	119
[SENSe:]FREQuency:STOP.....	119
[SENSe:]FREQuency:TABLE:DATA.....	117
[SENSe:]MIXer:BIAS:HIGH.....	157
[SENSe:]MIXer:BIAS[:LOW].....	157
[SENSe:]MIXer:FREQuency:HANDOver.....	157
[SENSe:]MIXer:FREQuency:STARt?.....	157
[SENSe:]MIXer:FREQuency:STOP?.....	158
[SENSe:]MIXer:HARMonic:BAND:PRESet.....	158
[SENSe:]MIXer:HARMonic:BAND[:VALue].....	158
[SENSe:]MIXer:HARMonic:HIGH:STATe.....	159
[SENSe:]MIXer:HARMonic:HIGH[:VALue].....	159
[SENSe:]MIXer:HARMonic:TYPE.....	159
[SENSe:]MIXer:HARMonic[:LOW].....	160
[SENSe:]MIXer:LOPower.....	160
[SENSe:]MIXer:LOSS:HIGH.....	161
[SENSe:]MIXer:LOSS:TABLE:HIGH.....	161
[SENSe:]MIXer:LOSS:TABLE[:LOW].....	161
[SENSe:]MIXer:LOSS[:LOW].....	161
[SENSe:]MIXer:PORTs.....	162
[SENSe:]MIXer:RFOVerrange[:STATe].....	162
[SENSe:]MIXer:SIGNal.....	160
[SENSe:]MIXer:THReshold.....	162
[SENSe:]MIXer[:STATe].....	162
[SENSe:]SWEEp:COUNT.....	136
[SENSe:]SWEEp:POINts.....	118
[SENSe:]SWEEp:TIME.....	136
ABORT.....	146
CALCulate:LIMit<k>:TYPE.....	175
CALCulate:UNCertainty:COMMon.....	138
CALCulate:UNCertainty:DATA:FREQuency.....	138
CALCulate:UNCertainty:DATA:GAIN.....	138
CALCulate:UNCertainty:DATA:NOISe.....	138
CALCulate:UNCertainty:DATA:RESUltS.....	139
CALCulate:UNCertainty:ENR:CALibration:UNCertainty.....	139
CALCulate:UNCertainty:ENR:CALibration:UNCertainty:COLD.....	139
CALCulate:UNCertainty:ENR:CALibration:UNCertainty:HOT.....	140

CALCulate:UNCertainty:ENR:UNCertainty.....	140
CALCulate:UNCertainty:ENR:UNCertainty:COLD.....	140
CALCulate:UNCertainty:ENR:UNCertainty:HOT.....	141
CALCulate:UNCertainty:MATCh:DUT:IN:[VSWR].....	141
CALCulate:UNCertainty:MATCh:DUT:IN:RL.....	141
CALCulate:UNCertainty:MATCh:DUT:OUT:[VSWR].....	142
CALCulate:UNCertainty:MATCh:DUT:OUT:RL.....	142
CALCulate:UNCertainty:MATCh:PREamp:RL.....	142
CALCulate:UNCertainty:MATCh:PREamp:[VSWR].....	142
CALCulate:UNCertainty:MATCh:SOURce:CALibration:RL.....	143
CALCulate:UNCertainty:MATCh:SOURce:CALibration:[VSWR].....	142
CALCulate:UNCertainty:MATCh:SOURce:RL.....	143
CALCulate:UNCertainty:MATCh:SOURce:[VSWR].....	143
CALCulate:UNCertainty:PREamp:GAIN.....	144
CALCulate:UNCertainty:PREamp:NOISe.....	144
CALCulate:UNCertainty:PREamp:STATe.....	144
CALCulate:UNCertainty:SANalyzer:GAIN:UNCertainty?.....	145
CALCulate:UNCertainty:SANalyzer:NOISe:UNCertainty?.....	145
CALCulate:UNCertainty:[RESult]?.....	144
CALCulate<n>:DELTamarker<m>:AOFF.....	186
CALCulate<n>:DELTamarker<m>:MAXimum:LEFT.....	192
CALCulate<n>:DELTamarker<m>:MAXimum:NEXT.....	192
CALCulate<n>:DELTamarker<m>:MAXimum:RIGHT.....	193
CALCulate<n>:DELTamarker<m>:MAXimum:[PEAK].....	192
CALCulate<n>:DELTamarker<m>:MINimum:LEFT.....	193
CALCulate<n>:DELTamarker<m>:MINimum:NEXT.....	193
CALCulate<n>:DELTamarker<m>:MINimum:RIGHT.....	194
CALCulate<n>:DELTamarker<m>:MINimum:[PEAK].....	194
CALCulate<n>:DELTamarker<m>:MREF.....	186
CALCulate<n>:DELTamarker<m>:TRACe.....	187
CALCulate<n>:DELTamarker<m>:X.....	187
CALCulate<n>:DELTamarker<m>:Y?.....	187
CALCulate<n>:DELTamarker<m>:[STATe].....	186
CALCulate<n>:LIMit<k>:ACTive?.....	179
CALCulate<n>:LIMit<k>:CLEar:[IMMediate].....	180
CALCulate<n>:LIMit<k>:COMMeNt.....	174
CALCulate<n>:LIMit<k>:CONTRol:SHIFt.....	176
CALCulate<n>:LIMit<k>:CONTRol:[DATA].....	176
CALCulate<n>:LIMit<k>:COPY.....	179
CALCulate<n>:LIMit<k>:DELeTe.....	180
CALCulate<n>:LIMit<k>:FAIL?.....	180
CALCulate<n>:LIMit<k>:LOWer:SHIFt.....	177
CALCulate<n>:LIMit<k>:LOWer:STATe.....	177
CALCulate<n>:LIMit<k>:LOWer:[DATA].....	177
CALCulate<n>:LIMit<k>:NAME.....	175
CALCulate<n>:LIMit<k>:STATe.....	181
CALCulate<n>:LIMit<k>:TRACe.....	181
CALCulate<n>:LIMit<k>:TRACe<t>:CHECK.....	182
CALCulate<n>:LIMit<k>:UPPer:SHIFt.....	178
CALCulate<n>:LIMit<k>:UPPer:STATe.....	179

CALCulate<n>:LIMit<k>:UPPER[:DATA].....	178
CALCulate<n>:MARKer<m>:AOFF.....	183
CALCulate<n>:MARKer<m>:MAXimum:LEFT.....	190
CALCulate<n>:MARKer<m>:MAXimum:NEXT.....	190
CALCulate<n>:MARKer<m>:MAXimum:RIGHT.....	190
CALCulate<n>:MARKer<m>:MAXimum[:PEAK].....	190
CALCulate<n>:MARKer<m>:MINimum:LEFT.....	191
CALCulate<n>:MARKer<m>:MINimum:NEXT.....	191
CALCulate<n>:MARKer<m>:MINimum:RIGHT.....	191
CALCulate<n>:MARKer<m>:MINimum[:PEAK].....	191
CALCulate<n>:MARKer<m>:TRACe.....	183
CALCulate<n>:MARKer<m>:X.....	184
CALCulate<n>:MARKer<m>:Y?.....	184
CALCulate<n>:MARKer<m>[:STATe].....	183
DISPlay:FORMat.....	113
DISPlay:MINFo[:STAT].....	189
DISPlay:MTABLE.....	189
DISPlay[:WINDow<n>]:SIZE.....	114
DISPlay[:WINDow<n>]:TABLE:ITEM.....	167
DISPlay[:WINDow<n>]:TRACe:SYMBols.....	167
DISPlay[:WINDow<n>]:TRACe:X[:SCALe].....	167
DISPlay[:WINDow<n>]:TRACe:Y[:SCALe]:AUTO.....	168
DISPlay[:WINDow<n>]:TRACe<t>:MODE.....	170
DISPlay[:WINDow<n>]:TRACe<t>:Y[:SCALe]:BOTTOm.....	168
DISPlay[:WINDow<n>]:TRACe<t>:Y[:SCALe]:RLEVel.....	133
DISPlay[:WINDow<n>]:TRACe<t>:Y[:SCALe]:RLEVel:AUTO.....	134
DISPlay[:WINDow<n>]:TRACe<t>:Y[:SCALe]:TOP.....	169
DISPlay[:WINDow<n>]:TRACe<t>[:STATe].....	170
FORMat:DEXPort:DSEParator.....	171
FORMat:DEXPort:HEADer.....	171
FORMat:DEXPort:TRACes.....	172
FORMat[:DATA].....	171
INITiate<n>:CONTInuous.....	146
INITiate<n>:SEQuencer:ABORt.....	147
INITiate<n>:SEQuencer:IMMediate.....	147
INITiate<n>:SEQuencer:MODE.....	148
INITiate<n>[:IMMediate].....	147
INPut:ATTenuation.....	134
INPut:COUPLing.....	150
INPut:FILTer:HPASs[:STATe].....	151
INPut:FILTer:YIG[:STATe].....	152
INPut:GAIN:STATe.....	135
INPut:GAIN[:VALue].....	134
INPut:IMPedance.....	151
INSTRument:CREate:DUPLicate.....	103
INSTRument:CREate:REPLace.....	104
INSTRument:CREate[:NEW].....	103
INSTRument:DELeTe.....	104
INSTRument:LIST?.....	104
INSTRument:REName.....	106

INSTrument[:SElect].....	106
LAYout:ADD[:WINDow]?.....	107
LAYout:CATalog[:WINDow]?.....	109
LAYout:IDENtify[:WINDow]?.....	109
LAYout:REMOve[:WINDow].....	109
LAYout:REPLace[:WINDow].....	110
LAYout:SPLitter.....	110
LAYout:WINDow<n>:ADD?.....	112
LAYout:WINDow<n>:IDENtify?.....	112
LAYout:WINDow<n>:REMOve.....	113
LAYout:WINDow<n>:REPLace.....	113
MMEMory:STORe<n>:TRACe.....	172
SOURce:EXTernal:FREQuency:OFFSet<offset>.....	163
SOURce:EXTernal:FREQuency[:FACTor]:DENominator.....	163
SOURce:EXTernal:FREQuency[:FACTor]:NUMerator.....	163
SOURce:EXTernal:POWer[:LEVel].....	164
SOURce:EXTernal:ROSCillator[:SOURce].....	164
STATus:OPERation:CONDition?.....	198
STATus:OPERation:ENABle.....	199
STATus:OPERation:NTRansition.....	199
STATus:OPERation:PTRansition.....	199
STATus:OPERation[:EVENT]?.....	198
STATus:QUESTionable:CONDition?.....	198
STATus:QUESTionable:CORRection:CONDition?.....	198
STATus:QUESTionable:CORRection:ENABle.....	199
STATus:QUESTionable:CORRection:NTRansition.....	199
STATus:QUESTionable:CORRection:PTRansition.....	199
STATus:QUESTionable:CORRection[:EVENT]?.....	198
STATus:QUESTionable:ENABle.....	199
STATus:QUESTionable:LIMit:CONDition?.....	198
STATus:QUESTionable:LIMit:ENABle.....	199
STATus:QUESTionable:LIMit:NTRansition.....	199
STATus:QUESTionable:LIMit:PTRansition.....	199
STATus:QUESTionable:LIMit[:EVENT]?.....	198
STATus:QUESTionable:NTRansition.....	199
STATus:QUESTionable:PTRansition.....	199
STATus:QUESTionable[:EVENT]?.....	198
SYSTem:COMMunicate:GPIB:RDEvice:GENerator:ADDRess.....	164
SYSTem:COMMunicate:RDEvice:GENerator:INTERface.....	165
SYSTem:COMMunicate:RDEvice:GENerator:TYPE.....	165
SYSTem:COMMunicate:TCPip:RDEvice:GENerator:ADDRess.....	165
SYSTem:CONFigure:DUT:GAIN.....	136
SYSTem:CONFigure:DUT:STIMe.....	137
SYSTem:CONFigure:GENerator:CONTRol:STATe.....	165
SYSTem:CONFigure:GENerator:INITialise:AUTO.....	166
SYSTem:CONFigure:GENerator:INITialise:IMMediate.....	166
SYSTem:CONFigure:GENerator:SWITCh:AUTO.....	166
SYSTem:PRESet:CHANnel[:EXECute].....	106
SYSTem:SEQuencer.....	150
TRACe<n>:COPY.....	173

TRACe<n>[:DATA]?..... 114

Index

Symbols

2nd stage correction 33, 58

A

Aborting
 Sweep 67
 AC/DC coupling 68
 Application cards 9
 Application notes 9
 Attenuation 60
 Auto ID
 External Mixer 74
 External Mixer (remote) 160
 Threshold (External Mixer, remote control) 162
 Threshold (External Mixer) 74
 Auto level range 60
 Averaging 58

B

Band
 Conversion loss table 78
 External Mixer 71
 External Mixer (remote) 158
 Bandwidth
 Resolution 36, 58
 Bias
 Conversion loss table 75, 78
 External Mixer 74
 External Mixer (remote) 157
 Brochures 9

C

Calibration 33, 58, 67
 Capture time
 see also Measurement time 136
 Center frequency 43
 Clear 46
 Closing
 Channels (remote) 104
 Windows (remote) 109, 113
 Comment
 Limit lines 95
 Compatibility
 Limit lines 93
 Continuous sweep
 Softkey 67
 Conventions
 SCPI commands 98
 Conversion loss
 External Mixer (remote) 161
 Conversion loss tables 75, 76
 Available (remote) 154
 Band (remote) 153
 Bias (remote) 153
 Configuring 75
 Creating 76
 Deleting (remote) 154
 External Mixer 72
 External Mixer (remote) 161
 Harmonic order (remote) 155

 Importing (External Mixer) 76
 Managing 75
 Mixer type (remote) 156
 Saving (External Mixer) 79
 Selecting (remote) 156
 Shifting values (External Mixer) 79
 Values (External Mixer) 79

Copying

 Measurement channel (remote) 103
 Traces 87

Coupling

 Input (remote) 150

D

Data format
 Remote 171, 172
 Data sheet 9
 Deleting
 Limit line values 96
 Delta markers
 Defining 89
 Direct measurement 47
 Direct measurements 28
 Duplicating
 Measurement channel (remote) 103
 DUT characteristics 47

E

ENR 49
 ENR source 50
 ENR table 52
 Delete 53
 Edit 52, 53
 Evaluation methods
 Remote 107
 Excess noise ratio (ENR) 49
 External generator
 Interface 80
 Interface settings 80
 External Mixer 70
 Activating (remote) 162
 Band 71, 157, 158
 Basic settings 73
 Configuration 69
 Conversion loss 72
 Conversion loss tables 75, 76
 Frequency range 70
 Handover frequency 71
 Harmonic Order 72
 Harmonic Type 72
 Name 78
 Range 72
 Restoring bands 71
 RF overrange 71, 162
 RF Start/RF Stop 70
 Serial number 78
 Type 72, 79, 162
 External reference
 External generator control 81

F

Filters	
High-pass (remote)	151
High-pass (RF input)	69
RBW	36
YIG (remote)	152
Fixed LO	48
Format	
Data (remote)	171, 172
Frequency	
Center	43
Span	44
Start	44
Stepsize	44
Stop	44
Frequency conversion	47
Frequency conversion measurements	28
Frequency list	25, 46
Frequency set	42
Frequency table	46, 47

G

Generator type	
External generator	80
Generators	
Frequency range, external generator	81
Power range, external generator	81
Setup files, external generator	80, 81
GPIO	
Address, External generator	81
External generator	80
TTL synchronization, External generator	81

H

Handover frequency	
External Mixer	71
External Mixer (remote)	157
Hardware settings	
Displayed	13
Harmonics	
Conversion loss table	78
External Mixer (remote)	159, 160
Order (External Mixer)	72
Type (External Mixer)	72
High-pass filter	
Remote	151
RF input	69

I

Image rejection	48
Impedance	
Remote	151
Setting	69
Input	
Coupling	68
Coupling (remote)	150
Input loss	55
Inserting	
Limit line values	96
Installation	11

K

Keys	
Peak Search	91
RUN CONT	67
RUN SINGLE	67

L

Level characteristics	59
Limit lines	92
Activating/Deactivating	93
Comment	95
Compatibility	93
Copying	94
Creating	94
Data points	96
Deactivating	94
Deleting	94
Deleting values	96
Details	95
Editing	94
Inserting values	96
Managing	92
Name	95
Saving	96
Selecting	94
Shifting	96
Traces	94
View filter	94
Visibility	93
Y-axis	95

Lines

Configuration	92
Limit, see Limit lines	92

LO

Level (External Mixer, remote control)	160
Level (External Mixer)	73

Loss

Input	55
Output	55
Loss table	56
Delete	57
Edit	56
Losses	54

M

Marker	37
Markers	
Deactivating	89
Delta markers	89
Minimum	91
Next minimum	92
Next peak	91
Peak	91
Querying position (remote)	184
Table	90
Type	89
Maximizing	
Windows (remote)	114
Measurement	
Frequency list	25
Performing	66
Measurement channel	
Creating (remote)	103, 104, 106
Deleting (remote)	104

- Duplicating (remote) 103
- Querying (remote) 104
- Renaming (remote) 106
- Replacing (remote) 104
- Selecting (remote) 106
- Measurement characteristics 57
- Measurement point
 - Delete 47
 - Insert 47
- Measurement points 44
- Measurement time
 - Remote 136
- Minimum 91
 - Marker positioning 91
 - Next 92
- Mixer Type
 - External Mixer 72
- Multiple
 - Measurement channels 12
- N**
- Name
 - Limit lines 95
- Next Minimum 92
 - Marker positioning 92
- Next Peak 91
 - Marker positioning 91
- Noise source 33, 49
- Noise source characteristics 48
- Noise Source Control 11
- O**
- Online help 8
- Options
 - High-pass filter 69, 151
- Output loss 55
- Overview
 - Configuration 40
- P**
- Peak search
 - Key 91
- Peaks
 - Marker positioning 91
 - Next 91
 - Softkey 91
- Populate 47
- Ports
 - External Mixer (remote) 162
- Position
 - Limit line values 96
- Preamplification 60
- Preset
 - Bands (External Mixer, remote) 158
 - External Mixer 71
- Presetting
 - Channels 41
- R**
- RBW 58
 - see Resolution Bandwidth 36
- Reference frequency
 - External generator 81
- Reference level 59
- Release notes 9
- Remote commands
 - Basics on syntax 98
 - Boolean values 101
 - Capitalization 99
 - Character data 102
 - Data blocks 102
 - Numeric values 101
 - Optional keywords 100
 - Parameters 100
 - Strings 102
 - Suffixes 99
- Resolution bandwidth 58
 - Impact 36
- Restoring
 - Channel settings 41
- Results
 - Data format (remote) 171, 172
- RF attenuation 60
- RF overrange
 - External Mixer 71, 162
- Room temperature 51
- RUN CONT
 - Key 67
- RUN SINGLE
 - Key 67
- S**
- Saving
 - Limit lines 96
- Sensitivity
 - RBW 36
- Sequencer 12
 - Aborting (remote) 147
 - Activating (remote) 147
 - Mode (remote) 148
 - Remote 146
- Settling time 58
- Setup files
 - External generator 80, 81
- Shift x
 - Limit lines 96
- Shift y
 - Limit lines 96
- Signal ID
 - External Mixer 74
 - External Mixer (remote) 160
- Single sweep
 - Softkey 67
- Softkeys
 - Continuous Sweep 67
 - Line Config 92
 - Min 91
 - Next Min 92
 - Next Peak 91
 - Norm/Delta 89
 - Peak 91
 - Single Sweep 67
- Span 44
- Specifics for
 - Configuration 42
 - Start frequency 44
 - Step(size) 44
 - Stop frequency 44

Suffixes	
Common	97
Remote commands	99
Sweep	
Aborting	67
Time (remote)	136
Sweep time	58
T	
TCP/IP	
Address, External generator	81
External generator	80
Temperature	51
Trace	86
Configuration	87
Mode	36
Preset	87
Selection	86
Trace export	87
Traces	
Copying	87
Copying (remote control)	173
Mode (remote)	170
Traces to be Checked	
Limit lines	94
TTL handshake	
see TTL synchronization	81
TTL synchronization	
External generator	81
Tuning mode	24, 43
V	
View filter	
Limit lines	94
Visible	
Limit lines	93
W	
White papers	9
Window title bar information	13
Windows	
Adding (remote)	107
Closing (remote)	109, 113
Configuring	42
Layout (remote)	110
Maximizing (remote)	114
Querying (remote)	109
Replacing (remote)	110
Splitting (remote)	114
Types (remote)	107
Y	
Y-axis	
Limit lines	95
YIG-preselector	
Activating/Deactivating	69
Activating/Deactivating (remote)	152