

Operating Manual



Power Supply NGMO1 and Power Supply NGMO2

192.1500.21 and 192.1500.24



Operating Manual
Power Supply NGMO1 and
Power Supply NGMO2
Edition: July 2004
Version: 4.00

All rights reserved, including translation into foreign languages. No part of this manual may be reproduced or reworked using electronic systems, duplicated or distributed in any form (photocopying, microfilm or any other process), not even for instructional purposes, without written permission from **ROHDE & SCHWARZ** GmbH & Co. KG.

© Disclosure or reproduction of this documentation, utilization and communication of its contents is not permitted, without express approval. Infringements will lead to claims for compensation. All rights reserved in the event of patents being granted or registration of a protected design.









ROHDE & SCHWARZ
GmbH & Co. KG
Mühlendorfstraße 15
D-81671 München
Phone: 49 (0)1805 124242
Fax: 49 (0)89 4129-13777
Internet: www.rohde-schwarz.com
E-mail: CustomerSupport@rohde-schwarz.com

Safety Instructions

This unit has been designed and tested in accordance with the EC Certificate of Conformity and has left the manufacturer's plant in a condition fully complying with safety standards.

To maintain this condition and to ensure safe operation, the user must observe all instructions and warnings given in this operating manual.

Safety-related symbols used on equipment and documentation from R&S:

							
Observe operating instructions	Weight indication for units >18 kg	PE terminal	Ground terminal	Danger! Shock hazard	Warning! Hot surfaces	Ground	Attention! Electrostatic sensitive devices require special care

- The unit may be used only in the operating conditions and positions specified by the manufacturer. Unless otherwise agreed, the following applies to R&S products:
IP degree of protection 2X, Pollution severity 2, overvoltage category 2, altitude max. 2000 m.
The unit may be operated only from AC supply mains fused with max. 16 A.
- For measurements in circuits with voltages $V_{rms} > 30$ V, suitable measures should be taken to avoid any hazards.
(e.g. use of appropriate measuring equipment, fusing, current limiting, electrical separation, insulation).
- If the unit is to be permanently wired, the PE terminal of the unit must first be connected to the PE conductor on site before any other connections are made. Installation and wiring of the unit should only be performed by qualified technical personnel.
- For permanently installed units without built-in fuses, circuit breakers or similar protective devices, the supply circuit must be fused such as to provide suitable protection for the users and equipment.
- Prior to switching on the unit, it must be ensured that the nominal voltage set on the unit matches the nominal voltage of the AC supply network.
- If a different voltage is to be set, the power fuse of the unit may have to be changed accordingly.
- Units of protection class I with disconnectible AC supply cable and appliance connector may be operated only from a power socket with grounding contact and with the PE conductor connected.
- It is not permissible to interrupt the PE conductor intentionally, neither in the incoming cable nor on the unit itself, as this may cause the unit to become electrically hazardous.
Any extension lines or multiple socket outlets used must be checked for compliance with relevant safety standards at regular intervals.
- If the unit has no power switch for disconnection from the AC supply, the plug of the connecting cable is regarded as the disconnecting device. In such cases it must be ensured that the power plug is easily reachable and accessible at all times (length of connecting cable approx. 2 m). Functional or electronic switches are not suitable for providing disconnection from the AC supply.
If units without power switches are integrated in racks or systems, a disconnecting device must be provided at system level.

continued overleaf

Safety Instructions

9. Applicable local or national safety regulations and rules for the prevention of accidents must be observed in all work performed.

Prior to performing any work on the unit or opening the unit, the latter must be disconnected from the supply network.

Any adjustments, replacements of parts, maintenance or repair may be carried out only by authorized R&S technical personnel.

Only original parts may be used for replacing parts relevant to safety (e.g. power switches, power transformers, fuses). A safety test must be performed after each replacement of parts relevant to safety.

(visual inspection, PE conductor test, insulation-resistance, leakage-current measurement, function test).
10. Ensure that the connections with information technology equipment comply with IEC950 / EN60950.
11. Lithium batteries must not be exposed to high temperatures or fire.

Keep batteries away from children.

If the battery is replaced improperly, there is danger of explosion. Only replace the battery by R&S type (see spare part list).

Lithium batteries are suitable for environmentally friendly disposal or specialized recycling. Dispose of them in appropriate containers only.

Do not short-circuit the battery.
12. Equipment returned or sent in for repair must be packed in the original packing or in packing with electrostatic and mechanical protection.
13. Electrostatics via the connectors may damage the equipment. For the safe handling and operation of the equipment, appropriate measures against electrostatics should be implemented.
14. The outside of the instrument is suitably cleaned using a soft, lint-free dust cloth. Never use solvents such as thinners, acetone or similar, as they may damage the front panel labelling or plastic parts.
15. Any additional safety instructions given in this manual are also to be observed.

Contents

1	Operator Information	1-1
1.1	Preface	1-1
1.2	NGMO-Versions	1-1
1.2.1	NGMO1	1-2
1.2.2	NGMO2	1-2
1.3	Purpose of the Handbook	1-2
1.4	Explanation of Symbols	1-3
1.5	Inspection	1-4
2	Safety	2-1
2.1	General	2-1
2.2	Safety Instructions	2-1
3	Unit Description	3-1
3.1	Introduction	3-1
3.2	Overview	3-2
3.2.1	Accessories	3-3
3.3	Specifications	3-4
3.4	Function Description	3-7
3.4.1	Communication	3-7
4	Operation	4-1
4.1	Operation Elements	4-1
4.2	Start-Up	4-5
4.2.1	NGMO2 Line Power Connection and Power-up	4-5
4.2.2	Main Functions of the NGMO2	4-5
4.2.3	Menu	4-9
4.3	Test Connections	4-20
4.3.1	Remote Sense	4-20
4.3.2	Local Sense	4-21
4.3.3	Output Impedance	4-21
4.4	Factory Defaults	4-22



4.5	Measurements	4-23
4.5.1	Reading back Voltage (V), Current (I), DVM	4-23
4.5.2	Dynamic Measurements	4-23
4.6	Status Structure	4-28
4.6.1	Status Byte and SRQ	4-28
4.6.2	Queues	4-28
5	IEEE Commands	5-1
5-1	IEEE-488.2 common commands and queries	5-1
5-2	FORMAT command summary	5-5
5-3	OUTPut command summary	5-6
5-4	SENSE command summary	5-9
5-5	SOURCE command summary	5-17
5-6	STATUS command summary	5-20
5-7	CONFIG command summary	5-22
5-8	SYSTEM command summary	5-23
5-9	Signal-oriented measurement-command summary	5-28
5-10	Remote calibration command summary	5-30
6	Ordering Information	6-1

Figures

Fig. 3-1	NGMO2, Front view	3-2
Fig. 3-2	NGMO2, Rear view	3-3
Fig. 3-3	NGMO2, Pin codes	3-7
Fig. 3-4	Circuit diagram: Mobile phone connected to the NGMO2	3-8
Fig. 4-1	NGMO2, Operation elements on the control panel	4-1
Fig. 4-2	Four-wire sense connection	4-20
Fig. 4-3	Local sense connections	4-21
Fig. 4-4	Sample values	4-24
Fig. 4-5	Pre-trigger and post-trigger acquisition	4-25
Fig. 4-6	Measurement repetition	4-26
Fig. 4-7	Status model structure	4-29





1 Operator Information

1.1 Preface

We are pleased that you have decided to invest in an **ROHDE & SCHWARZ Power Supply NGMO**.

We would naturally be glad to answer any application questions you may have.

We look forward to a productive partnership.

Your After Sales Team at



ROHDE & SCHWARZ

GmbH & Co. KG

1.2 NGMO-Versions

NOTE:



The Power Supply is available in different versions.

This Operating Manual contains descriptions for all versions. In chapters with differences in the description of the individual Power Supplies, such differences will be specially emphasized.

The designation NGMO is used wherever the description applies for all versions.

If you use this manual for a NGMO1:

Just ignore all descriptions and specifications which belong to the channel B of the power supply.

This is also valid for all status structure description and IEEE commands in chapter 4 and chapter 5 of this manual.

If you call a remote command for channel B, the IEEE error message 403 (invalid or non existant channel) is returned when calling "system:error?".

1.2.1 NGMO1

The Power Supply NGMO1 consists of the following assemblies:

- Keyboard with LC Display
- Processor board
- Analog board for Channel A
- Power supply unit

1.2.2 NGMO2

The NGMO2 is equipped with two analog boards and therefore delivers two separate voltage sources and signal channels. Apart from that the Power Supplies are absolutely identical.

1.3 Purpose of the Handbook

The operating manual contain all the information you will need to use the Power Supply NGMO.

This manual describes

- safe installation and assembly,
- appropriate and safe operation,

of the Power Supply.

Read the operating instructions carefully before you use the Power Supply. The operating instructions contain important information which must be acted on.

Apart from the information in the operating instructions, the statutory safety regulations that apply in the country of use, the relevant technical standards and the regulations concerning the safe and appropriate use of electrical equipment must also be observed.

The operating instructions belong to the unit and must always be available at the place of use of the Power Supply NGMO.

The owner must observe national safety and environmental protection regulations.



1.4 Explanation of Symbols

The Power Supply NGMO was produced according to the generally accepted regulations governing the technology and current status of science and technology.

However, it is impossible to design hazard-free electrical equipment.

In order to guarantee a sufficient level of safety for personnel working with the Power Supply NGMO, safety regulations must be observed.

Certain sections of the text are highlighted as follows:



ELECTROCUTION HAZARDS!

Observe the relevant safety regulations when operating electrical devices.



Observe the operating instruction.



WARNING!

Failure to follow the instructions could damage the Power Supply NGMO.



ATTENTION!

Failure to follow the instructions may cause spurious results.



NOTE:

Emphasizes significant details, the observance of which is of particular importance and which facilitate operation.



1.5 Inspection

The Power Supply NGMO2 was carefully inspected electrically and mechanically before shipment. After unpacking the unit from the shipping carton, check for any obvious signs of physical damage that may have occurred in transit. Remove any protective film over the screen.

Report any damage to the shipping agent immediately. Save the original packing carton for any future shipments. The following items are included with every order:

- 1 Power Supply NGMO,
- 1 power cable,
- 2 output connectors,
- 1 Operating manual



2 Safety

2.1 General

NOTE



Only personnel authorized by ROHDE & SCHWARZ may open the Power Supply NGMO.

If the safety regulations for the Power Supply NGMO are disregarded, ROHDE & SCHWARZ GmbH & Co KG will not assume liability for any resulting damage and all warranties will become null and void.

2.2 Safety Instructions



ELECTROCUTION HAZARDS!

Observe the relevant safety regulations when operating electrical devices.



Observe the operating instruction.



ATTENTION!

Failure to follow the instructions may cause spurious results.



WARNING!

Failure to follow the instructions could damage the Power Supply NGMO.





3 Unit Description

3.1 Introduction

The Power Supply NGMO is accommodated in a 1/2-19", 2 HU (high units) enclosure.

The NGMO is more, than just a power supply for conventional test and measurement equipment, - it is an accurate, multipurpose electronic device with two separate supply and measurement channels (NGMO2 only, NGMO1 only Channel A) which can be used as the following:

- high speed voltage source,
- programmable DC load,
- precise digital multimeter,
- sampling oscilloscope,

This unit fulfils all requirements of latest electronic battery-powered communication products.

The high speed and the high reliability are features which are very important in a production environment.

The NGMO is an ideal device for testing complex high-tech products such as mobile phones. With the NGMO, it is possible to create reproducible and realistic powering conditions.



3.2 Overview

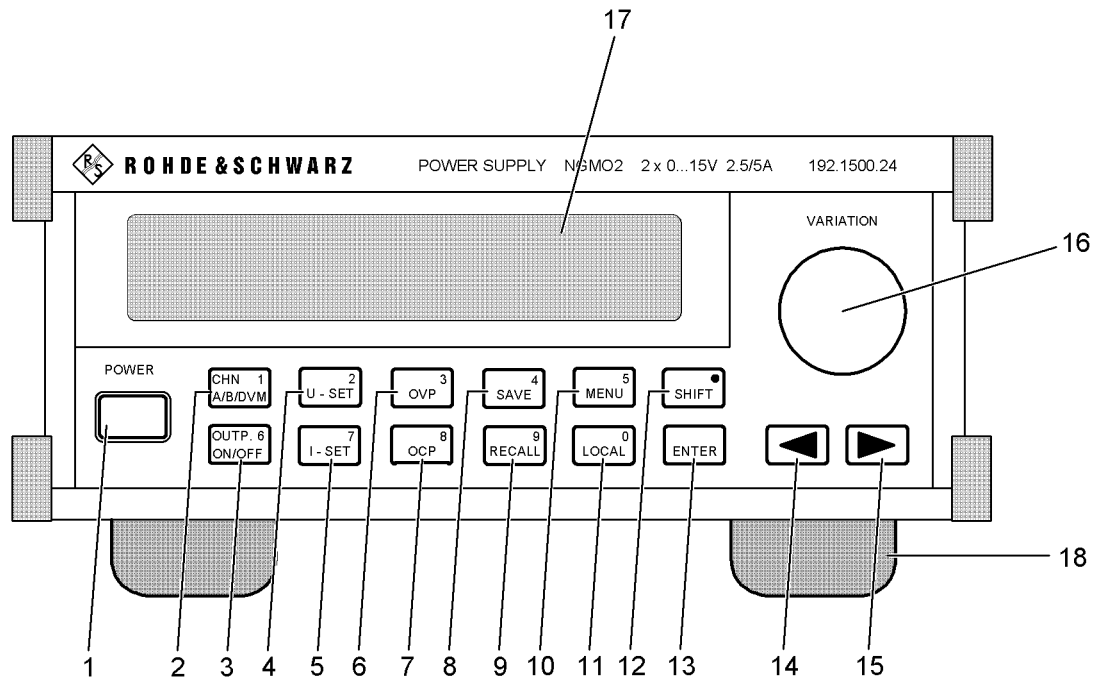

Fig. 3-1 NGMO2, Front view

- 1 pushbutton, POWER
- 2 key 1, CHN, A/B/DVM
- 3 key 6, OUTP., ON/OFF
- 4 key 2, U-SET
- 5 key 7, I-SET
- 6 key 3, OVP
- 7 key 8, OCP
- 8 key 4, SAVE
- 9 key 9, RECALL
- 10 key 5, MENU
- 11 key 0, LOCAL
- 12 key, SHIFT .
- 13 key, ENTER
- 14 arrow key, right
- 15 arrow key, left
- 16 rotary knob, VARIATION
- 17 display
- 18 unit foot

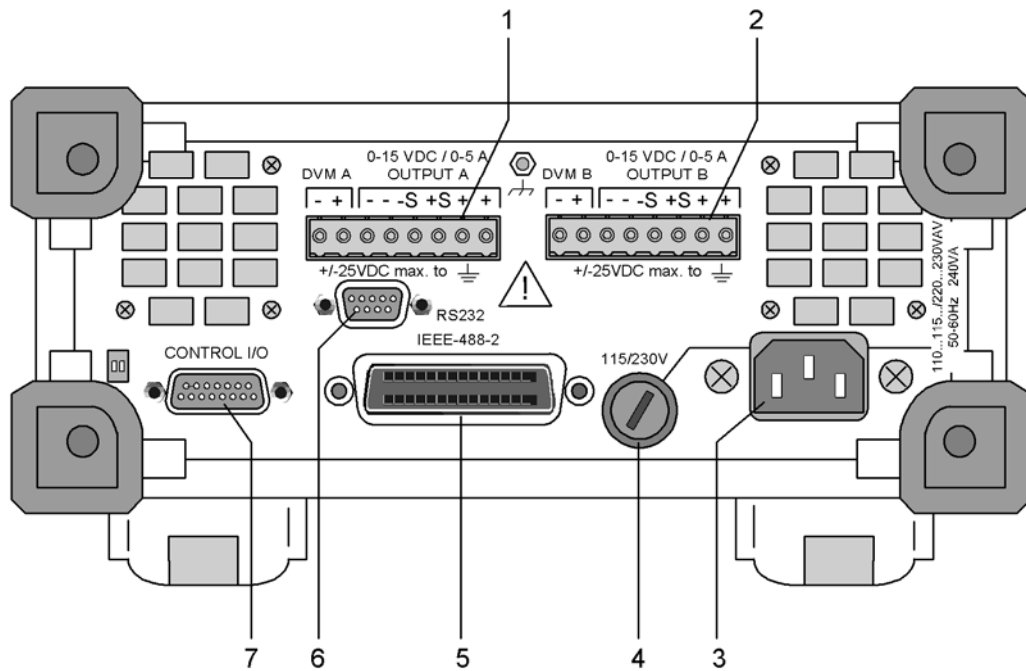

Fig. 3-2 NGMO2, Rear view

- 1 Channel A Connector
- 2 Channel B Connector
- 3 Mains, 120/230 VAC
- 4 Voltage Selector
- 5 IEEE488.2 Connector
- 6 RS485/232 Connector
- 7 Control I/O Connector

3.2.1 Accessories

- 1 power cable,
- 2 output connectors,
- 1 operating manual



3.3 Specifications

	Channel 1	Channel 2
Constant-voltage source		
- Voltage setting	0 to 15 V	0 to 15 V
- Resolution	1 mV	1 mV
- Deviation	0.05 % +5 mV	0.05 % +5 mV
• with ± 10 % AC supply variation	0.5 mV	0.5 mV
• from 10 to 90 % load change	0.01 % + 3 mV	0.01 % + 3 mV
- Transient recovery time on load change (0.1 A to 1.6 A) to recover within 20 mV		
with wide bandwidth		
• direct connected	<35 μ s	<35 μ s
• at "long" leads, sensed	<50 μ s	<50 μ s
with narrow bandwidth		
• direct connected	<80 μ s	<80 μ s
• at "long" leads, sensed	<100 μ s	<100 μ s
- Transient voltage drop on load change (0.1 A to 1.6 A)		
with wide bandwidth		
• at "long" leads, sensed	<60 mV	<60 mV
• ripple and noise	<1 mV _{RMS}	<1 mV _{RMS}
• output impedance	0 to 1 Ω , settable in 10 m Ω steps	0 to 1 Ω , settable in 10 m Ω steps
• voltage compensation	up to 1 V (4 V) per lead	up to 1 V (4 V) per lead
Constant-current source		
- Peak current (1 ms)	7 A	7 A
- Current setting		
• within 1.8 to 5 V	0 to 5 A	0 to 5 A
• outside 1.8 to 5 V	0 to 2.5 A	0 to 2.5 A
• resolution	1 mA	1 mA



Unit Description

Power Supply NGMO

- | | | |
|-------------------------------------|---|---|
| • deviation from full scale | 10 mA | 10 mA |
| with ± 10 % AC supply variation | 1 mA | 1 mA |
| from 10 to 90 % load change | 2.5 mA | 2.5 mA |
| • current sink capability | 2.8 A (0 to 5 V) derating up to 1 A at 15 V | 2.8 A (0 to 5 V) derating up to 1 A at 15 V |

Voltage measurement

- | | | |
|-----------------------------|-------------------------|-------------------------|
| - Range | -5 to 25 V | -5 to 25 V |
| • resolution | 1 mV | 1 mV |
| • deviation from full scale | 0.03 % +3 mV | 0.03 % +3 mV |
| - Measurement time | 2 ms to 200 ms settable | 2 ms to 200 ms settable |
| • averaging | 1 to 10 values | 1 to 10 values |

Current measurement

- | | | |
|-----------------------------|------------------------------------|------------------------------------|
| - Ranges | 7 A/0.5 A/5 mA | 7 A/0.5 A/5 mA |
| • resolution | 200 μ A/10 μ A/0.1 μ A | 200 μ A/10 μ A/0.1 μ A |
| • deviation from full scale | 15 mA/1 mA/10 μ A | 5 mA/1 mA/10 μ A |
| - Measurement time | 2 ms to 200 ms settable | 2 ms to 200 ms settable |
| • averaging | 1 to 10 values | 1 to 10 values |

Dynamic measurement

- | | | |
|---------------------|---------------------------------------|---------------------------------------|
| - Sample buffer | 1 to 5000 points | 1 to 5000 points |
| - Sample time | 10 μ s to 1 s in 10 μ s steps | 10 μ s to 1 s in 10 μ s steps |
| - multiple trigger | 1 to 100 | 1 to 100 |
| - Triggering system | | |
| • ranges | 5 A/0.5 A | 5 A/0.5 A |
| • settable levels | | |
| range 5 A | 0 A to 7 A in 200 μ A steps | 0 A to 7 A in 200 μ A steps |
| range 0.5 A | 0 mA to 0.5 A in 10 μ A steps | 0 mA to 0.5 A in 10 μ A steps |
| • DVM | -5 V to 25 V in 1 mV steps | -5 V to 25 V in 1 mV steps |



- Analysis of values

PEAK, MIN,
HIGH, LOW,
RMS,
AVERAge

PEAK, MIN,
HIGH, LOW,
RMS,
AVERAge

Protection Functions

- OVP
- OCP
- Open-sense lead detection

1.5 to 22 V, settable

1.5 to 22 V, settable

0 to 5 A, settable

0 to 5 A, settable

$\pm(0$ to 4 V) about set
voltage, settable

$\pm(0$ to 4 V) about set
voltage, settable

General Data

- Remote control
- Control inputs
- Control outputs
- AC supply
- AC input power
- Dimensions
- Mass

IEEE488.2, RS232C

2 x measurement trigger, 2 x output inhibit

2 x complete, 4 x relay driver, fault

110/115 V and 220/230 V selectable, 50 to 60 Hz

220 VA max.

220 VA max.

210.8 mm x 87.6 mm x 420 mm without rear and bottom
feet

7.5 kg

Environmental Data

- Humidity
- Operating temperature range
- Nominal temperature range

85 % at 35 °C non-condensing

0 to 45 °C

5 to 40 °C, 0 to 35 °C full power

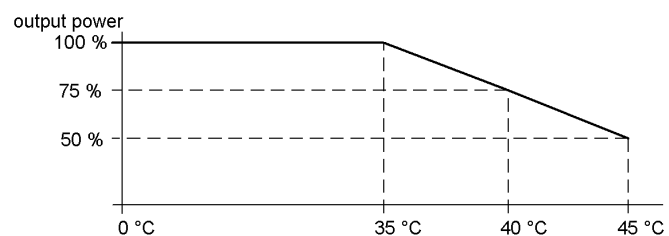

- Storage temperature range
- Temperature coefficient

-40 to 70 °C

18 to 28 °C (full accuracy)

5 to 40 °C (0.1 x specification)/°C

3.4 Function Description

3.4.1 Communication

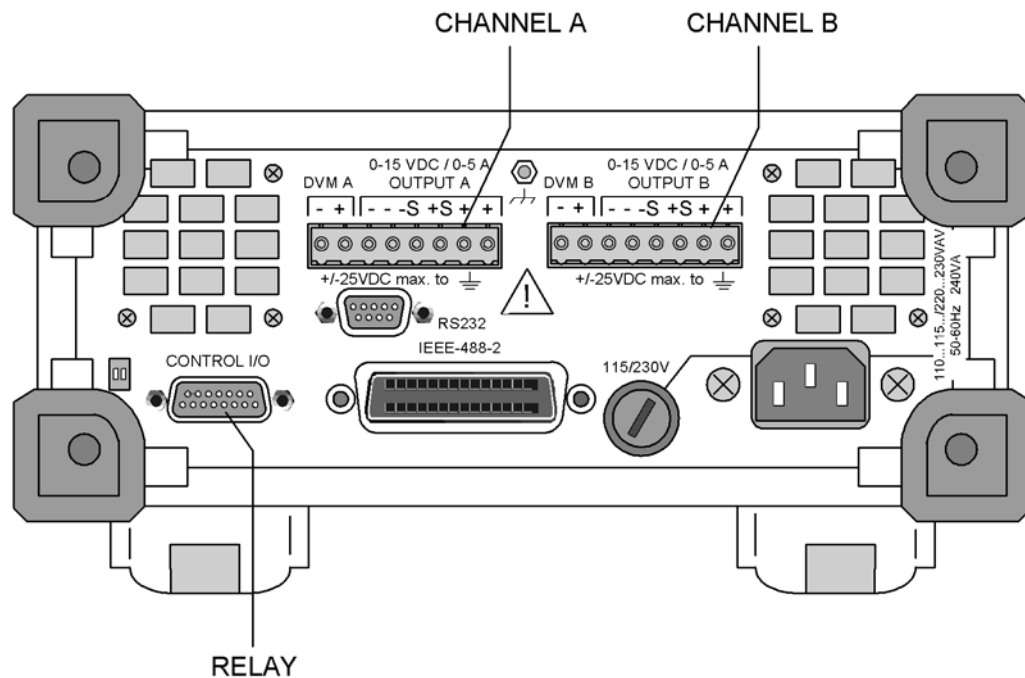

Fig. 3-3 NGMO2, Pin codes

Channel		Relay Connector, rear panel, SUB 15, male			
Pin	Function	Pin	Function	Signal	
1	DVM-	1	RELOUT 1	output, relay driver, open collector	28 VDC/200 mA
2	DVM+	2	RELOUT 2	output, relay driver, open collector	28 VDC/200 mA
3	FORCE-	3	RELOUT 3	output, relay driver, open collector	28 VDC/200 mA
4	FORCE-	4	RELOUT 4	output, relay driver, open collector	28 VDC/200 mA
5	SENSE-	5	FAULT	output, fault signal, open collector	28 VDC/200 mA
6	SENSE+	6	NC	not used	not used
7	FORCE+	7	NC	not used	not used
8	FORCE+	8	GND	GND	signal GND
		9	GND	GND	signal GND
		10	INHIBIT_B	input, external inhibit signal	TTL 0 ... 12 VDC
		11	TRIGGER_B	input, external inhibit signal	TTL 0 ... 12 VDC
		12	INHIBIT_A	input, external inhibit signal	TTL 0 ... 12 VDC
		13	TRIGGER_A	input, external inhibit signal	TTL 0 ... 12 VDC
		14	COMPL_B	output, complete signal, open collector	28 VDC/200 mA max.
		15	COMPL_A	output, complete signal, open collector	28 VDC/200 mA max.

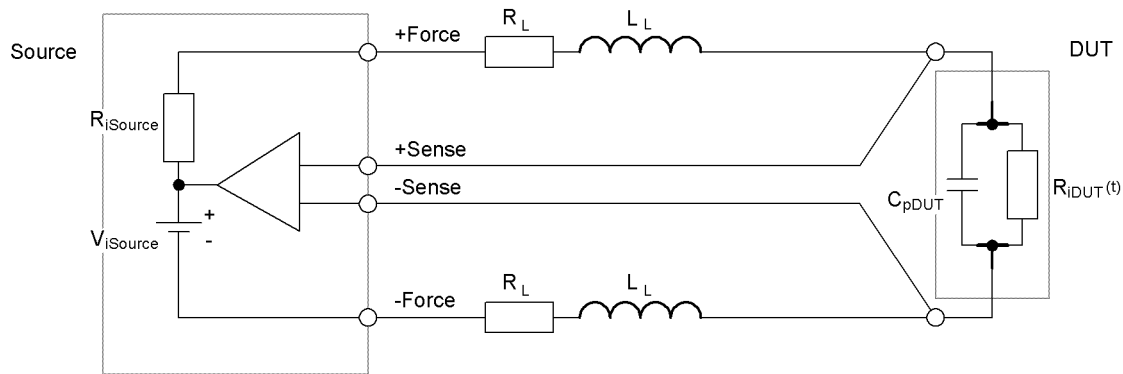

Fig. 3-4 Circuit diagram: Mobile phone connected to the NGMO2

The NGMO2 provides:

- 2 channels 15 V/2.5 (5) A with 7 A_{pk}
- fast output transient response
- sample buffer for fast current and voltage measurements
- internal and external triggers for current and voltage measurements
- separate DVM's
- DC-load capability up to 2.8 A
- high voltage setting resolution
- precise low-current measurements
- very low ripple and noise
- settable output impedance for battery emulation
- OVP/OCP
- open sense detection
- auxiliary inputs/outputs (output inhibit, relay, complete)
- small dimensions (2 HU, half 19")
- interfaces: IEEE488.2, RS232 and (USB)
- fast programming
- effective manual operation

4 Operation

4.1 Operation Elements

Fig. 4-1 shows the Operation Elements for the Power Supply **NGMO2**.

NOTE:



Operation elements and Start-up functions of the Power Supply **NGMO1** are identical with the **NGMO2**.

Operation elements for channel **B** must in this case be ignored.

Readings in the LC Display correspond with the respective Power Supply.

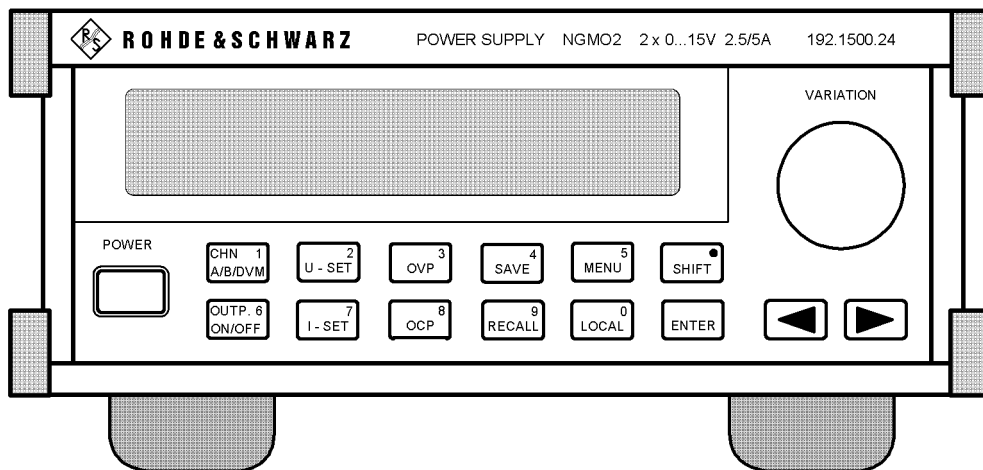







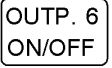
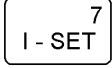
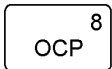

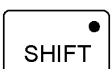



Fig. 4-1 Power Supply NGMO2, Operation elements on the control panel



Function element	Type	Function
	pushbutton	POWER This is the mains switch to turn the NGMO on and off.
	rotary knob	VARIATION This knob has various functions: <ul style="list-style-type: none"> to increase or decrease numerical values in a menu function, to select options within the menu.
	keys	ARROW KEYS (left and right) <ul style="list-style-type: none"> When no other function is selected, the LCD contrast can be adjusted with the arrow keys. The arrow key moves the cursor to the numerical input you want to make, or to vary a setting within the menu. The arrow keys can also be used to abort the recall or the save function.
	key	1; CHANNEL A; CHANNEL B; 1; Digital Voltmeter A; Digital Voltmeter B By pressing this key, channel A or channel B and the associated DVM can be selected. The selected DVM shows an applied external voltage.
	key	2; Voltage setting Press U-SET to set the output voltage you have selected. The value you want and, if necessary, modified by pressing the SHIFT key or by turning the variation knob.
	key	3; Overvoltage protection By pressing the OVP key you can set the max. +force output voltage with respect to the internal ground. If the voltage peaks exceed the set value, the NGMO switches off automatically to protect the unit under test.
	key	4; SAVE With the SAVE key all settings can be stored in one of the memory locations 1 to 9, except the recall settings, IEEE address, serial interface data, calibration data, which are stored in memory location 0.



Function element	Type	Function
	key	<p>5; MENU</p> <p>Pressing the MENU key, allows you to select any of the 36 NGMO available optional functions with the variation knob.</p> <p>A menu need not necessarily have submenus.</p>
	key	<p>6; OUTPUT; ON/OFF</p> <p>The ON/OFF key is used to turn the output of the current from the selected Power Supply (A, B or both) on or off.</p>
	key	<p>7; Current setting</p> <p>Press I-SET to set the output current limit of the channel you have selected. The value you want can be entered and modified after you press the SHIFT key or by turning the variation knob.</p> <p>The max. settable value is 5 V at 5 A. On a higher value than 5 V the max. current output is limited to max. 2.5 A.</p>
	key	<p>8; Overcurrent protection</p> <p>Pressing this key allows you to choose between the options “current protection mode” or “current limit mode”. When the “current protection mode” has been selected, the output is switched off when the max. output current exceeds the set current limit.</p>
	key	<p>9; RECALL</p> <p>The RECALL key is used to recall all settings stored in memory locations 1 to 9.</p> <p>Memory location 0 contains the factory default settings which can not be modified.</p>
	key	<p>0; LOCAL</p> <p>With the LOCAL key the unit operation can be switched from remote control back to local control.</p>
	key	<ul style="list-style-type: none"> • SHIFT <p>When the second function of the SHIFT key is selected, numerical values and a decimal point can be entered. Cancel a selected function by pressing the SHIFT key twice.</p>
	key	<p>ENTER</p> <p>Pressing the ENTER key numerical entries made using the SHIFT key or deactivates a setting function.</p>

**General Note:**

- All function keys in the middle of the control panel (CHN 1 A/B/DVM to 0 LOCAL and SHIFT) are assigned two functions, e.g. apart from the main setting functions, the numerals 0 to 9 and the decimal point printed on the keys can be entered to alter values when the shift key has been pressed.
- **UUT** stands for **unit under test** in the sequel.



4.2 Start Up

4.2.1 NGMO Line Power Connection and Power-up

The NGMO operates from a line voltage in the range 120/230 VAC at a frequency between 47 and 63 Hz.

Proceed as follows to connect the NGMO to the AC line and turn on:

1. Before plugging in the power cable, make sure that the power switch is off (the "**POWER**" switch has not been pressed and shows "OFF").
2. Check that the "**Mains Voltage Selector**" (4, Fig. 5-2) is set to the appropriate line voltage.
3. Connect the female end of the power cable to the AC receptacle on the rear panel.
4. Connect the Power Supply NGMO to the AC line.
5. Press the push button "**Power**" on the front panel.

4.2.2 Main Functions of the NGMO

When the NGMO2 is powered up, it displays the following start-up information:

**Rohde & Schwarz
N G M O 2**

Next screen after 4 seconds:

**Ver:x.yy IEEE Adr:nn
Found: A/B Type:**

Or

**Ver:x.yy IEEE Adr:nn
Found: Az + Bz**



Example 1

line 1:

- **"AS"** means that currently the settings for channel A are displayed. If you turn the output on by pressing the **"OUTP. on/off"** key the display changes to **"AM"** indicating that this is now a measured value taken from the output terminals of the selected power supply.
- **x.xxx** is the output voltage. If **"AS"** is displayed (output off) **x.xxx** is the nominal voltage. If **"AM"** is displayed (output on) **x.xxx** is the voltage measured on the sense lines of the output terminals.
- **y.yyy** is the current limit / output current. If **"AS"** or **"S"** is displayed in front of **y.yyy** then **y.yyy** is the current limit setting. If **"AM"** is displayed **y.yyy** is the actual current, measured on the force lines of the output terminals.

line 2:

- **A:OFF** means that the output of power supply A is currently turned off.
- **A:ON** means that the output of power supply A is currently turned on.
- **AB:OFF** is displayed if function A/B24 "Common output on/off" (see below Menu Items) is turned on and both outputs are off.
- **AB:ON** is displayed if function A/B24 "Common output on/off" (see below Menu Items) is turned on and both outputs are on.
- **PROT** is displayed if the **OCP** key has been pressed so activating the overcurrent protection function. In **OCP** active mode, the output is switched off if the current on output lines exceeds the current limit setting (**y.yyy**).
If **OCP** is turned off, the current is limited to the current limit setting. If NGMO2 enters the current limit state **"ILIM"** is displayed at the same location as **"PROT"**.
"INH" is displayed at the **"PROT"** location when the output has been turned off by a logical 1 applied to the INHIB_A pin on the **"CONTROL I/O"** connector.
- **RDY** is displayed when the NGMO2 has finished sampling and measurement data are ready to be transferred for analysis.
- **REM** is displayed when the NGMO2 has received remote commands via the IEEE interface or serial interface. In remote mode



manual setting keys are disabled except the local key and those to change the display mode. This makes it easier for software developers to verify that their software is running correctly.

When a lock command has been received from the IEEE interface the NGMO2 enters the lock state. In this state all manual settings are completely disabled. "**LOCK**" is displayed instead of "**REM**".

Example 2: is similar to example 1 except that channel B has been selected using the CHN key.

Example 3:

line 1:

- **DVMA** means that currently the DVM measurement input of channel A has been selected. The value of the voltage applied to channel A: DVM input is currently displayed.
- **z.zzz** is the value of the measured voltage in volts.
- **DVMA:** is selected by pressing the CHN key.

line: 2 is similar to example 1: line: 2.

Example 4: is similar to example 3, except that the voltage of DVM input of channel B is displayed.

- **DVMB:** can also be selected by pressing the CHN key.

End of startup

Now, the NGMO2 is in the main function mode. This mode allows the setting of the output voltage, the current limit, the overvoltage protection and the overcurrent protection.

The startup settings depend on the setting of menu item 29 (See description below for further information on recalling settings).



4.2.3 Menu

There are two ways of entering numerical settings. The first way is to use the variation knob (16, Fig. 3-1) and the arrow keys (14, 15, Fig. 3-1). The second is to use the keys with the extra blue labels.

4.2.3.1 How to Enter a Numerical Value Using the Variation Knob?

To enter a numerical value using the variation knob, you must first select a function that accepts such entries by pressing, e.g. U-SET, I-SET and OVP. In Menu mode the ENTER key must be pressed first to enter the setting mode. When you have pressed the appropriate key, a small underscore cursor indicates the digit that will be changed when you turn the variation knob. A different digit can be selected with the arrow keys. The right arrow key moves the underscore cursor one digit to the right; the left arrow key moves the underscore cursor one digit to the left. By turning the variation knob clockwise, the value above the cursor and all digits left of the cursor are increased. Turning the knob counter clockwise decreases the value.

To exit the entry mode press either the ENTER key or the function key. The underscore cursor then disappears.

4.2.3.2 How to Enter a Numerical Value directly?

To enter a numerical value directly, you must also first select a function that accepts a numerical input by pressing e.g. U-SET, I-SET and OVP. After that the SHIFT key must be pressed. To indicate that direct numerical input is selected, the NGMO2 displays a blinking block cursor in the input field. Now a value can be directly entered using the blue digit keys. The SHIFT key now acts as a double function key. The SHIFT key is used to enter decimal points for numerical entries. If a decimal point has already been entered, or decimal points are not accepted, SHIFT key aborts the ongoing entry and the old value is restored. The right arrow key can also be used to abort an entry which is being made.

The left arrow key acts as a back-space key. Each time the left arrow key is pressed, a digit is selected. When the ENTER key is pressed, the new value is accepted and the direct numerical entry mode is terminated.

**NOTE:**

If you are in the Menu mode and you have selected a function that accepts numerical entries, the direct numerical input mode can be activated by pressing the *SHIFT* key without first pressing the *ENTER* key. However, it is also possible to first select the variation knob entry mode by pressing the *ENTER* key and then entering the direct numerical entry mode by pressing the *SHIFT* key.

4.2.3.3 How to Change Settings in Menu Mode?

Most NGMO2 settings can only be changed inside the Menu mode. To enter the Menu mode, press the MENU key once. A brief message is displayed how to navigate through the menu. The NGMO2 then displays "A01." or "B01." (after power-on) or when you re-enter the Menu mode, the last menu item that was previously selected. Now, a menu item can be selected by turning the variation knob. The action to change an item value or setting depends on the kind of item. If an item type has predefined options, just press the left arrow key to move the square brackets around a value one to the left and the right arrow key to move it one to the right. The new selected setting comes into effect immediately. The ENTER key does not need to be pressed.

Items that accept numerical values are changed by using the variation knob or the direct numerical input as described above. To enter one of these modification modes either the ENTER key (for variation knob entry) or the shift key must be pressed. To leave the entry mode just press the ENTER key, which brings you back to the menu item selection mode.

NOTE:

Please note that the presence of absence of the cursor tells you what the current entry mode is. If no cursor is displayed, you are in menu item selection mode; if the underscore cursor is displayed, you are in the variation knob entry mode and if a flashing, solid cursor is displayed, the direct numerical entry mode has been selected.



4.2.3.4 Menu Items

The menu includes a selection of items from **A01** or **B01** to **A38** or **B38**:

(The indicated channel **A** or **B** depends on which channel is selected.)

A/B01:	<p>Current range [AUTO] 5A .5A 5mA</p> <p>This function selects the range for static current measurement (see main screen) and also selects the current range for signal analysis. The analysis mode is only available in the ranges .SA and SA.</p>
A/B02:	<p>Static Measure Interval (2-200 ms)</p> <p>This setting specifies the repetition time between two static current and DVM measurements. Any value from 2 to 200 ms can be selected.</p>
A/B03:	<p>Static Measure Average Count (1-10)</p> <p>This setting specifies the average count for static current and DVM measurements. Values from 1 to 10 can be selected. The total measurement time for static measurements is the product of "Static Measure Interval" multiplied by "Static Measure Average Count".</p>
A/B04:	<p>Output Impedance (0-1.00 Ohms)</p> <p>This menu item lets you set the output impedance from 0.00 Ohms to 1.00 Ohms in 10 mOhms steps.</p>
A/B05:	<p>Output Bandwidth high low</p> <p>This menu item lets you select one of two different output regulation characteristics. When in "High" mode the NGMO2 has the fastest regulation speed available (see specifications for further information), but this may result in an unstable load regulation for inductive loads.</p>



A/B06:	<p>Sample Channel [Current DVM]</p> <p>This menu items lets you select the source for the NGMO2 analysis functions. When “current” is selected the analysis functions use the internal current measure circuits for analysis (ranges 5A or .5A). In “DVM” mode the external DVM inputs are used for analysis.</p>
A/B07:	<p>Trigger Level Range: 5A (0.0000-7.0000A)</p> <p>Lets you set the trigger level in the 5A range (see menu item A/B01) and the signal analysis functions. Any value between 0.0000 A (Auto) and 7.0000 A that is a multiple of 200 uA can be selected. An asterisk on the right of line two of the LCD indicates when the 5A range has been selected in menu item A/B01.</p>
A/B08:	<p>Trigger Level Range 0.5A (0.00-500.00A)</p> <p>Lets you set the trigger level in the 0.5A range (see menu item A/B01) and the signal analysis functions. Any value between 0.00 mA (Auto) and 500.00 mA that is multiple of 10 uA can be selected. An asterisk on the right of line two of the LCD indicates when 0.5A range has been selected in menu item A/B01.</p>
A/B09:	<p>Trigger Level DVM: (-6.000-25.000V)</p> <p>Lets you set the trigger level for the DVM input (see menu item A/B06) and the signal analysis functions. Any value between -6.000 V (Auto) and +25.000 Volts that is a multiple of 1 mV can be selected. An asterisk on the right of line two of the LCD indicates when “Sample Channel: DVM” has been selected in menu item A/B06.</p>
A/B10:	<p>Trigger Timeout (0-60.000 seconds)</p> <p>f you are using the analysis mode (sampling mode) this function specifies the time in seconds the sampling unit waits for a trigger condition before a timeout message is generated after turning sampling mode on. Any value from 0.000 seconds (infinite) to 60.000 seconds can be selected.</p>



A/B11:	Trigger Source [int] ext The trigger source function lets you select either an internal trigger source (see A/B07 to A/B09) or use an external trigger signal to start an analysis measurement. The external trigger signal can be applied on the rear panel.
A/B12:	Trigger Slope [pos] neg The trigger slope specifies the slope (positive or negative transition) used for signal triggering. A positive slope is a low-to-high current or voltage transition, a negative slope specifies a high-to-low transition.
A/B13:	Trigger Count (1-100) The trigger count specifies the number of times the analysis measurement is repeated to calculate the average value for: Average, Peak, Min, High, Low and RMS functions. Any value from 1 to 100 can be selected.
A/B14:	Trigger Offset (-5000-50000 points) The trigger offset specifies a trigger delay for analysis measurements in terms of a certain number of sampling points. A positive "Trigger offset" specifies a delay, a negative "Trigger offset" specifies an advance trigger (pre trigger). Any integer value between -5000 to 50000 can be selected.
A/B15:	Sample length (1-5000 points) The sample length is the number of samples that are taken for a measurement signal analysis.



A/B16:	Sample Interval (0.01-1000 ms) The sample interval is the time interval between two consecutive samples used for measurement or signal analysis. Both the "Sample length" and the "Sample Interval" makes the total measuring time for one sample cycle. The total time for one sample cycle is equal to the "Sample length" x "Sample Interval".
A/B17:	Sample start [ON OFF] Setting the "Sample start" to ON initialises a sample or analysis measurement. After "Sample start" has been set to ON the sampling circuit waits for a trigger event. This can be either an internal or external trigger. After detecting the trigger condition, the input signal is sampled using the given "Sample interval" (see A/B16) and the given "Sample length" (see A/B15). The number of times this measurement cycle is repeated is given by the "Trigger count" (see A/B13). If "Trigger timeout" (see (A/B10) is set to a value greater than 0 and no trigger condition is met after "Sampling start" is set to ON for the time specified by "Trigger timeout" the error message "Trigger timeout" is displayed on the LCD. Both conditions - a normal end of measurement or a "Trigger timeout" - will reset the "Sample start" to OFF.
A/B18:	Read SAMP. Values Press ENT to display After a successful input signal measurement (sampling, see A/B17), press the ENTER key to display the results at the sampling points. Specific values can be selected with the arrow keys or the rotary knob.
A/B19:	Meas. + Read Type [AVER] PEAK MIN HIGH LOW RMS The "Meas. + Read Type" menu item lets you select a signal analysis type with the right or the left arrow key. After selecting one of the 6 possible settings, the result can be displayed by changing to menu item A/B20. Because all possible analysis types are calculated internally after each sampling cycle every setting is allowed.



A/B20:	<p>READ xxx Value (Result)</p> <p>The “READ xxx Value” menu item (xxx = AVER PEAK MIN HIGH LOW RMS) (see also A/B19) displays the result for the selected analysis function. If there is no result available (because there is no data that can be analyzed) only a line is displayed.</p>
A/B21:	<p>Maximum output Voltage (0.000-15.000 V)</p> <p>This menu item is an NGMO2 safety feature. Setting a voltage value below 15.000 volts limits the maximum settable output voltage in the main display to the voltage given here. A connected device is therefore protected from voltages above the maximum allowed ratings.</p>
A/B22:	<p>Maximum output Current (0.000-5.000 A)</p> <p>This menu item is an NGMO2 safety feature. Setting a current value below 5.000 Amperes limits the maximum settable output current limit in the main display to the current limit given here. A connected device is therefore protected from currents above the maximum allowed ratings.</p>
A/B23:	<p>Beep on Current limit: [on] off</p> <p>When “Beep on Current limit” is set on the NGMO2, there is a short beep whenever the NGMO2 enters the current limit state.</p>
A/B24:	<p>Common Output on off: [on] off</p> <p>When “Common Output on off” is set to OFF, the key “OUTP. on/off” switches only the output channel that is currently displayed or selected via remote command ON or OFF. If “Common Output on/off” is set to ON, the “OUTP. on/off” key acts simultaneously on both output channels. A remote command also acts on both channels.</p>



A/B25:	Relay 1 [on] off Turns the output driver for relay 1 on or off. The driver signal is applied to the "Control I/O" connector, Pin 1 on the rear panel (ground on pin 8 and 9).
A/B26:	Relay 2 [on] off Turns the output driver for relay 2 on or off. The driver signal is applied to the "Control I/O" connector, Pin 2 on the rear panel (ground on pin 8 and 9).
A/B27:	Relay 3 [on] off Turns the output driver for relay 3 on or off. The driver signal is applied to the "Control I/O" connector, Pin 3 on the rear panel (ground on pin 8 and 9).
A/B28:	Relay 4 [on] off Turns the output driver for relay 4 on or off. The driver signal is applied to the "Control I/O" connector, Pin 4 on the rear panel (ground on pin 8 and 9).
A/B29:	Recall setting when power on (0-10) The NGMO2 saves sets of settings in an internal EEPROM. With the menu item "Recall settings when power on" a user can select, which of the stored settings are loaded when the device is powered up. 0: use factory defaults after power up 1 to 9: use user-defined settings, that have been previously stored with the "SAVE" function 1 to 9. 10: use the last manual settings as the new power up settings.
A/B30:	IEEE Address (1-30) This setting specifies the IEEE address of the NGMO2. This setting is independent of the setting made with menu item 29 (Recall setting, when power on).



A/B31:	<p>Serial interface [on] off</p> <p>When set to ON, a RS232 connection to the NGMO2 can be used as a remote interface. This setting is independent of the setting made with menu item 29 (Recall setting when power on).</p>
A/B32:	<p>Serial Speed (300, 600, 1200, 2400, 4800, 9600, 19200, 38400 Baud)</p> <p>With this menu item the speed (Baud Rate) for the serial interface can be set using the rotary knob. Numerical entries can not be made with the "SHIFT" key. This setting is independent of the setting made with menu item 29 (Recall setting, when power on).</p>
A/B33:	<p>Serial count of Databits [7] 8</p> <p>This menu item selects the data length for the serial interface. This can be either 7 bits or 8 bits. Note, when a data length of 7 is selected only even or odd parity can be used due hardware limitations of the internal interface. This setting is independent of the setting made with menu item 29 (recall setting when power on).</p>
A/B34:	<p>Serial Parity [node] odd even</p> <p>With menu item "Serial Parity" the user can select the data integrity checking method for serial communication. This setting is independent of the setting made with menu item 29 (recall setting when power on).</p> <p>none: No check bits are sent or received and checked.</p> <p>odd: The number of ones in a data word (including parity bit) is odd.</p> <p>even: The number of ones in a data word (including parity bit) is even.</p>



A/B35:	Serial count of stopbits [1] 2 This menu item is used to select “Serial count of stopbits” for data transmission. When set to 1, only one stopbit is transmitted before the start of the next data byte. When set to 2, two stopbits are transmitted before the next data byte - this means synchronisation is better but there are fewer transfers per second. This setting is independent of the setting made with menu item 29 (recall setting when power on).
A/B36:	Serial Handshake [none] HW xon/xoff This menu item lets you set the serial handshake mode. <ul style="list-style-type: none">• none: NGMO2 does not use handshaking for serial communication. This mode assumes that both ends are always ready for data transfers.• HW: NGMO2 uses the serial handshake lines RTS and CTS for handshaking. If RTS is low, (not active) no data must be sent to NGMO2. If CTS is low, no data is send from NGMO2.• Xon/XOff: NGMO2 uses a software handshake for serial communication. The Xoff control character suspends serial communication; XON continues serial communication.
A/B37:	Serial Receive Delimiter: [CR] LF The setting of “Serial Receive Delimiter” decides which control character is used for delimiting a command that is sent to the NGMO2 using the serial interface. If CR is set, the NGMO2 waits for a carriage return (Control M) as the end of command character. If LF is set, NGMO2 waits for a line feed (Control J). If LF is set, a CR may precede the delimiter LF. This setting is independent of the setting made with menu item 29 (recall setting when power on).

**A/B38:****Calibration mode****Press ENT to select**

After pressing the enter key the user enters the calibration mode for the NGMO.

See Service Manual – Chapter 7 (192.1500.82)

NOTE:

The calibration of the Power Supply NGMO has to be made by Rohde & Schwarz personnel or an authorized company.



4.3 Test Connections



ELECTROCUTION HAZARDS!

Observe the relevant safety regulations when operating electrical devices.

Do not float the power supply output more than 25 V from chassis.

Otherwise, in addition to the output voltage above 50 VDC can increase at the terminals and present electric shock hazard to the operator.

4.3.1 Remote Sense

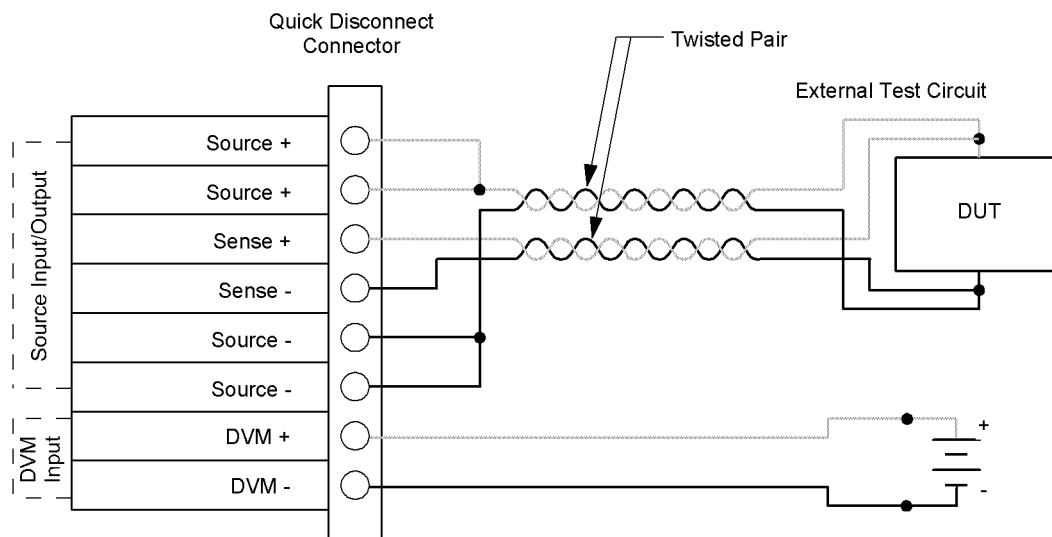

Fig. 4-2 Four-wire sense connection

As shown in Fig. 4-2 the channels are intended to be operated with remote sense leads (4-wire connection). The sense+ and sense- pins provide output voltage sensing.

Use voltage protection to turn off the output and protect against extremes (refer to 4.1: Operating Elements, 4.2.3: Menu).

Make sure, that the senses are properly connected.

Connect the sense inputs to the NGMO2 as close as possible to the load's source inputs using twisted pairs (see Fig. 4-2). This is necessary to achieve the maximum transient performance of the NGMO2.

4.3.2 Local sense

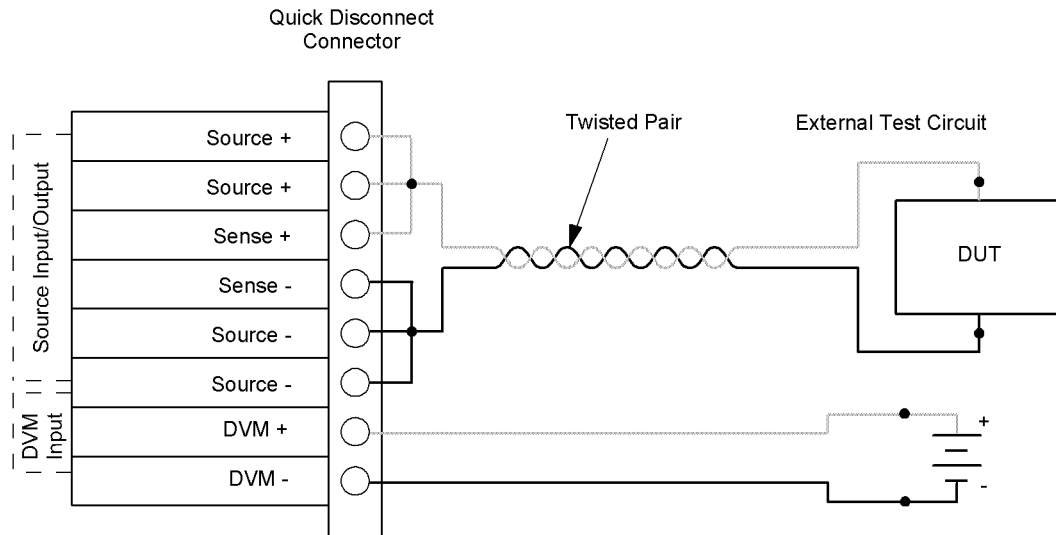

Fig. 4-3 Local sense connections

The NGMO2 can be connected to operate with local sense leads (2-wire connection) as shown in Fig. 4-3. When this connection scheme is used the sense inputs and supply outputs are jumpered at the rear of the NGMO2.

4.3.3 Output Impedance

The NGMO2 has a variable output impedance feature on both channels. This output impedance setting allows the performance of the battery channel to closely model a real battery's performance with a dynamic load. When setting the output impedance to a certain value (R_I), the output voltage drop will be proportional to the output current (see formula below). The output voltage will be reduced by the voltage drop. Voltage drop equation: $V_{drop}(t) = R_I \times I(t)$



4.4 Factory Defaults

The NGMO can be set to power up using the factory default conditions or the user-saved setup conditions. The factory defaults are listed in chapter 5 IEEE Commands.



Meaning:

- **x.yy** is the version number of the currently installed firmware
x = major version number,
yy = minor version number.
- **nn** = currently selected IEEE address for the device
- **Az** = type of power supply board mounted at location A in the NGMO. Currently, only type 3 is available.
- **Bz** = type of power supply board mounted at location B in the NGMO2. Currently only type 3 is available.

Next screen after 2 seconds:

(1)

"AS x.xxxV y.yyy A" (1)
 "A:OFF PROT RDY REM"

or

(2)

"BS x.xxxV y.yyy A" (2)
 "B:OFF PROT RDY REM"

or

(3)

"DVMA: z.zzz V" (3)
 "A:OFF PROT RDY REM"

or

(4)

"DVMB: z.zzz V" (4)
 "B:OFF PROT RDY REM"

The examples above illustrating display depend on the current setting and the current NGMO2 mode.



4.5 Measurements

The NGMO2 provides three multiplexed measure channels on each supply channel (A/B) for the measurement of output VOLTAGE and CURRENT as well as for the additional DVM input. The VOLTAGE channel is used only for static measure functions (readback), CURRENT and DVM channels are used for static and dynamic measure functions.

The value ranges represented below are valid for static and dynamic measurements.

Measurement	-OVR	displayed values	OVR
DVM	-6 V	-5.999 - 25.999 V	≥ 26 V
Voltage	-	0.000 - 15.999 V	≥ 16 V
Current			
Current Range 1	≥ -4 A	-3.9999 - 7.0000 A	> 7 A
Current Range 2	-	0.00 - 510.00 mA	> 510 mA
Current Range 3	-	0.0000 - 5.1000 mA	> 5.1 mA
Autorange	Change Range at Borders		
	R1 to R2: 0.5000 A R2 to R3: 5.00 mA R3 to R2: 5.1000 mA R2 to R1: 510.00 mA		

4.5.1 Reading back Voltage (V), Current (I), DVM

The sample interval for the static measurements (readback) is settable between 2 and 200 ms in 1-ms steps. An averaging over up to ten values can be selected for this measurements.

4.5.2 Dynamic Measurements

Dynamic measurements are available for the CURRENT channel in the 5 A and 0.5 A range and for the DVM channel. The measure system of the NGMO2 allows to record current and voltage waveforms with sampling frequencies up to 100 k-samples per second. That means samples can be taken and stored in time intervals off 10 μ s. Because using a Sigma-Delta AD converter with an high internal sampling rate, even very short events ($\ll 10$ μ) will have an influence on the delivered



sample value. That is important to protect against losing information when observing signals over a long time period.

The sample interval can be set between 10 μs and 1 s in 10 μs steps. At sample intervals greater than 10 μs the NGMO2 measure system samples internally in 10 μs intervals and averages the taken samples to build values in the selected time intervals.

Example:

With a selected sampling interval of 1.00 ms every sample value that is stored in the measurement buffer is an average out of 100 samples.

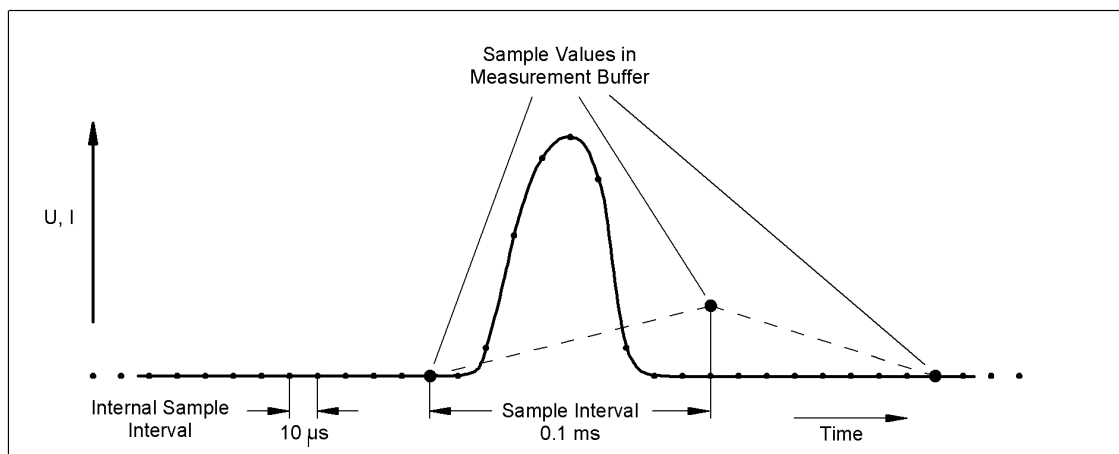

Fig. 4-4 Sample values

The measurement buffer is able to store up to 5000 sample values which can be read out separately to generate graphic representations and which are used to build the specific pulse values as AVERage, PEAK, MIN, HIGH, LOW and RMS.

By selecting a sample Interval of 1 s and the maximum sample number of 5000, the NGMO2 is able to observe a signal for a time period of more than 80 minutes without losing significant information about the signal course.

4.5.2.1 Trigger System

A dynamic measurement sequence is specified by the selected sample interval (0.01 ... 1000.00 ms) and the required number of sample points (Sample Length: 1... 5000). It is initialized by starting the sample mode (Sample Start > „on“) and then the trigger system detects the valid sample values depending on the selected trigger parameters. The measurement stops if either the selected number of values has been taken or the measurement buffer is full.

The trigger system allows the start of recording a signal before, at or after the trigger signal. Therefore a trigger offset can be set between - 5000 to 50000. With a positive trigger offset a trigger delay can be generated depending on the selected sample interval.

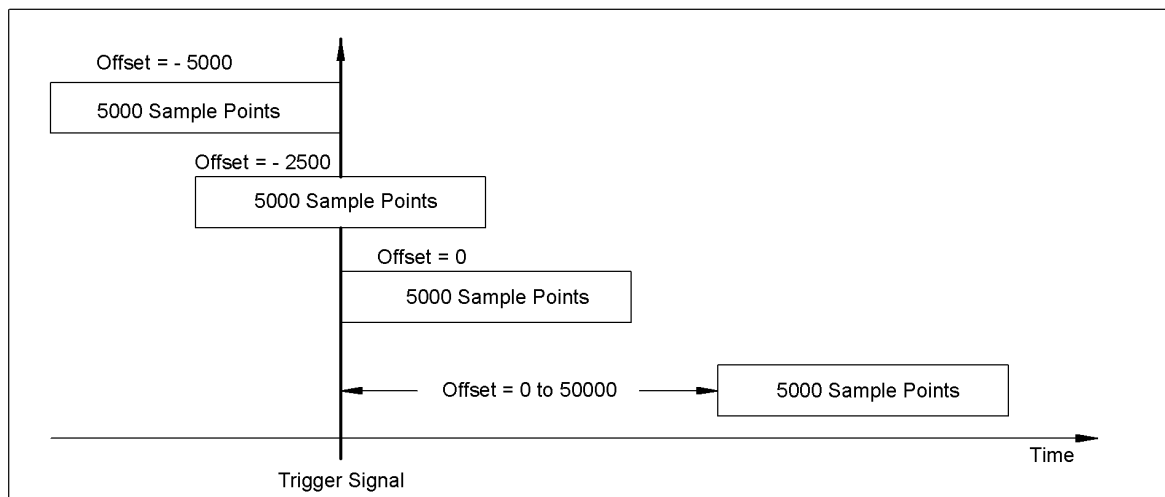

Fig. 4-5 Pre-trigger and post-trigger acquisition

The trigger system of the NGMO2 allows the automatic repetition of such measurement sequences up to 99 times to build average pulse values. Therefore a triggercount is settable between 1 and 100 in the menu which represents the number of sequences to be executed before the measurement is stopped.

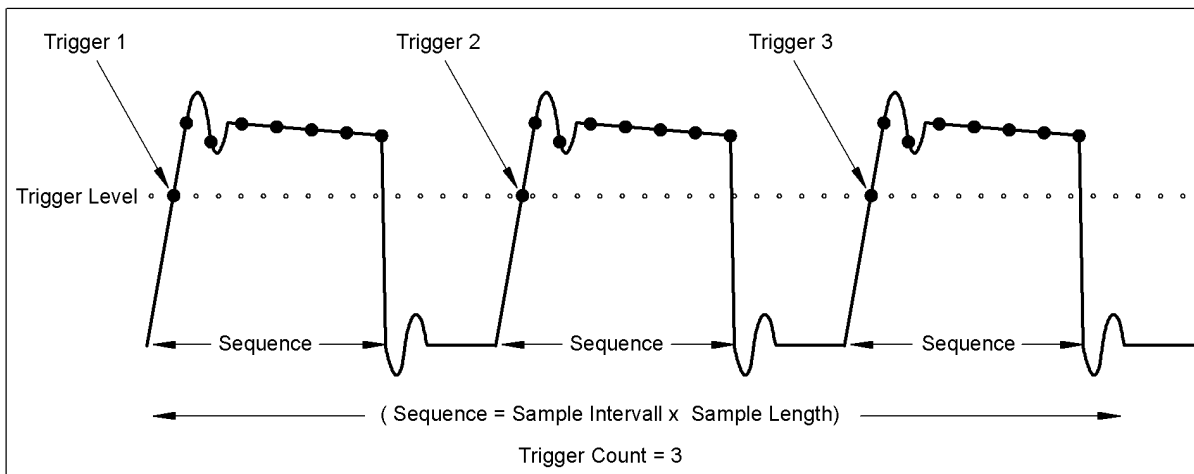

Fig. 4-6 Measurement repetition

NOTE:

The post- or pre-trigger is only available for a single sample sequence (triggercount = 1). With a selected triggercount > 1 data acquisition starts at the trigger signal for any sequence.

For each measurement range the trigger level is settable in the specified value borders with the given resolution of that range. With setting the trigger level to the low border of the selected measurement range, the AUTO TRIGGER is activated for that range. In this mode when starting a sample sequence the trigger system searches for a significant value change of the watched signal and sets the trigger level automatic if such a value change occurs.

In remote mode also software triggered measurements are possible with the NGMO.

4.5.2.2 Pulse Analysing

The NGMO2 provides the analysing of pulsed signals, which delivers the values of several pulse characterising sizes. This values are formed out of the samples as described below.

For all values the following applies to the result. With a selected triggercount x greater than one at first the pulse value is formed for each of the x single measurement sequences and than the average of these x values is formed to get the final result.



PEAK: The absolute highest sample that occurs during the measurement sequence is stored as the PEAK value.

MIN: Analogous to PEAK the absolute lowest sample value is used to form the MIN value.

For the computation of the **HIGH**, **LOW**, **AVERAge** and **RMS** values a imaginary „change level“ is used representing the middle between the PEAK value and the MIN value. This „change level“ is used to detect the beginnings and the ends of signal periods and the change between high and low fragments of the signal course.

NOTE:



The pulse analysis for the HIGH, LOW, AVERAge and RMS values delivers correct results only for periodical signals.

HIGH: For the HIGH value the average of all samples with values higher than the change level is formed and stored.

LOW: For the LOW value the average of all samples with values lower than the change level is formed and stored.

AVER: For the computation of the AVERAge value only complete recorded signal periods are considered and the average of all samples belonging to this periods is formed and stored.

RMS: For the computation of the RMS value only complete recorded signal periods are considered and the square average of all samples belonging to this periods is formed and stored.



4.6 Status Structure

The NGMO2 provides a series of status registers and queues allowing the operator to monitor and manipulate the various instrument events. The status structure is shown in Fig. 4-4. The heart of the status structure is the status byte register. This register can be read by the user's test program to determine if a service request (SRQ) has occurred, and what event caused it.

4.6.1 Status Byte and SRQ

The status byte register receives the summary bytes of four status register sets and two queues. The register sets and queues monitor the various instrument events. When an enabled event occurs, it sets a summary bit in the status byte register. When a summary of a status byte is set and its corresponding enable bit is set (as programmed by the user), the RQS/MSS bit will set to indicate that an SRQ has occurred.

4.6.1.1 Status Register Sets

A typical status register set is made up of a condition register, an event register and an event enable register. A condition register is a read-only register that is continuously updated to reflect the present operating conditions of the instrument.

When an event occurs, the appropriate event register bit is set to 1. The bit remains latched to 1 until the register is reset. When an event register bit is set and its corresponding enable bit is set (as programmed by the user), the output (summary) of the register is set to 1, which in turn sets the summary bit of the status byte register.

4.6.2 Queues

The NGMO2 uses an output queue and an error queue. The response messages to query commands are placed in the output queue. As various programming errors and status messages occur, they are placed in the error queue. When a queue contains data, it sets the appropriate summary bit of the status byte register.

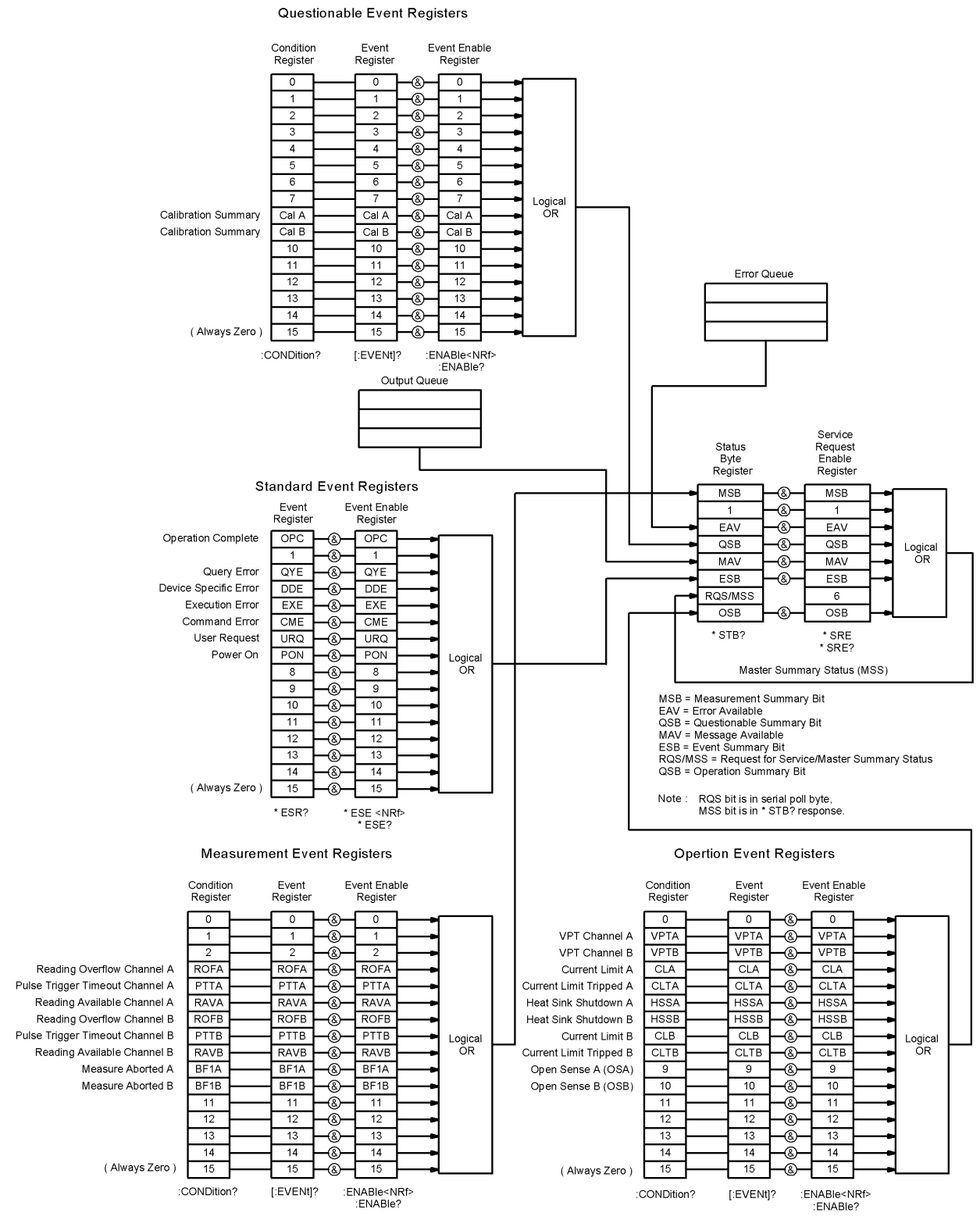

Fig. 4-7 Status model structure





5 IEEE Commands

* = Factory defaults

<NUM_VAL> = integer or real

<CHAR_VAL> = string

5.1 IEEE-488-2 common commands and queries

Command	Parameter	Par. value	Description	Def.	SCPI
*CLS		See status model structure for further information	Clears all event registers and error queues		
*ESE	<NUM_VAL>	See status model structure for further information	Program the standard event enable register		
*ESE?	<NUM_VAL>	See status model structure for further information	Reads the standard event enable register		
*ESR?		See status model structure for further information	Reads the standard event enable register and clears it		
*IDN?			Returns the manufacturer, model number, serial number, and firmware revision levels of the unit		
*OPC			Sets the operation complete bit in the standard event register		
*OPC?			Places an ASCII "1" into the output queue when selected device operations have been completed		
*RCL	<CHAR_VAL> or <NUM_VAL>		Returns the power supply to the user-saved setup (0...9)		
		0	Factory settings		
		1	First user setting		
		9	Ninth user setting		
		MIN	Factory settings		
		MAX	Ninth user setting		
*RCL?	<CHAR_VAL>		Queries the possible min and Max value		



Com-mand						Parameter	Par. value	Description	Def.	SCPI
							MIN	0		
							MAX	9		
*RST								Returns the power supply to the *RST default conditions		
*SAV						<CHAR_VAL> or <NUM_VAL>		Saves the present setup as the user-saved setup (1..9)		
							1	First user setting		
							9	Ninth user setting		
							MIN	First user setting		
							MAX	Ninth user setting		
*SAV?						<CHAR_VAL>		Queries the possible min and max value		
							MIN	1		
							MAX	9		
*SRE						<NUM_VAL>	See status model structure for further information	Programs the service request enable register		
*SRE?						<NUM_VAL>	See status model structure for further information	Queries the service request enable register		
*STB?							See status model structure for further information	Reads the status byte register		
*ARM								Sends a "SENSE:PULSE:START ON" command to both channels		
*AARM								Sends a "SENSE:PULSE:START ON" command to channel A		
*BARM								Sends a "SENSE:PULSE:START ON" command to channel B		
*TRG								Sends a "SENSE:PULSE:START ON" and a soft trigger command to both channels		
*ATRg								Sends a "SENSE:PULSE:START ON" and a soft trigger command to channel A		



Com-mand						Parameter	Par. value	Description	Def.	SCPI
*BTRg								Sends a "SENSE:PULSE:START ON" and a soft trigger command to channel B		
*TST?								Performs a checksum test on ROM and returns 0 for test OK and 1 for test failed		
*WAI								Waits until all previous commands are executed		
:DISPlay	:ENABle					<CHAR_VAL>		Enables or disables the LC Display	ON	✓
							OFF	Turns display off (fast data mode)		
							ON	Turns display on		
							MIN	Turns display off		
*							DEFault	Turns display on		
							MAX	Turns display on		
:DISPlay	:ENABle?					<CHAR_VAL>		Queries status of display		
								Results:		
								OFF		
								ON		
							MIN	OFF		
							DEFault	ON		
							MAX	ON		
:DISPlay	:CHANnel					<CHAR_VAL>		Changes the active display channel		
							A	Channel A	A	
							B	Channel B		
							DVMA	DVM A		
							DVMB	DVM B		
							MIN	Channel A		
							DEFault	Channel A		
							MAX	DVM B		
:DISPlay	:CHAN-nel?							Queries the active display channel setting		
								Results:		
								A		
								B		
								DVMA		
								DVMB		
							MIN	A		
							DEFault	A		



	Com- mand						Parameter	Par. value	Description	Def.	SCPI
								MAX	DVMB		



5.2 FORMAT command summary

Com- mand						Parameter	Par. value	Description	Def.	SCPI
:FORMat	[:DATA]					<CHAR_VAL>		Specifies the output data format for Fetch, Read and Message command.	ASCII	✓
							ASCIi	ASCII		
							LONG	Long integer		
							SREaI	Short real		
							DREaI	Double real		
							MIN	ASCII		
*							DEFault	ASCII		
							MAX	Double real		
:FORMat	[:DATA]?					<CHAR_VAL>		Queries selected data format		
								Results:		
								ASCII		
								LONG		
								SREAL		
								DREAL		
							MIN	ASCII		
							DEFault	ASCII		
							MAX	DREAL		
:FORMat	:BORDER					<CHAR_VAL>		Specifies byte order for non ASCII output formats.		✓
							NORMAL	Normal byte order (MSB first)	NOR- MAL	
							SWAPPed	Swapped byte order (LSB first)		
							MIN	Normal		
*							DEFault	Normal		
							MAX	Swapped		
:FORMat	:BORDER?							Queries byte order		
								Results:		
								NORMAL		
								SWAPPED		
							MIN	NORMAL		
							DEFault	NORMAL		
							MAX	SWAPPED		



5.3 OUTPut command summary

Command					Parameter	Par. value	Description	Def.	SCPI
:OUT	[:A]				<CHAR_VAL>	OFF	Turns output A off	OFF	
					<CHAR_VAL>	ON	Turns output A on		
:OUT	:B				<CHAR_VAL>	OFF	Turns output B off	OFF	
					<CHAR_VAL>	ON	Turns output B on		
:OUTPut	[:A]						Channel A / Channel 1		
:OUTPut	[1]						Channel A / Channel 1		
:OUTPut	:B						Channel B / Channel 2		
:OUTPut2							Channel B / Channel 2		
		[:STATe]			<CHAR_VAL>		Turns output ON or OFF (A or B)	OFF	✓
						OFF	Turns output off		
						ON	Turns output on		
						MIN	Turns output off		
*						DEFault	Turns output off		
						MAX	Turns output on		
						DISPlay	Sets LCD to main screen		
		[:STATe]?			<CHAR_VAL>		Queries state of output		
							Results:		
							OFF		
							ON		
						MIN	OFF		
						DEFault	OFF		
						MAX	ON		
		:OPEN-sense			<CHAR_VAL>	OFF	Turns open sense detection off		
						ON	Turns open sense detection on		
						MIN	Turns open sense detection off		
						DEFault	Turns open sense detection on		
						MAX	Turns open sense detection on		
		:OPEN-sense?			<CHAR_VAL>		Queries of open sense detection setting		
							OFF		
							ON		
						MIN	OFF		
*						DEFault	ON		
						MAX	ON		



IEEE Commands

Power Supply NGMO

Com-mand					Parameter	Par. value	Description	Def.	SCPI
		:BAND-width			<CHAR_VAL>		Selects slow or fast regulation speed	HIGH	✓
						HIGH	Bandwidth high		
						LOW	Bandwidth low		
						MIN	Bandwidth high		
*						DEFault	Bandwidth high		
						MAX	Bandwidth low		
						DISPlay	Sets LCD to OUTPUT BANDWIDTH		
		:BAND-width?			<CHAR_VAL>		Queries bandwidth settings		
							Results:		
							LOW		
							HIGH		
						MIN	HIGH		
						DEFault	HIGH		
						MAX	LOW		
		:IMPe-dance			<CHAR_VAL> or <NUM_VAL>		Specifies the output impedance to apply. 0 Ohms to 10hms in 10 mOhm steps	0 Ohms	
						0.00	0 Ohm		
						1.00	1 Ohm		
						MIN	Impedance 0 Ohm		
*						DEFault	Impedance 0 Ohm		
						MAX	Impedance 1 Ohm		
						DISPlay	Sets LCD to OUTPUT IMPEDANCE		
		:IMPe-dance?			<CHAR_VAL>		Queries impedance settings		
							Results:		
							0.00 <= NUM_VAL <= 1.00		
						MIN	0.00		
						DEFault	0.00		
						MAX	1.00		
:OUTPut	[A]								
		:RELAy1					Relay 1		
		:RELAy2					Relay 2		
		:RELAy3					Relay 3		
		:RELAy4					Relay 4		
					<CHAR_VAL>		Closes or opens relay control circuit	ZERO or OFF	
						ZERo	Opens		
						ONE	Closes		
						OFF	Opens		



Command						Parameter	Par. value	Description	Def.	SCPI
							ON	Closes		
							MIN	Opens		
*							DEFAult	Opens		
							MAX	Closes		
							DISPlay	Sets LCD to RELAIS <n>		
			:RELAy1?					Relay 1		
			:RELAy2?					Relay 2		
			:RELAy3?					Relay 3		
			:RELAy4?					Relay 4		
						<CHAR_VAL>		Queries the ON / OFF state of the corresponding relay port pin / digital I/O		
								Results:		
								OFF		
								ON		
							MIN	OFF		
							DEFAult	OFF		
							MAX	ON		



5.4 SENSE command summary

Com- mand						Parameter	Par. value	Description	Def.	SCPI
:SENSe	[:A]							Channel A / Channel 1		
:SENSe[1]								Channel A / Channel 1		
:SENSe	:B							Channel B / Channel 2		
:SENSe2								Channel B / Channel 2		
		:FUNction				<CHAR_VAL>		Selects Fetch, Read, Measure function type	VOLT AGE	
							"VOLTage" or VOLTage	Static voltage measurement		
							"CURRent" or CURRent	Static current measurement		
							"DVMeter" or DVMeter	Static DVM measurement		
							"AVERage" or AVERage	Average and sample measurement		
							"PEAK" or PEAK	Peak and sample measurement		
							"MIN" or MIN	Min and sample measurement		
							"HIGH" or HIGH	High and sample measurement		
							"LOW" or LOW	Low and sample measurement		
							"RMS" or RMS	Rms and sample measurement		
		:FUNction ?						Queries measurement setting		
								Results:		
								VOLTAGE		
								CURRENT		
								DVMETER		
								AVERAGE		
								PEAK		
								MIN		
								HIGH		
								LOW		
								RMS		
		:CURRent	[:DC]	:RANGe	[:UPPer]	<CHAR_VAL>		Selects expected current measurement range	HIGH or 5[A]	
							HIGH or 5[A]	5A		
							MEDIUm or 0.5[A]	500mA		



Command						Parameter	Par. value	Description	Def.	SCPI
							LOW or 0.005[A]	5mA		
							AUTO	Auto ranging		
							MIN	Auto ranging		
*							DEFault	5A		
							MAX	5mA		
							DISPlay	Sets LCD to: CURRENT RANGE		
		:CURRent	[:DC]	:RANGe	[:UPPer]?	<CHAR_VAL>		Queries current range		
								HIGH		
								MEDIUM		
								LOW		
								AUTO		
							MIN	AUTO		
							DEFault	HIGH		
							MAX	LOW		
		:MEASure	:INTerval			<CHAR_VAL> or <NUM_VAL>		Sets the measurement interval for voltage and current	1	
							2.00E-03	Measurement interval = 2 ms		
							2.00E-01	Measurement interval = 200 ms		
							MIN	2 ms		
*							DEFault	10 ms		
							MAX	200 ms		
							DISPlay	Sets LCD to STATIC MEASURE INTERVAL		
		:MEASure	:INTerval?			<CHAR_VAL>		Queries measurement interval		
								Results:		
								2E-3 <= NUM_VAL <= 0.2		
							MIN	0.002 ms		
							DEFault	0.01 ms		
							MAX	0.2 ms		
		:AVERage	[:COUNT]			<CHAR_VAL> or <NUM_VAL>		Sets the measurement average count	1	
							1	Average count = 1		
							10	Average count = 10		
							MIN	1		
*							DEFault	1		
							MAX	10		



Com- mand					Parameter	Par. value	Description	Def.	SCPI
						DISPlay	Sets LCD to STATIC AVERAGE COUNT		
		:AVERage	[:COUNT]?		<CHAR_VAL>		Queries measure- ment interval		
							Results:		
							1 <= NUM_VAL <= 10		
						MIN	1		
						DEFault	1		
						MAX	10		
		:PULSe	:TRIGger	:STATE?			Queries current trigger status		
							Results:		
							NONE		
							TRIGGERED		
							READY		
							TIMEOUT		
		:PULSe	[:MEAS- ure]	:CHANnel	<CHAR_VAL>		Selects pulse measurement channel	CUR- RENT	
						CURRent	Current measurement		
						DVM	DVM measure- ment		
						MIN	Current measurement		
*						DEFault	Current measurement		
						MAX	DVM measure- ment		
						DISPlay	Sets LCD to SAMPLE CHANNEL		
		:PULSe	[:MEAS- ure]	:CHAN- nel?	<CHAR_VAL>		Queries pulse measurement channel		
							Results:		
							CURRent		
							DVM		
						MIN	CURRENT		
						DEFault	CURRENT		
						MAX	DVM		
		:PULSe	[:MEAS- ure]	:START	<CHAR_VAL>		Select pulse measurement state	OFF	
						OFF	Off		
						ON	On		
						MIN	Off		
*						DEFault	Off		



Com- mand						Parameter	Par. value	Description	Def.	SCPI
							MAX	On		
							DISPlay	Sets LCD to SAMPLE START		
		:PULSe	[:MEAS- ure]	:START?		<CHAR_VAL>		Queries pulse measurement status		
								Results:		
								OFF		
								ON		
							MIN	OFF		
							DEFault	OFF		
							MAX	ON		
		:PULSe	[:MEAS- ure]	:TYPE		<CHAR_VAL>		Selects pulse measurement and read type	AVER AGE	
*							AVERage	Average		
							PEAK	Peak		
							MIN	Min		
							HIGH	High		
							LOW	Low		
							RMS	Rms		
							DISPlay	Sets LCD to MEASURE + READ TYPE		
		:PULSe	[:MEAS- ure]	:TYPE?		<CHAR_VAL>		Queries pulse measurement and read type		
								Results:		
								AVERAGE		
								PEAK		
								MIN		
								HIGH		
								LOW		
								RMS		
		:PULSe	:TRIGger	:LEVel	:HIGH	<CHAR_VAL> or <NUM_VAL>		Sets trigger level for 5A (HIGH) range	2.5 A	
							1.00E-04	0.1 mA		
							7	7 A		
							AUTO or 0	Auto trigger		
							MIN	0 mA -> AUTO		
*							DEFault	2.5 A		
							MAX	7 A		
							DISPlay	Sets LCD to TRIGGER LEVEL RANGE 5A		
		:PULSe	:TRIGger	:LEVel	:HIGH?	<CHAR_VAL>		Queries trigger level for 5A (HIGH) range		
								Results:		



Com- mand						Parameter	Par. value	Description	Def.	SCPI
								1E-4 <= NUM_VAL <= 7		
							MIN	0.0		
							DEFault	2.5		
							MAX	5.0		
		:PULSe	:TRIGger	:LEVel	:LOW	<CHAR_VAL> or <NUM_VAL>		Sets trigger level for 0.5A (LOW) range	2.5 mA	
							1.00E-05	0.01 mA		
							0.5	500 mA		
							AUTO or 0	Auto trigger		
							MIN	0A -> AUTO		
*							DEFault	250mA		
							MAX	500 mA		
							DISPlay	Sets LCD to TRIGGER LEVEL RANGE 0.5 A		
		:PULSe	:TRIGger	:LEVel	:LOW?	<CHAR_VAL>		Queries trigger level for 5mA range		
								Results:		
								1E-5 <= NUM_VAL <= 0.5		
							MIN	0.0		
							DEFault	2.5E-1		
							MAX	5.0E-1		
		:PULSe	:TRIGger	:LEVel	:DVM	<CHAR_VAL> or <NUM_VAL>		Sets trigger level DVM	0 V	
							-5.999	-5.999 Volt		
							25.000	25.000 Volt		
							MIN	AUTO		
*							DEFault	0 Volt		
							MAX	25.000 Volt		
							DISPlay	Sets LCD to TRIGGER LEVEL DVM		
							AUTO	Auto trigger		
		:PULSe	:TRIGger	:LEVel	:DVM?	<CHAR_VAL>		Queries trigger level DVM		
								Results:		
								-5.999 <= NUM_VAL <= 25.000		
							MIN	AUTO		
							DEFault	0.000		
							MAX	25.000		
		:PULSe	:TRIGger	:SOURce		<CHAR_VAL>		Selects trigger source	INT	
							INT	Intern		
							EXT	Extern		



Command					Parameter	Par. value	Description	Def.	SCPI
						MIN	Intern		
*						DEFAult	Intern		
						MAX	Extern		
						DISPlay	Sets LCD to TRIGGER SOURCE		
		:PULSe	:TRIGger	:SOURce?	<CHAR_VAL>		Queries trigger source		
							Results:		
							INT		
							EXT		
						MIN	INT		
						DEFAult	INT		
						MAX	EXT		
		:PULSe	:TRIGger	SLOPe	<CHAR_VAL>		Selects trigger slope	POS	
						POS	Positive		
						NEG	Negative		
						MIN	Positive		
*						DEFAult	positive		
						MAX	Negative		
						DISPlay	Sets LCD to TRIGGER SLOPE		
		:PULSe	:TRIGger	SLOPe?	<CHAR_VAL>		Queries trigger slope		
							Results:		
							POS		
							NEG		
						MIN	POS		
						DEFAult	POS		
						MAX	NEG		
		:PULSe	:SAMPle	:LENGth	<CHAR_VAL> or <NUM_VAL>		Sets sample length	1	
						1	Sample length 1		
						5000	Sample length 5000		
						MIN	Sample length 1		
*						DEFAult	Sample length 1		
						MAX	Sample length 5000		
						DISPlay	Sets LCD to SAMPLE LENGTH		
		:PULSe	:SAMPle	:LENGth?	<CHAR_VAL>		Queries sample length		
							Results:		
							1 <= NUM_VAL <= 5000		
						MIN	1.00		



Com- mand					Parameter	Par. value	Description	Def.	SCPI
						DEFAult	1.00		
						MAX	5000.00		
		:PULSe	:TRIGger	:OFFSet	<CHAR_VAL> or <NUM_VAL>		Sets trigger offset	0	
						-5000	Trigger offset -5000		
						50000	Trigger offset 50000		
						MIN	Trigger offset -5000		
*						DEFAult	Trigger offset 0		
						MAX	Trigger offset 50000		
						DISPlay	Sets LCD to TRIGGER OFFSET		
		:PULSe	:TRIGger	:OFFSet?	<CHAR_VAL>		Queries trigger offset	0	
							Results:		
							-5000 <= NUM_VAL <= 50000		
						MIN	-5000.00		
						DEFAult	0.00		
						MAX	50000.00		
		:PULSe	:TRIGger	:COUNT	<CHAR_VAL> or <NUM_VAL>		Sets trigger count	1	
						1	Trigger count 1		
						100	Trigger count 100		
						MIN	Trigger count 1		
*						DEFAult	Trigger count 1		
						MAX	Trigger count 100		
						DISPlay	Sets LCD to TRIGGER COUNT		
		:PULSe	:TRIGger	:COUNT?	<CHAR_VAL>		Queries trigger count		
							Results:		
							1 <= NUM_VAL <= 100		
						MIN	1.00		
						DEFAult	1.00		
						MAX	100.00		
		:PULSe	:TRIGger	:TIMEout	<CHAR_VAL> or <NUM_VAL>		Sets trigger timeout	INFI- NITE	
						0.001	Triggers timeout 0.001 sec.		
						60	Triggers timeout 60 sec.		
						INFinite	Triggers timeout infinite		



Command						Parameter	Par. value	Description	Def.	SCPI
							MIN	Triggers timeout infinite		
*							DEFault	Trigger timeout infinite		
							MAX	Trigger timeout 60		
							DISPlay	Sets LCD to TRIGGER TIMEOUT		
		:PULSe	:TRIGger	:TIMEout?		<CHAR_VAL>		Queries trigger timeout		
								Results:		
								0 <= NUM_VAL <= 60		
							MIN	INFINITE		
							DEFault	INFINITE		
							MAX	60.00		
		:PULSe	:SAMple	:INTerval		<CHAR_VAL> or <NUM_VAL>		Sets sample interval	1.0E-3	
							1.0E-5	Sample interval 0.01 msec.		
							1	Sample interval 1 sec.		
							MIN	Sample interval 0.01 msec.		
*							DEFault	Sample interval 1 msec.		
							MAX	Sample interval 1 sec.		
							DISPlay	Sets LCD to SAMPLE INTERVAL		
		:PULSe	:SAMple	:INTerval?		<CHAR_VAL>		Queries sample interval		
								Results:		
								1E-5 <= NUM_VAL <= 1		
							MIN	1E -5		
							DEFault	1E -3		
							MAX	1.00		



5.5 SOURCE command summary

Com- mand					Parameter	Par. value	Description	Def.	SCPI
:SOURce	[:A]						Channel A / Channel 1		
:SOURce	[1]						Channel A / Channel 1		
:SOURce	:B						Channel B / Channel 2		
:SOURce2							Channel B / Channel 2		
		:VOLTage	:PROTEction		<CHAR_VAL> or <NUM_VAL>		Sets VPT offset in 100mV steps	2.0	
						1.5	1.5 Volt		
						22	22 Volt		
						MIN	1.5 Volt		
*						DEFault	22 Volt		
						MAX	22 Volt		
						DISPlay	Sets LCD to VOLTAGE PROTECTION		
		:VOLTage	:PROTEction?		<CHAR_VAL>		Queries VPT offset		
							Results:		
							0.0 <= NUM_VAL <= 10.0		
						MIN	0.00		
						DEFault	2.0		
						MAX	10.0		
		:VOLTage	:PROTEction	:STATE?			Queries VPT state		
							Results:		
							0 -> not triggered		
							1 -> triggered		
		:VOLTage	:MAXSet- ting		<CHAR_VAL> or <NUM_VAL>		Sets max. settable output voltage	15	
						0.00	0 Volt		
						15.00	15 Volt		
						MIN	0 Volt		
*						DEFault	15 Volt		
						MAX	15 Volt		
						DISPlay	Sets LCD to Maximum output voltage		
		:VOLTage	:MAXSet- ting?		<CHAR_VAL>		Queries max. settable output voltage		
							Results:		
							0.000 <= NUM_VAL <= 15.000		



Command						Parameter	Par. value	Description	Def.	SCPI
							MIN	0		
							DEFAult	15		
							MAX	15		
		:VOLTage	[[:LEVel]	[[:IMMediate]	[[:AMPLitude]	<CHAR_VAL> or <NUM_VAL>		Sets voltage amplitude in 1 mV steps	0	
							0.000	0 Volt		
							15.000	15 Volt		
							MIN	0 Volt		
*							DEFAult	0 Volt		
							MAX	15 Volt		
							DISPlay	Sets LCD to main display		
		:VOLTage	[[:LEVel]	[[:IMMediate]	[[:AMPLitude]?	<CHAR_VAL>		Queries voltage amplitude		
								Results:		
								0.000 <= NUM_VAL <= 15.000		
							MIN	0		
							DEFAult	0		
							MAX	15		
		:CURRent	[[:LIMit]	[[:VALue]		<CHAR_VAL> or <NUM_VAL>		Sets current limit in Amps (max. 2.5A on voltages above 5V)	2	
							0.000	0.000A		
							5.000	5.000A		
							MIN	0.000A		
*							DEFAult	2.000A		
							MAX	5.000A		
							DISPlay	Sets LCD to main display		
		:CURRent	[[:LIMit]	[[:VALue]?		<CHAR_VAL>		Queries current limit		
								Results:		
								0.000 <= NUM_VAL <= 5.000		
							MIN	0		
							DEFAult	5		
							MAX	5		
		:CURRent	[[:LIMit]	[[:MAXSetting]		<CHAR_VAL> or <NUM_VAL>		Sets maximum settable current limit	5	
							0.000	0.000A		
							5.000	5.000A		
							MIN	0.000A		
*							DEFAult	5.000A		
							MAX	5.000A		



Com- mand					Parameter	Par. value	Description	Def.	SCPI
						DISPlay	Sets LCD to: Maximum output current		
		:CURRent	[:LIMit]	:MAXSet- ing?	<CHAR_VAL>		Queries max. settable current limit		
							Results:		
							0.000 <= NUM_VAL <= 5.000		
						MIN	0		
						DEFault	5		
						MAX	5		
		:CURRent	[:LIMit]	:TYPE	<CHAR_VAL>		Sets current limit type	LIMIT	
						LIMit	Limit		
						TRIP	Trip		
						MIN	Limit		
*						DEFault	Limit		
						MAX	trip		
						DISPlay	Sets LCD to: Main display		
		:CURRent	[:LIMit]	:TYPE?	<CHAR_VAL>		Queries current limit type		
							Results:		
							LIMIT		
							TRIP		
						MIN	LIMIT		
						DEFault	LIMIT		
						MAX	TRIP		
		:CURRent	[:LIMit]	:STATe?			Queries current limit state		
							Results:		
							1 -> in current limit or output tripped		
							0 -> not in LIMIT / TRIP		



5.6 STATUS command summary

Command						Parameter	Par. value	Description	Def.	SCPI
:STATus								General Status commands		
	:MEAS-urement	[:EVENT]?						Read the measurement event register. See status model structure for further information.		
								Results:		
								0 to 32767		
	:MEAS-urement	:ENABle				<NUM_VAL>	0 to 32767	Program the measurement enable register. See status model structure for further information		
	:MEAS-urement	:ENABle?						Read the measurement enable register		
								Results:		
								0 to 32767		
	:MEAS-urement	:CONDitio n?						Read the measurement condition register. See status model structure for further information		
								Results:		
								0 to 32767		
	:OPER-ation	[:EVENT]?						Read the operation event register. See status model structure for further information		
								Results:		
								0 to 32767		
	:OPER-ation	:ENABle				<NUM_VAL>	0 to 32767	Program the operation enable register. See status model structure for further information		
	:OPER-ation	:ENABle?						Read the operation enable register. See status model structure for further information		
								Results:		
								0 to 32767		



Com- mand						Parameter	Par. value	Description	Def.	SCPI
	:OPER- ation	:COND- ition?						Read the operation condition register. See status model structure for further information		
								Results:		
								0 to 32767		
	:QUES- tionable	[:EVENT]?						Read the questionable event register. See status model structure for further information		
								Results:		
								0 to 32767		
	:QUES- tionable	:ENABLe				<NUM_VAL>	0 to 32767	Program the questionable enable register. See status model structure for further information		
	:QUES- tionable	:ENABLe?						Read the questionable enable register. See status model structure for further information		
								Results:		
								0 to 32767		
	:QUES- tionable	:COND- ition?						Read the questionable condition register. See status model structure for further information		
								Results:		
								0 to 32767		
	:PRESet							Returns status registers to default states		
								Results:		
								none		



5.7 CONFIG command summary

Command					Parameter	Par. value	Description	Def.	SCPI
:CONFig	[A]						Channel A / Channel 1		
:CONFig	[1]						Channel A / Channel 1		
:CONFig	:B						Channel B / Channel 2		
:CONFig2							Channel B / Channel 2		
		:CURRent	:LIMit	:BEEP	<CHAR_VAL>		Beep on current limit	OFF	
						OFF	Off		
						ON	On		
						MIN	Off		
*						DEFAult	Off		
						MAX	On		
						DISPlay	Sets LCD to: Beep on current limit		
		:CURRent	:LIMit	:BEEP?	<CHAR_VAL>		Queries current limit beep		
							Results:		
							OFF		
							ON		
						MIN	OFF		
						DEFAult	OFF		
						MAX	ON		
:CONFig	[A]								
		:COMMon	:OUTPut	:ONOFF	<CHAR_VAL>		Sets output ON/OFF key to common for boths channels	OFF	
						OFF	Off		
						ON	On		
						MIN	Off		
*						DEFAult	Off		
						MAX	On		
						DISPlay	sets LCD to: Common output on/off		
		:COMMon	:OUTPut	:ONOFF?	<CHAR_VAL>		Queries common ON/OFF key function		
							OFF		
							ON		
						MIN	OFF		
						DEFAult	OFF		
						MAX	ON		



5.8 SYSTEM command summary

Com-mand						Parameter	Par. value	Description	Def.	SCPI
:SYSTem	:POSetup					<CHAR_VAL> or <NUM_VAL>		Selects default setting for power up	LAST-SET	
							0	Factory settings		
							1	First user-saved setting		
							9	Ninth user-saved setting		
*							10	Last front panel setup		
							RST	Factory settings		
							SAV1	First user-saved setting		
							SAV2	2		
							SAV3	3		
							SAV4	4		
							SAV5	5		
							SAV6	6		
							SAV7	7		
							SAV8	8		
							SAV9	Ninth user-saved setting		
							LASTset	Last front panel setup		
:SYSTem	:POSetup?					<CHAR_VAL>		Queries the default setup for power up		
								Results:		
								RST		
								SAV1		
								SAV2		
								SAV3		
								SAV4		
								SAV5		
								SAV6		
								SAV7		
								SAV8		
								SAV9		
:SYSTem	:ERRor?							Read and clear oldest message in error queue		
:SYSTem	:VERSion?							Queries SCPI version level		
:SYSTem	:PRESet							Stop all measurements and Sets NGMO2 to factory defaults		



Power Supply NGMO

IEEE Commands

Command					Parameter	Par. value	Description	Def.	SCPI
:SYSTem	:CLEar						Clears the error queue		
:SYSTem	:COMMunicate	:SERial	:ENABle		<CHAR_VAL>		Enables or disables the serial interface	OFF	
						OFF	Disable		
						ON	Enable		
						MIN	Disable		
*						DEFault	Disable		
						MAX	Enable		
						DISPlay	Sets LCD to: Serial Interface ON/OFF		
:SYSTem	:COMMunicate	:SERial	:ENABle?		<CHAR_VAL>		Queries serial interface enable ON/OFF state		
							Results:		
							OFF		
							ON		
						MIN	OFF		
						DEFault	OFF		
						MAX	ON		
:SYSTem	:COMMunicate	:SERial	:BAUD		<CHAR_VAL> or <NUM_VAL>		Sets serial baud rate	9600	
						300	300 baud		
						600	600 baud		
						1.200	1200 baud		
						2.400	2400 baud		
						4.800	4800 baud		
						9.600	9600 baud		
						19.200	19200 baud		
						38.400	38400 baud		
						MIN	300 baud		
*						DEFault	9600 baud		
						MAX	38400 baud		
						DISPlay	Sets LCD to: Serial speed		
:SYSTem	:COMMunicate	:SERial	:BAUD?		<CHAR_VAL>		Queries serial baud rate		
							Results:		
							300		
							600		
							1200		
							2400		
							4800		
							9600		
							19200		



Command					Parameter	Par. value	Description	Def.	SCPI
							38400		
						MIN	300		
						DEFault	9600		
						MAX	38400		
:SYSTem	:COMM-unicate	:SERial	:DATabits		<CHAR_VAL> or <NUM_VAL>		Sets serial data length	8	
						7	7 bits		
						8	8 bits		
						MIN	7 bits		
*						DEFault	8 bits		
						MAX	8 bits		
						DISPlay	Sets LCD to: Serial count of Databits		
:SYSTem	:COMM-unicate	:SERial	:DATabits?		<CHAR_VAL>		Queries serial data length		
							Results:		
							7		
							8		
						MIN	7		
						DEFault	8		
						MAX	8		
:SYSTem	:COMM-unicate	:SERial	:PARity		<CHAR_VAL>		Sets serial parity	NONE	
						NONE	None		
						ODD	Odd		
						EVEN	Even		
						MIN	None		
*						DEFault	None		
						MAX	Even		
						DISPlay	Sets LCD to: Serial parity		
:SYSTem	:COMM-unicate	:SERial	:PARity?		<CHAR_VAL>		Queries serial parity		
							Results:		
							NONE		
							ODD		
							EVEN		
						MIN	NONE		
						DEFault	NONE		
						MAX	EVEN		
:SYSTem	:COMM-unicate	:SERial	:STOPbits		<CHAR_VAL> or <NUM_VAL>		Sets number of stopbits	1	
						1	1 stopbits		
						2	2 stopbits		
						MIN	1 stopbits		
*						DEFault	1 stopbits		



Command					Parameter	Par. value	Description	Def.	SCPI
						MAX	2 stopbits		
						DISPlay	Sets LCD to: Serial count of stopbits		
:SYSTem	:COMM-unicate	:SERial	:STOPbits?		<CHAR_VAL>		Queries number of stopbits		
							Results:		
							1		
							2		
						MIN	1		
						DEFault	1		
						MAX	2		
:SYSTem	:COMM-unicate	:SERial	:HAND-shake		<CHAR_VAL>		Sets serial handshake mode	NONE	
						NONE	None		
						HARDware	Hardware		
						XON	Xon/xoff		
						MIN	None		
*						DEFault	None		
						MAX	Hardware		
						DISPlay	Sets LCD to: Serial Handshake		
:SYSTem	:COMM-unicate	:SERial	:HAND-shake?		<CHAR_VAL>		Queries serial handshake mode		
							Results:		
							NONE		
							XON		
							HARDWARE		
						MIN	NONE		
						DEFault	NONE		
						MAX	HARDWARE		
:SYSTem	:COMM-unicate	:SERial	:DELimiter		<CHAR_VAL>		Sets the serial delimiter	CR	
						CR	Carriage return		
						LF	Line feed		
						MIN	Carriage return		
*						DEFault	Carriage return		
						MAX	Carriage return		
						DISPlay	Sets LCD to: Serial delimiter		
:SYSTem	:COMM-unicate	:SERial	:DELimiter?		<CHAR_VAL>		Queries the serial delimiter		
							Results:		
							CR		
							LF		
						MIN	CR		
						DEFault	CR		



IEEE Commands

Power Supply NGMO

Com-mand						Parameter	Par. value	Description	Def.	SCPI
							MAX	LF		
:SYSTem	:COMM-unicate	:IEEe	:ADDRess			<CHAR_VAL> or <NUM_VAL>		Sets the IEEE address	10	
							1	Address nr. 01		
							30	Address nr. 30		
							MIN	Address nr. 01		
*							DEFault	Address nr. 05		
							MAX	Address nr. 30		
							DISPlay	Sets LCD to: IEEE Address		
:SYSTem	:COMM-unicate	:IEEe	:ADDRess ?			<CHAR_VAL>		Queries the IEEE address		
								Results:		
								01		
								30		
							MIN	01		
							DEFault	05		
							MAX	30		



5.9 Signal-oriented measurement-command summary

Command	Parameter	Par. value	Description	Def.	SCPI
:FETCh	[:A]?		Channel A / Channel 1		
:FETCh[1]?			Channel A / Channel 1		
:FETCh	:B?		Channel B / Channel 2		
:FETCh2?			Channel B / Channel 2		
			Returns the last triggered reading. Measuremode is taken from last "SENSe:FUNCTION" setting.		
:FETCh	[:A]		Channel A / Channel 1		
:FETCh[1]			Channel A / Channel 1		
:FETCh	:B		Channel B / Channel 2		
:FETCh2			Channel B / Channel 2		
	:ARRay?		Returns the last array of triggered readings. Return values are always sampling points.		
:READ	[:A]?		Channel A / Channel 1		
:READ[1]?			Channel A / Channel 1		
:READ	:B?		Channel B / Channel 2		
:READ2?			Channel B / Channel 2		
			Triggers and returns a reading. Measuremode is taken from last "SENSe:FUNCTION" setting		
:READ	[:A]		Channel A / Channel 1		
:READ[1]			Channel A / Channel 1		
:READ	:B		Channel B / Channel 2		
:READ2			Channel B / Channel 2		
	:ARRay?		Triggers and returns a array of readings. Return value are always sampling points.		



Com- mand						Parameter	Par. value	Description	Def.	SCPI
:MEASure	[:A]?							Channel A / Channel 1		
:MEASure	[1]?							Channel A / Channel 1		
:MEASure	:B?							Channel B / Channel 2		
:MEASure	2?							Channel B / Channel 2		
								Performs a READ. Measuremode is taken from last "SENSe:FUNC- tion" setting		
:MEASure	[:A]							Channel A / Channel 1		
:MEASure	[1]							Channel A / Channel 1		
:MEASure	:B							Channel B / Channel 2		
:MEASure	2							Channel B / Channel 2		
		:AVER- age?						Take a READ on AVERage function and returns the measure result		
		:PEAK?						.. for function PEAK		
		:MIN?						.. for function MIN		
		:HIGH?						.. for function HIGH		
		:LOW?						.. for function LOW		
		:RMS?						.. for function RMS		
		:VOLTage	[:DC]?					.. for function VOLTAGE		
		:CURRent	[:DC]?					.. for function CURRENT		
		:DVM?						.. for function DVM		



5.10 Remote calibration command summary

Command						Parameter	Par. value	Description	Def.	SCPI
:CAL	:ENTer	:PROT	:CODE			<NUM_VAL>	1...99999999	Unlocks calibration code	2222	
:CAL	:CHANGe	:PROT	:CODE			<NUM_VAL>	1...99999999	Sets new calibration code		
:CAL	[:A]							Channel A / Channel 1		
:CAL[1]								Channel A / Channel 1		
:CAL	:B							Channel B / Channel 2		
:CAL2								Channel B / Channel 2		
		:STEP1						Sets output to 50mV		
		:STEP2				<NUM_VAL>	0-200 mV	Reads Val from external DVM		
		:STEP3				<NUM_VAL>	14.000-16.000V	Reads Val from external DVM		
		:STEP4						Turns on measure voltage 5Volts		
		:STEP5				<NUM_VAL>	0.800 to 1.200 Ohms	Enters exact value of 1 Ohm cal resistor and do 5 Volts, 5A Calibration		
		:STEP6						Turns on measure Voltage 15 Volts		
		:STEP7				<NUM_VAL>	28.000 to 38.000 Ohms	Enters exact value of 33 Ohms cal resistor and do 15 Volts, 500 mA Calibration		
		:STEP8						Turns on measure Voltage 15 Volts		
		:STEP9				<NUM_VAL>	2800.0 to 3800.0 Ohms	Enters exact value of 3 KOhms cal resistor and do 15 Volts, 5mA Calibration		
		:DATE				<NUM_VAL>, <NUM_VAL>, <NUM_VAL>	YY, MM, DD	Sets calibration data		
		:SAVE						Save calibration data		
:CAL	:LOCK							Locks calibration		



6 Ordering Information

Pos. No.	Name	Part	Supplier	Part number
1		<p>Service Manual for NGMO1 and NGMO2</p> <p>The Service Manual provides the information necessary for calibration, fault finding and fault rectification on the NGMO.</p>	<p>Rohde & Schwarz, Cologne Department: 5 CE Phone: 49 (0)2203-51357</p>	192.1500.82
2	NGMO1	Programmable Analyzer-DC-Power Supply	RSE Munich	192.1500.21
3	NGMO2	Programmable Dual Analyzer-DC-Power Supply	RSE Munich	192.1500.24
4	NGMO2-B0	Front Panel Output Connectors	RSE Munich	192.1500.00
5	NGMO2-B1	19"-Adapter for one unit	RSE Munich	192.1500.01
6	NGMO2-B2	19"-Adapter for two units	RSE Munich	192.1500.02
7	NGMO2-K10	R&S Current Sniffer Software	RSE Munich	192.1500.04

