

Handheld Digital Oscilloscope

User Manual



1326.1578.02 – 06

This manual describes the following R&S®RTH models with firmware version 1.30:

- R&S®RTH1004 (1317.5000.K04)
- R&S®RTH1002 (1317.5000.K02)

© 2016 Rohde & Schwarz GmbH & Co. KG

Mühlhofstr. 15, 81671 München, Germany

Phone: +49 89 41 29 - 0

Fax: +49 89 41 29 12 164

Email: info@rohde-schwarz.com

Internet: www.rohde-schwarz.com

Subject to change – Data without tolerance limits is not binding.

R&S® is a registered trademark of Rohde & Schwarz GmbH & Co. KG.

Trade names are trademarks of the owners.

Throughout this manual, products from Rohde & Schwarz are indicated without the ® symbol , e.g. R&S®Scope Rider RTH is indicated as R&S RTH.

Contents

1	Getting Started.....	11
1.1	Preface.....	11
1.1.1	Key Features.....	11
1.1.2	Input Isolation.....	11
1.1.3	Measurement Categories.....	12
1.1.4	Documentation Overview.....	13
1.1.5	Regulatory Information.....	14
1.2	Preparing for Use.....	15
1.2.1	Unpacking the Instrument.....	15
1.2.2	Inserting and Charging the Battery.....	16
1.2.3	Powering On/Off.....	18
1.2.4	Using the Tilt Stand.....	18
1.2.5	EMI Suppression.....	19
1.3	Instrument Tour.....	20
1.3.1	Front View.....	20
1.3.2	Top View.....	22
1.3.3	Right View.....	23
1.3.4	Left View.....	24
1.3.5	Rear View.....	25
1.3.6	Display Overview.....	25
1.4	Operating Basics.....	26
1.4.1	Accessing the Functionality.....	26
1.4.2	Selecting the Mode.....	35
1.4.3	Displaying an Unknown Signal.....	36
1.4.4	Getting Information and Help.....	36
1.5	Maintenance.....	39
1.5.1	Cleaning.....	39
1.5.2	Data Storage and Security.....	39
1.5.3	Storing and Packing.....	40
2	Waveform Setup.....	41
2.1	Connecting Probes.....	41

2.2 Vertical Setup.....	42
2.2.1 Vertical Settings.....	42
2.2.2 Effect of the Bandwidth Filter.....	45
2.3 Horizontal Setup.....	46
2.4 Acquisition Control.....	47
2.5 Trigger.....	49
2.5.1 General Trigger Settings.....	50
2.5.2 Edge Trigger.....	53
2.5.3 Glitch Trigger.....	54
2.5.4 Width Trigger.....	55
2.5.5 Video/TV Trigger.....	57
2.5.6 External Trigger (R&S RTH1002).....	61
2.5.7 Pattern Trigger (R&S RTH-K19).....	62
2.5.8 State Trigger (R&S RTH-K19).....	64
2.5.9 Runt Trigger (R&S RTH-K19).....	65
2.5.10 Slew Rate Trigger (R&S RTH-K19).....	67
2.5.11 Data2Clock Trigger (R&S RTH-K19).....	69
2.5.12 Serial Pattern Trigger (R&S RTH-K19).....	70
2.5.13 Timeout Trigger (R&S RTH-K19).....	73
2.5.14 Interval Trigger (R&S RTH-K19).....	74
2.5.15 Window Trigger (R&S RTH-K19).....	75
2.5.16 Protocol Trigger (R&S RTH-K1, R&S RTH-K2 and R&S RTH-K3).....	76
3 Waveform Analysis.....	77
3.1 Zoom.....	77
3.2 Automatic Measurements.....	79
3.2.1 Performing Automatic Measurements.....	79
3.2.2 Measurement Results.....	79
3.2.3 Measurement Types.....	80
3.2.4 Measurement Settings.....	84
3.3 Cursor Measurements.....	85
3.3.1 Performing Cursor Measurements.....	86
3.3.2 Cursor Types and Results.....	86
3.3.3 Settings for Cursor Measurements.....	87

3.4 Mathematics	89
3.5 Reference Waveforms	91
3.5.1 Settings for Reference Waveforms.....	92
3.5.2 Waveform Files.....	93
3.6 XY-Diagram	95
3.7 History (Option R&S RTH-K15)	96
3.7.1 History Settings.....	97
3.7.2 Displaying History Data.....	98
3.7.3 Analyzing History Data.....	100
3.7.4 Exporting History Data.....	100
4 Mask Testing	102
4.1 Accessing the Mask Mode.....	102
4.2 Mask Test Results.....	102
4.3 Running Mask Tests.....	103
4.4 Mask Settings.....	104
5 Multimeter Measurements	107
5.1 Digital Multimeter (R&S RTH1002)	107
5.1.1 Accessing the Meter Mode.....	107
5.1.2 Display and Control.....	107
5.1.3 Running Multimeter Measurements.....	108
5.1.4 Settings.....	109
5.2 Voltmeter (R&S RTH1004)	111
5.2.1 Accessing the Meter Mode.....	111
5.2.2 Display and Control.....	111
5.2.3 Running Voltmeter Measurements.....	113
5.2.4 Voltmeter Settings.....	114
6 Data Logging	117
6.1 Accessing the Logger Mode.....	117
6.2 Logger Display.....	117
6.3 Logging Data.....	118
6.4 Logger Settings.....	119
6.5 Analyzing Logged Data.....	121

6.5.1	Cursor.....	121
6.5.2	Zoom.....	123
6.5.3	Logger Statistics.....	125
6.5.4	Loading Logged Data.....	125
6.5.5	Deleting Logged Data.....	126
6.5.6	Exporting Logged Data	126
7	Protocol Analysis.....	127
7.1	General Protocol Settings.....	127
7.2	I2C (Option R&S RTH-K1).....	128
7.2.1	The I ² C Protocol.....	128
7.2.2	I2C Configuration Settings.....	130
7.2.3	I2C Trigger Settings.....	130
7.3	SPI (Option R&S RTH-K1).....	133
7.3.1	The SPI Protocol.....	133
7.3.2	SPI Configuration Settings.....	134
7.3.3	SPI Trigger Settings.....	135
7.4	UART/RS-232/RS-422/RS-485 (Option R&S RTH-K2).....	137
7.4.1	The UART Interface.....	137
7.4.2	UART Configuration Settings.....	138
7.4.3	UART Trigger Settings.....	140
7.5	CAN (Option R&S RTH-K3).....	141
7.5.1	CAN Configuration Settings.....	141
7.5.2	CAN Trigger Settings.....	142
7.6	LIN (Option R&S RTH-K3).....	146
7.6.1	The LIN Protocol.....	146
7.6.2	LIN Configuration Settings.....	147
7.6.3	LIN Trigger Settings.....	149
8	Logic Analyzer (R&S RTH-B1 MSO).....	153
8.1	Logic Analyzer Settings.....	153
8.2	Triggering on Logic Channels.....	156
8.3	Analyzing Logic Channels.....	156
9	Documenting Results.....	158

9.1	Using USB Flash Drive	158
9.2	Instrument Settings	159
9.2.1	Using Fast Settings.....	159
9.2.2	Saving and Loading Savesets.....	160
9.3	Waveforms	162
9.3.1	Exporting Waveforms to File.....	162
9.3.2	Waveform Export Settings.....	162
9.3.3	Waveform Export Files.....	164
9.4	Screenshots	167
9.4.1	Screenshot Settings.....	168
9.5	Logger Records	169
9.6	Quick Save with OneTouch	169
9.7	Filesystem Tools	170
10	General Instrument Setup	172
10.1	Resetting the Instrument.....	172
10.2	Disabling the Touchscreen.....	172
10.3	Selfalignment.....	172
10.4	Setting the Date, Time and Language.....	174
10.5	Instrument Settings.....	175
10.6	Display Settings.....	177
10.7	Options.....	178
10.7.1	Activating Options.....	180
10.8	Updating the Firmware.....	181
11	Network Connections	183
11.1	LAN Connection.....	183
11.2	USB connection.....	185
11.3	Wireless LAN Connection (Option R&S RTH-K200/200US).....	185
11.4	Web Interface (Option R&S RTH-K201).....	188
12	Remote Control Commands	189
12.1	Conventions used in Command Description.....	189
12.2	Mode.....	189
12.3	Waveform Setup.....	190

12.3.1	Automatic Setup.....	190
12.3.2	Vertical Setup.....	190
12.3.3	Horizontal Setup.....	195
12.3.4	Acquisition Control.....	196
12.3.5	Trigger.....	198
12.4	Waveform Analysis.....	223
12.4.1	Zoom.....	223
12.4.2	Automatic Measurements.....	224
12.4.3	Cursor Measurements.....	227
12.4.4	Math Waveforms.....	231
12.4.5	Reference Waveforms.....	232
12.4.6	History (Option R&S RTH-K15).....	233
12.5	Mask Testing.....	236
12.5.1	Mask Definition.....	236
12.5.2	Mask Test.....	238
12.6	Digital Multimeter (R&S RTH1002).....	240
12.6.1	Activating the Multimeter mode.....	241
12.6.2	Measurement Configuration.....	241
12.6.3	Relative Measurements.....	248
12.6.4	Measurement Control.....	251
12.6.5	Results.....	252
12.7	Voltmeter (R&S RTH1004).....	257
12.7.1	Activating the Voltmeter.....	257
12.7.2	Measurement Configuration.....	257
12.7.3	Relative Measurements.....	261
12.7.4	Measurement Control.....	263
12.7.5	Results.....	265
12.8	Data Logging.....	268
12.8.1	Logger Settings.....	268
12.8.2	Cursor in Logger Mode.....	270
12.8.3	Zoom in Logger mode.....	273
12.8.4	Logger Statistics	273
12.9	Protocol Analysis.....	276

12.9.1	General Protocol Settings.....	277
12.9.2	I2C (Option R&S RTH-K1).....	277
12.9.3	SPI (Option R&S RTH-K1).....	281
12.9.4	UART/RS-232/RS-422/RS-485 (Option R&S RTH-K2).....	285
12.9.5	CAN (Option R&S RTH-K3).....	289
12.9.6	LIN (Option R&S RTH-K3).....	295
12.10	Logic Analyzer (R&S RTH-B1 MSO).....	299
12.11	Documenting Results.....	302
12.11.1	Screenshots.....	302
12.11.2	Waveform Data.....	303
12.12	General Instrument Setup.....	304
12.12.1	Date and Time.....	304
12.12.2	Display Settings.....	305
12.13	WLAN Connection (Option R&S RTH-K200/200US).....	306
	Annex.....	308
A	SCPI Command Structure.....	308
A.1	Syntax for Common Commands.....	308
A.2	Syntax for Device-Specific Commands.....	309
A.3	SCPI Parameters.....	311
A.4	Overview of Syntax Elements.....	314
A.5	Structure of a command line.....	315
A.6	Responses to Queries.....	315
B	Command Sequence and Synchronization.....	317
B.1	Preventing Overlapping Execution.....	317
	List of Commands.....	320

1 Getting Started

1.1 Preface

1.1.1 Key Features

The R&S RTH is the perfect multi-purpose tool for the lab and in the field. Outstanding key features are:

- Full isolation of all channels and interfaces
- CAT IV 600 V / CAT III 1000 V safety rating
- Bandwidth 60 MHz to 500 MHz with 5 GS/s sampling rate
- Acquisition speed up to 50.000 waveforms per second
- 2 mV/div sensitivity
- Up to 200 V offset range
- 33 automatic measurement functions
- Full operation using touch or keypad
- Wireless LAN and Ethernet for web based remote control and quick data access (optional)

The R&S RTH combines:

- Lab performance oscilloscope
- Logic analyzer with 8 digital inputs (optional)
- Protocol analyzer with trigger and decode (optional)
- Data logger
- Digital multimeter (R&S RTH1002)

1.1.2 Input Isolation

The instrument has independently floating isolated inputs. Each input channel has its own signal input and its own reference input. Each input channel is electrically isolated from the other input channels. Therefore, each reference of the used inputs must be connected to a reference voltage. Furthermore, input channels are electrically isolated from the communication ports and the power adapter input.

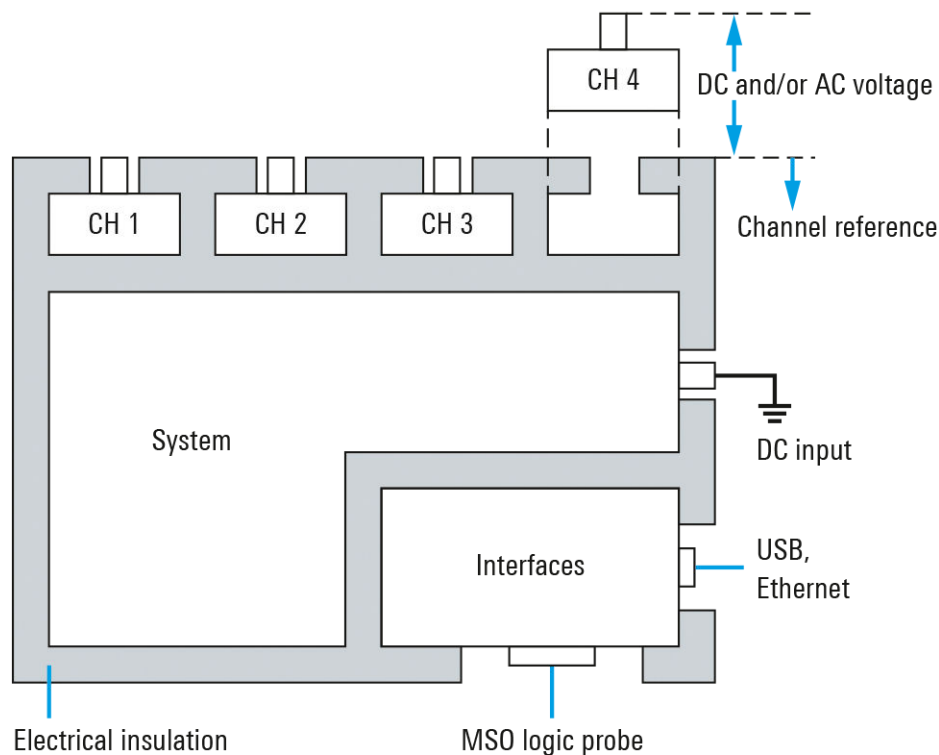

Figure 1-1: Isolation scheme of the R&S RTH

The input isolation has several advantages:

- You can measure independently floating signals simultaneously.
- The risk of causing a short circuit while measuring multiple signals is reduced substantially.
- When measuring signals with different grounds, the induced ground currents are kept to a minimum.

1.1.3 Measurement Categories

To ensure safe operation of measurement instruments, IEC 61010-2-030 defines particular safety requirements for testing and measuring circuits. The standard introduces measurement categories that rate instruments on their ability to resist short transient overvoltages that occur in addition to the working voltage of the instrument and can exceed the working voltage many times over.

Measurement categories are distinguished as follows:

- O - Instruments without rated measurement category
For measurements performed on circuits not directly connected to mains, for example, electronics, circuits powered by batteries, and specially protected secondary circuits. This measurement category is also known as CAT I.
- CAT II:

For measurements performed on circuits directly connected to the low-voltage installation by a standard socket outlet, for example, household appliances and portable tools.

- CAT III:
For measurements performed in the building installation, such as junction boxes, circuit breakers, distribution boards, and equipment with permanent connection to the fixed installation.
- CAT IV:
For measurements performed at the source of the low-voltage installation, such as electricity meters and primary overcurrent protection devices.

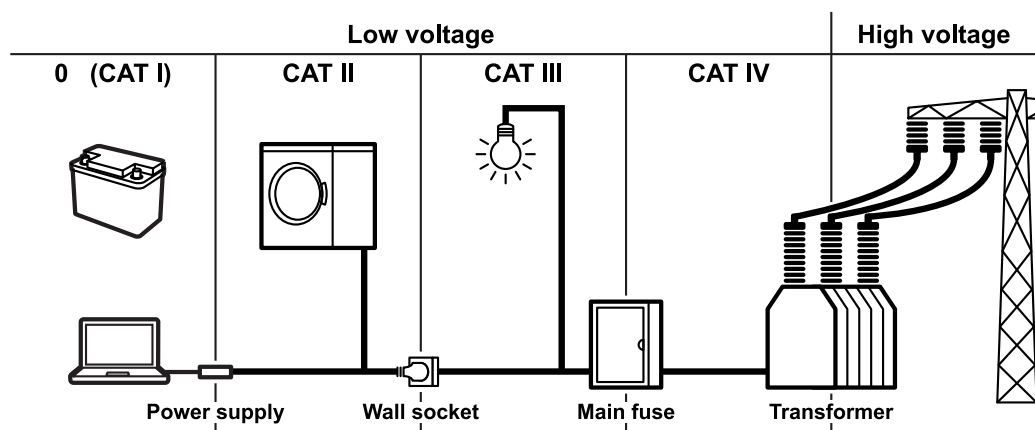

Figure 1-2: Examples of measurement categories

The higher the category, the higher the expected transient overvoltage. Overvoltages can overload a circuit and cause electrical and physical damage. Therefore, use the measurement instrument only in electrical environments for which the instrument is rated.

The measurement categories correspond to the overvoltage categories of the IEC60664 standards. Working voltages stated in context with measurement categories are always specified as effective voltages V (RMS) against earth ground.

1.1.4 Documentation Overview

The user documentation for the R&S RTH consists of the following parts:

- Instrument Help
The instrument help is part of the instrument's firmware. It offers quick, context-sensitive access to the complete information directly on the instrument.
- Basic Safety Instructions
This brochure provides safety instructions as well as operating conditions and further important information. The brochure is delivered with the instrument in printed form.
- Getting Started
The Getting Started manual provides the information needed to set up and start working with the instrument, and describes basic operations. The English edition of

this manual is delivered with the instrument in printed form. Editions in other languages, as well as newest version of the English one, are available on the product website.

- **User Manual**
The user manual describes all instrument modes and functions in detail. It also provides an introduction to remote control and a complete description of the remote control commands with programming examples. The newest version of the manual is available in English on the R&S RTH product website at www.rohde-schwarz.com/product/rth.html > "Downloads > Manuals".
- **Data Sheet**
The data sheet contains the complete instrument specification. It also lists the options and their order numbers as well as optional accessories. The data sheet is available on the R&S RTH product website at www.rohde-schwarz.com/product/rth.html > "Downloads" > "Brochures and Data Sheets".
- **Calibration Certificate**
The document is available on <https://gloris.rohde-schwarz.com/calcert>.
- **Open Source Acknowledgment**
The Open Source Acknowledgment document provides verbatim license text of open source software that is used in the instrument's firmware. It is available on the R&S RTH website at www.rohde-schwarz.com/product/rth.html > "Downloads" > "Firmware", and it can be read directly on the instrument.

1.1.5 Regulatory Information

Part 15 of the FCC and RSS-210 of IC Rules

This device complies with Part 15 of the FCC Rules and with Industry Canada licence-exempt RSS standard(s). Operation is subject to the following two conditions:

- this device may not cause harmful interference, and
- this device must accept any interference received, including interference that may cause undesired operation.

Le présent appareil est conforme aux CNR d'Industrie Canada applicables aux appareils radio exempts de licence. L'exploitation est autorisée aux deux conditions suivantes:

- l'appareil ne doit pas produire de brouillage, et
- l'utilisateur de l'appareil doit accepter tout brouillage radioélectrique subi, même si le brouillage est susceptible d'en compromettre le fonctionnement.

Changes or modifications made to this equipment not expressly approved by Rohde & Schwarz may void the FCC authorization to operate this equipment.

This equipment has been tested and found to comply with the limits for a Class A digital device, pursuant to Part 15 of the FCC Rules. These limits are designed to provide reasonable protection against harmful interference when the equipment is operated in a commercial environment. This equipment generates, uses, and can radiate radio frequency energy and, if not installed and used in accordance with the instruction manual, may cause harmful interference to radio communications. Operation of this equipment

in a residential area is likely to cause harmful interference in which case the user will be required to correct the interference at his own expense.

1.2 Preparing for Use

This section describes the basic steps to be taken when setting up the R&S RTH for the first time.

WARNING

Shock hazard caused by high voltages

The instrument must be used in an appropriate manner to prevent electric shock, fire, personal injury, or damage.

- Do not open the instrument casing.
- Do not use the instrument if the instrument casing, the display or any probe or accessory are damaged. If you detect or suspect any damage, have the instrument or accessory inspected by qualified service personnel.
- Use only specified probes and accessories that comply with the measurement category of your measurement task.
If you use other than Rohde & Schwarz accessories, make sure that they are suitable to the instrument and the measurement task.
- Do not operate the instrument in wet, damp or explosive atmospheres.
Make sure that all connectors are completely dry before connecting the inputs.
- Voltages higher than 30 V RMS or 42 V peak or 60 V DC are regarded as hazardous contact voltages. Make sure that only electrically skilled persons may use the R&S RTH for measurements on hazardous contact voltages because these working conditions require special education and experience to perceive risks and to avoid hazards which electricity can create.
- Observe the operating conditions specified in the data sheet. Note that the general safety instructions also contain information on operating conditions that will prevent damage to the instrument.
- Read and observe the "Basic Safety Instructions" delivered as a printed brochure with the instrument. In addition, read and observe the safety instructions in the following sections.

1.2.1 Unpacking the Instrument

When you receive your shipping package, unpack and inspect the package and its contents for damage.

1. Inspect the package for damage.
If the packaging material shows any signs of stress, notify the carrier as well as your Rohde & Schwarz service center. Keep the package and cushioning material

- for inspection. Keep a damaged package and the cushioning material until the contents have been checked for completeness and the instrument has been tested.
2. Unpack the handheld scope and the accessories and check the contents for completeness, see "[Package contents](#)" on page 16.
If anything is missing, contact your Rohde & Schwarz service center.
 3. Inspect the handheld scope and the accessories.
If there is any damage or defect, or if the R&S RTH does not operate properly, notify your Rohde & Schwarz service center.



Packing material

Retain the original packing material. If the instrument needs to be transported or shipped at a later date, you can use the material to protect the control elements and connectors.

Package contents

The delivery package contains the following items:

- R&S RTH handheld scope
- 4 Gbyte microSD card, installed in the battery compartment
- Power adapter with cable and adapter set for various socket types
- Battery pack
- R&S RT-ZI10 probes (2x for R&S RTH1002; 4x for R&S RTH1004)
- DMM test leads (only for R&S RTH1002)
- Hand strap, attached on the handheld scope
- Printed "Getting Started" manual and "Basic Safety Instructions" brochure

Optional accessories and their order numbers are listed in the data sheet.

1.2.2 Inserting and Charging the Battery

Before you can use the handheld scope for the first time, insert the battery pack and charge it.

WARNING

Risk of electrical shock during battery replacement

- Disconnect power supply, probes, test leads and all other cables before opening the battery cover.
- Use only the specified Li-Ion battery pack, which is delivered with the instrument. You can order additional battery packs at Rohde & Schwarz, see Data Sheet for order number.
- Do not operate the instrument with the battery cover open.
- Use only the specified power adapter, which is delivered with the instrument.

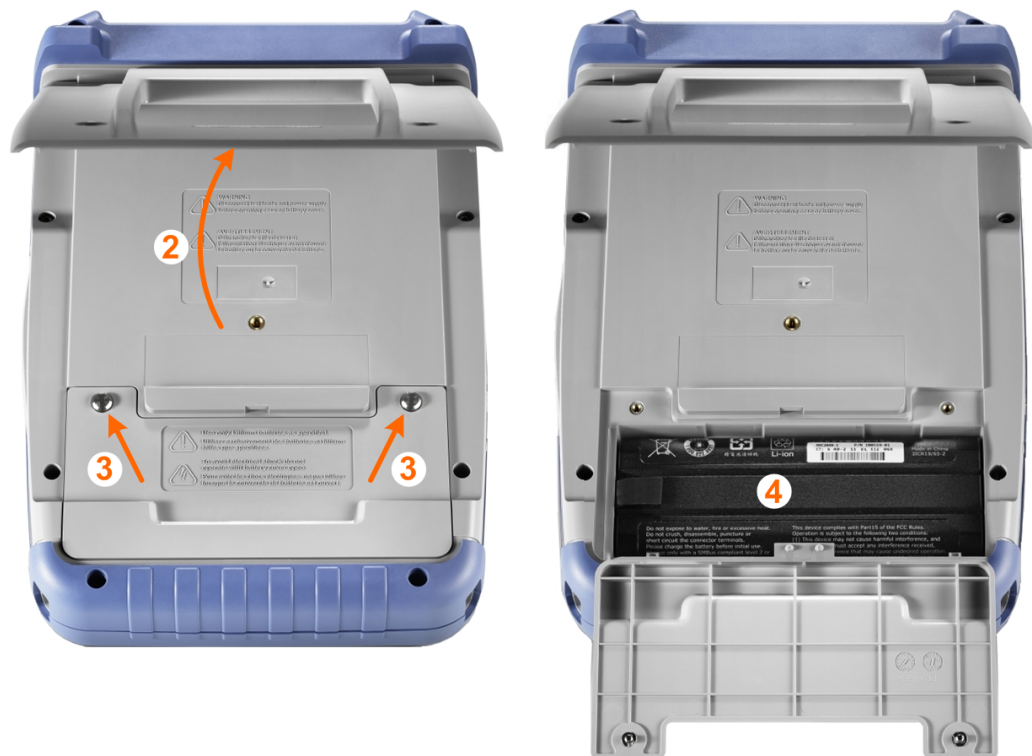

1. Turn off the instrument power. Remove power supply, probes, test leads and all other cables.
2. Fold out the tilt stand on the back of the instrument.
3. Screw open the battery cover.
4. Insert the battery pack.
5. Screw down the battery cover.
6. Connect the power adapter to the connector on the left side of the scope, and fully charge the battery. Charging may take a few hours.



If the instrument is on, the battery status is shown on the display.



Replace used batteries periodically by new batteries after 24 months of usage.

Observe the safety regulations in the "Batteries and rechargeable batteries/cells" chapter in the "Basis Safety Instructions" brochure, which is delivered with the instrument.

1.2.3 Powering On/Off

- ▶ Press the  POWER key to switch the instrument on or off.
The POWER key lights up in green color if power is on.

1.2.4 Using the Tilt Stand

The R&S RTH has a tilt stand for proper handling while the scope is placed on a table.

- ▶ Pull the tilt stand as shown below.



1.2.5 EMI Suppression

Electromagnetic Interference (EMI) may affect the measurement results.

To suppress generated Electromagnetic Interference:

- Use suitable shielded cables of high quality. For example use double-shielded RF and LAN cables.
- Always terminate open cable ends.
- Note the EMC classification in the data sheet.

1.3 Instrument Tour

1.3.1 Front View

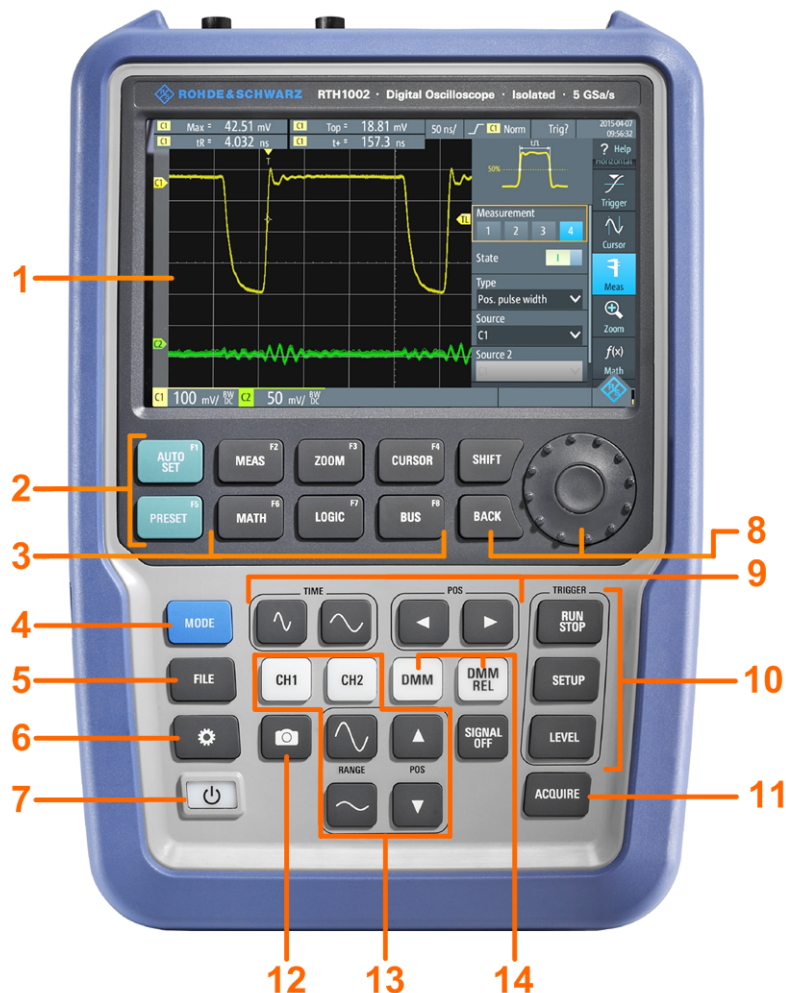

Figure 1-3: Front panel of the R&S RTH1002

- 1 = Touch display
- 2 = Waveform setup with AUTOSET, reset to default with PRESET
- 3 = Analysis functions
- 4 = Mode selection
- 5 = Save/Recall
- 6 = Instrument settings
- 7 = Power on/off
- 8 = Navigation controls
- 9 = Horizontal settings
- 10 = Run/stop acquisition and trigger settings
- 11 = Acquisition settings
- 12 = Screenshot and documentation output
- 13 = Channels and vertical settings
- 14 = Multimeter measurements

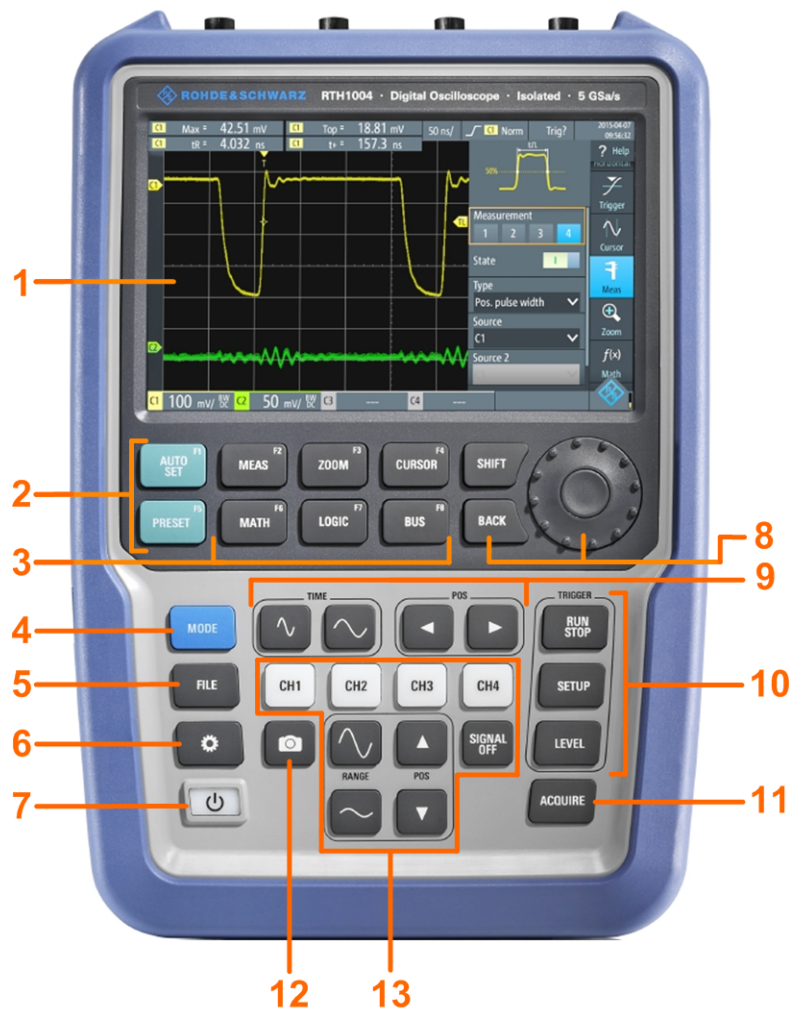

Figure 1-4: Front panel of the R&S RTH1004

- 1 = Touch display
- 2 = Waveform setup with AUTOSET, reset to default with PRESET
- 3 = Analysis functions
- 4 = Mode selection
- 5 = Save/Recall
- 6 = Instrument settings
- 7 = Power on/off
- 8 = Navigation controls
- 9 = Horizontal settings
- 10 = Run/stop acquisition and trigger settings
- 11 = Acquisition settings
- 12 = Screenshot and documentation output
- 13 = Channels and vertical settings

For a description of the keys, see [Chapter 1.4.1.3, "Using Front Panel Keys"](#), on page 33.

1.3.2 Top View

The R&S RTH1002 has two BNC input connectors CH1 and CH2, and two 4 mm banana plug inputs for multimeter measurements. The channel inputs have double channel-to-channel isolation that allows for independent floating measurements at each input. The DMM input is fully isolated from scope inputs, interfaces, and ground.



Figure 1-5: Top view of R&S RTH1002

The R&S RTH1004 has four BNC input connectors CH1, CH2, CH3, CH4. The channel inputs have double channel-to-channel isolation that allow for independent floating measurements at each input.



Figure 1-6: Top view of R&S RTH1004

⚠ WARNING

Shock hazard caused by high voltages

To avoid electrical shock and personal injury, and to prevent damage to the instrument or any other products connected to it, observe the following:

- Do not apply input voltages above the rating of the instrument and the accessories.
- Use only probes, test leads, and adapters that comply with the measurement category (CAT) of your measurement task.
- Test leads and measurement accessories used for multimeter measurements on a live mains circuit must be rated for CAT III or CAT IV according to IEC 61010-031. The voltage of the measured circuit must not exceed the rated voltage value.

Maximum input voltage:

- At BNC inputs: CAT IV 300 V
- With probe R&S RT-ZI10 or R&S RT-ZI11: CAT IV 600 V, CAT III 1000 V
- Meter input: CAT IV 600 V; CAT III 1000 V

Voltage ratings: V RMS (50 to 60 Hz) for AC sine wave and V DC for DC applications.

⚠ WARNING**Risk of electrical shock or fire**

Voltages higher than 30 V RMS or 42 V peak or 60 V DC are regarded as hazardous contact voltages. When working with hazardous contact voltages, use appropriate protective measures to preclude direct contact with the measurement setup:

- Use only insulated voltage probes, test leads and adapters.
- Do not touch voltages higher than 30 V RMS or 42 V peak or 60 V DC.

See also: [Chapter 1.1.2, "Input Isolation"](#), on page 11.

1.3.3 Right View

- 1 = LAN
- 2 = USB type B for remote control
- 3 = Probe compensation
- 4 = USB type A for flash drive
- 5 = Logic probe connector

⚠ CAUTION**Risk of injury or instrument damage**

Always close the lids of the communication ports and DC input when they are not in use.

LAN connector

RJ-45 connector to connect the instrument to a Local Area Network (LAN). It supports up to 100 Mbit/s.

USB type A connector

USB type A connector to connect a USB flash drive to store and reload instrument settings and measurement data.

USB type B connector (mini USB)

Mini USB connector to connect a computer for remote control of the instrument.

Probe compensation

Probe compensation terminal to support adjustment of passive probes to the oscilloscope channel.

Logic probe connector

Input for the logic probe R&S RT-ZL04. Logic analysis requires Mixed Signal Option R&S RTH-B1, which includes the logic probe R&S RT-ZL04.

⚠ WARNING**Risk of electrical shock - no CAT rating for MSO measurements**

The logic probe R&S RT-ZL04 is not rated for any measurement category. To avoid electrical shock or personal injury, and to prevent material damage, make sure that the ground clips of the R&S RT-ZL04 are connected to protective earth on the DUT.

1.3.4 Left View

- 1 = DC Input
- 2 = Kensington lock slot

DC Input

Connector for the power adapter to charge the battery.

Kensington lock slot

The Kensington lock is used to secure the instrument against theft.

1.3.5 Rear View



- 1 = Tilt stand to fold out
- 2 = Thread hole M5
- 3 = Battery compartment

1.3.6 Display Overview

In the most important modes scope, mask and XY, the display shows the following information.

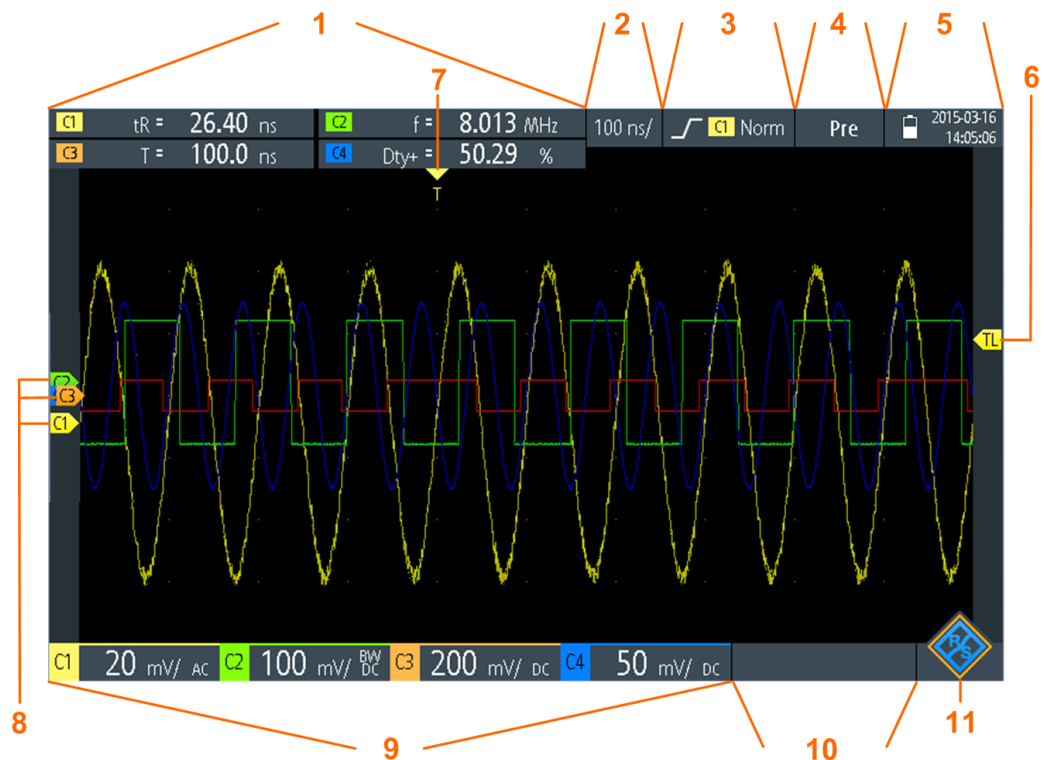

- 1 = Measurement results, depends on the mode and the selected measurement
- 2 = Time scale (horizontal scale, in s/division)
- 3 = Trigger type, trigger source, and trigger mode
- 4 = Capture status
- 5 = Battery status and AC connectivity for battery charging; date and time
- 6 = Trigger level
- 7 = Trigger position
- 8 = Channel marker indicate the ground levels. Channel C3 has the focus
- 9 = Vertical settings for each active channel: vertical scale (vertical sensitivity, in V/division), bandwidth limit (no indicator = full bandwidth, BW= limited frequency), coupling (AC or DC)
- 10 = Logic channels (MSO R&S RTH-B1)
- 11 = Menu button

You can adjust the vertical position of each waveform, the trigger level, and the trigger position by dragging the corresponding marker on the display. Alternatively, tap a marker to set the focus, and use the wheel to adjust position.

1.4 Operating Basics

1.4.1 Accessing the Functionality

The complete functionality is available in the menus and dialogs on the touchscreen. You can touch the functions directly on the display, or you can use the wheel to navigate and select. In addition, the most important functions are applied to the keys on the front panel to quickly set up and perform measurement tasks.

1.4.1.1 Using the Touchscreen

Using the touchscreen of the R&S RTH is as easy as using your mobile phone. To open the menu, tap the "Menu" button - that is the R&S logo in the right bottom corner of the display.

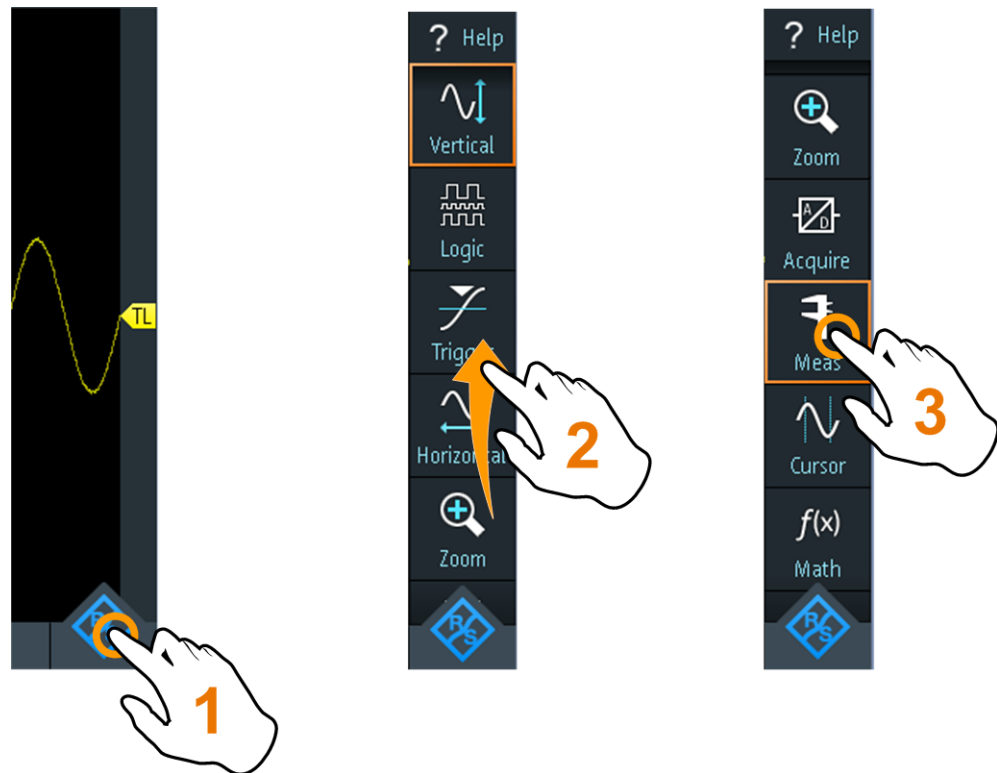

Figure 1-7: Open the menu and select a menu item



Figure 1-8: Switch on or off (left) and select a parameter value (right)

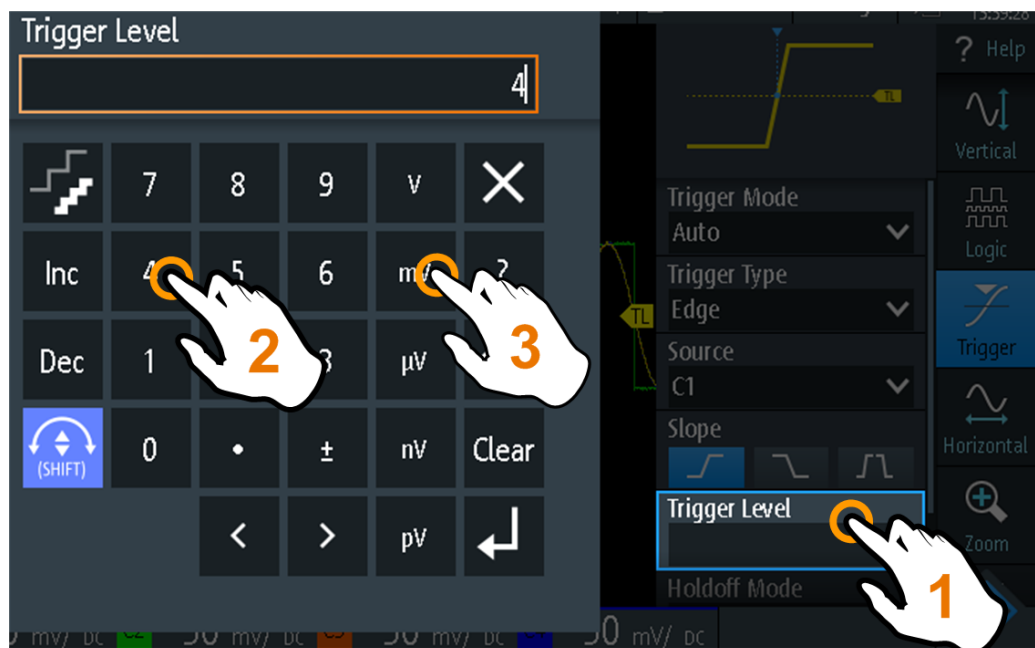

Figure 1-9: Enter numerical value and unit

1.4.1.2 Using the Navigation Wheel

In addition or alternatively to the touchscreen, you can use the wheel to control the R&S RTH.

When using the wheel, always observe the position of the focus - the orange frame or other highlighting that marks the active object on the screen.

- If the focus is on the menu button or somewhere in the menu or dialogs:
 - Turn the wheel to move the focus.
 - Press the wheel button to apply the selection.
- If the focus is on an element in the diagram, for example, on a waveform, cursor line, or trigger level:
 - Turn the wheel to change the position of the active element.
 - Press the wheel button to toggle the active element, for example, to toggle the cursor lines, or zoom size and zoom position.

The BACK key closes open dialogs and menus, and resets the focus to the "Menu" button.

Menu navigation

The following procedure describes how to access and navigate the menu. Navigating dialogs and selecting parameter values works in the same way. See also [Figure 1-10](#).

1. Press BACK until the focus is on the "Menu" button.
2. Press the wheel button to open the menu.
3. Turn the wheel to move the focus to the required menu item.
4. Press the wheel button to open the dialog, submenu, or keypad for the selected menu item.

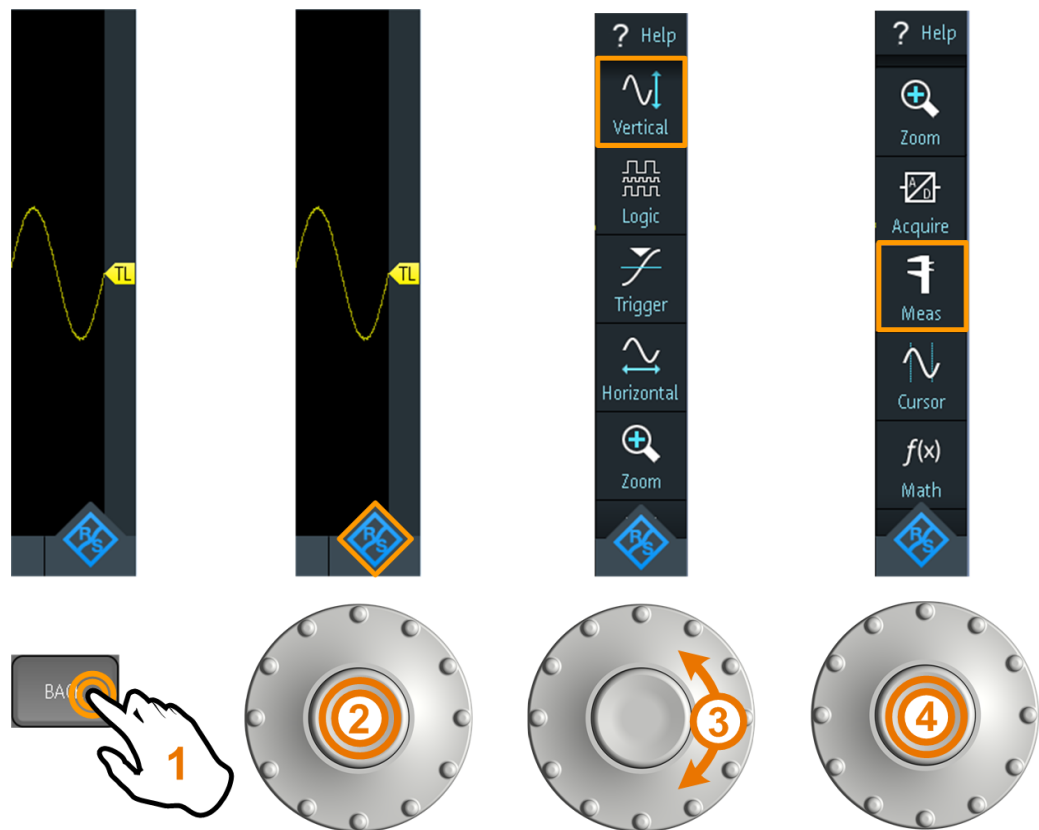

Figure 1-10: Open the menu and select a menu item

Set numerical value using the wheel

1. Set the focus to the required setting and press the wheel button *once*.
2. Turn the wheel until the required value is shown.
3. Press BACK.



Figure 1-11: Set numerical value using the wheel

Data entry using wheel and keypad

You can enter precise numerical values on the keypad. See also [Figure 1-12](#).

1. Set the focus to the required setting and press the wheel button *twice*.
2. Turn the wheel until the focus is on the required number.
3. Press the wheel button.
4. Turn the wheel until the focus is on the required unit.
5. Press the wheel button.

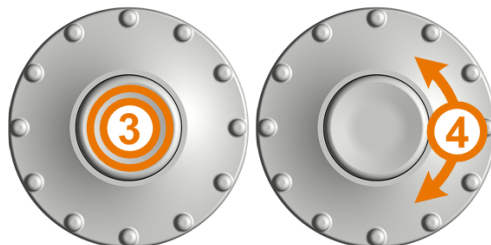
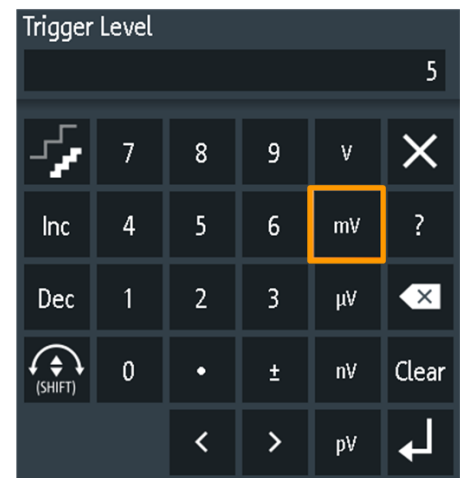
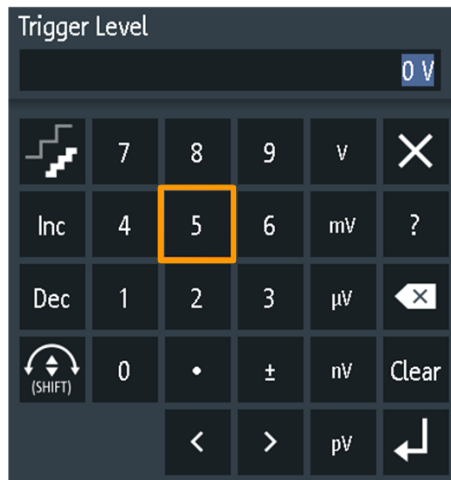
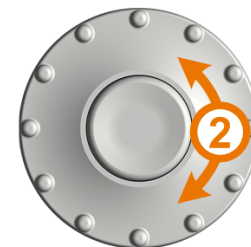
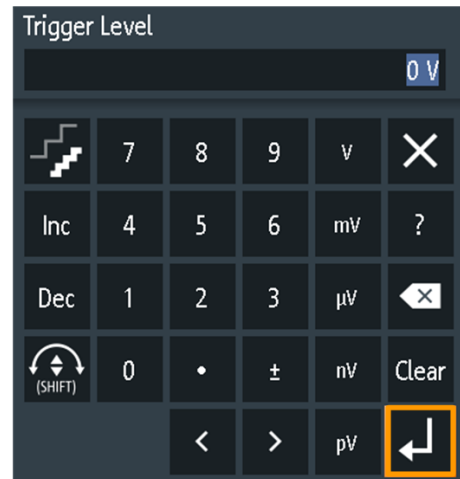



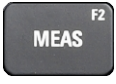
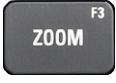

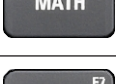



Figure 1-12: Enter numerical value and unit in the keypad











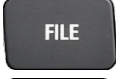



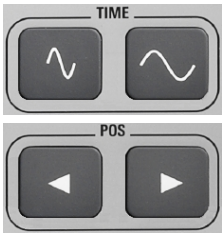

The SHIFT button toggles the wheel focus in the keypad. If the focus is on the entry field, turning the wheel changes the value. If the focus is in the lower part, the wheel selects numbers and unit.

1.4.1.3 Using Front Panel Keys

For an overview of the front panel keys, see [Figure 1-4](#)

Key	Short press	Long press
	AUTOSET analyses the active channels, adjusts the instrument settings, and displays stable waveforms.	
	PRESET sets the instrument to the default factory state.	
	MEAS starts or stops the last configured automatic measurements.	Opens or closes the "Meas" dialog to configure the measurements.
	ZOOM enables or disables the zoom with the last configuration. If the zoom is on but not in focus, pressing the key focuses the zoom.	Opens or closes the "Zoom" dialog to configure the zoom scale and position.
	CURSOR starts or stops the last configured cursor measurement. If the cursor is on but not in focus, pressing the key sets the focus to the first cursor line.	Opens or closes the "Cursor" dialog to configure the measurement.
	MATH switches the math waveform on or off.	Opens or closes the "Math" dialog to configure the math waveform.
	Requires logic analyzer option R&S RTH-B1 (MSO). The effect depends on the state of digital channels: If the all digital channels are off, the key switches D0..D7 on and sets the focus. If the digital channels are on but not in focus, the key sets the focus. If the focus is on digital channels, the key switches them off.	Opens or closes the "Logic" dialog to configure digital channels.
	Requires at least one protocol option R&S RTH-K1 or R&S RTH-K2.	
	SHIFT opens a dialog to save and load instrument settings.	
	If a dialog or menu is open, BACK closes it. If the menu is closed, the key toggles the focus between focused element in the diagram and the Menu button.	

Key	Short press	Long press
  	Open or close the "Mode", "File" or "Setup" dialog, respectively.	
	Outputs measurement documentation: saves a screenshot, waveform data, results, logger record, instrument settings, and/or text comment. You can select the data for output.	Opens or closes the "Screenshot" dialog to configure the documentation output.
All R&S RTH:  Only R&S RTH1004: 	The effect depends on the channel state: If the channel is off, the key switches the channel on and sets the focus. The key lights up. If the channel is on but not in focus, the key sets the focus. The key lights up.	Open or close the "Vertical" dialog for the correspondent channel to configure the channel settings.
Only R&S RTH1002: 	DMM starts or stops the meter measurements (same as MODE = "Meter"). DMM REL enables or disables relative meter measurements.	Opens or closes the "Meter" dialog to configure the measurements.
	TIME and POS adjust the horizontal time scale and position of the trigger point.	
	RANGE and POS set the vertical scale (vertical sensitivity) and the vertical position of the focused waveform (analog or channel, math or reference waveform).	
	SIGNAL OFF switches the focused waveform off.	
	RUN STOP starts and stops the acquisition.	
	SETUP opens or closes the "Trigger" dialog to select the trigger type and adjust the trigger settings.	

Key	Short press	Long press
	LEVEL activates the trigger level to be set using the wheel. If the trigger type has two trigger levels, pressing the key toggles the upper and lower levels.	
	ACQUIRE opens or closes the "Acquire" dialog to adjust the acquisition mode.	
	POWER key: switches the power on or off	

1.4.2 Selecting the Mode

A mode comprises all settings and functions that are needed to perform a measurement task. Selecting the mode is the first setup step.

1. Press the MODE key.

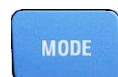

2. Select the mode:

- On the touchscreen: Tap the required mode icon.
- Using controls: Turn the wheel until the required mode is marked, and press the wheel button to select the mode.

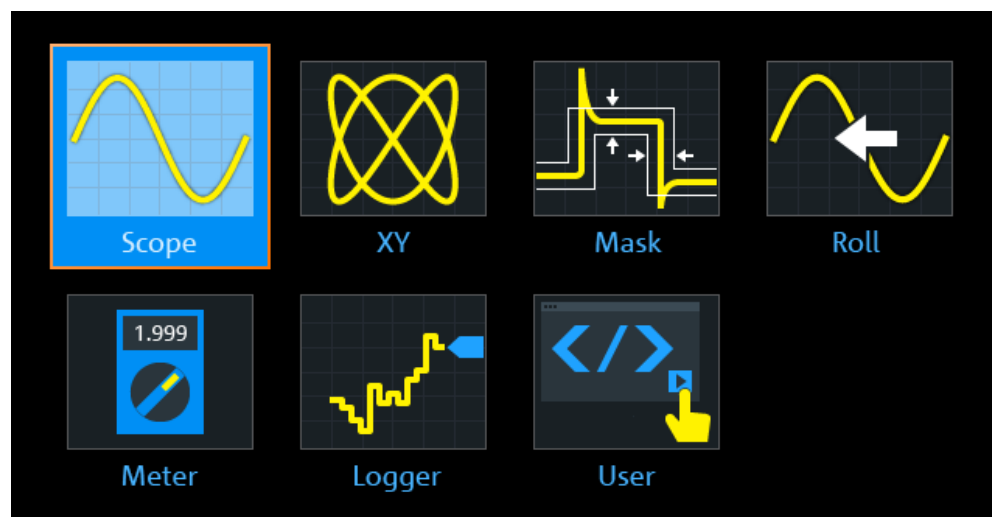

Remote command:

OP [:MODE] on page 189

1.4.3 Displaying an Unknown Signal

The R&S RTH can display unknown, complex signals automatically. The AUTOSET function analyzes the enabled channel signals, and adjusts the horizontal, vertical, and trigger settings to display stable waveforms.

1. Press the PRESET key.

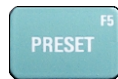

PRESET sets the instrument to a default factory state. The previous user-defined configuration is removed and all channels except for channel 1 are disabled.

2. Press the AUTOSET key.



The waveform is displayed.

1.4.4 Getting Information and Help

In most dialogs, graphics explain the meaning of the selected setting. For further information, you can open the help, which provides functional description of the settings with links to the corresponding remote commands, and background information.

1.4.4.1 Displaying Help

- ["To open the help window"](#) on page 36
- ["To show information on a setting"](#) on page 37
- ["To close the help window"](#) on page 37

To open the help window

- ▶ Tap the "Help" icon on the top of the menu.



If a dialog is open, the dialog's help topic is shown beside the dialog.
If a menu is open, the table of contents is shown.

To show information on a setting

If a dialog and the help window are open, you can easily call the information on each setting of the dialog.

- ▶ Tap the setting's *name*.

The corresponding help topic is displayed.

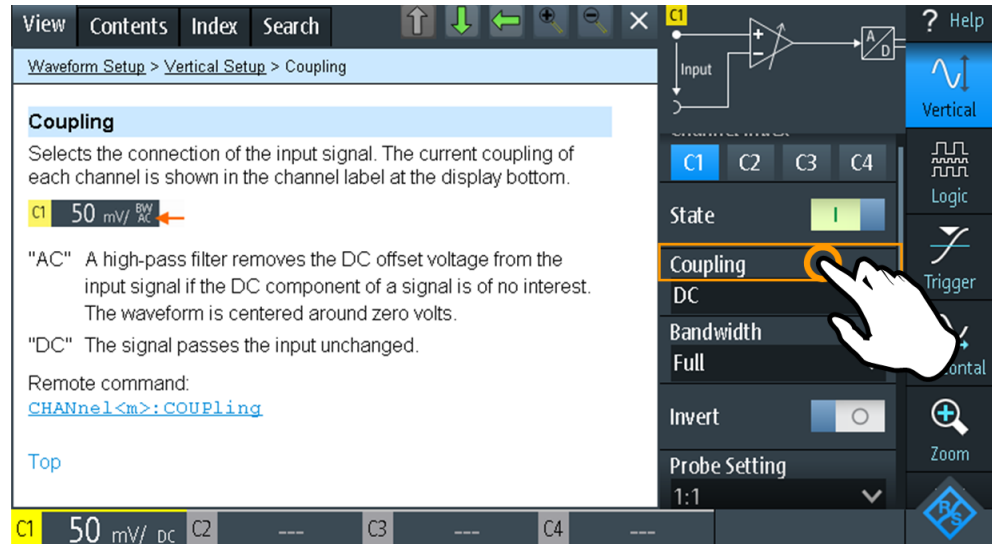

If you tap the *switch* or the *entry field*, you can adjust the setting without closing the help window.

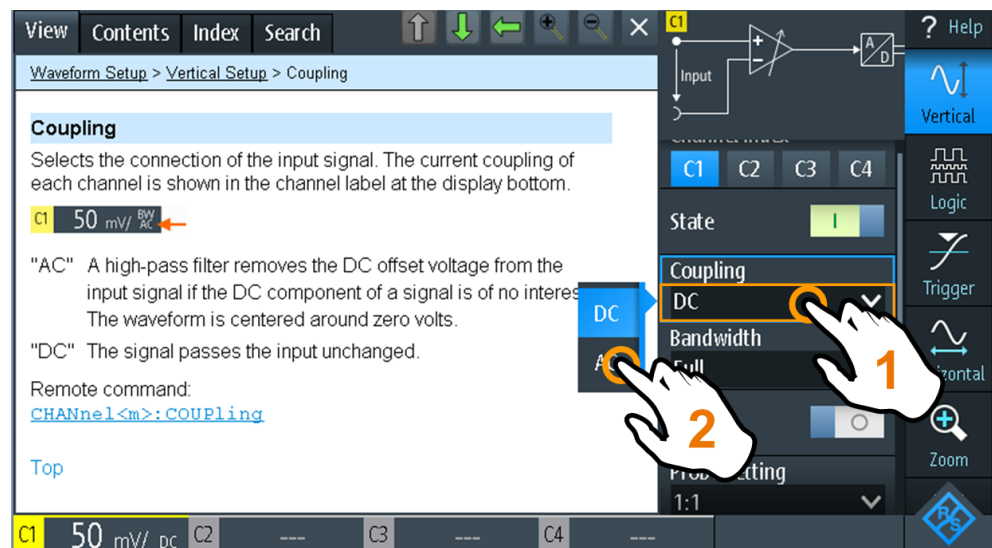

To close the help window

- ▶ Tap the "Close" icon in the upper right corner of the help window, or press BACK.

1.4.4.2 Using the Help Window

The help window has several tabs:



- "View": shows the selected help topic.
- "Contents": contains a table of help contents.
- "Index": contains index entries to search for help topics.
- "Search": provides text search.

The help toolbar provides the following buttons:



- Up and down arrows: browse the topics in the order of the table of contents. Up = previous topic, down = next topic.
- Left and right arrows: browse the topics visited before: Left = back, right = forward.
- Magnifiers: increase or decrease the font.
- ×: closes the help window.

To search for a topic in the index

The index is sorted alphabetically. You can browse the list, or search for entries.

1. Tap the "Index" tab.
2. Tap the entry field on top of the list.
3. Enter some characters of the keyword you are interested in.
You can use the Backspace key to delete single characters, and "Clear" to delete all characters in the "Keyword" field.
4. Tap the Enter key.
Now only index entries are displayed that contain the keyword characters.
5. To delete the keyword:
 - a) Tap the entry field again.
 - b) Tap "Clear".
 - c) Tap the Enter key.

To search the help for a text string

1. Tap the "Search" tab.
2. Tap the entry field on the top.
3. Enter the words you want to find.
If you enter several words with blanks between, topics containing all words are found.

To find a string of several words, enclose it in quotation marks. For example, a search for *"trigger mode"* finds all topics with exactly *"trigger mode"*. A search for *trigger mode* finds all topics that contain the words *trigger* and *mode*.

4. Tap the Enter key.
A list of search results is displayed.
5. To refine the search, use "Match Whole Word" and "Match Case", and tap "Start Search".

1.5 Maintenance

The instrument does not need a periodic maintenance. Only cleaning the instrument is essential.

The addresses of the Rohde & Schwarz support centers can be found at www.customersupport.rohde-schwarz.com.

A list of service centers is available on www.services.rohde-schwarz.com.

1.5.1 Cleaning

WARNING

Shock hazard

Before cleaning the instrument, remove all probes, leads, USB and LAN cables and power supply.

NOTICE

Instrument damage caused by cleaning agents

Cleaning agents contain substances that may damage the instrument. For example, cleaning agents that contain a solvent may damage the front panel labeling, plastic parts, or the display.

Never use cleaning agents such as solvents (thinners, acetone, etc), acids, bases, or other substances.

The outside of the instrument can be cleaned sufficiently using a soft, lint-free dust cloth.

1.5.2 Data Storage and Security

The instrument is delivered with the 4 Gbyte microSD card inserted and ready to use. We recommend that you do not remove the microSD card.

All instrument configuration data and user data are stored on the microSD card. In addition, a fallback firmware is stored on the microSD card to boot the instrument if an update failed.

If you use the instrument in a secured environment, you can remove the microSD card before the instrument leaves this area. The microSD card slot is under the right lid under the battery pack.

You can also change the microSD card if you need more memory. The instrument supports microSD cards up to 32 Gbyte.

1.5.3 Storing and Packing

The storage temperature range of the instrument is given in the data sheet. If the instrument is to be stored for a longer period of time, it must be protected against dust.

Repack the instrument as it was originally packed when transporting or shipping. The two protective foam plastic parts prevent the control elements and connectors from being damaged. The antistatic packing foil avoids any undesired electrostatic charging to occur.

If you do not use the original packaging, use a sturdy cardboard box of suitable size and provide for sufficient padding to prevent the instrument from slipping inside the package. Wrap antistatic packing foil around the instrument to protect it from electrostatic charging.

2 Waveform Setup

2.1 Connecting Probes

⚠ WARNING

Shock hazard caused by high voltages

Make sure to set the attenuation factor on the instrument according to the probe being used. Otherwise, the measurement results do not reflect the actual voltage level, and you might misjudge the actual risk.

1. Connect the probe(s) first to the channel input(s) at the top of the instrument, and then to the DUT.
2. Press and hold the CH key of the used input.
3. Select "Probe Setting".
4. Select the attenuation factor of the probe.
The probe's attenuation factor is indicated on the probe.

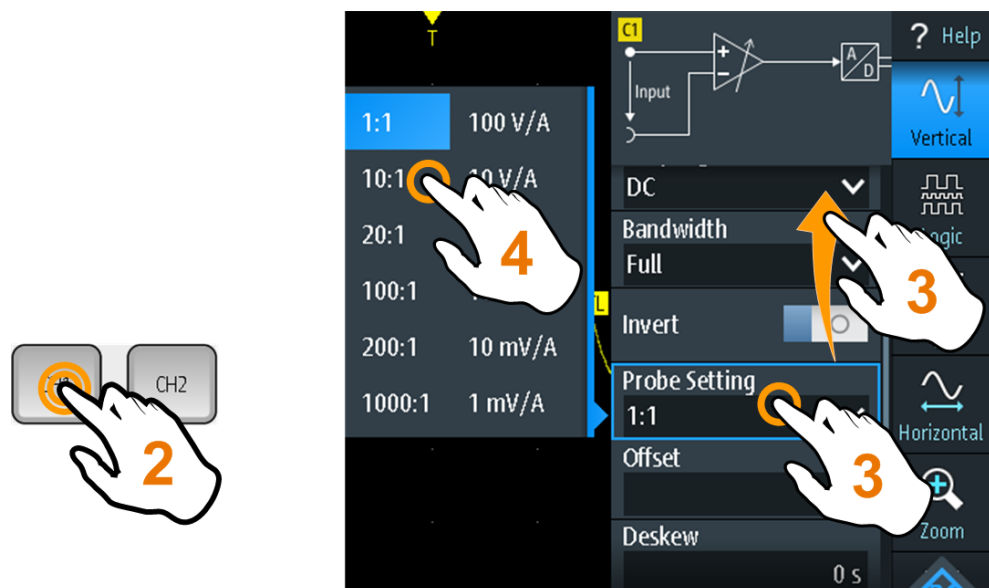

Note: If you perform current measurements using a shunt resistor as a current sensor, you have to multiply the V/A-value of the resistor by the attenuation of the probe. For example, if a $1\ \Omega$ resistor and a 10:1 probe is used, the V/A-value of the resistor is 1 V/A, the attenuation factor of the probe is 0.1, and the resulting current probe attenuation is 100 mV/A.

2.2 Vertical Setup

The controls and parameters of the vertical system adjust the scale and position of the waveform vertically.



1. To set vertical scale and position, use the RANGE and POS keys.



2. To adjust other vertical settings, select "Vertical" in the main menu.

Vertical scale and vertical position affect the resolution of the waveform amplitude directly. To get the full resolution, make sure that the waveforms cover most of the screen's height.

2.2.1 Vertical Settings

As long as the "Vertical" menu is open, the probe settings of active channels are shown on top of the display.



Channel Index

Selects the channel to be set up. All settings in the channel menu belong to the selected channel.

You can also press the channel key to select a channel. A long press of the channel key opens the correspondent channel menu.

Channel <n>

Switches the selected channel on or off.

Remote command:

[CHANnel<m>:STATe](#) on page 190

Coupling

Selects the connection of the input signal. The current coupling of each channel is shown in the channel label at the display bottom.



"AC" A highpass filter removes the DC offset voltage from the input signal if the DC component of a signal is of no interest. The waveform is centered on zero volts.

"DC" The signal passes the input unchanged.

Remote command:

[CHANnel<m>:COUPling](#) on page 192

Probe Setting

Selects the attenuation factor of the connected probe. The vertical scaling and measured values are multiplied by this factor so that the displayed values are equal to the actual signal values.

Make sure to set the attenuation factor on the instrument according to the probe being used. Otherwise, the measurement results do not reflect the actual voltage level, and you might misjudge the actual risk.

Bandwidth

Selects the bandwidth limit. The full instrument bandwidth indicates the range of frequencies that the instrument can acquire and display accurately with less than 3 dB attenuation.

For analog applications, the highest signal frequency determines the required oscilloscope bandwidth. The oscilloscope bandwidth should be at least 3 times higher than the maximum frequency included in the analog test signal to measure the amplitude with high accuracy.

Most test signals are more complex than a simple sine wave and include several spectral components. A digital signal, for example, is built up of several odd harmonics. For digital signals, the oscilloscope bandwidth should be at least 5 times higher than the clock frequency to be measured.

The oscilloscope is not a standalone system. You need a probe to measure the signal, and the probe has a limited bandwidth, too. The combination of oscilloscope and probe creates a system bandwidth. To reduce the effect of the probe on the system bandwidth, the probe bandwidth should exceed the bandwidth of the oscilloscope, the recommended factor is 1.5 x oscilloscope bandwidth.

See also: [Chapter 2.2.2, "Effect of the Bandwidth Filter"](#), on page 45.

"Full" At full bandwidth, all frequencies in the specified range are acquired and displayed. Full bandwidth is used for most applications.

"x MHz, x kHz" Frequency limit. Frequencies above the selected limit are removed to reduce noise at different levels. Limited bandwidth is indicated in the channel label.



Remote command:

[CHANnel<m>:BANDwidth](#) on page 192

Invert

Turns the inversion of the signal amplitude on or off. To invert means to reflect the voltage values of all signal components against the ground level. Inversion affects only the display of the signal but not the trigger. For example: if the oscilloscope triggers on the rising edge, the trigger is not changed by inversion, but the actually rising edge is displayed as falling edge.

Remote command:

[CHANnel<m>:POLarity](#) on page 191

Offset

Sets an offset voltage that is added to correct an offset-affected signal. The value is included in measurement results. The signal is shifted in relation to the ground level by the offset value. Negative offset values move the waveform down, positive values move it up.

Remote command:

[CHANnel<m>:OFFSet](#) on page 192

Deskew

Sets a delay for the selected channel.

Deskew compensates delay differences between channels caused by the different length of cables, probes, and other sources. Correct deskew values are important for accurate triggering. The propagation delay may lead to a non-synchronous waveform display. For example, a coax cable with a length of 1 meter has a propagation delay of typically 5.3 ns.

Remote command:

[CHANnel<m>:DESKew](#) on page 193

Technology

Sets the threshold, which is used for digitization of analog signals. If the signal value is higher than the threshold, the signal state is high (1 or true for the Boolean logic). Otherwise, if the signal value is below the threshold, the signal state is considered low (0 or false).

"Technology" Select a predefined value for one of the most common technologies, or select "User" to define an individual threshold.

"User Threshold Value" Set an individual threshold value if "Technology" is set to "User".

Remote command:

[CHANnel<m>:THReshold:TECHnology](#) on page 193

[CHANnel<m>:THReshold:USER](#) on page 194

[CHANnel<m>:THReshold:THReshold?](#) on page 194

RANGE keys

The vertical RANGE keys set the vertical scale (vertical sensitivity) of the selected waveform.

Remote command:

[CHANnel<m>:SCALE](#) on page 191

[CHANnel<m>:RANGE](#) on page 191

POS keys

Move the selected signal up or down in the diagram. The position is a graphical setting given in divisions, while the offset sets a voltage.

You can also drag the channel marker on the screen.

Remote command:

[CHANnel<m>:POSITION](#) on page 192

2.2.2 Effect of the Bandwidth Filter

Lowpass filters reduce the speed of the signal inside the instrument and cause a delay of the signal on the screen. The delay time depends on the selected filter.

The following table lists the approximate delay of the signal that is caused by various filters.

Table 2-1: Approximate signal delay dependent on the bandwidth filter

Filter	Approx. delay	Filter	Approx. delay
200 MHz	30.2 ns	500 kHz	9.07 µs
100 MHz	30.7 ns	200 kHz	22.13 µs
50 MHz	138.5 ns	100 kHz	43.87 µs
20 MHz	145 ns	50 kHz	87.47 µs
10 MHz	166.5 ns	20 kHz	218 µs
5 MHz	193 ns	10 kHz	434.7 µs

Filter	Approx. delay	Filter	Approx. delay
2 MHz	270.5 ns	5 kHz	869.3 μ s
1 MHz	4.71 μ s	2 kHz	2.173 ms
		1 kHz	4.347 ms

2.3 Horizontal Setup

Horizontal settings, also known as timebase settings, adjust the display in horizontal direction.



1. To set the timebase and horizontal position, use the TIME and POS keys.



2. To adjust all horizontal settings, select "Horizontal" in the main menu.

The determining point of an acquisition is the trigger point. Two parameters define the position of the trigger point: reference point and horizontal position (also known as trigger offset or delay). Using these parameters, you choose the part of the waveform you want to see: around the trigger, before, or after the trigger.

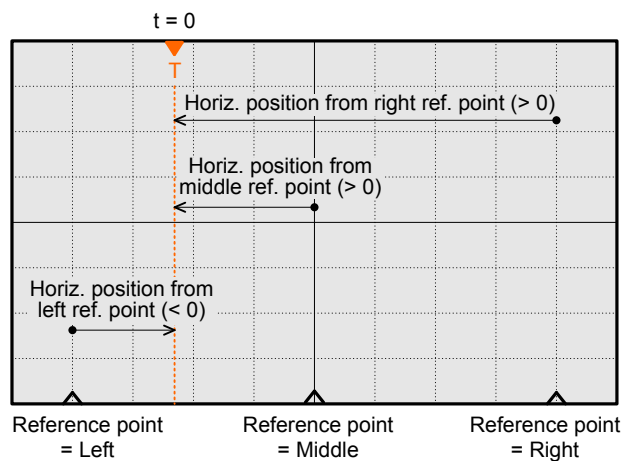

Signal delay

If you have set a bandwidth limit, the signal might appear delayed on the screen. The delay time depends on the selected filter. The effect is visible if several signals with different limits are displayed.

See also: [Chapter 2.2.2, "Effect of the Bandwidth Filter"](#), on page 45.

Description of settings



Time Scale

Sets the time scale of the horizontal axis for all signals, in seconds per division. The value is shown in the top information bar.

Increase the scale to see a longer part of the waveform. Decrease the scale to see the signal in more detail. The scale has a point that remains fixed on the screen when the scale value is changing - the reference point.

To set the time scale, you can also use the TIME keys.

Remote command:

[TIMEbase:SCALE](#) on page 195

[TIMEbase:RANGE](#) on page 195

Horizontal Position

Sets the horizontal position of the trigger point in relation to the reference point. The trigger position is marked by a colored triangle at the top of the diagram.

You can set the trigger point even outside the diagram and analyze the signal some time before or after the trigger. In this case, the trigger marker is shown on the left or right side of the diagram.

To set the horizontal position, you can also use the POS keys.

Remote command:

[TIMEbase:HORIZONTAL:POSITION](#) on page 195

Reference Point

Defines the time reference point in the diagram. You can set the reference point in the middle, or to the right to see the signal before the trigger. If the reference point is on the left, you see the signal after the trigger.

Remote command:

[TIMEbase:REFERENCE](#) on page 195

2.4 Acquisition Control

Acquisition settings define the processing of the captured samples in the instrument.



- ▶ To adjust the acquisition settings, press the ACQUIRE key, or select "Acquire" in the main menu.



- ▶ To start or stop acquisition, press the RUN STOP key.



The R&S RTH captures the continuous signal and converts it to digital samples. The digital samples are processed according to the acquisition settings. The result is a waveform record that is displayed on the screen and stored in memory.

Description of settings

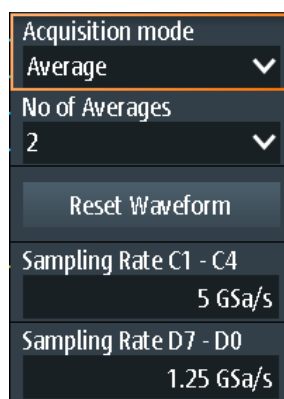

Acquisition Mode

Defines how the waveform is built from the captured samples.

"Sample"	One of n samples in a sample interval is recorded as waveform point, the other samples are discarded. Usually, most signals are displayed optimally with this acquisition mode but very short glitches might remain undiscovered by this method.
"Peak Detect"	The minimum and the maximum of n samples are recorded as waveform points, the other samples are discarded. Thus the instrument can detect fast signal peaks at slow time scale settings that would be missed with other acquisition modes.
"High Resolution"	The average of n captured sample points is recorded as one waveform point. Averaging reduces the noise, the result is a more precise waveform with higher vertical resolution.
"Average"	The average is calculated from the data of the current acquisition and a number of acquisitions before. The method reduces random noise. It requires a stable, triggered and repetitive signal. The number of acquisitions for average calculation is defined with Number of Averages .

"Envelope" The minimum and maximum values in a sample interval over a number of acquisitions are saved. The most extreme values of all acquisitions build the envelope. The resulting diagram shows two envelope waveforms: the minimums (floor) and maximums (roof) representing the borders in which the signal occurs.

Remote command:

[ACQUIRE:MODE](#) on page 196

Number of Averages

Sets the number of waveforms used to calculate the average waveform.

Remote command:

[ACQUIRE:AVERAGE:COUNT](#) on page 197

Reset Waveform

Restarts the envelope and average calculation.

Remote command:

[ACQUIRE:ARESET:IMMEDIATE](#) on page 197

Sampling Rate C1 - C4

Shows the number of recorded analog waveform points per second. The sample rate is the reciprocal value of the resolution.

Remote command:

[ACQUIRE:POINTS:ARATE?](#) on page 196

Sampling Rate D7 - D0

Shows the number of recorded digital waveform points per second.

RUN STOP key

Starts and stops the acquisition.

Remote command:

[RUN](#) on page 196

[STOP](#) on page 196

2.5 Trigger

Triggering means to capture the interesting part of the relevant waveforms. Choosing the right trigger type and configuring all trigger settings correctly allows you to detect various incidents in signals.

A trigger occurs if the trigger conditions are fulfilled. The instrument acquires continuously and keeps the sample points to fill the pretrigger part of the waveform record. When the trigger occurs, the instrument continues acquisition until the posttrigger part of the waveform record is filled. Then it stops acquiring and displays the waveform. When a trigger is recognized, the instrument does not accept another trigger until the acquisition is complete.

Trigger conditions include:

- Source of the trigger signal (channel)
- Trigger type and its setup, including one or more trigger levels
- Trigger mode

In addition, the horizontal position of the trigger point and the reference point are important to display the interesting part of the signal. See [Chapter 2.3, "Horizontal Setup"](#), on page 46.

The trigger level and position are marked on the display. The markers have the color of the trigger source. Information on the most important trigger settings is shown in the upper information bar.



Figure 2-1: Trigger information: width trigger on channel 2, single trigger mode



- ▶ To adjust all trigger settings, press the SETUP key.
- ▶ To adjust the trigger level, do one of the following:
 - Drag the trigger level marker on the right side of the display to the required position.
 - Press the LEVEL key and turn the wheel.
If the trigger type has two trigger levels, press the LEVEL key again to toggle the upper and lower levels. Alternatively, press the wheel.
 - Press the SETUP key. Select "Trigger Level", and enter the level value.
- ▶ To start and stop acquisition, press the RUN STOP key.

2.5.1 General Trigger Settings

General trigger settings are the settings that are independent of the trigger type. The settings specific for a trigger type are described in the following sections.

☰ Description of settings



Trigger Mode

The trigger mode determines the behavior of the instrument if no trigger occurs, and also the number of acquired waveforms when a trigger occurs.

- | | |
|----------|--|
| "Auto" | The instrument triggers repeatedly after a time interval if the trigger conditions are not fulfilled. If a real trigger occurs, it takes precedence. This mode helps to see the waveform even before the trigger is set. Successive waveforms are not triggered at the same point of the waveform. |
| "Normal" | The instrument acquires waveforms continuously, each time when a trigger occurs. If no trigger occurs, no waveform is acquired and the last acquired waveform is displayed. If no waveform was captured before, nothing is displayed. |
| "Single" | When a trigger occurs, the instrument acquires one waveform and stops the acquisition. |

Remote command:

[TRIGger:MODE](#) on page 198

Trigger Type

Selects the trigger type, the event type that defines the trigger point.

- [Chapter 2.5.2, "Edge Trigger"](#), on page 53
- [Chapter 2.5.3, "Glitch Trigger"](#), on page 54
- [Chapter 2.5.4, "Width Trigger"](#), on page 55
- [Chapter 2.5.5, "Video/TV Trigger"](#), on page 57

R&S RTH-K19 trigger options

- [Chapter 2.5.7, "Pattern Trigger \(R&S RTH-K19\)"](#), on page 62
- [Chapter 2.5.8, "State Trigger \(R&S RTH-K19\)"](#), on page 64
- [Chapter 2.5.9, "Runt Trigger \(R&S RTH-K19\)"](#), on page 65
- [Chapter 2.5.10, "Slew Rate Trigger \(R&S RTH-K19\)"](#), on page 67
- [Chapter 2.5.11, "Data2Clock Trigger \(R&S RTH-K19\)"](#), on page 69

- [Chapter 2.5.12, "Serial Pattern Trigger \(R&S RTH-K19\)", on page 70](#)
- [Chapter 2.5.13, "Timeout Trigger \(R&S RTH-K19\)", on page 73](#)
- [Chapter 2.5.14, "Interval Trigger \(R&S RTH-K19\)", on page 74](#)
- [Chapter 2.5.15, "Window Trigger \(R&S RTH-K19\)", on page 75](#)

Options containing special triggers

- [Chapter 2.5.16, "Protocol Trigger \(R&S RTH-K1, R&S RTH-K2 and R&S RTH-K3\)", on page 76](#)

Remote command:

[TRIGger:TYPE](#) on page 199

Source

Selects the trigger source, the channel on which the trigger condition is checked. All possible channels are listed. You can trigger on any channel to which a signal is connected, even if the channel is not active.

For most trigger types, analog and digital channels can be used as trigger source. Digital channels require option R&S RTH-B1. For video, runt and slew rate trigger, only analog channels are available.

Remote command:

[TRIGger:SOURce](#) on page 199

Trigger Level

Sets the trigger voltage level.

For the Video/TV trigger, the trigger level is the threshold of the sync pulse. Make sure that the trigger level crosses the synchronizing pulses of the video signal.

Remote command:

[TRIGger:LEVel<m>:VALue](#) on page 199

Holdoff Mode

Selects the method to define the holdoff.

The trigger holdoff defines when the next trigger after the current will be recognized. Thus, it affects the next trigger to occur after the current one. Holdoff helps to obtain stable triggering when the oscilloscope is triggering on undesired events.



"Off"	No holdoff
"Time"	Defines the holdoff as a time period. The next trigger occurs only after the "Time" on page 53 has passed.
"Events"	Defines the holdoff as a number of trigger events. The next trigger only occurs when this number of events is reached. The number of triggers to be skipped is defined in "Events" on page 53.

"Random" Defines the holdoff as a random time limited by "[Min Time / Max Time](#)" on page 53. For each acquisition, the instrument selects a new random holdoff time from the specified range. Random holdoff prevents synchronization to discover effects invisible with synchronized triggering, e.g. the features of a pulse train.

Remote command:

[TRIGger:HOLDoff:MODE](#) on page 200

Time ← Holdoff Mode

Sets the time that has to pass at least until the next trigger occurs.

Remote command:

[TRIGger:HOLDoff:TIME](#) on page 200

Events ← Holdoff Mode

Sets the number of triggers to be skipped until the next trigger occurs.

Remote command:

[TRIGger:HOLDoff:EVENTs](#) on page 201

Min Time / Max Time ← Holdoff Mode

Set the time limits for random holdoff time. For each acquisition, the instrument selects a new random holdoff time from the specified range.

Remote command:

[TRIGger:HOLDoff:MIN](#) on page 201

[TRIGger:HOLDoff:MAX](#) on page 201

Noise Reject

Enables a hysteresis to avoid unwanted trigger events caused by noise oscillation around the trigger level.

Remote command:

[TRIGger:MNR](#) on page 201

2.5.2 Edge Trigger

The edge trigger is the most common trigger type. The trigger occurs when the signal from the trigger source passes the trigger level in the specified direction (slope).

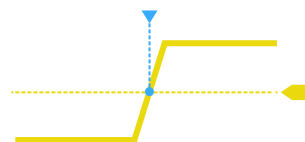

☰ Description of settings

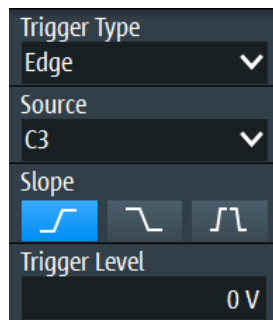





Figure 2-2: Edge trigger

Slope

Sets the edge direction for the trigger. You can trigger on:

-  rising edge, that is a positive voltage change
-  falling edge, that is a negative voltage change
-  rising and falling edge

Remote command:

[TRIGger:EDGE:SLOPe](#) on page 201

2.5.3 Glitch Trigger

The glitch trigger detects pulses shorter or longer than a specified time. It identifies deviation from the nominal data rate and helps to analyze causes of even rare glitches and their effects on other signals.

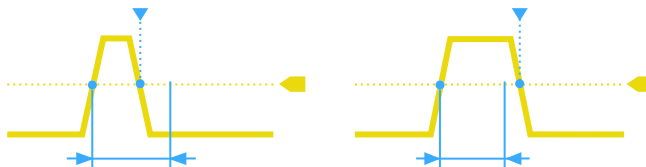

☰ Description of settings

Trigger Type	Glitch
Source	C3
Polarity	<input checked="" type="radio"/>  <input type="radio"/>  <input type="radio"/> 
Range	Shorter
Width	4.8 ns
Trigger Level	0 V

Polarity

Sets the pulse polarity, that is the direction of the first pulse slope. You can trigger on:

- Positive going pulses. The width is defined from the rising to the falling edge.
- Negative going pulses. The width is defined from the falling to the rising edge.
- Both positive and negative going pulses

Remote command:

[TRIGger:GLITch:POLarity](#) on page 202

Range

Selects the glitches to be identified: shorter or longer than the specified "[Width](#)" on page 55.

Remote command:

[TRIGger:GLITch:RANGe](#) on page 202

Width

Sets the pulse width of the glitch.

Remote command:

[TRIGger:GLITch:WIDTh](#) on page 202

2.5.4 Width Trigger

The width trigger compares the measured pulse width (duration of a pulse) with a given time limit. It detects pulses with an exact pulse width, pulses shorter or longer than a given time, as well as pulses inside or outside the allowable time range. The pulse width is measured at the trigger level.

Using the width trigger, you can define the pulse width more precisely than with the glitch trigger. However, using the range settings "Shorter" and "Longer", you can also trigger on glitches.

☰ Description of settings



Figure 2-3: Width trigger

Polarity

Sets the pulse polarity, that is the direction of the first pulse slope. You can trigger on:

- Positive going pulses. The width is defined from the rising to the falling edge.
- Negative going pulses. The width is defined from the falling to the rising edge.
- Both positive and negative going pulses

Remote command:

`TRIGger:WIDTH:POLarity` on page 202

Range

Defines how the measured pulse width is compared with the given limits.

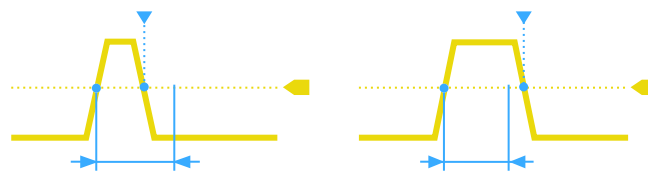

Figure 2-4: Pulse width is shorter or longer than a given width (same as glitch trigger)

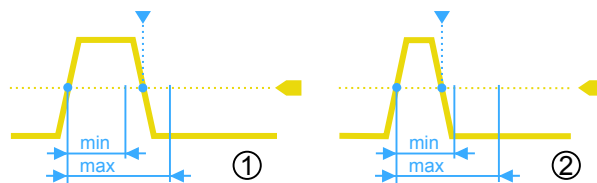

Figure 2-5: Pulse width is inside or outside a range

- 1 = Inside, pulse > min width AND pulse < max width
 2 = Outside, pulse < min width OR pulse > max width

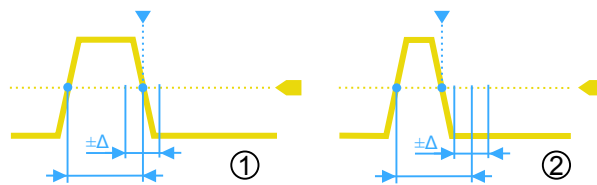

Figure 2-6: Pulse width is equal or unequal to a given width, with optional tolerance

1 = Equal, pulse > width - Δ AND pulse < width + Δ

2 = Unequal, pulse < width - Δ OR pulse > width + Δ

Remote command:

[TRIGger:WIDTH:RANGe](#) on page 203

Width

Sets the width for comparisons equal, unequal, shorter, and longer.

Remote command:

[TRIGger:WIDTH:WIDTHh](#) on page 203

\pm Tolerance

Sets a range Δt to the specified [Width](#) if the comparison range is equal or unequal. To trigger on an exact pulse width, set the tolerance to 0.

Remote command:

[TRIGger:WIDTH:DELTA](#) on page 203

Min Width / Max Width

Set the lower and upper time limits defining the time range if "Inside" or "Outside" is set for comparison.

Remote command:

[TRIGger:WIDTH:MIN](#) on page 204

[TRIGger:WIDTH:MAX](#) on page 204

2.5.5 Video/TV Trigger

The TV or video trigger is used to analyze analog baseband video signals. You can trigger on baseband video signals from standard definition and high definition standards, and also on user defined signals.

The instrument triggers on the line start - the horizontal sync pulse. You can trigger on all lines, or specify a line number. You can also trigger on the field or frame start.

2.5.5.1 Standard TV Trigger Settings

Access: SETUP key > "Trigger Type" = "Video/TV"

Trigger Type	Video/TV	▼
Source	C3	▼
Standard	PAL	▼
Signal Polarity	Positive	▼
Mode	All Fields	▼
Trigger Level	0 V	

Standard

Selects the TV standard or "Custom" for user-defined signals.

The standards PAL, PAL-M, NTSC and SECAM are available in the instrument firmware. All other standards require the advance trigger option R&S RTH-K19.

HDTV standards are indicated by the number of active lines, the scanning system (p for progressive scanning, i for interlaced scanning) and the frame rate. For interlaced scanning, the field rate is used instead of the frame rate. 1080p/24sF is an HDTV standard using progressive segmented frame scanning.

"Custom" can be used for signals of other video systems, for example, medical displays, video monitors, and security cameras. To trigger on these signals, you have to define the pulse type and length of the sync pulse, the scanning system and the line period.

Remote command:

[TRIGger:TV:STANdard](#) on page 204

Signal Polarity

Sets the polarity of the signal. Note that the sync pulse has the opposite polarity, for example, a positive signal has a negative sync pulse.

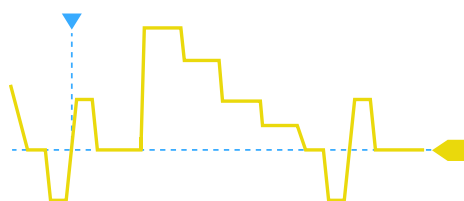

Figure 2-7: Signal with positive polarity and tri-level sync pulse

Remote command:

[TRIGger:TV:POLarity](#) on page 205

Mode

Selects the lines or fields on which the instrument triggers. Available modes depend on the scanning system of the selected standard.

- "All fields" Triggers on the first video line of the frame (progressive scanning) or field (interlaced scanning), for example, to find amplitude differences between the fields.
- "Odd fields / Even fields" Triggers on the first video line of the odd or even field. These modes are available for interlaced scanning (PAL, PAL-M, SECAM, NTSC, 1080i) and progressive segmented frame scanning (1080p/24sF). They can be used, for example, to analyze the components of a video signal.
- "All lines" Triggers on the line start of all video lines, for example, to find maximum video levels.
- "Line number" Triggers on a specified line. Enter the line number in "Line #".

Remote command:

`TRIGger:TV:MODE` on page 205

Line

Sets the number of the line to be triggered on if "Mode" is set to "Line number". Usually the lines of the frame are counted, beginning from the frame start.

For NTSC signals, the lines are counted per field, not per frame. Therefore, you have to set the "Field" (odd or even), and the line number in the field.

Remote command:

`TRIGger:TV:LINE` on page 206

`TRIGger:TV:LFIeld` on page 206

Trigger Level

Sets the trigger level as threshold for the synchronizing pulse. Make sure that the trigger level crosses the synchronizing pulses of the video signal.

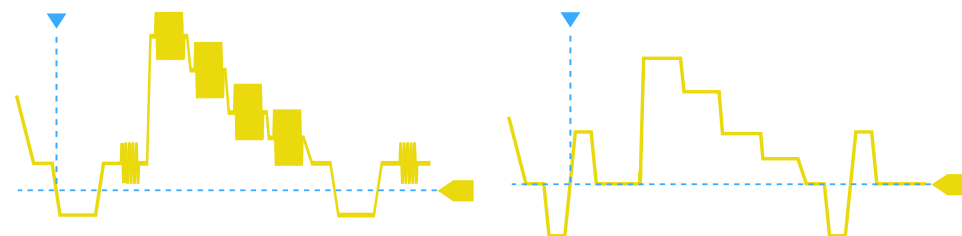

Figure 2-8: Trigger level with bi-level (left) and tri-level (right) sync pulses

Remote command:

`TRIGger:LEVel<m>:VALue` on page 199

2.5.5.2 Settings for Custom Video Signals (R&S RTH-K19)

In addition to the standard TV trigger settings, triggering on custom video signals requires a few more settings that describe the signal.

- ▶ SETUP key > "Trigger Type" = "Video/TV" > "Standard" = "Custom"

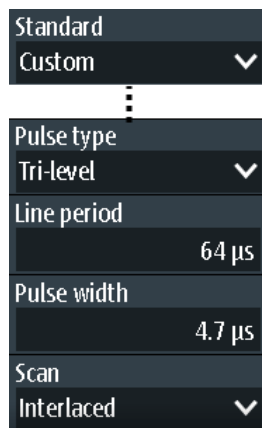

Pulse Type

Sets the type of the sync pulse, either bi-level sync pulse (used in SDTV signals), or tri-level sync pulse (used in HDTV signals).

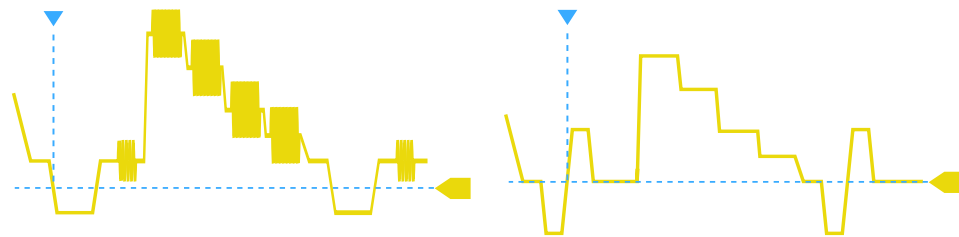

Figure 2-9: Bi-level (left) and tri-level (right) sync pulses

This setting is available for user-defined video signals if "Standard" is set to "Custom".

Remote command:

[TRIGger:TV:CUSTom:STYPe](#) on page 206

Line Period

Sets the duration of a single video line, the time between two successive sync pulses.

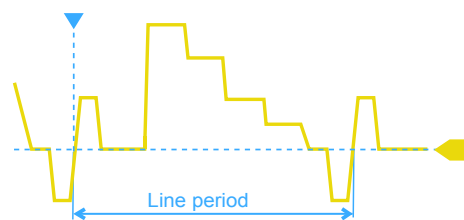

This setting is available for user-defined video signals if "Standard" is set to "Custom".

Remote command:

[TRIGger:TV:CUSTom:LDURation](#) on page 207

Pulse Width

Sets the width of the sync pulse.

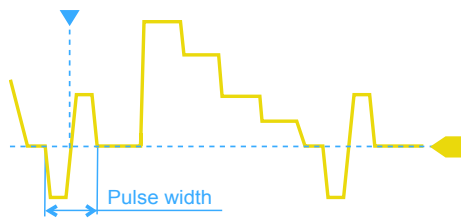

This setting is available for user-defined video signals if "Standard" is set to "Custom".

Remote command:

[TRIGger:TV:CUSTom:SDURation](#) on page 207

Scan

Sets the scanning system.

This setting is available for user-defined video signals if "Standard" is set to "Custom".

- "Interlaced" Interlace scanning uses two fields to create a frame. One field contains all the odd lines (odd, first, or upper field), the other contains all the even lines of the image (even, second, or lower field). First the lines of the odd field are processed, then the lines of the even field.
- "Progressive" Progressive scanning is a method to capture, transmit and display all lines of a frame in sequence.
- "Segmented" Progressive segmented frame uses progressive scanning to capture the frame, and interlaced scanning for transmission and display.

Remote command:

[TRIGger:TV:CUSTom:SCANmode](#) on page 207

2.5.6 External Trigger (R&S RTH1002)

The R&S RTH1002 has an edge trigger to trigger on an external signal.

1. Connect the external trigger signal to the DMM input:
 - a) Ground to black COM input.
 - b) Signal to red input.
2. Press the SETUP key.
3. Select "Trigger Type" = "External"



Description of settings

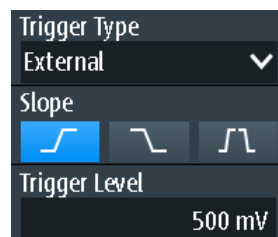

Slope

Sets the edge direction for the trigger. You can trigger on the rising edge, the falling edge, or rising and falling edges of the external signal.

Remote command:

`TRIGger:EXTernal:SLOPe` on page 208

Trigger Level

Sets the trigger voltage level.

Remote command:

`TRIGger:EXTernal:LEVel` on page 207

2.5.7 Pattern Trigger (R&S RTH-K19)

The pattern trigger works like a logic trigger. It provides logical combinations of the input channels and can be used for verifying the operation of digital logic. If the channel states match the desired pattern, the pattern trigger occurs. In addition to the pattern, you can define a timing condition. In this case, the trigger occurs if the pattern definition is true for the defined time.

- ▶ SETUP key > "Trigger Type" = "Pattern"

 **Description of settings**

Figure 2-10: Pattern trigger

Set Pattern

Defines the pattern: the states of the input channels and their logical combination. If R&S RTH-B1 is installed, active digital channels are also included in the pattern definition.

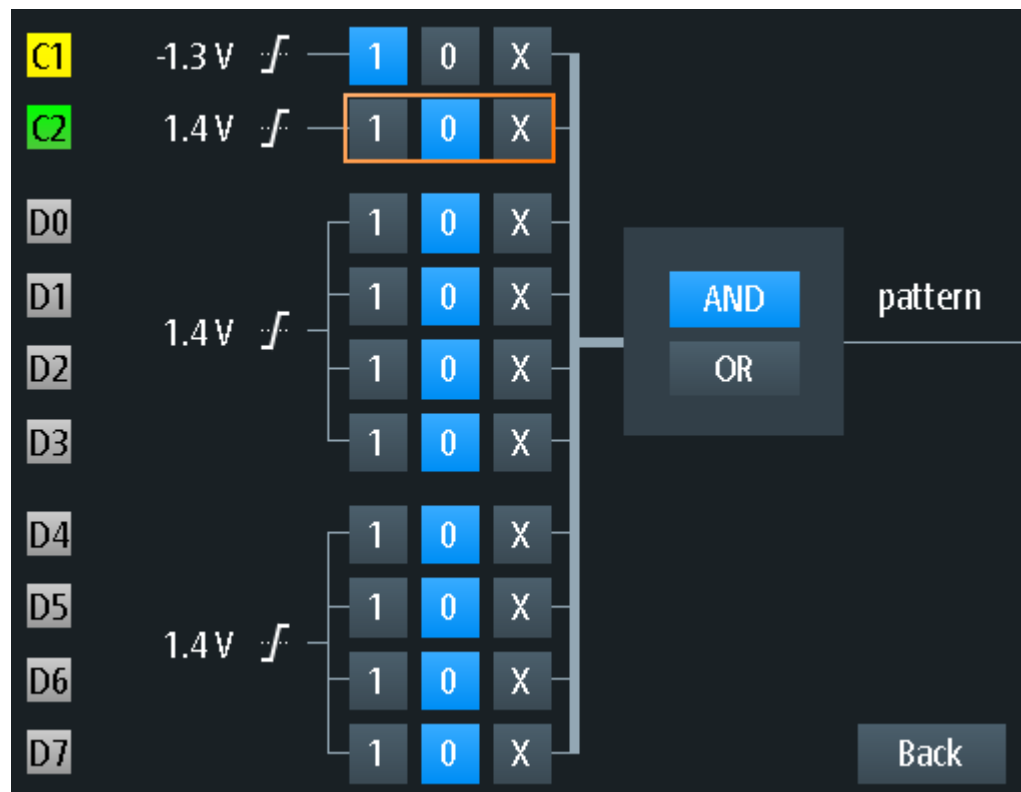

Figure 2-11: Pattern definition

The current threshold is displayed for each channel. For analog channels, the threshold is set in the "Vertical" menu. For logic channels, the threshold is set in the "Logic" menu.

The switches define the required state of each channel and set the logical combination:

"1" The signal value is above the defined threshold.

"0" The signal value is below the defined threshold.

"X" The signal state does not matter.

"AND" If all defined states are true, the logical result of the pattern definition is 1 (true).

"OR" If at least one of the defined states is true, the logical result of the pattern definition is 1 (true).

Remote command:

[TRIGger:PATtern:STATe\[:CHANnel<m>\]](#) on page 208

[TRIGger:PATtern:STATe:COMBination](#) on page 208

Range

Adds additional time limitation to the defined pattern.

"None" No time limit is set. If the defined pattern is true, the pattern trigger occurs.

"Timeout" Defines a minimum time during which the signals match the pattern definition.

"Longer"	If the pattern is true longer than the "Pattern Width" time, the trigger occurs.
"Shorter"	If the pattern is true for a time shorter than "Pattern Width", the trigger occurs.
"Equal"	If the pattern is true for the time " <i>Pattern Width</i> \pm Δt (" <i>Tolerance</i> ") , the trigger occurs.
"Unequal"	If the pattern is true for a time shorter than " <i>Pattern Width</i> - Δt OR longer than " <i>Pattern Width</i> + Δt ", the trigger occurs.
"Inside"	If the pattern is true for a time between "Min Pattern Width" and "Max Pattern Width", the trigger occurs.
"Outside"	If the pattern is true for a time shorter than "Min Pattern Width" OR longer than "Max Pattern Width", the trigger occurs.

Remote command:

[TRIGger:PATtern:WIDTh:RANGe](#) on page 209

[TRIGger:PATtern:TIMEout\[:TIME\]](#) on page 209

[TRIGger:PATtern:WIDTh\[:WIDTh\]](#) on page 209

[TRIGger:PATtern:WIDTh:DELTA](#) on page 210

2.5.8 State Trigger (R&S RTH-K19)

The state trigger verifies if the channel states match the defined pattern at the clock edge. The trigger occurs if the logical combination of the input channels is true at the crossing point of the selected clock edge and the trigger level.

- ▶ SETUP key > "Trigger Type" = "State"

Description of settings

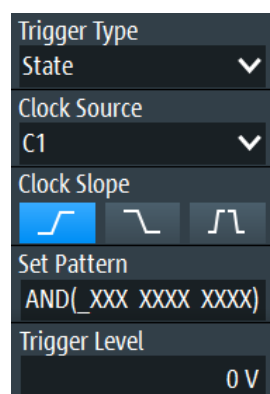

Figure 2-12: State trigger

Clock Source

Selects the input channel of the clock signal.

Remote command:

[TRIGger:STATe:CSourCe\[:VALue\]](#) on page 211

Clock Slope

Sets the edge of the clock at which the instrument checks the signal states: at the rising edge, the falling edge, or at both edges.

Remote command:

`TRIGger:STATe:CSourCe:EDGE` on page 211

Set Pattern

Defines the pattern: the states of the input channels and their logical combination. If R&S RTH-B1 is installed, active digital channels are also included in the pattern definition.

For details, see [Chapter 2.5.7, "Pattern Trigger \(R&S RTH-K19\)"](#), on page 62.

Remote command:

`TRIGger:STATe:CHANnel<m>` on page 210

`TRIGger:STATe:COMBination` on page 211

2.5.9 Runt Trigger (R&S RTH-K19)

A runt is a pulse lower than normal in amplitude. The amplitude crosses the first level twice in succession without crossing the second one. In addition to the upper and lower levels, you can define a time limit for the runt in the same way as for width triggers. For example, the runt trigger can detect signal parts remaining below a specified threshold amplitude because I/O ports are in undefined state.

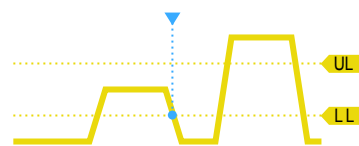

Figure 2-13: Runt trigger without time limits

- ▶ SETUP key > "Trigger Type" = "Runt"

☰ Description of settings

Trigger Type	Runt		
Source	C1		
Polarity	<input checked="" type="checkbox"/>  <input type="checkbox"/>  <input type="checkbox"/> 		
Range	Range	Range	Range
Any Runt	Longer	Equal	Inside
Upper Trigger Level	Runt Width	Runt Width	Min Runt Width
0 V	4.8 ns	4.8 ns	4 ns
Lower Trigger Level	Upper Trigger Level	±Tolerance	Max Runt Width
0 V	0 V	800 ps	5.6 ns
	Lower Trigger Level	Upper Trigger Level	Upper Trigger Level
	0 V	0 V	0 V
		Lower Trigger Level	Lower Trigger Level
		0 V	0 V

Upper Trigger Level / Lower Trigger Level

Set the upper and lower voltage thresholds for the runt trigger. The levels define the minimum and maximum runt amplitudes.

You can also press the LEVEL key to toggle the upper and lower levels, and turn the wheel to adjust the focused level. If the focus is on a trigger level, pressing the wheel also toggles the levels.

Remote command:

[TRIGger:LEVel<m>:RUNT:UPPer](#) on page 211

[TRIGger:LEVel<m>:RUNT:LOWer](#) on page 211

Polarity

Sets the pulse polarity, that is the direction of the first pulse slope. You can trigger on:

- Positive going pulses. The width is defined from the rising to the falling edge.
- Negative going pulses. The width is defined from the falling to the rising edge.
- Both positive and negative going pulses

Remote command:

[TRIGger:RUNT:POLarity](#) on page 212

Range

Defines an additional time limit of the runt pulse.

"Any runt" triggers on all runts fulfilling the level condition, without time limitation. The other comparisons are the same as for the width trigger, see "[Range](#)" on page 56.

Remote command:

[TRIGger:RUNT:RANGe](#) on page 212

Runt Width

Sets the width for comparisons equal, unequal, shorter, and longer.

Remote command:

`TRIGger:RUNT:WIDTh` on page 212

±Tolerance

Sets a tolerance range Δt to the specified [Runt Width](#) if the comparison range is equal or unequal.

Remote command:

`TRIGger:RUNT:DELTA` on page 213

Min Runt Width / Max Runt Width

Set the lower and upper time limits if "Inside" or "Outside" is set for comparison.

Remote command:

`TRIGger:RUNT:MINwidth` on page 213

`TRIGger:RUNT:MAXwidth` on page 213

2.5.10 Slew Rate Trigger (R&S RTH-K19)

The slew rate trigger is also known as transition trigger. It triggers if the transition time from the lower to higher voltage level (or vice versa) is shorter or longer as defined, or outside or inside a specified time range.

The slew rate trigger finds slew rates faster than expected or permissible to avoid overshooting and other interfering effects. It also detects slow edges violating the timing in pulse series.

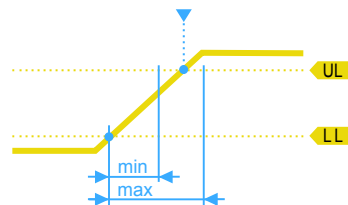

Figure 2-14: Slew rate trigger, transition time inside a range ($t > \text{min time AND } t < \text{max time}$)

- ▶ SETUP key > "Trigger Type" = "Slew rate"

☰ Description of settings

Trigger Type		
Slew Rate	▼	
Source	C1 ▼	
Slope	<input checked="" type="checkbox"/>  <input type="checkbox"/>  <input type="checkbox"/> 	
Range	Equal ▼	Range Inside ▼
Shorter	▼	
Time	4.8 ns	Min Time 4 ns
Upper Trigger Level	0 V	Max Time 5.6 ns
Lower Trigger Level	0 V	Upper Trigger Level 0 V
	±Tolerance 800 ps	Lower Trigger Level 0 V
	Upper Trigger Level 0 V	
	Lower Trigger Level 0 V	

Upper Trigger Level / Lower Trigger Level

Set the upper and lower voltage thresholds for the slew rate trigger. The time measurement starts when the signal crosses the first trigger level, and stops when the signal crosses the second level. The first trigger level is the upper or lower level depending on the selected slope.

Remote command:

[TRIGger:LEVel<m>:SLEW:UPPer](#) on page 214

[TRIGger:LEVel<m>:SLEW:LOWer](#) on page 214

Slope

Sets the edge direction for the trigger. You can trigger on:

- rising edge, that is a positive voltage change
- falling edge, that is a negative voltage change
- rising and falling edge

Remote command:

[TRIGger:SLEW:SLOPe](#) on page 214

Range

Defines the time limits of the slew rate. The comparisons are the same as for the width trigger, see "[Range](#)" on page 56.

Remote command:

[TRIGger:SLEW:RANGe](#) on page 214

Time

Sets the slew rate for comparisons equal, unequal, shorter, and longer.

Remote command:

[TRIGger:SLEW:RATE](#) on page 215

±Tolerance

Sets a tolerance range Δt to the specified **Time** if the comparison range is equal or unequal.

Remote command:

`TRIGger:SLEW:DELTA` on page 215

Min Time / Max Time

Set the lower and upper time limits if "Inside" or "Outside" is set for comparison.

Remote command:

`TRIGger:SLEW:MINwidth` on page 215

`TRIGger:SLEW:MAXwidth` on page 216

2.5.11 Data2Clock Trigger (R&S RTH-K19)

With the Data2Clock trigger - also known as setup/hold trigger - you can analyze the relative timing between two signals: a data signal and the synchronous clock signal. Many systems require, that the data signal must be steady for some time before and after the clock edge, for example, the data transmission on parallel interfaces.

The reference point for the time measurement is defined by clock level and clock edge.

- ▶ SETUP key > "Trigger Type" = "Data2Clk"

**Description of settings**

Trigger Type	Data2Clk
Clock Source	C1
Clock Slope	<input checked="" type="radio"/> <input type="radio"/> <input type="radio"/>
Data Source	D3
Trigger on Setup & Hold	Violation
Setup Time	8 ns
Hold time	5 ns
Trigger Level	0 V

Figure 2-15: Data2Clock trigger

Clock Source

Selects the input channel of the clock signal.

Remote command:

[TRIGger:DATatoclock:CSOURCE\[:VALue\]](#) on page 216

Clock Slope

Sets the edge of the clock signal: rising, falling, or both edges. The time reference point for the setup and hold time is the crossing point of the clock edge and the trigger level.

Remote command:

[TRIGger:DATatoclock:CSOURCE:EDGE](#) on page 216

Data Source

Selects the input channel of the data signal.

Remote command:

[TRIGger:DATatoclock:DSOURCE\[:VALue\]](#) on page 216

Trigger on Setup & Hold

Selects how a violation of the setup and hold time is handled.

"Violation" Triggers on a violation of the setup or hold time

"OK" Triggers if setup and hold time keep the limits.

Remote command:

[TRIGger:DATatoclock:CONDition](#) on page 216

Setup Time

Sets the minimum time before the clock edge while the data signal must stay steady.

The setup time can be negative. In this case, the hold time is always positive. If you set a negative setup time, the hold time is adjusted by the instrument.

Remote command:

[TRIGger:DATatoclock:STIME](#) on page 217

Hold Time

Sets the minimum time after the clock edge while the data signal must stay steady.

The hold time can be negative. In this case, the setup time is always positive. If you set a negative hold time, the setup time is adjusted by the instrument.

Remote command:

[TRIGger:DATatoclock:HTIME](#) on page 217

2.5.12 Serial Pattern Trigger (R&S RTH-K19)

The serial pattern event is used to trigger on signals with serial data patterns in relation to a clock signal - for example, on bus signals like the I²C bus. The trigger occurs during the reception of the last bit of the defined pattern.

2.5.12.1 Pattern Definition

The pattern defines the bits of the serial data to be found in the data stream.



The pattern definition described here is for the serial pattern trigger; however, a very similar pattern editor is available for other functions, such as protocol-specific triggers.

When you tap the pattern field, a pattern editor is displayed. The current bit definition in binary and hexadecimal format is displayed at the top of the editor, a virtual keypad is displayed beneath it. To define a bit, select the bit in the displayed pattern, then select the bit value from the displayed keypad. The currently selected bit is indicated by a blue background.



Figure 2-16: Pattern editor for 14-bit pattern in hexadecimal format

The maximum length of the pattern is 32 bit, however you can reduce the number of bits. The available bits are initially indicated by 'X', while the unused bits are indicated by gray squares. An 'X' indicates that the logical level for the bit is not relevant (do not care). Once you enter a value for the selected bit, the 'X' is overwritten.

You can enter the pattern in binary or hexadecimal format. Depending on which bit you select in the pattern display, binary or hexadecimal format is automatically selected for input. In binary format, each bit is defined individually, and only the digits 0 and 1 are available for input. In hexadecimal format, 4 bits are defined at the same time by the selected hexadecimal value. If fewer than 4 bits are available (due to the total number of bits), only those hexadecimal values are available that can be defined with the remaining number of bits. For example, for a total number of 14 bits, 3x4 bits can be defined by any hexadecimal value. The remaining 2 bits can define a 0, 1, 2, or 3 (as shown in [Figure 2-16](#)).

To store the defined pattern, select "Enter". The pattern editor is closed and the pattern is inserted in the pattern settings field.

2.5.12.2 Serial Pattern Trigger Settings

Access: (Trigger) SETUP key > "Trigger Type" = "Serial Pattern"



Description of settings

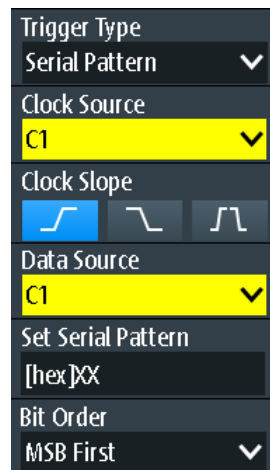

Figure 2-17: Serial pattern trigger

Clock Source.....	72
Clock Slope.....	72
Data Source.....	72
Set Serial Pattern.....	73
Bit Order.....	73

Clock Source

Selects the input channel of the clock signal.

Remote command:

[TRIGger:SPATtern:CSOource\[:VALue\]](#) on page 218

Clock Slope

Sets the edge at which the data value is sampled.

- rising edge
- falling edge
- rising and falling edges are considered (double data rate).

At double data rate, "First Clock Edge of Pattern" defines the edge at which the first bit of the pattern is sampled: at the rising clock edge, falling clock edge, or the first edge that is detected ("Either").

Remote command:

[TRIGger:SPATtern:CSOource:EDGE](#) on page 218

[TRIGger:SPATtern:CSOource:FIRStedge](#) on page 218

Data Source

Selects the input channel of the data signal.

Remote command:

[TRIGger:SPATtern:DSOource\[:VALue\]](#) on page 217

Set Serial Pattern

The pattern defines the bits of the serial data to be found in the data stream.

See also [Chapter 2.5.12.1, "Pattern Definition"](#), on page 70.

Remote command:

`TRIGger:SPATtern:PATtern` on page 218

Bit Order

Defines if the data words start with MSB (most significant bit) or LSB (least significant bit).

Remote command:

`TRIGger:SPATtern:ORDer` on page 218

2.5.13 Timeout Trigger (R&S RTH-K19)

The timeout trigger checks if the signal stays above or below the trigger level for a specified time lapse. In other words, the trigger occurs if the signal does not cross the trigger level during the specified time.

- ▶ SETUP key > "Trigger Type" = "Timeout"

**Description of settings**

Figure 2-18: Timeout trigger

Range

Selects the relation of the signal level to the trigger level:

"Stays High" The signal level stays above the trigger level.

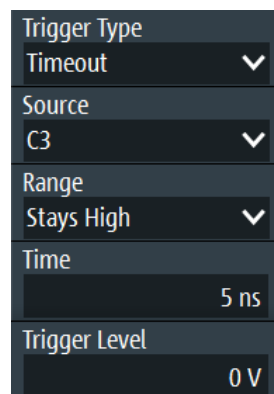
"Stays Low" The signal level stays below the trigger level.

"High or Low" The signal level stays above or below the trigger level.

Remote command:

`TRIGger:TIMEout:RANGe` on page 219

Time

Defines the time limit for the timeout at which the instrument triggers.

Remote command:

[TRIGger:TIMEout:TIME](#) on page 219

2.5.14 Interval Trigger (R&S RTH-K19)

The interval trigger analyzes the time between two pulses.

► SETUP key > "Trigger Type" = "Interval"

Description of settings

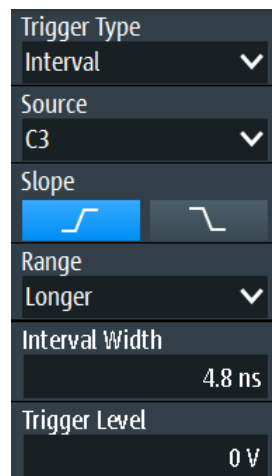

Figure 2-19: Interval trigger

Slope

Sets the edge for the trigger. You can analyze the interval between positive edges or between negative edges.

Remote command:

[TRIGger:INTerval:SLOPe](#) on page 219

Range

Defines how the time range of an interval is defined. The comparisons are the same as for the width trigger, see "[Range](#)" on page 56.

Remote command:

[TRIGger:INTerval:RANGe](#) on page 220

Interval Width

Sets the time between two pulses for comparisons equal, unequal, shorter, and longer.

Remote command:

[TRIGger:INTerval:WIDTh](#) on page 220

±Tolerance

Sets a tolerance range Δt to the specified [Interval Width](#) if the comparison range is equal or unequal.

Remote command:

`TRIGger:INTerval:DELTA` on page 220

Min Interval Width / Max Interval Width

Set the lower and upper time limits of the interval if "Inside" or "Outside" is set for comparison.

Remote command:

`TRIGger:INTerval:MINWidth` on page 220

`TRIGger:INTerval:MAXWidth` on page 221

2.5.15 Window Trigger (R&S RTH-K19)

The window trigger checks the signal run in relation to a "window" that is formed by the upper and lower voltage levels. The trigger occurs, if the waveform enters or leaves the window, or if the waveform stays inside or outside for a defined time range.

With the window trigger, you can display longer transient effects.

- ▶ SETUP key > "Trigger Type" = "Window"



Description of settings

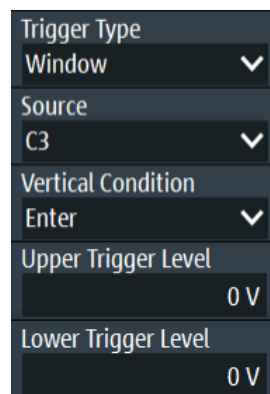

Figure 2-20: Window trigger

Vertical Condition

Selects how the signal run is compared with the window:

- | | |
|----------------|--|
| "Enter" | Triggers when the signal crosses the upper or lower level and thus enters the window made up of these two levels. |
| "Exit" | Triggers when the signal leaves the window. |
| "Stay Inside" | Triggers if the signal stays between the upper and lower level for a specified time. The time is defined in various ways by the "Range" conditions. |
| "Stay Outside" | Triggers if the signal stays above the upper level or below the lower level for a specified time. The time is defined in various ways by the "Range" conditions. |

Remote command:

[TRIGger:WINDow:RANGe](#) on page 222

Upper Trigger Level / Lower Trigger Level

Set the upper and lower voltage thresholds for the window trigger. The trigger levels are the vertical window limits.

Remote command:

[TRIGger:LEVel<m>:WINDow:UPPer](#) on page 221

[TRIGger:LEVel<m>:WINDow:LOWer](#) on page 221

Range

Selects how the time limit of the window is defined. Time conditioning is available for the vertical conditions "Stay Inside" and "Stay Outside".

"Longer"	Triggers if the signal crosses the upper or lower level after the specified "Width" time is reached.
"Shorter"	Triggers if the signal crosses the upper or lower level before the specified "Width" time is reached.
"Equal"	Triggers if the signal stays inside or outside the vertical window limits for the time "Width" "±Tolerance".
"Unequal"	Triggers if the signal stays inside or outside the vertical window limits for a time unequal to "Width" "±Tolerance"
"Inside"	Triggers if the signal stays inside or outside the vertical window limits at least for the time "Min Width" and for "Max Width" at the most.
"Outside"	"Outside" is the opposite definition of "Inside". The trigger occurs if the signal stays inside or outside the vertical window limits for a time shorter than "Min Width" or longer than "Max Width".

Remote command:

[TRIGger:WINDow:TIME](#) on page 221

[TRIGger:WINDow:WIDTH](#) on page 222

[TRIGger:WINDow:DELTA](#) on page 223

[TRIGger:WINDow:MINWidth](#) on page 223

[TRIGger:WINDow:MAXWidth](#) on page 223

2.5.16 Protocol Trigger (R&S RTH-K1, R&S RTH-K2 and R&S RTH-K3)

The protocol trigger requires at least one of the serial protocol options.

For protocol setup and trigger settings, see:

- [Chapter 7.2.3, "I2C Trigger Settings"](#), on page 130
- [Chapter 7.3.3, "SPI Trigger Settings"](#), on page 135
- [Chapter 7.4.3, "UART Trigger Settings"](#), on page 140
- [Chapter 7.5.2, "CAN Trigger Settings"](#), on page 142
- [Chapter 7.6.3, "LIN Trigger Settings"](#), on page 149

3 Waveform Analysis

3.1 Zoom

The zoom magnifies a part of the waveform in order to view more details with a maximum zoom factor of 100.



To activate the zoom:

- ▶ Press the ZOOM key.

The zoom is applied to all active analog and digital channels and math waveforms. The waveforms are displayed with a shorter time scale while the vertical scale remains unchanged. The zoom indicator on the bottom shows the size and position of the zoom area in the waveform.

To adjust the zoom using the wheel:

1. Check if the zoom has the focus - an orange frame on the zoom indicator. If not, press the ZOOM key.

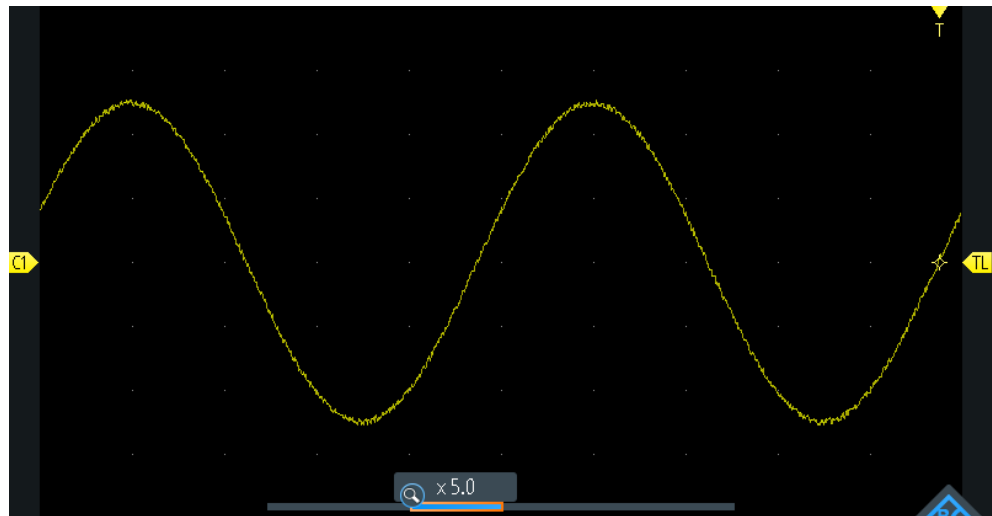

Figure 3-1: Zoomed waveform and zoom indicator with focus on zoom factor



Figure 3-2: Zoom indicator with focus on zoom position

2. Turn the wheel.
Depending on the focus, the position of the zoom area or the zoom factor is adjusted.
3. Press the wheel to toggle the setting.

- Turn the wheel to adjust the other parameter.

To position the zoom on the touchscreen:

- ▶ Use one of these methods:
 - Drag the zoom area in the zoom indicator.
 - Drag the trigger position marker.
In zoom mode, moving the trigger position marker changes the zoom position and not the horizontal position of the waveform.

To zoom in and out using pinching & spreading gestures

You can zoom in and out as you do on a mobile phone or tablet.

- To zoom in, touch the screen with two fingers and spread the fingers.
- To zoom out, touch the screen with two fingers and pinch them together.

To adjust the zoom numerically in the Zoom menu:

- ▶ Long-press the ZOOM key.

To analyze the zoomed signal, you can use cursor measurements.



Description of settings

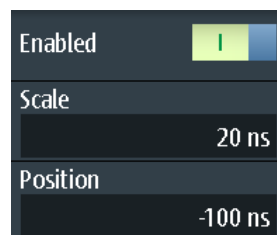

Enabled

Enables or disables the zoom.

Remote command:

[ZOOM:ENABLe](#) on page 223

Scale

Sets the time scale of the zoomed waveform.

$$Timebase_{zoom} = Timebase_{wfm} / Zoom\ factor$$

Remote command:

[ZOOM:SCALE](#) on page 224

Position

Sets the center position of the zoomed area in relation to the trigger point.

Note: The zoom overview also considers the horizontal position of the trigger point. If the horizontal position is $\neq 0$ and thus the trigger point is not in the middle, the zoom area in the overview is also shifted, even if the zoom position is 0.

Remote command:

ZOOM:POSition on page 224

3.2 Automatic Measurements

You can perform up to four different measurements simultaneously.

3.2.1 Performing Automatic Measurements

To start and stop the last configured measurements

- ▶ Press the MEAS key.

To configure automatic measurements in the Meas menu

1. To open the "Meas" menu, long-press the MEAS key.
2. Select the number of the measurement that you want to configure.
3. If the measurement is disabled, enable "State".
4. Select the "Type".
The selection list shows all available measurement types.
5. Select the "Source".
The selection list shows all active sources that are allowed for the selected measurement type.
6. Some measurement types require additional settings. Scroll down the menu and adjust the additional settings if necessary.

3.2.2 Measurement Results

The measurement results are shown on the left-top side of the screen.

C1	T = 100.1 ns	C2	Mean = 2.876 μ V
C3	RMS = 35.37 mV	C4	Dty+ = 50.00 %

Figure 3-3: Results of 4 active measurements

If a result cannot be determined, "---" is displayed. Adjust the horizontal and vertical settings if the instrument cannot measure.

If the measurement result is outside the measurement range and clipping occurs, the results are marked with < (underflow) or > (overflow). Adjust the vertical scale to get valid results.

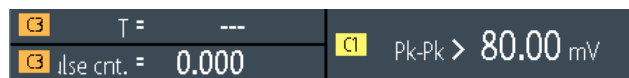

Figure 3-4: Invalid measurement results

Meas1 = period measurement on C3, no complete period detected

Meas2 = peak to peak measurement on C1, waveform is clipped

Meas3 = pulse count on C3, no pulse detected

Remote commands:



- [MEASurement<m>:RESult:ACTual?](#) on page 226
- [MEASurement<m>:RESult:LIMit?](#) on page 226

3.2.3 Measurement Types

The R&S RTH provides 35 measurement types to measure time, amplitude and power characteristics, and to count pulses and edges.

All measurement types that require only one source are also available for gated measurements using `CURSOR > "Type" = "Measure"`.

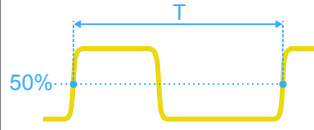
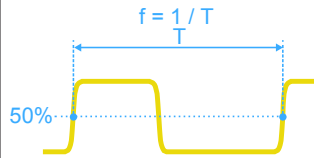
3.2.3.1 Time Measurements

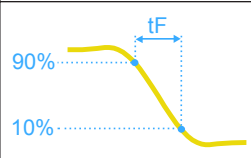
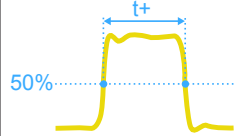

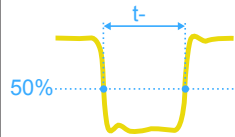
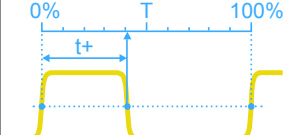
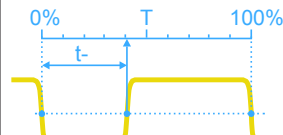
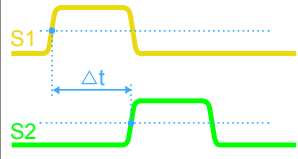
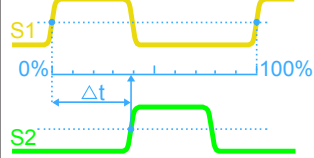
Meas. type	Symbol	Description	Graphic / formula	Source
Period	T in s	Time of the first period, measured on the 50% level. The measurement requires at least one complete period of the signal.		Analog, math, reference, logic
Frequency	f in Hz	Frequency of the signal, reciprocal value of the measured first period.		Analog, math, reference, logic
Rise time	tR in s	Rise time of the first rising edge. This is the time it takes the signal to rise from the 10% level to the 90% level.		Analog, math, reference
Fall time	tF in s	Fall time of the first falling edge. This is the time it takes the signal to fall from the 90% level to the 10% level.		Analog, math, reference
Positive pulse width	t+ in s	Duration of the first positive pulse: time between a rising edge and the following falling edge measured on the 50% level.		Analog, math, reference, logic

Meas. type	Symbol	Description	Graphic / formula	Source
Negative pulse width	t- in s	Duration of the first negative pulse: time between a falling edge and the following rising edge measured on the 50% level.		Analog, math, reference, logic
Positive duty cycle	Dty+ in %	Width of the first positive pulse in relation to the period in %. The measurement requires at least one complete period of the signal.	Dty+ = t+ / T * 100% 	Analog, math, reference, logic
Negative duty cycle	Dty- in %	Width of the first negative pulse in relation to the period in %. The measurement requires at least one complete period of the signal.	Dty- = t- / T * 100% 	Analog, math, reference, logic
Delay	Δt in s	Time difference between two slopes of the same or different waveforms, measured on the 50% level. Not available for cursor measurements		2 sources: analog, math, reference, logic
Phase	∠ in °	Phase difference between two waveforms, measured on the 50% level. Not available for cursor measurements	Phase = Δt / T * 360° 	2 sources: analog, math, reference, logic

3.2.3.2 Amplitude Measurements

The unit of most amplitude measurement results depends on the measured source.

Meas. type	Symbol	Description	Graphic / formula	Source
Mean value	Mean	Arithmetic average of the complete displayed waveform.	$\text{Mean} = \frac{1}{N} \sum_{k=1}^N x_k$	analog, math, reference, logic
RMS value	RMS	RMS (Root Mean Square) value of the voltage of the complete displayed waveform.	$\text{RMS} = \sqrt{\frac{1}{N} \sum_{k=1}^N x_k^2}$	analog, math, reference
Crest factor	Crest	The crest factor is also known as peak-to-average ratio. It is the maximum value divided by the RMS value of the displayed waveform.	$\text{Crest} = \frac{\text{Max} x_k }{\text{RMS}}$	analog, math, reference

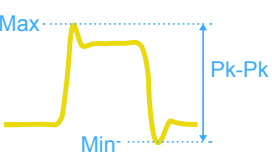
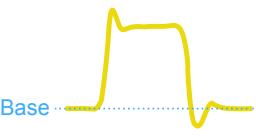
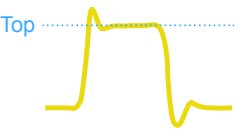
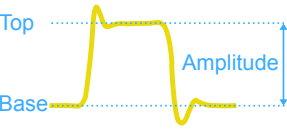
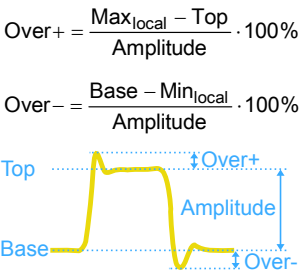
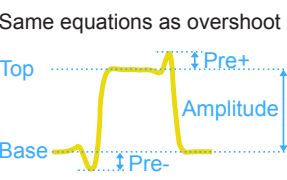
Meas. type	Symbol	Description	Graphic / formula	Source
Standard deviation	σ	Standard deviation of the displayed waveform.	$\sigma = \sqrt{\frac{1}{N-1} \sum_{k=1}^N (x_k - \text{Mean})^2}$	analog, math, reference
Minimum	Min	Minimum value within the displayed waveform.		analog, math, reference
Maximum	Max	Maximum value within the displayed waveform.		analog, math, reference
Peak to peak	Pk-Pk	Difference of maximum and minimum values.		analog, math, reference
Base level	Base	Low level of the displayed waveform - the lower maximum of the sample distribution. The measurement requires at least one complete period of the signal.		analog, math, reference
Top level	Top	High level of the displayed waveform - the upper maximum of the sample distribution. The measurement requires at least one complete period of the signal.		analog, math, reference
Amplitude	Amp	Difference between the top level and the base level of the signal. The measurement requires at least one complete period of the signal.		analog, math, reference
Overshoot	Over in %	Overshoot of a square wave <i>after</i> a rising or falling edge. It is calculated from measurement values top level, base level, local maximum, local minimum, and amplitude.	$\text{Over+} = \frac{\text{Max}_{\text{local}} - \text{Top}}{\text{Amplitude}} \cdot 100\%$ $\text{Over-} = \frac{\text{Base} - \text{Min}_{\text{local}}}{\text{Amplitude}} \cdot 100\%$ 	analog, math, reference
Preshoot	Pre in %	Overshoot of a square wave <i>before</i> a rising or falling edge.	<p>Same equations as overshoot</p> 	analog, math, reference

Meas. type	Symbol	Description	Graphic / formula	Source
AC	AC in V	RMS value of the AC part of a periodic signal, calculated over all periods on the display. The AC result is derived from the DC and AC+DC results.		analog, math, reference
DC	DC in V	Mean value of a periodic signal, calculated over all periods on the display. If no complete period is available, only the mean value of the visible waveform is calculated.		analog, math, reference
AC+DC	AC+DC in V	RMS value of a periodic signal, calculated over all periods on the display. If no complete period is available, only the RMS value of the visible waveform is calculated.		analog, math, reference

3.2.3.3 Counting

Meas. type	Symbol	Description	Graphic / formula	Sources
Positive pulse count	Cnt+	Number of positive pulses on the display. The mean value of the signal is determined. If the signal passes the mean value, an edge is counted. A positive pulse is counted if a rising edge and a following falling edge are detected.		Analog, math, reference, logic
Negative pulse count	Cnt-	Number of negative pulses on the display. The mean value of the signal is determined. If the signal passes the mean value, an edge is counted. A negative pulse is counted if a falling edge and a following rising edge are detected.		Analog, math, reference, logic
Rising edge count	Cnt↑	Number of rising edges on the display. The instrument determines the mean value of the signal and counts an edge every time the signal passes the mean value in the specified direction.		Analog, math, reference, logic
Falling edge count	Cnt↓	Number of falling edges on the display. The instrument determines the mean value of the signal and counts an edge every time the signal passes the mean value in the specified direction.		Analog, math, reference, logic

3.2.3.4 Power Measurements

Power measurements require two sources, one voltage source and one current source. They are not available for cursor measurements and logic channel sources.

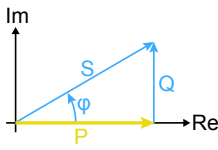
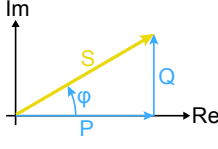
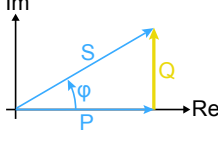
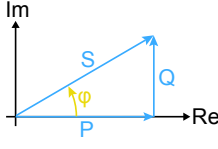
Meas. type	Symbol	Description	Graphic / formula	Sources
Active power	P in W	Active or real power is the energy of the system that can be used to do work.		2 sources: analog, math, reference
Apparent power	S in VA	Complex power S is the magnitude of the vector sum of real and reactive power.		2 sources: analog, math, reference
Reactive power	Q in var	Reactive power is temporally stored in a system because of the inductive and capacitive elements.		2 sources: analog, math, reference
Power factor	PF (no unit)	Power factor is a measure of the system efficiency. The value varies between -1 and 1.	PF = $\cos(\varphi)$ 	2 sources: analog, math, reference

3.2.4 Measurement Settings

Access: "Meas" menu

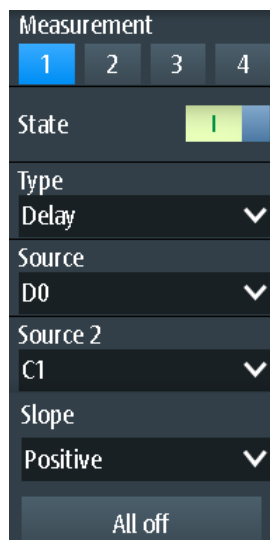

Measurement

Selects the measurement to be configured in the menu. You can perform up to four different measurements simultaneously.

State

Enables or disables the selected measurement.

Remote command:

[MEASurement<m>:ENABle](#) on page 224

Type

Selects the measurement type. For a detailed description, see [Chapter 3.2.3, "Measurement Types"](#), on page 80.

Remote command:

[MEASurement<m>:TYPE](#) on page 225

Source / Source 2

Defines the waveform to be measured. For delay, phase, and power measurements, 2 sources are required.

The sources can be any active input signal, math or reference waveform. Available source waveforms depend on the measurement type, see [Chapter 3.2.3, "Measurement Types"](#), on page 80.

Remote command:

[MEASurement<m>:SOURce](#) on page 225

All off

Disables all active measurements.

Remote command:

[MEASurement<m>:AOFF](#) on page 226

Slope

Sets the slope for the delay measurement type.

"Positive" Delay between the first rising edge of each source waveform.

"Negative" Delay between the first falling edge of each source waveform.

"Either" Delay between the first edge of each source waveform, no matter if it is rising or falling.

Remote command:

[MEASurement<m>:DELay:SLOPe](#) on page 226

3.3 Cursor Measurements

The cursor measurement determines the results at the current cursor positions, or or performs gated automatic measurements between the cursor lines. The cursors can be positioned manually at fixed positions, or they can follow the waveform.

You can perform cursor measurements on analog input signals, math waveform, XY-diagram, as well as on logic channels (requires option R&S RTH-B1).

3.3.1 Performing Cursor Measurements

To start and stop the last configured measurement

- ▶ Press the CURSOR key.

To configure the cursor measurement in the Cursor menu

1. To open the "Cursor" menu, long-press the CURSOR key.
2. Select the "Type" of the cursor.
3. For horizontal, track and measure types, select the "Source" channel that you want to measure.
4. Scroll down the menu and adjust the additional settings, which are required for the selected cursor type.

3.3.2 Cursor Types and Results

The results of cursor measurements are displayed at the top of the display. 4 cursor types are available.

Vertical cursors

For vertical cursors, two results are displayed by default: the absolute value of the time difference between the cursor lines Δt and its inverse value $1/\Delta t$. Optionally, the positions of the cursor lines t_1 and t_2 are also measured. The results are time values and do not depend on any waveform, thus no source is required.

Cursor Vert.	$\Delta t = 600.0 \text{ ns}$	$1/\Delta t = 1.667 \text{ MHz}$
-----------------	-------------------------------	----------------------------------

- [CURSor:TDELta?](#) on page 229
- [CURSor:ITDelta?](#) on page 229
- [CURSor:X1Position](#) on page 229
- [CURSor:X2Position](#) on page 229

Horizontal cursors

For horizontal cursors, the vertical values of the cursor positions y_1 and y_2 are measured. These are usually voltage or current values. The absolute value of the difference between the positions Δy is also displayed.

Cursor Horiz.	C1	$y_1 = -120.0 \text{ mV}$	$y_2 = 120.0 \text{ mV}$	$\Delta y = 240.0 \text{ mV}$
------------------	-----------	---------------------------	--------------------------	-------------------------------

- [CURSor:Y1Position](#) on page 230
- [CURSor:Y2Position](#) on page 230
- [CURSor:DELTA?](#) on page 229

Track cursors

Two vertical cursor lines are coupled to the waveform. The instrument measures the vertical values y_1 and y_2 of the crossings between the cursor lines and the waveform. It also measures the absolute values of the difference between the positions Δy and of the time difference between the cursor lines Δt

Cursor Track	C1	$y_1 = 384.3 \text{ mV}$	$\Delta y = 13.41 \text{ mV}$
		$y_2 = 397.7 \text{ mV}$	$\Delta t = 600.0 \text{ ns}$

- [CURSor:Y1Amplitude?](#) on page 230
- [CURSor:Y2Amplitude?](#) on page 230
- [CURSor:DELTA?](#) on page 229
- [CURSor:TDELTA?](#) on page 229

Measurements

Two vertical cursor lines define a gate for two parallel automatic measurements. All automatic measurements that need only one source are available. Delay, phase, and power measurements are not provided for cursor measurements, they require two sources.

See [Chapter 3.2.3, "Measurement Types"](#), on page 80.

Cursor Meas	C1	$T = 99.85 \text{ ns}$	$Rise = 27.13 \text{ ns}$
----------------	-----------	------------------------	---------------------------

If the measurement result is outside the measurement range and clipping occurs, the results are marked with < (underflow) or > (overflow). Adjust the vertical scale to get valid results.

- [CURSor:MEASurement<m>:RESult:ACTual?](#) on page 230
- [CURSor:MEASurement<m>:RESult:LIMit?](#) on page 230

3.3.3 Settings for Cursor Measurements

Access: "Cursor" menu

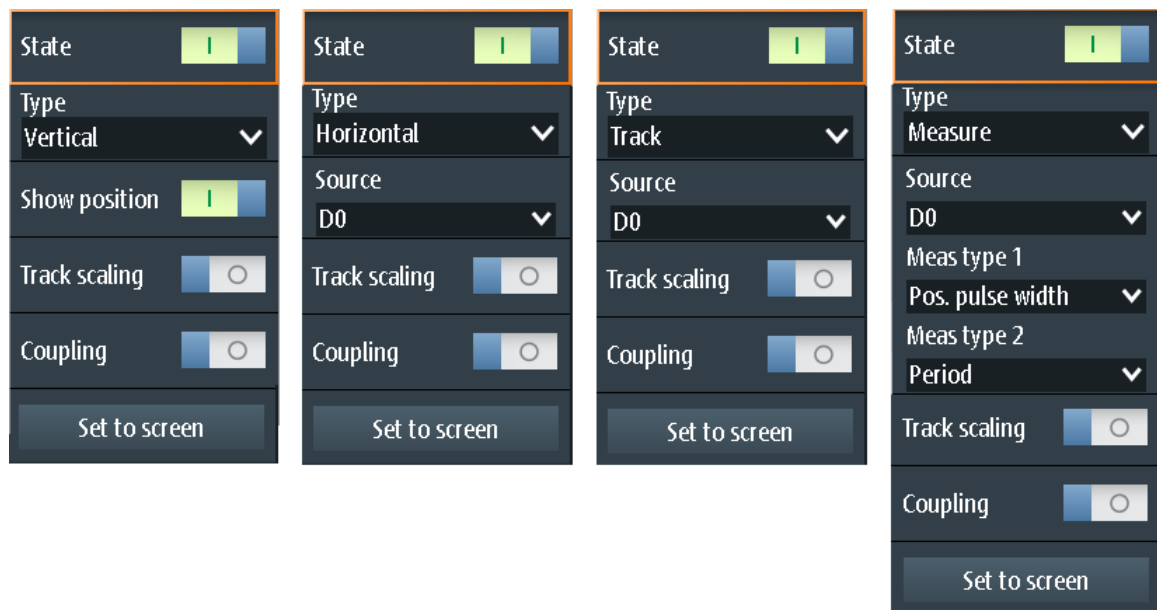
**State**

Enables or disables the cursor measurement.

Remote command:

[CURSor:STATe](#) on page 227

Type

Defines the type of the cursor measurement.

For details, see [Chapter 3.3.2, "Cursor Types and Results"](#), on page 86.

"Vertical"	Displays two vertical cursor lines and measures their timing parameters.
"Horizontal"	Displays two horizontal cursor lines and measures their amplitude parameters.
"Track"	Displays two vertical cursor lines and couples them to the source waveform. The amplitude characteristics and the time difference of the crossing points are measured.
"Measure"	Displays two vertical cursor lines that define a gate for two simultaneous automatic measurements.

Remote command:

[CURSor:FUNction](#) on page 227

Source

Defines the source on which the cursor measurement is performed. The source can be any active analog or digital input signal, math waveform, or bus (requires option).

The source setting is not available for the cursor type "Vertical", and for measurements in the XY-diagram.

Remote command:

[CURSor:SOURce](#) on page 227

Show Position

Shows the position values of the vertical cursor lines t1 and t2 in the measurement results. The setting is only available for the vertical cursor type.

Cursor	t1 = -285.6 ns	Δt = 600.0 ns
Vert.	t2 = 314.4 ns	1/ Δt = 1.667 MHz

Meas Type 1 / Meas Type 2

Set the automatic measurements to be performed on the source waveform between the cursor lines. The setting is only available for the "Measure" cursor type.

All automatic measurements that need only one source are available. Delay, phase, and power measurements are not provided for cursor measurements, they require two sources.

For a description of the measurement types, see [Chapter 3.2.3, "Measurement Types"](#), on page 80.

Remote command:

[CURSor:MEASurement<m>:TYPE](#) on page 228

Track Scaling

If enabled, the position of the cursor lines is adjusted if the vertical or horizontal scales are changed. The cursor lines keep their relative position to the waveform.

If disabled, the cursor lines remain on their position on the display if the scaling is changed.

Remote command:

[CURSor:SCPLing](#) on page 228

Coupling

Couples the cursor lines so that the distance between the two lines remains the same if one cursor is moved.

Remote command:

[CURSor:COUPLing](#) on page 228

Set to Screen

Sets the cursors to a default position on the screen. This is helpful if the cursors have disappeared from the display or need to be moved for a larger distance.

Remote command:

[CURSor:SCReen](#) on page 228

3.4 Mathematics

A math waveform is a calculated waveform. You can calculate data out of one or two different sources using several predefined operations.

- ▶ To configure the math waveform, long-press the MATH key.
- ▶ To activate or deactivate the last configured math waveform, press the MATH key.

- ▶ To adjust vertical scale and position of the math waveform, use the RANGE and POS keys.

You can analyze math waveforms in the same way as channel waveforms: use zoom, perform automatic and cursor measurements, save as reference waveform, and perform mask tests.

Description of settings

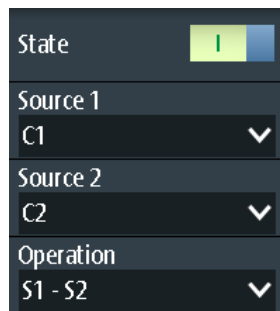

State

Activates the waveform and displays it.

Remote command:

[REFCurve:STATe](#) on page 232

[CALCulate:MATH:STATe](#) on page 231

Source 1 / Source 2

Sets the source(s) for the defined mathematic operation.

Operation

Select an operation to calculate the math waveform.

"S1 + S2" *Addition:* Adds the values of "Source 1" and "Source 2".



"S1 - S2" *Subtraction:* Subtracts the values of "Source 2" from the values of "Source 1".

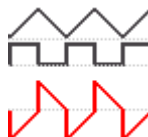

"S1 * S2" *Multiplication:* Multiplies the values of "Source 1" and "Source 2".



"-S1," *Inverse:* Inverts all voltage values of "Source 1", i.e. all values are mirrored at the ground level. Thus, a positive voltage offset becomes negative.

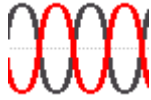

"|S1|" *Abs. Value:* Calculates the absolute value of "Source 1". All negative values are inverted to positive values.

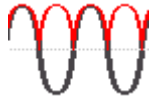

"S1²" *Square:* Squares the value of "Source 1".



Remote command:

[CALCulate:MATH\[:EXPRession\] \[:DEFine\]](#) on page 231

RANGE keys

The vertical RANGE keys set the vertical scale (vertical sensitivity) of the math waveform.

Remote command:

[CALCulate:MATH:VERTical:SCALE](#) on page 231

[CALCulate:MATH:VERTical:RANGe](#) on page 232

POS keys

Move the math waveform or down in the diagram. The position is a graphical setting given in divisions.

You can also drag the waveform marker on the screen.

Remote command:

[CALCulate:MATH:VERTical:POSition](#) on page 232

3.5 Reference Waveforms

To compare waveforms and analyze differences between waveforms, you can use a reference waveform. You can also save reference waveforms and load them for further use. The display of a reference waveform is independent from that of the source waveform; you can change the vertical scale and position



To create and save a reference waveform

1. Set up the waveform that will be the reference.
2. Open the "Ref" menu.

3. Select the "Source" waveform.
4. Select "Update".
The reference waveform is created, activated, and shown on top of the original waveform.
5. You can change the vertical scale and position using the RANGE and POS keys.
6. To save the reference, select "Save".
7. Select the "File Type" (format BIN, XML, or CSV).
8. Select the "File Name" and enter the file name.

3.5.1 Settings for Reference Waveforms

Access: "Ref" menu

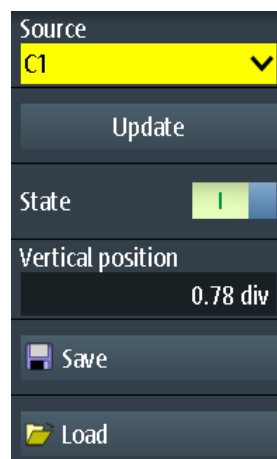

Source

Selects the waveform to be taken as reference waveform. Any active channel or math waveform can be used.

Remote command:

[REFCurve:SOURce](#) on page 232

Update

Creates the reference waveform from the source waveform.

Remote command:

[REFCurve:UPDate](#) on page 232

State

Activates the waveform and displays it.

Remote command:

[REFCurve:STATe](#) on page 232

[CALCulate:MATH:STATe](#) on page 231

Vertical Position

Sets the vertical position of the reference waveform.

You can also tap the waveform label "R" to set the focus to the reference waveform, and use the RANGE and POS keys to adjust the display.

Remote command:

[REFCurve:POSition](#) on page 233

Save / Load

Saves or loads a reference waveform. The default directory is `C:/Users/<user>/Rohde-Schwarz/RTH/ReferenceCurves`.

Select the "File Type" (format BIN, XML, or CSV) and enter the "File Name". See also [Chapter 3.5.2, "Waveform Files"](#), on page 93.

Remote command:

[REFCurve:NAME](#) on page 233

[REFCurve:SAVE](#) on page 233

[REFCurve:OPEN](#) on page 233

[REFCurve:DELeTe](#) on page 233

3.5.2 Waveform Files

Reference waveforms can be stored in XML, CSV, or BIN format.



If you want to reload reference waveforms on the instrument, save them in BIN or CSV format. XML files cannot be reloaded.

Waveform data is saved in two files. One file contains the waveform data values and is indicated by `*Wfm.*` in the file name. The second file contains the header data, for example, time scale, vertical scale, vertical position, acquisition mode, and more. Header data is required to reload the waveform from data, or to analyze the data values of the data file.

3.5.2.1 Waveform Header Files

The header files of XML and BIN waveform files are written in XML format. The header files of CSV waveform files are written in CSV format. You can open the header files and use their information for data analysis.

CSV header files only contain the property names and values, one property per row.

```
VerticalScale:0.05:
```

```
HorizontalScale:5e-08:
```

XML header files contain more information than CSV header files. For analysis, only `Name` and `Value` are needed.

```
<Prop Name="VerticalScale" Value="0.05" UserValue="0.05" Step="0.001" Default="0.05"
Min="0.001" Max="100" StepDefault="0.001" StepFactor="10" UnitId="77"
UnitName="V/div" BitGroupSize="0" Format="0"></Prop>
<Prop Name="HorizontalScale" Value="1e-07" UserValue="1e-07" Step="1e-09"
Default="1e-07" Min="1e-09" Max="500" StepDefault="1e-09" StepFactor="10"
UnitId="75" UnitName="s/div" BitGroupSize="0" Format="0"></Prop>
```

Header files contain the following properties:

Value	Description
Vertical settings	
VerticalScale	Vertical scale of the waveform in Volts per division, or other unit / division
VerticalOffset	Vertical offset of the waveform in Volts, or other unit
VerticalPosition	Vertical position of the waveform in divisions
Horizontal and acquisition settings	
HorizontalScale	Time scale in seconds per division
HorizontalLeft	Horizontal start value of the waveform (time in s)
HorizontalResolutionPP	Time between two recorded samples
HorizontalAcquisitionMode	Sample, Peak Detect, High Res, Envelope, or Average
HorizontalDecimationFactor	At long time bases, if the number of captured samples is higher than the available record length, decimation takes effect. If the time scale is $\leq 5 \mu\text{s}/\text{div}$, the decimation factor is 1.
Samples	
HorizontalTraceLength	Record length, number of recorded waveform samples, which are stored in the memory
PostSettlingSamples	Number of additional samples after the end of the waveform record.
PreSettlingSamples	Number of additional samples before the beginning of waveform samples. They ensure that all measurements can be performed on the reloaded waveform that could be performed on the original waveform.

3.5.2.2 Waveform Data Files

The waveform data files are indicated by **Wfm.** in the file name. They contain the actual waveform data, the Y-values of the samples. Mostly, the Y-values are voltages:

Y0; Y1; Y2; Y3; ...

Before and after the waveform data, the instrument writes some presettling and post-settling samples. The overall number of values in the data file is:

$$\text{ValuesNumber} = \text{PreSettlingSamples} + \text{HorizontalTraceLength} + \text{PostSettlingSamples}$$

For envelope waveforms, the number of values in the file doubles. Two Y-values for each sample are written, one for the upper and one for the lower envelope:

Ymin0; Ymax0; Ymin1; Ymax1; Ymin2; Ymax2; Ymin3; Ymax3;...

In peak detect acquisition mode, the number of values depends on the decimation factor. If the decimation factor is 1, one value per sample is written. At higher decimation factors, two values per sample are written.

In CSV files, the data values of one sample are written in one row. Envelope data, for example, looks like this:

```
-0.0125490196078431    -0.0619607843137255
-0.0133333333333333    -0.0627450980392157
-0.0149019607843137    -0.0650980392156863
```

XML files are easy to read:

```
<sample>
  <datamax>-0.012549</datamax>
  <datamin>-0.0619608</datamin>
</sample>
<sample>
  <datamax>-0.0133333</datamax>
  <datamin>-0.0627451</datamin>
</sample>
<sample>
  <datamax>-0.014902</datamax>
  <datamin>-0.065098</datamin>
</sample>
```

3.6 XY-Diagram

XY-diagrams combine the voltage or current levels of two input signals in one diagram. They use the level of a second signal as the x-axis, rather than a time base. This allows you to perform phase shift measurements, for example.



1. Press the MODE key.
2. Select "XY".
3. Make sure that the signals, the trigger, and the acquisition are set up correctly. The following menus are available in XY-mode:
 - "Vertical", see [Chapter 2.2, "Vertical Setup"](#), on page 42.
 - "Horizontal", see [Chapter 2.3, "Horizontal Setup"](#), on page 46.
 - "Trigger", see [Chapter 2.5, "Trigger"](#), on page 49.
 - "Acquire", see [Chapter 2.4, "Acquisition Control"](#), on page 47.

To analyze the signal in XY-mode, you can use cursor measurements. You can select vertical or horizontal cursors, couple the cursor lines or set them to screen. All other cursor settings are not relevant for measuring the XY-diagram.

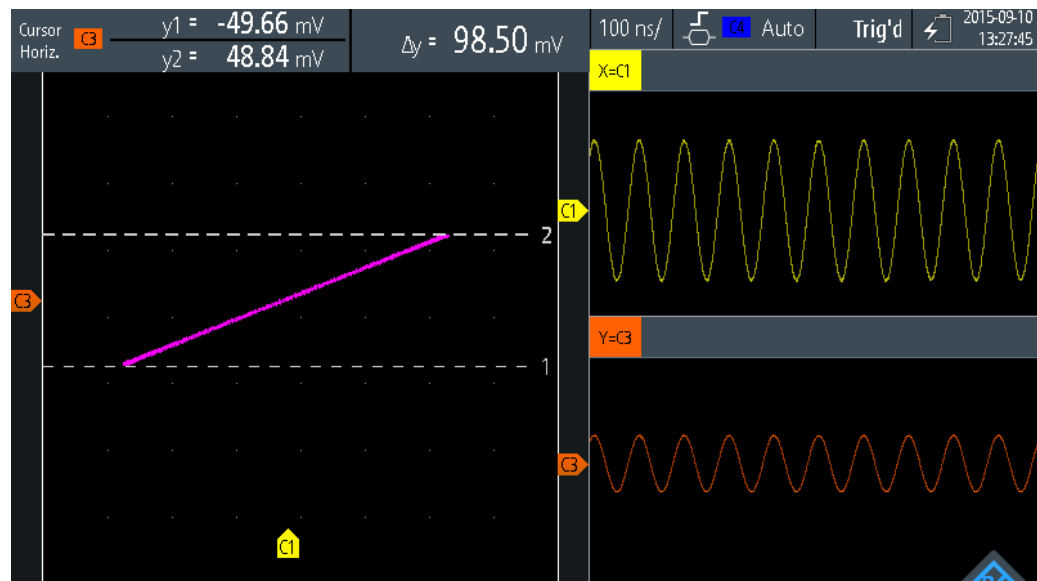

Description of settings

Source X

Defines the signal that supplies the x-values of the XY-diagram, replacing the usual time base. The source can be any of the active analog channels.

Source Y

Defines the signal to be displayed in y-direction in an XY-diagram. The source can be any of the active analog channels.

3.7 History (Option R&S RTH-K15)

The history option R&S RTH-K15 accesses the data of previous acquisitions and provides them for further analysis. Using this option, you can analyze, for example, packet communication on serial buses, radar pulses, laser pulses, and signals that occur in short bursts with long idle times.

If history is enabled and an acquisition runs, the instrument stores the captured waveforms, processes the data and displays the current waveform. Each stored waveform is called a segment. When the acquisition is stopped, the history player is shown to access the stored segments, and to display and analyze them. When you start a new acquisition, the history is cleared and written anew.

The history stores the following data during acquisition:

- All active analog channels.
- All logic channels if at least one logic is active (with option R&S RTH-B1).
- Decoded bus data if the bus is active (with option R&S RTH-K1 and/or R&S RTH-K2).

To enable the history:

1. Tap the Menu button and select "History" on the menu.
2. Enable "History".

3.7.1 History Settings

Access: "History" menu

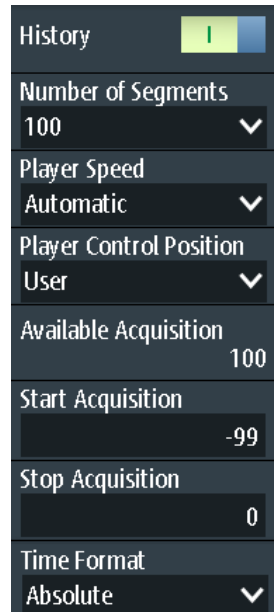
**History**

Enables the history function. The instrument stores the captured waveforms in segments. After stopping the acquisition, you can analyze them.

Remote command:

[CHANnel<m>:HISTory\[:STATe\]](#) on page 234

Number of Segments

Sets the number of segments to be stored.

Note: If zoom or mathematics are active during acquisition, the actual number of stored segments may be less than the defined number. To avoid the decrease of stored waveforms, disable zoom and mathematics before you acquire the waveforms. You can enable zoom and mathematics later in stop mode and use them to analyze any of the history segments.

Remote command:

[CHANnel<m>:HISTory:NSEGments](#) on page 234

Player Speed

Defines how fast the history player shows the stored segments.

Remote command:

[CHANnel<m>:HISTory:TPACq](#) on page 234

Player Control Position

Sets the position of the history player window on the display. You can drag the window on the touchscreen to another position. If so, a "User" position is indicated.

Available Acquisition

Shows the number of segments that are currently stored in the history.

Remote command:

[ACQUIRE:AVailable?](#) on page 234

Start Acquisition / Stop Acquisition

Define the index of the first and the last history segment that the history player shows. Change these values if you want to see a smaller range of subsequent segments from the history. The newest segment has always the index "0". Older segments have a negative index. The number of available segments is shown in "Available Acquisition".

Remote command:

[CHANnel<m>:HISTory:START](#) on page 234

[CHANnel<m>:HISTory:STOP](#) on page 235

Time Format

Defines if the timestamp in the history player window shows the absolute or relative time. Absolute time is the date and the daytime of the current acquisition. Relative time is the difference to the newest segment (index = 0).

See also "[Timestamp](#)" on page 99.

3.7.2 Displaying History Data

In the history player window, you start and stop the playback of the stored segments, and you can display a particular acquisition.

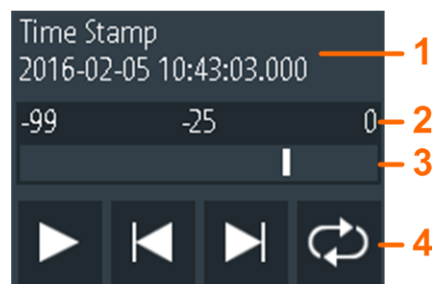

1 = Timestamp, here: absolute time

2 = Index of the oldest, current, and newest (= 0) segment

3 = Slider to set the displayed segment

4 = Control buttons: Play, Step Forward, Step Back, and Repeat

Timestamp

The timestamp shows the time of the currently displayed history segment. Thus, the time relation between acquisitions is always available. More precisely, the timestamp is the time of the trigger event.

The timestamp can be absolute or relative:

- Absolute: Date and daytime of the trigger event of the displayed segment. Depending on the horizontal position, the waveform can be captured up to 100,000 seconds after the trigger event, and thus after the displayed timestamp. The instrument considers this delay automatically, all measurements are related to the trigger event.
- Relative: time difference of the current segment to the newest segment (index = 0).

Remote command:

- `CHANnel<m>:HISTory:TSABsolute?` on page 236
- `CHANnel<m>:HISTory:TSDate?` on page 236
- `CHANnel<m>:HISTory:TSRelative?` on page 236

To display history segments

You can access the history segments in several ways:

- Play back all captured history segments.
- Play back a specified range of subsequent segments.
- Show one particular segment.

Proceed as follows:

1. If the acquisition is running, stop the acquisition.
The history player is shown.
2. To play back the segments once, tap the Play button.
By default, all captured waveforms are shown.
3. To display a range of segments out of the history:
 - a) Open the "History" menu.
 - b) Set the index of the first and the last segment that you want to see.
See "[Start Acquisition / Stop Acquisition](#)" on page 98.
 - c) In the history player window, tap the Play button.
4. To play back the segments repeatedly.
 - a) Enable the "Repeat" button.
 - b) Tap the "Play" button.
5. To access a particular segment, you can:
 - Drag the slider in the history player window, until the required index number is shown.
 - Use the "Step Forward" and "Step Back" buttons to show the next segment.

Remote command:

- `CHANnel<m>:HISTory:PLAY` on page 235
- `CHANnel<m>:HISTory:REPLay` on page 235
- `CHANnel<m>:HISTory:CURRent` on page 235

3.7.3 Analyzing History Data

You can analyze the stored segments using the following possibilities:

- Switch analog channels on and off if they were active during acquisition.
- Change vertical scale and position of captured channels.
- Use the zoom.
- Save screenshots.
- Perform cursor measurements.
- Perform automatic measurements.
- Use the mathematical functions.
- Switch logic channels on and off if at least one channel was active during acquisition.
- Enable and disable the serial bus if it was active during acquisition.

3.7.4 Exporting History Data

You can export history data to files. History data is always saved in "Compressed CSV" files. Each segment is saved to a separate file, and all segment files are written to a compressed folder.

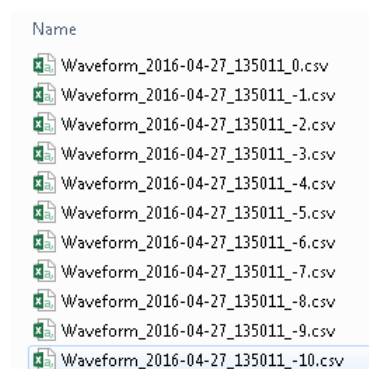

Figure 3-5: Content of a history waveform folder

The file names are built using the filename pattern and the segment index:

`<filename base>_<date>_<time>_<index>.csv.`

In the header section, the relative timestamp of each segment is written. The newest segment with index 0 has the timestamp 0. All timestamps are relative to the newest segment, in s.

Timestamp	-0.000046568
Waveform Type	ANALOG
Acquisition Mode	SAMPLE
Horizontal Unit	s
Horizontal Scale	1.00E-07
Horizontal Position	1.06E-22
Reference Point	50%
Sample Interval	2.00E-10
Record Length	5000
Probe Setting	'10:1'
Vertical Unit	V
Vertical Scale	0.5
Vertical Position	0
Vertical Offset	0

To save history data:

1. Set up the history and capture the waveforms.
2. Press the FILE key.
3. Select "Waveforms".
4. Tap "Select Waveform" and select one waveform for export, or select all active waveforms.
5. Enable "Save History".
If acquisition is running, enabling "Save History" stops the acquisition.
6. Check the "Waveform Directory", the "Filename Base", and the "CSV Column Delimiter". Adjust if necessary.
7. If you need time information for analysis, enable "Store with Time".
8. Tap "Save Waveform".

All export settings are described in [Chapter 9.3.2, "Waveform Export Settings"](#), on page 162.

4 Mask Testing

Masks are used to determine whether the amplitude of a signal remains within specified limits, e.g. to detect errors or test compliance of digital signals.

A mask is specified by an upper and a lower limit line. The signal must run inside these limit lines, otherwise a mask violation occurs. A new mask is created from an existing signal: Mask limits are created by copying the waveform, and the limits are moved and stretched. The result is a tolerance tube around the signal that is used as mask.

4.1 Accessing the Mask Mode

1. Press the MODE key.

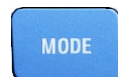

2. Select "Mask".

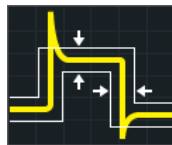

The mask interface is displayed and mask testing is started if masks are already defined and activated.

4.2 Mask Test Results

Mask testing checks all active waveforms for mask violation simultaneously.

The test result of the selected mask is shown in the result table in the upper left corner of the display.

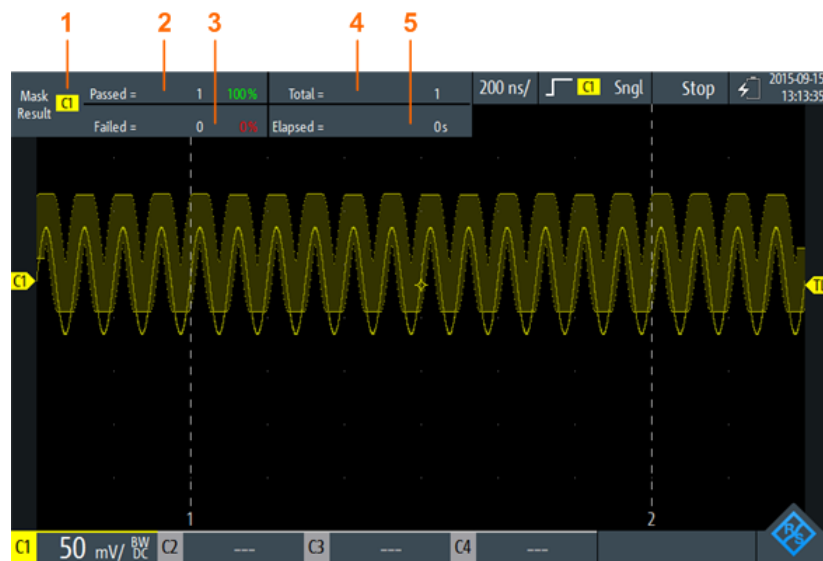

Figure 4-1: Mask-mode-view

- 1 = Selected channel
- 2 = Number and percentage share of passed acquisitions
- 3 = Number and percentage share of failed acquisitions
- 4 = Number of tested acquisitions
- 5 = Test duration

Remote commands for mask test results:

- [MASK:CHANnel<m>:RESult:PASS\[:COUNT\]? on page 239](#)
- [MASK:CHANnel<m>:RESult:PASS:PERCentage? on page 239](#)
- [MASK:CHANnel<m>:RESult:FAIL\[:COUNT\]? on page 239](#)
- [MASK:CHANnel<m>:RESult:FAIL:PERCentage? on page 238](#)
- [MASK:CHANnel<m>:RESult:TOTL\[:COUNT\]? on page 240](#)
- [MASK:ELAPsedtime:TOTAL? on page 240](#)
- [MASK:ELAPsedtime\[:SECS\]? on page 240](#)
- [MASK\[:TESTstate\]? on page 238](#)

4.3 Running Mask Tests

1. Before you can perform mask tests, adjust the waveforms by editing the vertical, horizontal, trigger and acquisition settings.

For details see:

- [Chapter 2.2, "Vertical Setup", on page 42](#)
- [Chapter 2.3, "Horizontal Setup", on page 46](#)
- [Chapter 2.5, "Trigger", on page 49](#)
- [Chapter 2.4, "Acquisition Control", on page 47](#)

Note: The acquisition mode "Envelope" is not available while running mask tests.

2. If you want to test a mathematical (math) waveform, generate a math waveform, see [Chapter 3.4, "Mathematics"](#), on page 89.
3. Select the "Mask" menu.
4. Select the mask channel that is assigned to the tested waveform.
5. To activate the mask, tap "State".

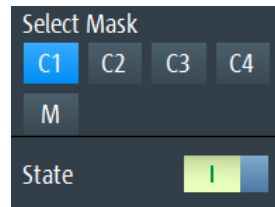

Note: If the selected mask was used before, the stored mask is displayed.

6. To set the mask width, enter "Width X" and "Width Y".
7. Select the "Action on Violation".
This action is applied to all masks.
8. To create the mask, tap "Create Mask".
9. To start and stop mask testing, press the RUN STOP key.



Analyzing the mask test

To view the details of the waveform at a mask test violation, you can use the zoom function, see [Chapter 3.1, "Zoom"](#), on page 77. Zooming is only possible while the mask test is stopped.

4.4 Mask Settings

Access: "Mask" menu

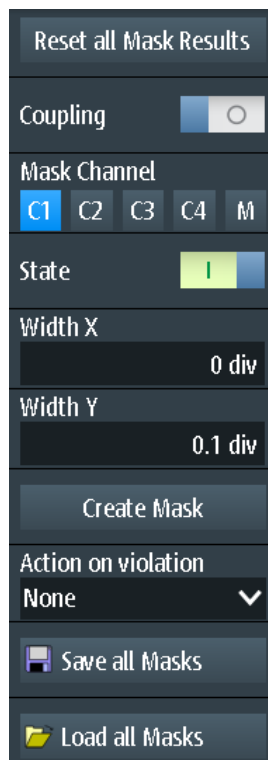

Figure 4-2: Mask settings

Reset all Mask Results

Resets all mask test results.

Remote command:

[MASK:RST](#) on page 238

Coupling

If enabled, the settings of the selected mask are applied to all active masks when you tap "Create Mask".

Mask Channel

Selects the mask to be configured.

If the selected mask has been created before, and it is active, the mask is shown on the display.

Each mask channel is assigned to its related waveform (input channel or math waveform) as indicated by the mask channel name.

State

Turns the mask on or off.

If the assigned waveform is inactive, it is activated together with the mask.

Remote command:

[MASK:CHANnel<m>:STATe](#) on page 237

Width X

Changes the width of the mask in horizontal direction.

The specified number of divisions is added to the positive x-values and subtracted from the negative x-values of the mask limits in relation to the mask center. Thus, the left half of the mask is pulled to the left, the right half is pulled to the right.

To apply the changed value to an existing mask, tap "Create Mask".

Remote command:

[MASK:CHANnel<m>:PROPerties:XWIDth](#) on page 237

Width Y

Changes the width of the mask in vertical direction.

The specified number of divisions is added to the y-values of the upper mask limit and subtracted from the y-values of the lower mask limit. Thus, the upper half of the mask is pulled upwards, the lower half is pulled down, and the overall height of the mask is twice the "Width Y".

To apply the changed value to an existing mask, tap "Create Mask".

Remote command:

[MASK:CHANnel<m>:PROPerties:YWIDth](#) on page 237

Create Mask

Creates a new mask, or applies modified mask settings to the mask.

If "Coupling" is enabled, all active masks are recreated with the settings of the selected mask.

Remote command:

[MASK:CHANnel<m>:CREatemask](#) on page 237

Action on Violation

Selects the action to be executed if the mask limits are violated.

This action is applied to all masks.

Remote command:

[MASK:ONViolation\[:SELECTION\]](#) on page 238

Save all Masks

Opens an explorer to save all active masks.

Load all Masks

Opens an explorer to load masks.

If an acquisition is running, the acquisition is topped until the masks are reloaded.

RUN / STOP

Starts and stops triggering on mask violations.

Remote command:

[RUN](#) on page 196

[STOP](#) on page 196

5 Multimeter Measurements

The 4-channel R&S RTH1004 has 4 software-based voltmeters, which can measure in parallel. For each voltmeter you can select the source and measurement type. See [Voltmeter \(R&S RTH1004\)](#).

The 2-channel R&S RTH1002 has a hardware-based digital multimeter with two separate banana plug inputs for various multimeter measurements. Except for voltages, the DMM can also measure resistance, capacitance, temperature and more. See [Digital Multimeter \(R&S RTH1002\)](#).

5.1 Digital Multimeter (R&S RTH1002)

The hardware-based digital multimeter features various multimeter measurements. Except for voltages, the DMM can also measure resistance, capacitance, temperature and more.

In "Meter" mode, a separate self-alignment of the meter inputs is available, see [Chapter 10.3, "Selfalignment"](#), on page 172.

All remote commands for configuration and measuring are listed in [Chapter 12.6, "Digital Multimeter \(R&S RTH1002\)"](#), on page 240.

5.1.1 Accessing the Meter Mode

► There are several ways to start the multimeter mode:

- Press the DMM key.



- Press the MODE key, and select "Meter".

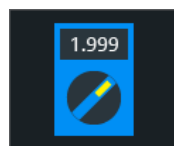

- To start relative measurements, press the DMM REL key.

The multimeter interface is displayed, and the measurement is started immediately.

5.1.2 Display and Control

The multimeter display shows detailed results and setup icons.

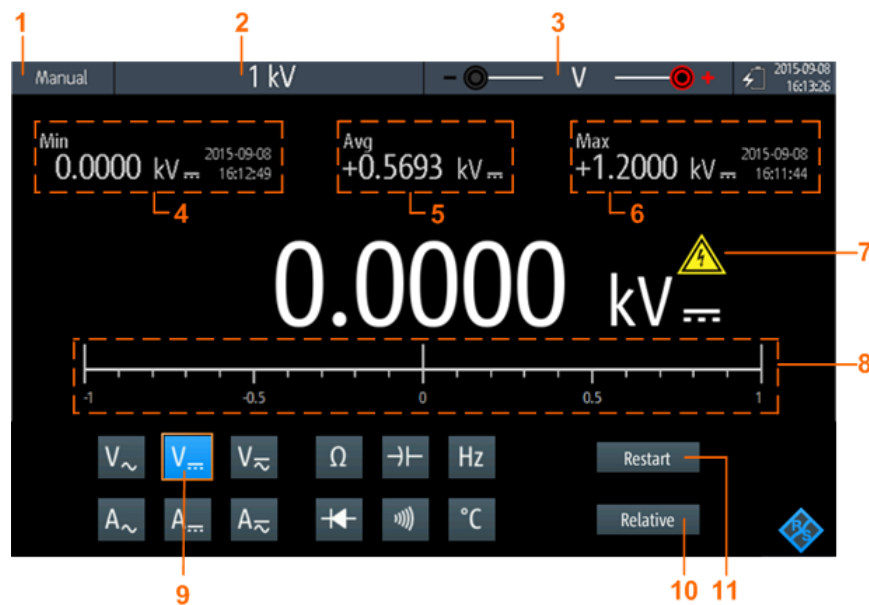



Figure 5-1: Display of the digital multimeter

- 1 = Measurement state. "Manual" or "Auto": running measurement with manual or automatic range. "Hold": stopped measurement.
- 2 = Measurement range
- 3 = Test lead connection including polarity
- 4 = Minimum value and timestamp
- 5 = Average value
- 6 = Maximum value and timestamp
- 7 = Warning sign, shows up if the measured value is higher than 30 V
- 8 = Bargraph displaying the measured value
- 9 = Measurement type
- 10 = Activates or deactivates relative measurement
- 11 = Restarts the measurement and resets all values

In meter mode, the keys behave slightly different from scope mode:

- The AUTOSSET key toggles the range mode: autoranging and manual range setting.
- The vertical RANGE and POS keys adjust the measurement range.
- The MEAS key opens the "Meter" menu.
- The following keys work as usual: FILE, , , PRESET, MODE, BACK.
- The CH keys switch back to the scope mode.
- All other keys do not work.

5.1.3 Running Multimeter Measurements

1. Connect the test leads to the meter inputs.
2. Select the "Meter" mode.
3. Select the measurement type (no. 9 in [Figure 5-1](#)).

4. To set the range mode to autoranging or manual range setup, press AUTOSET.
5. If you are in manual range mode, adjust the measurement range: Press the RANGE keys.
6. For current and temperature measurements, adjust the "Probe Setting".
7. For continuity measurement, adjust the "Resistance Threshold".
8. If you want to get relative result values:
 - a) Activate "Relative" (no. 10).
 - b) To set a user-defined reference value, open the "Meter" menu.
 - c) Activate "Reference", and enter the value in "Reference Manual".

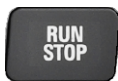

9. To stop the meter measurement, press the RUN STOP key.

The status "Hold" is displayed on the upper left. Stopping the measurement does not delete statistical values. The measurement continues when you press RUN STOP again.

5.1.4 Settings

Access: "Meter" menu

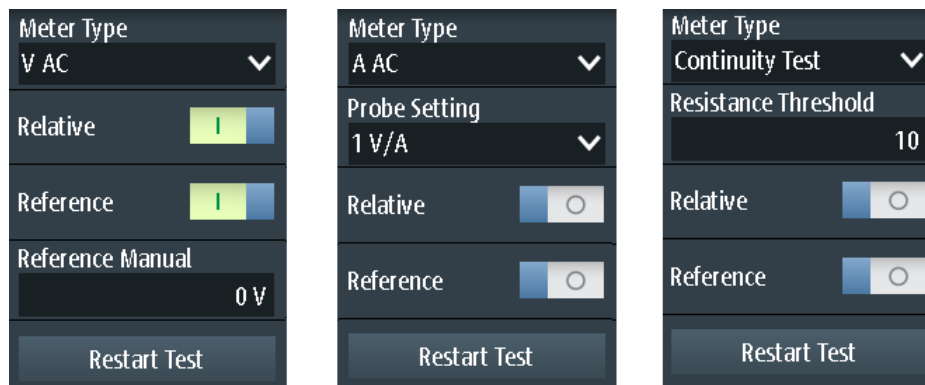

Figure 5-2: Digital multimeter settings

Meter Type

Sets the measurement type for the multimeter.

Meter icon	"Meter Type"	Description
	"V AC"	AC voltage measurement
	"V DC"	DC voltage measurement
	"V AC+DC"	AC+DC voltage (RMS) measurement
	"A AC"	AC current measurement

Meter icon	"Meter Type"	Description
	"A DC"	DC current measurement
	"A AC+DC"	AC+DC current (RMS) measurement
	"Resistance"	Resistance measurement
	"Continuity Test"	Continuity measurement
	"Diode Test"	Diode measurement
	"Capacitance"	Capacity measurement
	"Temperature"	Temperature measurement (an adapter is required)
	"Frequency"	Frequency measurement

Remote command:

`METer<m>:SENSe:FUNction` on page 263

Resistance Threshold

This setting is only relevant for continuity measurement. If the measured voltage drops below the "Resistance Threshold", the instrument beeps.

Probe Setting

Sets the sensitivity factor of the current probe for current measurements.

Sets the adapter type for temperature measurements.

Relative

Activates or deactivates relative measurement. If you activate this function, the currently measured value is taken as reference value. Instead of the bargraph, the reference value and the measured value are displayed. You can also set a desired value as reference value, see "[Reference / Reference Manual](#)" on page 111.

You can also activate or deactivate relative measurement by pressing DMM REL.



1 = Reference value

2 = Actual value relative to reference value

Remote command:

[Chapter 12.6.3, "Relative Measurements"](#), on page 248...

Reference / Reference Manual

"Reference" activates or deactivates the setting of a manual reference value.

If active, enter the reference value in "Reference Manual".

Restart Test

Restarts the measurement.

RANGE / POS

In meter mode, the vertical RANGE and POS keys adjust the DMM measurement range.

Remote command:

[Chapter 12.6.2, "Measurement Configuration"](#), on page 241

5.2 Voltmeter (R&S RTH1004)

The software-based voltmeter features AC, DC, AC+DC voltage measurements. Current measurements are also possible if you use a shunt resistor or I/U converter.

All remote commands for configuration and measuring are listed in [Chapter 12.7, "Voltmeter \(R&S RTH1004\)"](#), on page 257.

5.2.1 Accessing the Meter Mode

1. Press the MODE key.

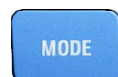

2. Select "Meter".

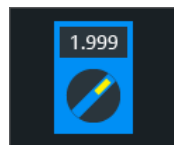

The multimeter interface is displayed.

5.2.2 Display and Control

The voltmeter display shows all 4 voltmeters at a glance, or only one voltmeter with details and setup icons.

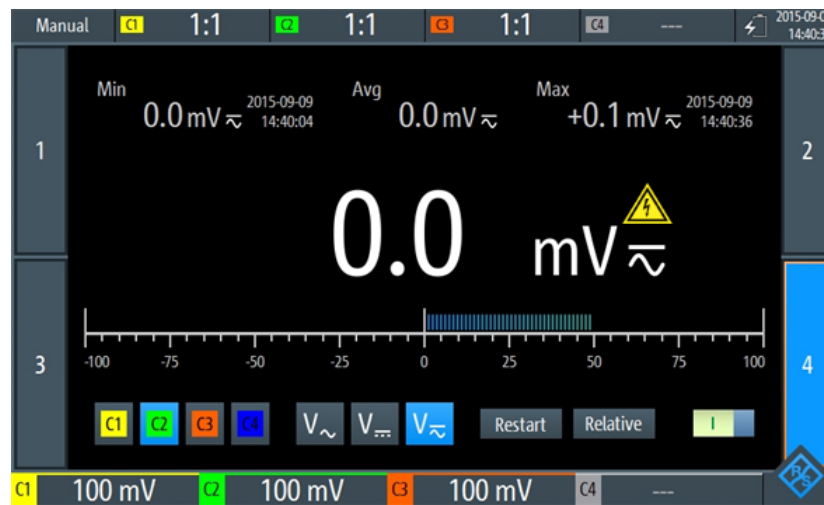

Figure 5-3: One-voltmeter-view

- 1 = Measurement state. "Manual": running measurement, manual range setup. "Hold": stopped measurement.
- 2 = Probe settings
- 3 = Minimum value and timestamp
- 4 = Average value
- 5 = Maximum value and timestamp
- 6 = Warning sign, shows up if the measured value is higher than 30 V
- 7 = Bargraph displaying the measured value
- 8 = Measurement source (input channel). Selected source is highlighted.
- 9 = Measurement ranges of active channels
- 10 = Measurement type (AC, DC or AC+DC). Selected type is highlighted.
- 11 = Restarts the measurement and resets all values
- 12 = Activates or deactivates relative measurement
- 13 = On/Off-Switch to turn selected meter on or off
- 14 = Displayed voltmeter, indicated by highlighted number

The buttons at the bottom of the display offer the following quick settings:

- [Input Signal](#)
- [Measure Type](#)
- [Restart Test](#)
- [Relative](#)

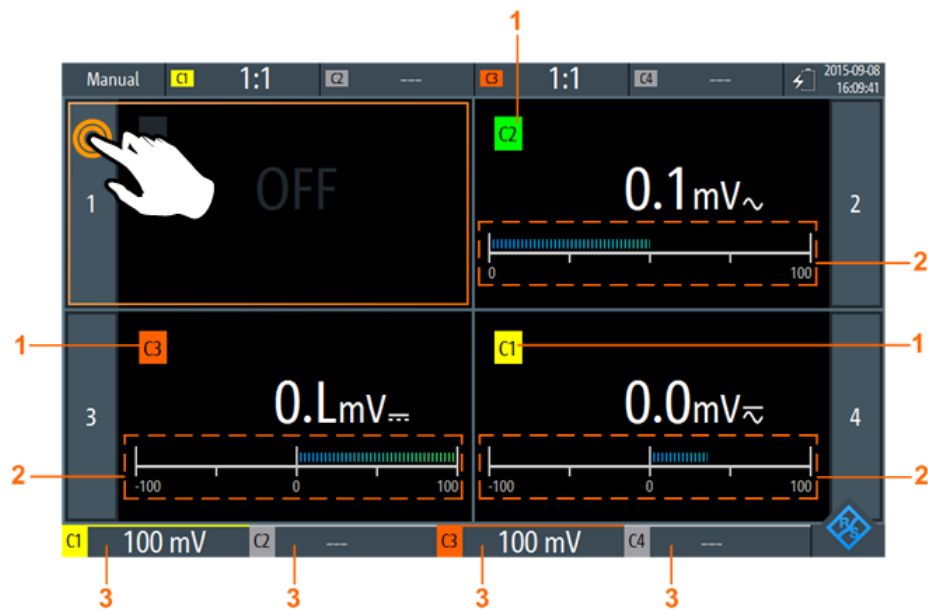



Figure 5-4: Four-voltmeter-view

- 1 = Channel measured by the voltmeter
- 2 = Bargraph displaying the measured value
- 3 = Measurement ranges of active channels

In meter mode, the keys behave different from scope mode:

- The vertical RANGE and POS keys both adjust the measurement range of the selected channel.
- The MEAS key opens the "Meter" menu.
- The following keys work as usual: FILE, , , PRESET, MODE, BACK.
- All other keys do not work.



Displaying voltmeters

- ▶ To switch to one-voltmeter-view, use one of the following methods:
 - Tap the meter number as shown in [Figure 5-4](#).
 - Turn the wheel to select a voltmeter, and press the wheel button to open it.
- ▶ To view all 4 voltmeters, use one of the following methods:
 - Tap the highlighted number of the opened voltmeter as shown in [Figure 5-3](#).
 - Press BACK.

5.2.3 Running Voltmeter Measurements

1. Set up the channels for voltmeter measurements.
 - a) Select the "Vertical" menu.

- b) Adjust the "Probe Setting" for all measured channels.
See also "Probe Setting" on page 43.

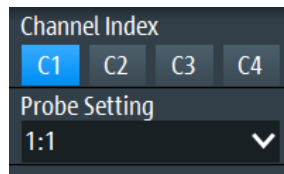

2. If the 4-voltmeter-view is shown, switch to the one-voltmeter-view.
See "Displaying voltmeters" on page 113.
3. Select the channel to be measured (no. 8 in Figure 5-3).
4. Select the measurement type (no. 10).



5. Activate the voltmeter (no. 13)
6. To adjust the measurement range manually, press the RANGE keys.
7. If you want to get relative result values:
 - a) Activate "Relative" (no. 12).
 - b) To set a user-defined reference value, open the "Meter" menu.
 - c) Activate "Reference", and enter the reference value in "Reference Manual".



8. To stop the meter measurement, press the RUN STOP key.

The status "Hold" is displayed on the upper left. Stopping the measurement does not delete statistical values. The measurement continues when you press RUN STOP again.

Alternatively, you can select the voltmeter and adjust the meter settings in the "Meter" menu.

5.2.4 Voltmeter Settings

Access: "Meter" menu

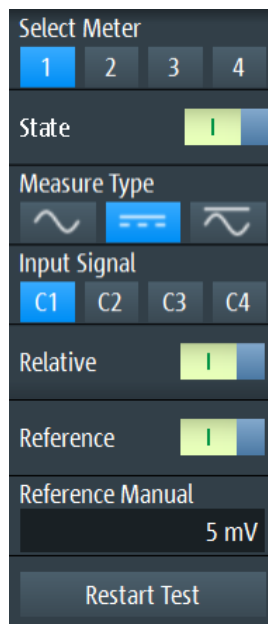

Figure 5-5: Voltmeter settings

Select Meter

Selects one of the 4 voltmeters and displays its settings in the menu.

State

Switches the selected meter on or off.

Remote command:

[METer<m>:SENSe:STATe](#) on page 257

Measure Type

Sets the measurement type for the selected meter.

Note: The AC coupling is activated if the selected channel is only used for AC measurements. If the selected channel is also used for DC or AC+DC measurement, the AC coupling is deactivated and the AC value is calculated out of the AC+DC and DC values. The precision of the results is reduced.

Menu icon	Meter icon	Description
		AC voltage or current measurement
		AC+DC voltage or current (RMS) measurement
		DC voltage or current measurement

Note: An external shunt resistor or I/U converter is needed for current measurement.

Remote command:

[METer<m>:SENSe:FUNctIon](#) on page 263

Input Signal

Selects the channel which is measured by the selected meter.

Remote command:

[METer<m>:SENSe:SOURce](#) on page 258

Relative

Activates or deactivates relative measurement. If you activate this function, the currently measured value is taken as reference value. Instead of the bargraph, the reference value and the measured value are displayed (see [Figure 5-6](#)). You can also set a desired value as reference value, see "[Reference / Reference Manual](#)" on page 116.

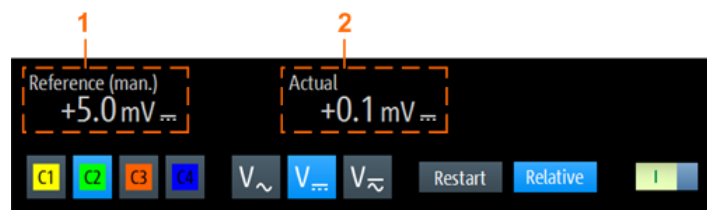

Figure 5-6: Relative measurement

1 = Reference value

2 = Measured value relative to reference value

Remote command:

[Chapter 12.7.3, "Relative Measurements"](#), on page 261

Reference / Reference Manual

"Reference" activates or deactivates the manual reference value.

If active, enter the reference value in "Reference Manual".

Restart Test

Restarts the measurement and also restarts statistical calculation.

RANGE / POS

In meter mode, the vertical RANGE and POS keys adjust the measurement range of the selected channel.

Remote command:

[Chapter 12.7.2, "Measurement Configuration"](#), on page 257

6 Data Logging

The data logger records scope or meter data captured of up to 4 different measurements. The logging can last up to 23 days. The records are displayed as an on-screen-chart and can be stored in 10 different slots. Using the "Zoom" and "Cursor" functions, logged data can be analyzed.

6.1 Accessing the Logger Mode

1. Press the MODE key.

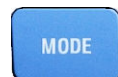

2. Select "Logger".



The logger interface is displayed.

If a scope measurement or meter measurement is running, the logging is started automatically when you enter the logger mode.

6.2 Logger Display

If you log data of scope measurements, you can log all active measurements at once. The logger display shows all logs with latest results at a glance, or one log with latest and statistical results.

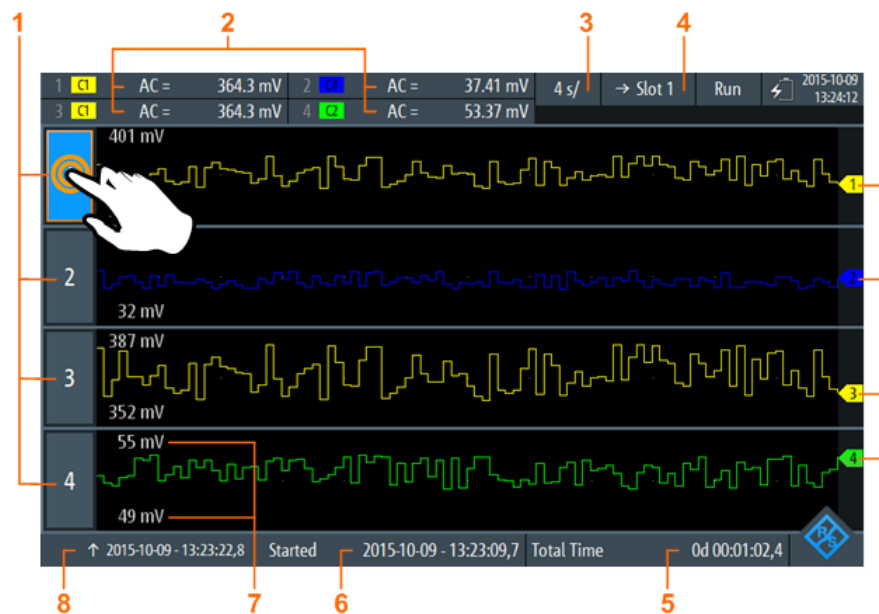

Figure 6-1: Logger display, view of all logged scope measurements

- 1 = Logged measurements
- 2 = Latest values of the logged measurements (depends on logging type and measurement type)
- 3 = Time basis
- 4 = Memory slot
- 5 = Recording time
- 6 = Start time
- 7 = Upper and lower scaling value of each measurement
- 8 = Time stamp of the left side of the display

Displaying logged measurements



1. To switch to one-log-view, use one of the following methods:
 - Tap on one of the logged measurements as shown in [Figure 6-1](#).
 - Press the assigned CH key.
2. To view all logs, use one of the following methods:
 - Tap the highlighted number of the opened log.
 - Press the CH key of the opened log.

6.3 Logging Data

You can log up to four different scope measurements or meter measurements simultaneously.

Before you start the logging, set up and activate the measurements that you want to log. See:

- [Chapter 3.2, "Automatic Measurements"](#), on page 79
- [Chapter 5, "Multimeter Measurements"](#), on page 107

1. Access the logger mode, see [Chapter 6.1, "Accessing the Logger Mode"](#), on page 117.
2. Select the "Logger" menu.
3. If data logging is running, press RUN/STOP to stop the logging. The logged data is stored automatically. You can only adjust the logger settings if logging is stopped.
4. Select the source that you want to log.
5. Select the sample rate.
6. Select the horizontal scale.
By default, the horizontal scale is set to "auto". In this case, all logged data are always displayed, and the scaling is adjusted automatically when the amount of data increases..
7. Select the slot, where the logged data will be stored.
8. To start logging, press the RUN STOP key.



When you stop logging, the logged data is stored automatically in the selected slot. Each slot stores the data of a single logging period. If you use the slot a second time, the stored data is overwritten.

6.4 Logger Settings

Access: "Logger" menu

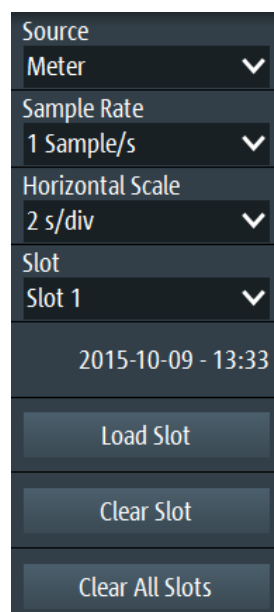

Source

Selects the logger source: "Scope" or "Meter".

Changing the source is only possible in stop mode.

Remote command:

[LOGGer : SOURce](#) on page 269

Sample Rate

Selects the number of log samples per second.

Changing the sample rate is only possible in stop mode.

Remote command:

[LOGGer : TIMebase : SRATe](#) on page 269

Horizontal Scale

Selects the horizontal scale of the logged data.

The horizontal scale is set to "auto" by default. In this case, all logged data is always displayed.

Remote command:

[LOGGer : TIMebase : SCALE](#) on page 269

Slot

Selects one of the 10 memory slots for storing the logged data.

If data is stored in a slot, the start time of the stored data is displayed in the menu. You can change the slot during recording.

Remote command:

[LOGGer : SLOT : CURRent](#) on page 269

Load Slot

Loads the stored log data of the selected slot.

Only possible while logging is stopped.

Remote command:

[LOGGer : SLOT : LOAD](#) on page 269

Clear Slot

Deletes the log data of the selected slot.

Only possible while logging is stopped.

Remote command:

[LOGGer : SLOT : CLear](#) on page 270

Clear All Slots

Deletes the log data of all slots.

Only possible while logging is stopped.

Remote command:

[LOGGer : ACLR](#) on page 270

6.5 Analyzing Logged Data

You can analyze logged data using the "Cursor" and the "Zoom". To analyze logged data at a later time, the data is stored automatically, and you can load the stored data to the display.

6.5.1 Cursor

To analyze logged data, you can use cursor measurements, see also [Chapter 3.3, "Cursor Measurements"](#), on page 85.

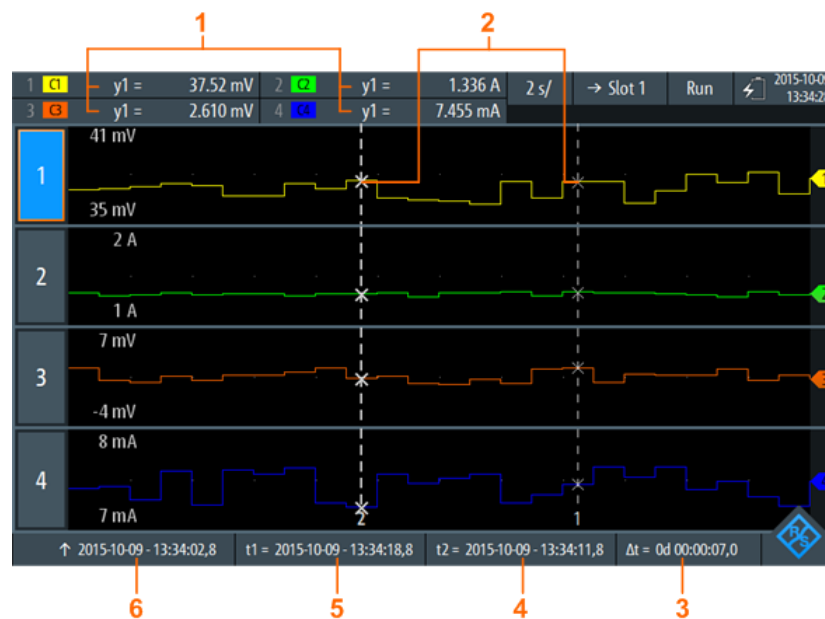

Figure 6-2: Logger display with cursors

- 1 = Values of the crossings between the selected cursor line and the waveform
- 2 = Cursor lines
- 3 = Absolute value of the time difference between the cursor lines $\Delta t = |t1-t2|$
- 4 = Position of the cursor line 2
- 5 = Position of the cursor line 1
- 6 = Time stamp of the logged signal on the left side of the display



To select one of the two cursor lines, tap a cursor line, or use the wheel to navigate and select. The selected line is highlighted by a bold line.

Remote commands for cursor results:

- `LOGGer:CURSor<m>:POSItion` on page 271
- `LOGGer:CURSor:TDELta?` on page 272
- `LOGGer:CURSor<m>:RESUlt<n>[:AMPLitude]?` on page 272



The logger cursor only allows you to set a "Cursor Value". You cannot define the cursor "Type" and "Source" as you can in the "Scope" and "Mask" mode because these settings are not relevant for logging.



Description of settings

Access: "Cursor" menu

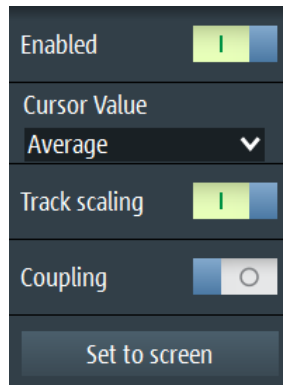

Figure 6-3: Cursor settings

Enable

Enables or disables the cursor measurement.

Remote command:

[LOGGer:CURSor<m>:STATe](#) on page 270

Cursor Value

Sets the measured crossing point between the cursor lines and the waveform, see [Figure 6-4](#). These settings only apply if data logging is running for more than 2 days and 7 hours. After this time, the logger compresses 4 logging values into a "Minimum", "Average" and "Maximum" value.

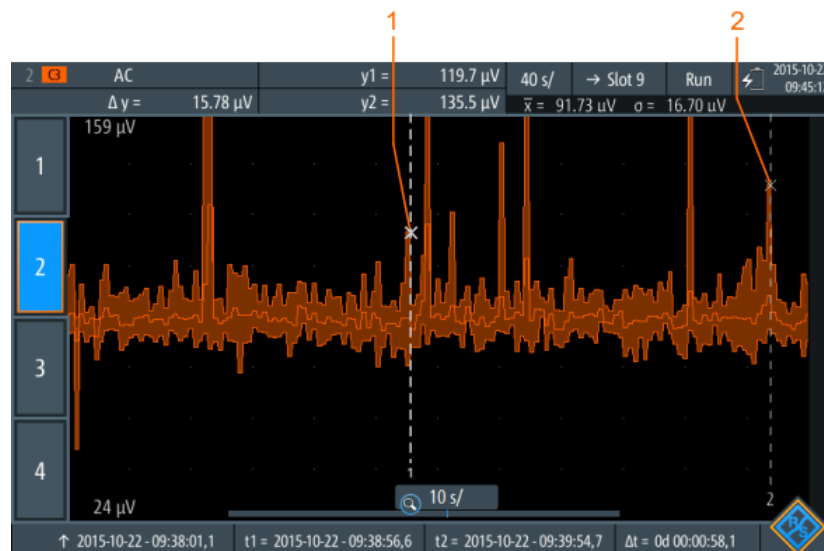

Figure 6-4: Logger cursor with summarized data

1 = Maximum value of cursor line 1
 2 = Maximum value of cursor line 2

Remote command:

[LOGGer:CURSor<m>:TYPE](#) on page 270

Track scaling

If enabled, the position of the cursor lines is adjusted if the scale is changed. The cursor lines keep their relative position to the waveform.

If disabled, the cursor lines remain on their position on the display if the scaling is changed.

Remote command:

[LOGGer:CURSor<m>:SCPLing](#) on page 271

Coupling

Couples the cursor lines so that the distance between the two lines remains the same if one cursor is moved.

Remote command:

[LOGGer:CURSor<m>:COUPLing](#) on page 271

Set to screen

Sets the cursors to a default position on the screen. This is helpful if the cursors have disappeared from the display or need to be moved for a larger distance.

Remote command:

[LOGGer:CURSor<m>:SCReen](#) on page 271

6.5.2 Zoom

To analyze logged data, you can use the "Zoom" function, see also [Chapter 3.1, "Zoom"](#), on page 77.



The zoom is only available if enough data have been logged.

The zoom settings in logger mode are the same as in scope mode, but the time range is much longer.

If data logging is running for more than 2 days and 7 hours, the logger compresses 4 logging values into a minimum, average and maximum value, see [Figure 6-5](#).

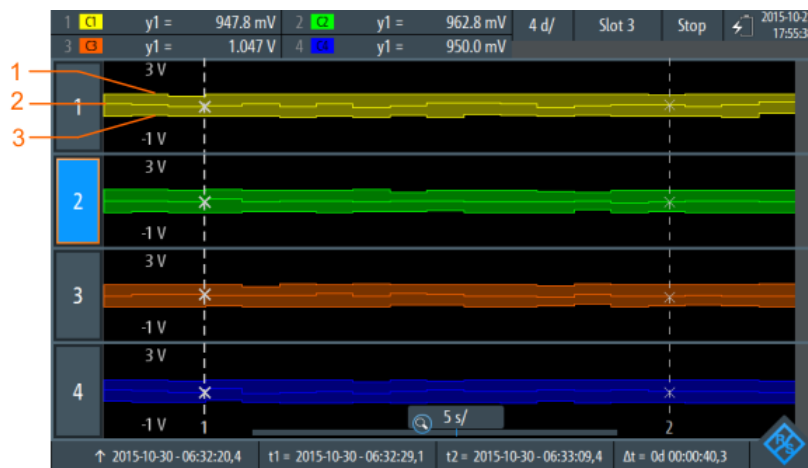

Figure 6-5: Logger zoom with summarized data

1 = Maximum values

2 = Average values

3 = Minimum values



Description of settings

Access: "Zoom" menu

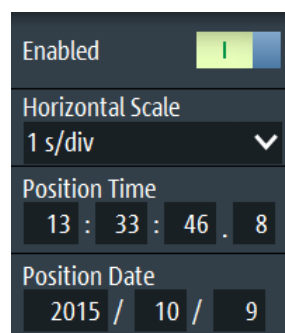

Figure 6-6: Zoom settings

Enable

Turns the zoom on or off.

Remote command:

[LOGGer: ZOOM: ENABLE](#) on page 273

Horizontal Scale

Sets the horizontal scale of the horizontal axis for all logged signals, in seconds per division.

Remote command:

[LOGGer:ZOOM:SCALe](#) on page 273

Position / Position Date

Sets the position of the zoomed area in relation to the left side of the display.

Remote command:

[LOGGer:ZOOM:POSition](#) on page 273

6.5.3 Logger Statistics

Figure 6-7: Logger statistics

1 = Measurement results; display depends on the logger mode and the selected measurement

2 = Mean value statistic

3 = Standard deviation statistic

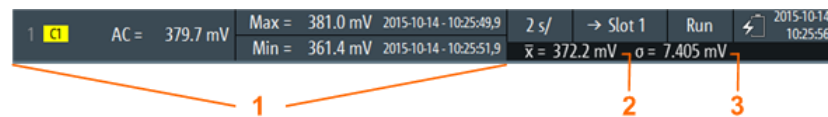

Statistics are only shown if a single log is displayed.

Remote commands for logger statistics:

- [LOGGer:RECORDing:START?](#) on page 273
- [LOGGer:RECORDing:TOTAL?](#) on page 274
- [LOGGer:MEASurement<m>:RESult:CURRentsampl?](#) on page 274
- [LOGGer:MEASurement<m>:RESult:MAXimum:POSition?](#) on page 274
- [LOGGer:MEASurement<m>:RESult:MAXimum:VALue?](#) on page 274
- [LOGGer:MEASurement<m>:RESult:MINimum:POSition?](#) on page 275
- [LOGGer:MEASurement<m>:RESult:MINimum:VALue?](#) on page 275
- [LOGGer:MEASurement<m>:RESult:MEAN?](#) on page 275
- [LOGGer:MEASurement<m>:RESult:STDDev?](#) on page 275
- [LOGGer:MEASurement<m>:ENABLEd?](#) on page 276
- [LOGGer:MEASurement<m>:TYPE?](#) on page 276
- [LOGGer:MEASurement<m>:SOURce?](#) on page 276

6.5.4 Loading Logged Data

Logged data can be loaded from the slot, in which they were stored.

1. Access the logger mode, see [Chapter 6.1, "Accessing the Logger Mode"](#), on page 117.
2. Select the "Logger" menu.
3. If a data logging is running, press RUN STOP to stop logging.
4. Select the slot with the logs that you want to display.
5. Tap "Load Slot" to display the stored logs.

6.5.5 Deleting Logged Data

Logs stored on the slots can be deleted individually or all together.

To delete logs of a single slot:

1. Select the slot with the logs which you want to delete.
2. Tap "Clear Slot".

To delete logs on all slots:

- ▶ Tap "Clear All Slots".

6.5.6 Exporting Logged Data

You can save the logger records to a CSV or MAT file for further analysis. See [Chapter 9.5, "Logger Records"](#), on page 169.

7 Protocol Analysis

Using the R&S RTH and additional options, you can analyze the following serial protocols:

- Serial Peripheral Interface (SPI) - requires option R&S RTH-K1
- Inter-Integrated circuit bus (I²C) - requires option R&S RTH-K1
- UART / RS-232 / RS-422 / RS-485 interfaces - require option R&S RTH-K2

The analysis of serial data consists of three main steps:

- Protocol configuration: Select the protocol type, and configure the input line as well as the protocol-specific settings.
- Decoding: Select the display format of the decoded data. The digitized signal data is displayed on the screen together with the decoded content of the messages. You can scale the signal display and zoom into it to see it in more detail.
- Triggering: You can trigger on various events that are typical for the configured bus type, for example, on start and stop of messages, or on data patterns.

Analysis is performed on analog input channels, and - if MSO option R&S RTH-B1 is installed - also on digital channels.

7.1 General Protocol Settings

Access: "Bus" menu

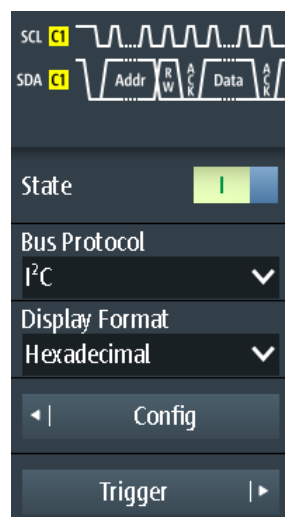

For all serial protocols, the following settings are required:

State

Enables the decoding and the display of the serial bus data.

Remote command:

[BUS \[:STATe\]](#) on page 277

Bus Protocol

Defines protocol type of the bus for configuration and trigger settings.

Remote command:

`BUS:TYPE` on page 277

Display Format

Sets the decoding format of the data: binary, hexadecimal, decimal, octal, or ASCII.

Remote command:

`BUS:FORMat` on page 277

7.2 I2C (Option R&S RTH-K1)

7.2.1 The I²C Protocol

This chapter provides an overview of protocol characteristics, data format, address types and trigger possibilities. For detailed information, read the "I2C-bus specification and user manual" available on the NXP manuals web page at <http://www.nxp.com/>.

I²C characteristics

Main characteristics of I²C are:

- Two-wire design: serial clock (SCL) and serial data (SDA) lines
- Master-slave communication: the master generates the clock and addresses the slaves. Slaves receive the address and the clock. Both master and slaves can transmit and receive data.
- Addressing scheme: each slave device is addressable by a unique address. Multiple slave devices can be linked together and can be addressed by the same master.
- Read/write bit: specifies if the master will read (=1) or write (=0) the data.
- Acknowledge: takes place after every byte. The receiver of the address or data sends the acknowledge bit to the transmitter.

The R&S RTH supports all operating speed modes: high-speed, fast mode plus, fast mode, and standard mode.

Data transfer

The format of a simple I²C message (frame) with 7 bit addressing consists of the following parts:

- Start condition: a falling slope on SDA while SCL is high
- 7-bit address of the slave device that either will be written to or read from
- R/W bit: specifies if the data will be written to or read from the slave
- ACKnowledge bits: is issued by the receiver of the previous byte if the transfer was successful

Exception: At read access, the master terminates the data transmission with a NACK bit after the last byte.

- Data: a number of data bytes with an ACK bit after every byte
- Stop condition: a rising slope on SDA while SCL is high

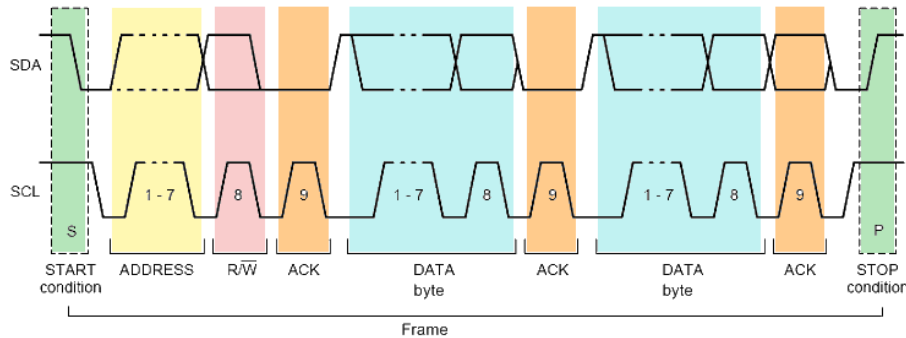

Figure 7-1: I2C write access with 7-bit address

Address types: 7-bit and 10-bit

Slave addresses can be 7 or 10 bits long. A 7-bit address requires one byte, 7 bits for the address followed by the R/W bit.

A 10-bit address for write access requires two bytes: the first byte starts with the reserved sequence 11110, followed by the two MSB of the address and the write bit. The second byte contains the remaining 8 LSB of the address. The slave acknowledges each address byte.

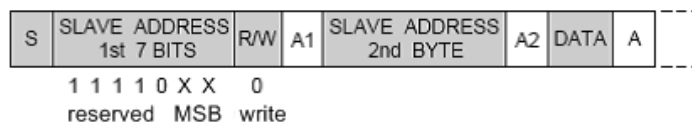

Figure 7-2: 10-bit address, write access

A 10-bit address for read access requires three bytes. The first two bytes are identical to the write access address. The third byte repeats the address bits of the first byte and sets the read bit.

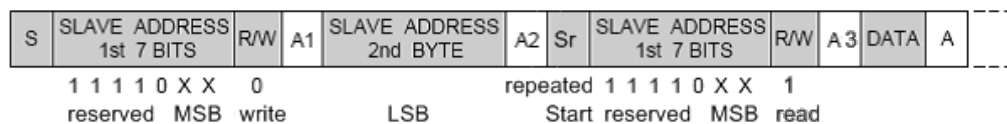

Figure 7-3: 10-bit address, read access

Trigger

The R&S RTH can trigger on various parts of I2C messages. The data and clock lines must be connected to the input channels, triggering on math and reference waveforms is not possible.

You can trigger on:

- Start or stop condition
- Repeated start condition
- Transfer direction (read or write)
- Bytes with missing acknowledge bit
- Specific slave address
- Specific data pattern in the message

7.2.2 I2C Configuration Settings

Access: "Bus" menu > "Bus Protocol" = "I2C" > "Config"

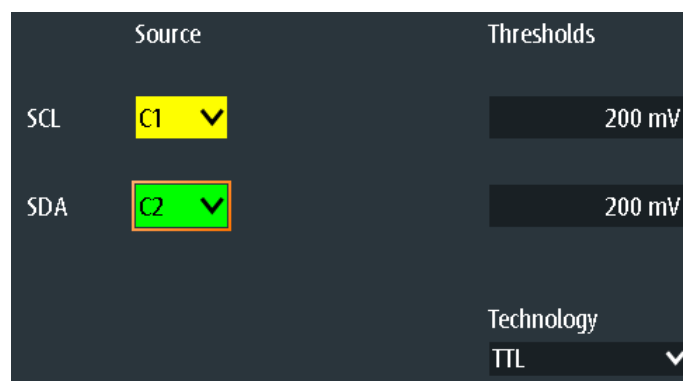

SCL / SDA

Set the input source of the data line (SDA) and clock line (SCL).

If option R&S RTH-B1 is installed, digital channels can also be used as source.

Remote command:

[BUS:I2C:SCL:SOURce](#) on page 278

[BUS:I2C:SDA:SOURce](#) on page 278

Thresholds / Technology

Sets the threshold value for digitization of signals. If the signal value is higher than the threshold, the signal state is high. Otherwise, the signal state is considered low.

You can select the threshold voltages for various types of integrated circuits in the "Technology" list, or set a user-defined value in "Thresholds".

Remote command:

[BUS:I2C:TECHnology](#) on page 278

[BUS:I2C:SCL:THReshold](#) on page 278

[BUS:I2C:SDA:THReshold](#) on page 278

7.2.3 I2C Trigger Settings

Access: "Bus" menu > "Bus Protocol" = "I2C" > "Trigger"



I2C Trigger

Selects the trigger type for I²C analysis.

- "Start" Sets the trigger to the start of the message. The start condition is a falling edge on SDA while SCL is high. The trigger instant is the falling edge of the SDA line.
- "Restart" Sets the trigger to a restart - when the start condition occurs without previous stop condition. Restart conditions occur when a master exchanges multiple messages with a slave without releasing the bus.
- "Stop" Sets the trigger to the end of the message. The stop condition is a rising slope on SDA while SCL is high.
- "No Ack (Missing Ack)" Missing acknowledge bit: the instrument triggers if the data line remains HIGH during the clock pulse following a transmitted byte. You can also localize specific missing acknowledge bits by setting the [No Ack \(Missing Ack\)](#) bits.
- "Address" Sets the trigger to one specific address pattern that is expected. The trigger time is the falling clock edge of the acknowledge bit after the address.
- "Data" Sets the trigger to a specified data pattern that is expected.
- "Address and Data" Sets the trigger to a combination of address and data condition.

Remote command:

[TRIGger: I2C:MODE](#) on page 279

No Ack (Missing Ack)

Selects which missing acknowledge bits is detected if the trigger type is set to "No Ack (Missing Ack)".

"Address NACK"

No slave recognizes the address.

"Data Read NACK"

Marks the end of the read process when the master reads data from the slave. This Nack is sent according to the protocol definition, it is not an error.

"Data Write NACK"

The addressed slave does not accept the written data.

Remote command:

[TRIGger:I2C:ADNack](#) on page 279

[TRIGger:I2C:DRNack](#) on page 279

[TRIGger:I2C:DWNack](#) on page 279

Address Pattern

Specifies the address pattern to be found, in binary or hex format. Enter the pattern in MSB first bit order.

See also [Chapter 2.5.12.1, "Pattern Definition"](#), on page 70.

Remote command:

[TRIGger:I2C:ADDRess](#) on page 280

Address Relation

Defines how the specified serial address pattern is compared with the acquired signal. The instrument triggers if the acquired address is equal or unequal the defined pattern.

Remote command:

[TRIGger:I2C:ACONdition](#) on page 280

R/W Bit

Toggles the trigger condition between read and write access of the master. Select "Either" if the transfer direction is not relevant for the trigger condition.

Remote command:

[TRIGger:I2C:ACCess](#) on page 280

Data Pattern

Specifies the data pattern to be found on the specified line, in binary or hex format. Enter the words in MSB first bit order.

See also [Chapter 2.5.12.1, "Pattern Definition"](#), on page 70.

Remote command:

[TRIGger:I2C:DATA](#) on page 280

Data Relation

Sets how the defined serial data pattern is compared with the acquired signal. The instrument triggers if the acquired data pattern is equal or unequal the defined pattern.

Remote command:

[TRIGger:I2C:DCONdition](#) on page 280

Byte Offset

Sets the number of bytes before the first byte of the data pattern. These bytes are ignored.

Remote command:

[TRIGger:I2C:DPOsition](#) on page 281

7.3 SPI (Option R&S RTH-K1)

7.3.1 The SPI Protocol

A 4-channel instrument is required for full support of the SPI protocol.

The Serial Peripheral Interface SPI is used for communication with slow peripheral devices, in particular, for transmission of data streams.

Main characteristics of SPI are:

- Master-slave communication
- No device addressing; The slave is accessed by a chip select, or slave select line.
- No acknowledgement mechanism to confirm receipt of data
- Duplex capability

Most SPI buses have four lines, two data and two control lines:

- Clock line to all slaves (SCLK)
- Slave Select or Chip Select line (SS or CS)
- Master data output, slave data input (MOSI or SDI)
- Master data input, slave data output (MISO or SDO)

When the master generates a clock and selects a slave device, data may be transferred in either or both directions simultaneously.

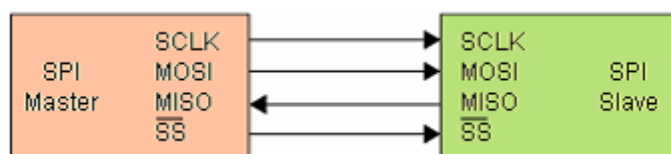

Figure 7-4: Simple configuration of SPI bus

The data bits of a message are grouped by following criteria:

- A word contains a number of successive bits. The word length is defined in the protocol configuration.
- A frame contains a number of successive words, at least one word.

For SPI buses, the R&S RTH provides the following trigger possibilities:

- On frame start
- On frame end

- On a serial pattern at a specified position

7.3.2 SPI Configuration Settings

Access: "Bus" menu > "Bus Protocol" = "SPI" > "Config"

	Source		Thresholds
CS	C1	Polarity Active high	200 mV
Clock	C2	Slope Rising	200 mV
MOSI	C3		200 mV
MISO	C4		200 mV
Word Length	8 bit	Bit Order MSB First	Technology TTL
Frame Timeout	1 ms		

Back

Source : CS / Clock / MOSI / MISO

Set the input channels of the SPI lines.

If option R&S RTH-B1 is installed, digital channels can also be used as source.

Remote command:

[BUS:SPI:SSEL:SOURce](#) on page 281

[BUS:SPI:SCLK:SOURce](#) on page 281

[BUS:SPI:MISO:SOURce](#) on page 281

[BUS:SPI:MOSI:SOURce](#) on page 281

Polarity

Selects whether the chip select signal is high active (high = 1) or low active (low = 1).

Remote command:

[BUS:SPI:SSEL:POLarity](#) on page 282

Slope

Selects if data are sampled on the rising or falling slope of the clock. The clock slope marks the begin of a new bit.

Remote command:

[BUS:SPI:SCLK:SLOPe](#) on page 282

Thresholds / Technology

Sets the threshold value for digitization of signals. If the signal value is higher than the threshold, the signal state is high. Otherwise, the signal state is considered low.

You can select the threshold voltage on all lines for various types of integrated circuits in the "Technology" list, or set a user-defined value for each line in "Thresholds".

Remote command:

[BUS:SPI:TECHnology](#) on page 282

[BUS:SPI:SSEL:THReshold](#) on page 282

[BUS:SPI:SCLK:THReshold](#) on page 282

[BUS:SPI:MISO:THReshold](#) on page 282

[BUS:SPI:MOSI:THReshold](#) on page 282

Word Length

Sets the number of bits in a word. The maximum length is 32 bit.

Remote command:

[BUS:SPI:WSize](#) on page 283

Bit Order

Defines if the data of the words starts with MSB (most significant bit) or LSB (least significant bit). The display of the decoded signal considers this setting, results are displayed in the specified order.

Remote command:

[BUS:SPI:ORDeR](#) on page 283

Frame Timeout

Sets the minimum idle time between two data frames. If the time interval between the data frames is shorter, the words are part of the same frame. Within the timeout, the data and clock lines are low. A new frame begins when the timeout has expired.

Timeout is only relevant if the bus has no chip select.

Remote command:

[BUS:SPI:TIMEout](#) on page 283

7.3.3 SPI Trigger Settings

Access: "Bus" menu > "Bus Protocol" = "SPI" > "Trigger"



SPI Trigger

Selects the trigger type for SPI analysis.

- "Frame Start" Sets the trigger to the start of the message. If the bus has a CS line, the frame starts when the chip select signal changes to the active state. Without CS line, the frame starts when the idle time has expired.
- "Frame End" Sets the trigger to the end of the message. If the bus has a CS line, the frame ends when the chip select signal changes to the inactive state. Without CS line, the frame ends when the idle time has expired after the last clock and no new clock appeared during that time.
- "Data" Sets the trigger to a specified bit pattern that is expected on one of the lines.

Remote command:

[TRIGger:SPI:MODE](#) on page 283

Datasource

Selects the line, on which the trigger pattern is expected.

Remote command:

[TRIGger:SPI:DSRC](#) on page 284

Pattern

Specifies the data pattern to be found on the specified line, in binary or hex format. Enter the words in MSB first bit order.

See also [Chapter 2.5.12.1, "Pattern Definition"](#), on page 70.

Remote command:

[TRIGger:SPI:DATA](#) on page 284

Relation

Defines how the defined serial data pattern is compared with the acquired signal. The instrument triggers if the acquired data word is equal or unequal the defined pattern.

Remote command:

[TRIGger:SPI:DCONdition](#) on page 284

Bit Offset

Sets the number of bits before the first bit of the pattern. These bits are ignored. The first bit after CS or timeout is bit 0. For example, with bit offset = 2, bit 0 and bit 1 after CS are ignored, and the pattern starts with bit 2.

Remote command:

[TRIGger:SPI:DPOSition](#) on page 285

Chip Select

Defines if the SPI bus uses a chip select line or not.

Remote command:

[BUS:SPI:SSEL:STATe](#) on page 284

7.4 UART/RS-232/RS-422/RS-485 (Option R&S RTH-K2)

7.4.1 The UART Interface

The Universal Asynchronous Receiver/Transmitter UART converts words of data into serial data, and vice versa. It is the base of many serial protocols like of RS-232 and RS-422. The UART uses only one line, or two lines for transmitter and receiver. The R&S RTH can analyze one UART line.

Data transfer

The data is transmitted in words, also referred to as symbols or characters. Each word consists of a start bit, several data bits, an optional parity bit, and one or more stop bits. Several words can form a frame, or package. The end of a frame is marked by a pause between two symbols.



Figure 7-5: Bit order in a UART word (symbol)

- The start bit is a logic 0.
- The stop bits and the idle state are always logic 1.

The UART protocol has no clock for synchronization. The receiver synchronizes by means of the start and stop bits, and the bit rate that must be known to the receiver.

Trigger

The R&S RTH can trigger on specified parts of UART serial signals:

- Start bit of a word
- Frame start
- Data pattern
- Parity error
- Stop error
- Break

7.4.2 UART Configuration Settings

Access: "Bus" menu > "Bus Protocol" = "UART" > "Config"

Source	C1	Polarity	Idle High	Threshold	200 mV
				Technology	TTL
Bit Rate	9600	Predefined Bit Rates	9.6 kbps		
Data Bits	8 bit	Parity	Odd	Stop Bits	1 bit
Bit Order	MSB First	Frame Mode	Idle Time	Idle Time	33.333336 ms

Source

Selects the input channel to which the UART line is connected.

If option R&S RTH-B1 is installed, digital channels can also be used as source.

Remote command:

[BUS:UART:SOURce](#) on page 285

Polarity

Defines the logic states of the line. In idle high state, the idle state corresponds to a logic 1, and the start bit to a logic 0. In idle low state, the idle state corresponds to a logic 0, and the start bit to a logic 1. During idle time, no data is transmitted.

Remote command:

[BUS:UART:POLarity](#) on page 285

Threshold / Technology

Sets the threshold value for digitization of signals. If the signal value is higher than the threshold, the signal state is high. Otherwise, the signal state is considered low. The interpretation of high and low is defined by the [Polarity](#).

You can select the threshold voltages for various types of integrated circuits in the "Technology" list, or set a user-defined value in "Threshold".

Remote command:

[BUS:UART:TECHnology](#) on page 286

[BUS:UART:THReshold](#) on page 286

Predefined Bit Rates / Bit Rate

Set the number of transmitted bits per second.

You can select a predefined value in the "Predefined Bit Rates" list, or set a user-defined value in "Bit Rate".

Remote command:

[BUS:UART:STDBitrate](#) on page 286

[BUS:UART:BITRate](#) on page 286

Data Bits

Sets the number of data bits in a word (symbol) in a range from 5 bits to 9 bits.

Remote command:

[BUS:UART:SSIZe](#) on page 287

Parity

Defines the optional parity bit that is used for error detection.

"None" No parity bit is used.

"Odd" The parity bit is set to "1" if the number of data bits set to "1" is even.

"Even" The parity bit is set to "1" if the number of data bits set to "1" is odd.

Remote command:

[BUS:UART:PARity](#) on page 287

Stop Bits

Sets the number of stop bits: 1 or 1.5 or 2 stop bits are possible.

Remote command:

[BUS:UART:SBIT](#) on page 287

Bit Order

Defines if a word starts with MSB (most significant bit) or LSB (least significant bit). The display of the decoded signal considers this setting, results are displayed in the specified order.

Remote command:

[BUS:UART:ORDer](#) on page 287

Frame Mode

Allows to decode frames of several words in the data stream, which are defined by a timeout between a stop bit and the next start bit. Enter the minimum timeout between two frames in "Idle Time".

Remote command:

[BUS:UART:FRAMemode](#) on page 288

[BUS:UART:TOUT](#) on page 288

7.4.3 UART Trigger Settings

Access: "Bus" menu > "Bus Protocol" = "UART" > "Trigger"

UART Trigger

Selects the trigger type for UART analysis.

"Start Bit"	Triggers on a start bit. The start bit is the first low bit after a stop bit if polarity is idle high.
"Frame Start"	Triggers on the begin of a data frame. The frame start is configured with BUS:UART:FRAMemode .
"Data"	Triggers on a serial pattern or data word. You can define the Pattern and Relation .
"Parity Error"	Triggers on a parity error, which indicates a transmission error. This trigger type is only available if a parity is configured for the UART bus.
"Stop Error"	Triggers if the stop bit is a logic 0.
"Break Condition"	Triggers if a start bit is not followed by a stop bit, and the data line remains at logic 0 for longer than a UART word.

Remote command:

[TRIGger:UART:TYPE](#) on page 288

Pattern

Specifies the data pattern to be found on the specified trigger source, in binary or hex format. Enter the words in MSB first bit order.

See also [Chapter 2.5.12.1, "Pattern Definition"](#), on page 70.

Remote command:

[TRIGger:UART:DATA](#) on page 288

Relation

Defines how the defined serial data pattern is compared with the acquired signal. The instrument triggers if the acquired data word is equal or unequal the defined pattern.

Remote command:

[TRIGger:UART:DCondition](#) on page 289

7.5 CAN (Option R&S RTH-K3)

CAN is the Controller Area Network, a bus system used within automotive network architecture.

7.5.1 CAN Configuration Settings

Access: "Bus" menu > "Bus Protocol" = "CAN" > "Config"

The screenshot shows the CAN Configuration Settings interface. It includes the following fields and controls:

- Source:** A dropdown menu set to "C1".
- Polarity:** A dropdown menu set to "CAN_L".
- Threshold:** A text input field set to "2 V".
- Technology:** A dropdown menu set to "CAN".
- Bit Rate:** A text input field set to "50 kbps".
- Predefined Bit Rates:** A dropdown menu set to "50 kbps".
- Sample Point:** A text input field set to "50 %".

Source

Sets the input channel of the CAN line.

Remote command:

[BUS:CAN:DATA:SOURce](#) on page 289

Polarity

Selects whether the chip select signal is high active (high = 1) or low active (low = 1).

Remote command:

[BUS:CAN:TYPE](#) on page 291

Threshold / Technology

Sets the threshold value for digitization of signals. If the signal value is higher than the threshold, the signal state is high. Otherwise, the signal state is considered low.

You can select the threshold voltage on the source CANe for various types of integrated circuits in the "Technology" list, or set a user-defined value in "Threshold".

Remote command:

[BUS:CAN:TECHnology](#) on page 291

[BUS:CAN:DATA:THReshold](#) on page 290

Bit rate / Predefined Bit Rates

Sets the number of transmitted bits per second. The maximum bit rate is 20 kbit/s.

To select a bit rate from the list of predefined values, tap the "Predefined Bit Rates" field, then select the value.

To set a user-defined value, double-tap the "Bit Rate" field, then enter the value and unit using the displayed keypad. The "Predefined Bit Rates" setting is automatically set to "User Bit Rate".

Remote command:

[BUS:CAN:BITRate](#) on page 289

Sample Point

The CAN bus interface uses an asynchronous transmission scheme. The standard specifies a set of rules to resynchronize the local clock of a CAN node to the message.

The sample point divides the nominal bit period into two distinct time segments. The length of the time segments is defined in time quanta according to network and node conditions during CAN development.

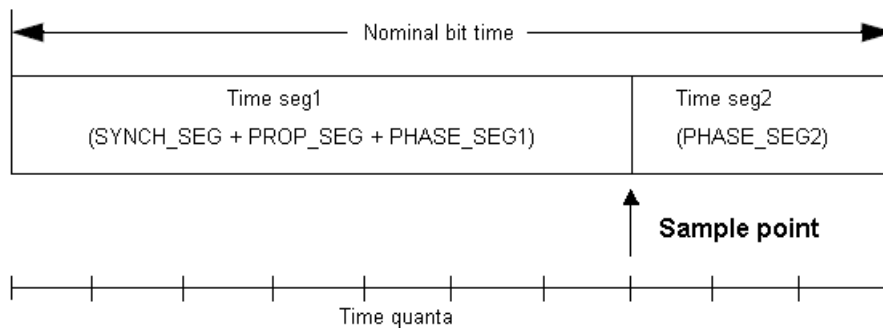

Remote command:

[BUS:CAN:SAMPlepoint](#) on page 290

7.5.2 CAN Trigger Settings

Access: SETUP (Trigger) > "Trigger type" = "Bus"

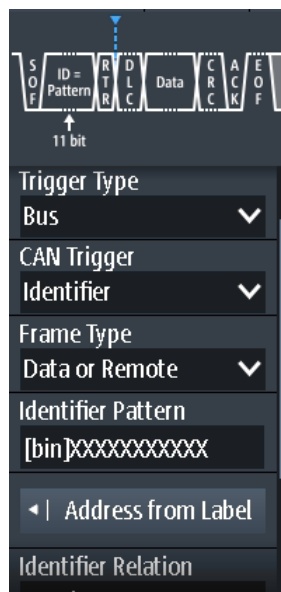

CAN Trigger.....	143
Frame type.....	144
ID type.....	144
Identifier Pattern.....	144
Identifier Relation.....	145
Data Pattern.....	145
Data Relation.....	145
Address from Label.....	145
Error conditions: CRC, Bit stuffing, Form, Ack.....	145

CAN Trigger

Depending on the selected CAN trigger type, different additional parameters are available.

"Start of Frame"

Triggers on the stop bit of the sync field.

"End of frame"

Triggers after a wakeup frame.

"Frame type"

Triggers on a specified frame type (data, remote, error, or overload). For data and remote frames, also the identifier format is considered.

"Identifier"

Sets the trigger to a specific identifier or an identifier range. Only the 6-bit identifier without parity bits is considered, not the protected identifier.

"Identifier + Data"

Sets the trigger to a combination of identifier and data condition. The instrument triggers at the end of the last byte of the specified data pattern.

"Error condition"

Identifies various errors in the frame. You can select one or more error types as the trigger condition.

Remote command:

[TRIGger:CAN:TYPE](#) on page 294

Frame type

CAN has several frame types which can be used as trigger condition.

For data and remote frames, the identifier format has to be set with [ID type](#).

"Error"	When a node recognizes an error, it cancels transmission by sending an error frame. The instrument triggers seven bit-periods after the end of the error flag that is marked by a dominant-recessive edge. The ID type is irrelevant for error frames.
"Overload"	When a node needs a delay between data and/or remote frames, it sends an overload frame. The instrument triggers seven bit-periods after the end of the overload flag that is marked by a dominant-recessive edge. The ID type is irrelevant for overload frames.
"Data"	The data frame is the only frame for actual data transmission.
"Remote"	Remote frames are only available in the CAN protocol. The remote frame initiates the transmission of data by another node. The frame format is the same as of data frames but without the data field.
"Data or Remote"	Data frames or remote frames initiate the transmission of data by another node. The frame format is the same as of data frames.

Remote command:

[TRIGger:CAN:FTYPE](#) on page 293

ID type

Selects the length of the identifier:

"11 bit"	Identifier length of the CAN base frame format. The instrument triggers on the sample point of the IDE bit (identifier extension flag).
"29 bit"	Identifier length of the CAN extended frame format. The instrument triggers on the sample point of the RTR bit.
"Any"	The ID type and ID pattern are not relevant for the trigger condition. If the trigger type is "Identifier", the instrument triggers on any identifier in the specified frame type. If the trigger type is "Identifier + Data", set the "ID type" to "Any" if you want to trigger only on data.

Remote command:

[TRIGger:CAN:ITYPE](#) on page 294

Identifier Pattern

Specifies the identifier pattern to be found, in binary or hex format. Enter the pattern in MSB first bit order.

See also [Chapter 2.5.12.1, "Pattern Definition"](#), on page 70.

Remote command:

[TRIGger:CAN:IDENTifier](#) on page 293

Identifier Relation

Defines how the specified identifier pattern is compared with the acquired signal. The instrument triggers if the acquired address is equal or unequal the defined pattern.

Remote command:

[TRIGger:LIN:ICONdition](#) on page 298

Data Pattern

Specifies the data pattern to be found, in binary or hex format. Enter the pattern in MSB first bit order.

See also [Chapter 2.5.12.1, "Pattern Definition"](#), on page 70.

Remote command:

[TRIGger:LIN:DATA](#) on page 297

Data Relation

Defines how the specified data pattern is compared with the acquired signal. The instrument triggers if the acquired address is equal or unequal the defined pattern.

Remote command:

[TRIGger:LIN:DCondition](#) on page 298

Address from Label

If a label list with node names was loaded and applied in the bus configuration, you can simply select the node name from the list instead of entering the numeric identifier.

The instrument triggers on the identifier of the selected node.

Error conditions: CRC, Bit stuffing, Form, Ack

If a CAN detects a bit stuffing error, form error, or ack error, it transmits an error flag at the next bit. The R&S RTH detects errors in the message and triggers on these errors even if no CAN node sends an error flag.

- CRC error
CAN uses the Cyclic Redundancy Check, which is a complex checksum calculation method. The transmitter calculates the CRC and sends the result in the CRC sequence. The receiver calculates the CRC in the same way. A CRC error occurs when the calculated result differs from the received value in the CRC sequence.
- Bit stuffing error
The frame segments Start Of Frame, Arbitration Field, Control Field, Data Field and CRC Sequence are coded by the bit stuffing method. The transmitter automatically inserts a complementary bit into the bit stream when it detects five consecutive bits of identical value in the bit stream to be transmitted. A stuff error occurs when the 6th consecutive equal bit level in the mentioned fields is detected.
- Form error
A form error occurs when a fixed-form bit field contains one or more illegal bits.
- Ack error
An acknowledgement error occurs when the transmitter does not receive an acknowledgment - a dominant bit during the Ack Slot.

Remote command:

[TRIGger:CAN:ACKerror](#) on page 292

[TRIGger:CAN:BITSterror](#) on page 292

[TRIGger:CAN:CRCError](#) on page 292

[TRIGger:CAN:FORMerror](#) on page 292

7.6 LIN (Option R&S RTH-K3)

The Local Interconnect Network (LIN) is a simple, low-cost bus system used within automotive network architectures. LIN is usually a sub-network of a CAN bus. The primary purpose of LIN is to integrate uncritical sensors and actuators with low bandwidth requirements. Common applications in a motor vehicle are the control of doors, windows, wing mirrors, and wipers.

7.6.1 The LIN Protocol

This chapter provides an overview of protocol characteristics, frame format, identifiers and trigger possibilities. For detailed information, order the LIN specification on <http://www.lin-subbus.org/> (free of charge).

LIN characteristics

Main characteristics of LIN are:

- Single-wire serial communications protocol, based on the UART byte-word interface
- Single master, multiple slaves - usually up to 12 nodes
- Master-controlled communication: master coordinates communication with the LIN schedule and sends identifier to the slaves
- Synchronization mechanism for clock recovery by slave nodes without crystal or ceramics resonator

The R&S RTH supports several versions of the LIN standard: v1.3, v2.0, v2.1 and the American SAE J2602.

Data transfer

Basic communication concept of LIN:

- Communication in an active LIN network is always initiated by the master.
- Master sends a message header including the synchronization break, the synchronization byte, and the message identifier.
- The identified node sends the message response: one to eight data bytes and one checksum byte.
- Header and response form the message frame.

The data is transmitted in bytes using the UART byte-word interface without the parity bit. Each byte consists of a start bit, 8 bits and a stop bit.

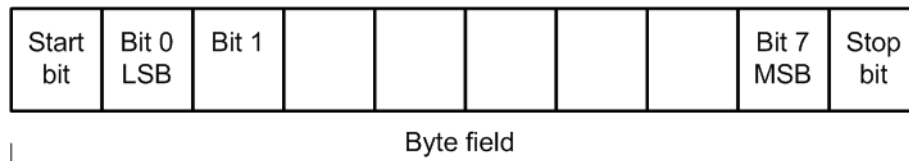

Figure 7-6: Structure of a byte field

Data bytes are transmitted LSB first.

The identifier byte consists of 6 bits for the frame identifier and two parity bits. This combination is known as protected identifier.

Trigger

The R&S RTH can trigger on various parts of LIN frames. The data line must be connected to an input channel, triggering on math and reference waveforms is not possible.

You can trigger on:

- Frame start (synchronization field)
- Specific slave identifier or identifier range
- Data pattern in the message
- Wake up signal
- Checksum error (error in data), parity error (error in identifier)

7.6.2 LIN Configuration Settings

Access: PROTOCOL > "Bus type" = "LIN" > "Configuration"

Source **C1** ▼ Polarity **Idle High** ▼ Threshold **1.4 V**

Technology **User** ▼

Bit Rate **9.6 kbps** Predefined Bit Rates **9.6 kbps** ▼

Standard **Auto** ▼

Back

Source.....	148
Polarity.....	148
Standard.....	149
Bit rate / Predefined Bit Rates.....	149
Threshold / Technology.....	149

Source

Sets the source of the data line. All channel waveforms can be used.

Remote command:

[BUS:LIN:DATA:SOURce](#) on page 296

Polarity

Defines the idle state of the bus. The idle state is the recessive state and corresponds to a logical 1.

"Idle Low" The bus is idle (state = 1) when the signal is low

"Idle High" The bus is idle (state = 1) when the signal is high

Remote command:

[BUS:LIN:POLarity](#) on page 296

Standard

Selects the version of the LIN standard that is used in the DUT. The setting mainly defines the checksum version used during decoding.

The most common version is v2.x. For mixed networks, or if the standard is unknown, set the LIN standard to "Auto".

Remote command:

[BUS:LIN:STANdard](#) on page 296

Bit rate / Predefined Bit Rates

Sets the number of transmitted bits per second. The maximum bit rate is 20 kbit/s.

To select a bit rate from the list of predefined values, tap the "Predefined Bit Rates" field, then select the value.

To set a user-defined value, double-tap the "Bit Rate" field, then enter the value and unit using the displayed keypad. The "Predefined Bit Rates" setting is automatically set to "User Bit Rate".

Remote command:

[BUS:LIN:BITRate](#) on page 295

Threshold / Technology

Sets the threshold value for digitization of signals. If the signal value is higher than the threshold, the signal state is high. Otherwise, the signal state is considered low.

You can select the threshold voltages for various technologies in the "Technology" list, or set a user-defined value in "Threshold".

Remote command:

[BUS:LIN:TECHnology](#) on page 297

[BUS:LIN:DATA:THReshold](#) on page 296

7.6.3 LIN Trigger Settings

Access: SETUP (Trigger) > "Trigger type" = "Bus"

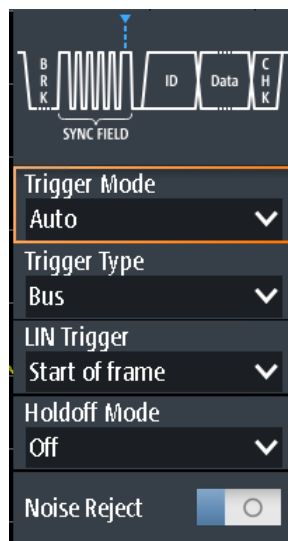

LIN Trigger.....	150
Checksum Error.....	151
Parity Error.....	151
Sync Error.....	151
Identifier Pattern.....	151
Identifier Relation.....	151
Address from Label.....	151
Data Pattern.....	151
Data Relation.....	151

LIN Trigger

Depending on the selected LIN trigger type, different additional parameters are available.

"Start of Frame"

Triggers on the stop bit of the sync field.

"Wakeup frame"

Triggers after a wakeup frame.

"Error condition"

Identifies various errors in the frame. You can select one or more error types as the trigger condition.

"Identifier"

Sets the trigger to a specific identifier or an identifier range. Only the 6-bit identifier without parity bits is considered, not the protected identifier.

"Identifier + Data"

Sets the trigger to a combination of identifier and data condition. The instrument triggers at the end of the last byte of the specified data pattern.

Remote command:

`TRIGger:LIN:TYPE` on page 299

Checksum Error

Triggers on a checksum error. The checksum verifies the correct data transmission. It is the last byte of the frame response. The checksum includes not only the data but also the protected identifier (PID).

Remote command:

[TRIGger:LIN:CHKSError](#) on page 297

Parity Error

Triggers on a parity error. Parity bits are the bits 6 and 7 of the identifier. They verify the correct transmission of the identifier.

Remote command:

[TRIGger:LIN:IPERror](#) on page 298

Sync Error

Triggers if synchronization caused an error.

Remote command:

[TRIGger:LIN:SYERror](#) on page 299

Identifier Pattern

Specifies the identifier pattern to be found, in binary or hex format. Enter the pattern in MSB first bit order.

See also [Chapter 2.5.12.1, "Pattern Definition"](#), on page 70.

Remote command:

[TRIGger:LIN:IDENTifier](#) on page 298

Identifier Relation

Defines how the specified identifier pattern is compared with the acquired signal. The instrument triggers if the acquired address is equal or unequal the defined pattern.

Remote command:

[TRIGger:LIN:ICONdition](#) on page 298

Address from Label

If a label list with node names was loaded and applied in the bus configuration, you can simply select the node name from the list instead of entering the numeric identifier.

The instrument triggers on the identifier of the selected node.

Data Pattern

Specifies the data pattern to be found, in binary or hex format. Enter the pattern in MSB first bit order.

See also [Chapter 2.5.12.1, "Pattern Definition"](#), on page 70.

Remote command:

[TRIGger:LIN:DATA](#) on page 297

Data Relation

Defines how the specified data pattern is compared with the acquired signal. The instrument triggers if the acquired address is equal or unequal the defined pattern.

Remote command:

[TRIGger:LIN:DCONdition](#) on page 298

8 Logic Analyzer (R&S RTH-B1 MSO)

The Mixed Signal Option R&S RTH-B1 adds logic analyzer functions to the classical oscilloscope functions. Using the logic analyzer, you can analyze and debug embedded systems with mixed-signal designs that use analog signals and time-correlated digital signals simultaneously. The option provides a logic probe with 8 logic channels. The instrument ensures that analog and digital waveforms are timealigned and synchronized so that critical timing interactions between analog and digital signals can be displayed and tested.

Each logic channel can be displayed on the screen and used as trigger source.

- ▶ To activate the logic analyzer, press the LOGIC key.
To disable, press LOGIC again.
- ▶ To configure logic channels in the "Logic" menu, long-press the LOGIC key.

To scale and move the logic channels vertically:

1. If the logic channels are not focused, press the LOGIC key to set the focus.
2. Press the vertical RANGE and POS keys.

8.1 Logic Analyzer Settings

Access: "Logic" menu

**Logic Channels**

Enables or disables the logic channels.

Remote command:

[LOGic:STATE](#) on page 299

Visible

By default, all 8 logic channels are displayed. Disable the logic channels that you do not need for analysis.

Couple Thresh.

Couples the threshold and hysteresis settings for the logic channels.

If enabled, all logic channels use the same threshold and hysteresis settings.

If disabled, 2 channel groups are available, which can use different threshold and hysteresis settings: D0 - D3, and D4 - D7.

Remote command:

[LOGic:THCoupling](#) on page 300

Threshold

Sets the threshold value for the selected channel group, or for all logic channels. For each acquired sample, the instrument compares the input voltage with the threshold value. If the input voltage is above the threshold, the signal state "1" is stored. Otherwise, the signal state "0" is stored if the input voltage is below the threshold.

You can set the digital threshold in several ways:

- The same threshold and hysteresis are used for all logic channels: Enable "Threshold" and set the values for channels D0 - D3, and D4 - D7.
- Different thresholds and hysteresis are used for individual channel groups: Disable "Threshold" and set the threshold and hysteresis for each group.

You can select the threshold voltages for various types of integrated circuits in the list, or set a user-defined value.

"TTL"	1.4 V
"ECL"	-1.3 V
"CMOS"	2.5 V
"GND"	0 V (for CAN channels, requires option R&S RTH-K3)
"CAN"	2 V (for CAN channels, requires option R&S RTH-K3)
"7 V Supply"	7 V (for LIN channels, requires option R&S RTH-K3)
"12 V Supply"	12 V (for LIN channels, requires option R&S RTH-K3)
"18 V Supply"	18 V (for LIN channels, requires option R&S RTH-K3)

Remote command:

[LOGic:GROup<m>:TECHnology](#) on page 300

[LOGic:GROup<m>:USER](#) on page 301

Hysteresis

Hysteresis avoids the change of signal states due to noise oscillation around the threshold level. Set a small hysteresis for clean signals, and large hysteresis for noisy signals.

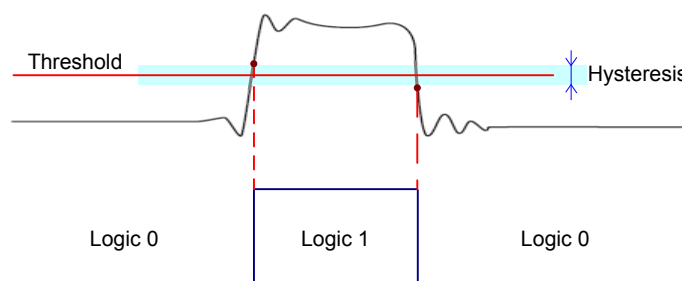

Remote command:

[LOGic:GROup<m>:HYSTeresis](#) on page 301

Deskew

Enables deskewing.

Deskew compensates delays that are known from the circuit specifics or caused by the different length of cables. The skew between the probe boxes of the digital channels and the probe connectors of the analog channels is automatically aligned by the instrument.

Select Channel / Deskew

You can set the deskew for all channels of a logic probe at once, or for each logic channel separately.

Select the channel and enter the deskew value in "Deskew".

Remote command:

`LOGic:CHANnel<m>:DESKew` on page 302

Set all Deskews to Zero

Resets all deskew values to zero.

8.2 Triggering on Logic Channels

Each digital channel can be used as trigger source. Using the pattern trigger, you can trigger on logical combinations of analog and digital channels. Additionally, you can define a trigger holdoff time.

If you trigger on logic channels, the threshold is used as trigger level. The "Trigger Level" setting is not available.

The following trigger types are available if the trigger source is a logic channel:

- Edge
- Glitch
- Width
- Pattern: the pattern can use all active logic channels
- State: the pattern can use all active logic channels
- Data2Clock: only the clock can be a logic channel.
- Serial pattern: clock and data source can be logic channels.
- Timeout
- Interval
- Window

All trigger types except for edge, glitch and width require option R&S RTH-K19.

For analysis of serial protocols, you configure the protocol using logic channels as sources, and trigger on trigger type "Bus". For details, see the chapter describing the relevant bus.

8.3 Analyzing Logic Channels

The main analysis tools for logic channels are serial protocol analysis (BUS), and the pattern and state triggers.

Furthermore, you can zoom into the display (ZOOM).

To measure logic channels, you can use automatic and cursor measurements as usual. the following measurement types are available:

- Period
- Frequency

- Positive and negative pulse width
- Positive and negative duty cycle
- Delay (only automatic measurements)
- Phase (only automatic measurements)
- Mean
- Positive and negative pulse count
- Rising and falling edge count

See also [Chapter 3.2, "Automatic Measurements"](#), on page 79 and [Chapter 3.3, "Cursor Measurements"](#), on page 85.

You can also export the waveform data: FILE > "Waveforms"

9 Documenting Results

The R&S RTH can store various data to files for further analysis and reporting:

- [Instrument Settings](#)
- [Waveforms](#)
- [Screenshots](#)
- [Logger Records](#)

You can also combine these data and save it to file by pressing the  key: [Quick Save with OneTouch](#).

To check the storage devices and manage the data files, the [Filesystem Tools](#) menu provides various functions.

- ▶ To access export and data functions, press the FILE key.

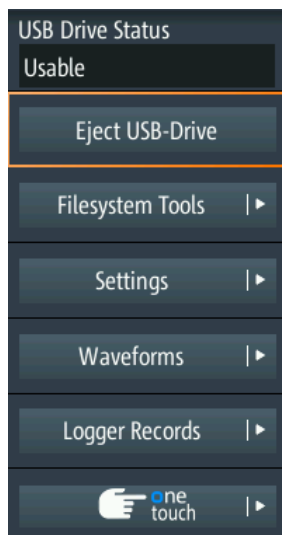

9.1 Using USB Flash Drive

You can connect a USB flash drive on the right side of the instrument. If a USB flash drive is connected, all screenshots and result data are written to this external device by default. Instrument settings are saved on the instrument, but you can store them to the USB flash drive as well.

1. To check the status of the USB flash drive, press the FILE key.
The connection status is shown on the top of the menu.



2. To remove the USB flash drive from the instrument, tap "Eject USB Drive" in the "File" menu.
3. To check the file system on the USB flash drive for errors, tap "Filesystem Tools" > "Check USB Drive".

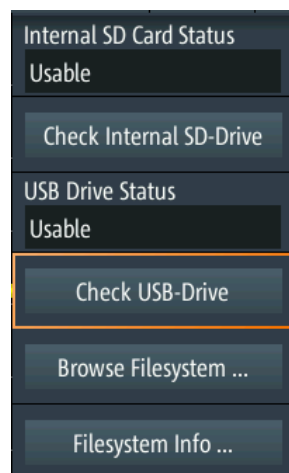

9.2 Instrument Settings

To repeat measurements or tests at different times or perform similar measurements with different test data, you can save the used configuration settings for later use. Furthermore, it can be helpful to refer to the configuration settings of a particular measurement when analyzing the results. Therefore, you can easily save the complete measurement configuration including the display settings.

The R&S RTH provides two ways to store the measurement configuration:

- Save as fast setting
- Save as saveset

9.2.1 Using Fast Settings

The R&S RTH has 8 slots to save and load often used configuration settings very quickly.

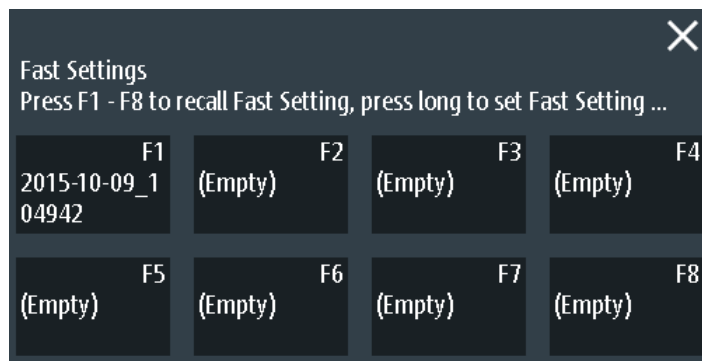

To save the current setting as fast setting

1. Press the SHIFT key.
2. Tap and hold one of the storage slots F1...F8.
The online keyboard opens.
3. Type the settings name and tap ↵.
The configuration settings are saved to the slot.

To load a fast setting

1. Press the SHIFT key.
2. Tap the storage slot that holds the required configuration.
The settings are loaded.

Alternatively, you can save and load fast settings in the "File" menu: FILE > "Settings" > "Fast Settings".

9.2.2 Saving and Loading Savesets

You can save and reload an unlimited number of configuration setups. By default, the settings are stored on the microSD card in the following directory:

```
media/SD/Rohde-Schwarz/RTH/SaveSets
```

The storage location can be changed. The file format is XML.

To save the current settings in a saveset

1. Press the FILE key.
2. Tap "Settings".
3. The current storage location is shown in "Setting Directory".
 - To store the file under a default name in the specified directory, tap "Save Setting".

- To store the file in another directory and/or with a user-defined filename, tap "Save Setting As". Select the path, directory, and enter the filename.

To load and display a saveset

1. Press the FILE key.
2. Tap "Settings".
3. The current storage location is shown in "Setting Directory".
 - To load a file from the specified directory, tap "Load Setting".
 - To load a file from another directory, tap "Setting Directory" and change the directory.
Tap "Load Setting".
4. Select the file to be loaded.



Description of settings

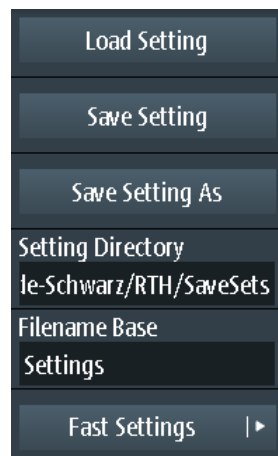

Load Setting

Opens the specified directory. Tap the file to be loaded.

Save Setting

Saves the settings to the specified directory with a default filename. The filename pattern is: <filename base>_<date>_<time>.xml.

Save Setting As

Opens a file selection dialog. Navigate to the target directory and enter the filename. Tap "Save" to store the file.

Setting Directory

Sets the directory to which the settings are stored with the "Save Setting" function.

Filename Base

Defines the first part of the filename. The complete filename pattern is: <filename base>_<date>_<time>.xml.

9.3 Waveforms

Analog channel and math waveforms can be saved in several ways:

- As reference waveforms for later use on the instrument: "Ref" menu. See: [Chapter 3.5, "Reference Waveforms"](#), on page 91
- In CSV file on a USB flash drive or internal SD card for further analysis using other applications: FILE > "Waveforms". This way is described in the current chapter.

If you want to save many waveforms, you can assign the function to the  key. See: [Chapter 9.6, "Quick Save with OneTouch"](#), on page 169.

9.3.1 Exporting Waveforms to File

The waveform export provides the following possibilities:

- Store either one waveform or all active waveforms.
- Include time values.
- Option R&S RTH-K15: Save history data.
- Option R&S RTH-B1: Save logic channels.

If a USB flash drive is attached, the file is stored there. Otherwise, the file is stored in the `Export` folder on the microSD card.

1. Activate the waveforms that you want to export.
2. Press the FILE key.
3. Select "Waveforms".
4. Tap "Select Waveform" and select one waveform for export, or select all active waveforms.
5. Select the "File Format"
6. Check the "Waveform Directory", the "Filename Base", and the "CSV Column Delimiter". Adjust if necessary.
7. If you need time information for analysis, enable "Store with Time".
8. If you want to save history data, enable "Save History".
9. Tap "Save Waveform".

All export settings are described in [Chapter 9.3.2, "Waveform Export Settings"](#), on page 162.

9.3.2 Waveform Export Settings

Access: FILE > "Waveforms"



Select Waveform

Select the waveform to be exported. You can export:

- A single analog channel or math waveform
- All active digital channels
- All active waveforms at once

Save History

This function is only available if option R&S RTH-K15 is installed. It includes the waveform history in the data export. If acquisition is running, enabling "Save History" stops the acquisition. History data is always saved in "Compressed CSV" files.

File Format

Selects the format of the export file.

"CSV"	Comma-separated values (CSV) text file, the waveform is stored in a table. The columns are separated by commas or another delimiter. For each sample, one line is written. Values are listed in scientific notation. You can convert the comma-separated text to columns.
"Compressed CSV"	ZIP file that contains one or more CSV files. This format reduces the file size.

Save Waveform / Save Waveform As

Save the waveform data. The functions are available if the instrument is in a waveform mode ("Scope", "XY", "Mask").

"Save Waveform"	Saves the file in the defined "Waveform Directory" using the auto-naming pattern.
"Save Waveform As"	Opens a file explorer where you can select the directory and enter the filename.

Waveform Directory

Defines the directory where the waveform files are stored. If a USB flash drive is connected, the instrument stores the data to this external device by default.

Filename Base

Defines the first part of the filename. The complete filename pattern is:

```
<filename base>_<date>_<time>.csv|zip.
```

Store with Time

Includes horizontal values in the export data (time values).

CSV Column Delimiter

Selects the column delimiter for CSV files. You need to know the delimiter when you convert the CSV text to columns in a spreadsheet.

9.3.3 Waveform Export Files

Waveform data is stored in CSV or compressed CSV format.

A CSV file is a comma-separated values (CSV) text file, the waveform is stored in a table. The columns are separated by commas or another delimiter. For each sample, one line is written. Values are listed in scientific notation. You can convert the comma-separated text to columns.

9.3.3.1 Content of Waveform Files

The first lines of the file contain header data, for example, time scale, vertical scale, vertical and horizontal positions. Header data is required to interpret the waveform data, and to analyze the data values of the data file.

Value	Description
Vertical Scale	In V/div or A/div, only for analog waveforms
Vertical Position	In divisions, only for analog channels
Vertical Offset	In V or A, only for analog channels
Threshold	Only for digital channels

9.3.3.3 Converting CSV to Excel Files

If you open an exported CSV file in Excel or another spreadsheet, all data is written in one column. The value delimiter is usually a comma, but you can select another delimiter in the export settings. As an example, the following procedure describes text conversion to columns in Excel. Other spreadsheet applications provide similar features. Make sure to select the correct text delimiter, decimal separator and thousands separator.

1. Open the CSV file in Excel.
2. Click the column header "A" to select all data.
3. On the "Data" ribbon, click "Text to Columns".
4. Select the data type "Delimited".
Click "Next".
5. Select the delimiter that you have used in the export file (usually a comma).
Click "Next".
6. Click "Advanced".
7. Select the point as decimal separator and the comma as thousands separator.

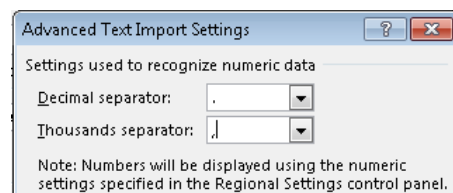



8. Click "Finish".

9.4 Screenshots

You can create and save screenshots of the current display of your waveforms and measurement results. If a USB flash device is connected to the R&S RTH, the instrument saves the screenshot to the USB flash device. Otherwise, the screenshots are saved on the microSD card.



To save the current display in a screenshot:

1. Press the FILE key.
 2. Disable "One touch".
 3. Press the  key.
- To configure the screenshots, long-press the  key, or open the "Screenshot" menu.

You can also view all saved screenshots directly on the instrument.

9.4.1 Screenshot Settings

Access: "Screenshot" menu

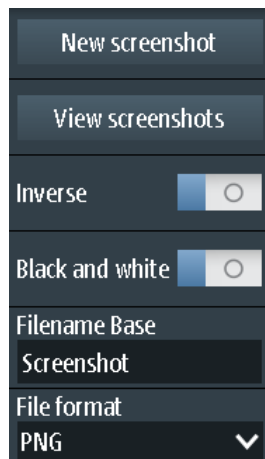

New screenshot

Saves the current display in a new screenshot.

Remote command:

[HCOPY:IMMEDIATE](#) on page 303

View screenshots

Displays the last saved screenshot. You can browse all screenshots that are saved.

Inverse

Inverts the colors of the output, i.e. a dark waveform is printed on a white background.

Remote command:

[HCOPY:INVERSE](#) on page 303

Black and White

Creates a black and white screenshot.

Remote command:

[HCOPY:COLOR](#) on page 303

Filename base

Defines the prefix of the file name. By default, the filename has the prefix "Screenshot_".

Remote command:

[MMEMoRY:NAME](#) on page 303

File format

Defines the format of the screenshot file. The following formats are available:

- PNG: Portable Network Graphics is a graphic format with lossless data compression.
- JPG: compressed file format, compression according to JPEG standard
- BMP: BitMaP is an uncompressed format, files are large and saving might take some time.
- TIFF: Tagged Image File Format, often used in publishing companies and print processing.

Remote command:

[HCOPY:LANGuage](#) on page 303

9.5 Logger Records

You can save the logger records to a CSV or MAT file for further analysis. Saving is only possible if the instrument is in "Logger" mode.

1. Press the FILE key.
2. Tap "Logger Records".
3. Tap "Export As".
4. Select the "File Type", enter the "File Name", and change the folder if necessary. If a USB flash drive is attached, the file is stored there. Otherwise, the file is stored in the `Export` folder on the microSD card.

9.6 Quick Save with OneTouch

The  key initiates one or more assigned saving actions. By default, the key saves a screenshot.

If OneTouch is enabled, you can assign the following actions to the  key:

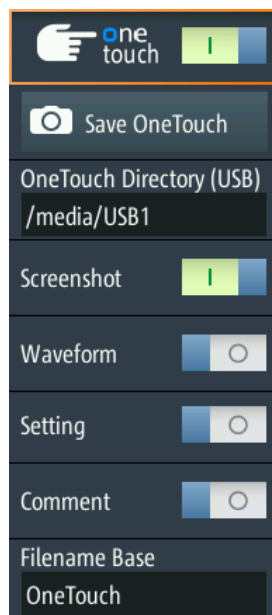

- Save a screenshot
- Save waveforms
- Save settings
- Add a comment to the saved file.

Access: FILE > "OneTouch", or "Screenshot" menu > "OneTouch"



One touch

Switches the function of the  key:

- If OneTouch is disabled, the  key saves a screenshot of the current display.
- If OneTouch is enabled, the  key can also save waveform data and settings in addition to the screenshot.

Save OneTouch

Saves the selected data to a ZIP file.

OneTouch Directory

Defines the directory where the OneTouch ZIP files are stored. If a USB flash drive is connected, the instrument stores the data to this external device by default.

Screenshot / Waveform / Setting

Select the data that you want to include in the OneTouch file.

Comment

If enabled, you can enter a comment when you save a OneTouch file. The comment is written to a text file, which is included in the ZIP file. Furthermore, the first 10 characters of the comment are added to the ZIP filename.

Filename Base

Defines the first part of the filename. The complete filename pattern is:

```
<filename base>_<date>_<time>_<comment10ch>.zip.
```

9.7 Filesystem Tools

Access: FILE > "Filesystem Tools"

The "Filesystem Tools" help you to check the storage devices and manage the data files.

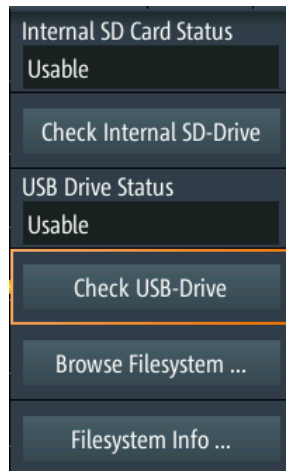

Internal SD Card Status

Shows the status of the internal SD card.

Check Internal SD Drive

Checks the file system on the SD card for errors.

USB Drive Status / Check USB Drive

See [Chapter 9.1, "Using USB Flash Drive"](#), on page 158.

Browse Filesystem

Opens a file explorer, where you can check the files on the SD card and on the USB flash drive. You can rename and delete files, and create folders. Some options help to navigate and select files.

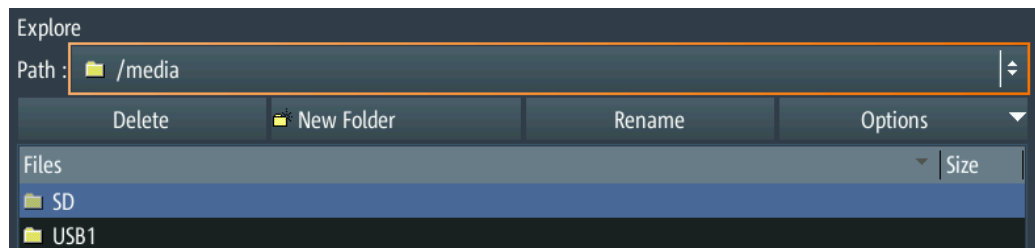

Filesystem Info

Shows the overall and free space that is available on the connected storage devices.

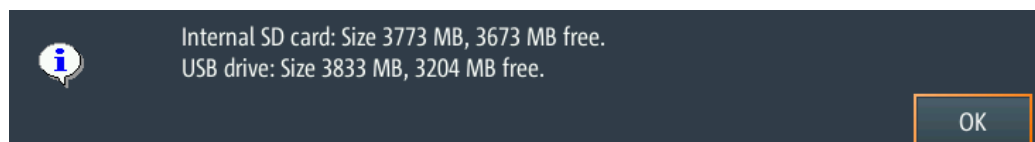

10 General Instrument Setup

The general instrument settings are available in all operating modes.

10.1 Resetting the Instrument

Reset is helpful if the instrument is in undefined condition and cannot be operated.

- ▶ To switch off the instrument and reset the hardware, press the  power key for 5 seconds.
- ▶ To restore the factory settings, hold down the PRESET key during the boot process.

10.2 Disabling the Touchscreen

If you use the instrument in an environment with immissions considerably higher than specified, the immissions can affect the touch sensitivity of the screen. In this case, operate the instrument using the keys and the wheel and disable the touchscreen.

- ▶ To disable the touchscreen, press the SHIFT key for 2 seconds.

10.3 Selfalignment

Access:  or "Setup" menu > "Selfalignment"

The self-alignment aligns the data from several input channels vertically and horizontally to synchronize the timebases, amplitudes and positions.

The R&S RTH1002 provides an additional, separate self-alignment of the meter inputs.

Recommendation on performing the self-alignment:

- When putting the instrument into operation for the first time
- After a firmware update
- Once a week
- When major temperature changes occur (> 5°)

NOTICE**Warm-up and prepare the instrument**

Make sure that the instrument has been running and warming up before you start the self-alignment. The minimum warm-up time is indicated in the data sheet.

Before the self-alignment, remove all probes, leads, and other connected lines from the instrument input.

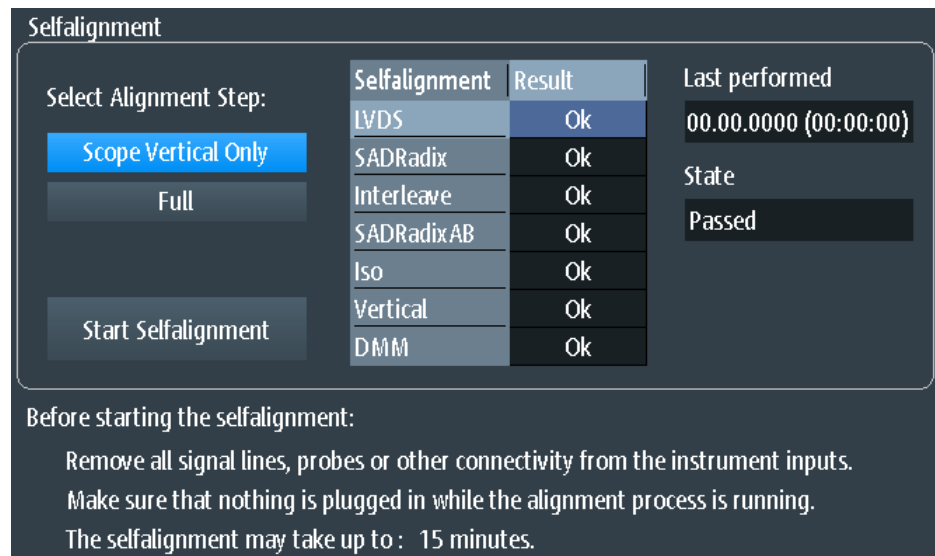

Figure 10-1: Self-alignment in scope mode

- To start, tap "Start Selfalignment".

The alignment can take up to 15 minutes. The results are shown in the "Selfalignment" dialog box.

R&S RTH1002: Self-alignment of DMM inputs

If the instrument is in "Meter" mode, you can choose to align all inputs, or only the meter inputs. The self-alignment of the meter inputs takes up to 30 seconds, while the complete self-alignment takes up to 15 minutes.

Selfalignment

Select Alignment Step:

DMM Only

Full

Start Selfalignment

Selfalignment	Result
LVDS	Ok
SADRadix	Ok
Interleave	Ok
SADRadixAB	Ok
Iso	Ok
Vertical	Ok
DMM	Ok

Last performed
00.00.0000 (00:00:00)

State
Passed

Before starting the selfalignment:
Remove all signal lines, probes or other connectivity from the instrument inputs.
Make sure that nothing is plugged in while the alignment process is running.
The selfalignment may take up to : 30 seconds.

10.4 Setting the Date, Time and Language

The instrument has a date and time clock. You can adjust the clock to the local time, and you can select the display language. Supported languages are listed in the data sheet. The help is provided in English.

A reboot of the instrument is not necessary.

Set date and time

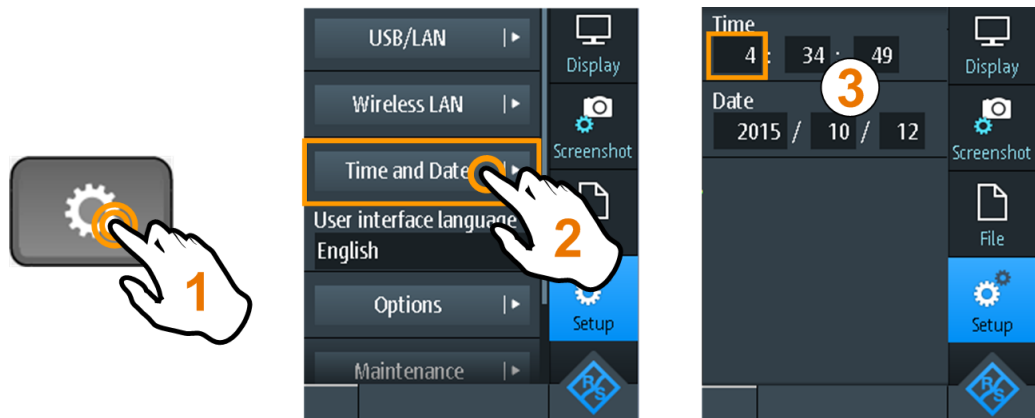

Set display language
 **Description of settings**
User Interface Language

Select the language in which the functions and messages are displayed. Supported languages are listed in the data sheet. The help is provided in English.

The instrument changes the language after a few seconds, a reboot is not required.

Time

Set the local time in the following order: hours / minutes / seconds.

Remote command:

[SYSTem:TIME](#) on page 305

Date

Set the date in the following order: year / month / day.

Remote command:

[SYSTem:DATE](#) on page 304

10.5 Instrument Settings

Access:  or "Setup" menu

**Enable Touch**

Switches the touch functionality of the screen on or off. Alternatively, you can press the SHIFT key for 2 seconds.

If you use the instrument in an environment with immissions considerably higher than specified, the immissions can affect the touch sensitivity of the screen. In this case, operate the instrument using the keys and the wheel and disable the touchscreen.

Remote command:

`DISPlay:MOUS` on page 306

Selfalignment

See [Chapter 10.3, "Selfalignment"](#), on page 172.

Selftest

The self-test checks the hardware of the instrument. It is intended for service tasks.

USB/LAN

See [Chapter 11.1, "LAN Connection"](#), on page 183 and [Chapter 11.2, "USB connection"](#), on page 185.

Wireless LAN

See [Chapter 11.3, "Wireless LAN Connection \(Option R&S RTH-K200/200US\)"](#), on page 185.

Time and Date

See [Chapter 10.4, "Setting the Date, Time and Language"](#), on page 174.

User Interface Language

See [Chapter 10.4, "Setting the Date, Time and Language"](#), on page 174.

Options

See [Chapter 10.7, "Options"](#), on page 178

Maintenance

The "Device Info" tab provides service information for your R&S RTH. If you need support, you may be asked to provide this information. Here you can also read the "Open Source Acknowledgment", which provides verbatim license text of open source software that is used in the instrument's firmware.

The "Service" tab allows the service personnel to enter a password that activates further service functions.

Firmware Update

See [Chapter 10.8, "Updating the Firmware"](#), on page 181.

10.6 Display Settings

Access: "Display" menu

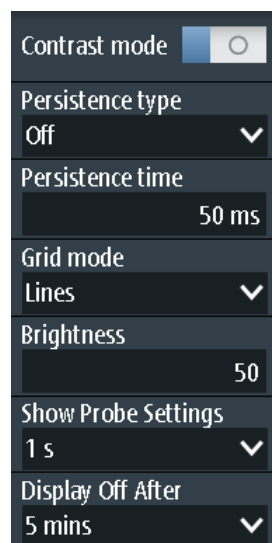
**Contrast Mode**

If enabled, the waveforms are displayed in black color on white background.

Remote command:

`DISPlay:CONTRast` on page 306

Persistence Type

Defines how long every new data point remains on the screen.

"Off" Deactivates persistence.

"Time" Data points remain on the screen for the duration defined with [Persistence Time](#).

"Infinite" Data points remain on the screen infinitely until persistence is set to "Off".

Remote command:

`DISPlay:PERSistence[:TYPE]` on page 305

Persistence Time

User-defined persistence time if "Persistence Type" is "Time". Each new data point remains on the screen for the duration defined here.

Remote command:

`DISPlay:PERSistence:TIME` on page 305

Grid Mode

Defines the grid display. A grid helps you identify the position of specific data points.

"Off" No grid is shown.

"Dots" Dots mark the intersections of the gridlines.

"Lines" Displays the grid as horizontal and vertical lines.

Brightness

Changes the brightness of the touchscreen.

Remote command:

`DIAGnostic:SERVice:LCD:BRIGthness` on page 306

Show Probe Settings

Defines how long the probe settings of active channels are shown when you press a channel key. The settings are shown on the top of the display.

The probe settings are always shown as long as the "Vertical" menu is open.

Display Off After

Defines when the display switches off if it is not used. Switching off the display saves energy and prolongs the battery's operating time.

10.7 Options

All options are activated by license keys. No additional installation or hardware change is required.



Unregistered licenses

Unregistered licenses are not assigned to a particular instrument. The instrument accepts only registered licenses. If your license is delivered unregistered, use the online tool R&S License Manager to register the license for your instrument. The registration of a permanent license is irreversible, so ensure that you register it for the correct instrument. The address of the tool is <https://extranet.rohde-schwarz.com/service>.

The "Active options" tab provides information on installed software options. Here you can install new options or deactivate existing options using license keys.

Active options		Inactive options	Deactivated options
Description	Activation type	Valid until	
K1 I2C/SPI Trigger & Decode	Permanent		
K2 UART/RS232 Trigger & Decode	Permanent		
B1 Mixed-Signal-Opt. 250 MHz	Permanent		
B242 200 MHz Option, RTH1004	Permanent		
K19 Advanced Trigger	Permanent		
K200 Wireless LAN	Permanent		

Required information to order an option

Material number	1317.5000K04
Serial number	900079
Device ID	1317.5000K04-900079-Fw

Install a new option

Enter new option key

Install from file ...

The "Inactive options" tab lists all deactivated and expired options.

Active options		Inactive options	Deactivated options
Description	Activation type	Valid until	Remark
K200 Wireless LAN	Permanent	-	deactivated

The "Deactivated options" tab shows all deactivated options with their deactivation information and provides a function to export the deactivation response. The response is required by the R&S License Manager.

Active options	Inactive options	Deactivated options
Description	Key	Response
K200 Wireless LAN	010263902420031714993030926	04690C3456E888B6B

 Export deactivation response ...

10.7.1 Activating Options

Consult your sales representative and provide the material number, serial number, and the device ID of your instrument to get a license key. You find this information in  > "Options" > "Active options".

The license key is provided in written form or in a file. Unregistered licenses must be registered in the R&S License Manager before they can be activated on the instrument.

1. If you received the option key in a file, save the file to a USB flash drive, and connect the drive to the R&S RTH.
2. Press the  key.
3. Select "Options", and select the "Active options" tab.

Active options	Inactive options	Deactivated options
Description	Activation type	Valid until
K1 I2C/SPI Trigger & Decode	Permanent	
K2 UART/RS232 Trigger & Decode	Permanent	
B1 Mixed-Signal-Opt. 250 MHz	Permanent	
B242 200 MHz Option, RTH1004	Permanent	
K19 Advanced Trigger	Permanent	
K200 Wireless LAN	Permanent	

Required information to order an option		Install a new option
Material number	1317.5000K04	Enter new option key
Serial number	900079	
Device ID	1317.5000K04-900079-Fw	Install from file ...

- If you received a key in written form, enter the key in the "Enter new option key" field.
If you received a key in digital form as a file, tap "Install from file", select path /media/USB1, and select the option key file.
- If you want to activate several options, repeat step 3 for each option.
- Restart the instrument.

10.8 Updating the Firmware

Your instrument is delivered with the latest firmware version. Firmware updates are provided on the Internet at www.rohde-schwarz.com/product/rth.html > "Downloads" > "Firmware". Along with the firmware file, you find the Release Notes describing the improvements and modifications.

Make sure to update the firmware if a new version is available.

- Download the firmware installation file RTH*.rsi, and save it to a USB flash drive.
- Connect the USB flash drive to the USB connector on the right panel of the instrument.
- Press .
- Scroll down the menu and tap "Open File" under "Firmware Update".
- Select the firmware file.
If you cannot see the RTH*.rsi file, select the path /media/USB1, and the folder that contains the file.
- Tap "Select".

7. Tap "Yes".

The firmware update starts. Wait until the update has finished. The instrument restarts automatically.

11 Network Connections

This chapter describes the setup of network connections.

There are several ways to connect the R&S RTH to a computer:

- Connect the instrument to a local area network (LAN), usually the company network. For this connection, ethernet technology is used.
LAN connection is used for remote operation using the web interface option R&S RTH-K201, for remote control using SCPI commands, and for data transfer.
- Connect the instrument directly to a computer using USB.
The direct USB connection is used for remote control using SCPI commands.
- Connect the instrument to the wireless LAN (requires option R&S RTH-K200).
You can operate the instrument remotely using a web browser on the computer or mobile device.

11.1 LAN Connection

1. Connect the LAN cable to the LAN connector on the right panel of the instrument.
2. Press the  key.
3. Select "USB/LAN".
4. Select "Interface" = "Ethernet". By default, DHCP is used and all address information is assigned automatically.
5. Note the IP address, which is required to address the instrument in the network.

Description of settings

Interface	Ethernet 
Status	Ready (Eth. connected)
Hostname	RTH-900079
DHCP	<input checked="" type="checkbox"/>
IP Address (DHCP)	10.113.1.159
Subnet mask (DHCP)	255.255.252.0
Gateway (DHCP)	10.113.0.1
DNS Server (DHCP)	10.0.2.166
MAC Address	00:90:B8:1D:E4:70

Interface

Select LAN or USB connection.

Status

Shows the connection status.

Hostname

Shows the computer name of the instrument.

In a LAN that uses a Domain Name System server (DNS server), each computer or instrument can be accessed using a unique name instead of the IP address. The DNS server translates the host name to the IP address. The host name is useful when a DHCP server is used, as a new IP address is assigned each time the instrument is restarted.

The default name is RTH-<serial_number>. You can change the name, but make sure that the name is unique in the LAN.

DHCP

Enables dynamic TCP/IP configuration using the Dynamic Host Configuration Protocol (DHCP). If DHCP is on, all address information is assigned automatically. Disable DHCP if the network does not support this protocol.

IP Address / Subnet mask / Gateway / DNS Server

Shows the IP address and other address information for LAN connection.

If the network supports DHCP, the DHCP server assigns these parameters. It is safe to establish a connection to the LAN without any previous instrument configuration.

If DHCP is not supported, enter the address information manually (static address).

Note: Risk of network errors. Connection errors can affect the entire network. If your network does not support DHCP, or if you disable DHCP, make sure to assign valid address information before connecting the instrument to the LAN. To obtain a valid IP address, subnet mask, and gateway, contact your network administrator.

MAC Address

Shows the media access control address (MAC address), a physical address and a unique identifier of the instrument.

11.2 USB connection

The USB device connector is intended to connect a computer directly to the instrument. You need a VISA communication tool installed on the computer to control the instrument using remote commands.

1. Connect a USB cable to the USB mini-B connector on the right panel of the instrument, and to a computer.
2. Press the  key.
3. Select "USB/LAN".
4. Select "Interface" = "USB".
The instrument shows the connection status.
5. When the computer detects the connected instrument, the drivers are automatically installed, and a message is displayed.
The drivers are IVI drivers
6. Open the Device Manager on the computer and check if the connected instrument is shown.

11.3 Wireless LAN Connection (Option R&S RTH-K200/200US)

Using the option R&S RTH-K200/200US, you can control your instrument with a portable device. Thus, you can perform dangerous measurements without risk.

When the instrument is connected to the portable device, the waveform display and user interface of the R&S RTH are directly available in the web browser. All settings can be changed in the browser, no software installation is required.

There are two ways to connect via wireless LAN:

- Usually, the R&S RTH is the access point and you set up connection on the portable device.
- The R&S RTH is the client that connects to a router or access point.

To enable wireless LAN

1. Press the  key.
2. Tap "Wireless LAN".
3. Only for option R&S RTH-K200: Select the "Country", where you use the instrument.
The list contains all countries where the wireless LAN option has been approved. You also can find the list in the data sheet.
4. Enable "Wireless State".
Now you can connect the instrument.

To use the instrument as access point

1. Select "Wireless Mode" = "Access Point" in the "Wireless LAN" menu.
2. If you connect for the first time, change the default "Passphrase". You can also change the identifier of the instrument, the "SSID".
3. On your portable device, set up the connection to the instrument. Select the SSID and enter the passphrase.
The detailed procedure is described in the documentation of your portable device.

To use the instrument as client

1. Select "Wireless Mode" = "Client" in the "Wireless LAN" menu.
2. Tap "Scan" for available wireless LAN routers and access points.
3. Select the "Network SSID" of the required router.
4. Enter the password of the required router in "Network Passphrase".
If the connection succeeded, "Connected" is enabled.
Alternatively, you can enter the DHCP or static IP address of the router to identify it.

 **Description of settings**

Wireless State	<input type="checkbox"/>
Wireless Mode	Access point
SSID	RTH-
Passphrase	RTH_AP12345
Status	
MAC Address	D9:AA:FF:AA:CE:DD

Country

Select the country, where you use the wireless LAN. The list contains all countries where the wireless LAN option has been approved.

Wireless State

Enables or disables wireless LAN access.

Wireless Mode

Selects the wireless LAN function of the instrument. It can serve as access point or as client.

Remote command:

[SYSTEM:COMMunicate:WLAN:MODE](#) on page 306

SSID

Shows the wireless LAN identifier of the instrument. You can change the identifier.

Passphrase

Shows the wireless LAN password of the instrument. You can change the password.

Status / Connected

Shows the connection status.

Network SSID

Enter the SSID of the router to which you want to connect.

Network Passphrase

Enter the password of the router to which you want to connect.

Scan

Checks for available routers and access points.

MAC Address

Shows the media access control address (MAC address), a physical address and unique identifier of the instrument.

11.4 Web Interface (Option R&S RTH-K201)

If the R&S RTH is connected to a computer via LAN or WLAN (with option R&S RTH-K200/200US), you can operate the instrument from the computer. No additional tools are required, you need only a web browser that supports HTML5. Thus, you can use your smartphone or tablet to operate the oscilloscope remotely.

1. Open a web browser on the computer or mobile device.
2. Type the instrument's host name or IP address in the address field of the browser, for example, *http://10.133.10.203*.

The instrument's homepage is shown.

Using the web interface, you can:

- Display a screenshot of the current instrument display.
- Operate the instrument using the menus on the emulated display.
This view is designed for small devices, for example, smartphones.
- Operate the instrument using the emulated front panel.
You see a live image of the instrument. You can use the keys, the wheel and the menus in the same way as directly on the instrument.
- Organize the data that is saved on the instrument.
You can download files to the computer, upload files to the instrument, delete and rename files, and create folders.

12 Remote Control Commands

12.1 Conventions used in Command Description

Note the following conventions used in the remote command descriptions:

- **Command usage**
If not specified otherwise, commands can be used both for setting and for querying parameters.
If a command can be used for setting or querying only, or if it initiates an event, the usage is stated explicitly.
- **Parameter usage**
If not specified otherwise, a parameter can be used to set a value and it is the result of a query.
Parameters required only for setting are indicated as **Setting parameters**.
Parameters required only to refine a query are indicated as **Query parameters**.
Parameters that are only returned as the result of a query are indicated as **Return values**.
- **Conformity**
Commands that are taken from the SCPI standard are indicated as **SCPI confirmed**. All commands used by the R&S RTH follow the SCPI syntax rules.
- **Asynchronous commands**
A command which does not automatically finish executing before the next command starts executing (overlapping command) is indicated as an **Asynchronous command**.
- **Reset values (*RST)**
Default parameter values that are used directly after resetting the instrument (*RST command) are indicated as ***RST** values, if available.
- **Default unit**
This is the unit used for numeric values if no other unit is provided with the parameter.

12.2 Mode

OP[:MODE] <OperationMode>

Sets the operating mode of the instrument.

Parameters:

<OperationMode> YT | XY | MASK | METer | LOGGer

*RST: YT (scope mode)

12.3 Waveform Setup

- [Automatic Setup](#)..... 190
- [Vertical Setup](#)..... 190
- [Horizontal Setup](#)..... 195
- [Acquisition Control](#)..... 196
- [Trigger](#)..... 198

12.3.1 Automatic Setup

AUToscale

Performs an autoset in scope mode.

Usage: Event

12.3.2 Vertical Setup

The channel suffix <m> selects the channel for which the command is executed. The number of channels depends on the instrument type. The R&S RTH1004 has 4 channels, the suffix values are 1 | 2 | 3 | 4. The R&S RTH1002 has 2 channels, the suffix values are 1 | 2.



Set the attenuation factor of the probe manually on the display when you attach the probe: "Vertical" > "Probe Setting". There is no remote command for probe setup. Make sure to set the attenuation factor on the instrument according to the probe being used. Otherwise, the measurement results do not reflect the actual voltage level, and you might misjudge the actual risk.

CHANnel<m>:STATe	190
CHANnel<m>:SCALE	191
CHANnel<m>:RANGE	191
CHANnel<m>:POLarity	191
CHANnel<m>:POSition	192
CHANnel<m>:OFFSet	192
CHANnel<m>:COUPling	192
CHANnel<m>:BANDwidth	192
CHANnel<m>:DESKew	193
CHANnel<m>:THReshold:TECHnology	193
CHANnel<m>:THReshold:USER	194
CHANnel<m>:THReshold:THReshold?	194

CHANnel<m>:STATe <State>

Switches the channel signal on or off.

Suffix:

<m> 1|2 (RTH1002) , 1..4 (RTH1004)

Parameters:

<State> ON | OFF
*RST: OFF

CHANnel<m>:SCALE <Scale>

Sets the vertical scale (vertical sensitivity) of the indicated waveform.

Suffix:

<m> 1|2 (RTH1002) , 1..4 (RTH1004)

Parameters:

<Scale> Scale value, given in Volts per division
Range: 2E-3 to 100
Increment: 1E-3
*RST: 0.05
Default unit: V/div

CHANnel<m>:RANGe <Range>

Sets the voltage range across the 8 vertical divisions of the diagram. Use the command alternatively to [CHANnel<m>:SCALE](#).

Suffix:

<m> 1|2 (RTH1002) , 1..4 (RTH1004)

Parameters:

<Range> Voltage range value
Range: 0 to 800E+3
Increment: 10E-6
*RST: 0
Default unit: V

CHANnel<m>:POLarity <Polarity>

Turns the inversion of the signal amplitude on or off. To invert means to reflect the voltage values of all signal components against the ground level. Inversion affects only the display of the signal but not the trigger.

Suffix:

<m> 1|2 (RTH1002) , 1..4 (RTH1004)

Parameters:

<Polarity> NORMal | INVerted
*RST: NORMal

CHANnel<m>:POSition <Position>

Moves the selected signal up or down in the diagram. The position is a graphical setting given in divisions, while the offset sets a voltage.

Suffix:

<m> 1|2 (RTH1002) , 1..4 (RTH1004)

Parameters:

<Position> Position value, given in divisions.
 Range: -4 to 4
 Increment: 0.5
 *RST: 0
 Default unit: div

CHANnel<m>:OFFSet <Offset>

Sets an offset voltage that is added to correct an offset-affected signal. The value is included in measurement results. The signal is shifted in relation to the ground level by the offset value. Negative offset values move the waveform down, positive values move it up.

Suffix:

<m> 1|2 (RTH1002) , 1..4 (RTH1004)

Parameters:

<Offset> Range: -400 to 400
 Increment: 0.5
 *RST: 0
 Default unit: V

CHANnel<m>:COUPling <Coupling>

Selects the connection of the indicated channel.

Suffix:

<m> 1|2 (RTH1002) , 1..4 (RTH1004)

Parameters:

<Coupling> DCLimit | ACLimit

DCLimit

The signal passes the input unchanged.

ACLimit

A high-pass filter removes the DC offset voltage from the input signal if the DC component of a signal is of no interest.

*RST: DCLimit

CHANnel<m>:BANDwidth <BandwidthLimit>

Selects the bandwidth limit for the indicated channel.

Suffix:

<m> 1|2 (RTH1002) , 1..4 (RTH1004)

Parameters:

<BandwidthLimit> FULL | B350 | B200 | B100 | B60 | B50 | B40 | B20 | B10 | B5 | B4 | B2 | B1 | B5HK | B4HK | B2HK | B1HK | B50K | B40K | B20K | B10K | B5K | B4K | B2K | B1K

FULL

At full bandwidth, all frequencies in the specified range are acquired and displayed.

B350 | B200 | B100 | B60 | B50 | B40 | B20 | B10 | B5 | B4 | B2 | B1

Limit to 350 MHz, 200 MHz, 100 MHz, 60 MHz, ..., respectively.

B5HK | B4HK | B2HK | B1HK | B50K | B40K | B20K | B10K | B5K | B4K | B2K | B1K

Limit to 500 kHz, 400 kHz, ..., respectively.

*RST: FULL

CHANnel<m>:DESKew <Deskew>

Sets a delay for the selected channel.

Deskew compensates delay differences between channels caused by the different length of cables, probes, and other sources.

Suffix:

<m> 1|2 (RTH1002) , 1..4 (RTH1004)

Parameters:

<Deskew> Deskew value
 Range: -100E-9 to 100E-9
 Increment: 800E-12
 *RST: 0
 Default unit: s

CHANnel<m>:THReshold:TECHnology <ThresholdType>

Sets the threshold value for digitization of analog signals. If the signal value is higher than the threshold, the signal state is high (1 or true for the boolean logic). Otherwise, the signal state is considered low (0 or false) if the signal value is below the threshold.

Suffix:

<m> 1|2 (RTH1002) , 1..4 (RTH1004)

Parameters:

<ThresholdType> TTL | ECL | CMOS | CAN | GND | LIN7vsupply | LIN12vsupply | LIN18vsupply | USER

TTL

1.4 V

ECL

-1.3 V

CMOS

2.5 V

GND

0 V (for CAN channels, requires option R&S RTH-K3)

CAN

2 V (for CAN channels, requires option R&S RTH-K3)

LIN7vsupply | LIN12vsupply | LIN18vsupply

7 V / 12 V / 18 V (for LIN channels, requires option R&S RTH-K3)

USER

Set the value with `CHANnel<m>:THReshold:USER`.

*RST: TTL

CHANnel<m>:THReshold:USER <ThresholdValue>

Set an individual threshold value if `CHANnel<m>:THReshold:TECHnology` is set to USER.

Suffix:

<m> 1|2 (RTH1002) , 1..4 (RTH1004)

Parameters:

<ThresholdValue> Range: -400 to 400
Increment: 1E-3
*RST: 1.4
Default unit: V

CHANnel<m>:THReshold:THReshold?

Returns the threshold value.

Suffix:

<m> 1|2 (RTH1002) , 1..4 (RTH1004)

Return values:

<Level> Range: -10 to 10
Increment: 1E-3
*RST: 0
Default unit: V

Usage: Query only

12.3.3 Horizontal Setup

TIMEbase:SCALE	195
TIMEbase:RANGe	195
TIMEbase:HORizontal:POSition	195
TIMEbase:REFerence	195
ACQuire:POINts:ARATe?	196

TIMEbase:SCALE <Scale>

Sets the time scale of the horizontal axis for all signals.

Parameters:

<Scale> Range: 1E-9 to 500
 Increment: Steps 1, 2, 5 (1, 2, 5, 10, 20, 50, 100, 200, 500...)
 *RST: 100E-9
 Default unit: s/div

TIMEbase:RANGe <AcquisitionTime>

Sets the acquisition time, the timerange across the 10 horizontal divisions of the diagram. Use the command alternatively to [TIMEbase:SCALE](#).

Parameters:

<AcquisitionTime> Range: 10E-9 to 5000
 Increment: Steps 1, 2, 5 (1, 2, 5, 10, 20, 50, 100, 200, 500...)
 *RST: 1E-6
 Default unit: s

TIMEbase:HORizontal:POSition <Position>

Sets the horizontal position of the trigger point in relation to the reference point.

See also: "[Horizontal Position](#)" on page 47

Parameters:

<Position> Range: Depends on the time scale, see table below.
 Increment: 0.1
 *RST: 0
 Default unit: s

Time scale	Min./max. horizontal position
1 ns/div to 100 µs/div	±2 s
200 µs/div to 2 s/div	<i>Time scale * 20000</i>
5 s/div – 500 s/div	100000 s

TIMEbase:REFerence <ReferencePoint>

Defines the time reference point in the diagram.

Parameters:

<ReferencePoint> Position of the reference point in percent of the screen width.
 Available values are:
 10: on the left side of the screen
 50: in the middle of the screen
 90: on the right side
 *RST: 50
 Default unit: %

ACQUIRE:POINTS:ARATE?

Returns the number of recorded analog waveform points per second.

Return values:

<ADCSampleRate> Range: 1.25E+9 to 5E+9
 Increment: 1
 *RST: 1.25E+9
 Default unit: Sa/s

Usage: Query only

12.3.4 Acquisition Control

RUN.....	196
STOP.....	196
ACQUIRE:MODE.....	196
ACQUIRE:AVERAge:COUNT.....	197
ACQUIRE:ARESet:IMMediate.....	197
ACQUIRE:POINts[:VALue]?.....	197
ACQUIRE:RESolution?.....	198

RUN

Starts the continuous acquisition.

Usage: Event

STOP

Stops the running acquisition.

Usage: Event

ACQUIRE:MODE <AcquisitionMode>

Defines how the waveform is built from the captured samples.

Parameters:

<AcquisitionMode> SAMPLE | PDETECT | HRESOLUTION | AVERAGE | ENVELOPE

SAMPLE

One of n samples in a sample interval is recorded as waveform point, the other samples are discarded.

PDETECT

The minimum and the maximum of n samples are recorded as waveform points, the other samples are discarded.

HRESOLUTION

The average of n captured sample points is recorded as one waveform point.

AVERAGE

The average is calculated from the data of the current acquisition and a number of acquisitions before. The number of acquisitions for average calculation is defined with **ACQUIRE:**

AVERAGE:COUNT.

ENVELOPE

The minimum and maximum values in an sample interval over a number of acquisitions are saved. The most extreme values of all acquisitions build the envelope.

*RST: SAMPLE

ACQUIRE:AVERAGE:COUNT <NoOfAves>

Sets the number of waveforms used to calculate the average waveform.

Parameters:

<NoOfAves> Range: 2 to 8192
Increment: 2^N (N = 1 .. 13)
*RST: 2

ACQUIRE:ARESET:IMMEDIATE

Restarts the envelope and average calculation.

Usage: Event

ACQUIRE:POINTS[:VALUE]?

Returns the record length, number of recorded waveform samples.

Return values:

<RecordLength> Range: 1 to 500000
Increment: 1
*RST: 1

Usage: Query only

ACQUIRE:RESOLUTION?

Returns the resolution, the time between two waveform samples.

Return values:

<ResolutionPP> Range: 1E-12 to 1E+12
 Increment: 1E-12
 *RST: 0
 Default unit: s

Usage: Query only

12.3.5 Trigger

• General Trigger Settings	198
• Edge Trigger	201
• Glitch Trigger	201
• Width Trigger	202
• Video/TV Trigger	204
• External Trigger (R&S RTH1002)	207
• Pattern Trigger (R&S RTH-K19)	208
• State Trigger (R&S RTH-K19)	210
• Runt Trigger (R&S RTH-K19)	211
• Slew Rate Trigger (R&S RTH-K19)	213
• Data2Clock Trigger (R&S RTH-K19)	216
• Serial Pattern Trigger (R&S RTH-K19)	217
• Timeout Trigger (R&S RTH-K19)	219
• Interval Trigger (R&S RTH-K19)	219
• Window Trigger (R&S RTH-K19)	221

12.3.5.1 General Trigger Settings

See also: [Chapter 2.5.1, "General Trigger Settings"](#), on page 50

TRIGger:MODE	198
TRIGger:SOURce	199
TRIGger:TYPE	199
TRIGger:LEVel<m>:VALue	199
TRIGger:HOLDoff:MODE	200
TRIGger:HOLDoff:TIME	200
TRIGger:HOLDoff:EVENTs	201
TRIGger:HOLDoff:MIN	201
TRIGger:HOLDoff:MAX	201
TRIGger:MNR	201

TRIGger:MODE <Mode>

The trigger mode determines the behavior of the instrument if no trigger occurs, and also the number of acquired waveforms when a trigger occurs.

Parameters:

<Mode> AUTO | NORMAl | SINGle | AS

AUTO

The instrument triggers repeatedly after a time interval if the trigger conditions are not fulfilled. If a real trigger occurs, it takes precedence.

NORMAl

The instrument acquires waveforms continuously, each time when a trigger occurs.

SINGle

When a trigger occurs, the instrument acquires one waveform.

*RST: AUTO

TRIGger:SOURce <Source>

Selects the trigger source, the waveform on which the trigger condition is checked.

Parameters:

<Source> C1 | C2 | C3 | C4 | D0 | D1 | D2 | D3 | D4 | D5 | D6 | D7

Logic channels D0..D7 require option R&S RTH-B1. For video, runt, slew rate and window trigger, only analog channels are available.

*RST: C1

TRIGger:TYPE <Type>

Selects the trigger type, the event type that defines the trigger point.

Parameters:

<Type> EDGE | GLITch | WIDTHh | TV | PATTeRn | STATe | RUNT | SLEWrate | DATatoclock | SERPattern | TIMEout | INTerval | WINDow | PROTocol

EDGE | GLITch | WIDTHh | TV

Standard trigger types

PATTeRn | STATe | RUNT | SLEWrate | DATatoclock | SER-Pattern | TIMEout | INTerval | WINDow

Require option R&S RTH-K19

PROTocol

Requires option R&S RTH-K1 and/or R&S RTH-K2

*RST: EDGE

TRIGger:LEVel<m>:VALue <Level>

Sets the trigger level voltage. The command is relevant for all trigger types that require one trigger level.

Suffix:

<m> 1..23
 Indicates the trigger source:
 1..4: analog channels 1 to 4
 8..15: digital channels D0 to D7
 5..7 and 16..22: not available

Parameters:

<Level> Range: -10 to 10
 Increment: 1E-3
 *RST: 0
 Default unit: V

TRIGger:HOLDoff:MODE <Mode>

Selects the method to define the holdoff.

Parameters:

<Mode> OFF | TIME | RANDom | EVENts

OFF

No holdoff

TIME

Defines the holdoff as a time period. The next trigger occurs only after a time has passed, which is defined with [TRIGger:HOLDoff:TIME](#).

RANDom

Defines the holdoff as a random time limited by [TRIGger:HOLDoff:MIN](#) and [TRIGger:HOLDoff:MAX](#). For each acquisition, the instrument selects a new random holdoff time from the specified range.

EVENts

Defines the holdoff as a number of trigger events, which is defined with [TRIGger:HOLDoff:EVENts](#).

*RST: OFF

TRIGger:HOLDoff:TIME <Time>

Sets the time that has to pass at least until the next trigger occurs. The command takes effect if [TRIGger:MODE](#) is set to [TIME](#).

Parameters:

<Time> Range: 8E-9 to 10
 Increment: 200E-6
 *RST: 1E-3
 Default unit: s

TRIGger:HOLDoff:EVENTs <Events>

Sets the number of triggers to be skipped until the next trigger occurs. The command takes effect if **TRIGger:MODE** is set to **EVENTs**.

Parameters:

<Events> Range: 1 to 1000000000
 Increment: 10
 *RST: 1

TRIGger:HOLDoff:MIN <RandomMinTime>**TRIGger:HOLDoff:MAX** <RandomMaxTime>

Set the time limits for random holdoff time. For each acquisition, the instrument selects a new random holdoff time from the specified range.

Parameters:

<RandomMinTime> Range: 8E-9 to 10
 <RandomMaxTime> Increment: 200E-6
 *RST: 2E-3
 Default unit: s

TRIGger:MNR <MoreNoiseReject>



Enables a hysteresis to avoid unwanted trigger events caused by noise oscillation around the trigger level.

Parameters:

<MoreNoiseReject> ON | OFF
 *RST: OFF

12.3.5.2 Edge Trigger**TRIGger:EDGE:SLOPe** <Slope>

Sets the edge direction for the trigger. You can trigger on:

-  Rising edge, that is a positive voltage change
-  Falling edge, that is a negative voltage change
-  Rising and falling edge

Parameters:

<Slope> POSitive | NEGative | EITHer
 *RST: POSitive

12.3.5.3 Glitch Trigger

See also: [Chapter 2.5.3, "Glitch Trigger"](#), on page 54

TRIGger:GLITch:POLarity.....	202
TRIGger:GLITch:RANGe.....	202
TRIGger:GLITch:WIDTh.....	202

TRIGger:GLITch:POLarity <Polarity>

Sets the pulse polarity, that is the direction of the first pulse slope. You can trigger on:

- Positive going pulses. The width is defined from the rising to the falling edge.
- Negative going pulses. The width is defined from the falling to the rising edge.
- Both positive and negative going pulses

Parameters:

<Polarity> POSitive | NEGative | EITHER
 *RST: POSitive

TRIGger:GLITch:RANGe <Condition>

Selects the glitches to be identified: shorter or longer than the width specified with [TRIGger:GLITch:WIDTh](#).

Parameters:

<Condition> LONGer | SHORter
 *RST: LONGer

TRIGger:GLITch:WIDTh <Duration>

Sets the pulse width of the glitch.

Parameters:

<Duration> Range: 800E-12 to 10000
 Increment: 100E-9
 *RST: 5E-9
 Default unit: s

12.3.5.4 Width Trigger

See also [Chapter 2.5.4, "Width Trigger"](#), on page 55.

TRIGger:WIDTh:POLarity.....	202
TRIGger:WIDTh:RANGe.....	203
TRIGger:WIDTh:WIDTh.....	203
TRIGger:WIDTh:DELTA.....	203
TRIGger:WIDTh:MAX.....	204
TRIGger:WIDTh:MIN.....	204

TRIGger:WIDTh:POLarity <Polarity>

Sets the pulse polarity, that is the direction of the first pulse slope. You can trigger on:

- Positive going pulses. The width is defined from the rising to the falling edge.
- Negative going pulses. The width is defined from the falling to the rising edge.
- Both positive and negative going pulses

Parameters:

<Polarity> POSitive | NEGative | EITHer
 *RST: POSitive

TRIGger:WIDTh:RANGe <Condition>

Defines how the measured pulse width is compared with the given limit(s).

Parameters:

<Condition> LONGer | SHORter | EQUal | NEQual | WITHin | OUTSide

LONGer | SHORter

Triggers on pulses shorter or longer than a width set using [TRIGger:WIDTh:WIDTh](#).

EQUal | NEQual

Triggers on pulses equal or not equal a given width that is set using [TRIGger:WIDTh:WIDTh](#). In addition, a tolerance can be set around the specified width using [TRIGger:WIDTh:DELTA](#).

WITHin | OUTSide

Triggers on pulses inside or outside a given range. The range is set using [TRIGger:WIDTh:MIN](#) and [TRIGger:WIDTh:MAX](#).

*RST: LONGer

TRIGger:WIDTh:WIDTh <Duration>

Sets the width for comparison ranges EQUal, UNEQual, SHORter, and LONGer.

See [TRIGger:WIDTh:RANGe](#) on page 203

Parameters:

<Duration> Range: 800E-12 to 10000
 Increment: 100E-9
 *RST: 5E-9
 Default unit: s

TRIGger:WIDTh:DELTA <Tolerance>

Sets a range Δt to the specified width, which is defined using [TRIGger:WIDTh:WIDTh](#).

Parameters:

<Tolerance> Range: 0 to 5000
 Increment: 500E-12
 *RST: 0
 Default unit: s

TRIGger:WIDTh:MAX <MaxDuration>

Sets the upper limit for the pulse width if **TRIGger:WIDTh:RANGe** is set to **WIDHIn** or **OUTSide**.

Parameters:

<MaxDuration> Range: 800E-12 to 10000
 Increment: 100E-9
 *RST: 5E-9
 Default unit: s

TRIGger:WIDTh:MIN <MinDuration>

Sets the lower limit for the pulse width if **TRIGger:WIDTh:RANGe** is set to **WIDHIn** or **OUTSide**.

Parameters:

<MinDuration> Range: 800E-12 to 10000
 Increment: 100E-9
 *RST: 5E-9
 Default unit: s

12.3.5.5 Video/TV Trigger

The standards PAL, PAL-M, NTSC and SECAM are available in the instrument firmware. All other standards and custom signals require the advanced trigger option (R&S RTH-K19).

TRIGger:TV:STANdard	204
TRIGger:TV:POLarity	205
TRIGger:TV:MODE	205
TRIGger:TV:LINE	206
TRIGger:TV:LFIeld	206
TRIGger:TV:CUSTom:STYPe	206
TRIGger:TV:CUSTom:LDURation	207
TRIGger:TV:CUSTom:SDURation	207
TRIGger:TV:CUSTom:SCANmode	207

TRIGger:TV:STANdard <Standard>

Selects the TV standard or **CUSTom** for user-defined signals.

Parameters:

<Standard>

PAL | PALM | NTSC | SECam | P480L60HZ | P576L50HZ |
 P720L30HZ | P720L50HZ | P720L60HZ | I1080L50HZ |
 I1080L60HZ | P1080L24HZ | P1080L24HZSF | P1080L25HZ |
 P1080L30HZ | P1080L50HZ | P1080L60HZ | CUSTom

PAL | PALM | NTSC | SECam

Standards delivered with the instrument firmware.

PxxxxLyyHZ

HDTV standards using progressive scanning (P). xxxx indicates the number of active lines, yy is the frame rate.

Triggering on HDTV standards requires option R&S RTH-K19.

IxxxxLxxHZ

HDTV standards using interlaced scanning (I). xxxx indicates the number of active lines, yy is the field rate.

P1080L24HZSF

1080p/24sF is a HDTV standard using progressive segmented frame scanning.

CUSTom

Used for signals of other video systems, for example, medical displays, video monitors, and security cameras. Requires option R&S RTH-K19.

*RST: PAL

TRIGger:TV:POLarity <Polarity>

Sets the polarity of the signal. Note that the sync pulse has the opposite polarity, for example, a positive signal has a negative sync pulse.

Parameters:

<Polarity>

POSitive | NEGative

*RST: POSitive

TRIGger:TV:MODE <Mode>

Selects the lines or fields on which the instrument triggers. Available modes depend on the scanning system of the selected standard.

Parameters:

<Mode>

ALL | ODD | EVEN | ALINe | LINE

ALL

All fields: Triggers on the first video line of the frame (progressive scanning) or field (interlaced scanning), for example, to find amplitude differences between the fields.

ODD | EVEN

Odd fields / even fields: Triggers on the first video line of the odd or even field. These modes are available for interlaced scanning (PAL, PAL-M, SECAM, NTSC, 1080i) and progressive segmented frame scanning (1080p/24sF). They can be used, for example, to analyze the components of a video signal.

ALINe

All lines: Triggers on the line start of all video lines, for example, to find maximum video levels.

LINE

Triggers on a specified line. Specify the line number using [TRIGger:TV:LINE](#).

*RST: ALL

TRIGger:TV:LINE <LineNumber>

Sets the number of the line to be triggered on if [TRIGger:TV:MODE](#) is LINE.

Usually the lines of the frame are counted, beginning from the frame start.

For NTSC signals, the lines are counted per field, not per frame. Therefore, you have to set the odd or even field using [TRIGger:TV:LField](#), and the line number in the field.

Parameters:

<LineNumber>

Range: 1 to 3000

Increment: 1

*RST: 1

TRIGger:TV:LField <LineField>

Line field (odd or even) used as reference for counting the video lines. Used by the NTSC standard.

Parameters:

<LineField>

FIELD1 | FIELD2

*RST: FIELD1

TRIGger:TV:CUSTom:STYPe <SyncPulseType>

Sets the type of the sync pulse, either bi-level sync pulse (usually used in SDTV signals), or tri-level sync pulse (used in HDTV signals).

Parameters:

<SyncPulseType> BIlevel | TRILevel
 *RST: BIlevel

TRIGger:TV:CUSTom:LDURation <LineDuration>

Sets the duration of a single video line, the time between two successive sync pulses.

Parameters:

<LineDuration> Range: 5E-6 to 200E-6
 Increment: 100E-9
 *RST: 64E-6
 Default unit: s

TRIGger:TV:CUSTom:SDURation <SyncPulseDuration>

Sets the width of the sync pulse.

Parameters:

<SyncPulseDuration> Range: 100E-9 to 100E-6
 Increment: 100E-9
 *RST: 4.7E-6
 Default unit: s

TRIGger:TV:CUSTom:SCANmode <ScanMode>

Sets the scanning system.

For details, see "Scan" on page 61.

Parameters:

<ScanMode> INTerlaced | PROGressive | SEGmented
 *RST: INTerlaced

12.3.5.6 External Trigger (R&S RTH1002)

TRIGger:EXTernal:LEVel.....207

TRIGger:EXTernal:SLOPe.....208

TRIGger:EXTernal:LEVel <Level>

Sets the trigger voltage level.

Parameters:

<Level> Range: -10 to 10
 Increment: 1E-3
 *RST: 0
 Default unit: V

TRIGger:EXTernal:SLOPe <Slope>

Sets the edge direction for the trigger. You can trigger on the rising edge, the falling edge, or riding and falling edges of the external signal.

Parameters:

<Slope> POSitive | NEGative | EITHer
*RST: POSitive

12.3.5.7 Pattern Trigger (R&S RTH-K19)

See also [Chapter 2.5.7, "Pattern Trigger \(R&S RTH-K19\)"](#), on page 62.

TRIGger:PATtern:STATe[:CHANnel<m>].....	208
TRIGger:PATtern:STATe:COMBination.....	208
TRIGger:PATtern:WIDTh:RANGe.....	209
TRIGger:PATtern:TIMEout[:TIME].....	209
TRIGger:PATtern:WIDTh[:WIDTh].....	209
TRIGger:PATtern:WIDTh:DELTA.....	210

TRIGger:PATtern:STATe[:CHANnel<m>] <State>

Sets the state of each input channel. The channel is specified by the channel suffix:

The logical combination of the channel states is defined by [TRIGger:PATtern:STATe:COMBination](#).

Suffix:

<m> 1..4: analog channel 1 to 4
 8..15: digital channels D0 to D7
 5..7 and 16..22: not available

Parameters:

<State> ONE | ZERO | DONTcare
ONE
The signal value is above the defined threshold.
ZERO
The signal value is below the defined threshold.
DONTcare
The signal state does not matter.
*RST: DONTcare

TRIGger:PATtern:STATe:COMBination <ChCombination>

Sets the logical combination for all active channels. The required state of each channel is defined by [TRIGger:STATe:CHANnel<m>](#).

Parameters:

<ChCombination> AND | OR
*RST: AND

TRIGger:PATtern:WIDTh:RANGe <Condition>

Adds additional time limitation to the pattern defined by `TRIGger:PATtern:STATe[:CHANnel<m>]` and `TRIGger:PATtern:STATe:COMBination`.

Parameters:

<Condition>

ANY | TIMEout | LONGer | SHORter | EQUal | NEQual | WITHin | OUTSide

ANY

Triggers on all runts fulfilling the level condition, without time limitation.

Triggers if the signals match the pattern definition for a minimum time, which is specified by `TRIGger:PATtern:TIMEout[:TIME]`.

LONGer | SHORter

Triggers on pulses shorter or longer than a runt width that is defined by `TRIGger:RUNT:WIDTh`.

EQUal | NEQual

Triggers pulses with a width equal or unequal to a given width and an optional tolerance defined by `TRIGger:RUNT:WIDTh` and `Runt Width`

WITHin | OUTSide

Triggers on pulses inside or outside a given range. The range is defined by ..

*RST: LONGer

TRIGger:PATtern:TIMEout[:TIME] <Time>

Sets a minimum time during which the signals match the pattern definition defined by `TRIGger:PATtern:STATe[:CHANnel<m>]` and `TRIGger:PATtern:STATe:COMBination`.

The command is required if `TRIGger:PATtern:WIDTh:RANGe` is set to TIMEout.

Parameters:

<Time>

Range: 100E-12 to 10000

Increment: 100E-9

*RST: 5E-9

Default unit: s

TRIGger:PATtern:WIDTh[:WIDTh] <Duration>

Sets the width for comparison ranges LONGer, SHORter, EQUal and NEQual.

See `TRIGger:PATtern:WIDTh:RANGe` on page 209.

Parameters:

<Duration> Range: 800E-12 to 10000
 Increment: 100E-9
 *RST: 5E-9
 Default unit: s

TRIGger:PATtern:WIDTh:DELTA <Tolerance>

Sets a range Δt to the pattern width that is defined by `TRIGger:PATtern:WIDTh[:WIDTh]`.

Parameters:

<Tolerance> Range: 0 to 5000
 Increment: 500E-12
 *RST: 0
 Default unit: s

12.3.5.8 State Trigger (R&S RTH-K19)

See also [Chapter 2.5.8, "State Trigger \(R&S RTH-K19\)"](#), on page 64.

<code>TRIGger:STATe:CHANnel<m></code>	210
<code>TRIGger:STATe:COMBination</code>	211
<code>TRIGger:STATe:CSOurce[:VALue]</code>	211
<code>TRIGger:STATe:CSOurce:EDGE</code>	211

TRIGger:STATe:CHANnel<m> <State>

Sets the state of each input channel. The channel is specified by the channel suffix:

The logical combination of the channel states is defined by `TRIGger:STATe:COMBination`.

Suffix:

<m> 1..4: analog channel 1 to 4
 8..15: digital channels D0 to D7
 5..7 and 16..22: not available

Parameters:

<State> ONE | ZERO | DONTcare

ONE

The signal value is above the defined threshold.

ZERO

The signal value is below the defined threshold.

DONTcare

The signal state does not matter.

*RST: DONTcare

TRIGger:STAtE:COMBination <ChCombination>

Sets the logical combination for all active channels. The required state of each channel is defined by `TRIGger:PATtern:STAtE[:CHANnel<m>]`.

Parameters:

<ChCombination> AND | OR
 *RST: AND

TRIGger:STAtE:CSOURCE[:VALue] <Source>

Sets the input channel of the clock signal.

Parameters:

<Source> C1 | C2 | C3 | C4 | D0 | D1 | D2 | D3 | D4 | D5 | D6 | D7
 *RST: C1

TRIGger:STAtE:CSOURCE:EDGE <Slope>

Sets the edge of the clock at which the instrument checks the signal states.

Parameters:

<Slope> POSitive | NEGative | EITHer
 *RST: POSitive

12.3.5.9 Runt Trigger (R&S RTH-K19)

See also [Chapter 2.5.9, "Runt Trigger \(R&S RTH-K19\)"](#), on page 65.

<code>TRIGger:LEVel<m>:RUNT:LOWer</code>	211
<code>TRIGger:LEVel<m>:RUNT:UPPer</code>	211
<code>TRIGger:RUNT:POLarity</code>	212
<code>TRIGger:RUNT:RANGe</code>	212
<code>TRIGger:RUNT:WIDTh</code>	212
<code>TRIGger:RUNT:DELTa</code>	213
<code>TRIGger:RUNT:MAXWidth</code>	213
<code>TRIGger:RUNT:MINWidth</code>	213
<code>TRIGger:RUNT:MAXWidth</code>	213

TRIGger:LEVel<m>:RUNT:LOWer <LowerLevel>**TRIGger:LEVel<m>:RUNT:UPPer** <UpperLevel>

Set the upper and lower levels that limit the runt.

Suffix:

<m> 1..23
 1..4: Indicates the trigger source: analog channel 1 to 4
 5..22: not available

Parameters:

<LowerLevel> Range: -10 to 10
 <UpperLevel> Increment: 1E-3
 *RST: 0
 Default unit: V

TRIGger:RUNT:POLarity <Polarity>

Sets the pulse polarity, that is the direction of the first pulse slope. You can trigger on:

- Positive going pulses. The width is defined from the rising to the falling edge.
- Negative going pulses. The width is defined from the falling to the rising edge.
- Both positive and negative going pulses

Parameters:

<Polarity> POSitive | NEGative | EITHer
 *RST: POSitive

TRIGger:RUNT:RANGe <Condition>

Defines an additional time limit of the runt pulse.

Parameters:

<Condition> ANY | LONGer | SHORter | EQUal | NEQual | WITHin | OUTSide

ANY

Triggers on all runts fulfilling the level condition, without time limitation.

LONGer | SHORter

Defines a minimum time during which the signals match the pattern definition. The minimum time is defined by

EQUal | NEQual

Triggers on pulses equal or not equal a given runt width that is set using [TRIGger:RUNT:WIDTh](#). In addition, a tolerance can be set around the specified width using [TRIGger:RUNT:DELTA](#).

WITHin | OUTSide

Triggers on pulses inside or outside a given range. The range is set using ... and

*RST: LONGer

TRIGger:RUNT:WIDTh <Duration>

Sets the width for comparison ranges EQUal, UNEQual, SHORter, and LONGer.

See [TRIGger:WIDTh:RANGe](#).

Parameters:

<Duration> Range: 800E-12 to 10000
 Increment: 100E-9
 *RST: 5E-9
 Default unit: s

TRIGger:RUNT:DELTA <Tolerance>

Sets a range Δt to the specified width, which is defined using [TRIGger:RUNT:WIDTH](#).

Parameters:

<Tolerance> Range: 0 to 5000
 Increment: 500E-12
 *RST: 0
 Default unit: s

TRIGger:RUNT:MAXWidth <MaxDuration>

Sets the upper time limit of the runt for comparisons WITHin and OUTSide.

Parameters:

<MaxDuration> Range: 800E-12 to 10000
 Increment: 100E-9
 *RST: 5E-9
 Default unit: s

TRIGger:RUNT:MINWidth <MinDuration>

Sets the lower time limit of the runt for comparisons WITHin and OUTSide.

Parameters:

<MinDuration> Range: 800E-12 to 10000
 Increment: 100E-9
 *RST: 5E-9
 Default unit: s

TRIGger:RUNT:MAXWidth <MaxDuration>

Sets the upper time limit of the runt for comparisons WITHin and OUTSide.

Parameters:

<MaxDuration> Range: 800E-12 to 10000
 Increment: 100E-9
 *RST: 5E-9
 Default unit: s

12.3.5.10 Slew Rate Trigger (R&S RTH-K19)

See also [Chapter 2.5.10, "Slew Rate Trigger \(R&S RTH-K19\)"](#), on page 67.

TRIGger:LEVel<m>:SLEW:LOWer.....	214
TRIGger:LEVel<m>:SLEW:UPPer.....	214
TRIGger:SLEW:SLOPe.....	214
TRIGger:SLEW:RANGe.....	214
TRIGger:SLEW:RATE.....	215
TRIGger:SLEW:DELTA.....	215
TRIGger:SLEW:MINWidth.....	215
TRIGger:SLEW:MAXWidth.....	216

TRIGger:LEVel<m>:SLEW:LOWer <Level>
TRIGger:LEVel<m>:SLEW:UPPer <Level>

Set the upper and lower voltage thresholds, respectively. The time measurement starts when the signal crosses the first trigger level - the upper or lower level depending on the selected slope - and stops when the signal crosses the second level.

Suffix:

<m>	1..23
	1..4: Indicates the trigger source: analog channel 1 to 4
	5..22: not available

Parameters:

<Level>	Range: -10 to 10
	Increment: 1E-3
	*RST: 0
	Default unit: V

TRIGger:SLEW:SLOPe <Slope>

Sets the edge direction for the trigger.

Parameters:

<Slope>	POSitive NEGative EITHER
	*RST: POSitive

TRIGger:SLEW:RANGe <Condition>

Defines the time limits of the slew rate.

Parameters:

<Condition> LONGer | SHORter | EQUal | NEQual | WITHin | OUTSide

LONGer | SHORter
Triggers on pulses shorter or longer than a runt width that is set using [TRIGger:SLEW:RATE](#).

EQUal | NEQual
Triggers on pulses equal or not equal a given runt width that is set using [TRIGger:SLEW:RATE](#). In addition, a tolerance can be set around the specified width using [TRIGger:RUNT:DELTA](#).

WITHin | OUTSide
Triggers on pulses inside or outside a given range. The range is set using ... and

*RST: LONGer

TRIGger:SLEW:RATE <Duration>

Sets the slew rate for comparison ranges EQUal, UNEQual, SHORter, and LONGer.

See [TRIGger:SLEW:RANGe](#).

Parameters:

<Duration> Range: 800E-12 to 10000
Increment: 100E-9
*RST: 5E-9
Default unit: s

TRIGger:SLEW:DELTA <Tolerance>

Sets a range Δt to the specified slew rate, which is defined using [TRIGger:SLEW:RATE](#).

Parameters:

<Tolerance> Range: 0 to 5000
Increment: 500E-12
*RST: 0
Default unit: s

TRIGger:SLEW:MINWidth <MinDuration>

Sets the lower time limit of the transition time for comparisons WITHin and OUTSide.

Parameters:

<MinDuration> Range: 800E-12 to 10000
Increment: 100E-9
*RST: 5E-9
Default unit: s

TRIGger:SLEW:MAXWidth <MaxDuration>

Sets the upper time limit of the transition time for comparisons WITHin and OUTSide.

Parameters:

<MaxDuration> Range: 800E-12 to 10000
 Increment: 100E-9
 *RST: 5E-9
 Default unit: s

12.3.5.11 Data2Clock Trigger (R&S RTH-K19)

See also [Chapter 2.5.11, "Data2Clock Trigger \(R&S RTH-K19\)"](#), on page 69.

TRIGger:DATatoclock:DSOURCE[:VALue].....	216
TRIGger:DATatoclock:CSOURCE[:VALue].....	216
TRIGger:DATatoclock:CSOURCE:EDGE.....	216
TRIGger:DATatoclock:CONDition.....	216
TRIGger:DATatoclock:HTIME.....	217
TRIGger:DATatoclock:STIME.....	217

TRIGger:DATatoclock:DSOURCE[:VALue] <Source>

Selects the input channel of the data signal.

Parameters:

<Source> C1 | C2 | C3 | C4 | D0 | D1 | D2 | D3 | D4 | D5 | D6 | D7
 *RST: C1

TRIGger:DATatoclock:CSOURCE[:VALue] <Source>

Selects the input channel of the clock signal.

Parameters:

<Source> C1 | C2 | C3 | C4 | D0 | D1 | D2 | D3 | D4 | D5 | D6 | D7
 *RST: C1

TRIGger:DATatoclock:CSOURCE:EDGE <Slope>

Sets the edge of the clock signal: rising (POSitive), falling (NEGative), or both edges (EITHer). The time reference point for the setup and hold time is the crossing point of the clock edge and the trigger level.

Parameters:

<Slope> POSitive | NEGative | EITHer
 *RST: POSitive

TRIGger:DATatoclock:CONDition <TrigCondition>

Selects how a violation of the setup and hold time is handled.

Parameters:

<TrigCondition> VIOLation | OK

VIOLation
Triggers on a violation of the setup or hold time

OK
Triggers if setup and hold time keep the limits.

*RST: VIOLation

TRIGger:DATatoclock:HTIME <HoldTime>

Sets the minimum time after the clock edge while the data signal must stay steady.

The hold time can be negative. In this case, the setup time has to be positive. The setup time is defined by [TRIGger:DATatoclock:STIME](#).

Parameters:

<HoldTime> Range: -124E-9 to 124E-9
Increment: 1E-9
*RST: 1E-9
Default unit: s

TRIGger:DATatoclock:STIME <SetupTime>

Sets the minimum time before the clock edge while the data signal must stay steady.

The setup time can be negative. In this case, the hold time has to be positive. The setup time is defined by [TRIGger:DATatoclock:HTIME](#).

Parameters:

<SetupTime> Range: -124E-9 to 124E-9
Increment: 1E-9
*RST: 1E-9
Default unit: s

12.3.5.12 Serial Pattern Trigger (R&S RTH-K19)

TRIGger:SPATtern:DSource[:VALue]	217
TRIGger:SPATtern:CSource[:VALue]	218
TRIGger:SPATtern:CSource:EDGE	218
TRIGger:SPATtern:CSource:FIRStedge	218
TRIGger:SPATtern:ORDer	218
TRIGger:SPATtern:PATtern	218

TRIGger:SPATtern:DSource[:VALue] <Source>

Selects the input channel of the data signal.

Parameters:

<Source> C1 | C2 | C3 | C4 | D0 | D1 | D2 | D3 | D4 | D5 | D6 | D7
*RST: C1

TRIGger:SPATtern:CSource[:VALue] <Source>

Sets the input channel of the clock signal.

Parameters:

<Source> C1 | C2 | C3 | C4 | D0 | D1 | D2 | D3 | D4 | D5 | D6 | D7
*RST: C1

TRIGger:SPATtern:CSource:EDGE <Slope>

Sets the edge at which the data value is sampled.

Parameters:

<Slope> POSitive | NEGative | EITHer
POSitive
Rising edge
NEGative
Falling edge
EITHer
Rising and falling edges are considered (double data rate).
At double data rate, the edge at which the first bit of the pattern is sampled is defined by [TRIGger:SPATtern:CSource:FIRStedge](#).
*RST: POSitive

TRIGger:SPATtern:CSource:FIRStedge <FirstClockEdge>

Sets the edge at which the first bit of the pattern is sampled.

The command is required if [TRIGger:SPATtern:CSource:EDGE](#) is set to `Either` (double data rate).

Parameters:

<FirstClockEdge> POSitive | NEGative | EITHer
*RST: POSitive

TRIGger:SPATtern:ORDER <BitOrder>

Defines if the data words start with MSBF (most significant bit first) or LSBF (least significant bit first).

Parameters:

<BitOrder> LSBF | MSBF
*RST: MSBF

TRIGger:SPATtern:PATtern <Pattern>

Defines the serial pattern to be triggered on.

Parameters:

<Pattern> String that contains the pattern in binary format. The parameter accepts the bit value X (don't care).

Example:

```
TRIGger:SPATtern:PATtern '11001100'
```

```
TRIGger:SPATtern:PATtern '110011XX'
```

12.3.5.13 Timeout Trigger (R&S RTH-K19)

TRIGger:TIMEout:RANGe.....	219
TRIGger:TIMEout:TIME.....	219

TRIGger:TIMEout:RANGe <TimeoutMode>

Selects the relation of the signal level to the trigger level, which is specified with `TRIGger:LEVel<m>:VALue`

Parameters:

<TimeoutMode> HIGH | LOW | EITHer
*RST: HIGH

TRIGger:TIMEout:TIME <Time>

Sets the time limit for the timeout at which the instrument triggers.

Parameters:

<Time> Range: 100E-12 to 10000
Increment: 100E-9
*RST: 5E-9
Default unit: s

12.3.5.14 Interval Trigger (R&S RTH-K19)

TRIGger:INTerval:SLOPe.....	219
TRIGger:INTerval:RANGe.....	220
TRIGger:INTerval:WIDTh.....	220
TRIGger:INTerval:DELTA.....	220
TRIGger:INTerval:MINWidth.....	220
TRIGger:INTerval:MAXWidth.....	221

TRIGger:INTerval:SLOPe <Slope>

Sets the edge direction for the trigger. You can analyze the interval between positive edges or between negative edges.

Parameters:

<Slope> POSitive | NEGative
*RST: POSitive

TRIGger:INTerval:RANGe <Condition>

Defines how the time range of an interval is defined.

Parameters:

<Condition> LONGer | SHORter | EQUal | NEQual | WITHin | OUTSide

LONGer | SHORter

Triggers on intervals shorter or longer than an interval that is set using [TRIGger:INTerval:WIDTh](#).

EQUal | NEQual

Triggers on intervals equal or not equal a given interval width that is set using [TRIGger:INTerval:WIDTh](#). In addition, a tolerance can be set around the specified width using [TRIGger:INTerval:DELTA](#).

WITHin | OUTSide

Triggers on intervals inside or outside a given range. The range is set using ... and

*RST: LONGer

TRIGger:INTerval:WIDTh <Duration>

Sets the time between two pulses for comparisons EQUal, UNEQual, SHORter, and LONGer.

Parameters:

<Duration> Range: 800E-12 to 10000
Increment: 100E-9
*RST: 5E-9
Default unit: s

TRIGger:INTerval:DELTA <Tolerance>

Sets a range Δt to the specified width, which is defined using [TRIGger:INTerval:WIDTh](#). The command is relevant for comparisons EQUal and UNEQual.

Parameters:

<Tolerance> Range: 0 to 5000
Increment: 500E-12
*RST: 0
Default unit: s

TRIGger:INTerval:MINWidth <MinDuration>

Sets the lower time limit of the interval for comparisons WITHin and OUTSide.

Parameters:

<MinDuration> Range: 800E-12 to 10000
 Increment: 100E-9
 *RST: 5E-9
 Default unit: s

TRIGger:INTerval:MAXWidth <MaxDuration>

Sets the upper time limit of the interval for comparisons WITHin and OUTSide.

Parameters:

<MaxDuration> Range: 800E-12 to 10000
 Increment: 100E-9
 *RST: 5E-9
 Default unit: s

12.3.5.15 Window Trigger (R&S RTH-K19)

TRIGger:LEVel<m>:WINDow:LOWer.....	221
TRIGger:LEVel<m>:WINDow:UPPer.....	221
TRIGger:WINDow:TIME.....	221
TRIGger:WINDow:RANGe.....	222
TRIGger:WINDow:WIDTh.....	222
TRIGger:WINDow:DELTA.....	223
TRIGger:WINDow:MINWidth.....	223
TRIGger:WINDow:MAXWidth.....	223

TRIGger:LEVel<m>:WINDow:LOWer <Level>**TRIGger:LEVel<m>:WINDow:UPPer** <Level>

Set the upper and lower voltage thresholds for the window trigger, respectively. The trigger levels are the vertical window limits.

Suffix:

<m> 1..23
 1..4: Indicates the trigger source: analog channel 1 to 4
 5..22: not available

Parameters:

<Level> Range: -10 to 10
 Increment: 1E-3
 *RST: 0
 Default unit: V

TRIGger:WINDow:TIME <Condition>

Selects how the time limit of the window is defined.

Parameters:

<Condition>

LONGer | SHORter | EQUal | NEQual | WITHin | OUTSide

LONGer | SHORterTriggers if the signal crosses the upper or lower level after/before the time "Width" defined by `TRIGger:WINDow:WIDTh`**EQUal | NEQual**Triggers if the signal stays inside or outside the vertical window limits for a time equal/unequal to "Width" "±Tolerance" defined by `TRIGger:WINDow:WIDTh` and `TRIGger:WINDow:DELTA`.**WITHin**Triggers if the signal stays inside or outside the vertical window limits for a time \geq "Min Width" AND \leq "Max Width".**OUTSide**Triggers if the signal stays inside or outside the vertical window limits for a time $<$ "Min Width" OR $>$ "Max Width".

*RST: LONGer

TRIGger:WINDow:RANGe <LevelRangeMode>

Selects how the signal run is compared with the window:

Parameters:

<LevelRangeMode>

ENTer | EXIT | WITHin | OUTSide

ENTer | EXITTriggers when the signal crosses the upper or lower level and thus enters/leaves the window made up of these two levels which are defined by `TRIGger:LEVel<m>:WINDow:UPPer` and `TRIGger:LEVel<m>:WINDow:LOWer`**WITHin | OUTSide**Triggers if the signal stays between/above the upper and lower level for a specified time. The time is defined by `TRIGger:WINDow:TIME`

*RST: ENTer

TRIGger:WINDow:WIDTh <Duration>

Sets the width for comparison ranges LONGer, SHORter, EQUal, NEQual.

See `TRIGger:WINDow:TIME` on page 221.**Parameters:**

<Duration>

Range: 800E-12 to 10000

Increment: 100E-9

*RST: 5E-9

Default unit: s

TRIGger:WINDow:DELTA <Tolerance>

Sets a range Δt to the specified width, which is defined using [TRIGger:WINDow:WIDTh](#).

Parameters:

<Tolerance> Range: 0 to 5000
 Increment: 500E-12
 *RST: 0
 Default unit: s

TRIGger:WINDow:MINWidth <MinDuration>

Sets the lower time limit of the stay inside or outside the window (comparisons WITHin and OUTSide).

Parameters:

<MinDuration> Range: 800E-12 to 10000
 Increment: 100E-9
 *RST: 5E-9
 Default unit: s

TRIGger:WINDow:MAXWidth <MaxDuration>

Sets the upper time limit of the stay inside or outside the window (comparisons WITHin and OUTSide).

Parameters:

<MaxDuration> Range: 800E-12 to 10000
 Increment: 100E-9
 *RST: 5E-9
 Default unit: s

12.4 Waveform Analysis

12.4.1 Zoom

See also [Chapter 3.1, "Zoom"](#), on page 77.

ZOOM:ENABle	223
ZOOM:SCALe	224
ZOOM:POSition	224

ZOOM:ENABle <Enabled>

Enables or disables the zoom.

Parameters:

<Enabled> ON | OFF
 *RST: OFF

ZOOM:SCALE <Scale>

Sets the time scale of the zoomed waveform.

Depending on the recording time not all horizontal scales are available. This is due to the fact that, the zoom is always displaying a complete curve.

Parameters:

<Scale> Range: 1E-12 to 500
 Increment: 1E-12
 *RST: 100E-9
 Default unit: s

ZOOM:POSition <Position>

Sets the center position of the zoomed area in relation to the trigger point.

Parameters:

<Position> Range: -500 to 500
 Increment: 1E-12
 *RST: 0
 Default unit: s

12.4.2 Automatic Measurements

In remote commands for automatic measurements, the suffix <m> defines the measurement index. You can perform up to four different measurements simultaneously.

- [Measurement Settings](#)..... 224
- [Measurement Results](#)..... 226

12.4.2.1 Measurement Settings

MEASurement<m>:ENABLE	224
MEASurement<m>:SOURce	225
MEASurement<m>:TYPE	225
MEASurement<m>:AOFF	226
MEASurement<m>:DELay:SLOPe	226

MEASurement<m>:ENABLE <State>

Enables or disables the measurement.

Suffix:

<m> 1..4

Parameters:

<State> ON | OFF
 *RST: OFF

MEASurement<m>:SOURce <Source>, [<Source2>]

Defines the waveform to be measured. For delay, phase, and power measurements, 2 sources are required.

The sources can be any active input signal, math or reference waveform. Available source waveforms depend on the measurement type, see [Chapter 3.2.3, "Measurement Types"](#), on page 80.

Suffix:

<m> 1..4

Parameters:

<Source> C1 | C2 | C3 | C4 | M1 | R | D0 | D1 | D2 | D3 | D4 | D5 | D6 | D7

<Source2> C1 | C2 | C3 | C4 | M1 | R | D0 | D1 | D2 | D3 | D4 | D5 | D6 | D7

MEASurement<m>:TYPE <Type>

Selects the measurement type. For a detailed description, see [Chapter 3.2.3, "Measurement Types"](#), on page 80.

Suffix:

<m> 1..4

Parameters:

<Type> PERiod | FREQuency | RTIME | FTIME | PPULse | NPULse | PDCYcle | NDCYcle | DELay | PHASe | MEAN | RMS | CREST | STDDev | MINimum | MAXimum | PKPK | BASelevel | TOPLevel | AMPLitude | OVRShoot | PREShoot | AC | DC | ACDC | PPCount | NPCount | RECount | FECount | PWRP | PWRS | PWRQ | PWRFactor

*RST: MINimum

RTIME	Rise time	PREShoot	Preshoot
FTIME	Fall time	PPCount	Positive pulse count
PPULse	Positive pulse width	NPCount	Negative pulse count
NPULse	Negative pulse width	RECount	Rising edge count
PDCYcle	Positive duty cycle	FECount	Falling edge count
NDCYcle	Negative duty cycle	PWRP	Active power
STDDev	Standard deviation	PWRS	Apparent power
PKPK	Peak to peak	PWRQ	Reactive power
OVRShoot	Overshoot	PWRFactor	Power factor

MEASurement<m>:AOFF

Disables all active measurements.

Suffix:

<m> 1..4
The suffix is irrelevant.

Usage: Event

MEASurement<m>:DELay:SLOPe <Slope>

Sets the slope for the delay measurement type.

Suffix:

<m> 1..4

Parameters:

<Slope> POSitive | NEGative | EITHer

POSitive

Delay between the first rising edge of each source waveform.

NEGative

Delay between the first falling edge of each source waveform.

EITHer

Delay between the first edge of each source waveform, no matter if it is rising or falling.

*RST: POSitive

12.4.2.2 Measurement Results

MEASurement<m>:RESult:ACTual?

Returns the result of the indicated measurement.

Suffix:

<m> 1..4

Return values:

<Result> Range: -100E+24 to 100E+24
Increment: 100E-12
*RST: 0

Usage: Query only

MEASurement<m>:RESult:LIMit?

Indicates whether the measurement results are inside the measurement range, or outside (clipping).

Suffix:

<m> 1..4

Return values:

<ResultLimit> INSide | OVERflow | UNDerflow | OVUNflow
 *RST: INSide

Usage: Query only

12.4.3 Cursor Measurements

- [Cursor Settings](#)..... 227
- [Cursor Measurement Results](#)..... 228

12.4.3.1 Cursor Settings

CURSor:STATe	227
CURSor:FUNCTion	227
CURSor:SOURce	227
CURSor:COUPLing	228
CURSor:SCPLing	228
CURSor:SCReen	228
CURSor:MEASurement<m>:TYPE	228

CURSor:STATe <State>

Enables or disables the cursor measurement.

Parameters:

<State> ON | OFF
 *RST: OFF

CURSor:FUNCTion <Type>

Defines the type of the cursor measurement.

Parameters:

<Type> VERTical | HORizontal | TRACking | MEASure
 See [Chapter 3.3.2, "Cursor Types and Results"](#), on page 86.
 *RST: VERTical

CURSor:SOURce <Source>

Defines the source on which the cursor measurement is performed. The source setting is not relevant for the vertical cursor type.

Parameters:

<Source> C1 | C2 | C3 | C4 | M1 | D0 | D1 | D2 | D3 | D4 | D5 | D6 | D7
 *RST: C1

CURSor:COUPling <Coupling>

Couples the cursor lines so that the distance between the two lines remains the same if one cursor is moved.

Parameters:

<Coupling> ON | OFF
*RST: OFF

CURSor:SCPLing <ScaleCoupling>

If ON, the position of the cursor lines is adjusted if the vertical or horizontal scales are changed. If OFF, the cursor lines remain on their position on the display if the scaling is changed.

Parameters:

<ScaleCoupling> ON | OFF
*RST: OFF

CURSor:SCReen

Sets the cursors to a default position on the screen.

Usage: Event

CURSor:MEASurement<m>:TYPE <Type>

Sets the automatic measurements to be performed on the source waveform between the cursor lines. The setting is only available if **CURSor:FUNction** is set to **MEASure**.

Suffix:

<m> 1..2
Defines the measurement index. Two simultaneous cursor measurements can be performed.

Parameters:

<Type> PERiod | FREQuency | RTIME | FTIME | PPULse | NPULse |
PDCYcle | NDCYcle | MEAN | RMS | CRESst | STDDev |
MINimum | MAXimum | PKPK | BASelevel | TOPLevel |
AMPLitude | OVRShoot | PRESshoot | AC | DC | ACDC |
PPCount | NPCount | RECount | FECount
See **MEASurement<m>:TYPE** on page 225.
*RST: MINimum

12.4.3.2 Cursor Measurement Results

CURSor:TDELta?	229
CURSor:ITDelta?	229
CURSor:X1Position	229

CURSor:X2Position.....	229
CURSor:DELTA?.....	229
CURSor:Y1Position.....	230
CURSor:Y2Position.....	230
CURSor:Y1Amplitude?.....	230
CURSor:Y2Amplitude?.....	230
CURSor:MEASurement<m>:RESult:ACTual?.....	230
CURSor:MEASurement<m>:RESult:LIMit?.....	230

CURSor:TDELTA?

Returns the time difference Δ between to vertical cursor lines.

Return values:

<ResultDeltaT> Range: -100E+24 to 100E+24
 *RST: 0

Usage: Query only

CURSor:ITDELTA?

Returns the inverse value of time difference between to vertical cursor lines $1/\Delta t$.

Return values:

<ResultDeltaTInv> Range: -100E+24 to 100E+24
 Increment: 0
 *RST: 0

Usage: Query only

CURSor:X1Position <UserX1>

CURSor:X2Position <UserX2>

Set the horizontal positions t1 and t2 (time) of the vertical cursor lines.

Parameters:

<UserX1>, <UserX2> Range: -100E+24 to 100E+24
 Increment: 100E-12
 *RST: 0
 Default unit: s

CURSor:DELTA?

Returns the absolute value of the difference between the positions of horizontal cursor lines Δy .

Return values:

<ResultDelta> Range: -100E+24 to 100E+24
 *RST: 0

Usage: Query only

CURSor:Y1Position <UserY1>

CURSor:Y2Position <UserY2>

Set the vertical positions y1 and y2 of the horizontal cursor lines.

Parameters:

<UserY1>, <UserY2> Range: -100E+24 to 100E+24
 Increment: 100E-6
 *RST: 0
 Default unit: V

CURSor:Y1AMplitude?

CURSor:Y2AMplitude?

Return the vertical values of the crossing points between the tracking cursors and the source waveform.

Return values:

<ResultAmplitude1> Range: -100E+24 to 100E+24
 <ResultAmplitude2> *RST: 0

Usage: Query only

CURSor:MEASurement<m>:RESult:ACTual?

Returns the result of the indicated cursor measurement.

Suffix:

<m> 1..2
 Defines the measurement index. Two simultaneous cursor measurements can be performed.

Return values:

<Result> Range: -100E+24 to 100E+24
 Increment: 100E-12
 *RST: 0

Usage: Query only

CURSor:MEASurement<m>:RESult:LIMit?

Indicates whether the measurement results are inside the measurement range, or outside (clipping).

Suffix:

<m> 1..2
 Defines the measurement index. Two simultaneous cursor measurements can be performed.

Return values:

<ResultLimit> INSide | OVERflow | UNDerflow | OVUNflow
 *RST: INSide

Usage: Query only

12.4.4 Math Waveforms

12.4.4.1 Math Settings

CALCulate:MATH:STATe.....	231
CALCulate:MATH[:EXPRession][:DEFine].....	231
CALCulate:MATH:VERTical:SCALE.....	231
CALCulate:MATH:VERTical:RANGe.....	232
CALCulate:MATH:VERTical:POSition.....	232

CALCulate:MATH:STATe <State>

Enables or disables the math channel.

Parameters:

<State> ON | OFF

Usage: SCPI confirmed

CALCulate:MATH[:EXPRession][:DEFine] <ExprDefinition>

Sets the operation to calculate a math waveform.

Parameters:

<ExprDefinition> String that defines the operation. x is the channel number of source 1, y the channel number of source 2.
 Addition: 'Cx+Cy'
 Subtraction: 'Cx-Cy'
 Multiplication: 'Cx*Cy'
 Inverse: '-Cx'
 Absolute value: 'Abs(Cx)'
 Square: 'Pow(Cx)'

Example:

```
CALC:MATH:EXPR:DEF 'C1-C2'
```

Subtracts the values of CH2 from the values of CH1.

```
CALC:MATH:EXPR:DEF 'Pow(C1)'
```

Squares the values of CH1.

Usage: SCPI confirmed

CALCulate:MATH:VERTical:SCALE <Scale>

Sets the vertical scale (vertical sensitivity) of the math waveform.

Parameters:

<Scale> Scale value, in V/div.

Usage: SCPI confirmed

CALCulate:MATH:VERTical:RANGe <Position>

Sets the voltage range across the 8 vertical divisions of the diagram. Use the command alternatively to [CALCulate:MATH:VERTical:SCALE](#).

Parameters:

<Position> Voltage value of the range

Usage: SCPI confirmed

CALCulate:MATH:VERTical:POSition <Position>

Moves the math waveform or down in the diagram.

Parameters:

<Position> Position value, given in divisions.

Usage: SCPI confirmed

12.4.5 Reference Waveforms

REFCurve:SOURce	232
REFCurve:UPDate	232
REFCurve:STATe	232
REFCurve:POSition	233
REFCurve:NAME	233
REFCurve:SAVE	233
REFCurve:OPEN	233
REFCurve:DELeTe	233

REFCurve:SOURce <Source>

Selects the waveform to be taken as reference waveform.

Parameters:

<Source> C1 | C2 | C3 | C4 | M1
 *RST: C1

REFCurve:UPDate

Creates the reference waveform from the source waveform.

Usage: Event

REFCurve:STATe <State>

Activates or deactivates the reference waveform.

Parameters:

<State> ON | OFF

REFCurve:POSition <Position>

Sets the vertical position of the reference waveform.

Parameters:

<Position> Default unit: DIV

REFCurve:NAME <Name>

Defines the path, file name and file format of the reference waveform file.

The default path is C:/Users/<user>/Rohde-Schwarz/RTH/ReferenceCurves.

Parameters:

<Name> String

Example:

```
:REFCurve:NAME 'C:
/Users/user1/Rohde-Schwarz/RTH/ReferenceCurves/reference00
```

REFCurve:SAVE

Saves the reference waveform. The target file is specified using [REFCurve:NAME](#).

Usage: Event

REFCurve:OPEN

Loads a stored reference waveform from the specified file. The file is specified using [REFCurve:NAME](#).

Usage: Event

REFCurve:DELeTe

Deletes a stored reference waveform file. The file is specified using [REFCurve:NAME](#).

Usage: Event

12.4.6 History (Option R&S RTH-K15)

In `CHANnel:HISTory` commands, the channel suffix is irrelevant, omit it.

See also: [Chapter 3.7, "History \(Option R&S RTH-K15\)"](#), on page 96

CHANnel<m>:HISTory[:STATe]	234
CHANnel<m>:HISTory:NSEGments	234
CHANnel<m>:HISTory:TPACq	234
ACQUIRE:AVAILable?	234
CHANnel<m>:HISTory:START	234
CHANnel<m>:HISTory:STOP	235
CHANnel<m>:HISTory:CURRent	235

CHANnel<m>:HISTory:PLAY	235
CHANnel<m>:HISTory:REPLay	235
CHANnel<m>:HISTory:TSABsolute?	236
CHANnel<m>:HISTory:TSDate?	236
CHANnel<m>:HISTory:TSRelative?	236

CHANnel<m>:HISTory[:STATe] <State>

Enables or disables the history function.

Parameters:

<State> ON | OFF
 *RST: OFF

CHANnel<m>:HISTory:NSEGments <Depth>

Sets the approximate number of waveforms to be stored.

See also "[Number of Segments](#)" on page 97.

Parameters:

<Depth> LOW | MEDium | HIGH
 *RST: LOW

CHANnel<m>:HISTory:TPACq <PlayerSpeed>

Defines how fast the history player shows the stored waveforms.

Parameters:

<PlayerSpeed> AUTO | SLOW | MEDium | FAST
 *RST: AUTO

ACQuire:AVAILable?

Shows the number of segments that are stored in the history.

Return values:

<AvailableAcqs> Range: 0 to 5000
 Increment: 1
 *RST: 0

Usage: Query only

CHANnel<m>:HISTory:START <StartAcqIdx>

Sets the index of the first (older) history segment that you want to see in the history player. To query the number of available segments, use [ACQuire:AVAILable?](#).

Parameters:

<StartAcqIdx> Range: -4999 to 0
 Increment: 1
 *RST: 0

CHANnel<m>:HISTory:STOP <StopAcqIdx>

Sets the index of the last (newer) history segment that you want to see in the history player. To query the number of available segments, use [ACQUIRE:AVAILABLE?](#). The newest segment has always the index "0". Older segments have a negative index.

Parameters:

<StopAcqIdx> Range: -4999 to 0
 Increment: 1
 *RST: 0

Example:

```
CHANnel:START -199
CHANnel:STOP -100
```

The segments 101 (index -100) to 200 (index -199) in the history player.

CHANnel<m>:HISTory:CURRENT <CurrAcqIdx>

Accesses a particular segment in the memory to display it. The query returns the index of the segment that is shown.

To determine the number of stored segments, use [ACQUIRE:AVAILABLE?](#).

Parameters:

<CurrAcqIdx> History index: the newest segment has the index "0", older segments have a negative index: $-(n-1)$, ..., -1 , 0
 n is the number of acquired segments.

Range: 0 to $-(n-1)$
 Increment: 1
 *RST: 0

CHANnel<m>:HISTory:PLAY

Starts and stops the playback of the history segments.

Example:

```
CHANnel:HISTory:PLAY; *OPC
```

See also [Chapter B, "Command Sequence and Synchronization"](#), on page 317.

Usage:

Event
 Asynchronous command

CHANnel<m>:HISTory:REPLay <AutoRepeat>

If set to ON, the playback of the selected history segments repeats automatically.

Parameters:

<AutoRepeat> ON | OFF
 *RST: OFF

CHANnel<m>:HISTory:TSABsolute?

Returns the absolute daytime of the current segment ([CHANnel<m>:HISTory:CURRent](#)).

Return values:

<TimeStampAbsTime>String containing the time and unit.

Usage: Query only

CHANnel<m>:HISTory:TSDate?

Returns the date of the current segment ([CHANnel<m>:HISTory:CURRent](#)).

Return values:

<TimeStampAbsData>String with date of the current acquisition (absolute time)

Usage: Query only

CHANnel<m>:HISTory:TSRelative?

Returns the relative time of the current segment - the time difference to the newest segment (index = 0).

See also [CHANnel<m>:HISTory:CURRent](#).

Return values:

<TimeStampRel> String containing the relative time in seconds.

Usage: Query only

12.5 Mask Testing

12.5.1 Mask Definition

The suffix <m> selects the mask channel for which the command is executed. The number of channels depends on the instrument type. The R&S RTH1004 has 5 mask channels, the suffix values are 1 | 2 | 3 | 4 | 5. The R&S RTH1002 has 3 mask channels, the suffix values are 1 | 2 | 5. Suffix 5 is used for the mask on a math waveform.

MASK:CHANnel<m>:STATe	237
MASK:CHANnel<m>:PROPerties:XWIDth	237
MASK:CHANnel<m>:PROPerties:YWIDth	237
MASK:CHANnel<m>:CREatemask	237

MASK:CHANnel<m>:STATe <State>

Turns the selected mask on or off.

Suffix:

<m> 1|2|5 (RTH1002) , 1..5 (RTH1004)

Parameters:

<State> ON | OFF
*RST: OFF

MASK:CHANnel<m>:PROPerties:XWIDth <WidthX>

Changes the width of the selected mask in horizontal direction.

Suffix:

<m> 1|2|5 (RTH1002) , 1..5 (RTH1004)

Parameters:

<WidthX> Range: 0 to 10
Increment: 0.01
*RST: 0
Default unit: div

MASK:CHANnel<m>:PROPerties:YWIDth <WidthY>

Changes the width of the selected mask in vertical direction.

Suffix:

<m> 1|2|5 (RTH1002) , 1..5 (RTH1004)

Parameters:

<WidthY> Range: 0 to 8
Increment: 0.01
*RST: 0.1
Default unit: div

MASK:CHANnel<m>:CREatemask

Creates a mask from the envelope waveform of the selected waveform with the defined width in x and y direction.

Suffix:

<m> 1|2|5 (RTH1002) , 1..5 (RTH1004)

Usage: Event

12.5.2 Mask Test

MASK:ONViolation[:SElection].....	238
MASK:RST.....	238
MASK[:TESTstate]?	238
MASK:CHANnel<m>:RESult:FAIL:PERCentage?	238
MASK:CHANnel<m>:RESult:FAIL[:COUNt]?	239
MASK:CHANnel<m>:RESult:PASS:PERCentage?	239
MASK:CHANnel<m>:RESult:PASS[:COUNt]?	239
MASK:CHANnel<m>:RESult:TOTL[:COUNt]?	240
MASK:ELAPsedtime:TOTal?	240
MASK:ELAPsedtime[:SECS]?	240

MASK:ONViolation[:SElection] <SelectedActions>

Defines the action to be executed if a violation occurs.

Parameters:

<SelectedActions> NONE | STOP | BEEP | BPSTop
 *RST: NONE

MASK:RST

Sets the counters of passed and failed acquisitions to Zero.

Usage: Event

MASK[:TESTstate]?

Returns the state of the mask test.

Return values:

<TestState> NOMask | IDLE | RUNNing

NOMask
No mask is active and no testing possible.

IDLE
Mask test has been stopped or not yet started.

RUNNing
Test ist running.

*RST: NOMask

Usage: Query only

MASK:CHANnel<m>:RESult:FAIL:PERCentage?

Returns the percentage share of failed acquisitions.

Suffix:

<m> 1|2|5 (RTH1002) , 1..5 (RTH1004)

Return values:

<FailedPercentage> Range: 0 to 100
Increment: 0.1
*RST: 0
Default unit: %

Usage: Query only

MASK:CHANnel<m>:RESult:FAIL[:COUNT]?

Returns the number of failed acquisitions.

Suffix:

<m> 1|2|5 (RTH1002) , 1..5 (RTH1004)

Return values:

<FailedCount> Range: 0 to 0
Increment: 1
*RST: 0

Usage: Query only

MASK:CHANnel<m>:RESult:PASS:PERcentage?

Returns the percentage share of passed acquisitions.

Suffix:

<m> 1|2|5 (RTH1002) , 1..5 (RTH1004)

Return values:

<PassedPercentage> Range: 0 to 100
Increment: 0.1
*RST: 0
Default unit: %

Usage: Query only

MASK:CHANnel<m>:RESult:PASS[:COUNT]?

Returns the number of passed acquisitions.

Suffix:

<m> 1|2|5 (RTH1002) , 1..5 (RTH1004)

Return values:

<PassedCount> Range: 0 to 0
Increment: 1
*RST: 0

Usage: Query only

MASK:CHANnel<m>:RESult:TOTL[:COUNT]?

Returns the number of tested acquisitions.

Suffix:

<m> 1|2|5 (RTH1002) , 1..5 (RTH1004)

Return values:

<ResultTotal> Range: 0 to 0
Increment: 1
*RST: 0

Usage: Query only

MASK:ELAPsedtime:TOTal? <Day>, <Hour>, <Min>, <Sec>

Returns the test duration.

Query parameters:

<Day> Test time in days.
<Hour> Test time in hours.
<Min> Test time in minutes.
<Sec> Test time in seconds.

Return values:

<ZSec> Test time in deciseconds.

Usage: Query only

MASK:ELAPsedtime[:SECS]?

Returns the test duration in seconds.

Return values:

<Sec> Time in seconds

Usage: Query only

12.6 Digital Multimeter (R&S RTH1002)

- [Activating the Multimeter mode](#).....241
- [Measurement Configuration](#).....241
- [Relative Measurements](#)..... 248
- [Measurement Control](#).....251
- [Results](#)..... 252

12.6.1 Activating the Multimeter mode

To activate the DMM, use `OP METer`.

OP[:MODE] <OperationMode>

Sets the operating mode of the instrument.

Parameters:

<OperationMode> YT | XY | MASK | METer | LOGGer

*RST: YT (scope mode)

12.6.2 Measurement Configuration

The instrument sets most configuration settings automatically. For most measurement types, the measurement range is the only parameter that can be set. For temperature measurements, specific settings are required.

The instrument can adjust the measurement range if autoranging is configured for a measurement. Otherwise, you can set a fixed measurement range.

To set a fixed measurement range, you can use several commands:

- `METer:CONFigure:<function>`
Configures the specified measurement including the measurement range.
See [Chapter 12.6.2.1, "METer:CONFigure Commands"](#), on page 242.
- `METer:SENSe:<function>:RANGe:UPPer`
Sets the measurement range and turns off autoranging.
See [Chapter 12.6.2.2, "METer:SENSe:<function>:RANGe:UPPER Commands"](#), on page 244.
- `METer:MEASure:<function>`
Configures the specified measurement including the measurement range, starts the measurement, and returns the result.

To enable autoranging, you can use the following commands:

- `METer:SENSe:<function>:RANGe:AUTO`
Enables or disables the autoranging. See [Chapter 12.6.2.3, "METer:SENSe:<function>:RANGe:AUTO Commands"](#), on page 246.
- `METer:CONFigure:<function> 'AUTO'`
See [Chapter 12.6.2.1, "METer:CONFigure Commands"](#), on page 242.

The configuration commands are described in the following chapters:

- [METer:CONFigure Commands](#).....242
- [METer:SENSe:<function>:RANGe:UPPER Commands](#).....244
- [METer:SENSe:<function>:RANGe:AUTO Commands](#).....246
- [AC+DC Current and Voltage Measurements](#).....247
- [Temperature Measurements](#).....248

12.6.2.1 METer:CONFigure Commands

METer:CONFigure:<function> commands set all internal measurement parameters for the specified measurement. For most measurements, it also sets the measurement range.

To set the range to minimum, maximum, or default value, use the following parameters:

- METer:CONFigure:<function> MIN
- METer:CONFigure:<function> MAX
- METer:CONFigure:<function> DEF

For some measurements, you can also set the auto range:

METer:CONFigure:<function> 'AUTO'. Note that 'AUTO' is a string parameter. Alternatively, you can use the METer:SENSe:<function>:RANGe:AUTO commands.

The METer:CONFigure:<function> commands are only for configuration. To activate a measurement, use METer:SENSe:FUNCTION.

METer:CONFigure:VALue? returns the active measurement and range.

To read the result, use METer<m>:READ? or METer<m>:FETCh?.

METer:CONFigure:CONTInuity.....	242
METer:CONFigure:DIODE.....	242
METer:CONFigure:TEMPerature.....	242
METer:CONFigure:CAPacitance.....	242
METer:CONFigure:CURRent:AC.....	243
METer:CONFigure:CURRent:DC.....	243
METer:CONFigure:FREQuency.....	243
METer:CONFigure:RESistance.....	243
METer:CONFigure:VOLTage:AC.....	244
METer:CONFigure:VOLTage:DC.....	244

METer:CONFigure:CONTInuity

METer:CONFigure:DIODE

METer:CONFigure:TEMPerature

Configures the specified measurement. The instrument sets a fixed range.

Usage: Event

METer:CONFigure:CAPacitance

Sets the internal parameters and configures the range for capacitance measurements.

Parameters:

<Range>

<numeric value> | 'AUTO' | MIN | MAX | DEF

<numeric value>

The instrument has fixed measurement ranges: 10 nF|100 nF|
1 µF|10 µF|100 µF|1 mF|10 mF.

You can enter any value between the minimum and maximum value. The instrument uses the next suitable range.

Range: 10 nF to 10 mF

*RST: 10 nF

Usage:

Setting only

METer:CONFigure:CURRENT:AC**METer:CONFigure:CURRENT:DC**

Sets the internal parameters and configures the range for current measurements.

You need an external shunt resistor or I/U converter for current measurement.

Parameters:

<Range>

<numeric value> | 'AUTO' | MIN | MAX | DEF

<numeric value>

The instrument has fixed measurement ranges: 1 A|10 A|100 A|
1 kA.

You can enter any value between the minimum and maximum value. The instrument uses the next suitable range.

Range: 1 to 1000

*RST: 1

Default unit: A

Usage:

Setting only

METer:CONFigure:FREQuency

Configures the frequency measurement and sets voltage autoranging.

To set a fixed voltage range, use [METer:SENSe:FREQuency:VOLTage:RANGe:UPPer](#).

Usage:

Event

METer:CONFigure:RESistance

Sets the internal parameters and configures the range for resistance measurements.

Parameters:

<Range> <numeric value> | 'AUTO' | MIN | MAX | DEF

<numeric value>

The instrument has fixed measurement ranges: 1 k Ω |10 k Ω |100 k Ω |1 M Ω |10 M Ω |100 M Ω .

You can enter any value between the minimum and maximum value. The instrument sets the next suitable range.

Range: 1 kOhm to 100 MOhm

*RST: AUTO

Usage:

Setting only

METer:CONFigure:VOLTagE:AC**METer:CONFigure:VOLTagE:DC**

Sets the internal parameters and configures the range for voltage measurements.

Parameters:

<Range> <numeric value> | 'AUTO' | MIN | MAX | DEF

<numeric value>

The instrument has fixed measurement ranges: 1 V|10 V|100 V|1 kV.

You can enter any value between the minimum and maximum value. The instrument uses the next suitable range.

Range: 1 to 1000

*RST: 1

Default unit: V

Usage:

Setting only

12.6.2.2 METer:SENSE:<function>:RANGE:UPPER Commands

METer:SENSE:<function>:RANGE:UPPER commands set the measurement range and turn off autoranging. You can use these commands in addition to METer:CONFigure commands if you want to change only the range.

METer:SENSE:CAPacitance:RANGE:UPPer.....	244
METer:SENSE:CURRent:AC:RANGE:UPPer.....	245
METer:SENSE:CURRent:DC:RANGE:UPPer.....	245
METer:SENSE:FREQuency:VOLTagE:RANGE:UPPer.....	245
METer:SENSE:RESistance:RANGE:UPPer.....	245
METer:SENSE:VOLTagE:AC:RANGE:UPPer.....	246
METer:SENSE:VOLTagE:DC:RANGE:UPPer.....	246

METer:SENSE:CAPacitance:RANGE:UPPer <Range>

Sets a fixed range for capacitance measurements and turns off auto ranging.

Parameters:

<Range> <numeric value> | MIN | MAX | DEF

<numeric value>

The instrument has fixed measurement ranges: 10 nF|100 nF|
1 µF|10 µF|100 µF|1 mF|10 mF.

You can enter any value between the minimum and maximum value. The instrument uses the next suitable range.

Range: 10 nF to 10 mF

*RST: 10 nF

METer:SENSe:CURRent:AC:RANGe:UPPer <Range>

METer:SENSe:CURRent:DC:RANGe:UPPer <Range>

Sets a fixed current range and turns off auto ranging.

Parameters:

<Range> <numeric value> | MIN | MAX | DEF

<numeric value>

The instrument has fixed measurement ranges: 1 A|10 A|100 A|
1 kA.

You can enter any value between the minimum and maximum value. The instrument uses the next suitable range.

Range: 1 to 1000

*RST: 1

Default unit: A

METer:SENSe:FREQuency:VOLTage:RANGe:UPPer <Range>

Sets a fixed voltage range for frequency measurements and turns off auto ranging.

Parameters:

<Range> <numeric value> | MIN | MAX | DEF

<numeric value>

The instrument has fixed measurement ranges: 1 V|10 V|100 V|
1 kV.

You can enter any value between the minimum and maximum value. The instrument uses the next suitable range.

Range: 1 to 1000

*RST: 1

Default unit: V

METer:SENSe:RESistance:RANGe:UPPer <Range>

Sets a fixed range for resistance measurements and turns off auto ranging.

Parameters:

<Range> <numeric value> | MIN | MAX | DEF

<numeric value>

The instrument has fixed measurement ranges: 1 kΩ|10 kΩ|
100 kΩ|1 MΩ|10 MΩ|100 MΩ.

You can enter any value between the minimum and maximum value. The instrument sets the next suitable range.

Range: 1 kOhm to 100 MOhm

*RST: 1 kOhm

METer:SENSe:VOLTage:AC:RANGe:UPPer <Range>

METer:SENSe:VOLTage:DC:RANGe:UPPer <Range>

Sets a fixed voltage range and turns off auto ranging.

Parameters:

<Range> <numeric value> | MIN | MAX | DEF

<numeric value>

The instrument has fixed measurement ranges: 1 V|10 V|100 V|
1 kV.

You can enter any value between the minimum and maximum value. The instrument uses the next suitable range.

Range: 1 to 1000

*RST: 1

Default unit: V

12.6.2.3 METer:SENSe:<function>:RANGe:AUTO Commands

METer:SENSe:<function>:RANGe:AUTO commands turn autoranging on or off. For some measurements, you can also use the METer:CONFigure:<function> command, see [Chapter 12.6.2.1, "METer:CONFigure Commands"](#), on page 242.

METer:SENSe:CAPacitance:RANGe:AUTO.....	246
METer:SENSe:CURRent:AC:RANGe:AUTO.....	246
METer:SENSe:CURRent:DC:RANGe:AUTO.....	246
METer:SENSe:FREQuency:VOLTage:RANGe:AUTO.....	246
METer:SENSe:RESistance:RANGe:AUTO.....	246
METer:SENSe:VOLTage:AC:RANGe:AUTO.....	246
METer:SENSe:VOLTage:DC:RANGe:AUTO.....	246

METer:SENSe:CAPacitance:RANGe:AUTO <State>

METer:SENSe:CURRent:AC:RANGe:AUTO <State>

METer:SENSe:CURRent:DC:RANGe:AUTO <State>

METer:SENSe:FREQuency:VOLTage:RANGe:AUTO <State>

METer:SENSe:RESistance:RANGe:AUTO <State>

METer:SENSe:VOLTage:AC:RANGe:AUTO <State>

METer:SENSe:VOLTage:DC:RANGe:AUTO <State>

Disables or enables the autoranging for the specified measurement.

The query always returns OFF or ON.

Parameters:

<State> OFF | ON | ONCE

OFF | ON

0 | 1 are not supported.

ONCE

Performs an immediate autorange and then turns off the auto-ranging.

Example:

```
METer:SENSe:VOLTage:DC:RANGe:AUTO ONCE
```

```
METer:SENSe:VOLTage:DC:RANGe:AUTO?
```

```
<-- OFF
```

12.6.2.4 AC+DC Current and Voltage Measurements

METer<m>:SENSe:CURRent:AC:COUPling..... 247

METer<m>:SENSe:VOLTage:AC:COUPling..... 247

METer<m>:SENSe:CURRent:AC:COUPling <Coupling>

METer<m>:SENSe:VOLTage:AC:COUPling <Coupling>

Enables AC+DC measurements.

Suffix:

<m> 1..4

R&S RTH1002: always 1, omit the suffix

R&S RTH1004: Selects the voltmeter.

Parameters:

<CoupVoltageMeas> DCLimit | ACLimit

DCLimit

Enables AC+DC measurement.

ACLimit

Enables AC measurement.

*RST: DCLimit

Example: Configure and perform AC+DC current measurement with range 100 A:

```
:METer:CONFigure:CURRent:AC 100
:METer:SENSe:FUNCTion 'CURR:AC'
:METer:CONFigure:VALue?
<-- "CURR:AC 100"
:METer:SENSe:CURRent:AC:COUPLing DCL
:METer:READ?
<-- 0.035906488794
```

Configure and perform AC voltage measurement with range 10 V:

```
:METer:CONFigure:VAOLTage:AC 10
:METer:SENSe:FUNCTion 'VOLT:AC'
:METer:CONFigure:VALue?
<-- "VOLT:AC 10"
:METer:SENSe:CURRent:AC:COUPLing ACL
:METer:READ?
<-- 0.030006488794
```

12.6.2.5 Temperature Measurements

METer:UNIT:TEMPerature.....	248
METer:SENSe:TEMPerature:TRANsductor:RTD:TYPE.....	248

METer:UNIT:TEMPerature <Unit>

Sets the unit for temperature measurements.

Parameters:

<Unit> C | F | K

METer:SENSe:TEMPerature:TRANsductor:RTD:TYPE <Unit>

Sets the adapter type for temperature measurements.

Parameters:

<Unit> PT100 | PT500

12.6.3 Relative Measurements

To perform relative measurements, set the relevant

METer:SENSe:<function>:NULL:STATe command to ON. By default, the reference value is 0. Alternatively, you can use METer<m>:SENSe:RELative:STATe.

To change the reference value, use the METer:SENSe:<function>:NULL:VALue command.

METer:SENSe:CAPacitance:NULL:STATe.....	249
METer:SENSe:CURRent:AC:NULL:STATe.....	249
METer:SENSe:CURRent:DC:NULL:STATe.....	249
METer:SENSe:RESistance:NULL:STATe.....	249
METer:SENSe:TEMPerature:NULL:STATe.....	249
METer:SENSe:VOLTag:e:AC:NULL:STATe.....	249
METer:SENSe:VOLTag:e:DC:NULL:STATe.....	249
METer<m>:SENSe:NULL:STATe.....	249
METer<m>:SENSe:RELative:STATe.....	249
METer:SENSe:CAPacitance:NULL:VALue.....	250
METer:SENSe:CURRent:AC:NULL:VALue.....	250
METer:SENSe:CURRent:DC:NULL:VALue.....	250
METer:SENSe:VOLTag:e:AC:NULL:VALue.....	250
METer:SENSe:VOLTag:e:DC:NULL:VALue.....	250
METer:SENSe:RESistance:NULL:VALue.....	250
METer:SENSe:TEMPerature:NULL:VALue.....	250
METer<m>:SENSe:NULL:VALU.....	251

METer:SENSe:CAPacitance:NULL:STATe <State>

METer:SENSe:CURRent:AC:NULL:STATe <State>

METer:SENSe:CURRent:DC:NULL:STATe <State>

METer:SENSe:RESistance:NULL:STATe <State>

METer:SENSe:TEMPerature:NULL:STATe <State>

METer:SENSe:VOLTag:e:AC:NULL:STATe <State>

METer:SENSe:VOLTag:e:DC:NULL:STATe <State>

Enables or disables the relative measurement. The reference value is defined using the appropriate `METer:SENSe:<function>:NULL:VALue` command.

Parameters:

<State> OFF | ON
 *RST: OFF

METer<m>:SENSe:NULL:STATe <SetRelative>

METer<m>:SENSe:RELative:STATe <SetRelative>

Enables or disables the relative measurement for the currently active measurement type.

Relative measurements are not available for diode, continuity, and frequency measurements.

Suffix:

<m> 1..4
 R&S RTH1002: always 1, omit the suffix
 R&S RTH1004: Selects the voltmeter.

Parameters:

<SetRelative> ON | OFF
 ON = 1, OFF = 0
 *RST: OFF

METer:SENSe:CAPacitance:NULL:VALue <ReferenceValue>

Sets the reference value for capacitance measurements. The measurement result is the difference of the measured sample and the reference value.

The value takes effect if relative measurement is on, see [METer:SENSe:CAPacitance:NULL:STATe](#).

Parameters:

<ReferenceValue> Range: +/- (1.1 * measurement range)
 *RST: 0
 Default unit: F

METer:SENSe:CURRent:AC:NULL:VALue <ReferenceValue>**METer:SENSe:CURRent:DC:NULL:VALue** <ReferenceValue>**METer:SENSe:VOLTage:AC:NULL:VALue** <ReferenceValue>**METer:SENSe:VOLTage:DC:NULL:VALue** <ReferenceValue>

Sets the reference value for relative measurements. The measurement result is the difference of the measured sample and the reference value.

The value takes effect if relative measurement is on, see [METer:SENSe:<function>:NULL:STATe](#).

Parameters:

<ReferenceValue> Range: +/- (1.1 * measurement range)
 *RST: 0
 Default unit: V (VOLTage) | A (CURRent)

METer:SENSe:RESistance:NULL:VALue <ReferenceValue>

Sets the reference value for resistance measurements. The measurement result is the difference of the measured sample and the reference value.

The value takes effect if relative measurement is on, see [METer:SENSe:RESistance:NULL:STATe](#).

Parameters:

<ReferenceValue> Range: +/- (1.1 * measurement range)
 *RST: 0
 Default unit: Ohm

METer:SENSe:TEMPerature:NULL:VALue <ReferenceValue>

Sets the reference value for temperature measurements. The measurement result is the difference of the measured sample and the reference value.

The value takes effect if relative measurement is on, see [METer:SENSe:TEMPerature:NULL:STATe](#).

Parameters:

<ReferenceValue> Range: -200 to 850
 *RST: 0
 Default unit: To define the unit, use METer:UNIT:TEMPerature.

METer<m>:SENSe:NULL:VALU <ReferenceValue>

Sets the reference value for the currently active measurement type.

Relative measurements are not available for diode, continuity, and frequency measurements.

Suffix:

<m> 1..4
 R&S RTH1002: always 1, omit the suffix
 R&S RTH1004: Selects the voltmeter.

Parameters:

<ReferenceValue> Range: +/- (1.1 * measurement range)
 Default unit: Depends on the measurement type

12.6.4 Measurement Control

METer:SENSe:FUNcTion.....	251
METer:CONFigure:VALue?.....	252
METer<m>:TRIGger:MODE.....	252
METer<m>:ABORT.....	252

METer:SENSe:FUNcTion <MeasType>

Sets the measurement type and activates it. All measurement attributes of the previous function (range, resolution, etc.) are remembered. If you return to the previous function, the measurement attributes are restored.

Changing the measurement type disables scaling, limit testing, histogram, statistics, and trend chart data collection: CALC:<function>:STAT is set OFF.

Setting parameters:

<MeasType> 'CAPacitance | CONTInuity | CURRent:AC | CURRent[:DC] |
 CURRent:AD | DIODE | FREQUency | RESistance |
 TEMPerature | VOLTage:AC | VOLTage[:DC] | VOLTage:AD'
 String parameter
 *RST: VOLTage [:DC]

Example: MET:SENS:FUNC "VOLT:AC"
 MET:CONF:VAL?
 <--"VOLT:AC 1"

Usage: Setting only

METer:CONFigure:VALue?

Returns the actual measurement type (short form) and the range.

Return values:

<Configuration> String parameter

Example:

MET:CONF:VAL?

<--"VOLT:DC 100"

The DMM is set to DC voltage measurement and range 100 V.

Usage:

Query only

METer<m>:TRIGger:MODE <TriggerMode>

Defines how long the instrument measures. To start the measurement again, use RUN or the appropriate METer<m>:MEASure:<function> command.

Suffix:

<m>

1..4

R&S RTH1002: always 1, omit the suffix

R&S RTH1004: Selects the voltmeter.

Parameters:

<TriggerMode>

AUTO | SINGle

AUTO

The instrument performs continuous measurements.

SINGle

The instrument performs a single measurement.

*RST: AUTO

METer<m>:ABORt

Stops the running measurement.

Suffix:

<m>

1..4

R&S RTH1002: always 1, omit the suffix

R&S RTH1004: Selects the voltmeter.

Usage:

Event

12.6.5 Results

- [Reading Values](#).....253
- [METer:MEASure Commands](#).....253
- [Statistics](#).....255

12.6.5.1 Reading Values

After configuration and selection of the active measurement, you can read the result values.

METer<m>:READ?	253
METer<m>:FETCh?	253

METer<m>:READ?

Starts a new measurement, returns the current measurement result and deletes the memory.

Suffix:

<m>	1..4
	R&S RTH1002: always 1, omit the suffix
	R&S RTH1004: Selects the voltmeter.

Return values:

<Result>	Range: -100E+24 to 100E+24
	Increment: 0
	*RST: 0
	Default unit: V

Usage: Query only

METer<m>:FETCh?

Returns all measurement results that are saved in the memory. You can use the command several times to retrieve the same data.

Suffix:

<m>	1..4
	R&S RTH1002: always 1, omit the suffix
	R&S RTH1004: Selects the voltmeter.

Return values:

<NumericResult>	Range: -100E+24 to 100E+24
	Increment: 0
	*RST: 0
	Default unit: V

Usage: Query only

12.6.5.2 METer:MEASure Commands

Sending a METer:MEASure:<function>? command is the same as sending the METer:CONFigure:<function> command followed immediately by a READ? command.

METer:MEASure:CONTinuity?	254
METer:MEASure:DIODE?	254
METer:MEASure:FREQuency?	254

METer:MEASure:TEMPerature?	254
METer:MEASure:CAPacitance?	254
METer:MEASure:CURRent:AC?	254
METer:MEASure:CURRent:DC?	254
METer:MEASure:RESistance?	255
METer:MEASure:VOLTage:AC?	255
METer:MEASure:VOLTage:DC?	255

METer:MEASure:CONTInuity?**METer:MEASure:DIODE?****METer:MEASure:FREQuency?****METer:MEASure:TEMPerature?**

Configures the measurement and returns the result.

Return values:

<Range>

Usage: Query only

METer:MEASure:CAPacitance? [<ExpectedValue>]

Configures the capacitance measurement and returns the result.

Query parameters:

[<ExpectedValue>] <numeric value> | MIN | MAX | DEF | 'AUTO'

Optional parameter, expected measurement result or range. The instrument sets the appropriate measurement range.

See: [METer:CONFigure:CAPacitance](#).

Return values:

<Result> Numeric value

Usage: Query only

METer:MEASure:CURRent:AC? [<ExpectedValue>]**METer:MEASure:CURRent:DC?** [<ExpectedValue>]

Configures the current measurement and returns the result.

Query parameters:

[<ExpectedValue>] <numeric value> | MIN | MAX | DEF | 'AUTO'

Optional parameter, expected measurement result or range. The instrument sets the appropriate measurement range.

See: [METer:CONFigure:CURRent:DC](#).

Return values:

<Result> Numeric value

Example: :METer:MEASure:CURRent:DC? 15
<-- 13.4907681509

Usage: Query only

METer:MEASure:RESistance? [<ExpectedValue>]

Configures the resistance measurement and returns the result.

Query parameters:

[<ExpectedValue>] <numeric value> | MIN | MAX | DEF | 'AUTO'

Optional parameter, expected measurement result or range. The instrument sets the appropriate measurement range.

See: [METer:CONFigure:RESistance](#).

Return values:

<Result> Numeric value

Usage: Query only

METer:MEASure:VOLTage:AC? [<ExpectedValue>]**METer:MEASure:VOLTage:DC?** [<ExpectedValue>]

Configures the voltage measurement and returns the result.

Query parameters:

[<ExpectedValue>] <numeric value> | MIN | MAX | DEF | 'AUTO'

Optional parameter, expected measurement result or range. The instrument sets the appropriate measurement range.

See: [METer:CONFigure:VOLTage:DC](#).

Return values:

<Result> Numeric value

Example: :METer:MEASure:VOLTage:DC? 5
<-- 3.4907681509

Usage: Query only

12.6.5.3 Statistics

Before you can get statistical results, configure the measurement and select the measurement to be performed using [METer:SENSe:FUNction](#).

METer<m>:CALCulate:AVERage:AVERage?	255
METer<m>:CALCulate:AVERage:MINimum?	256
METer<m>:CALCulate:AVERage:MAXimum?	256
METer<m>:CALCulate:AVERage:CLEar	256

METer<m>:CALCulate:AVERage:AVERage?

Returns the mean value of the measurement series.

Suffix:

<m> 1..4
R&S RTH1002: always 1, omit the suffix
R&S RTH1004: Selects the voltmeter.

Return values:

<Average> Range: -100E+24 to 100E+24
 Increment: 1E-12
 *RST: 0
 Default unit: V

Usage: Query only

METer<m>:CALCulate:AVERage:MINimum?

Returns the minimum value of the measurement series.

Suffix:

<m> 1..4
 R&S RTH1002: always 1, omit the suffix
 R&S RTH1004: Selects the voltmeter.

Return values:

<Minimum> Range: -100E+24 to 100E+24
 Increment: 1E-12
 *RST: 0
 Default unit: V

Usage: Query only

METer<m>:CALCulate:AVERage:MAXimum?

Returns the maximum value of the measurement series.

Suffix:

<m> 1..4
 R&S RTH1002: always 1, omit the suffix
 R&S RTH1004: Selects the voltmeter.

Return values:

<Maximum> Range: -100E+24 to 100E+24
 Increment: 1E-12
 *RST: 0
 Default unit: V

Usage: Query only

METer<m>:CALCulate:AVERage:CLEar

Deletes all statistical values.

Statistics are also deleted if:

- The measurement function changes (METer:SENSe:FUNction).
- *RST
- SYSTem:PRESet

Suffix:	
<m>	1..4 R&S RTH1002: always 1, omit the suffix R&S RTH1004: Selects the voltmeter.
Usage:	Event

12.7 Voltmeter (R&S RTH1004)

- [Activating the Voltmeter](#)..... 257
- [Measurement Configuration](#)..... 257
- [Relative Measurements](#)..... 261
- [Measurement Control](#)..... 263
- [Results](#)..... 265

12.7.1 Activating the Voltmeter

METer<m>:SENSe:STATe <State>

Activates the voltmeter measurement.

Suffix:

<m>	1..4 Selects the voltmeter.
-----	--------------------------------

Parameters:

<State>	ON OFF
*RST:	OFF

12.7.2 Measurement Configuration

The only parameter that can be set is the measurement range. All other settings are automatically adjusted by the instrument.

To set a fixed measurement range, you can use several commands:

- **METer<m>:CONFIgure:<function>**
Configures the specified measurement including the measurement range.
See [Chapter 12.7.2.2, "METer<m>:CONFIgure Commands"](#), on page 258.
- **METer<m>:SENSe:<function>:RANGe:UPPer**
Sets the measurement range.
See [Chapter 12.7.2.3, "METer<m>:SENSe:<function>:RANGe:UPPER Commands"](#), on page 260.
- **METer<m>:MEASure:<function>**
Configures the specified measurement including the measurement range, starts the measurement, and returns the result.

The configuration commands are described in the following chapters:

- [General Configuration](#).....258
- [METer<m>:CONFigure Commands](#).....258
- [METer<m>:SENSe:<function>:RANGe:UPPER Commands](#).....260
- [AC+DC Current and Voltage Measurements](#).....261

12.7.2.1 General Configuration

METer<m>:SENSe:SOURce <InputChannel>

Selects the input channel to be measured by the specified voltmeter.

Suffix:

<m> 1..4
Selects the voltmeter.

Parameters:

<InputChannel> C1 | C2 | C3 | C4
*RST: C1

METer<m>:SENSe:RANGe <MeterRangeUI>

Sets the measurement range of the input channel that is measured by the meter.

Suffix:

<m> 1..4
Selects the voltmeter.

Parameters:

<MeterRangeUI> Range: The range depends on the selected measurement type. For values, see the appropriate METer:CONFigure:<function> command.

12.7.2.2 METer<m>:CONFigure Commands

METer:CONFigure:<function> commands set all internal measurement parameters for the specified measurement, and also the measurement range.

To set the range to minimum, maximum, or default value, use the following parameters:

- METer<m>:CONFigure:<function> MIN
- METer<m>:CONFigure:<function> MAX
- METer<m>:CONFigure:<function> DEF

The METer<m>:CONFigure:<function> commands are only for configuration. To activate a measurement, use METer<m>:SENSe:FUNction on page 263.

METer<m>:CONFigure:VALue? returns the active measurement and range.

To read the result, use METer<m>:READ? or METer<m>:FETCh?.

METer<m>:CONFigure:CURRent:AC.....259
METer<m>:CONFigure:CURRent:DC.....259

METer<m>:CONFigure:VOLTage:AC.....	259
METer<m>:CONFigure:VOLTage:DC.....	259

METer<m>:CONFigure:CURREnt:AC**METer<m>:CONFigure:CURREnt:DC**

Sets the internal parameters and configures the range for current measurements.

You need an external shunt resistor or I/U converter for current measurement.

Suffix:

<m> 1..4
Selects the voltmeter.

Parameters:

<Range> <numeric value> | MIN | MAX | DEF

<numeric value>

The instrument has fixed measurement ranges: 1 A|10 A|100 A|1 kA.

You can enter any value between the minimum and maximum value. The instrument uses the next suitable range.

Range: 1 to 1000

*RST: 1

Default unit: A

Usage: Setting only

METer<m>:CONFigure:VOLTage:AC**METer<m>:CONFigure:VOLTage:DC**

Sets the internal parameters and configures the range for voltage measurements.

Suffix:

<m> 1..4
Selects the voltmeter.

Parameters:

<Range> <numeric value> | MIN | MAX | DEF

<numeric value>

The instrument has fixed measurement ranges: 1 V|10 V|100 V|1 kV.

You can enter any value between the minimum and maximum value. The instrument uses the next suitable range.

Range: 1 to 1000

*RST: 1

Default unit: V

Usage: Setting only

12.7.2.3 METer<m>:SENSe:<function>:RANGe:UPPER Commands

METer<m>:SENSe:<function>:RANGe:UPPER commands set the measurement range. You can use these commands in addition to METer<m>:CONFigure commands if you want to change only the range.

METer<m>:SENSe:CURRent:AC:RANGe:UPPer.....	260
METer<m>:SENSe:CURRent:DC:RANGe:UPPer.....	260
METer<m>:SENSe:VOLTage:AC:RANGe:UPPer.....	260
METer<m>:SENSe:VOLTage:DC:RANGe:UPPer.....	260

METer<m>:SENSe:CURRent:AC:RANGe:UPPer <Range>
METer<m>:SENSe:CURRent:DC:RANGe:UPPer <Range>

Sets a fixed current range.

Suffix:

<m> 1..4
 Selects the voltmeter.

Parameters:

<Range> <numeric value> | MIN | MAX | DEF

<numeric value>

The instrument has fixed measurement ranges: 1 A|10 A|100 A| 1 kA.

You can enter any value between the minimum and maximum value. The instrument uses the next suitable range.

Range: 1 to 1000

*RST: 1

Default unit: A

METer<m>:SENSe:VOLTage:AC:RANGe:UPPer <Range>
METer<m>:SENSe:VOLTage:DC:RANGe:UPPer <Range>

Sets a fixed voltage range.

Suffix:

<m> 1..4
 Selects the voltmeter.

Parameters:

<Range> <numeric value> | MIN | MAX | DEF

<numeric value>

The instrument has fixed measurement ranges: 1 V|10 V|100 V| 1 kV.

You can enter any value between the minimum and maximum value. The instrument uses the next suitable range.

Range: 1 to 1000

*RST: 1

Default unit: V

12.7.2.4 AC+DC Current and Voltage Measurements

METer<m>:SENSe:CURRent:AC:COUPling.....	261
METer<m>:SENSe:VOLTagE:AC:COUPling.....	261

METer<m>:SENSe:CURRent:AC:COUPling <Coupling>

METer<m>:SENSe:VOLTagE:AC:COUPling <Coupling>

Enables AC+DC measurements.

Suffix:

<m> 1..4
 R&S RTH1002: always 1, omit the suffix
 R&S RTH1004: Selects the voltmeter.

Parameters:

<CoupVoltageMeas> DCLimit | ACLimit

DCLimit

Enables AC+DC measurement.

ACLimit

Enables AC measurement.

*RST: DCLimit

Example:

Configure and perform AC+DC current measurement with range 100 A:

```
:METer:CONFigure:CURRent:AC 100
:METer:SENSe:FUNCTion 'CURR:AC'
:METer:CONFigure:VALue?
<-- "CURR:AC 100"
:METer:SENSe:CURRent:AC:COUPling DCL
:METer:READ?
<-- 0.035906488794
```

Configure and perform AC voltage measurement with range 10 V:

```
:METer:CONFigure:VAOLTagE:AC 10
:METer:SENSe:FUNCTion 'VOLT:AC'
:METer:CONFigure:VALue?
<-- "VOLT:AC 10"
:METer:SENSe:CURRent:AC:COUPling ACL
:METer:READ?
<-- 0.030006488794
```

12.7.3 Relative Measurements

To perform relative measurements, set the relevant

METer<m>:SENSe:<function>:NULL:STATe command to ON. By default, the reference value is 0. Alternatively, you can use METer<m>:SENSe:RELative:STATe.

To change the reference value, use the

`METer<m>:SENSe:<function>:NULL:VALue` command.

<code>METer<m>:SENSe:CURREnt:AC:NULL:STATe</code>	262
<code>METer<m>:SENSe:CURREnt:DC:NULL:STATe</code>	262
<code>METer<m>:SENSe:VOLTage:AC:NULL:STATe</code>	262
<code>METer<m>:SENSe:VOLTage:DC:NULL:STATe</code>	262
<code>METer<m>:SENSe:NULL:STATe</code>	262
<code>METer<m>:SENSe:RELative:STATe</code>	262
<code>METer<m>:SENSe:CURREnt:AC:NULL:VALue</code>	263
<code>METer<m>:SENSe:CURREnt:DC:NULL:VALue</code>	263
<code>METer<m>:SENSe:VOLTage:AC:NULL:VALue</code>	263
<code>METer<m>:SENSe:VOLTage:DC:NULL:VALue</code>	263
<code>METer<m>:SENSe:NULL:VALU</code>	263

`METer<m>:SENSe:CURREnt:AC:NULL:STATe` <State>

`METer<m>:SENSe:CURREnt:DC:NULL:STATe` <State>

`METer<m>:SENSe:VOLTage:AC:NULL:STATe` <State>

`METer<m>:SENSe:VOLTage:DC:NULL:STATe` <State>

Enables or disables the relative measurement. The reference value is defined using

`METer:SENSe:<function>:NULL:VALue`

Suffix:

<m> 1..4
Selects the voltmeter.

Parameters:

<State> OFF | ON
*RST: OFF

`METer<m>:SENSe:NULL:STATe` <SetRelative>

`METer<m>:SENSe:RELative:STATe` <SetRelative>

Enables or disables the relative measurement for the currently active measurement type.

Relative measurements are not available for diode, continuity, and frequency measurements.

Suffix:

<m> 1..4
R&S RTH1002: always 1, omit the suffix
R&S RTH1004: Selects the voltmeter.

Parameters:

<SetRelative> ON | OFF
ON = 1, OFF = 0
*RST: OFF

METer<m>:SENSe:CURRent:AC:NULL:VALue <ReferenceValue>
METer<m>:SENSe:CURRent:DC:NULL:VALue <ReferenceValue>
METer<m>:SENSe:VOLTAge:AC:NULL:VALue <ReferenceValue>
METer<m>:SENSe:VOLTAge:DC:NULL:VALue <ReferenceValue>

Sets the reference value for relative measurements. The measurement result is the difference of the measured sample and the reference value.

The value takes effect if relative measurement is on, see [METer<m>:SENSe:VOLTAge:DC:NULL:STATe](#).

Suffix:

<m> 1..4
 Selects the voltmeter.

Parameters:

<ReferenceValue> Range: +/- (1.1 * measurement range)
 *RST: 0
 Default unit: V (VOLTAge) | A (CURRent)

METer<m>:SENSe:NULL:VALU <ReferenceValue>

Sets the reference value for the currently active measurement type.

Relative measurements are not available for diode, continuity, and frequency measurements.

Suffix:

<m> 1..4
 R&S RTH1002: always 1, omit the suffix
 R&S RTH1004: Selects the voltmeter.

Parameters:

<ReferenceValue> Range: +/- (1.1 * measurement range)
 Default unit: Depends on the measurement type

12.7.4 Measurement Control

METer<m>:SENSe:FUNctIon	263
METer<m>:CONFigure:VALue?	264
METer<m>:TRIGger:MODE	264
METer<m>:ABORT	265

METer<m>:SENSe:FUNctIon <MeasType>

Sets the measurement type for the selected meter. All measurement attributes of the previous function (range, resolution, etc.) are remembered. If you return to the previous function, the measurement attributes are restored.

Changing the measurement type disables scaling, limit testing, histogram, statistics, and trend chart data collection: `CALC:<function>:STAT` is set OFF.

Suffix:

<m> 1..4
Selects the voltmeter.

Setting parameters:

<MeasType> 'VOLTage:AC | VOLTage[:DC] | VOLTage:AD'
String parameter
*RST: VOLTage [:DC]

Example:

```
MET2:SENS:FUNC "VOLT:AC"
MET2:CONF:VAL?
<-- "VOLT:AC 1"
Sets the second voltmeter to AC voltage measurement.
```

Usage: Setting only

METer<m>:CONFigure:VALue?

Returns the actual measurement type (short form) and the range.

Suffix:

<m> 1..4
Selects the voltmeter.

Return values:

<Configuration> String parameter

Example:

```
MET:CONF:VAL?
<-- "VOLT:DC 100"
The first voltmeter is set to DC voltage measurement and range 100 V.
```

Usage: Query only

METer<m>:TRIGger:MODE <TriggerMode>

Defines how long the instrument measures. To start the measurement again, use RUN or the appropriate METer<m>:MEASure:<function> command.

Suffix:

<m> 1..4
R&S RTH1002: always 1, omit the suffix
R&S RTH1004: Selects the voltmeter.

Parameters:

<TriggerMode> AUTO | SINGle
AUTO
The instrument performs continuous measurements.
SINGle
The instrument performs a single measurement.
*RST: AUTO

METer<m>:ABORt

Stops the running measurement.

Suffix:

<m> 1..4
 R&S RTH1002: always 1, omit the suffix
 R&S RTH1004: Selects the voltmeter.

Usage: Event

12.7.5 Results

- [Reading Values](#).....265
- [METer:MEASure Commands](#).....266
- [Statistics](#).....267

12.7.5.1 Reading Values

[METer<m>:READ?](#)..... 265
[METer<m>:FETCh?](#)..... 265

METer<m>:READ?

Starts a new measurement, returns the current measurement result and deletes the memory.

Suffix:

<m> 1..4
 R&S RTH1002: always 1, omit the suffix
 R&S RTH1004: Selects the voltmeter.

Return values:

<Result> Range: -100E+24 to 100E+24
 Increment: 0
 *RST: 0
 Default unit: V

Usage: Query only

METer<m>:FETCh?

Returns all measurement results that are saved in the memory. You can use the command several times to retrieve the same data.

Suffix:

<m> 1..4
 R&S RTH1002: always 1, omit the suffix
 R&S RTH1004: Selects the voltmeter.

Return values:

<NumericResult> Range: -100E+24 to 100E+24
 Increment: 0
 *RST: 0
 Default unit: V

Usage: Query only

12.7.5.2 METer:MEASure Commands

Sending a `METer:MEASure:<function>?` command is the same as sending the `METer:CONFigure:<function>` command followed immediately by a `READ?` command.

METer<m>:MEASure:CURRent:AC?	266
METer<m>:MEASure:CURRent:DC?	266
METer<m>:MEASure:VOLTag:AC?	266
METer<m>:MEASure:VOLTag:DC?	266

METer<m>:MEASure:CURRent:AC? [<ExpectedValue>]

METer<m>:MEASure:CURRent:DC? [<ExpectedValue>]

Configures the current measurement and returns the result.

Suffix:

<m> 1..4
 Selects the voltmeter.

Query parameters:

[<ExpectedValue>] <numeric value> | MIN | MAX | DEF

Optional parameter, expected measurement result or range. The instrument sets the appropriate measurement range.

See: [METer<m>:CONFigure:CURRent:DC](#).

Return values:

<Result> Numeric value

Usage: Query only

METer<m>:MEASure:VOLTag:AC? [<ExpectedValue>]

METer<m>:MEASure:VOLTag:DC? [<ExpectedValue>]

Configures the voltage measurement and returns the result.

Suffix:

<m> 1..4
 Selects the voltmeter.

Query parameters:

[<ExpectedValue>] <numeric value> | MIN | MAX | DEF

Optional parameter, expected measurement result or range. The instrument sets the appropriate measurement range.

See: [METer<m>:CONFigure:VOLTag:DC](#).

Return values:
 <Result> Numeric value

Usage: Query only

12.7.5.3 Statistics

Before you can get statistical results, configure the measurement and select the measurement to be performed using `METer<m>:SENSe:FUNCTion`.

<code>METer<m>:CALCulate:AVERage:AVERage?</code>	267
<code>METer<m>:CALCulate:AVERage:MINimum?</code>	267
<code>METer<m>:CALCulate:AVERage:MAXimum?</code>	267
<code>METer<m>:CALCulate:AVERage:CLEar</code>	268

`METer<m>:CALCulate:AVERage:AVERage?`

Returns the mean value of the measurement series.

Suffix:

<m> 1..4
 R&S RTH1002: always 1, omit the suffix
 R&S RTH1004: Selects the voltmeter.

Return values:

<Average> Range: -100E+24 to 100E+24
 Increment: 1E-12
 *RST: 0
 Default unit: V

Usage: Query only

`METer<m>:CALCulate:AVERage:MINimum?`

Returns the minimum value of the measurement series.

Suffix:

<m> 1..4
 R&S RTH1002: always 1, omit the suffix
 R&S RTH1004: Selects the voltmeter.

Return values:

<Minimum> Range: -100E+24 to 100E+24
 Increment: 1E-12
 *RST: 0
 Default unit: V

Usage: Query only

`METer<m>:CALCulate:AVERage:MAXimum?`

Returns the maximum value of the measurement series.

Suffix:

<m> 1..4
 R&S RTH1002: always 1, omit the suffix
 R&S RTH1004: Selects the voltmeter.

Return values:

<Maximum> Range: -100E+24 to 100E+24
 Increment: 1E-12
 *RST: 0
 Default unit: V

Usage: Query only

METer<m>:CALCulate:AVERage:CLEar

Deletes all statistical values.

Statistics are also deleted if:

- The measurement function changes (METer:SENSe:FUNction).
- *RST
- SYSTem:PRESet

Suffix:

<m> 1..4
 R&S RTH1002: always 1, omit the suffix
 R&S RTH1004: Selects the voltmeter.

Usage: Event

12.8 Data Logging

- [Logger Settings](#).....268
- [Cursor in Logger Mode](#).....270
- [Zoom in Logger mode](#).....273
- [Logger Statistics](#)273

12.8.1 Logger Settings

- [LOGGer:SOURce](#).....269
- [LOGGer:TIMEbase:SRATe](#).....269
- [LOGGer:TIMEbase:SCALE](#).....269
- [LOGGer:SLOT:CURRent](#).....269
- [LOGGer:SLOT:LOAD](#).....269
- [LOGGer:SLOT:CLEar](#).....270
- [LOGGer:ACLR](#).....270

LOGGer:SOURce <Source>

Sets the logger source.

Parameters:

<Source> SCOPE | METer

LOGGer:TIMEbase:SRATe <NextSampleRate>

Sets the number of samples per second.

Parameters:

<NextSampleRate> SA1 | SA2 | SA5 | SA10
*RST: SA1

LOGGer:TIMEbase:SCALe <NextHorizScale>

Selects the horizontal scale of the logged data.

Parameters:

<NextHorizScale> AUTO | S1 | S2 | S4 | S5 | S10 | S20 | S40 | M1 | M2 | M4 | M5 |
M10 | M20 | M40 | H1 | H2 | H4 | H5 | H10 | H20 | D1 | D2 | D4

S1 | S2 | S4 | S5 | S10 | S20 | S40

Seconds per division

M1 | M2 | M4 | M5 | M10 | M20 | M40

Minutes per division

H1 | H2 | H4 | H5 | H10 | H20

Hours per division

D1 | D2 | D4

Days per division

*RST: AUTO

LOGGer:SLOT:CURRent <SelectedSlot>

Selects one of the 10 memory slots to store the data during the logging. It is possible to change the slot during recording.

Parameters:

<SelectedSlot> SLOT1 | SLOT2 | SLOT3 | SLOT4 | SLOT5 | SLOT6 | SLOT7 |
SLOT8 | SLOT9 | SLOT10

*RST: SLOT1

LOGGer:SLOT:LOAD

Loads the stored log data of a slot. The slot is defined using [LOGGer:SLOT:CURRent](#).

Usage: Event

LOGGer:SLOT:CLEar

Deletes the log data of a slot. The slot is defined using `LOGGer:SLOT:CURRent`.

Only possible while logging is stopped.

Usage: Event

LOGGer:ACLR

Deletes the log data of all slots. Only possible while logging is stopped.

Usage: Event

12.8.2 Cursor in Logger Mode

12.8.2.1 Cursor Settings

<code>LOGGer:CURSor<m>:STATe</code>	270
<code>LOGGer:CURSor<m>:TYPE</code>	270
<code>LOGGer:CURSor<m>:SCPLing</code>	271
<code>LOGGer:CURSor<m>:COUPLing</code>	271
<code>LOGGer:CURSor<m>:SCReen</code>	271

LOGGer:CURSor<m>:STATe <Enabled>

Enables or disables the logger cursor measurement.

Suffix:

<m> 1..2

Parameters:

<Enabled> ON | OFF
*RST: OFF

LOGGer:CURSor<m>:TYPE <Value>

If data logging is running for more than 2 days and 7 hours, the logger compresses 4 logging values into a minimum, average and maximum value. The command sets the measured crossing point between the cursor lines and the waveform.

For logging periods shorter than 2 days and 7 hours, the command is not relevant.

Parameters:

<Value> MINimum | AVERage | MAXimum
*RST: AVERage

LOGGer:CURSor<m>:SCPLing <TrackScaling>

If ON, the position of the cursor lines is adjusted when the horizontal scale is changed.

If OFF, the cursor lines remain on their position on the display when the scaling is changed.

Suffix:

<m> 1..2

Parameters:

<TrackScaling> ON | OFF
*RST: OFF

LOGGer:CURSor<m>:COUPling <Coupling>

Couples the cursor lines so that the distance between the two lines remains the same when one cursor is moved.

Suffix:

<m> 1..2

Parameters:

<Coupling> ON | OFF
*RST: OFF

LOGGer:CURSor<m>:SCReen

Sets the cursors to a default position on the screen.

Suffix:

<m> 1..2

Usage: Event

12.8.2.2 Cursor Results

LOGGer:CURSor<m>:POSition.....	271
LOGGer:CURSor:TDELta?.....	272
LOGGer:CURSor<m>:RESult<n>[:AMPLitude]?.....	272

LOGGer:CURSor<m>:POSition

<Year>,<Month>,<Day>,<Hours>,<Minutes>,<Seconds>,<TenthsOfSecond>

Sets the positions of the cursor lines.

Suffix:

<m> 1..2
Specifies the cursor line.

Parameters:

<Year>	Range: 2015 to 9999 Increment: 1 *RST: 2015
<Month>	Range: 1 to 12 Increment: 1 *RST: 1
<Day>	Range: 1 to 31 Increment: 1 *RST: 1
<Hours>	Range: 0 to 23 Increment: 1 *RST: 1
<Minutes>	Range: 0 to 59 Increment: 1 *RST: 1
<Seconds>	Range: 0 to 59 Increment: 1 *RST: 0
<TenthsOfSecond>	Range: 0 to 9 Increment: 1 *RST: 0

LOGGer:CURSor:TDELta?

Returns the time difference of the cursor lines.

Return values:

<Day>,<Hour>,<Min>,<Sec>,<ZSec>

Usage: Query only

LOGGer:CURSor<m>:RESult<n>[:AMPLitude]?

Returns the measured value at the specified cursor line.

Suffix:

<m>	1..2 Specifies the cursor line.
<n>	1..4 Specifies the measurement.

Return values:

<Yvalue> Measurement value

Usage: Query only

12.8.3 Zoom in Logger mode

LOGGer:ZOOM:ENABLE.....	273
LOGGer:ZOOM:SCALE.....	273
LOGGer:ZOOM:POSition.....	273

LOGGer:ZOOM:ENABLE <Zoom Enabled>

Enables or disables the logger zoom.

Parameters:

<Zoom Enabled> ON | OFF
 *RST: OFF

LOGGer:ZOOM:SCALE <Zoom Scale>

Sets the time scale of the zoomed waveform.

Parameters:

<Zoom Scale> AUTO | S1 | S2 | S4 | S5 | S10 | S20 | S40 | M1 | M2 | M4 | M5 |
 M10 | M20 | M40 | H1 | H2 | H4 | H5 | H10 | H20 | D1 | D2 | D4

LOGGer:ZOOM:POSition <Year>,<Month>,<Day>,<Hour>,<Min>,<Sec>

Sets the center position of the zoomed area in relation to the left side of the display.

12.8.4 Logger Statistics

The suffix <m> specifies the measurement that is logged.

LOGGer:RECORDing:START?	273
LOGGer:RECORDing:TOTAL?	274
LOGGer:MEASurement<m>:RESult:CURRentsampl?	274
LOGGer:MEASurement<m>:RESult:MAXimum:POSition?	274
LOGGer:MEASurement<m>:RESult:MAXimum:VALue?	274
LOGGer:MEASurement<m>:RESult:MINimum:POSition?	275
LOGGer:MEASurement<m>:RESult:MINimum:VALue?	275
LOGGer:MEASurement<m>:RESult:MEAN?	275
LOGGer:MEASurement<m>:RESult:STDDev?	275
LOGGer:MEASurement<m>:ENABLEd?	276
LOGGer:MEASurement<m>:TYPE?	276
LOGGer:MEASurement<m>:SOURce?	276

LOGGer:RECORDing:START?

Returns the absolute start time of the current logging session.

Return values:

<StartTime> Year, month, day, hour, minute, second, decisecond, for exam-
 ple 2015,10,29,16,10,22,2

Usage: Query only

LOGGer:RECOrding:TOTal?

Returns the total duration of the current logging session.

Return values:

<Day>;<Hour>;<Min>;<Sec>;<FracSec>; 1; 42; 32; 2

Usage: Query only

LOGGer:MEASurement<m>:RESult:CURRentsampl?

Returns the actual logging value of the selected measurement.

Suffix:

<m> 1..4

Return values:

<CurrentSample> Range: -100E+24 to 100E+24
Increment: 100E-12
*RST: 0

Usage: Query only

LOGGer:MEASurement<m>:RESult:MAXimum:POSition?

Returns the time stamp of the maximum logging value of the selected measurement.

Suffix:

<m> 1..4

Return values:

<TimeOfMax>

Usage: Query only

LOGGer:MEASurement<m>:RESult:MAXimum:VALue?

Returns the maximum logging value of the selected measurement.

Suffix:

<m> 1..4

Return values:

<Maximum> Range: -100E+24 to 100E+24
Increment: 100E-12
*RST: 0

Usage: Query only

LOGGer:MEASurement<m>:RESult:MINimum:POSition?

Returns the time stamp of the minimum logging value of the selected measurement.

Suffix:

<m> 1..4

Return values:

<TimeOfMin>

Usage: Query only

LOGGer:MEASurement<m>:RESult:MINimum:VALue?

Returns the minimum logging value of the selected measurement.

Suffix:

<m> 1..4

Return values:

<Minimum> Range: -100E+24 to 100E+24
Increment: 100E-12
*RST: 0

Usage: Query only

LOGGer:MEASurement<m>:RESult:MEAN?

Returns the mean logging value of the selected measurement.

Suffix:

<m> 1..4

Return values:

<Average> Range: -100E+24 to 100E+24
Increment: 100E-12
*RST: 0

Usage: Query only

LOGGer:MEASurement<m>:RESult:STDDev?

Returns the standard deviation value of the selected measurement.

Suffix:

<m> 1..4

Return values:

<StdDeviation> Range: -100E+24 to 100E+24
Increment: 100E-12
*RST: 0

Usage: Query only

LOGGer:MEASurement<m>:ENABLEd?

Returns the measurement state of scope and meter measurements.

Suffix:

<m> 1..4

Return values:

<Enabled> ON | OFF
*RST: OFF

Usage: Query only

LOGGer:MEASurement<m>:TYPE?

Returns the measurement type of the selected measurement.

Suffix:

<m> 1..4

Return values:

<Type> See [MEASurement<m>:TYPE](#) on page 225.

Usage: Query only

LOGGer:MEASurement<m>:SOURce?

Returns the source channel of the selected measurement.

Suffix:

<m> 1..4

Return values:

<Source> C1 | C2 | C3 | C4 | M1 | R1 | XY | D0 | D1 | D2 | D3 | D4 | D5 |
D6 | D7

<Source2> C1 | C2 | C3 | C4 | M1 | R1 | XY | D0 | D1 | D2 | D3 | D4 | D5 |
D6 | D7

Example:

LOGGer:MEASurement4:SOURce?

<-- C2,C1

Measurement 4 is a delay measurement on source 1 = C2 and
source 2 = C1

Usage: Query only

12.9 Protocol Analysis

- [General Protocol Settings](#)..... 277
- [I2C \(Option R&S RTH-K1\)](#)..... 277
- [SPI \(Option R&S RTH-K1\)](#)..... 281

- [UART/RS-232/RS-422/RS-485 \(Option R&S RTH-K2\)](#)..... 285
- [CAN \(Option R&S RTH-K3\)](#)..... 289
- [LIN \(Option R&S RTH-K3\)](#)..... 295

12.9.1 General Protocol Settings

BUS:TYPE	277
BUS[:STATe]	277
BUS:FORMat	277

BUS:TYPE <Protocol>

Defines protocol type of the bus for configuration and trigger settings.

Parameters:

<Protocol> I2C | SPI | UART | CAN | LIN
 *RST: I2C

BUS[:STATe] <State>

Enables the decoding and the display of the serial bus data.

Parameters:

<State> ON | OFF
 *RST: OFF

BUS:FORMat <NumberFormat>

Sets the decoding format of the data.

Parameters:

<NumberFormat> BIN | OCT | DEC | HEX | ASCii
 *RST: HEX

12.9.2 I2C (Option R&S RTH-K1)

- [I2C Configuration Settings](#)..... 277
- [I2C Trigger](#)..... 278

12.9.2.1 I2C Configuration Settings

BUS:I2C:SCL:SOURce	278
BUS:I2C:SDA:SOURce	278
BUS:I2C:TECHnology	278
BUS:I2C:SCL:THReshold	278
BUS:I2C:SDA:THReshold	278

BUS:I2C:SCL:SOURce <Channel>

BUS:I2C:SDA:SOURce <Channel>

Set the input channels of the I2C lines.

Parameters:

<Channel> C1 | C2 | C3 | C4 | D0 | D1 | D2 | D3 | D4 | D5 | D6 | D7

C3 and C4: only R&S RTH1004

Digital channels are available if option R&S RTH-B1 is installed.

*RST: C1

BUS:I2C:TECHnology <ThresholdType>

Sets the threshold values of all I2C lines as defined for various signal technologies.

Parameters:

<ThresholdType> TTL | ECL | CMOS | USER

TTL

1.4 V

ECL

-1.3 V

CMOS

2.5 V

USER

Set a user-defined value for each line using the

BUS:I2C:<line>:THReshold commands.

*RST: TTL

Usage: SCPI confirmed

BUS:I2C:SCL:THReshold <ThresholdValue>

BUS:I2C:SDA:THReshold <ThresholdValue>

Set a user-defined threshold value for the corresponding line if **BUS:I2C:TECHnology** is set to **USER**.

Parameters:

<ThresholdValue> Range: -400 to 400

Increment: 1E-3

*RST: 1.4

Default unit: V

12.9.2.2 I2C Trigger

TRIGger:I2C:MODE.....	279
TRIGger:I2C:ADNack.....	279
TRIGger:I2C:DRNack.....	279
TRIGger:I2C:DWNack.....	279
TRIGger:I2C:ACCess.....	280

TRIGger:I2C:ACONdition.....	280
TRIGger:I2C:ADDRess.....	280
TRIGger:I2C:DATA.....	280
TRIGger:I2C:DCondition.....	280
TRIGger:I2C:DPOsition.....	281

TRIGger:I2C:MODE <TriggerType>

Selects the trigger type for I²C analysis.

Parameters:

<TriggerType> START | REStart | STOP | NACK | ADDRess | DATA | ADAT

NACK = Missing acknowledge bit

ADAT = combination of address and data condition

For details, see "I²C Trigger" on page 131.

*RST: START

TRIGger:I2C:ADNack <TrigOnNoAckForAddress>

Set ON to trigger if no slave recognizes the address.

The command takes effect if [TRIGger:I2C:MODE](#) is NACK.

Parameters:

<TrigOnNoAckForAddress> ON | OFF

*RST: ON

TRIGger:I2C:DRNack <NoAckDataRead>

Set ON to trigger if the end of the read process is marked when the master reads data from the slave. This Nack is sent according to the protocol definition, it is not an error.

The command takes effect if [TRIGger:I2C:MODE](#) is NACK.

Parameters:

<NoAckDataRead> ON | OFF

*RST: ON

TRIGger:I2C:DWNack <NoAckDataWrite>

Set ON to trigger if the addressed slave does not accept the written data, and the write data acknowledge bit is missing.

The command takes effect if [TRIGger:I2C:MODE](#) is NACK.

Parameters:

<NoAckDataWrite> ON | OFF

*RST: ON

TRIGger:I2C:ACcEss <ReadWriteBit>

Toggles the trigger condition between read and write access of the master. Select "Either" if the transfer direction is not relevant for the trigger condition.

The command takes effect if **TRIGger:I2C:MODE** is **ADDRess** or **ADAT**.

Parameters:

<ReadWriteBit> READ | WRITe | EITHer
*RST: EITHer

TRIGger:I2C:ACONdition <Relation>

Defines how the specified serial address pattern is compared with the acquired signal. The instrument triggers if the acquired address is equal or unequal to the pattern.

Parameters:

<Relation> EQUal | NEQual
*RST: EQUal

TRIGger:I2C:ADDRess <Pattern>

Specifies the address pattern to be found, in binary format. Enter the pattern in MSB first bit order.

Parameters:

<Pattern> String with max. 7 or 10 characters, depending on the address length. Characters 0, 1, and X are allowed. If you define a pattern shorter than the address length, the missing LSB are filled with X.

Example: TRIG:I2C:ADDR "10110"
Sets the 7 bit address pattern 10110XX.

TRIGger:I2C:DATA <Pattern>

Defines the data pattern as trigger condition. Enter the words in MSB first bit order.

Parameters:

<Pattern> String with max. 4 bytes in binary format. Characters 0, 1, and X are allowed. If you define a pattern with incomplete byte, the missing LSB are filled with X.

Example: TRIGger:I2C:DATA '11111111000000001111'
TRIGger:I2C:DATA?
<-- 11111111000000001111XXXX

TRIGger:I2C:DCONdition <Relation>

Defines how the specified data pattern is compared with the acquired signal. The instrument triggers if the acquired data is equal or unequal to the pattern.

Parameters:

<Relation> EQUal | NEQual
 *RST: EQUal

TRIGger:I2C:DPOsition <ByteOffset>

Sets the number of bytes before the first byte of the data pattern. These bytes are ignored.

Parameters:

<ByteOffset> Range: 0 to 4095
 Increment: 1
 *RST: 0

12.9.3 SPI (Option R&S RTH-K1)**12.9.3.1 SPI Configuration Settings**

BUS:SPI:SCLK:SOURce.....	281
BUS:SPI:SSEL:SOURce.....	281
BUS:SPI:MOSI:SOURce.....	281
BUS:SPI:MISO:SOURce.....	281
BUS:SPI:SCLK:SLOPe.....	282
BUS:SPI:SSEL:POLarity.....	282
BUS:SPI:TECHnology.....	282
BUS:SPI:SCLK:THReshold.....	282
BUS:SPI:SSEL:THReshold.....	282
BUS:SPI:MOSI:THReshold.....	282
BUS:SPI:MISO:THReshold.....	282
BUS:SPI:WSIZe.....	283
BUS:SPI:ORDer.....	283
BUS:SPI:TIMeout.....	283

BUS:SPI:SCLK:SOURce <Channel>

BUS:SPI:SSEL:SOURce <Channel>

BUS:SPI:MOSI:SOURce <Channel>

BUS:SPI:MISO:SOURce <Channel>

Set the input channels of the SPI lines.

Parameters:

<Channel> C1 | C2 | C3 | C4 | D0 | D1 | D2 | D3 | D4 | D5 | D6 | D7
 C3 and C4: only R&S RTH1004
 Digital channels are available if option R&S RTH-B1 is installed.
 *RST: C1

BUS:SPI:SCLK:SLOPe <ClockEdge>

Selects if data are sampled on the rising or falling slope of the clock. The clock slope marks the begin of a new bit.

Parameters:

<ClockEdge> POSitive | NEGative
*RST: POSitive

BUS:SPI:SSEL:POLarity <ChipSelectPolarity>

Selects whether the chip select signal is high active (high = 1) or low active (low = 1).

Parameters:

<ChipSelectPolarity> ACTLow | ACTHigh
*RST: ACTHigh

BUS:SPI:TECHnology <ThresholdType>

Sets the threshold values of all SPI lines as defined for various signal technologies.

Parameters:

<ThresholdType> TTL | ECL | CMOS | USER
TTL
1.4 V
ECL
-1.3 V
CMOS
2.5 V
USER
Set a user-defined value for each line using the
`BUS:SPI:<line>:THReshold` commands.
*RST: TTL

Usage: SCPI confirmed

BUS:SPI:SCLK:THReshold <ThresholdValue>**BUS:SPI:SSEL:THReshold** <ThresholdValue>**BUS:SPI:MOSI:THReshold** <ThresholdValue>**BUS:SPI:MISO:THReshold** <ThresholdValue>

Set a user-defined value for the corresponding line if `BUS:SPI:TECHnology` is set to USER.

Parameters:

<ThresholdValue> Range: -400 to 400
Increment: 1E-3
*RST: 1.4
Default unit: V

BUS:SPI:WSize <WordLength>

Sets the number of bits in a word.

Parameters:

<WordLength> WL4Bit | WL8Bit | WL12bit | WL16bit | WL20bit | WL24bit |
WL28bit | WL32bit
*RST: WL8Bit

BUS:SPI:ORder <BitOrder>

Defines if the data of the words starts with MSB (most significant bit) or LSB (least significant bit). Results are displayed in the specified order.

Parameters:

<BitOrder> LSBF | MSBF
*RST: MSBF

BUS:SPI:TIMEout <FrameTimeout>

Sets the minimum idle time between two data frames. If the time interval between the data frames is shorter, the words are part of the same frame. Within the timeout, the data and clock lines are low. A new frame begins when the timeout has expired.

Timeout is only relevant if the bus has no chip select.

Parameters:

<FrameTimeout> Range: 500E-9 to 1000
Increment: 1E-3
*RST: 1E-3
Default unit: s

12.9.3.2 SPI Trigger

TRIGger:SPI:MODE.....	283
BUS:SPI:SSEL:STATe.....	284
TRIGger:SPI:DSRC.....	284
TRIGger:SPI:DATA.....	284
TRIGger:SPI:DCONDition.....	284
TRIGger:SPI:DPOSition.....	285

TRIGger:SPI:MODE <TriggerType>

Selects the trigger type for SPI analysis.

Parameters:

<TriggerType> FRST | FREN | DATA

FRST = frame start

FREN = frame end

DATA = data.

For details, see "[SPI Trigger](#)" on page 136.

*RST: FRST

BUS:SPI:SSEL:STATE <UseChipSelect>

Defines if the SPI bus uses a chip select line or not.

Parameters:

<UseChipSelect> ON | OFF

*RST: ON

TRIGger:SPI:DSRC <DataSource>

Selects the line, on which the trigger pattern is expected.

Parameters:

<DataSource> MISO | MOSI

*RST: MISO

TRIGger:SPI:DATA <Pattern>

Specifies the data pattern to be found on the specified line, in binary format. Enter the words in MSB first bit order.

Parameters:

<Pattern> String with max. 32 bit in binary format. Characters 0, 1, and X are allowed.

Example:

```
TRIGger:SPI:DATA '111000'
```

```
TRIGger:SPI:DATA?
```

```
<--111000
```

Specifies a 6 bit pattern. Higher bits are omitted.

TRIGger:SPI:DCONdition <Relation>

Defines how the specified data pattern is compared with the acquired signal. The instrument triggers if the acquired data is equal or unequal to the pattern.

Parameters:

<Relation> EQUal | NEQual

*RST: EQUal

TRIGger:SPI:DPOsition <BitOffset>

Sets the number of bits before the first bit of the pattern. These bits are ignored. The first bit after CS or timeout is bit 0.

Parameters:

<BitOffset> Range: 0 to 4095
 Increment: 1
 *RST: 0

12.9.4 UART/RS-232/RS-422/RS-485 (Option R&S RTH-K2)

- [UART Configuration](#).....285
- [UART Trigger](#).....288

12.9.4.1 UART Configuration

BUS:UART:SOURce	285
BUS:UART:POLarity	285
BUS:UART:TECHnology	286
BUS:UART:THReshold	286
BUS:UART:STDBitrate	286
BUS:UART:BITRate	286
BUS:UART:SSIZe	287
BUS:UART:PARity	287
BUS:UART:SBIT	287
BUS:UART:ORDer	287
BUS:UART:FRAMemode	288
BUS:UART:TOUT	288

BUS:UART:SOURce <Channel>

Selects the input channel of the UART line.

Parameters:

<Channel> C1 | C2 | C3 | C4 | D0 | D1 | D2 | D3 | D4 | D5 | D6 | D7
 C3 and C4: only R&S RTH1004
 Digital channels are available if option R&S RTH-B1 is installed.
 *RST: C1

BUS:UART:POLarity <Polarity>

Defines the logic states of the line. In idle high state, the idle state corresponds to a logic 1, and the start bit to a logic 0. In idle low state, the idle state corresponds to a logic 0, and the start bit to a logic 1. During idle time, no data is transmitted.

Parameters:

<Polarity> IDLLow | IDLHigh
 *RST: IDLHigh

BUS:UART:TECHnology <ThresholdType>

Sets the threshold value of the UART line as defined for various signal technologies.

Parameters:

<ThresholdType> TTL | ECL | CMOS | USER

TTL

1.4 V

ECL

-1.3 V

CMOS

2.5 V

USER

Set a user-defined value using [BUS:UART:THReshold](#).

*RST: TTL

BUS:UART:THReshold <ThresholdValue>

Sets an individual threshold value for digitization of signals if [BUS:UART:TECHnology](#) is set to `USER`.

Parameters:

<ThresholdValue> Range: -400 to 400

Increment: 1E-3

*RST: 1.4

Default unit: V

BUS:UART:STDBitrate <Bitrate>

Sets the number of transmitted bits per second.

Parameters:

<Bitrate> BPS_300 | BPS_600 | BPS_1200 | BPS_2400 | BPS_4800 |
BPS_9600 | BPS_14400 | BPS_19200 | BPS_28800 |
BPS_38400 | BPS_56000 | BPS_57600 | BPS_115200 |
BPS_128000 | BPS_230400 | BPS_460800 | BPS_921600 |
CUSTom

Values in bits per second.

CUSTom: Set the bit rate using [BUS:UART:BITRate](#).

*RST: BPS_14400

BUS:UART:BITRate <CustomBitrate>

Sets a user-defined bit rate if [BUS:UART:STDBitrate](#) is set to `CUSTom`.

Parameters:

<CustomBtrate> Range: 300 to 20000000
 Increment: 1
 *RST: 14400
 Default unit: bps

BUS:UART:SSize <DataBits>

Sets the number of data bits in a word (symbol).

Parameters:

<DataBits> B5 | B6 | B7 | B8 | B9
 *RST: B8

BUS:UART:PARity <Parity>

Defines the optional parity bit that is used for error detection.

Parameters:

<Parity> NONE | ODD | EVEN

NONE
 No parity bit is used.

ODD
 The parity bit is set to "1" if the number of data bits set to "1" is even.

EVEN
 The parity bit is set to "1" if the number of data bits set to "1" is odd.

*RST: NONE

BUS:UART:SBIT <StopBits>

Sets the number of stop bits: 1 or 1.5 or 2 stop bits are possible.

Parameters:

<StopBits> B1 | B15 | B2
 *RST: B1

BUS:UART:ORDer <BitOrder>

Defines if a word starts with MSB (most significant bit) or LSB (least significant bit). The display of the decoded signal considers this setting, results are displayed in the specified order.

Parameters:

<BitOrder> LSBF | MSBF
 *RST: MSBF

BUS:UART:FRAMemode <FrameMode>

IDLE defines frames of several words in the data stream, which are defined by a timeout between a stop bit and the next start bit. Enter the minimum timeout between two frames using [BUS:UART:TOUT](#).

Parameters:

<FrameMode> NONE | IDLE
*RST: NONE

BUS:UART:TOUT <IdleTime>

Sets the minimum timeout between two frames if [BUS:UART:FRAMemode](#) is set to IDLE.

Parameters:

<IdleTime> Range: 100E-9 to 1
 Increment: 1E-3
*RST: 1E-3
Default unit: s

12.9.4.2 UART Trigger

TRIGger:UART:TYPE	288
TRIGger:UART:DATA	288
TRIGger:UART:DCondition	289

TRIGger:UART:TYPE <TriggerType>

Selects the trigger type for UART analysis.

Parameters:

<TriggerType> STBT | PCKS | DATA | PRER | STPerror | BRKC
STBT = start bit
PCKS = frame start
PRER = parity error
STPerror = stop error
BRKC = break condition
DATA: : data. To set up the trigger condition, use [TRIGger:UART:DATA](#), and [TRIGger:UART:DCondition](#).
For details, see "UART Trigger" on page 140.
*RST: STBT

TRIGger:UART:DATA <Pattern>

Defines the data pattern as trigger condition. Enter the words in MSB first bit order.

Parameters:

<Pattern> String with max. 8 bit in binary format. Characters 0, 1, and X are allowed.

Example:

```
TRIGger:UART:DATA '1x11'
TRIGger:UART:DATA?
1X11
```

TRIGger:UART:DCONdition <Relation>

Defines how the specified data pattern is compared with the acquired signal. The instrument triggers if the acquired data is equal or unequal to the pattern.

Parameters:

<Relation> EQUal | NEQual
*RST: EQUal

12.9.5 CAN (Option R&S RTH-K3)

- [CAN Configuration Settings](#)..... 289
- [CAN Trigger](#)..... 291

12.9.5.1 CAN Configuration Settings

BUS:CAN:BITRate	289
BUS:CAN:DATA:SOURce	289
BUS:CAN:DATA:THReshold	290
BUS:CAN:SAMPlepoint	290
BUS:CAN:TECHnology	291
BUS:CAN:TYPE	291

BUS:CAN:BITRate <CustomBitrate>

Sets the number of transmitted bits per second.

Parameters:

<CustomBitrate> Range: 10000 to 1000000
 Increment: 1
 *RST: 50000
 Default unit: bps

BUS:CAN:DATA:SOURce <Channel>

Sets the input channel of the CAN line.

Parameters:

<Channel> C1 | C2 | C3 | C4 | M1 | R1 | XY | D0 | D1 | D2 | D3 | D4 | D5 |
 D6 | D7 | S | FFT | MEAS1 | MEAS2 | MEAS3 | MEAS4 | CMEA |
 NONE
 *RST: C1

Usage: Asynchronous command

BUS:CAN:DATA:THReshold <ThresholdValue>

Sets the threshold value for digitization of signals manually. If the signal value is higher than the threshold, the signal state is high. Otherwise, the signal state is considered low.

This value is only considered for [BUS:CAN:TECHnology](#) USER

Parameters:

<ThresholdValue> Range: -400 to 400
 Increment: 1E-3
 *RST: 1.4
 Default unit: V

BUS:CAN:SAMPlEpoint <SamplePoint>

The sample point divides the nominal bit period into two distinct time segments. The length of the time segments is defined in time quanta according to network and node conditions during CAN development.

Parameters:

<SamplePoint> Range: 10 to 95
 Increment: 1
 *RST: 50
 Default unit: %

BUS:CAN:TECHnology <ThresholdType>**Parameters:**

<ThresholdType> TTL | ECL | CMOS | CAN | GND | LIN7vsupply | LIN12vsupply | LIN18vsupply | USER

TTL

1.4 V

ECL

-1.3 V

CMOS

2.5 V

GND

0 V (for CAN channels, requires option R&S RTH-K3)

CAN

2 V (for CAN channels, requires option R&S RTH-K3)

LIN7vsupply | LIN12vsupply | LIN18vsupply

7 V / 12 V / 18 V (for LIN channels, requires option R&S RTH-K3)

USER

Set the value with `CHANnel<m>:THReshold:USER`.

*RST: CAN

BUS:CAN:TYPE <SignalType>

Selects whether the chip select signal is high active (high = 1) or low active (low = 1).

Parameters:

<SignalType> CANH | CANL

CANH

Signal is high active (high = 1)

CANL

Signal is low active (low = 1)

*RST: CANL

12.9.5.2 CAN Trigger

TRIGger:CAN:ACKerror.....	292
TRIGger:CAN:BITSterror.....	292
TRIGger:CAN:CRCErrror.....	292
TRIGger:CAN:DATA.....	292
TRIGger:CAN:DCONdition.....	292
TRIGger:CAN:FORMerror.....	292
TRIGger:CAN:FTYPE.....	293
TRIGger:CAN:ICONdition.....	293
TRIGger:CAN:IDENtifier.....	293
TRIGger:CAN:ITYPE.....	294
TRIGger:CAN:TYPE.....	294

TRIGger:CAN:ACKerror <AckError>

An acknowledgement error occurs when the transmitter does not receive an acknowledgment - a dominant bit during the Ack Slot.

Parameters:

<AckError> ON | OFF
 *RST: ON

TRIGger:CAN:BITSterror <StuffBitError>

A stuff error occurs when the 6th consecutive equal bit level in the mentioned fields is detected.

Parameters:

<StuffBitError> ON | OFF
 *RST: ON

TRIGger:CAN:CRCError <CrcError>

A CRC error occurs when the calculated result differs from the received value in the CRC sequence.

Parameters:

<CrcError> ON | OFF
 *RST: ON

TRIGger:CAN:DATA <Pattern>

Specifies the data pattern to be found, in binary or hex format. Enter the pattern in MSB first bit order.

Parameters:

<Pattern> String that contains the pattern in binary format. The parameter accepts the bit value X (don't care).

TRIGger:CAN:DCONDition <Relation>

Defines how the specified data pattern is compared with the acquired signal. The instrument triggers if the acquired address is equal or unequal the defined pattern.

Parameters:

<Relation> EQUal | NEQual
 *RST: EQUal

TRIGger:CAN:FORMerror <FormError>

A form error occurs when a fixed-form bit field contains one or more illegal bits.

Parameters:

<FormError> ON | OFF
 *RST: ON

TRIGger:CAN:FTYPE <FrameType>

CAN has several frame types which can be used as trigger condition.

For data and remote frames, the identifier format has to be set with **TRIGger:CAN:ITYPE**.

Parameters:

<FrameType> ERRor | OVERload | DATA | REMote | DOR

ERRor

When a node recognizes an error, it cancels transmission by sending an error frame.

The instrument triggers seven bit periods after the end of the error flag that is marked by a dominant-recessive edge.

OVERload

When a node needs a delay between data and/or remote frames, it sends an overload frame.

DATA

The data frame is the only frame for actual data transmission.

REMote

Remote frames are only available in the CAN protocol.

The remote frame initiates the transmission of data by another node. The frame format is the same as of data frames but without the data field.

DOR

Data frames or remote frames initiate the transmission of data by another node. The frame format is the same as of data frames.

*RST: DOR

TRIGger:CAN:ICONdition <Relation>

Defines how the specified identifier pattern is compared with the acquired signal. The instrument triggers if the acquired address is equal or unequal the defined pattern.

Parameters:

<Relation> EQUal | NEQual
 *RST: EQUal

TRIGger:CAN:IDENTifier <Pattern>

Specifies the identifier pattern to be found, in binary format. Enter the pattern in MSB first bit order.

Parameters:

<Pattern>

String that contains the pattern in binary format. The parameter accepts the bit value X (don't care).

Example:

```
TRIG:CAN:TYPE ID
TRIG:CAN:IDEN 001001
TRIG:CAN:ICON EQU
```

Triggers if the ID of the measured signal is 001001.

TRIGger:CAN:ITYPE <IdentifierType>

Selects the length of the identifier.

Parameters:

<IdentifierType>

B11 | B29 | ANY

ANY

The ID type and ID pattern are not relevant for the trigger condition.

If the trigger type is "Identifier", the instrument triggers on any identifier in the specified frame type.

If the trigger type is "Identifier + Data", set the "ID type" to "Any" if you want to trigger only on data.

```
*RST: ANY
```

TRIGger:CAN:TYPE <TriggerType>

Depending on the selected CAN trigger type, different additional parameters are available.

Parameters:

<TriggerType>

STOF | EOF | FTYP | ID | IDDT | ERRC

STOF

Triggers on the stop bit of the sync field.

EOF

Triggers after a wakeup frame.

FTYP

Triggers on a specified frame type (data, remote, error, or overload). For data and remote frames, also the identifier format is considered.

ID

Sets the trigger to a specific identifier or an identifier range. Only the 6-bit identifier without parity bits is considered, not the protected identifier.

IDDT

Sets the trigger to a combination of identifier and data condition. The instrument triggers at the end of the last byte of the specified data pattern.

ERRC

Identifies various errors in the frame. You can select one or more error types as the trigger condition.

*RST: STOF

12.9.6 LIN (Option R&S RTH-K3)

- [LIN Configuration Settings](#)..... 295
- [LIN Trigger](#)..... 297

12.9.6.1 LIN Configuration Settings

BUS:LIN:BITRate	295
BUS:LIN:DATA:SOURce	296
BUS:LIN:DATA:THReshold	296
BUS:LIN:POLarity	296
BUS:LIN:STANdard	296
BUS:LIN:TECHnology	297

BUS:LIN:BITRate <CustomBitrate>

Sets the number of transmitted bits per second.

Parameters:

<CustomBitrate>

Range: 1000 to 20000

Increment: 1

*RST: 9600

Default unit: bps

BUS:LIN:DATA:SOURce <Channel>

Sets the source of the data line. All channel waveforms can be used.

Parameters:

<Channel> C1 | C2 | C3 | C4 | M1 | R1 | XY | D0 | D1 | D2 | D3 | D4 | D5 |
D6 | D7 | S | FFT | MEAS1 | MEAS2 | MEAS3 | MEAS4 | CMEA |
NONE
*RST: C1

Usage: Asynchronous command

BUS:LIN:DATA:THReshold <ThresholdValue>

Sets the threshold value for digitization of signals manually. If the signal value is higher than the threshold, the signal state is high. Otherwise, the signal state is considered low.

This value is only considered for **BUS:LIN:TECHnology** USER

Parameters:

<ThresholdValue> Range: -400 to 400
Increment: 1E-3
*RST: 1.4
Default unit: V

BUS:LIN:POLarity <Polarity>

Defines the idle state of the bus. The idle state is the recessive state and corresponds to a logical 1.

Parameters:

<Polarity> IDLLow | IDLHigh
IDLLow
The bus is idle (state = 1) when the signal is low
IDLHigh
The bus is idle (state = 1) when the signal is high
*RST: IDLHigh

BUS:LIN:STANdard <Standard>

Selects the version of the LIN standard that is used in the DUT. The setting mainly defines the checksum version used during decoding.

Parameters:

<Standard> V1X | V2X | J2602 | AUTO
*RST: AUTO

BUS:LIN:TECHnology <ThresholdType>

Sets the threshold value for digitization of signals according to the specified technology. If the signal value is higher than the threshold, the signal state is high. Otherwise, the signal state is considered low.

To set a user-defined threshold, select `USER` and define the value using `BUS:LIN:DATA:THReshold` on page 296.

Parameters:

<ThresholdType> TTL | ECL | CMOS | CAN | GND | LIN7vsupply | LIN12vsupply | LIN18vsupply | USER

CMOS

2.5 V

LIN7vsupply | LIN12vsupply | LIN18vsupply

7 V / 12 V / 18 V

USER

Set the value with `BUS:LIN:DATA:THReshold`.

*RST: TTL

12.9.6.2 LIN Trigger

<code>TRIGger:LIN:CHKSError</code>	297
<code>TRIGger:LIN:DATA</code>	297
<code>TRIGger:LIN:DCondition</code>	298
<code>TRIGger:LIN:ICONdition</code>	298
<code>TRIGger:LIN:IDENtifier</code>	298
<code>TRIGger:LIN:IPERror</code>	298
<code>TRIGger:LIN:SYERror</code>	299
<code>TRIGger:LIN:TYPE</code>	299

TRIGger:LIN:CHKSError <ChecksumError>

Triggers on a checksum error if `TRIGger:LIN:TYPE` is set to `ERRC`

Parameters:

<ChecksumError> ON | OFF

*RST: ON

TRIGger:LIN:DATA <Pattern>

Defines the data pattern as trigger condition. Enter the words in MSB first bit order.

Parameters:

<Pattern>

String with max. 4 bytes in binary format. Characters 0, 1, and X are allowed. If you define a pattern with incomplete byte, the missing LSB are filled with X.

Example:

```
TRIG:LIN:TYPE IDDT
TRIG:LIN:IDEN 001001
TRIG:LIN:ICON EQU
TRIG:LIN:DCON EQU
TRIG:LIN:DATA '11111111000000001111'
TRIG:LIN:DATA?
<-- 11111111000000001111XXXX
Triggers when the id '001001' and the data
'11111111000000001111' is detected in the measured signal
```

TRIGger:LIN:DCONdition <Relation>

Defines how the specified data pattern is compared with the acquired signal.

Parameters:

<Relation> EQUal | NEQual
 *RST: EQUal

TRIGger:LIN:ICONdition <Relation>

Defines how the specified identifier pattern is compared with the acquired signal. The instrument triggers if the acquired address is equal or unequal the defined pattern.

Parameters:

<Relation> EQUal | NEQual
 *RST: EQUal

TRIGger:LIN:IDENtifier <Pattern>

Specifies the identifier pattern to be found, in binary format. Enter the pattern in MSB first bit order.

Parameters:

<Pattern> String with max. 7 characters. Characters 0, 1, and X are allowed. If you define a pattern shorter than the pattern length, the missing LSB are filled with X.

Example:

```
TRIG:LIN:TYPE ID
TRIG:LIN:IDEN 001001
TRIG:LIN:ICON EQU
Triggers if the ID of the measured signal is 001001.
```

TRIGger:LIN:IPERror <ParityError>

Triggers on a parity error if [TRIGger:LIN:TYPE](#) is set to ERRC

Parameters:

<ParityError> ON | OFF
 *RST: ON

TRIGger:LIN:SYERror <SyncError>

Triggers on a synchronization error if **TRIGger:LIN:TYPE** is set to **ERRC**

Parameters:

<SyncError> ON | OFF
*RST: ON

TRIGger:LIN:TYPE <TriggerType>**Parameters:**

<TriggerType> SYNC | WKFR | ERRC | ID | IDDT

SYNC

Triggers on the stop bit of the sync field.

WKFR

Triggers after a wakeup frame.

ERRC

Identifies various errors in the frame. You can select one or more error types as the trigger condition.

ID

Sets the trigger to a specific identifier or an identifier range.

IDDT

Sets the trigger to a combination of identifier and data condition. The instrument triggers at the end of the last byte of the specified data pattern.

*RST: SYNC

12.10 Logic Analyzer (R&S RTH-B1 MSO)

LOGic:STATe	299
LOGic:THCoupling	300
LOGic:GROup<m>:TECHnology	300
LOGic:GROup<m>:USER	301
LOGic:GROup<m>:THReshold?	301
LOGic:GROup<m>:HYSTeresis	301
LOGic:CHANnel<m>:DESKew	302
POD:STATe?	302

LOGic:STATe <State>

Enables or disables the logic channels.

Parameters:

<State> ON | OFF
*RST: OFF

LOGic:THCoupling <ThresCoup>

Couples the threshold and hysteresis settings for the logic channels.

If enabled, all logic channels use the same threshold and hysteresis settings.

If disabled, 2 channel groups are available, which can use different threshold and hysteresis settings: D0 - D3, and D4 - D7.

Parameters:

<ThresCoup> ON | OFF
 *RST: ON

LOGic:GROup<m>:TECHnology <ThresholdType>

Sets the threshold value for the selected channel group, or for all logic channels.

Suffix:

<m> 1..3
 1 = all logic channels D0 to D7
 2 = group D0 to D3
 3 = group D4 to D7
 The suffix only takes effect if **LOGic:THCoupling** is OFF.

Parameters:

<ThresholdType> TTL | ECL | CMOS | CAN | GND | LIN7vsupply | LIN12vsupply |
 LIN18vsupply | USER

TTL
 1.4 V

ECL
 -1.3 V

CMOS
 2.5 V

GND
 0 V (for CAN channels, requires option R&S RTH-K3)

CAN
 2 V (for CAN channels, requires option R&S RTH-K3)

LIN7vsupply | LIN12vsupply | LIN18vsupply
 7 V / 12 V / 18 V (for LIN channels, requires option R&S RTH-K3)

12 V Supply
 12 V (for LIN channels, requires option R&S RTH-K3)

18 V Supply
 18 V (for LIN channels, requires option R&S RTH-K3)

USER
 Set the value with **LOGic:GROup<m>:USER**.

*RST: TTL

LOGic:GROup<m>:USER <ThresholdValue>

Sets the threshold value if **LOGic:GROup<m>:TECHnology** is set to **USER**.

Suffix:

<m> 1..3
 1 = all logic channels D0 to D7
 2 = group D0 to D3
 3= group D4 to D7
 The suffix only takes effect if **LOGic:THCoupling** is **OFF**.

Parameters:

<ThresholdValue> Range: -400 to 400
 Increment: 1E-3
 *RST: 1.4
 Default unit: V

LOGic:GROup<m>:THReshold?

Returns the current threshold value.

Suffix:

<m> 1..3
 1 = all logic channels D0 to D7
 2 = group D0 to D3
 3= group D4 to D7

Return values:

<Level> Range: -10 to 10
 Increment: 1E-3
 *RST: 0
 Default unit: V

Usage: Query only

LOGic:GROup<m>:HYSTeresis <Hysteresis>

Hysteresis avoids the change of signal states due to noise oscillation around the threshold level. Set a small hysteresis for clean signals, and large hysteresis for noisy signals.

Suffix:

<m> 1..3
 1 = all logic channels D0 to D7
 2 = group D0 to D3
 3= group D4 to D7
 The suffix only takes effect if **LOGic:THCoupling** is **OFF**.

Parameters:

<Hysteresis> SMALL | MEDium | LARGe
 *RST: MEDium

LOGic:CHANnel<m>:DESKew <Value>

Sets the deskew for all channels of a logic probe at once, or for each logic channel separately.

Suffix:

<m> 1..9
 1..8: logic channels 0 to 7
 9: all logic channels

Parameters:

<Value> Range: -100E-9 to 100E-9
 Increment: 800E-12
 *RST: 0
 Default unit: s

Example:

```
LOGic:CHANnel9:DESKew 0.00000001
LOGic:CHANnel8:DESKew 0.00000002
LOGic:CHANnel1:DESKew?
<-- 1e-08
LOGic:CHANnel8:DESKew?
<-- 2e-08
```

POD:STATE?

Returns the connection state of the logic probe.

Return values:

<PODConnected> ON | OFF
 *RST: OFF

Usage: Query only

12.11 Documenting Results

12.11.1 Screenshots

The example program creates a screenshot and saves it to a file on the SD card. Then the screenshot data is read and deleted.

```
:HCOpy:LANGUage PNG
:MMEMory:NAME '/media/SD/Screenshot.png'
:HCOpy:IMMEDIATE;*OPC
:MMEMory:DATA? '/media/SD/Screenshot.png'
:MMEMory:DELeTe '/media/SD/Screenshot.png';*OPC
```

HCOPy:LANGuage.....	303
HCOPy:COLor.....	303
HCOPy:INVerse.....	303
MMEMory:NAME.....	303
HCOPy:IMMEDIATE.....	303

HCOPy:LANGuage <FileFormat>

Defines the format of the screenshot file.

Parameters:

<FileFormat> PNG | JPG | BMP | TIFF
 *RST: PNG

HCOPy:COLor <BlackWhite>

Creates a black and white screenshot.

Parameters:

<BlackWhite> ON | OFF
 *RST: OFF

HCOPy:INVerse <InverseColor>

Inverts the colors of the output, i.e. a dark waveform is printed on a white background.

Parameters:

<InverseColor> ON | OFF
 *RST: OFF

MMEMory:NAME <Filename>

Defines the filename of the next screenshot.

Parameters:

<Filename> String with the filename

HCOPy:IMMEDIATE

Saves the current display in a new screenshot.

Usage: Event

12.11.2 Waveform Data

The example program saves the data of channel 1 to a file on the SD card. Then the data is read and deleted.

```
:EXPort:WAVEform:NAME '/media/SD/Waveform.csv'
:EXPort:WAVEform:SOURce C1      oder :EXPort:WAVEform:MULTichannel 1
:EXPort:WAVEform:INCXvalues 1           // include time values
:EXPort:WAVEform:DLOGging 0           // without history
:EXPort:WAVEform:SAVE ;*OPC
:MMEMory:DATA? '/media/SD/Waveform.csv'
:MMEMory:DELeTe '/media/SD/Waveform.csv';*OPC
```

The example program saves the history data of channel 1 to a file on the SD card. Then the data is read and deleted.

```
:EXPort:WAVEform:NAME '/media/SD/WaveformHistory.zip'
:EXPort:WAVEform:SOURce C1      oder :EXPort:WAVEform:MULTichannel 1
:EXPort:WAVEform:INCXvalues 1           // include time values
:EXPort:WAVEform:DLOGging 1           // include history
:CHANnell:HISTory:STARt -77           // select segment range (optional)
:CHANnell:HISTory:STARt -5
:EXPort:WAVEform:SAVE ;*OPC
:MMEMory:DATA? '/media/SD/WaveformHistory.zip'
:MMEMory:DELeTe '/media/SD/WaveformHistory.zip';*OPC
```

12.12 General Instrument Setup

- [Date and Time](#).....304
- [Display Settings](#)..... 305

12.12.1 Date and Time

SYSTem:DATE [<Year>], [<Month>], [<Day>]

SYSTem:DATE? [<Year>], [<Month>]

Sets the date on the instrument.

Parameters:

<Day>	Range:	1 to 31
	Increment:	1
	*RST:	1

Parameters for setting and query:

<Year>	Range:	2012 to 2099
	Increment:	1
	*RST:	2012

<Month>	Range:	1 to 12
	Increment:	1
	*RST:	1

SYSTem:TIME [<Hours>], [<Minutes>], [<Seconds>]

SYSTem:TIME? [<Hours>], [<Minutes>]

Sets the time on the instrument.

Parameters:

<Seconds> Range: 0 to 59
 Increment: 1
 *RST: 1

Parameters for setting and query:

<Hours> Range: 0 to 24
 Increment: 1
 *RST: 1

<Minutes> Range: 0 to 59
 Increment: 1
 *RST: 1

12.12.2 Display Settings

DISPlay:PERsistence[:TYPE]	305
DISPlay:PERsistence:TIME	305
DISPlay:CONTRast	306
DISPlay:MOUS	306
DISPlay:LCD	306
DIAGnostic:SERVice:LCD:BRIGthness	306

DISPlay:PERsistence[:TYPE] <PersistenceType>

Defines how long every new data point remains on the screen.

Parameters:

<PersistenceType> OFF | TIME | INF

OFF

Deactivates persistence.

TIME

Data points remain on the screen for the duration defined with [DISPlay:PERsistence:TIME](#).

INF

Data points remain on the screen infinitely until persistence is set to OFF.

*RST: OFF

DISPlay:PERsistence:TIME <PersistenceTime>

Sets a user-defined persistence time. The command takes effect if [DISPlay:PERsistence\[:TYPE\]](#) is set to `TIME`.

Parameters:

<PersistenceTime> Range: 0.05 to 10
 Increment: 0.01
 *RST: 0.05
 Default unit: s

DISPlay:CONTRast <ContrastMode>

If enabled, the waveforms are displayed in black color on white background.

Parameters:

<ContrastMode> ON | OFF
 *RST: OFF

DISPlay:MOUS <EnableTouch>

Switches the touch functionality of the screen on or off.

If you use the instrument in an environment with immissions considerably higher than specified, the immissions may affect the touch sensitivity of the screen. In this case, disable the touch and operate the instrument using the keys and the wheel.

Parameters:

<EnableTouch> ON | OFF
 *RST: OFF

DISPlay:LCD <EnableLCD>

Turns the LCD display on or off.

Parameters:

<EnableLCD> ON | OFF
 *RST: OFF

DIAGnostic:SERVice:LCD:BRIGhtness <LCDBrightness>

Changes the brightness of the touchscreen.

Parameters:

<LCDBrightness> LOW | MEDium | HIGH
 *RST: MEDium

12.13 WLAN Connection (Option R&S RTH-K200/200US)

SYSTem:COMMunicate:WLAN:MODE <Mode>

Selects the wireless LAN function of the instrument. It can serve as access point or as client.

Parameters:

<Mode>

ACCesspoint | CLient

*RST: ACCesspoint

Annex

A SCPI Command Structure

SCPI commands consist of a so-called header and, in most cases, one or more parameters. The header and the parameters are separated by a "white space" (ASCII code 0 to 9, 11 to 32 decimal, e.g. blank). The headers may consist of several mnemonics (keywords). Queries are formed by appending a question mark directly to the header.

The commands can be either device-specific or device-independent (common commands). Common and device-specific commands differ in their syntax.

A.1 Syntax for Common Commands

Common (=device-independent) commands consist of a header preceded by an asterisk (*) and possibly one or more parameters.

Examples:

*RST	RESET	Resets the instrument.
*ESE	EVENT STATUS ENABLE	Sets the bits of the event status enable registers.
*ESR?	EVENT STATUS QUERY	Queries the contents of the event status register.
*IDN?	IDENTIFICATION QUERY	Queries the instrument identification string.

A.2 Syntax for Device-Specific Commands



Not all commands used in the following examples are necessarily implemented in the instrument.

For demonstration purposes only, assume the existence of the following commands for this section:

- DISPLAY[:WINDow<1...4>]:MAXimize <Boolean>
- FORMat:READings:DATA <type>[,<length>]
- HCOpy:DEvIce:COLor <Boolean>
- HCOpy:DEvIce:CMAP:COLor:RGB <red>,<green>,<blue>
- HCOpy[:IMMediate]
- HCOpy:ITEM:ALL
- HCOpy:ITEM:LABel <string>
- HCOpy:PAGE:DIMensions:QUADrant [<N>]
- HCOpy:PAGE:ORIEntation LANDscape | PORTRait
- HCOpy:PAGE:SCALE <numeric value>
- MMEMory:COpy <file_source>,<file_destination>
- SENSE:BANDwidth|BWIDth[:RESolution] <numeric_value>
- SENSE:FREQuency:STOP <numeric value>
- SENSE:LIST:FREQuency <numeric_value>{,<numeric_value>}

Long and short form

The mnemonics feature a long form and a short form. The short form is marked by upper case letters, the long form corresponds to the complete word. Either the short form or the long form can be entered; other abbreviations are not permitted.

Example:

HCOpy:DEvIce:COLor ON is equivalent to HCOP:DEV:COL ON.



Case-insensitivity

Upper case and lower case notation only serves to distinguish the two forms in the manual, the instrument itself is case-insensitive.

Numeric suffixes

If a command can be applied to multiple instances of an object, e.g. specific channels or sources, the required instances can be specified by a suffix added to the command. Numeric suffixes are indicated by angular brackets (<1...4>, <n>, <i>) and are replaced by a single value in the command. Entries without a suffix are interpreted as having the suffix 1.

Example:

Definition: `HCOPY:PAGE:DIMensions:QUADrant [<N>]`

Command: `HCOP:PAGE:DIM:QUAD2`

This command refers to the quadrant 2.

**Different numbering in remote control**

For remote control, the suffix may differ from the number of the corresponding selection used in manual operation. SCPI prescribes that suffix counting starts with 1. Suffix 1 is the default state and used when no specific suffix is specified.

Some standards define a fixed numbering, starting with 0. If the numbering differs in manual operation and remote control, it is indicated for the corresponding command.

Optional mnemonics

Some command systems permit certain mnemonics to be inserted into the header or omitted. These mnemonics are marked by square brackets in the description. The instrument must recognize the long command to comply with the SCPI standard. Some commands are considerably shortened by these optional mnemonics.

Example:

Definition: `HCOPY[:IMMEDIATE]`

Command: `HCOP:IMM` is equivalent to `HCOP`

**Optional mnemonics with numeric suffixes**

Do not omit an optional mnemonic if it includes a numeric suffix that is relevant for the effect of the command.

Example:

Definition: `DISPlay[:WINDow<1...4>]:MAXimize <Boolean>`

Command: `DISP:MAX ON` refers to window 1.

In order to refer to a window other than 1, you must include the optional `WINDow` parameter with the suffix for the required window.

`DISP:WIND2:MAX ON` refers to window 2.

Parameters

Parameters must be separated from the header by a "white space". If several parameters are specified in a command, they are separated by a comma (.). For a description of the parameter types, refer to [Chapter A.3, "SCPI Parameters"](#), on page 311.

Example:

Definition: `HCOPY:DEvice:CMAP:COLor:RGB <red>, <green>, <blue>`

Command: `HCOP:DEV:CMAP:COL:RGB 3, 32, 44`

Special characters

	<p>Parameters</p> <p>A vertical stroke in parameter definitions indicates alternative possibilities in the sense of "or". The effect of the command differs, depending on which parameter is used.</p> <p>Example:</p> <p>Definition: <code>HCOPY:PAGE:ORIENTATION LANDscape PORTRait</code></p> <p>Command <code>HCOPY:PAGE:ORI LAND</code> specifies landscape orientation</p> <p>Command <code>HCOPY:PAGE:ORI PORT</code> specifies portrait orientation</p> <p>Mnemonics</p> <p>A selection of mnemonics with an identical effect exists for several commands. These mnemonics are indicated in the same line; they are separated by a vertical stroke. Only one of these mnemonics needs to be included in the header of the command. The effect of the command is independent of which of the mnemonics is used.</p> <p>Example:</p> <p>Definition: <code>SENSE:BANDwidth BWIDTH[:RESolution] <numeric_value></code></p> <p>The two following commands with identical meaning can be created:</p> <p><code>SENS:BAND:RES 1</code></p> <p><code>SENS:BWID:RES 1</code></p>
[]	<p>Mnemonics in square brackets are optional and may be inserted into the header or omitted.</p> <p>Example: <code>HCOPY[:IMMEDIATE]</code></p> <p><code>HCOP:IMM</code> is equivalent to <code>HCOP</code></p>
{ }	<p>Parameters in curly brackets are optional and can be inserted once or several times, or omitted.</p> <p>Example: <code>SENSe:LIST:FREQuency <numeric_value>{,<numeric_value>}</code></p> <p>The following are valid commands:</p> <p><code>SENS:LIST:FREQ 10</code></p> <p><code>SENS:LIST:FREQ 10,20</code></p> <p><code>SENS:LIST:FREQ 10,20,30,40</code></p>

A.3 SCPI Parameters

Many commands are supplemented by a parameter or a list of parameters. The parameters must be separated from the header by a "white space" (ASCII code 0 to 9, 11 to 32 decimal, e.g. blank). Allowed parameters are:

- Numeric values
- Special numeric values
- Boolean parameters
- Text
- Character strings
- Block data

The parameters required for each command and the allowed range of values are specified in the command description.

Numeric values

Numeric values can be entered in any form, i.e. with sign, decimal point and exponent. Values exceeding the resolution of the instrument are rounded up or down. The mantissa may comprise up to 255 characters, the exponent must lie inside the value range -32000 to 32000. The exponent is introduced by an "E" or "e". Entry of the exponent alone is not allowed. In the case of physical quantities, the unit can be entered.

Allowed unit prefixes are G (giga), MA (mega), MOHM and MHZ (also allowed), K (kilo), M (milli), U (micro) and N (nano). If the unit is missing, the basic unit is used.

Example: `SENS:FREQ:STOP 1.5GHz = SENS:FREQ:STOP 1.5E9`

Units

For physical quantities, the unit can be entered. Allowed unit prefixes are:

- G (giga)
- MA (mega), MOHM, MHZ
- K (kilo)
- M (milli)
- U (micro)
- N (nano)

If the unit is missing, the basic unit is used.

Example:

`SENSe:FREQ:STOP 1.5GHz = SENSe:FREQ:STOP 1.5E9`

Some settings allow relative values to be stated in percent. According to SCPI, this unit is represented by the `PCT` string.

Example:

`HCOP:PAGE:SCAL 90PCT`

Special numeric values

The texts listed below are interpreted as special numeric values. In the case of a query, the numeric value is provided.

- **MIN/MAX**
MINimum and MAXimum denote the minimum and maximum value.
- **DEF**
DEFault denotes a preset value which has been stored in the EPROM. This value conforms to the default setting, as it is called by the `*RST` command.
- **UP/DOWN**
UP, DOWN increases or reduces the numeric value by one step. The step width can be specified via an allocated step command for each parameter which can be set via UP, DOWN.
- **INF/NINF**

INFINITY, Negative INFINITY (NINF) represent the numeric values 9.9E37 or -9.9E37, respectively. INF and NINF are only sent as instrument responses.

- **NAN**

Not A Number (NAN) represents the value 9.91E37. NAN is only sent as a instrument response. This value is not defined. Possible causes are the division of zero by zero, the subtraction of infinite from infinite and the representation of missing values.

Example:

Setting command: `SENSe:LIST:FREQ MAXimum`

Query: `SENS:LIST:FREQ?`, Response: `3.5E9`



Queries for special numeric values

The numeric values associated to `MAXimum`/`MINimum`/`DEFault` can be queried by adding the corresponding mnemonics to the command. They must be entered following the quotation mark.

Example: `SENSe:LIST:FREQ? MAXimum`

Returns the maximum numeric value as a result.

Boolean Parameters

Boolean parameters represent two states. The "ON" state (logically true) is represented by "ON" or a numeric value 1. The "OFF" state (logically untrue) is represented by "OFF" or the numeric value 0. The numeric values are provided as the response for a query.

Example:

Setting command: `HCOpy:DEV:COL ON`

Query: `HCOpy:DEV:COL?`

Response: `1`

Text parameters

Text parameters observe the syntactic rules for mnemonics, i.e. they can be entered using a short or long form. Like any parameter, they have to be separated from the header by a white space. In the case of a query, the short form of the text is provided.

Example:

Setting command: `HCOpy:PAGE:ORientation LANDscape`

Query: `HCOp:PAGE:ORI?`

Response: `LAND`

Character strings

Strings must always be entered in quotation marks (' or ").

Example:

```
HCOP:ITEM:LABel "Test1" or HCOP:ITEM:LABel 'Test1'
```

Block data

Block data is a format which is suitable for the transmission of large amounts of data. A command using a block data parameter has the following structure:

Example:

```
FORMat:READings:DATA #45168xxxxxxxx
```

The ASCII character # introduces the data block. The next number indicates how many of the following digits describe the length of the data block. In the example the 4 following digits indicate the length to be 5168 bytes. The data bytes follow. During the transmission of these data bytes all end or other control signs are ignored until all bytes are transmitted.

#0 specifies a data block of indefinite length. The use of the indefinite format requires a `NL^END` message to terminate the data block. This format is useful when the length of the transmission is not known or if speed or other considerations prevent segmentation of the data into blocks of definite length.

A.4 Overview of Syntax Elements

The following table provides an overview of the syntax elements:

:	The colon separates the mnemonics of a command. In a command line the separating semicolon marks the uppermost command level.
;	The semicolon separates two commands of a command line. It does not alter the path.
,	The comma separates several parameters of a command.
?	The question mark forms a query.
*	The asterisk marks a common command.
'' ..	Quotation marks introduce a string and terminate it (both single and double quotation marks are possible).
#	The hash symbol introduces binary, octal, hexadecimal and block data. <ul style="list-style-type: none"> • Binary: #B10110 • Octal: #O7612 • Hexa: #HF3A7 • Block: #21312
	A "white space" (ASCII-Code 0 to 9, 11 to 32 decimal, e.g. blank) separates the header from the parameters.

A.5 Structure of a command line

A command line may consist of one or several commands. It is terminated by one of the following:

- a <New Line>
- a <New Line> with EOI
- an EOI together with the last data byte

Several commands in a command line must be separated by a semicolon ";". If the next command belongs to a different command system, the semicolon is followed by a colon.

Example:

```
MMEM:COPY "Test1", "MeasurementXY";:HCOP:ITEM ALL
```

This command line contains two commands. The first command belongs to the MMEM system, the second command belongs to the HCOP system.

If the successive commands belong to the same system, having one or several levels in common, the command line can be abbreviated. To this end, the second command after the semicolon starts with the level that lies below the common levels. The colon following the semicolon must be omitted in this case.

Example:

```
HCOP:ITEM ALL;:HCOP:IMM
```

This command line contains two commands. Both commands are part of the HCOP command system, i.e. they have one level in common.

When abbreviating the command line, the second command begins with the level below HCOP. The colon after the semicolon is omitted. The abbreviated form of the command line reads as follows:

```
HCOP:ITEM ALL;IMM
```

A new command line always begins with the complete path.

Example:

```
HCOP:ITEM ALL
```

```
HCOP:IMM
```

A.6 Responses to Queries

A query is defined for each setting command unless explicitly specified otherwise. It is formed by adding a question mark to the associated setting command. According to SCPI, the responses to queries are partly subject to stricter rules than in standard IEEE 488.2.

- The requested parameter is transmitted without a header.

Example: `HCOP:PAGE:ORI?`, **Response:** `LAND`

- Maximum values, minimum values and all other quantities that are requested via a special text parameter are returned as numeric values.

Example: `SENSe:FREQuency:STOP? MAX`, **Response:** `3.5E9`

- Numeric values are output without a unit. Physical quantities are referred to the basic units or to the units set using the `Unit` command. The response `3.5E9` in the previous example stands for 3.5 GHz.

- Truth values (Boolean values) are returned as 0 (for OFF) and 1 (for ON).

Example:

Setting command: `HCOPy:DEV:COL ON`

Query: `HCOPy:DEV:COL?`

Response: `1`

- Text (character data) is returned in a short form.

Example:

Setting command: `HCOPy:PAGE:ORIENTATION LANDscape`

Query: `HCOP:PAGE:ORI?`

Response: `LAND`

B Command Sequence and Synchronization

IEEE 488.2 defines a distinction between overlapped (asynchronous) and sequential commands:

- A sequential command finishes executing before the next command starts executing. Commands that are processed quickly are usually implemented as sequential commands.
- An overlapping or asynchronous command does not automatically finish executing before the next command starts executing. Usually, overlapping commands take longer to process and allow the program to do other tasks while being executed. If overlapping commands must be executed in a defined order, e.g. to avoid wrong measurement results, they must be serviced sequentially. This method is called synchronization between the controller and the instrument.

Setting commands within one command line, even though they are implemented as sequential commands, are not necessarily serviced in the order in which they have been received. To make sure that commands are carried out in a certain order, each command must be sent in a separate command line.

Example: Commands and queries in one message

Do not combine queries with commands that affect the queried value in one program message because the response to the query is not predictable.

The following commands always return the specified result:

```
:CHAN:SCAL 0.01;POS 1
```

```
:CHAN:SCAL?
```

Result:

```
0.01 (10 mV/div)
```



As a rule, send commands and queries in different program messages.

For further information, refer to:

- rohde-schwarz.com/rckb: Rohde & Schwarz web page that provides information on instrument drivers and remote control.
- "Automatic Measurement Control - A tutorial on SCPI and IEEE 488.2" from John M. Pieper (R&S order number 0002.3536.00). The book offers detailed information on concepts and definitions of SCPI.

B.1 Preventing Overlapping Execution

To prevent an overlapping execution of commands, one of the commands *OPC, *OPC? or *WAI can be used. All three commands cause a certain action only to be carried out after the hardware has been set. By suitable programming, the controller can be forced to wait for the corresponding action to occur.

Table B-1: Synchronization using *OPC, *OPC? and *WAI

Command	Action	Programming the controller
*OPC	Sets the Operation Complete bit in the ESR after all previous commands have been executed.	<ul style="list-style-type: none"> Setting bit 0 in the ESE Setting bit 5 in the SRE Waiting for service request (SRQ)
*OPC?	Stops command processing until 1 is returned. This is only the case after the Operation Complete bit has been set in the ESR. This bit indicates that the previous setting has been completed.	Sending *OPC? directly after the command whose processing should be terminated before other commands can be executed.
*WAI	Stops further command processing until all commands sent before *WAI have been executed.	Sending *WAI directly after the command whose processing should be terminated before other commands are executed.

Command synchronization using *WAI or *OPC? is a good choice if the overlapped command takes only little time to process. The two synchronization commands simply block overlapped execution of the command. Append the synchronization command to the overlapping command, for example:

```
SINGLE; *OPC?
```

For time consuming overlapped commands you can allow the controller or the instrument to do other useful work while waiting for command execution. Use one of the following methods:

***OPC with a service request**

1. Set the OPC mask bit (bit no. 0) in the ESE: *ESE 1
2. Set bit no. 5 in the SRE: *SRE 32 to enable ESB service request.
3. Send the overlapped command with *OPC
4. Wait for a service request

The service request indicates that the overlapped command has finished.

***OPC? with a service request**

1. Set bit no. 4 in the SRE: *SRE 16 to enable MAV service request.
2. Send the overlapped command with *OPC?
3. Wait for a service request

The service request indicates that the overlapped command has finished.

Event Status Register (ESE)

1. Set the OPC mask bit (bit no. 0) in the ESE: *ESE 1
2. Send the overlapped command without *OPC, *OPC? or *WAI

3. Poll the operation complete state periodically (by means of a timer) using the sequence: *OPC; *ESR?

A return value (LSB) of 1 indicates that the overlapped command has finished.

List of Commands

ACQUIRE:ARESet:IMMediate.....	197
ACQUIRE:AVAILable?.....	234
ACQUIRE:AVERAge:COUNT.....	197
ACQUIRE:MODE.....	196
ACQUIRE:POINts:ARATe?.....	196
ACQUIRE:POINts:VALue]?.....	197
ACQUIRE:RESolution?.....	198
AUToscale.....	190
BUS:CAN:BITRate.....	289
BUS:CAN:DATA:SOURce.....	289
BUS:CAN:DATA:THReshold.....	290
BUS:CAN:SAMPlepoint.....	290
BUS:CAN:TECHnology.....	291
BUS:CAN:TYPE.....	291
BUS:FORMat.....	277
BUS:I2C:SCL:SOURce.....	278
BUS:I2C:SCL:THReshold.....	278
BUS:I2C:SDA:SOURce.....	278
BUS:I2C:SDA:THReshold.....	278
BUS:I2C:TECHnology.....	278
BUS:LIN:BITRate.....	295
BUS:LIN:DATA:SOURce.....	296
BUS:LIN:DATA:THReshold.....	296
BUS:LIN:POLarity.....	296
BUS:LIN:STANdard.....	296
BUS:LIN:TECHnology.....	297
BUS:SPI:MISO:SOURce.....	281
BUS:SPI:MISO:THReshold.....	282
BUS:SPI:MOSI:SOURce.....	281
BUS:SPI:MOSI:THReshold.....	282
BUS:SPI:ORDer.....	283
BUS:SPI:SCLK:SLOPe.....	282
BUS:SPI:SCLK:SOURce.....	281
BUS:SPI:SCLK:THReshold.....	282
BUS:SPI:SSEL:POLarity.....	282
BUS:SPI:SSEL:SOURce.....	281
BUS:SPI:SSEL:STATe.....	284
BUS:SPI:SSEL:THReshold.....	282
BUS:SPI:TECHnology.....	282
BUS:SPI:TIMEout.....	283
BUS:SPI:WSIZe.....	283
BUS:TYPE.....	277
BUS:UART:BITRate.....	286
BUS:UART:FRAMemode.....	288
BUS:UART:ORDer.....	287
BUS:UART:PARity.....	287
BUS:UART:POLarity.....	285

BUS:UART:SBIT.....	287
BUS:UART:SOURce.....	285
BUS:UART:SSIZe.....	287
BUS:UART:STDBitrate.....	286
BUS:UART:TECHnology.....	286
BUS:UART:THReshold.....	286
BUS:UART:TOUT.....	288
BUS[:STATe].....	277
CALCulate:MATH:STATe.....	231
CALCulate:MATH:VERTical:POSition.....	232
CALCulate:MATH:VERTical:RANGe.....	232
CALCulate:MATH:VERTical:SCALe.....	231
CALCulate:MATH[:EXPRession][:DEFine].....	231
CHANnel<m>:BANDwidth.....	192
CHANnel<m>:COUPling.....	192
CHANnel<m>:DESKew.....	193
CHANnel<m>:HISTory:CURRent.....	235
CHANnel<m>:HISTory:NSEGments.....	234
CHANnel<m>:HISTory:PLAY.....	235
CHANnel<m>:HISTory:REPLay.....	235
CHANnel<m>:HISTory:START.....	234
CHANnel<m>:HISTory:STOP.....	235
CHANnel<m>:HISTory:TPACq.....	234
CHANnel<m>:HISTory:TSABsolute?.....	236
CHANnel<m>:HISTory:TSDate?.....	236
CHANnel<m>:HISTory:TSRelative?.....	236
CHANnel<m>:HISTory[:STATe].....	234
CHANnel<m>:OFFSet.....	192
CHANnel<m>:POLarity.....	191
CHANnel<m>:POSition.....	192
CHANnel<m>:RANGe.....	191
CHANnel<m>:SCALe.....	191
CHANnel<m>:STATe.....	190
CHANnel<m>:THReshold:TECHnology.....	193
CHANnel<m>:THReshold:THReshold?.....	194
CHANnel<m>:THReshold:USER.....	194
CURSor:COUPling.....	228
CURSor:DELTA?.....	229
CURSor:FUNCTion.....	227
CURSor:ITDelta?.....	229
CURSor:MEASurement<m>:RESult:ACTual?.....	230
CURSor:MEASurement<m>:RESult:LIMit?.....	230
CURSor:MEASurement<m>:TYPE.....	228
CURSor:SCPLing.....	228
CURSor:SCReen.....	228
CURSor:SOURce.....	227
CURSor:STATe.....	227
CURSor:TDELTA?.....	229
CURSor:X1Position.....	229
CURSor:X2Position.....	229

CURSor:Y1AMplitude?.....	230
CURSor:Y1Position.....	230
CURSor:Y2AMplitude?.....	230
CURSor:Y2Position.....	230
DIAGnostic:SERVice:LCD:BRIGhtness.....	306
DISPlay:CONTrast.....	306
DISPlay:LCD.....	306
DISPlay:MOUS.....	306
DISPlay:PERSiStence:TIME.....	305
DISPlay:PERSiStence[:TYPE].....	305
HCOPy:COLor.....	303
HCOPy:IMMEDIATE.....	303
HCOPy:INVerse.....	303
HCOPy:LANGUage.....	303
LOGGer:ACLR.....	270
LOGGer:CURSor:TDELta?.....	272
LOGGer:CURSor<m>:COUPling.....	271
LOGGer:CURSor<m>:POSition.....	271
LOGGer:CURSor<m>:RESult<n>[:AMPLitude]?.....	272
LOGGer:CURSor<m>:SCPLing.....	271
LOGGer:CURSor<m>:SCReen.....	271
LOGGer:CURSor<m>:STATe.....	270
LOGGer:CURSor<m>:TYPE.....	270
LOGGer:MEASurement<m>:ENABled?.....	276
LOGGer:MEASurement<m>:RESult:CURRentsampL?.....	274
LOGGer:MEASurement<m>:RESult:MAXimum:POSition?.....	274
LOGGer:MEASurement<m>:RESult:MAXimum:VALue?.....	274
LOGGer:MEASurement<m>:RESult:MEAN?.....	275
LOGGer:MEASurement<m>:RESult:MINimum:POSition?.....	275
LOGGer:MEASurement<m>:RESult:MINimum:VALue?.....	275
LOGGer:MEASurement<m>:RESult:STDDev?.....	275
LOGGer:MEASurement<m>:SOURce?.....	276
LOGGer:MEASurement<m>:TYPE?.....	276
LOGGer:RECORDing:STARt?.....	273
LOGGer:RECORDing:TOTAL?.....	274
LOGGer:SLOT:CLear.....	270
LOGGer:SLOT:CURRent.....	269
LOGGer:SLOT:LOAD.....	269
LOGGer:SOURce.....	269
LOGGer:TIMEbase:SCALE.....	269
LOGGer:TIMEbase:SRATE.....	269
LOGGer:ZOOM:ENABle.....	273
LOGGer:ZOOM:POSition.....	273
LOGGer:ZOOM:SCALE.....	273
LOGic:CHANnel<m>:DESKew.....	302
LOGic:GROup<m>:HYSTEResis.....	301
LOGic:GROup<m>:TECHnology.....	300
LOGic:GROup<m>:THREShold?.....	301
LOGic:GROup<m>:USER.....	301
LOGic:STATe.....	299

LOGic:THCoupling.....	300
MASK:CHANnel<m>:CREatemask.....	237
MASK:CHANnel<m>:PROPERTIES:XWIDTH.....	237
MASK:CHANnel<m>:PROPERTIES:YWIDTH.....	237
MASK:CHANnel<m>:RESult:FAIL:PERcentage?.....	238
MASK:CHANnel<m>:RESult:FAIL[:COUNT]?.....	239
MASK:CHANnel<m>:RESult:PASS:PERcentage?.....	239
MASK:CHANnel<m>:RESult:PASS[:COUNT]?.....	239
MASK:CHANnel<m>:RESult:TOTL[:COUNT]?.....	240
MASK:CHANnel<m>:STATe.....	237
MASK:ELAPsedtime:TOTal?.....	240
MASK:ELAPsedtime[:SECS]?.....	240
MASK:ONViolation[:SElection].....	238
MASK:RST.....	238
MASK[:TESTstate]?.....	238
MEASurement<m>:AOFF.....	226
MEASurement<m>:DELay:SLOPe.....	226
MEASurement<m>:ENABle.....	224
MEASurement<m>:RESult:ACTual?.....	226
MEASurement<m>:RESult:LIMit?.....	226
MEASurement<m>:SOURce.....	225
MEASurement<m>:TYPE.....	225
METer:CONFigure:CAPacitance.....	242
METer:CONFigure:CONTInuity.....	242
METer:CONFigure:CURRent:AC.....	243
METer:CONFigure:CURRent:DC.....	243
METer:CONFigure:DIODE.....	242
METer:CONFigure:FREQuency.....	243
METer:CONFigure:RESistance.....	243
METer:CONFigure:TEMPerature.....	242
METer:CONFigure:VALue?.....	252
METer:CONFigure:VOLTagE:AC.....	244
METer:CONFigure:VOLTagE:DC.....	244
METer:MEASure:CAPacitance?.....	254
METer:MEASure:CONTInuity?.....	254
METer:MEASure:CURRent:AC?.....	254
METer:MEASure:CURRent:DC?.....	254
METer:MEASure:DIODE?.....	254
METer:MEASure:FREQuency?.....	254
METer:MEASure:RESistance?.....	255
METer:MEASure:TEMPerature?.....	254
METer:MEASure:VOLTagE:AC?.....	255
METer:MEASure:VOLTagE:DC?.....	255
METer:SENSe:CAPacitance:NULL:STATe.....	249
METer:SENSe:CAPacitance:NULL:VALue.....	250
METer:SENSe:CAPacitance:RANGe:AUTO.....	246
METer:SENSe:CAPacitance:RANGe:UPPer.....	244
METer:SENSe:CURRent:AC:NULL:STATe.....	249
METer:SENSe:CURRent:AC:NULL:VALue.....	250
METer:SENSe:CURRent:AC:RANGe:AUTO.....	246

METer:SENSe:CURRent:AC:RANGe:UPPer.....	245
METer:SENSe:CURRent:DC:NULL:STATe.....	249
METer:SENSe:CURRent:DC:NULL:VALue.....	250
METer:SENSe:CURRent:DC:RANGe:AUTO.....	246
METer:SENSe:CURRent:DC:RANGe:UPPer.....	245
METer:SENSe:FREQUency:VOLTagE:RANGe:AUTO.....	246
METer:SENSe:FREQUency:VOLTagE:RANGe:UPPer.....	245
METer:SENSe:FUNCTion.....	251
METer:SENSe:RESistance:NULL:STATe.....	249
METer:SENSe:RESistance:NULL:VALue.....	250
METer:SENSe:RESistance:RANGe:AUTO.....	246
METer:SENSe:RESistance:RANGe:UPPer.....	245
METer:SENSe:TEMPerature:NULL:STATe.....	249
METer:SENSe:TEMPerature:NULL:VALue.....	250
METer:SENSe:TEMPerature:TRANsductor:RTD:TYPE.....	248
METer:SENSe:VOLTagE:AC:NULL:STATe.....	249
METer:SENSe:VOLTagE:AC:NULL:VALue.....	250
METer:SENSe:VOLTagE:AC:RANGe:AUTO.....	246
METer:SENSe:VOLTagE:AC:RANGe:UPPer.....	246
METer:SENSe:VOLTagE:DC:NULL:STATe.....	249
METer:SENSe:VOLTagE:DC:NULL:VALue.....	250
METer:SENSe:VOLTagE:DC:RANGe:AUTO.....	246
METer:SENSe:VOLTagE:DC:RANGe:UPPer.....	246
METer:UNIT:TEMPerature.....	248
METer<m>:ABORT.....	252
METer<m>:ABORT.....	265
METer<m>:CALCulate:AVERage:AVERage?.....	255
METer<m>:CALCulate:AVERage:AVERage?.....	267
METer<m>:CALCulate:AVERage:CLEar.....	256
METer<m>:CALCulate:AVERage:CLEar.....	268
METer<m>:CALCulate:AVERage:MAXimum?.....	256
METer<m>:CALCulate:AVERage:MAXimum?.....	267
METer<m>:CALCulate:AVERage:MINimum?.....	256
METer<m>:CALCulate:AVERage:MINimum?.....	267
METer<m>:CONFigure:CURRent:AC.....	259
METer<m>:CONFigure:CURRent:DC.....	259
METer<m>:CONFigure:VALue?.....	264
METer<m>:CONFigure:VOLTagE:AC.....	259
METer<m>:CONFigure:VOLTagE:DC.....	259
METer<m>:FETCh?.....	253
METer<m>:FETCh?.....	265
METer<m>:MEASure:CURRent:AC?.....	266
METer<m>:MEASure:CURRent:DC?.....	266
METer<m>:MEASure:VOLTagE:AC?.....	266
METer<m>:MEASure:VOLTagE:DC?.....	266
METer<m>:READ?.....	253
METer<m>:READ?.....	265
METer<m>:SENSe:CURRent:AC:COUPling.....	247
METer<m>:SENSe:CURRent:AC:COUPling.....	261
METer<m>:SENSe:CURRent:AC:NULL:STATe.....	262

METer<m>:SENSe:CURRent:AC:NULL:VALue.....	263
METer<m>:SENSe:CURRent:AC:RANGe:UPPer.....	260
METer<m>:SENSe:CURRent:DC:NULL:STATe.....	262
METer<m>:SENSe:CURRent:DC:NULL:VALue.....	263
METer<m>:SENSe:CURRent:DC:RANGe:UPPer.....	260
METer<m>:SENSe:FUNCTion.....	263
METer<m>:SENSe:NULL:STATe.....	249
METer<m>:SENSe:NULL:STATe.....	262
METer<m>:SENSe:NULL:VALU.....	251
METer<m>:SENSe:NULL:VALU.....	263
METer<m>:SENSe:RANGe.....	258
METer<m>:SENSe:RELative:STATe.....	249
METer<m>:SENSe:RELative:STATe.....	262
METer<m>:SENSe:SOURce.....	258
METer<m>:SENSe:STATe.....	257
METer<m>:SENSe:VOLTagE:AC:COUPling.....	247
METer<m>:SENSe:VOLTagE:AC:COUPling.....	261
METer<m>:SENSe:VOLTagE:AC:NULL:STATe.....	262
METer<m>:SENSe:VOLTagE:AC:NULL:VALue.....	263
METer<m>:SENSe:VOLTagE:AC:RANGe:UPPer.....	260
METer<m>:SENSe:VOLTagE:DC:NULL:STATe.....	262
METer<m>:SENSe:VOLTagE:DC:NULL:VALue.....	263
METer<m>:SENSe:VOLTagE:DC:RANGe:UPPer.....	260
METer<m>:TRIGger:MODE.....	252
METer<m>:TRIGger:MODE.....	264
MMEMory:NAME.....	303
OP[:MODE].....	189
OP[:MODE].....	241
POD:STATe?.....	302
REFCurve:DELeTe.....	233
REFCurve:NAME.....	233
REFCurve:OPEN.....	233
REFCurve:POSition.....	233
REFCurve:SAVE.....	233
REFCurve:SOURce.....	232
REFCurve:STATe.....	232
REFCurve:UPDate.....	232
RUN.....	196
STOP.....	196
SYSTem:COMMunicate:WLAN:MODE.....	306
SYSTem:DATE.....	304
SYSTem:TIME.....	305
TIMebase:HORIZontal:POSition.....	195
TIMebase:RANGe.....	195
TIMebase:REFerence.....	195
TIMebase:SCALE.....	195
TRIGger:CAN:ACKerror.....	292
TRIGger:CAN:BITSterror.....	292
TRIGger:CAN:CRCError.....	292
TRIGger:CAN:DATA.....	292

TRIGger:CAN:DCONdition.....	292
TRIGger:CAN:FORMerror.....	292
TRIGger:CAN:FTYPE.....	293
TRIGger:CAN:ICONdition.....	293
TRIGger:CAN:IDENtifier.....	293
TRIGger:CAN:ITYPE.....	294
TRIGger:CAN:TYPE.....	294
TRIGger:DATatoclock:CONDItion.....	216
TRIGger:DATatoclock:CSource:EDGE.....	216
TRIGger:DATatoclock:CSource[:VALue].....	216
TRIGger:DATatoclock:DSource[:VALue].....	216
TRIGger:DATatoclock:HTime.....	217
TRIGger:DATatoclock:STime.....	217
TRIGger:EDGE:SLOPe.....	201
TRIGger:EXTernal:LEVel.....	207
TRIGger:EXTernal:SLOPe.....	208
TRIGger:GLITch:POLarity.....	202
TRIGger:GLITch:RANGe.....	202
TRIGger:GLITch:WIDTh.....	202
TRIGger:HOLDoff:EVENTs.....	201
TRIGger:HOLDoff:MAX.....	201
TRIGger:HOLDoff:MIN.....	201
TRIGger:HOLDoff:MODE.....	200
TRIGger:HOLDoff:TIME.....	200
TRIGger:I2C:ACCess.....	280
TRIGger:I2C:ACONdition.....	280
TRIGger:I2C:ADDRess.....	280
TRIGger:I2C:ADNack.....	279
TRIGger:I2C:DATA.....	280
TRIGger:I2C:DCONdition.....	280
TRIGger:I2C:DPOSItion.....	281
TRIGger:I2C:DRNack.....	279
TRIGger:I2C:DWNack.....	279
TRIGger:I2C:MODE.....	279
TRIGger:INTerval:DELTA.....	220
TRIGger:INTerval:MAXWIDth.....	221
TRIGger:INTerval:MINWIDth.....	220
TRIGger:INTerval:RANGe.....	220
TRIGger:INTerval:SLOPe.....	219
TRIGger:INTerval:WIDTh.....	220
TRIGger:LEVel<m>:RUNT:LOWer.....	211
TRIGger:LEVel<m>:RUNT:UPPer.....	211
TRIGger:LEVel<m>:SLEW:LOWer.....	214
TRIGger:LEVel<m>:SLEW:UPPer.....	214
TRIGger:LEVel<m>:VALue.....	199
TRIGger:LEVel<m>:WINDow:LOWer.....	221
TRIGger:LEVel<m>:WINDow:UPPer.....	221
TRIGger:LIN:CHKSError.....	297
TRIGger:LIN:DATA.....	297
TRIGger:LIN:DCONdition.....	298

TRIGger:LIN:ICONdition.....	298
TRIGger:LIN:IDENtifier.....	298
TRIGger:LIN:IPERror.....	298
TRIGger:LIN:SYERror.....	299
TRIGger:LIN:TYPE.....	299
TRIGger:MNR.....	201
TRIGger:MODE.....	198
TRIGger:PATtern:STATe:COMBination.....	208
TRIGger:PATtern:STATe[:CHANnel<m>].....	208
TRIGger:PATtern:TIMEout[:TIME].....	209
TRIGger:PATtern:WIDTh:DELTA.....	210
TRIGger:PATtern:WIDTh:RANGe.....	209
TRIGger:PATtern:WIDTh[:WIDTh].....	209
TRIGger:RUNT:DELTA.....	213
TRIGger:RUNT:MAXWidth.....	213
TRIGger:RUNT:MAXWidth.....	213
TRIGger:RUNT:MINWidth.....	213
TRIGger:RUNT:POLarity.....	212
TRIGger:RUNT:RANGe.....	212
TRIGger:RUNT:WIDTh.....	212
TRIGger:SLEW:DELTA.....	215
TRIGger:SLEW:MAXWidth.....	216
TRIGger:SLEW:MINWidth.....	215
TRIGger:SLEW:RANGe.....	214
TRIGger:SLEW:RATE.....	215
TRIGger:SLEW:SLOPe.....	214
TRIGger:SOURce.....	199
TRIGger:SPATtern:CSOURce:EDGE.....	218
TRIGger:SPATtern:CSOURce:FIRStedge.....	218
TRIGger:SPATtern:CSOURce[:VALue].....	218
TRIGger:SPATtern:DSOURce[:VALue].....	217
TRIGger:SPATtern:ORDer.....	218
TRIGger:SPATtern:PATtern.....	218
TRIGger:SPI:DATA.....	284
TRIGger:SPI:DCONdition.....	284
TRIGger:SPI:DPOStion.....	285
TRIGger:SPI:DSRC.....	284
TRIGger:SPI:MODE.....	283
TRIGger:STATe:CHANnel<m>.....	210
TRIGger:STATe:COMBination.....	211
TRIGger:STATe:CSOURce:EDGE.....	211
TRIGger:STATe:CSOURce[:VALue].....	211
TRIGger:TIMEout:RANGe.....	219
TRIGger:TIMEout:TIME.....	219
TRIGger:TV:CUSTom:LDURation.....	207
TRIGger:TV:CUSTom:SCANmode.....	207
TRIGger:TV:CUSTom:SDURation.....	207
TRIGger:TV:CUSTom:STYPe.....	206
TRIGger:TV:LFIeld.....	206
TRIGger:TV:LINE.....	206

TRIGger:TV:MODE.....	205
TRIGger:TV:POLarity.....	205
TRIGger:TV:STANdard.....	204
TRIGger:TYPE.....	199
TRIGger:UART:DATA.....	288
TRIGger:UART:DCONDition.....	289
TRIGger:UART:TYPE.....	288
TRIGger:WIDTh:DELTA.....	203
TRIGger:WIDTh:MAX.....	204
TRIGger:WIDTh:MIN.....	204
TRIGger:WIDTh:POLarity.....	202
TRIGger:WIDTh:RANGe.....	203
TRIGger:WIDTh:WIDTh.....	203
TRIGger:WINDow:DELTA.....	223
TRIGger:WINDow:MAXWidth.....	223
TRIGger:WINDow:MINWidth.....	223
TRIGger:WINDow:RANGe.....	222
TRIGger:WINDow:TIME.....	221
TRIGger:WINDow:WIDTh.....	222
ZOOM:ENABle.....	223
ZOOM:POSition.....	224
ZOOM:SCALe.....	224