

Power Supply/Load Module

User Manual



1504.4560.12 – 05

This manual describes the following R&S®TSVP module:

- R&S®TS-PSU

© 2016 Rohde & Schwarz GmbH & Co. KG

Mühlhofstr. 15, 81671 München, Germany

Phone: +49 89 41 29 - 0

Fax: +49 89 41 29 12 164

Email: info@rohde-schwarz.com

Internet: www.rohde-schwarz.com

Subject to change – Data without tolerance limits is not binding.

R&S® is a registered trademark of Rohde & Schwarz GmbH & Co. KG.

Trade names are trademarks of the owners.

The following abbreviations are used throughout this manual: R&S®TS-PSU is abbreviated as R&S TS-PSU.

Basic Safety Instructions

Always read through and comply with the following safety instructions!

All plants and locations of the Rohde & Schwarz group of companies make every effort to keep the safety standards of our products up to date and to offer our customers the highest possible degree of safety. Our products and the auxiliary equipment they require are designed, built and tested in accordance with the safety standards that apply in each case. Compliance with these standards is continuously monitored by our quality assurance system. The product described here has been designed, built and tested in accordance with the EC Certificate of Conformity and has left the manufacturer's plant in a condition fully complying with safety standards. To maintain this condition and to ensure safe operation, you must observe all instructions and warnings provided in this manual. If you have any questions regarding these safety instructions, the Rohde & Schwarz group of companies will be happy to answer them.







Furthermore, it is your responsibility to use the product in an appropriate manner. This product is designed for use solely in industrial and laboratory environments or, if expressly permitted, also in the field and must not be used in any way that may cause personal injury or property damage. You are responsible if the product is used for any purpose other than its designated purpose or in disregard of the manufacturer's instructions. The manufacturer shall assume no responsibility for such use of the product.

The product is used for its designated purpose if it is used in accordance with its product documentation and within its performance limits (see data sheet, documentation, the following safety instructions). Using the product requires technical skills and, in some cases, a basic knowledge of English. It is therefore essential that only skilled and specialized staff or thoroughly trained personnel with the required skills be allowed to use the product. If personal safety gear is required for using Rohde & Schwarz products, this will be indicated at the appropriate place in the product documentation. Keep the basic safety instructions and the product documentation in a safe place and pass them on to the subsequent users.











Observing the safety instructions will help prevent personal injury or damage of any kind caused by dangerous situations. Therefore, carefully read through and adhere to the following safety instructions before and when using the product. It is also absolutely essential to observe the additional safety instructions on personal safety, for example, that appear in relevant parts of the product documentation. In these safety instructions, the word "product" refers to all merchandise sold and distributed by the Rohde & Schwarz group of companies, including instruments, systems and all accessories. For product-specific information, see the data sheet and the product documentation.

Safety labels on products

The following safety labels are used on products to warn against risks and dangers.

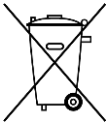
Symbol	Meaning	Symbol	Meaning
	Notice, general danger location Observe product documentation		ON/OFF Power
	Caution when handling heavy equipment		Standby indication
	Danger of electric shock		Direct current (DC)

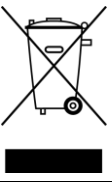
Basic Safety Instructions

Symbol	Meaning	Symbol	Meaning
	Caution ! Hot surface		Alternating current (AC)
	Protective conductor terminal To identify any terminal which is intended for connection to an external conductor for protection against electric shock in case of a fault, or the terminal of a protective earth		Direct/alternating current (DC/AC)
	Earth (Ground)		Class II Equipment to identify equipment meeting the safety requirements specified for Class II equipment (device protected by double or reinforced insulation)
	Frame or chassis Ground terminal		EU labeling for batteries and accumulators For additional information, see section "Waste disposal/Environmental protection", item 1.
	Be careful when handling electrostatic sensitive devices		EU labeling for separate collection of electrical and electronic devices For additional information, see section "Waste disposal/Environmental protection", item 2.
	Warning! Laser radiation For additional information, see section "Operation", item 7.		

Signal words and their meaning

The following signal words are used in the product documentation in order to warn the reader about risks and dangers.



Indicates a hazardous situation which, if not avoided, will result in death or serious injury.



Indicates a hazardous situation which, if not avoided, could result in death or serious injury.



Indicates a hazardous situation which, if not avoided, could result in minor or moderate injury.



Indicates information considered important, but not hazard-related, e.g. messages relating to property damage.
In the product documentation, the word ATTENTION is used synonymously.

These signal words are in accordance with the standard definition for civil applications in the European Economic Area. Definitions that deviate from the standard definition may also exist in other economic areas or military applications. It is therefore essential to make sure that the signal words described here are always used only in connection with the related product documentation and the related product. The use of signal words in connection with unrelated products or documentation can result in misinterpretation and in personal injury or material damage.

Basic Safety Instructions

Operating states and operating positions

The product may be operated only under the operating conditions and in the positions specified by the manufacturer, without the product's ventilation being obstructed. If the manufacturer's specifications are not observed, this can result in electric shock, fire and/or serious personal injury or death. Applicable local or national safety regulations and rules for the prevention of accidents must be observed in all work performed.

1. Unless otherwise specified, the following requirements apply to Rohde & Schwarz products: predefined operating position is always with the housing floor facing down, IP protection 2X, use only indoors, max. operating altitude 2000 m above sea level, max. transport altitude 4500 m above sea level. A tolerance of $\pm 10\%$ shall apply to the nominal voltage and $\pm 5\%$ to the nominal frequency, overvoltage category 2, pollution degree 2.
2. Do not place the product on surfaces, vehicles, cabinets or tables that for reasons of weight or stability are unsuitable for this purpose. Always follow the manufacturer's installation instructions when installing the product and fastening it to objects or structures (e.g. walls and shelves). An installation that is not carried out as described in the product documentation could result in personal injury or even death.
3. Do not place the product on heat-generating devices such as radiators or fan heaters. The ambient temperature must not exceed the maximum temperature specified in the product documentation or in the data sheet. Product overheating can cause electric shock, fire and/or serious personal injury or even death.

Electrical safety

If the information on electrical safety is not observed either at all or to the extent necessary, electric shock, fire and/or serious personal injury or death may occur.

1. Prior to switching on the product, always ensure that the nominal voltage setting on the product matches the nominal voltage of the mains-supply network. If a different voltage is to be set, the power fuse of the product may have to be changed accordingly.
2. In the case of products of safety class I with movable power cord and connector, operation is permitted only on sockets with a protective conductor contact and protective conductor.
3. Intentionally breaking the protective conductor either in the feed line or in the product itself is not permitted. Doing so can result in the danger of an electric shock from the product. If extension cords or connector strips are implemented, they must be checked on a regular basis to ensure that they are safe to use.
4. If there is no power switch for disconnecting the product from the mains, or if the power switch is not suitable for this purpose, use the plug of the connecting cable to disconnect the product from the mains. In such cases, always ensure that the power plug is easily reachable and accessible at all times. For example, if the power plug is the disconnecting device, the length of the connecting cable must not exceed 3 m. Functional or electronic switches are not suitable for providing disconnection from the AC supply network. If products without power switches are integrated into racks or systems, the disconnecting device must be provided at the system level.
5. Never use the product if the power cable is damaged. Check the power cables on a regular basis to ensure that they are in proper operating condition. By taking appropriate safety measures and carefully laying the power cable, ensure that the cable cannot be damaged and that no one can be hurt by, for example, tripping over the cable or suffering an electric shock.

Basic Safety Instructions

6. The product may be operated only from TN/TT supply networks fuse-protected with max. 16 A (higher fuse only after consulting with the Rohde & Schwarz group of companies).
7. Do not insert the plug into sockets that are dusty or dirty. Insert the plug firmly and all the way into the socket provided for this purpose. Otherwise, sparks that result in fire and/or injuries may occur.
8. Do not overload any sockets, extension cords or connector strips; doing so can cause fire or electric shocks.
9. For measurements in circuits with voltages $V_{rms} > 30$ V, suitable measures (e.g. appropriate measuring equipment, fuse protection, current limiting, electrical separation, insulation) should be taken to avoid any hazards.
10. Ensure that the connections with information technology equipment, e.g. PCs or other industrial computers, comply with the IEC 60950-1 / EN 60950-1 or IEC 61010-1 / EN 61010-1 standards that apply in each case.
11. Unless expressly permitted, never remove the cover or any part of the housing while the product is in operation. Doing so will expose circuits and components and can lead to injuries, fire or damage to the product.
12. If a product is to be permanently installed, the connection between the protective conductor terminal on site and the product's protective conductor must be made first before any other connection is made. The product may be installed and connected only by a licensed electrician.
13. For permanently installed equipment without built-in fuses, circuit breakers or similar protective devices, the supply circuit must be fuse-protected in such a way that anyone who has access to the product, as well as the product itself, is adequately protected from injury or damage.
14. Use suitable overvoltage protection to ensure that no overvoltage (such as that caused by a bolt of lightning) can reach the product. Otherwise, the person operating the product will be exposed to the danger of an electric shock.
15. Any object that is not designed to be placed in the openings of the housing must not be used for this purpose. Doing so can cause short circuits inside the product and/or electric shocks, fire or injuries.
16. Unless specified otherwise, products are not liquid-proof (see also section "Operating states and operating positions", item 1). Therefore, the equipment must be protected against penetration by liquids. If the necessary precautions are not taken, the user may suffer electric shock or the product itself may be damaged, which can also lead to personal injury.
17. Never use the product under conditions in which condensation has formed or can form in or on the product, e.g. if the product has been moved from a cold to a warm environment. Penetration by water increases the risk of electric shock.
18. Prior to cleaning the product, disconnect it completely from the power supply (e.g. AC supply network or battery). Use a soft, non-linting cloth to clean the product. Never use chemical cleaning agents such as alcohol, acetone or diluents for cellulose lacquers.

Operation

1. Operating the products requires special training and intense concentration. Make sure that persons who use the products are physically, mentally and emotionally fit enough to do so; otherwise, injuries or material damage may occur. It is the responsibility of the employer/operator to select suitable personnel for operating the products.

Basic Safety Instructions

2. Before you move or transport the product, read and observe the section titled "Transport".
3. As with all industrially manufactured goods, the use of substances that induce an allergic reaction (allergens) such as nickel cannot be generally excluded. If you develop an allergic reaction (such as a skin rash, frequent sneezing, red eyes or respiratory difficulties) when using a Rohde & Schwarz product, consult a physician immediately to determine the cause and to prevent health problems or stress.
4. Before you start processing the product mechanically and/or thermally, or before you take it apart, be sure to read and pay special attention to the section titled "Waste disposal/Environmental protection", item 1.
5. Depending on the function, certain products such as RF radio equipment can produce an elevated level of electromagnetic radiation. Considering that unborn babies require increased protection, pregnant women must be protected by appropriate measures. Persons with pacemakers may also be exposed to risks from electromagnetic radiation. The employer/operator must evaluate workplaces where there is a special risk of exposure to radiation and, if necessary, take measures to avert the potential danger.
6. Should a fire occur, the product may release hazardous substances (gases, fluids, etc.) that can cause health problems. Therefore, suitable measures must be taken, e.g. protective masks and protective clothing must be worn.
7. Laser products are given warning labels that are standardized according to their laser class. Lasers can cause biological harm due to the properties of their radiation and due to their extremely concentrated electromagnetic power. If a laser product (e.g. a CD/DVD drive) is integrated into a Rohde & Schwarz product, absolutely no other settings or functions may be used as described in the product documentation. The objective is to prevent personal injury (e.g. due to laser beams).
8. EMC classes (in line with EN 55011/CISPR 11, and analogously with EN 55022/CISPR 22, EN 55032/CISPR 32)
 - Class A equipment:
Equipment suitable for use in all environments except residential environments and environments that are directly connected to a low-voltage supply network that supplies residential buildings
Note: Class A equipment is intended for use in an industrial environment. This equipment may cause radio disturbances in residential environments, due to possible conducted as well as radiated disturbances. In this case, the operator may be required to take appropriate measures to eliminate these disturbances.
 - Class B equipment:
Equipment suitable for use in residential environments and environments that are directly connected to a low-voltage supply network that supplies residential buildings

Repair and service

1. The product may be opened only by authorized, specially trained personnel. Before any work is performed on the product or before the product is opened, it must be disconnected from the AC supply network. Otherwise, personnel will be exposed to the risk of an electric shock.

Basic Safety Instructions

- Adjustments, replacement of parts, maintenance and repair may be performed only by electrical experts authorized by Rohde & Schwarz. Only original parts may be used for replacing parts relevant to safety (e.g. power switches, power transformers, fuses). A safety test must always be performed after parts relevant to safety have been replaced (visual inspection, protective conductor test, insulation resistance measurement, leakage current measurement, functional test). This helps ensure the continued safety of the product.

Batteries and rechargeable batteries/cells

If the information regarding batteries and rechargeable batteries/cells is not observed either at all or to the extent necessary, product users may be exposed to the risk of explosions, fire and/or serious personal injury, and, in some cases, death. Batteries and rechargeable batteries with alkaline electrolytes (e.g. lithium cells) must be handled in accordance with the EN 62133 standard.

- Cells must not be taken apart or crushed.
- Cells or batteries must not be exposed to heat or fire. Storage in direct sunlight must be avoided. Keep cells and batteries clean and dry. Clean soiled connectors using a dry, clean cloth.
- Cells or batteries must not be short-circuited. Cells or batteries must not be stored in a box or in a drawer where they can short-circuit each other, or where they can be short-circuited by other conductive materials. Cells and batteries must not be removed from their original packaging until they are ready to be used.
- Cells and batteries must not be exposed to any mechanical shocks that are stronger than permitted.
- If a cell develops a leak, the fluid must not be allowed to come into contact with the skin or eyes. If contact occurs, wash the affected area with plenty of water and seek medical aid.
- Improperly replacing or charging cells or batteries that contain alkaline electrolytes (e.g. lithium cells) can cause explosions. Replace cells or batteries only with the matching Rohde & Schwarz type (see parts list) in order to ensure the safety of the product.
- Cells and batteries must be recycled and kept separate from residual waste. Rechargeable batteries and normal batteries that contain lead, mercury or cadmium are hazardous waste. Observe the national regulations regarding waste disposal and recycling.

Transport

- The product may be very heavy. Therefore, the product must be handled with care. In some cases, the user may require a suitable means of lifting or moving the product (e.g. with a lift-truck) to avoid back or other physical injuries.
- Handles on the products are designed exclusively to enable personnel to transport the product. It is therefore not permissible to use handles to fasten the product to or on transport equipment such as cranes, fork lifts, wagons, etc. The user is responsible for securely fastening the products to or on the means of transport or lifting. Observe the safety regulations of the manufacturer of the means of transport or lifting. Noncompliance can result in personal injury or material damage.
- If you use the product in a vehicle, it is the sole responsibility of the driver to drive the vehicle safely and properly. The manufacturer assumes no responsibility for accidents or collisions. Never use the product in a moving vehicle if doing so could distract the driver of the vehicle. Adequately secure the product in the vehicle to prevent injuries or other damage in the event of an accident.

Instrucciones de seguridad elementales

Waste disposal/Environmental protection

1. Specially marked equipment has a battery or accumulator that must not be disposed of with unsorted municipal waste, but must be collected separately. It may only be disposed of at a suitable collection point or via a Rohde & Schwarz customer service center.
2. Waste electrical and electronic equipment must not be disposed of with unsorted municipal waste, but must be collected separately.
Rohde & Schwarz GmbH & Co. KG has developed a disposal concept and takes full responsibility for take-back obligations and disposal obligations for manufacturers within the EU. Contact your Rohde & Schwarz customer service center for environmentally responsible disposal of the product.
3. If products or their components are mechanically and/or thermally processed in a manner that goes beyond their intended use, hazardous substances (heavy-metal dust such as lead, beryllium, nickel) may be released. For this reason, the product may only be disassembled by specially trained personnel. Improper disassembly may be hazardous to your health. National waste disposal regulations must be observed.
4. If handling the product releases hazardous substances or fuels that must be disposed of in a special way, e.g. coolants or engine oils that must be replenished regularly, the safety instructions of the manufacturer of the hazardous substances or fuels and the applicable regional waste disposal regulations must be observed. Also observe the relevant safety instructions in the product documentation. The improper disposal of hazardous substances or fuels can cause health problems and lead to environmental damage.

For additional information about environmental protection, visit the Rohde & Schwarz website.

Instrucciones de seguridad elementales

¡Es imprescindible leer y cumplir las siguientes instrucciones e informaciones de seguridad!

El principio del grupo de empresas Rohde & Schwarz consiste en tener nuestros productos siempre al día con los estándares de seguridad y de ofrecer a nuestros clientes el máximo grado de seguridad. Nuestros productos y todos los equipos adicionales son siempre fabricados y examinados según las normas de seguridad vigentes. Nuestro sistema de garantía de calidad controla constantemente que sean cumplidas estas normas. El presente producto ha sido fabricado y examinado según el certificado de conformidad de la UE y ha salido de nuestra planta en estado impecable según los estándares técnicos de seguridad. Para poder preservar este estado y garantizar un funcionamiento libre de peligros, el usuario deberá atenerse a todas las indicaciones, informaciones de seguridad y notas de alerta. El grupo de empresas Rohde & Schwarz está siempre a su disposición en caso de que tengan preguntas referentes a estas informaciones de seguridad.

Además queda en la responsabilidad del usuario utilizar el producto en la forma debida. Este producto está destinado exclusivamente al uso en la industria y el laboratorio o, si ha sido expresamente autorizado, para aplicaciones de campo y de ninguna manera deberá ser utilizado de modo que alguna persona/cosa pueda sufrir daño. El uso del producto fuera de sus fines definidos o sin tener en cuenta las instrucciones del fabricante queda en la responsabilidad del usuario. El fabricante no se hace en ninguna forma responsable de consecuencias a causa del mal uso del producto.















Instrucciones de seguridad elementales

Se parte del uso correcto del producto para los fines definidos si el producto es utilizado conforme a las indicaciones de la correspondiente documentación del producto y dentro del margen de rendimiento definido (ver hoja de datos, documentación, informaciones de seguridad que siguen). El uso del producto hace necesarios conocimientos técnicos y ciertos conocimientos del idioma inglés. Por eso se debe tener en cuenta que el producto solo pueda ser operado por personal especializado o personas instruidas en profundidad con las capacidades correspondientes. Si fuera necesaria indumentaria de seguridad para el uso de productos de Rohde & Schwarz, encontraría la información debida en la documentación del producto en el capítulo correspondiente. Guarde bien las informaciones de seguridad elementales, así como la documentación del producto, y entréguelas a usuarios posteriores.



Tener en cuenta las informaciones de seguridad sirve para evitar en lo posible lesiones o daños por peligros de toda clase. Por eso es imprescindible leer detalladamente y comprender por completo las siguientes informaciones de seguridad antes de usar el producto, y respetarlas durante el uso del producto. Deberán tenerse en cuenta todas las demás informaciones de seguridad, como p. ej. las referentes a la protección de personas, que encontrarán en el capítulo correspondiente de la documentación del producto y que también son de obligado cumplimiento. En las presentes informaciones de seguridad se recogen todos los objetos que distribuye el grupo de empresas Rohde & Schwarz bajo la denominación de "producto", entre ellos también aparatos, instalaciones así como toda clase de accesorios. Los datos específicos del producto figuran en la hoja de datos y en la documentación del producto.

Señalización de seguridad de los productos

Las siguientes señales de seguridad se utilizan en los productos para advertir sobre riesgos y peligros.

Símbolo	Significado	Símbolo	Significado
	Aviso: punto de peligro general Observar la documentación del producto		Tensión de alimentación de PUESTA EN MARCHA / PARADA
	Atención en el manejo de dispositivos de peso elevado		Indicación de estado de espera (standby)
	Peligro de choque eléctrico		Corriente continua (DC)
	Advertencia: superficie caliente		Corriente alterna (AC)
	Conexión a conductor de protección		Corriente continua / Corriente alterna (DC/AC)
	Conexión a tierra		El aparato está protegido en su totalidad por un aislamiento doble (reforzado)
	Conexión a masa		Distintivo de la UE para baterías y acumuladores Más información en la sección "Eliminación/protección del medio ambiente", punto 1.

Instrucciones de seguridad elementales

Símbolo	Significado	Símbolo	Significado
	Aviso: Cuidado en el manejo de dispositivos sensibles a la electrostática (ESD)		Distintivo de la UE para la eliminación por separado de dispositivos eléctricos y electrónicos Más información en la sección "Eliminación/protección del medio ambiente", punto 2.
	Advertencia: rayo láser Más información en la sección "Funcionamiento", punto 7.		

Palabras de señal y su significado

En la documentación del producto se utilizan las siguientes palabras de señal con el fin de advertir contra riesgos y peligros.



Indica una situación de peligro que, si no se evita, causa lesiones graves o incluso la muerte.



Indica una situación de peligro que, si no se evita, puede causar lesiones graves o incluso la muerte.



Indica una situación de peligro que, si no se evita, puede causar lesiones leves o moderadas.



Indica información que se considera importante, pero no en relación con situaciones de peligro; p. ej., avisos sobre posibles daños materiales.

En la documentación del producto se emplea de forma sinónima el término CUIDADO.

Las palabras de señal corresponden a la definición habitual para aplicaciones civiles en el área económica europea. Pueden existir definiciones diferentes a esta definición en otras áreas económicas o en aplicaciones militares. Por eso se deberá tener en cuenta que las palabras de señal aquí descritas sean utilizadas siempre solamente en combinación con la correspondiente documentación del producto y solamente en combinación con el producto correspondiente. La utilización de las palabras de señal en combinación con productos o documentaciones que no les correspondan puede llevar a interpretaciones equivocadas y tener por consecuencia daños en personas u objetos.

Estados operativos y posiciones de funcionamiento

El producto solamente debe ser utilizado según lo indicado por el fabricante respecto a los estados operativos y posiciones de funcionamiento sin que se obstruya la ventilación. Si no se siguen las indicaciones del fabricante, pueden producirse choques eléctricos, incendios y/o lesiones graves con posible consecuencia de muerte. En todos los trabajos deberán ser tenidas en cuenta las normas nacionales y locales de seguridad del trabajo y de prevención de accidentes.

Instrucciones de seguridad elementales

1. Si no se convino de otra manera, es para los productos Rohde & Schwarz válido lo que sigue: como posición de funcionamiento se define por principio la posición con el suelo de la caja para abajo, modo de protección IP 2X, uso solamente en estancias interiores, utilización hasta 2000 m sobre el nivel del mar, transporte hasta 4500 m sobre el nivel del mar. Se aplicará una tolerancia de $\pm 10\%$ sobre el voltaje nominal y de $\pm 5\%$ sobre la frecuencia nominal. Categoría de sobrecarga eléctrica 2, índice de suciedad 2.
2. No sitúe el producto encima de superficies, vehículos, estantes o mesas, que por sus características de peso o de estabilidad no sean aptos para él. Siga siempre las instrucciones de instalación del fabricante cuando instale y asegure el producto en objetos o estructuras (p. ej. paredes y estantes). Si se realiza la instalación de modo distinto al indicado en la documentación del producto, se pueden causar lesiones o, en determinadas circunstancias, incluso la muerte.
3. No ponga el producto sobre aparatos que generen calor (p. ej. radiadores o calefactores). La temperatura ambiente no debe superar la temperatura máxima especificada en la documentación del producto o en la hoja de datos. En caso de sobrecalentamiento del producto, pueden producirse choques eléctricos, incendios y/o lesiones graves con posible consecuencia de muerte.

Seguridad eléctrica

Si no se siguen (o se siguen de modo insuficiente) las indicaciones del fabricante en cuanto a seguridad eléctrica, pueden producirse choques eléctricos, incendios y/o lesiones graves con posible consecuencia de muerte.

1. Antes de la puesta en marcha del producto se deberá comprobar siempre que la tensión preseleccionada en el producto coincida con la de la red de alimentación eléctrica. Si es necesario modificar el ajuste de tensión, también se deberán cambiar en caso dado los fusibles correspondientes del producto.
2. Los productos de la clase de protección I con alimentación móvil y enchufe individual solamente podrán enchufarse a tomas de corriente con contacto de seguridad y con conductor de protección conectado.
3. Queda prohibida la interrupción intencionada del conductor de protección, tanto en la toma de corriente como en el mismo producto. La interrupción puede tener como consecuencia el riesgo de que el producto sea fuente de choques eléctricos. Si se utilizan cables alargadores o regletas de enchufe, deberá garantizarse la realización de un examen regular de los mismos en cuanto a su estado técnico de seguridad.
4. Si el producto no está equipado con un interruptor para desconectarlo de la red, o bien si el interruptor existente no resulta apropiado para la desconexión de la red, el enchufe del cable de conexión se deberá considerar como un dispositivo de desconexión. El dispositivo de desconexión se debe poder alcanzar fácilmente y debe estar siempre bien accesible. Si, p. ej., el enchufe de conexión a la red es el dispositivo de desconexión, la longitud del cable de conexión no debe superar 3 m). Los interruptores selectores o electrónicos no son aptos para el corte de la red eléctrica. Si se integran productos sin interruptor en bastidores o instalaciones, se deberá colocar el interruptor en el nivel de la instalación.
5. No utilice nunca el producto si está dañado el cable de conexión a red. Compruebe regularmente el correcto estado de los cables de conexión a red. Asegúrese, mediante las medidas de protección y de instalación adecuadas, de que el cable de conexión a red no pueda ser dañado o de que nadie pueda ser dañado por él, p. ej. al tropezar o por un choque eléctrico.

Instrucciones de seguridad elementales

6. Solamente está permitido el funcionamiento en redes de alimentación TN/TT aseguradas con fusibles de 16 A como máximo (utilización de fusibles de mayor amperaje solo previa consulta con el grupo de empresas Rohde & Schwarz).
7. Nunca conecte el enchufe en tomas de corriente sucias o llenas de polvo. Introduzca el enchufe por completo y fuertemente en la toma de corriente. La no observación de estas medidas puede provocar chispas, fuego y/o lesiones.
8. No sobrecargue las tomas de corriente, los cables alargadores o las regletas de enchufe ya que esto podría causar fuego o choques eléctricos.
9. En las mediciones en circuitos de corriente con una tensión $U_{\text{eff}} > 30 \text{ V}$ se deberán tomar las medidas apropiadas para impedir cualquier peligro (p. ej. medios de medición adecuados, seguros, limitación de tensión, corte protector, aislamiento etc.).
10. Para la conexión con dispositivos informáticos como un PC o un ordenador industrial, debe comprobarse que éstos cumplan los estándares IEC60950-1/EN60950-1 o IEC61010-1/EN 61010-1 válidos en cada caso.
11. A menos que esté permitido expresamente, no retire nunca la tapa ni componentes de la carcasa mientras el producto esté en servicio. Esto pone a descubierto los cables y componentes eléctricos y puede causar lesiones, fuego o daños en el producto.
12. Si un producto se instala en un lugar fijo, se deberá primero conectar el conductor de protección fijo con el conductor de protección del producto antes de hacer cualquier otra conexión. La instalación y la conexión deberán ser efectuadas por un electricista especializado.
13. En el caso de dispositivos fijos que no estén provistos de fusibles, interruptor automático ni otros mecanismos de seguridad similares, el circuito de alimentación debe estar protegido de modo que todas las personas que puedan acceder al producto, así como el producto mismo, estén a salvo de posibles daños.
14. Todo producto debe estar protegido contra sobretensión (debida p. ej. a una caída del rayo) mediante los correspondientes sistemas de protección. Si no, el personal que lo utilice quedará expuesto al peligro de choque eléctrico.
15. No debe introducirse en los orificios de la caja del aparato ningún objeto que no esté destinado a ello. Esto puede producir cortocircuitos en el producto y/o puede causar choques eléctricos, fuego o lesiones.
16. Salvo indicación contraria, los productos no están impermeabilizados (ver también el capítulo "Estados operativos y posiciones de funcionamiento", punto 1). Por eso es necesario tomar las medidas necesarias para evitar la entrada de líquidos. En caso contrario, existe peligro de choque eléctrico para el usuario o de daños en el producto, que también pueden redundar en peligro para las personas.
17. No utilice el producto en condiciones en las que pueda producirse o ya se hayan producido condensaciones sobre el producto o en el interior de éste, como p. ej. al desplazarlo de un lugar frío a otro caliente. La entrada de agua aumenta el riesgo de choque eléctrico.
18. Antes de la limpieza, desconecte por completo el producto de la alimentación de tensión (p. ej. red de alimentación o batería). Realice la limpieza de los aparatos con un paño suave, que no se deshilache. No utilice bajo ningún concepto productos de limpieza químicos como alcohol, acetona o diluyentes para lacas nitrocelulósicas.

Instrucciones de seguridad elementales**Funcionamiento**

1. El uso del producto requiere instrucciones especiales y una alta concentración durante el manejo. Debe asegurarse que las personas que manejen el producto estén a la altura de los requerimientos necesarios en cuanto a aptitudes físicas, psíquicas y emocionales, ya que de otra manera no se pueden excluir lesiones o daños de objetos. El empresario u operador es responsable de seleccionar el personal usuario apto para el manejo del producto.
2. Antes de desplazar o transportar el producto, lea y tenga en cuenta el capítulo "Transporte".
3. Como con todo producto de fabricación industrial no puede quedar excluida en general la posibilidad de que se produzcan alergias provocadas por algunos materiales empleados —los llamados alérgenos (p. ej. el níquel)—. Si durante el manejo de productos Rohde & Schwarz se producen reacciones alérgicas, como p. ej. irritaciones cutáneas, estornudos continuos, enrojecimiento de la conjuntiva o dificultades respiratorias, debe avisarse inmediatamente a un médico para investigar las causas y evitar cualquier molestia o daño a la salud.
4. Antes de la manipulación mecánica y/o térmica o el desmontaje del producto, debe tenerse en cuenta imprescindiblemente el capítulo "Eliminación/protección del medio ambiente", punto 1.
5. Ciertos productos, como p. ej. las instalaciones de radiocomunicación RF, pueden a causa de su función natural, emitir una radiación electromagnética aumentada. Deben tomarse todas las medidas necesarias para la protección de las mujeres embarazadas. También las personas con marcapasos pueden correr peligro a causa de la radiación electromagnética. El empresario/operador tiene la obligación de evaluar y señalizar las áreas de trabajo en las que exista un riesgo elevado de exposición a radiaciones.
6. Tenga en cuenta que en caso de incendio pueden desprenderse del producto sustancias tóxicas (gases, líquidos etc.) que pueden generar daños a la salud. Por eso, en caso de incendio deben usarse medidas adecuadas, como p. ej. máscaras antigás e indumentaria de protección.
7. Los productos con láser están provistos de indicaciones de advertencia normalizadas en función de la clase de láser del que se trate. Los rayos láser pueden provocar daños de tipo biológico a causa de las propiedades de su radiación y debido a su concentración extrema de potencia electromagnética. En caso de que un producto Rohde & Schwarz contenga un producto láser (p. ej. un lector de CD/DVD), no debe usarse ninguna otra configuración o función aparte de las descritas en la documentación del producto, a fin de evitar lesiones (p. ej. debidas a irradiación láser).
8. Clases de compatibilidad electromagnética (conforme a EN 55011 / CISPR 11; y en analogía con EN 55022 / CISPR 22, EN 55032 / CISPR 32)
 - Aparato de clase A:
Aparato adecuado para su uso en todos los entornos excepto en los residenciales y en aquellos conectados directamente a una red de distribución de baja tensión que suministra corriente a edificios residenciales.
Nota: Los aparatos de clase A están destinados al uso en entornos industriales. Estos aparatos pueden causar perturbaciones radioeléctricas en entornos residenciales debido a posibles perturbaciones guiadas o radiadas. En este caso, se le podrá solicitar al operador que tome las medidas adecuadas para eliminar estas perturbaciones.
 - Aparato de clase B:
Aparato adecuado para su uso en entornos residenciales, así como en aquellos conectados directamente a una red de distribución de baja tensión que suministra corriente a edificios residenciales.

Instrucciones de seguridad elementales

Reparación y mantenimiento

1. El producto solamente debe ser abierto por personal especializado con autorización para ello. Antes de manipular el producto o abrirlo, es obligatorio desconectarlo de la tensión de alimentación, para evitar toda posibilidad de choque eléctrico.
2. El ajuste, el cambio de partes, el mantenimiento y la reparación deberán ser efectuadas solamente por electricistas autorizados por Rohde & Schwarz. Si se reponen partes con importancia para los aspectos de seguridad (p. ej. el enchufe, los transformadores o los fusibles), solamente podrán ser sustituidos por partes originales. Después de cada cambio de partes relevantes para la seguridad deberá realizarse un control de seguridad (control a primera vista, control del conductor de protección, medición de resistencia de aislamiento, medición de la corriente de fuga, control de funcionamiento). Con esto queda garantizada la seguridad del producto.

Baterías y acumuladores o celdas

Si no se siguen (o se siguen de modo insuficiente) las indicaciones en cuanto a las baterías y acumuladores o celdas, pueden producirse explosiones, incendios y/o lesiones graves con posible consecuencia de muerte. El manejo de baterías y acumuladores con electrolitos alcalinos (p. ej. celdas de litio) debe seguir el estándar EN 62133.

1. No deben desmontarse, abrirse ni triturarse las celdas.
2. Las celdas o baterías no deben someterse a calor ni fuego. Debe evitarse el almacenamiento a la luz directa del sol. Las celdas y baterías deben mantenerse limpias y secas. Limpiar las conexiones sucias con un paño seco y limpio.
3. Las celdas o baterías no deben cortocircuitarse. Es peligroso almacenar las celdas o baterías en estuches o cajones en cuyo interior puedan cortocircuitarse por contacto recíproco o por contacto con otros materiales conductores. No deben extraerse las celdas o baterías de sus embalajes originales hasta el momento en que vayan a utilizarse.
4. Las celdas o baterías no deben someterse a impactos mecánicos fuertes indebidos.
5. En caso de falta de estanqueidad de una celda, el líquido vertido no debe entrar en contacto con la piel ni los ojos. Si se produce contacto, lavar con agua abundante la zona afectada y avisar a un médico.
6. En caso de cambio o recarga inadecuados, las celdas o baterías que contienen electrolitos alcalinos (p. ej. las celdas de litio) pueden explotar. Para garantizar la seguridad del producto, las celdas o baterías solo deben ser sustituidas por el tipo Rohde & Schwarz correspondiente (ver lista de recambios).
7. Las baterías y celdas deben reciclarse y no deben tirarse a la basura doméstica. Las baterías o acumuladores que contienen plomo, mercurio o cadmio deben tratarse como residuos especiales. Respete en esta relación las normas nacionales de eliminación y reciclaje.

Transporte

1. El producto puede tener un peso elevado. Por eso es necesario desplazarlo o transportarlo con precaución y, si es necesario, usando un sistema de elevación adecuado (p. ej. una carretilla elevadora), a fin de evitar lesiones en la espalda u otros daños personales.

Instrucciones de seguridad elementales

2. Las asas instaladas en los productos sirven solamente de ayuda para el transporte del producto por personas. Por eso no está permitido utilizar las asas para la sujeción en o sobre medios de transporte como p. ej. grúas, carretillas elevadoras de horquilla, carros etc. Es responsabilidad suya fijar los productos de manera segura a los medios de transporte o elevación. Para evitar daños personales o daños en el producto, siga las instrucciones de seguridad del fabricante del medio de transporte o elevación utilizado.
3. Si se utiliza el producto dentro de un vehículo, recae de manera exclusiva en el conductor la responsabilidad de conducir el vehículo de manera segura y adecuada. El fabricante no asumirá ninguna responsabilidad por accidentes o colisiones. No utilice nunca el producto dentro de un vehículo en movimiento si esto pudiera distraer al conductor. Asegure el producto dentro del vehículo debidamente para evitar, en caso de un accidente, lesiones u otra clase de daños.

Eliminación/protección del medio ambiente

1. Los dispositivos marcados contienen una batería o un acumulador que no se debe desechar con los residuos domésticos sin clasificar, sino que debe ser recogido por separado. La eliminación se debe efectuar exclusivamente a través de un punto de recogida apropiado o del servicio de atención al cliente de Rohde & Schwarz.
2. Los dispositivos eléctricos usados no se deben desechar con los residuos domésticos sin clasificar, sino que deben ser recogidos por separado. Rohde & Schwarz GmbH & Co.KG ha elaborado un concepto de eliminación de residuos y asume plenamente los deberes de recogida y eliminación para los fabricantes dentro de la UE. Para desechar el producto de manera respetuosa con el medio ambiente, dirijase a su servicio de atención al cliente de Rohde & Schwarz.
3. Si se trabaja de manera mecánica y/o térmica cualquier producto o componente más allá del funcionamiento previsto, pueden liberarse sustancias peligrosas (polvos con contenido de metales pesados como p. ej. plomo, berilio o níquel). Por eso el producto solo debe ser desmontado por personal especializado con formación adecuada. Un desmontaje inadecuado puede ocasionar daños para la salud. Se deben tener en cuenta las directivas nacionales referentes a la eliminación de residuos.
4. En caso de que durante el trato del producto se formen sustancias peligrosas o combustibles que deban tratarse como residuos especiales (p. ej. refrigerantes o aceites de motor con intervalos de cambio definidos), deben tenerse en cuenta las indicaciones de seguridad del fabricante de dichas sustancias y las normas regionales de eliminación de residuos. Tenga en cuenta también en caso necesario las indicaciones de seguridad especiales contenidas en la documentación del producto. La eliminación incorrecta de sustancias peligrosas o combustibles puede causar daños a la salud o daños al medio ambiente.

Se puede encontrar más información sobre la protección del medio ambiente en la página web de Rohde & Schwarz.

Quality management and environmental management

Sehr geehrter Kunde,

Sie haben sich für den Kauf eines Rohde&Schwarz Produktes entschieden. Sie erhalten damit ein nach modernsten Fertigungsmethoden hergestelltes Produkt. Es wurde nach den Regeln unserer Qualitäts- und Umweltmanagementsysteme entwickelt, gefertigt und geprüft. Rohde&Schwarz ist unter anderem nach den Managementsystemen ISO9001 und ISO 14001 zertifiziert.

Der Umwelt verpflichtet

- Energie-effiziente, RoHS-konforme Produkte
- Kontinuierliche Weiterentwicklung nachhaltiger Umweltkonzepte
- ISO 14001-zertifiziertes Umweltmanagementsystem

Dear customer,

You have decided to buy a Rohde&Schwarz product. This product has been manufactured using the most advanced methods. It was developed, manufactured and tested in compliance with our quality management and environmental management systems. Rohde&Schwarz has been certified, for example, according to the ISO9001 and ISO 14001 management systems.

Environmental commitment

- Energy-efficient products
- Continuous improvement in environmental sustainability
- ISO 14001-certified environmental management system



Cher client,

Vous avez choisi d'acheter un produit Rohde&Schwarz. Vous disposez donc d'un produit fabriqué d'après les méthodes les plus avancées. Le développement, la fabrication et les tests de ce produit ont été effectués selon nos systèmes de management de qualité et de management environnemental. La société Rohde&Schwarz a été homologuée, entre autres, conformément aux systèmes de management ISO 9001 et ISO 14001.

Engagement écologique

- Produits à efficience énergétique
- Amélioration continue de la durabilité environnementale
- Système de management environnemental certifié selon ISO 14001



Customer Support

Technical support – where and when you need it

For quick, expert help with any Rohde & Schwarz equipment, contact one of our Customer Support Centers. A team of highly qualified engineers provides telephone support and will work with you to find a solution to your query on any aspect of the operation, programming or applications of Rohde & Schwarz equipment.

Up-to-date information and upgrades

To keep your instrument up-to-date and to be informed about new application notes related to your instrument, please send an e-mail to the Customer Support Center stating your instrument and your wish. We will take care that you will get the right information.

Europe, Africa, Middle East

Phone +49 89 4129 12345
customersupport@rohde-schwarz.com

North America

Phone 1-888-TEST-RSA (1-888-837-8772)
customer.support@rsa.rohde-schwarz.com

Latin America

Phone +1-410-910-7988
customersupport.la@rohde-schwarz.com

Asia/Pacific

Phone +65 65 13 04 88
customersupport.asia@rohde-schwarz.com

China

Phone +86-800-810-8228 /
+86-400-650-5896
customersupport.china@rohde-schwarz.com



1 Usage

1.1 General

These operating instructions provide all the information required for installation, programming, and operation of the Power Supply/Load Module R&S TS-PSU on the R&S CompactTSVP/ R&S PowerTSVP production test platform. They also include detailed information on the special features of the R&S TS-PSU, specifications, block diagrams, and pin assignment of the connector. All processes described in the manual assume the reader is familiar with personal computers, the Windows7/Windows XP operating system and the basic principles of electrical measurement systems in the form of modules (CompactPCI or PXI modules).

1.2 Description of Product

The Power Supply/Load Module R&S TS-PSU is a module based on CompactPCI developed for use on the ROHDE & SCHWARZ R&S CompactTSVP and R&S PowerTSVP production test platform. It has a width of only one slot and a height of four units. It has two floating channels that are completely independent of each other with a maximum power of 50 W each, a voltage range of +/-50 V and a maximum current of 3 A. The currents and voltages can be programmed in both the positive and negative range. Thanks to this 4-quadrant capability of the module, it can also be operated in applications as a load (sink). The measurement units integrated into the module for each channel make it possible to read back the current and voltage of any given channel. Using the multiplexer included in the module, it is also possible with the R&S TS-PSU to measure external voltages over time directly on the test object. The functionality of the module also includes extensive options for controlling individual channels via trigger lines and generating trigger signals. As with all modules available from ROHDE & SCHWARZ, the R&S TS-PSU also has access to existing analog measurement buses in the R&S CompactTSVP and R&S PowerTSVP with both channels. This measurement bus makes it possible to switch outputs without any extra wiring to other measurement and switching cards present in the R&S CompactTSVP / R&S PowerTSVP.

The CAN bus (Controller Area Network) present in the R&S CompactTSVP and R&S PowerTSVP is used to control the R&S TS-PSU.

1.3 Scope of delivery

The scope of delivery for the Power Supply/Load Module R&S TS-PSU includes the following components:

- PSU power module (CompactPCI module, for use in a front slot)
- R&S TS-PDC Power supply (use in the appropriate Rear-I/O slot)

- PSU-AC/DC converter for external power supply of the R&S TS-PSU

Please open the package carefully and check to ensure the hardware inside has been delivered in perfect condition. If the modules included in the delivery show any signs of damage that would interfere with their intended purpose, please contact ROHDE & SCHWARZ Customer Support.

1.4 Characteristics

Table 1-1: Characteristics R&S TS-PSU

Characteristics R&S TS-PSU
Two fully independent, floating power supply units with up to 50 V / 0 ... 50 V / 50 W
Source and sink operation with separate sensing (four-quadrant operation)
Electronic load with up to 20 W continuous dissipated power
Integrated voltage and current measurement
Two integrated voltage measurement units for external use
Recording of voltage or current values as they change over time
External trigger of source and measurement via PXI trigger signals
Over voltage, over current, over temperature and short circuit protection
4:1 Relay multiplexer (force and sense) per channel for panel test
Access to analog measurement bus
Self-test capability
Softpanel for direct operation
LabWindows/CVI driver support
GTSL (generic test software library) in DLL format

1.5 Safety instructions

CAUTION

The R&S CompactTSVP/ R&S PowerTSVP production platform and the Power Supply/ Load Module R&S TS-PSU are designed so that users can operate at voltages up to 125 V. The requirements according to EN61010-1 for operation with “hazardous live” voltages must be observed.

For additional details see [Chapter 6.5.3, "Instructions for operation with voltages dangerous to the touch"](#), on page 41 and the leaflet entitled “Safety Instructions” in the

operating instructions for the R&S CompactTSVP/ R&S PowerTSVP production platform.

2 View

Figure 2-1 to Figure 2-3 show views of the three modules of Power Supply/Load Module R&S TS-PSU.



Figure 2-1: PSU power module view

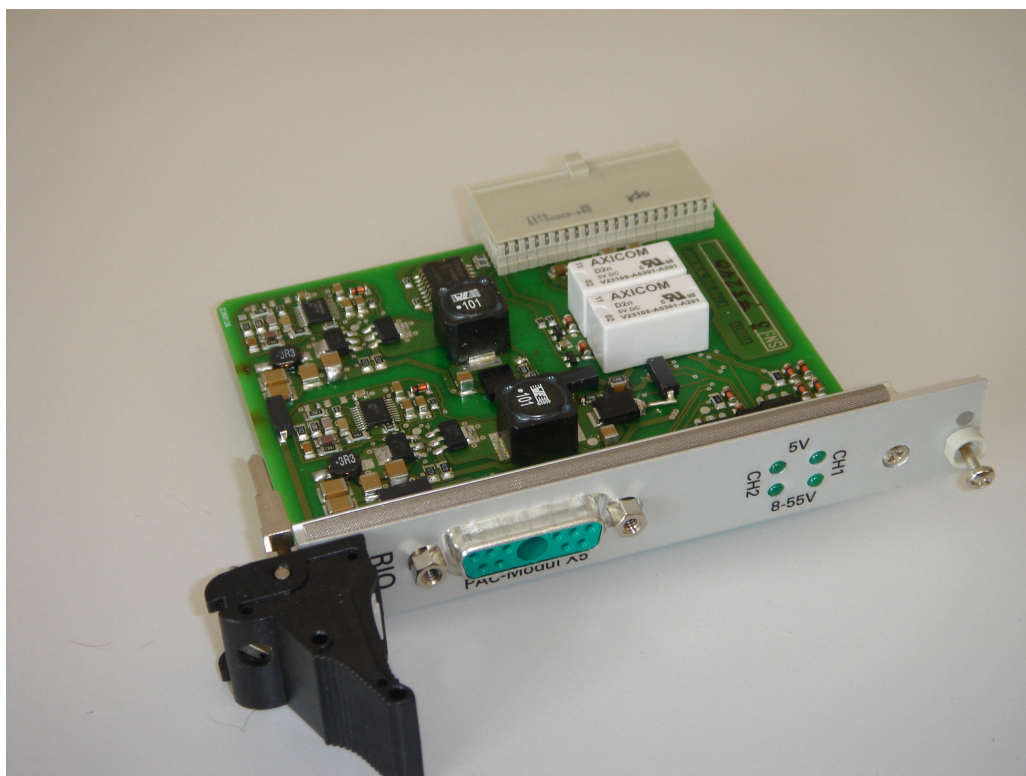

Figure 2-2: PSU RIO module view



Figure 2-3: PSU AC/DC converter view

3 Block Diagram

Figure 3-1 shows a simplified functional block diagram of the Power Supply/Load Module R&S TS-PSU. This functional block diagram represents the three modules of the R&S TS-PSU.

- PSU power module
- PSU RIO module
- PSU AC/DC converter

Figure 3-2 shows a block diagram of the Power Supply/Load Module R&S TS-PSU (PSU power module and PSU RIO module).

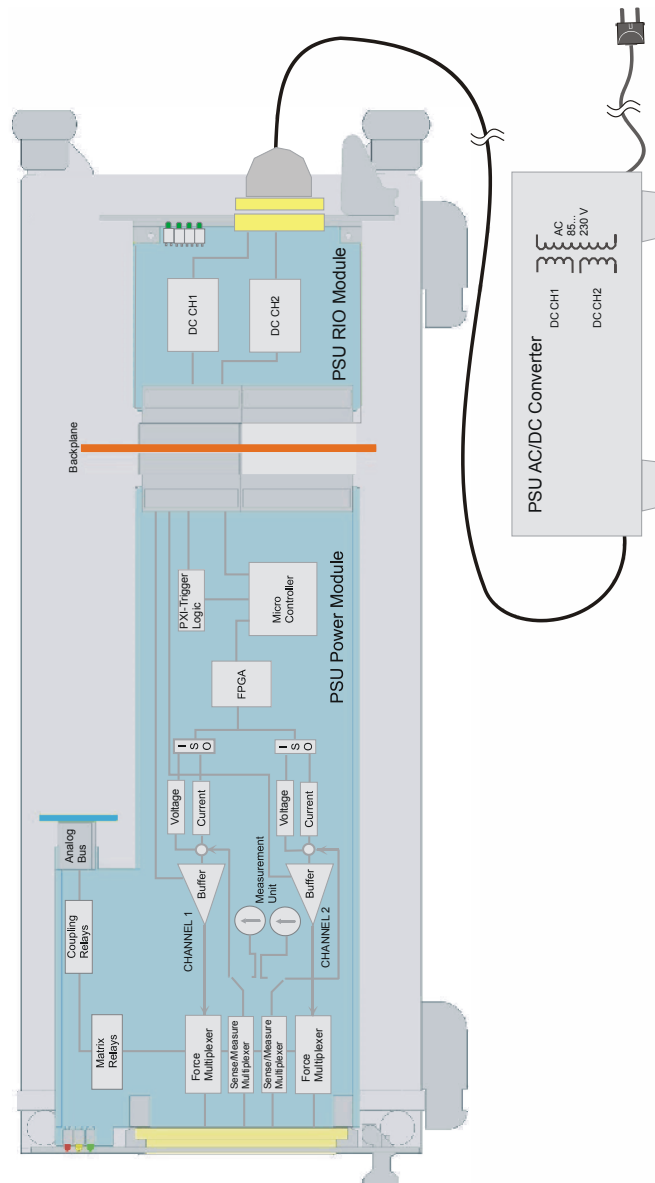

Figure 3-1: Functional block diagram R&S TS-PSU

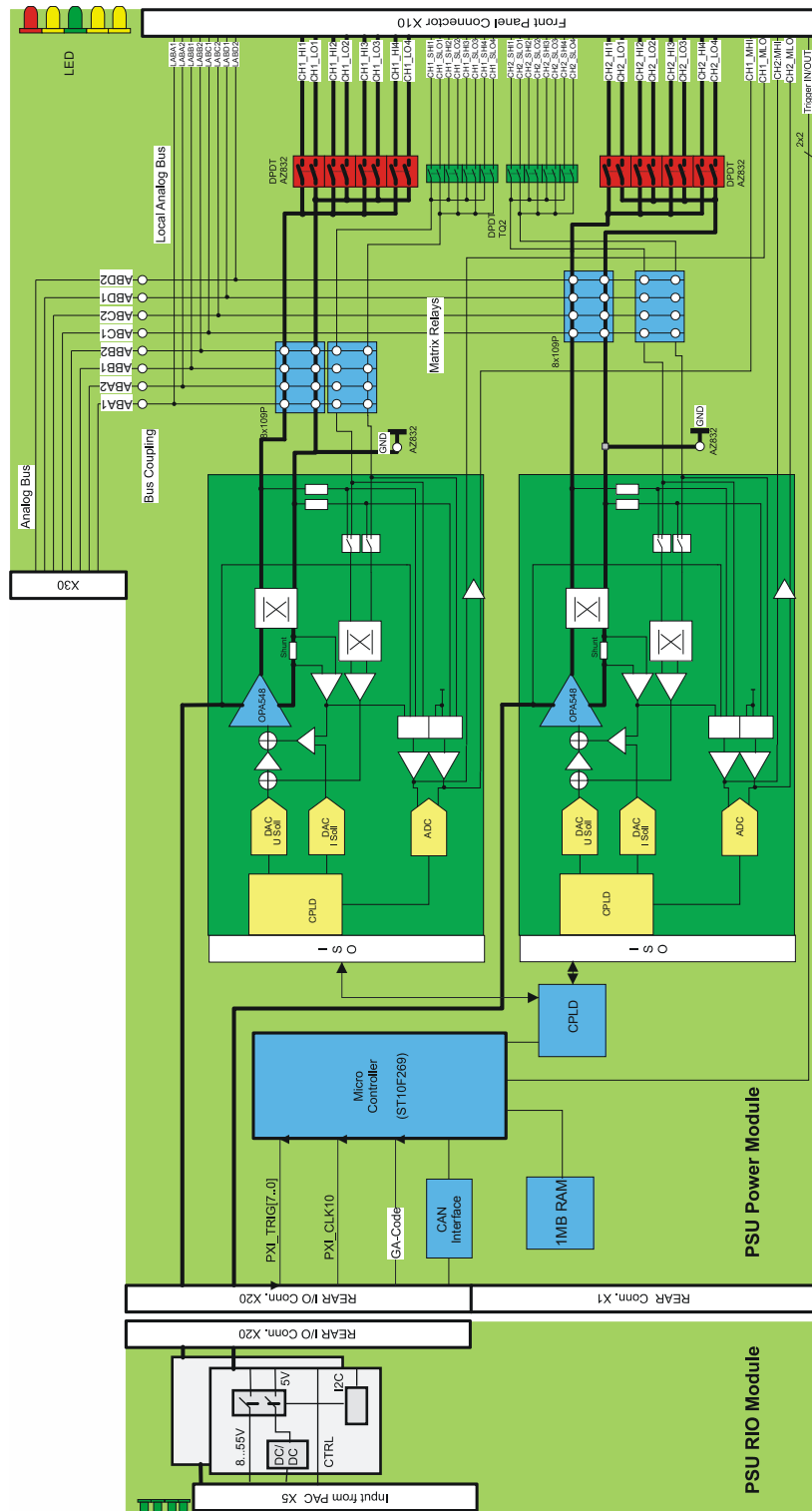

Figure 3-2: Block diagram R&S TS-PSU

4 Layout

4.1 Overview

The Power Supply/Load Module R&S TS-PSU is an option for integration into the R&S CompactTSVP production test platform or R&S PowerTSVP production platform. It consists of the following three modules:

- PSU power module (CompactPCI module, for use in a front slot)
- PSU RIO module to connect the PSU AC/DC converter to the PSU power module (for use in the corresponding slot on the back)
- PSU AC/DC converter for external power supply of the R&S TS-PSU

The PSU AC/DC converter provides the power required by the test object and the power module. It does not represent a load on the R&S CompactTSVP power supply.

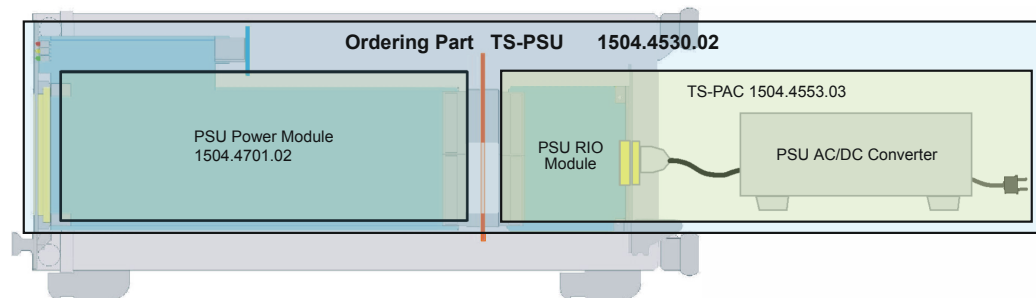

Figure 4-1: Components of order item R&S TS-PSU

4.2 PSU power module

4.2.1 Mechanical layout

The PSU power module is designed as a long plug-in card for front side insertion in the R&S CompactTSVP production platform or in the R&S PowerTSVP production test platform. The front side connector X10 is used to connect the test object. Connector X30 connects the module with the analog bus backplane in the R&S CompactTSVP. Connectors X20/X1 connect the module with the cPCI backplane/PXI control backplane.

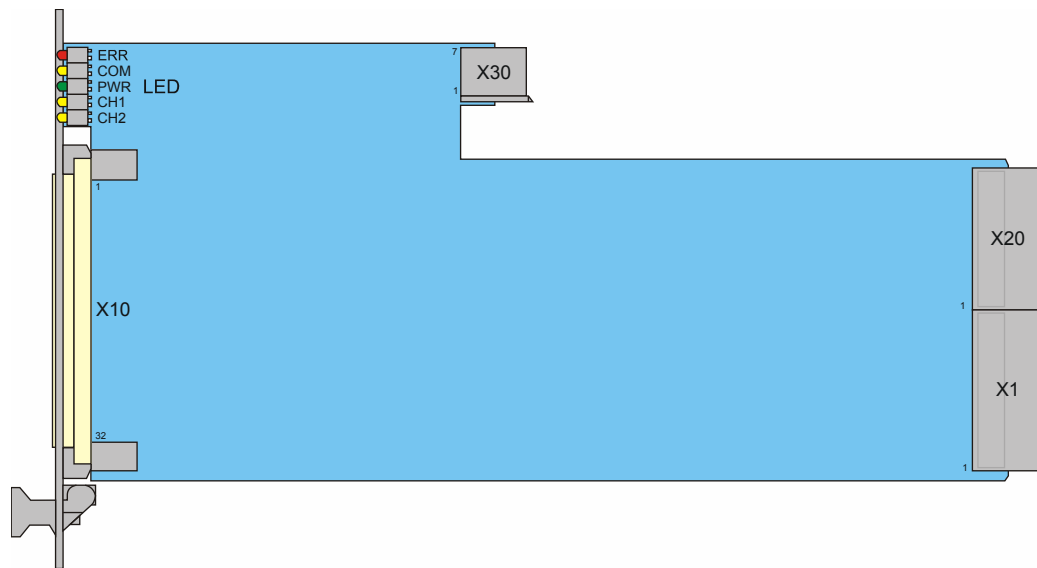

Figure 4-2: Arrangement of connectors and PSU power module LEDs

Table 4-1: PSU power module connectors

Abbreviation	Use
X1	cPCI Connector
X10	Front Connector
X20	cPCI Connector
X30	Analog Bus Connector

4.2.2 Display elements

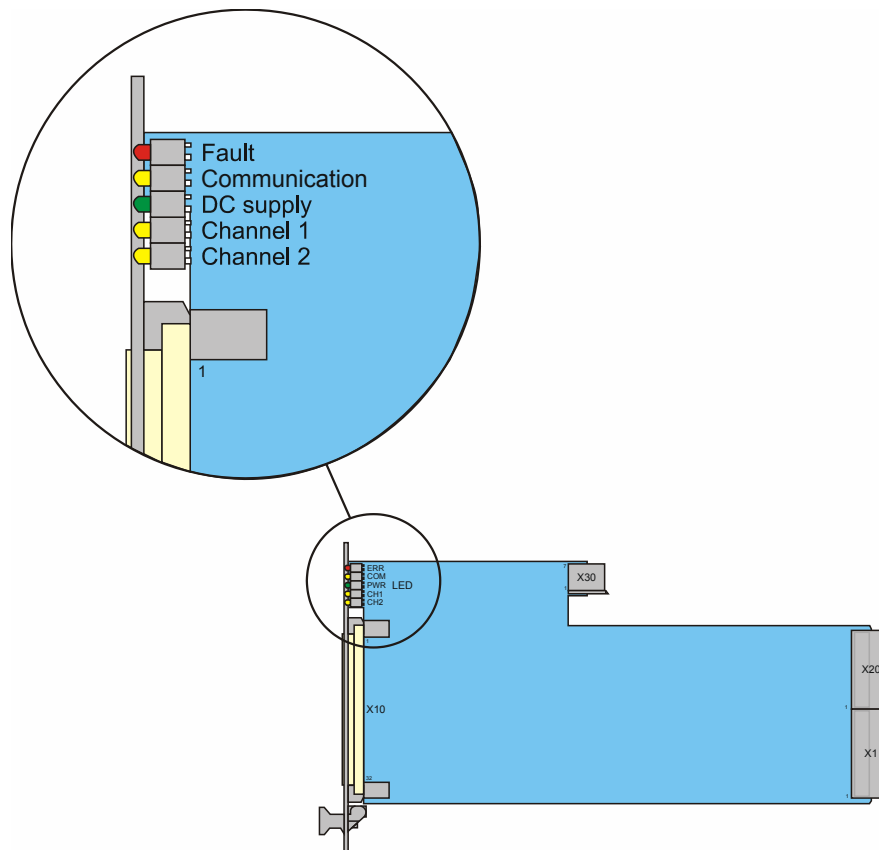

Figure 4-3: Arrangement of the LEDs on the PSU power module

There are five light emitting diodes (LEDs) on the front panel of the PSU power module. They indicate the current status of the module. The meaning of the LEDs is as follows:

Table 4-2: Display elements on the PSU power module

LED	Description
ERR (red)	Error status: Lit or flashing if an error occurs during the power on test on the R&S TS-PSU module after the power supply is turned on. This means there is a hardware problem in the module. (See also Chapter 8, "Self-Test" , on page 50)
COM (yellow)	Communication: Lit when data is being transferred via the interface.
PWR (green)	Power supply OK: Lit when all necessary power supply voltages are present

LED	Description
CH1 (yellow)	Continuously lit: Channel 1 is working with constant current Flashing: The protective mechanism for Channel 1 has engaged (see also Chapter 5.2.11, "Protective mechanisms" , on page 23)
CH2 (yellow)	Continuously lit: Channel 2 is working with constant current Flashing: The protective mechanism for Channel 2 has engaged (see also Chapter 5.2.11, "Protective mechanisms" , on page 23)

4.3 PSU RIO module

4.3.1 Mechanical layout

The PSU RIO module has been specially developed for operation of the R&S TS-PSU. It is used on the back of the R&S CompactTSVP production platform or R&S PowerTSVP. The height of the board is 3 HE (134 mm). The module is fastened in place by two fastening screws. X20 connects the PSU RIO module with the backplane in the R&S CompactTSVP / R&S PowerTSVP. The PSU RIO module must always be used in the corresponding rear IO slot (R&S CompactTSVP / R&S PowerTSVP) of the inserted PSU power module. The external PSU AC/DC converter is connected on connector X5 to the PSU RIO module.

NOTICE

The PSU RIO module must only be used in combination with the PSU power module. Using it with other modules (for example cPCI/ PXI standard modules) may damage the modules.

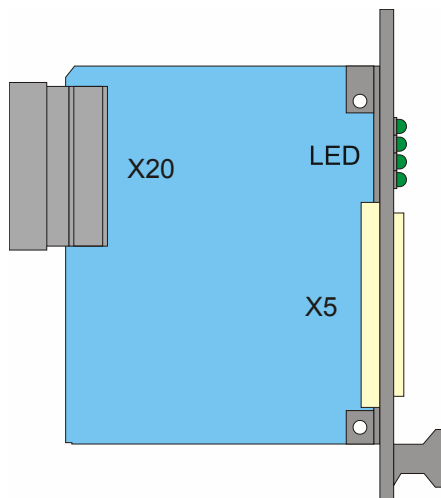

Figure 4-4: Arrangement of plug-in connectors and PSU RIO module LEDs

Table 4-3: PSU RIO module connectors

Abbreviation	Use
X5	PSU AC/DC converter
X20	Extension (rear I/O)

4.3.2 Display elements

(see [Figure 4-4](#))

There are four light diodes (LEDs) on the front of the PSU RIO module. They indicate the current status of the power supply voltages generated by the PSU AC/DC converter. The meaning of the individual LEDs is as follows:

Table 4-4: Display elements on the PSU RIO module

LED	Description
5 V (green)	+5 V DC (CH1) present
8-55 V (green)	+8..55 V DC (CH1) present
5 V (green)	+5 V DC (CH2) present
8-55 V (green)	+8..55 V DC (CH2) present

4.4 PSU AC/DC converter

4.4.1 Mechanical layout

The external PSU AC/DC converter is connected via connector X5 to the PSU RIO module. Connection to the power supply voltage (mains power) is via the power plug

4.4.2 Display and control elements

4.4.2.1 PAC 100W2 (1504.4553.02)

There is an On/Off switch on the PSU AC/DC converter. When the power supply voltage (mains power) is present and the PSU AC/DC converter is turned on, the On/Off switch is lit.

4.4.2.2 PAC 100W2 V535 (1504.4553.03)

There is a mains switch on the PSU AC/DC converter. In the switched on state and when the mains power is present, the green LED near the ventilation slots is lit.

5 Function Description

5.1 General

The Power Supply/Load Module 12V R&S TS-PSU contains two identically structured, floating analog channels. Unless otherwise noted, the following description applies to both channels. [Figure 5-1](#) shows a block diagram of one channels.

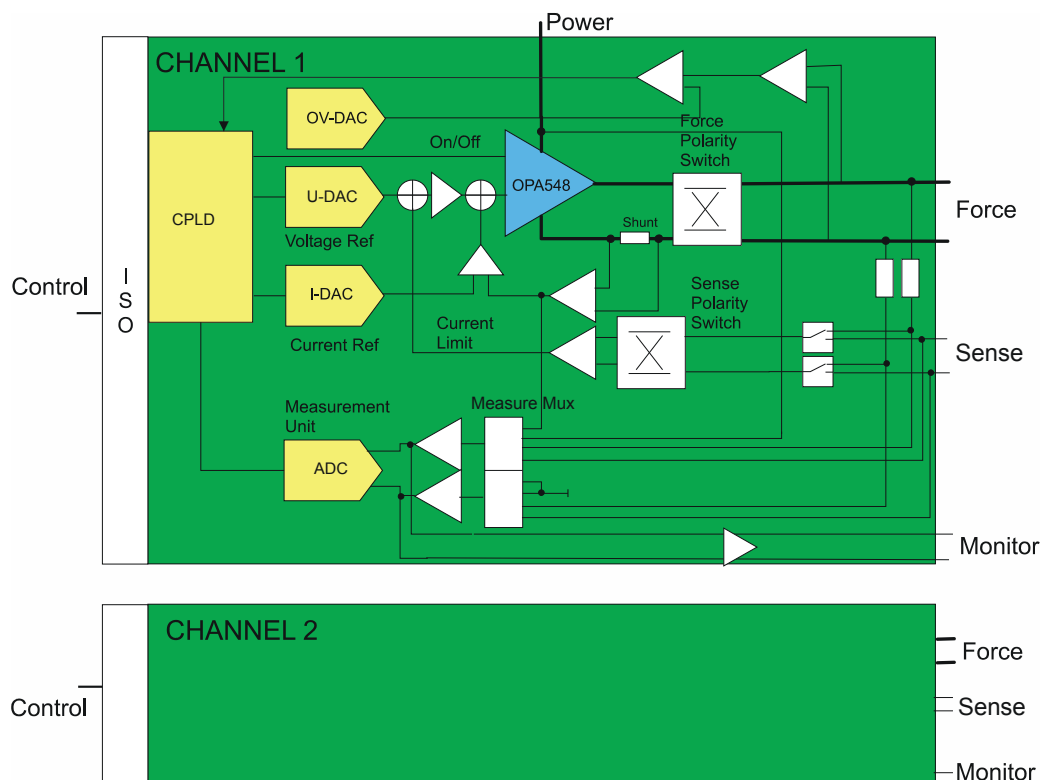

Figure 5-1: Block diagram of channels

5.2 Power supply/load unit

The Power Supply/Load Module 12V R&S TS-PSU is designed as a 4- quadrant source consisting of a 2-quadrant output stage followed by a polarity switch. The output stage consists of a linear regulator with current and voltage feedback. The linear regulator receives its power through the PSU-AC/DC converter.

The settings for output voltage and maximum current are used to configure the output stage.

Users can select between two voltage and three current ranges.

The following voltage ranges are available:

- 50 V
- 15 V

The following current ranges are available:

- 10mA
- 100mA
- 3A

For a summary of the possible combinations of voltages and currents, see the characteristic diagram in [Chapter 5.2.1, "Characteristic diagram"](#), on page 18.

The setting of current and voltage range determines the resolution of the module. Because of this, the smallest possible range appropriate for any given application should be used. The resolution of voltage setting is 16 bits plus a positive/negative sign. For current, 16 bits represent the quantity only; no positive or negative sign can be selected.

Below the maximum current set, the output stage works as a constant voltage source, otherwise as a constant current source, or switches off (depending on the configuration).

Please also refer to [Chapter 5.2.11, "Protective mechanisms"](#), on page 23, [step 5](#).

Switching between source mode (Source) and load mode (Sink) is done automatically.

In sink mode, current is also regulated. In addition, the voltage is programmed to less than the externally applied voltage, to force current flow from the test object to the R&S TS-PSU. This may increase the voltage at the output to rise to the level of the external source, but not beyond the range (15 V, 50 V V).

Over-Voltage-Protection (OVP) should be adjusted appropriately to protect the output stage, especially if the voltage of the external source is higher than the range.

Behaviour when the maximum current is exceeded can be defined by calling function `rspsu_Attr_CurrentLimitBehaviour()`. When „Regulate“ (default state) is selected in parameter behavior, the output current is limited; with “Trip” the output is turned off.

Example of sink operation:

Purpose: Discharging an accumulator with an output voltage of 8 V to 6 V with a maximum discharge current of 1 A. The internal resistance of the accumulator is 1Ω.

Setting R&S TS-PSU: U = 6 V, I = 1 A

The charged accumulator with U = 8 V is connected to the R&S TS-PSU. The R&S TS-PSU controls discharging of the accumulator based on the specified setting so that the current flows at a maximum of I = 1 A. Thus with an internal resistance of 1Ω and a maximum current of 3 A, the voltage difference between the output voltage of the R&S TS-PSU and the voltage of the accumulator must not exceed 1 V. It follows that at the beginning of discharge on the output of the R&S TS-PSU, a voltage of 7 V is present, which slowly drops to a value of 6 V as the accumulator discharges. Once the voltage of the R&S TS-PSU has reached 6 V, that value is maintained. As soon as the accu-

ulator voltage has also fallen to 6 V, no more current will flow and discharging is complete.

5.2.1 Characteristic diagram

The maximum voltage or current values are determined by the characteristic data of the R&S TS-PSU. In addition to the absolute limits 50 V and 3 A, a maximum output power (CURRENT_LIMIT * VOLTAGE_LEVEL) of 50 W must not be exceeded in source operation and 20 W in sink mode (continuous operation). This results in the characteristic diagram for Source and Sink mode shown here (Figure 5-2). Special cases must be taken into consideration for low voltages.

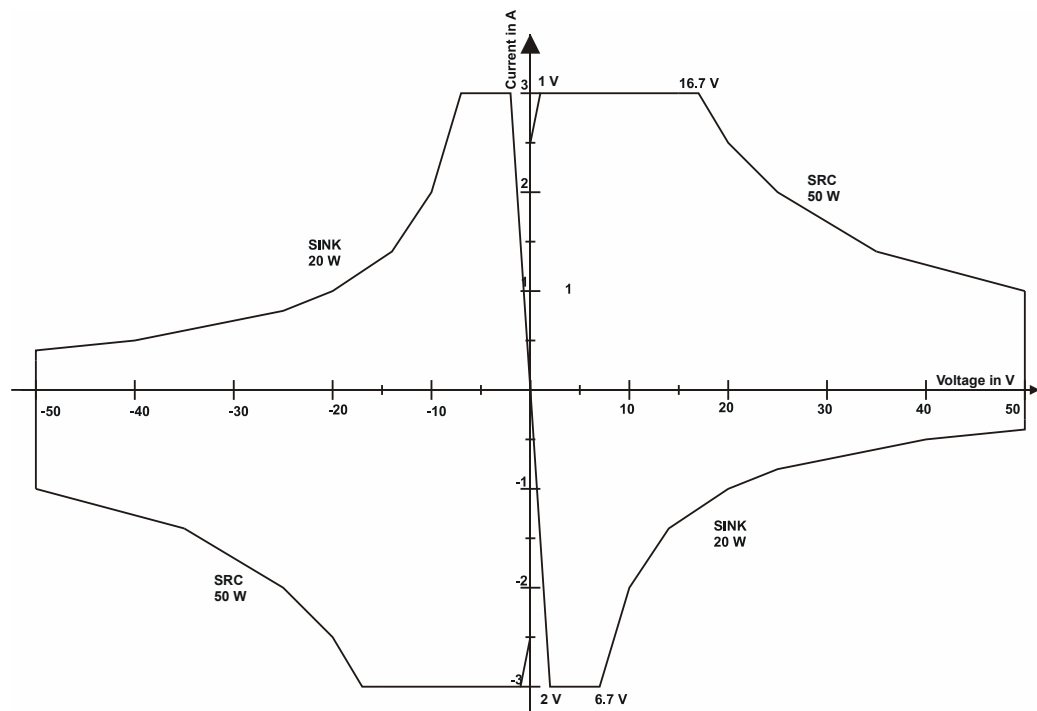

Figure 5-2: Current/voltage characteristic diagram

5.2.2 Reverse polarity in load case

If an external source is connected to the R&S TS-PSU that has the opposite polarity to the output voltage set, the R&S TS-PSU will attempt to impose the polarity set by the user. This must not cause the maximum current set to be exceeded, however. External behaviour depends on the external source and its ability to provide current.

5.2.2.1 Weak external source (current remains below the maximum current)

When weak external sources are connected, the R&S TS-PSU forces the polarity set on its pins.

NOTICE

This reverses the polarity of the external source, which could be damaged under some circumstances!

5.2.2.2 Strong external source (able to provide a high current)

When a strong external source is connected, the R&S TS-PSU detects this and remains in the externally applied quadrant, even though according to specification it should be working in a different quadrant. The R&S TS-PSU sinks the maximum current set. After discharge (voltage on the pins is approximately < 0.8 V) of the external source, the R&S TS-PSU switches to the desired polarity and from then on changes the external source with reverse polarity.

NOTICE

This reverses the polarity of the external source, which could be damaged under some circumstances!

5.2.3 Inductive loads

Turning off inductive loads suddenly can generate very high voltage spikes. Flyback diodes should therefore be used to protect the output stage of the R&S TS-PSU.

If it is not possible to use flyback diodes, proceed as follows when switching off inductive loads:

1. Set the output voltage = 0 V
2. Wait until the current drops to close to 0 A
3. Turn off R&S TS-PSU electronically
4. Open the relay(s)

5.2.4 External sensing

To compensate for voltage drops in the line to the external load or source, the R&S TS-PSU can be set to external sensing. Then two additional lines directly to the test object are required. The measured voltage difference on these lines is automatically regulated to the target voltage by the R&S TS-PSU.

If the R&S TS-PSU is operated with external sensing, the sense lines must be connected to corresponding input pins on the front connector and switched through the relay matrix to the sense inputs. Otherwise an incorrect voltage will be assumed for regulation of the output voltage, causing an incorrect output voltage to be generated. For reasons of safety, however, the error voltage of the output stage is limited to a difference

of approximately 4 - 5 V. This limit also applies if the sense lines are accidentally shorted or connected with reverse polarity. This determines a maximum correctable error voltage based on maximum line resistances of 4 - 5 V.

Since the pins for external sensing are also used for external voltage measurement, no additional external voltage can be measured in "external sensing" mode.

5.2.5 Current limiting when using matrix relays in the output path

Reed relays are used as matrix relays (see [Chapter 5.4.1, "Matrix and front relay"](#), on page 26) in the R&S TS-PSU with a current load capacity of 1 A. Because of this, when a matrix relay from the output path to the analog bus is closed by the software, automatically a current limit of 1 A is turned on. If current limiting was previously set to a lower value, the lower value will be used.

This function can be disabled. In this case, the relays will remain unprotected.

Default setting: „Function enabled“



This protective mechanism is subject to some restrictions. Since current regulation involves a certain delay, peak currents that could cause damage to the relay contacts may nevertheless occur. To prevent such damage, the relay contacts should normally be switched to a no-current state. For this the R&S TS-PSU offers a command to switch (inhibit) outputs on and off electronically by software.

5.2.6 Power dissipation and settling time

The linear regulator in the PSU power module is supplied with power by an external PSU-AC/DC converter. To perform the controlling functions correctly, the linear regulator always requires a supply voltage that is at least approx. 5 V above the respective output voltage.

To check the output voltage of the PSU-AC/DC converter, the user has three different options:

- Mode 1: automatic preselection through the firmware
- Mode 2: Control via the PSU output voltage
- Mode 3: Manual setting via the internal D/A converter

In Mode 1 ("automatic preselection through the firmware"), the firmware selects mode 2 or mode 3 as the optimum operating mode, depending on the current setting. Basically, at a current setting below 400 mA (50 V range) or 1.3 A (15 V range), the PSU-AC/DC converter voltage is set to a fixed value (55 V or 20 V), since the maximum dissipation loss cannot be exceeded in this case (Mode 3). In all the other cases, the PSU-AC/DC converter voltage is controlled through the PSU output voltage (Mode 2).

Mode 2 ("control via the PSU output voltage") ensures that the output stage is always supplied with the minimum voltage required, which keeps the dissipation loss to a minimum too. A disadvantage is that the settling time may be considerably higher with an increase in the nominal output voltage, since the setting speed of the PSU-AC/DC con-

verter output voltage is limited. Approx. 3.5 A are available for the rising edge, which - apart from the output voltage - also have to charge the capacities in the PSU-AC/DC converter and in the PSU power module.

In Mode 3 ("manual setting via D/A converter"), an increase in the PSU output voltage can be achieved at a maximum speed within the range of from 0 V up to the set supply voltage of - 5 V. Excessively high supply voltage in combination with high current values results in high dissipation loss of the output stage and thus, after a certain delay, in thermal cut-out. The static dissipation loss limit is at approx. 22 W, i.e. at 3 A at approx. 7 V of overvoltage.

As a rule, the PSU-AC/DC converter output voltage is always increased at the maximum possible speed. The speed is limited only by the available re-charging current (approx. 3.5 A) and the given capacities on the PSU-AC/DC converter and the PSU power module (together approx. 300 µF).

A decrease in the PSU-AC/DC converter output voltage is effected at different speeds depending on the respective power consumption (the more power, the faster). The time constant without any current flow is approx. 100 ms.

5.2.7 Wiring channels in series (cascading)

Serial wiring of the two output channels of the R&S TS-PSU is possible using external wiring. To do this, current limiting of the two channels should be set to approximately the same value (difference about 1% of range). **We urgently recommend that you remain in constant voltage mode. Otherwise the module may be destroyed at high currents.** If the current exceeds the value set, one channel will first regulate the voltage to a lower value; the second channel will follow somewhat later. The difference is determined by the amplification and offset error of the current regulator.

NOTICE

Each separate GND relay must be set specifically! Both GND relays must never be closed together. Doing so would cause a internal short circuit.

CAUTION

Connecting the outputs of the channels in series (cascading) makes it possible to generate voltages dangerous to the touch of up to 100 V!

Floating channels must never exceed a voltage of 125 V against ground. This applies to each individual connection pin. It is especially important to observe this requirement when both sources are cascaded, for example when they are switched together in the adapter.

For more information, see [Chapter 6.5, "Safety instructions"](#), on page 40.

5.2.8 Connecting channels in parallel

The R&S TS-PSU is **not** designed for parallel wiring of outputs and the possible resulting currents of up to 6 A. Because of this, the outputs must **not** be wired in parallel. Because of the 4-quadrant capability, equalisation currents could flow between the two channels (with one source working in source mode, the other in sink mode).

5.2.9 Electronic on/off and PWM

The R&S TS-PSU has an electronic switch for rapid On / Off switching of the output path. For reasons of safety, the module is automatically switched to “Off” after initialisation.

The R&S TS-PSU also offers an option for quickly switching back and forth between 0 V and the programmed value with the pulse width modulator (PWM) integrated into the module. This makes it possible, depending on the voltage setting, to generate pulses with a width of at least 50 μ s and a maximum frequency of approximately 10 kHz.

5.2.10 Dynamic Operation

Dynamic operation refers to the operation with changing current and/or voltage. It can be achieved as follows:

- Frequent and rapid (<100 ms) reprogramming of the voltage and/or current setting
- Frequent and rapid change of the polarity
- Frequent and rapid change of the load
- PWM Operation
- Output of an “arbitrary waveform”
- Triggered output with frequent and rapid programming of a new voltage and/or current value
- “gated” Operation

With dynamic operation, the descriptions in [Chapter 5.2.6, "Power dissipation and settling time"](#), on page 20 must be heeded by all means with respect to settling time and dissipation loss. Especially with high currents (above 400 mA in the 50 V range, 1.3 A in the 15 V range), the setting of the supply voltage of the output stage is important.

As a rule, this supply voltage cannot be set at any desired speed. Thus, if this voltage is controlled via the mode “Control via the PSU output voltage”, the maximum dissipation loss may still be exceeded, since the supply voltage decreases gradually on the trailing edge of the PSU output voltage, which results in the maximum dissipation loss being exceeded.

An example in this context: Output short-circuited or loaded with low resistance, switched on, current = 0 A, voltage does not matter (e.g. 5 V). With Mode1 (“automatic preselection through the firmware”), the PSU supply voltage is set to 55 V. If the current limit is now set to 3 A, the firmware will switch to “Control via the PSU output voltage”. Since the output voltage is almost 0, the voltage of the PSU-AC/DC converter is reduced, which, however, takes some time. At first, up to a noticeable reduction, the

output stage must process up to $3\text{ A} \times 55\text{ V} = 165\text{ W}$, which results in thermal shut-down with an already heated output stage (due to any previous currents).

5.2.11 Protective mechanisms

A series of protective mechanisms are integrated into the output stage to prevent damage to the R&S TS-PSU and externally connected devices. When necessary, these protective mechanisms turn off the linear regulator of the appropriate channel and open the relays of the force lines. The LEDs assigned to the channel (CH1 or CH2) begin to flash. The channel cannot be connected and activated again until the user has confirmed that the protective mechanism has engaged. Driver function `rspsu_ResetOutputProtection` is used for this purpose. It can also be implicitly called by resetting the module (`rspsu_reset`). The module software can also be used to query whether a channel is in voltage or current mode, and whether a protective mechanism has been triggered.

The module software can also be used to query whether a channel is in voltage or current mode, and whether a protective mechanism has been triggered.

1. Over-voltage protection

If the voltage at the force pins exceeds the programmed threshold value, the protective mechanism will respond. To ensure effective operation, the value must be far enough above normal operation so that minor deviations do not cause triggering.

2. Current monitoring

High currents may flow if regulation fails or in the event of overload. To prevent damage, overcurrent protection engages at approximately 120 % of the current range.

Example:

With a the current range of 3 A, overcurrent protection engages at 3.6 A.

3. Excess temperature protection

Several temperature sensors are built into the R&S TS-PSU to protect the linear regulator. One of these temperature sensors continuously monitors the temperature on the heat sink of the PSU power module. If the limit value of 70°C is exceeded, the protective mechanism for the linear regulator engages. In some applications, however, (for example PWM mode at high frequency and high current), it is possible that only the linear controller will heat up very quickly, without the temperature of the heat sink coming close to the limit temperature of 70°C. A temperature sensor integrated into the linear controller monitors its temperature in addition and switches off the linear controller when necessary to prevent it from being destroyed by excess heat. This condition is also detected by the R&S TS-PSU and results in the affected channel being turned off.

4. Monitoring power supply voltages

If one of the power supply voltages is not correctly applied, this will cause the protective mechanism to engage and the yellow LED for that channel will begin to flash.

5. Current limiting

The behaviour of the current limiting function can be configured. With the “regulate” setting, the set current is controlled (default), with the “trip” setting, the system is switched off in the case of a current flow above the set current value.

5.3 Measurement unit

The integrated measurement unit of the Power Supply/Load Module R&S TS-PSU consist of 16-bit ADC with a sampling rate of 10 kHz and a front end multiplexer for selecting different sources or measurement points. The measurement unit is closely connected to the output stage of the associated channel and works on the same internal measurement reference point.

5.3.1 Measurement options, resolution

The R&S TS-PSU offers the following measurement options:

- Measurement of output voltage on the force pins
- Measurement of voltage on the sense pins
- Measurement of currents via internal shunt

When the output stage is switched to “internal sense” mode, any external voltage can be measured on the sense pins. Without additional wiring only differential measurement is possible, since the R&S TS-PSU cannot switch an internal ground connection to CHx_SHI or CHx_SLO. Due to an external wiring from CHx_LO to CHx_SLO and closing of the ground relay, “single ended” measurement is also feasible. The difference in voltage may be up to 50 V. The maximum voltage of each individual signal must not exceed 50 V against CHx_LO.

The voltage measurement range is always 50 V.

The current measurement range is specified by the setting of the R&S TS-PSU. For example, if the range is set to 10 mA, the range of the measurement unit will also be ± 10 mA.

5.3.2 Sampling

The measurement unit implemented on the R&S TS-PSU makes it possible to record individual values, average values, or entire waveforms. To record transient processes or current and voltage values over time, the R&S TS-PSU is able to record the selected source at a sampling rate of up to 10 kHz and save measurement values. The available memory depth is designed for up to 10000 measurement values. The sampling rate, duration of recording, start delay, and triggering can be freely selected. At the maximum sampling frequency, an interval of one second can still be measured. Correspondingly longer recording is possible at lower sampling frequencies. The measurement can be started via internal or external triggers. It is also possible to start the measurement in the background and retrieve the measurement values later.

5.3.3 Monitor output

The R&S TS-PSU has two pins on the X10 front connector that pass the input voltage of the ADC to the output through a buffer. In this way, the selected measurement source can be recorded using an external oscilloscope or digitizer. The voltages and value range on these monitor outputs (CHx_MHI and CHx_MLO) are as follow:

Table 5-1: Voltages and value range of monitor outputs

Selected source	Source signal for 2.50V full scale of monitor voltage	Conversion factor
Force voltage	52.7 V	Source signal in V = 21.08 * monitor voltage in V
Sense voltage	52.7 V	Source signal in V = 21.08 * monitor voltage in V
Current 10 mA	12.6 mA	Source current in mA = 5.02 * monitor voltage in V
Current 100 mA	120 mA	Source current in mA = 48.1 * monitor voltage in V
Current 3 A	3.73 A	Source current in A = 1.49 * monitor voltage in V

The monitor output signal must be measured differentially at high impedance. 10 kΩ is built in internally before CHx_MHI and CHx_MLO each as a protective mechanism against short-circuits.



Signals CHx_MHI / CHx_MLO must be measured floating against the force or sense potential. Depending on the quadrant of the source, the potential against CHx_MLO approximates CHx_LO (output voltage positive) or CHx_HI (output voltage negative). This means the common mode voltage on CHx_MLO against CHx_LO is approximately 0 V to approximately -50 V.

5.4 Relay matrix

The relay matrix implemented in the Power Supply/Load Module R&S TS-PSU is used for flexible connection and simple wiring of test objects. Its layout is as follows:

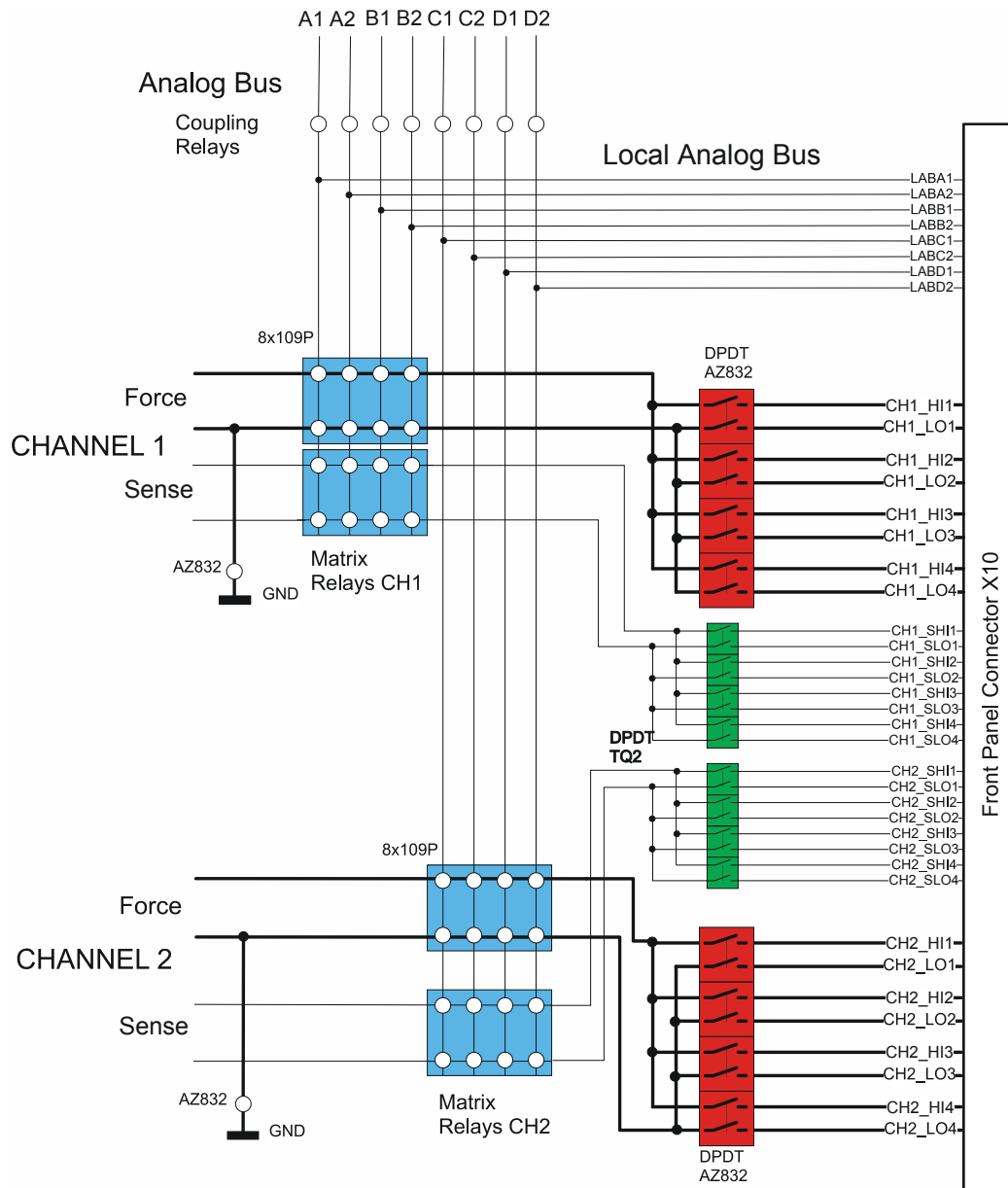

Figure 5-3: Signal connection

5.4.1 Matrix and front relay

The front lines can be switched via the front relays to four outputs on the front connector.

The Pins on the front connector are designed for a current load of max. 1 A per pin, i.e. with higher currents, several pins must be used to prevent that the plug-type connector is destroyed due to overload.

Four sense or measurement inputs (two-pin) can also be directed via the sense lines with a maximum current of 1 A to the source or measurement unit.

All lines have access to the local analog bus through the matrix relay and via the coupling relays to the analog bus in the R&S CompactTSVP

All matrix relays and coupling relays can switch a maximum of 1 A. For safety reasons, current limiting is automatically reduced to 1 A when a matrix relay is in use, although this mechanism offers only limited, additional protection (see [Chapter 5.2.5, "Current limiting when using matrix relays in the output path"](#), on page 20).

To prevent the relay contacts from being destroyed, the relays should only be switched if no current is flowing through them. Before a contact is activated, the channel should be turned off electronically.

The following functions are available to operate these relays:

- `rpsu_Connect`
- `rpsu_Disconnect`
- `rpsu_DisconnectAll`

The function `rpsu_DisconnectAll` can be used to break all connections that were set up with `rpsu_Connect`. `rpsu_DisconnectAll` has no effect on the configuration of the coupling relays or ground relay.

5.4.2 Coupling Relays

The coupling relays connect the local analog bus on the module with the analog bus in the R&S CompactTSVP. The function `rpsu_ConfigureCoupling` defines the status of the coupling relays. Please consider that the function `rpsu_DisconnectAll` does not open these relays.

5.4.3 Ground relays

Each channel of the R&S TS-PSU has its own ground relay that can be used to connect the CHx_LO signal to ground. PSU channels are operated ground free in their basic state. The function `rpsu_ConfigureGround` is used to determine whether a channel is being operated with ground reference or ground free. Also note that `rpsu_DisconnectAll` does not affect the ground relay!



For technical reasons, a non-switched PSU channel (all matrix and front relays of a channel are opened) is automatically grounded with the ground relay. It is automatically opened again before another connection is made if the channel is configured ground-free.

5.5 Trigger unit

5.5.1 Trigger outputs

The Power Supply/Load Module R&S TS-PSU can generate trigger signals on lines PXI_TRIGn (X20) and XTO n (X10). The polarity of the trigger signal can be adjusted. The following events may cause a change in the level on trigger lines:

- Call to function `rspsu_InitiateTrigger`. This function generates a “General Purpose” trigger (trigger pulse approximately 1 μ s long) if trigger source “GP” has been configured to one or more trigger outputs by `rspsu_ConfigureTriggerOutput`.
- Switching a channel on or off if trigger source “CH1” or “CH2” has been configured to one or more trigger outputs by `rspsu_ConfigureTriggerOutput`.

5.5.2 Trigger inputs

Trigger signals on trigger inputs PXI_TRIGn (X20) and XTIn (X10) can start a measurement value recording (voltage or current) in the measurement unit or set the output voltage and current limiting of the source to a new value. The two channels can be triggered synchronously.

5.6 Operation as electronic load

5.6.1 General

The following additional modes are available to operate the Power Supply/Load Module R&S TS-PSU as an electronic load:

- Operation as constant current sink (Constant Current Mode)
- Operation as a constant resistance load (Constant Resistance Mode)
- Operation as a load with constant power (Constant Power Mode)

In these modes, the device software uses both the supply / load unit and the measurement unit to control the electronic load. Therefore, the measurement unit cannot be used by the operator in these modes. In these modes, the applied voltage and the current flowing are continuously measured by the measurement unit and evaluated by the device software depending on the selected mode. The modes can be activated using the `rspsu_ConfigureMode` function.

In the constant current mode, the measured voltage is used to monitor the polarity of the connected source. The measured current is compared with the reference value. If it lies within the tolerance range, the status „Regulated“ is indicated.

In the resistance load and constant power load modes, the input voltage is continuously measured and the new value for limiting the current is calculated and set. When the applied voltage is stable and thus current limitation is correctly set, a current measurement is performed. If the measured value lies within the expected tolerance range, regulation is engaged and the „Regulated“ status bit is set.

The measuring rate and the adjustment speed of the R&S TS-PSU are limited. In the worst case, the time for adjusting the current is 12.8 ms. For the current to be adjusted, the applied voltage must be stable. The load modes cannot therefore be used for AC voltages.

Inductance in series to the load can impair the stability of the regulation. It counteracts the change in the current:

$$dU = -L * di / dt.$$

A current increase of 1 A / μ s with an inductance of 1 μ H creates a voltage drop of 1 V.

To counteract voltage drops, the regulation algorithm limits the current increase to 100 mA / 400 μ s. In addition, the integral component of the PI algorithm counters voltage fluctuations. This stabilises the regulation.

Other measures to prevent oscillating regulation include:

- Connecting a capacitor parallel to the output to stabilise the voltage.
- Choosing the largest possible wire cross-section to connect the load.
- Using the shortest possible wires.
- Keeping the space between the outward and return wires to a minimum (twisted wires are the optimum solution).

The current regulation status can be queried using the `rspsu_QuerySinkState` driver function. As well as a status register, this function also returns the measured voltage and current values. As the measurement unit cannot record current and voltage simultaneously and only with a delay, two bits in the status register indicate the validity of the other return values. If the return values are invalid, the value `IVI_VAL_NAN` is returned for current and/or voltage.

The following bits are defined in the status register:

Table 5-2: Bits in status register for load simulation

Symbolic name	Value	Meaning
RSPSU_SS_VOLT_VALID	0x0001	This bit is set if a valid voltage value is present. The associated „OVR“ bit (over range) is then also valid. After turning on the R&S TS-PSU in the load modes, it takes some time until the first measurement result is available.
RSPSU_SS_CURR_VALID	0x0002	This bit is set if a valid current value is present. The associated „OVR“ bit (over range) is then also valid. After turning on the load, it takes some time until the first measurement result is available. The current measurement is only performed if the measured voltage is stable. Each time a change in voltage is measured, this bit is initially reset and current measurement interrupted.
RSPSU_SS_REGULATED	0x0004	This bit is set if the current flowing into the R&S TS-PSU module and measured using the measurement unit lies within a tolerance range around the reference value. The following tolerances are used: 10 mA range $\pm 134 \mu\text{A}$ 100 mA range $\pm 1.3 \text{ mA}$ 3 A range $\pm 40 \text{ mA}$ The applied voltage must be stable for the current measurement to be performed. This bit is reset when the input voltage changes.
RSPSU_SS_VOLT_OVR	0x0010	This bit is set if the measured voltage is outside the set range. In this case, IVI_VAL_NAN is returned for the measured value and the R&S TS-PSU is shut down. The shutdown must be acknowledged by the operator before the channel can be used again. Refer to chapter Chapter 5.2.11, "Protective mechanisms" , on page 23.
RSPSU_SS_CURR_OVR	0x0020	This bit is set if the measured current is outside the set range. In this case, IVI_VAL_NAN is returned for the measured value.



The other bits in the status register are used for internal purposes and can thus have different values.



Switching on the *External Sensing* and usage of the sense wires increases the accuracy during operation as a constant resistance load (Constant Resistance Mode) or operation as a load with constant power (Constant Power Mode).

5.6.2 Operation as constant current sink

Examples of the use of this mode include discharging batteries or determining the capacity of a battery. A constant current is drawn from the connected source until the set output voltage (final discharging voltage) is reached. This mode differs from „Normal“ mode in that the polarity of the R&S TS-PSU is automatically adjusted to the connected source. To do this, the voltage is measured using the measurement unit and the load unit is reconfigured if required (reverse polarity protection). Refer to [Chapter 5.2.2, "Reverse polarity in load case"](#), on page 18.

This mode is configured using the `rspsu_ConfigureConstCurrent` function. This is used to set the current to be drawn and the output voltage of the R&S TS-PSU. To achieve high accuracy, an appropriate range should be selected for the voltage and current.

NOTICE

The externally applied voltage may not exceed the upper limit of the range. The over voltage protection should be adjusted appropriately to protect the limit. Refer to [Chapter 5.2, "Power supply/load unit"](#), on page 16.

5.6.3 Operation as resistance load

The main characteristic of this mode is that the load current depends on the applied voltage in line with Ohm's Law. An electronic resistance load is used to load external sources with a constant resistance. Practical applications include:

- Power pack test
- Battery test
- Testing microprocessor voltage regulation circuits

The applied voltage is continuously measured by the device software and the current limitation is adjusted depending on the programmed resistance value. The R&S TS-PSU output voltage is set to 0 V. When the applied external voltage has a stable value, regulation is verified using the current measurement.

The `rspsu_ConfigureConstResistance` function can be used to set the required resistance value. The value that can be reached depends on the selected ranges. The following table shows the range limits.

Table 5-3: Range limits for operation as resistance load

Current range	3 A		100 mA		10 mA	
	15 V	50 V	15 V	50 V	15 V	50 V
R _{min}	2/3 Ω	2/3 Ω	5 Ω	5 Ω	50 Ω	50 Ω
R _{max}	1500 Ω	5000 Ω	15 kΩ	50 kΩ	150 kΩ	500 kΩ

Note that the maximum resistance can only be reached if the applied voltage is sufficiently high. The higher voltage guarantees that a current is flowing that can be regulated by the R&S TS-PSU. However, the externally applied voltage may not exceed the upper limit of the range. The over voltage protection should be adjusted appropriately to protect the limit. Refer to [Chapter 5.2, "Power supply/load unit"](#), on page 16. The minimum resistance is only reached if the voltage is low enough to ensure that the current limitation range is not exceeded. For regulation to continue functioning correctly, the voltage may not be lower than 0.5 V.

5.6.4 Operation as load with constant power

The main characteristic of this mode is that the load current depends on the applied voltage and a set power. Therefore, an external source is loaded with a constant power.

In this mode, the voltage is also measured by the device software and the current limitation is adjusted accordingly. The R&S TS-PSU output voltage is set to 0 V.

The `rspsu_ConfigureConstPower` function can be used to set the required power. The value that can be reached depends on the selected ranges. The following table shows the range limits.

Table 5-4: Range limits for operation as resistance load

Current range	3 A		100 mA		10 mA	
	15 V	50 V	15 V	50 V	15 V	50 V
P _{min}	5 mW	5 mW	0,5 mW	0,5 mW	50 μW	50 μW
P _{max}	20 W	20 W	1,5 W	5 W	0,15 W	0,5 W

Note that the minimum power can only be reached if the applied voltage is sufficiently low. However, the voltage may not be lower than 0.5 V. At voltages of less than 0.1 V, the current limitation is always set to the lowest possible value in the currently selected range. The maximum power is then only reached if the voltage is sufficiently high. This means that the maximum current in the range is not exceeded. The externally applied voltage may not exceed the upper limit of the voltage range. The over voltage protection should be adjusted appropriately to protect the limit. Refer to chapter 5.2.



For voltage jumps at the electronic load input or when turning on, when regulating the current the external source can be temporarily loaded with higher currents than in the regulated state. If the voltage from the source then drops, the requirement for constant power regulates the current limitation to a higher value. If the external source cannot supply this current and the voltage falls further, an unexpected operating point occurs. In this case, it makes sense to initially apply a lower load to the source.

5.6.5 Regulation accuracy

The regulation accuracy in „Constant Resistance“ and „Constant Power“ mode depends on the voltage measurement accuracy and the accuracy of the adjustable current for current limitation.

The data sheet includes the following accuracies:

Voltage measurement accuracy:

- $\pm (0.1\% + 50 \text{ mV})$

Current regulation accuracy:

- in 10 mA range: $\pm (0.4\% + 20 \text{ }\mu\text{A})$
- in 100 mA range: $\pm (0.4\% + 200 \text{ }\mu\text{A})$
- in 3 A range: $\pm (0.4\% + 6 \text{ mA})$

The regulation accuracy can be calculated as follows:

The input voltage is used to calculate the minimum / maximum measured voltage:

- $U_{\min} = U - (U * 0.1\% + 50 \text{ mV})$
- $U_{\max} = U + (U * 0.1\% + 50 \text{ mV})$

The minimum / maximum measured voltage can be used to calculate the minimum / maximum target current:

In „Constant Resistance“ mode:

- $I_{\text{nom, min}} = U_{\min} / R_{\text{nom}}$
- $I_{\text{nom, max}} = U_{\max} / R_{\text{nom}}$

In „Constant Power“ mode:

- $I_{\text{nom, min}} = P_{\text{nom}} / U_{\max}$
- $I_{\text{nom, max}} = P_{\text{nom}} / U_{\min}$

By specifying the current accuracy of the source, $I_{\text{nom, min}}$ and $I_{\text{nom, max}}$ can be used to calculate the minimum / maximum value of the set current limitation.

For example, for the 3 A current range:

- $I_{\min} = I_{\text{nom, min}} - (I_{\text{nom, min}} * 0.4\% + 6 \text{ mA})$
- $I_{\max} = I_{\text{nom, max}} + (I_{\text{nom, max}} * 0.4\% + 6 \text{ mA})$

The minimum current limitation value I_{\min} , the maximum current limitation value I_{\max} and the input voltage can be used to calculate the minimum resistance R_{\min} , the maximum resistance R_{\max} , the minimum power P_{\min} and the maximum power P_{\max} .

- $R_{\min} = U / I_{\max}$
- $R_{\max} = U / I_{\min}$
- $P_{\min} = U * I_{\min}$
- $P_{\max} = U * I_{\max}$

The graphs below show examples of the maximum error depending on the reference value and the measured voltage.

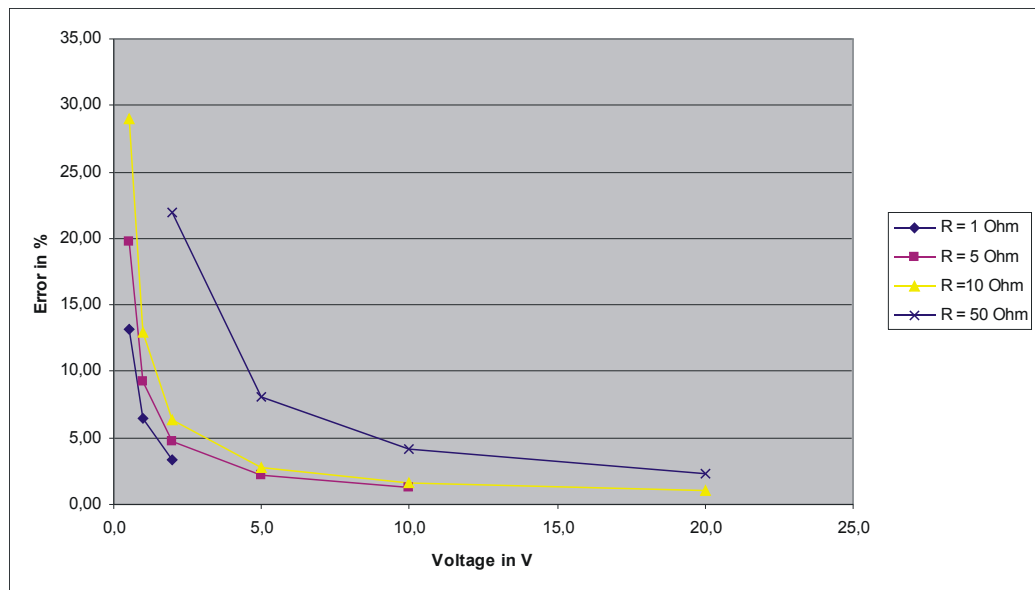

Figure 5-4: Error in „Constant Resistance“ mode in 3 A range

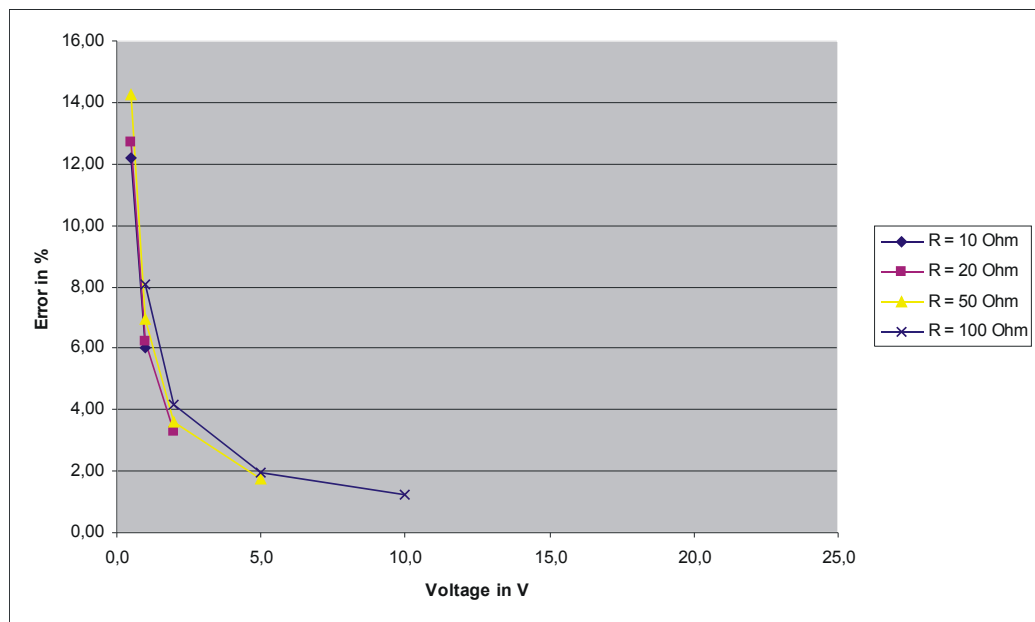

Figure 5-5: Error in „Constant Resistance“ mode in 100 mA range

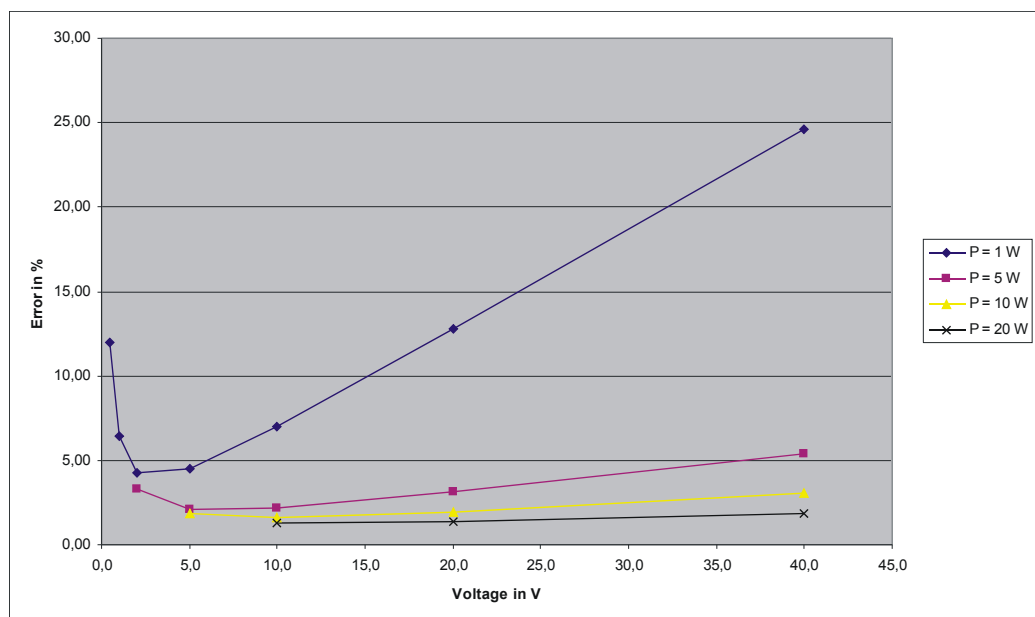

Figure 5-6: Error in „Constant Power“ mode in 3 A range

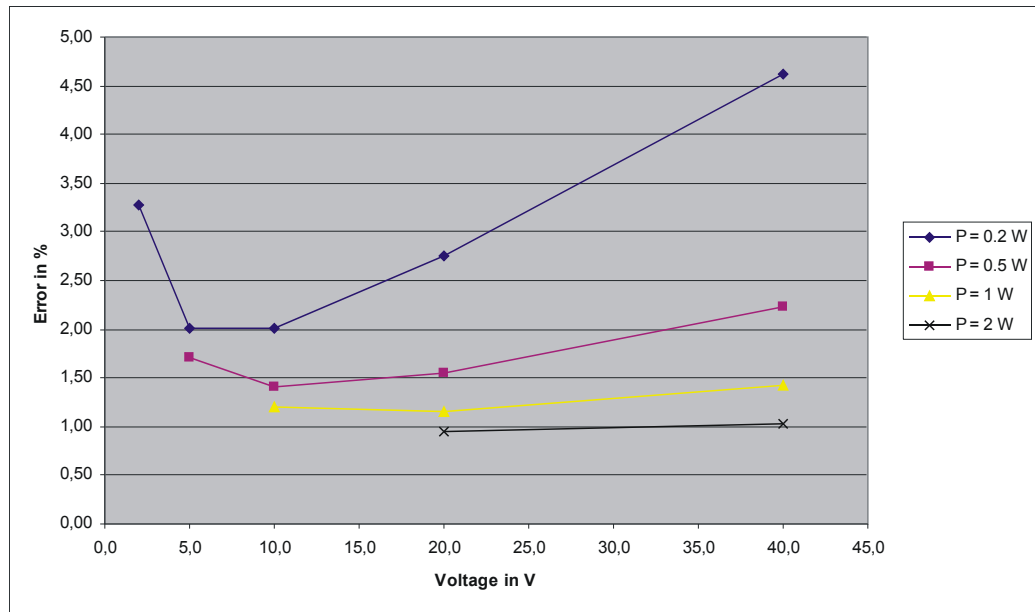

Figure 5-7: Error in „Constant Power“ mode in 100 mA range

5.6.6 Load simulation data

Table 5-5: Load simulation data

	Load channel data					
Voltage:	15 V			50 V		
Current:	0 - 10 mA	0 - 100 mA	0 - 3 A	0 - 10 mA	0 - 100 mA	0 - 3 A
Power:	20 W continous; 25 W peak					
Minimum voltage:	0,5 V	0,5 V	0,5 V	0,5 V	0,5 V	0,5 V
	Operation as constant current sink					
Range:	0 - 10 mA	0 - 100 mA	0 - 3 A	0 - 10 mA	0 - 100 mA	0 - 3 A
Resolution:	0.39 μ A	3.7 μ A	115 μ A	0.39 μ A	3.7 μ A	115 μ A
Accuracy[1]:	0.4% + 20 μ A	0.4% + 200 μ A	0.4% + 6 mA	0.4% + 20 μ A	0.4% + 200 μ A	0.4% + 6 mA
	Operation as resistance load					
Range:	50 Ω - 150 k Ω	5 Ω - 15 k Ω	2/3 Ω - 1,5 k Ω	50 Ω - 500 k Ω	5 Ω - 50 k Ω	2/3 Ω - 5 k Ω
Resolution:	1 m Ω	100 $\mu\Omega$	10 $\mu\Omega$	1 m Ω	100 $\mu\Omega$	10 $\mu\Omega$
	Operation as load with constant power					

Operation as electronic load

Range:	50 μ W - 0.15 W	0.5 mW - 1.5 W	5 mW - 20 W	50 μ W - 0.5 W	0.5 mW - 5 W	5 mW - 20 W
Resolution:	100 nW	1 μ W	10 μ W	100 nW	1 μ W	10 μ W

[1] Accuracy: \pm (% of set value + absolute value)

6 Commissioning

6.1 Installation of the PSU power module

To install the PSU power module, proceed as follows:

- Run down and power off the TSVP

NOTICE

To facilitate optimal heat dissipation, if multiple R&S TS-PSU modules are used, they should be installed distributed in the R&S CompactTSVP / R&S PowerTSVP housing.

- Remove the front panel from the rear side of the TSVP chassis by slackening off the screws

NOTICE

Damaged backplane due to bent pins

Bent pins may result in permanent damage to the backplane.

Check the backplane connector for bent pins!

Any pins that are bent must be straightened!

When module is connected, it must be guided with both hands and carefully pressed into the backplane connector.

- Press in the module applying moderate pressure.
- The PSU power module is correctly located when a distinct 'stop' can be felt
- Tighten the top and bottom screws on the front panel of the PSU power module



Install the PSU RIO module as described in [Chapter 6.2, "Installation of the PSU RIO module"](#), on page 38.

6.2 Installation of the PSU RIO module



Before the PSU RIO module can be installed, the PSU power module must be installed first (see [Chapter 6.1, "Installation of the PSU power module"](#), on page 38)

To install the PSU RIO module, follow these steps:

- Select the appropriate rear I/O slot for the RIO module.
- Remove the appropriate rear plate section on the R&S CompactTSVP / R&S PowerTSVP housing by loosening the two screws.

NOTICE**Damaged backplane due to bent pins**

Bent pins may result in permanent damage to the backplane.

Check the backplane connector for bent pins!

Any pins that are bent must be straightened!

When module is connected, it must be guided with both hands and carefully pressed into the backplane connector.

- Press in the PSU RIO module applying moderate pressure.
- Tighten the upper and lower screws on the front plate of the PSU RIO module.

6.3 Connecting the PSU AC/DC converter

To connect the PSU AC/DC converter, follow these steps:

- Attach the connection cable to the appropriate plug (X5) on the PSU RIO module and tighten.
- Connect the plug of the PSU AC/DC converter with the power supply socket.

6.4 Switching on sequence

After the module is installed in a R&S CompactTSVP or R&S PowerTSVP, there is no switching on or switching off sequence that needs to be observed for use of the PSU AC/DC converter and the corresponding TSVP. If the PSU AC/DC converter is turned on after the R&S CompactTSVP / R&S PowerTSVP, the two yellow LEDs for Channels 1 and 2 continue to flash until the module is accessed by the software and the protection mechanism is thereby turned off.

6.5 Safety instructions

6.5.1 General

⚠ CAUTION

The R&S CompactTSVP/ R&S PowerTSVP production test platform and the Power Supply/Load Module R&S TS-PSU are designed so that users can operate at voltages up to 125 V. The requirements according to EN61010-1 for operation with “hazardous live” voltages must be observed.

NOTICE

If signals with voltages dangerous to the touch are being transferred via the analog bus, all modules involved, including PXI-external modules, must be specified for the relevant voltage.

6.5.2 Replacing the R&S TS-PSU

⚠ CAUTION

Before replacing the R&S TS-PSU, the R&S CompactTSVP/ R&S PowerTSVP must always be turned off or the power plug must be disconnected. All connections to external test objects must be disconnected.

⚠ CAUTION

Before the PSU power module is removed from the R&S CompactTSVP / R&S PowerTSVP housing, make certain the module has had sufficient time to cool off. The cooling body of the PSU power module may heat up during operation under full load, etc.. In order to avoid possible injury (for example burns) to the user, the PSU power module should be cooled off before it is removed. The cooling-off process can be sped up if the PSU AC/DC converter is turned off or the output stage is disconnected via the relay while the R&S CompactTSVP / R&S PowerTSVP and its fans continue to run.

6.5.3 Instructions for operation with voltages dangerous to the touch

In conformity with EN 61010-1, the following voltage limit values are considered „Hazardous live“.

- 70 V DC
- 33 V AC eff
- 46.7 V AC peak

⚠ CAUTION

When operating the Power Supply/Load Module 12V R&S TS-PSU above these voltage limit values, the requirements of EN61010-1 must be observed.

The Power Supply/Load Module 12V R&S TS-PSU and Test System Versatile Platform R&S CompactTSVP / R&S PowerTSVP are designed for a maximum voltage of 125 V between ground-free measurement devices, analog buses, and GND. Care must be taken to ensure that this limit is not exceeded at any time, even as the sum of voltages, and thus not as a result of alternating signals.

Figure 6-1 shows a typical permissible voltage configuration between analog buses and ground.

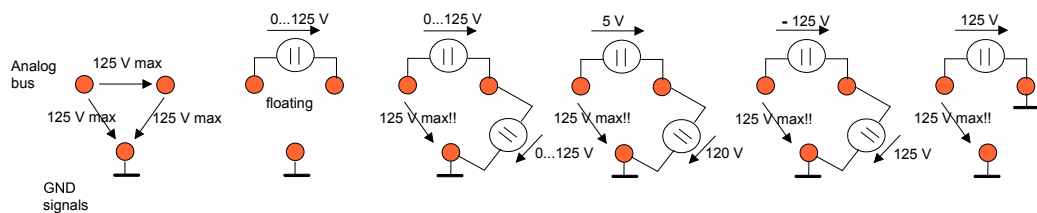

Figure 6-1: Permissible voltages on analog bus lines

For reasons of fire prevention in conformity with EN 61010-1, we recommend limiting the current or output for DC sources to 150 VA.

7 Software

7.1 Driver Software

A LabWindows IVI driver is available to control the Power Supply/Load Module R&S TS-PSU that supports classes IVI DCPWR and IVI SWTCH. All other functions of the hardware are supported by specific extensions of the driver. The driver is a component of the ROHDE & SCHWARZ GTSL software. All functions of the driver are documented extensively in online Help and in the LabWindows/CVI Function Panels.

During driver installation, the following software modules are installed:

Table 7-1: Driver Installation R&S TS-PSU

Module	Path	Comment
rpsu.dll	<GTSL directory>\Bin	Driver
/ rpsu.chm	<GTSL directory>\Bin	Help files
rpsu.fp	<GTSL directory>\Bin	LabWindows CVI Function Panel file, function panels for CVI development interface
rpsu.sub	<GTSL directory>\Bin	LabWindows CVI attribute file. This file is required by some „function panels“.
rpsu.lib	<GTSL directory>\Bin	Import Library
rpsu.h	<GTSL directory>\Include	Header file for the driver



To use the driver, the IVI and VISA libraries from National Instruments are necessary.

7.2 Softpanel

A "Soft-Panel" is included with the software package for R&S TS-PSU (see [Figure 7-1](#)). The Soft-Panel requires the support of the IVI driver. It makes it possible to operate the module interactively.

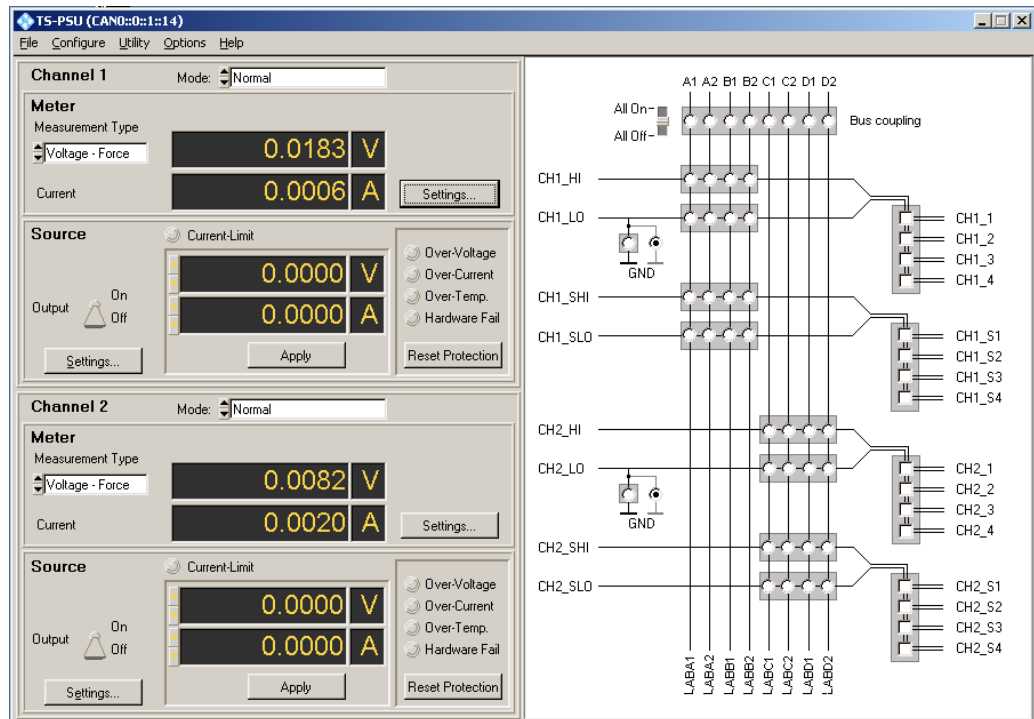

Figure 7-1: Softpanel R&S TS-PSU



The operation of the Softpanel is described in Chapter 13 of the “GTSL Software Description”.

7.2.1 Configuration of sources



Activating the "Settings..." button from the "Source" area calls the dialogue for configuring sources.

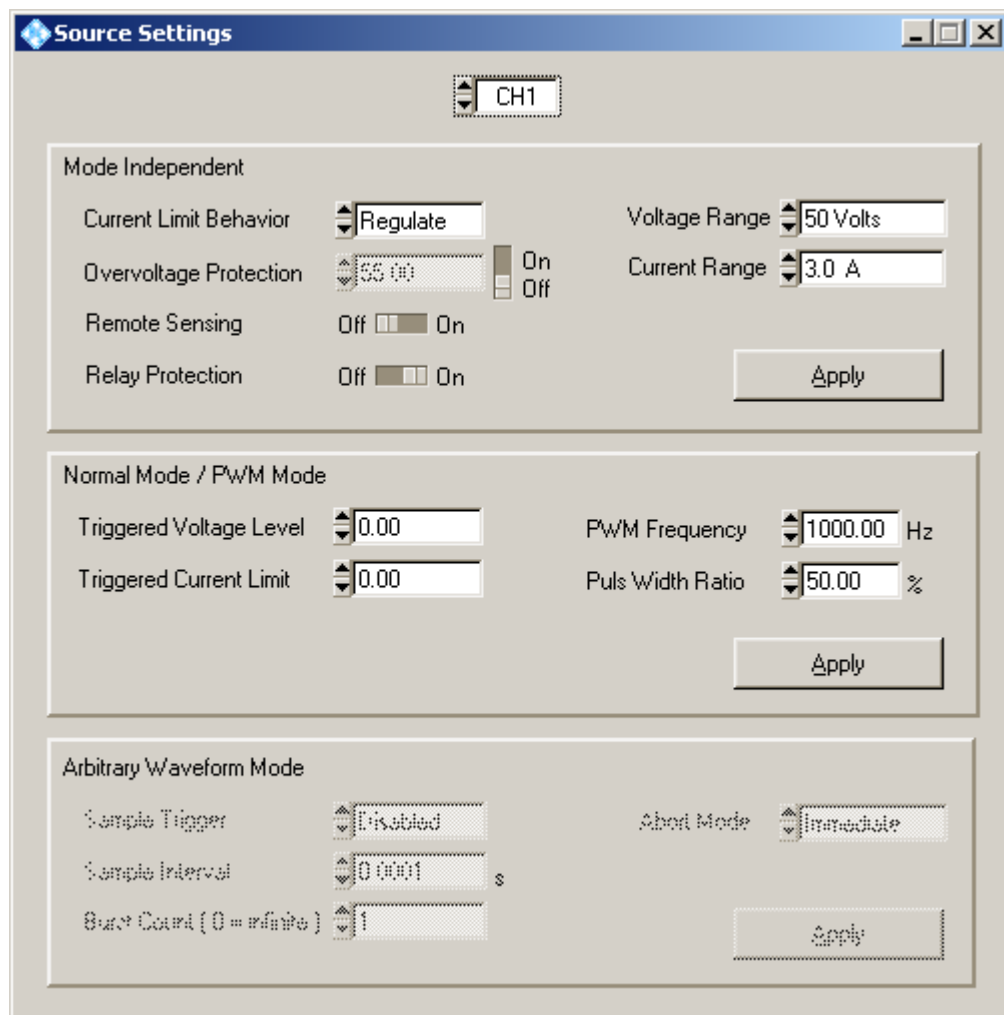

Figure 7-2: Configuration of sources

7.2.2 Configuration of measurement units

Settings...

Activating the "Settings..." button from the "Meter" area calls the dialogue for configuring measurement units.

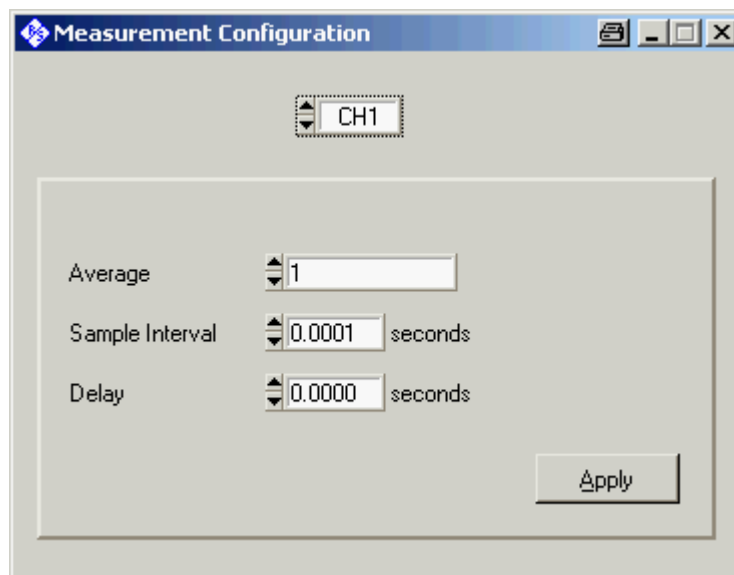

Figure 7-3: Configuration of measurement units

7.3 Sample programmes

7.3.1 Programming with GTSL libraries

/*

This example connects channel 1 to the front connector, configures current limit and voltage, switches the source on and measures the output current.

Error handling is not considered in this sample in order to keep it easy to read. The return status should be checked for "errorOccured" after each library call.

The following configuration files are used in this example:

```
physical.ini
-----
[device->psu]
Type          = PSU
ResourceDesc  = CAN0::0::1::12
DriverDll     = rpspu.dll
DriverPrefix  = rpspu
DriverOption  = "Simulate=0"
```

```

PsuApplication.ini
-----
[bench->dcpwr]

; configure the TS-PSU as power supply
DcPwrSupply1 = device->psu
DcPwrChannelTable = io_channel->dcpwr

; configure the TS-PSU as switch device
SwitchDevice1 = device->psu
AppChannelTable = io_channel->switch

; configure the DC power channels
[io_channel->dcpwr]
CH1 = psu!CH1
CH2 = psu!CH2

; configure the switch channels
[io_channel->switch]
CH1 = psu!CH1
CH1_1 = psu!CH1_1

*/

#include "resmgr.h"
#include "dcpwr.h"
#include "swmgr.h"

int main (int argc, char *argv[])
{
    long residDcpwr; /* resource ID for DC power supply library */
    long residSwmgr; /* resource ID for switch manager library */

    short errorOccurred = 0;
    long errorCode = 0;
    char errorMessage [GTSL_ERROR_BUFFER_SIZE] = "";

    double result = 0.0;

    /* load the physical and application configuration files */
    RESMGR_Setup ( 0, "physical.ini", "PSUApplication.ini",
                  &errorOccurred, &errorCode, errorMessage);

    /* initialize the DC power supply library */
    DCPWR_Setup ( 0, "bench->dcpwr", &residDcpwr,
                  &errorOccurred, &errorCode, errorMessage);

    /* initialize the switch manager library */
    SWMGR_Setup ( 0, "bench->dcpwr", &residSwmgr,
                  &errorOccurred, &errorCode, errorMessage);

```

```
/* configure channel 1 earth tied */
DCPWR_Conf_Ground_Relay ( 0, residDcpwr, "CH1", 1,
                          &errorOccurred, &errorCode, errorMessage);

/* connect channel 1 to front connector */
SWMGR_Connect ( 0, residSwmgr, "CH1", "CH1_1",
               &errorOccurred, &errorCode, errorMessage);

/* set current limit range for channel 1 to 100.0 mA */
DCPWR_Conf_Output_Range ( 0, residDcpwr, "CH1", DCPWR_VAL_CURRENT, 100.0e-3,
                          &errorOccurred, &errorCode, errorMessage);

/* set current limit for channel 1 to 10 mA; current limit behavior is regulate */
DCPWR_Conf_Current_Limit ( 0, residDcpwr, "CH1", DCPWR_VAL_REGULATE, 10.0e-3,
                           &errorOccurred, &errorCode, errorMessage);

/* select voltage range 15 V*/
DCPWR_Conf_Output_Range ( 0, residDcpwr, "CH1", DCPWR_VAL_VOLTAGE, 15.0,
                          &errorOccurred, &errorCode, errorMessage);

/* set voltage to 10 V */
DCPWR_Conf_Voltage_Level ( 0, residDcpwr, "CH1", 10.0,
                           &errorOccurred, &errorCode, errorMessage);

/* wait until relays have settled; timeout 500 ms */
SWMGR_WaitForDebounce ( 0, residSwmgr, 500,
                       &errorOccurred, &errorCode, errorMessage);

/* switch on channel 1 */
DCPWR_Conf_Output_Enabled ( 0, residDcpwr, "CH1", 1,
                            &errorOccurred, &errorCode, errorMessage);

/* configure the measurement: Sample Count 40, Sample Interval 1 ms, Delay 0.0 */
DCPWR_Conf_Measurement ( 0, residDcpwr, "CH1", 40, 1.0e-3, 0.0,
                        &errorOccurred, &errorCode, errorMessage);

/* measure the output current */
DCPWR_Measure ( 0, residDcpwr, "CH1", DCPWR_VAL_CURRENT, &result,
               &errorOccurred, &errorCode, errorMessage);

/* switch off channel 1 */
DCPWR_Conf_Output_Enabled ( 0, residDcpwr, "CH1", 0,
                           &errorOccurred, &errorCode, errorMessage);

/* disconnect all */
SWMGR_DisconnectAll ( 0, residSwmgr,
                    &errorOccurred, &errorCode, errorMessage);

/* configure channel 1 earth free again */
```

```

DCPWR_Conf_Ground_Relay ( 0, residDcpwr, "CH1", 0,
                          &errorOccurred, &errorCode, errorMessage);

/* close the libraries */
SWMGR_Cleanup ( 0, residSwmgr,
               &errorOccurred, &errorCode, errorMessage);

DCPWR_Cleanup ( 0, residDcpwr,
               &errorOccurred, &errorCode, errorMessage);

RESMGR_Cleanup ( 0, &errorOccurred, &errorCode, errorMessage);

return 0;
}

```

7.3.2 Programming with device drivers

```

/*
This example connects channel 1 to the front connector, configures
current limit and voltage, switches the source on and measures the
output current.

Error handling is not considered in this sample in order to
keep it easy to read. The return status should be checked for
VI_SUCCESS after each driver call.
*/

#include "rspsu.h"

int main (int argc, char *argv[])
{
    ViSession vi;
    ViStatus status;
    ViReal64 result;

    /*
    open a session to the device driver. The resource descriptor
    depends on the slot number of the module and must be adapted
    to the target system.
    */
    status = rspsu_InitWithOptions ("CAN0::0::2::5::INSTR",
                                    VI_TRUE,
                                    VI_TRUE,
                                    "Simulate=0,RangeCheck=1",
                                    &vi);

    /* configure channel 1 earth tied */
    status = rspsu_ConfigureGround (vi, "CH1", VI_TRUE);
}

```

```
/* connect channel 1 to front connector */
status = rspsu_Connect (vi, "CH1", "CH1_1");

/* set current limit range for channel 1 to 100.0 mA */
status = rspsu_ConfigureOutputRange (vi, "CH1", RSPSU_VAL_RANGE_CURRENT, 100.0E-3);

/* set current limit for channel 1 to 10 mA; current limit behavior is regulate */
status = rspsu_ConfigureCurrentLimit (vi, "CH1", RSPSU_VAL_CURRENT_REGULATE, 10.0E-3);

/* select voltage range 15 V*/
status = rspsu_ConfigureOutputRange (vi, "CH1", RSPSU_VAL_RANGE_VOLTAGE, 15.0);

/* set voltage to 10 V */
status = rspsu_ConfigureVoltageLevel (vi, "CH1", 10.0);

/* wait until relays have settled; timeout 500 ms */
status = rspsu_WaitForDebounce (vi, 500);

/* switch on channel 1 */
status = rspsu_ConfigureOutputEnabled (vi, "CH1", VI_TRUE);

/* configure the measurement: Sample Count 40, Sample Interval 1 ms, Delay 0.0 */
status = rspsu_ConfigureMeasurement (vi, "CH1", 40, 0.001, 0.0);

/* measure the output current */
status = rspsu_Measure (vi, "CH1", RSPSU_VAL_MEASURE_CURRENT, & result);

/* switch off channel 1 */
status = rspsu_ConfigureOutputEnabled (vi, "CH1", VI_FALSE);

/* disconnect all */
status = rspsu_DisconnectAll(vi);

/* configure channel 1 earth free again */
status = rspsu_ConfigureGround (vi, "CH1", VI_FALSE);

/* close the driver session */
status = rspsu_close (vi);

return 0;
}
```

8 Self-Test

The Power Supply/Load Module R&S TS-PSU has an integrated capability for self-test. The following tests are implemented:

- LED test
- Power on test
- TSVP self-test

8.1 LED Test

After power-on, all three LED's light up for around three seconds to indicate that the 5 V supply is present and all LED's are working. The following statements can be made about the different LED states:

Table 8-1: Statements about the LED Test

LED	Description
One LED does not light up	Hardware problem on the module LED faulty
No LED's light up	No +5 V supply

8.2 Power on test

The power on test runs in parallel to the LED test. The following observations may be made about the different display states of the LEDs:

Table 8-2: Observations about the power on test

LED	Description
PWR LED (green) on	All power supply voltages are present
PWR LED (green) off	At least one power supply voltage is missing
ERR LED (red) off	No error is present
ERR LED (red) is lit or flashing	Hardware error is present (processor is not starting)
CH1 LED (yellow) off	No error is present
CH1 LED (yellow) flashing*	Channel has been deactivated because of an error (the PSU-AC/DC converter is possibly not be turned on).
CH2 LED (yellow) off	No error is present
CH2 LED (yellow) flashing*	Channel has been deactivated because of an error (the PSU-AC/DC converter may not be turned on).



If you forget to turn on the PSU-AC/DC converter, it can also be turned on later. Following that, the R&S TS-PSU module may be reset with the aid of the Softpanel (see Chapter 7.2, "Softpanel", on page 42).

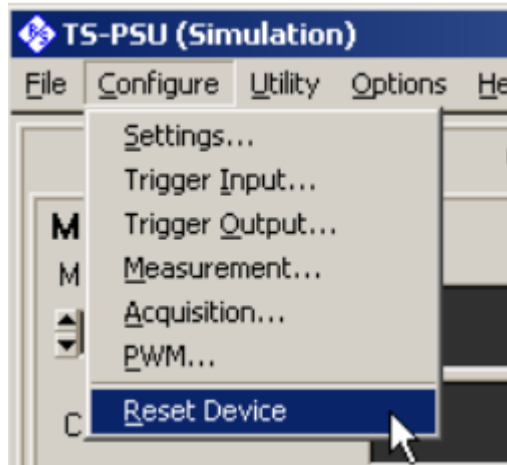

8.3 TSVP self-test

As part of the TSVP self test, an extensive test of the R&S TS-PSU module is performed and an exhaustive protocol is generated. This is done with the "Self-Test Support Library".

The R&S TS-PSAM analog stimulus and measurement module is used as a measurement unit in the TSVP self-test. The functionality of the modules in the system is ensured by measurements via the analog bus.

First the global analog bus and then the local analog bus are tested for valid voltages. These voltages could possibly come from an outside source, for example through sources that are connected. After an isolation measurement between the buses, all the relays (coupling, matrix, multiplexer, sense relays) are tested. The voltage and current measurements of the sources and PSU-AC/DC converter are made. The voltage and current section are tested for the measurement unit. Finally triggering via PXI lines is tested.



You can find information about starting the self-test and the order of required work steps as well as a detailed description of parameters and sequences that are tested in the R&S CompactTSVP / R&S Power TSVP Service Manual.

9 Interface description

9.1 PSU power module

9.1.1 Connector X1

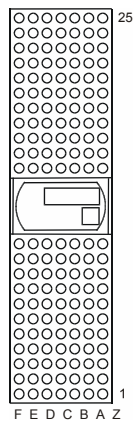

Figure 9-1: Connector X1 (view: mating side)

Pin	F	E	D	C	B	A	Z
25	GND	+5V				+5V	GND
24	GND				+5V		GND
23	GND		+5V				GND
22	GND				GND		GND
21	GND						GND
20	GND				GND		GND
19	GND		GND				GND
18	GND				GND		GND
17	GND		GND				GND
16	GND				GND		GND
15	GND		GND				GND
12..14							
11	GND		GND				GND
10	GND				GND		GND
9	GND		GND				GND
8	GND				GND		GND
7	GND		GND				GND
6	GND				GND		GND
5	GND		GND				GND
4	GND				GND		GND
3	GND		+5V				GND
2	GND				+5V		GND
1	GND	+5V				+5V	GND
Pin	F	E	D	C	B	A	Z

Figure 9-2: Assignment of X1

9.1.2 Connector X10

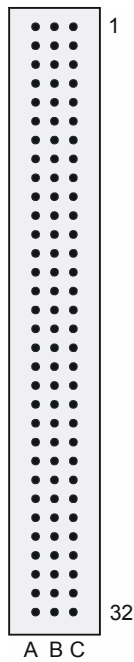

Figure 9-3: Connector X10 (view: mating side)

Table 9-1: Assignment of X10

Pin	A	B	C
1	LABA1	GND	LABA2
2	LABB1	GND	LABB2
3	LABC1	GND	LABC2
4	LABD1	GND	LABD2
5			
6	CH1_HI1	CH1_HI1	CH1_HI1
7	CH1_LO1	CH1_LO1	CH1_LO1
8	CH1_HI2	CH1_HI2	CH1_HI2
9	CH1_LO2	CH1_LO2	CH1_LO2
10	CH1_HI3	CH1_HI3	CH1_HI3
11	CH1_LO3	CH1_LO3	CH1_LO3
12	CH1_HI4	CH1_HI4	CH1_HI4
13	CH1_LO4	CH1_LO4	CH1_LO4
14	CH1_SHI1		CH1_SLO1
15	CH1_SHI2	CH1_MHI	CH1_SLO2
16	CH1_SHI3	CH1_MLO	CH1_SLO3
17	CH1_SHI4		CH1_SLO4
18	CH2_HI1	CH2_HI1	CH2_HI1
19	CH2_LO1	CH2_LO1	CH2_LO1
20	CH2_HI2	CH2_HI2	CH2_HI2
21	CH2_LO2	CH2_LO2	CH2_LO2
22	CH2_HI3	CH2_HI3	CH2_HI3
23	CH2_LO3	CH2_LO3	CH2_LO3
24	CH2_HI4	CH2_HI4	CH2_HI4
25	CH2_LO4	CH2_LO4	CH2_LO4
26	CH2_SHI1		CH2_SLO1
27	CH2_SHI2	CH2_MHI	CH2_SLO2
28	CH2_SHI3	CH2_MLO	CH2_SLO3
29	CH2_SHI4		CH2_SLO4
30			
31	XTI1	XTI2	GND
32	XTO1	XTO2	CHA_GND

The CHA_GND signal is connected with the front plate of the module and via two 10 nF capacitors with GND. The front plate itself has no direct connection to GND. When a test object is connected, the test object GND should be connected to GND. To avoid ripple loops, do not connect GND and CHA_GND.

9.1.3 Connector X20

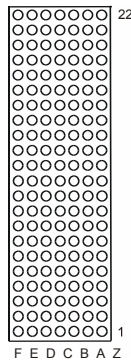

Figure 9-4: Connector X20 (view: mating side)

Pin	F	E	D	C	B	A	Z
22		GA0	GA1	GA2	GA3	GA4	
21					GA5		
20		+5V (PWA)	GND	+5V (PWA)			
19				+5V (PWA)	GND		
18		PXI_TRIG6	CAN_EN in PCA3 V4.0	PXI_TRIG5	PXI_TRIG4	PXI_TRIG3	
17		PXI_CLK10			GND	PXI_TRIG2	
16		PXI_TRIG7	GND		PXI_TRIG0	PXI_TRIG1	
15			+5V (PWA)		GND		
14							
13							
12	NP	PGND1	PACCTL_CH1	+5VRIO_CH1		+VPA_CH1	NP
11	NP						NP
10		PGND2	PACCTL_CH2	+5VRIO_CH2		+VPA_CH2	
9					+VPA_CH2	+VPA_CH2	
8		PGND1	PGND1	PGND1			
7					+VPA_CH1	+VPA_CH1	
6		PGND2	PGND2	PGND2			
5							
4							
3			RRST#		GND	RSDO	
2			RSDI			RSCLK	
1		+5V (PWA)	CAN_L	CAN_H	GND	RCS#	
Pin	F	E	D	C	B	A	Z

Figure 9-5: Assignment of X20 (NP = not populated)

9.1.4 Connector X30

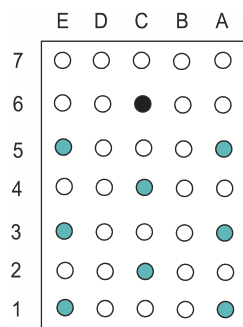

Figure 9-6: Connector X30 (mating side)

Table 9-2: X30 Pinning Schedule

Pin	E	D	C	B	A
7					
6			GND		
5	ABC1				ABA1
4			ABB1		
3	ABC2				ABB2
2			ABA2		
1	ABD2				ABD1

9.2 PSU RIO module

9.2.1 Connector X5 at PAC 100W2 (1504.4553.02)

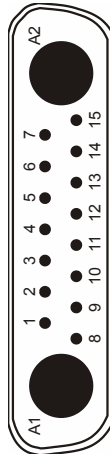

Figure 9-7: Connector X5 (view: mating side)

Table 9-3: Assignment of X5

Pin	Signal
1	PACCTRL CH2
2	8-55V CH1
3	8-55V CH2
4	COM CH1
5	COM CH2
6	Uh CH1 (voltage for 5 V Step-Down)
7	Uh CH2 (voltage for 5 V Step-Down)
8	PACCTRL CH1
9	8-55V CH1
10	8-55V CH2
11	COM CH1
12	COM CH2
13	NC
14	CTR-COM CH2
15	CTR-COM CH1

9.2.2 Connector X5 at PAC 100W2 V535 (1504.4553.03)

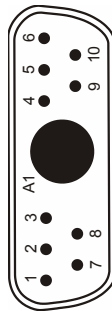

Figure 9-8: Connector X5 (view: mating side)

Table 9-4: Assignment of X5

Pin	Signal
1	PACCTRL CH1
2	COM CH1
3	PAC PWR1
4	PAC PWR2
5	COM CH2
6	PACCTRL CH2
A1	NC (key)
7	CTR-COM CH1
8	COM CH1
9	COM CH2
10	CTR-COM CH2

9.2.3 Connector X20

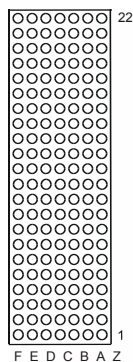

Figure 9-9: Connector X20 (view: mating side)

Pin	Z	A	B	C	D	E	F
22		GA4	GA3	GA2	GA1	GA0	
21			GA5				
20				+5V (PWA)	GND	+5V (PWA)	
19			GND	+5V (PWA)			
18		PXI_TRIG3	PXI_TRIG4	PXI_TRIG5	CAN_EN in PCA3 V4.0	PXI_TRIG6	
17		PXI_TRIG2	GND			PXI_CLK10	
16		PXI_TRIG1	PXI_TRIG0		GND	PXI_TRIG7	
15			GND		+5V (PWA)		
14							
13							
12	NP	+VPA_CH1		+5VRIO_CH1	PACCTL_CH1	PGND1	NP
11	NP						NP
10		+VPA_CH2		+5VRIO_CH2	PACCTL_CH2	PGND2	
9		+VPA_CH2	+VPA_CH2				
8				PGND1	PGND1	PGND1	
7		+VPA_CH1	+VPA_CH1				
6				PGND2	PGND2	PGND2	
5							
4							
3		RSDO	GND		RRST#		
2		RSCLK			RSDI		
1		RCS#	GND	CAN_H	CAN_L	+5V (PWA)	
Pin	Z	A	B	C	D	E	F

Figure 9-10: Assignment of X20 (NP = not populated)

9.3 PSU AC/DC converter

9.3.1 Connector X5 at PAC 100W2 (1504.4553.02)

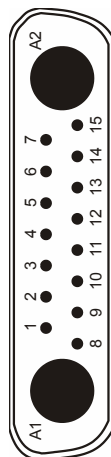

Figure 9-11: Connector X5 (view: mating side)

Table 9-5: Assignment of X5

Pin	Signal
1	PACCTRL CH2
2	8-55V CH1
3	8-55V CH2
4	COM CH1
5	COM CH2
6	Uh CH1 (voltage for 5 V Step-Down)
7	Uh CH2 (voltage for 5 V Step-Down)
8	PACCTRL CH1
9	8-55V CH1
10	8-55V CH2
11	COM CH1
12	COM CH2
13	NC
14	CTR-COM CH2
15	CTR-COM CH1

9.3.2 Connector X5 at PAC 100W2 V535 (1504.4553.03)

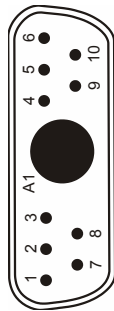

Figure 9-12: Connector X5 (view: mating side)

Table 9-6: Assignment of X5

Pin	Signal
1	PACCTRL CH1
2	COM CH1
3	PAC PWR1
4	PAC PWR2
5	COM CH2

Pin	Signal
6	PACCTRL CH2
A1	NC (key)
7	CTR-COM CH1
8	COM CH1
9	COM CH2
10	CTR-COM CH2

10 Specifications

NOTICE

The technical data of the Power Supply/Load Module R&S TS-PSU are shown in the corresponding data sheets.

In the event of any discrepancies between data in this user manual and technical data in the data sheet, the data sheet takes precedence.
