

# INSTRUCTION MANUAL

ManualsPlus.com

**B&K**

Model 1246

## DIGITAL IC COLOR GENERATOR

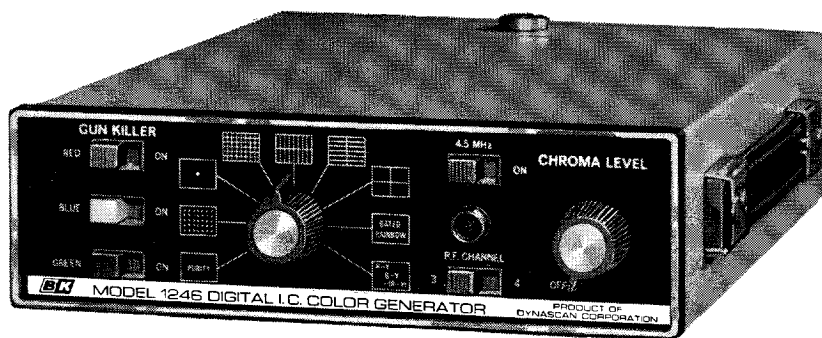

**B&K**

Product of DYNASCAN CORPORATION  
1801 West Belmont Avenue, Chicago, Illinois 60618

**INSTRUCTION MANUAL**

**FOR**

**Model 1246**

**DIGITAL IC**

**COLOR GENERATOR**

**B & K** *DIVISION OF DYNASCAN CORPORATION*

1801 West Belle Plaine Avenue

Chicago, Illinois 60613

**TABLE OF CONTENTS**

	page
INTRODUCTION .....	4
SPECIFICATIONS .....	5
OPERATING PROCEDURE .....	6
A. Controls and Functions .....	6
B. Operation .....	9
CONVERGENCE .....	11
A. Purity .....	11
B. Static .....	11
C. Dynamic .....	11
COLOR ADJUSTMENTS .....	12
A. Hue Setting and Range .....	12
B. Demodulator Alignment Check .....	13
C. Color Sync Locking .....	14
D. Color Fit .....	14
E. Color Killer .....	14
DEFLECTION SYSTEM TESTS .....	15
A. Overscan .....	15
B. Linearity, Size and Centering .....	15
THEORY OF OPERATION .....	16
CALIBRATION and MAINTENANCE .....	19
A. Dot Size .....	19
B. RF Oscillator/Modulator .....	19
C. Color Oscillator/Bar Width .....	19
D. 4.5 MHz Oscillator .....	21

## INTRODUCTION

### **B & K Model 1246 Digital IC Color Generator**

This fine quality, easy to use portable generator has been designed by B & K for quick, easy convergence and adjustment of color TV sets.

Integrated circuit (IC) flip-flops perform all counting functions; there is absolutely no way for them to “jump” a count, because they can only divide by 2. This guarantees jitter-free patterns—even with severe temperature and voltage variations. Pattern flicker is also completely eliminated because the progressive scan system presents the same signal on each field.

You can carry the 1246 from your car trunk at  $-20^{\circ}$  Fahrenheit into a home and it will operate perfectly when first turned on.

Two crystal controlled, keyed rainbow color displays are provided to test color circuits, range of hue control and align color demodulators. A chroma level control provides the ability of displaying color to any degree of saturation up to 200%.

Multiple dot and crosshatch patterns are provided for adjusting horizontal/vertical linearity, centering and size on color or black and white TV receivers. These patterns are *indispensable* when adjusting convergence on color receivers. Dot size and vertical line width is sharp and bright, due to special IC circuitry. It is preset to an optimum at the factory, but can easily be readjusted to suit personal preference.

Two crystal-controlled RF channels and a 4.5 MHz fine-tuning aid insure that the 1246 is easy to set-up and always remains exactly on frequency.

Red, blue and green gun killers provide the convenience of remotely shutting off all or any combination of CRT guns when performing certain color tests and adjustments.

Small and compact, this unit outperforms every instrument of comparable quality while consuming a minimal amount of space in a tube caddy.

## SPECIFICATIONS

### PATTERNS (9 total)

PURITY .....	Clear raster
DOTS .....	1, Center 9 x 9
CROSSHATCH .....	1 x 1 Crosshair 1 x 9 9 x 1 9 x 9
COLOR BARS .....	Gated Rainbow: 10 bars at 30° intervals from burst. R-Y, B-Y, —(R-Y): 3 bars gated at 90°, 180°, and 270° from burst.

### LINE WIDTH

HORIZONTAL .....	1 horizontal line (54 μS)
VERTICAL .....	Preset to .25 μS; internally adjustable from .1 to .8 μS

### CHROMA

Offset subcarrier system utilizing a frequency of 3.579545 MHz—1 H (15,816Hz) or 3.563729 MHz, ± .001%. 10 bars and R-Y, B-Y, —(R-Y) are produced by gating with 189 KHz and 63 KHz respectively. The subcarrier level is adjustable from 0 to 200% by front panel control adjustment.

### SIGNAL SYNTHESIS

Progressive scan system utilizing digital binary logic elements to derive all sync and video information. The countdown chain is synchronized to a crystal controlled frequency of 189.800 KHz, ± .005%.

The composite video signal approximates TV standards.

	SYNC (H=63.22μS)	FREQUENCY	PULSE WIDTH
HORIZONTAL .....		15,816 Hz	0.08 H (5.4 μS)
VERTICAL .....		59.91 Hz	4 H (253 μS)
	BLANK	TOTAL	FRONT PORCH REAR PORCH
HORIZONTAL ....	0.145 H (9.2 μS)		0.06 H (3.8 μS)
VERTICAL .....	16 H (1012 μS)	.. 4 H (253 μS)	.. 8 H (506 μS)

### RF OUTPUT

CHANNELS .....Crystal Controlled on 3 (61.25 MHz) and 4 (67.25 MHz) ± .005%. Selectable by front panel slide switch.

LEVEL .....10,000  $\mu$ Volts typical into a 300 $\Omega$  load.

TUNING AID .....4.5 MHz unmodulated carrier  $\pm .2\%$ . Fixed injection level of 30% of total modulation excursion.

## POWER REQUIREMENTS

100 to 130 Volts AC, 50/60 Hz.

Internal power supply is transformer isolated, full-wave rectified and transistor-zener regulated to provide a constant and ripple-free supply voltage.

## OPERATING RANGE

From  $-20^{\circ}$  F to  $+140^{\circ}$  F with no performance degradation.

## MECHANICAL

SIZE .....2.25" x 7" x 10.375"

WEIGHT .....3.5 lbs.

CABLE STORAGE ..... 30 cubic inches

## ADDITIONAL

Red, blue and green front panel gun killer switches with 4 ft. cable.

## OPERATING PROCEDURE

The 1246 has 2 controls and 5 slide switches, all located on the front panel.

### A. CONTROLS AND FUNCTIONS (Refer to Fig. 1)

1. **CHROMA LEVEL:** Rotation of this control adjusts the color sub-carrier amplitude from 0 to 200%; at midpoint (indicator vertical), the level is normal or 100% of sync amplitude. In the extreme counter-clockwise position, AC power to the unit is switched off.

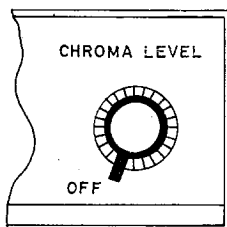

AC OFF

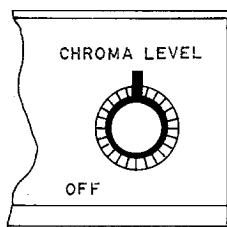

100%

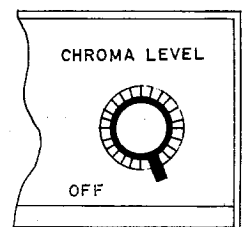

200%

2. **PATTERN SELECTOR:** Nine patterns are programmed into the 1246 for expediency of convergence and color alignment. In sequence:

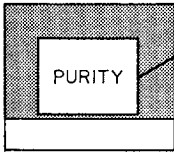

The first position provides sync and an ultra-clean “reference black” level to produce a clear, blemish-free raster. Accuracy and speed of purity adjustments are greatly enhanced through its use.

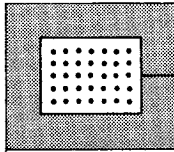

9 x 9 sharp and well defined dots are produced for use in the static convergence operation. Dot width is preset to  $.25\mu S$  but may be readjusted internally to suit personal preference. (See CALIBRATION section).

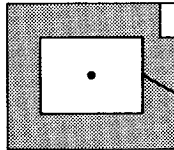

A single center dot derived from the previous pattern eliminates visual “hunting” and marking of the screen in order to verify its location.

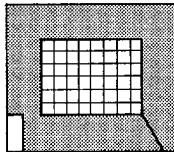

The 9 x 9 CROSSHATCH is extremely useful in dynamic convergence, linearity, size and overscan adjustments. The sharp definition of the vertical and horizontal lines helps to insure precision in convergence.

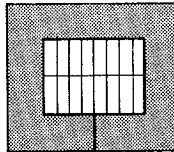

The single horizontal line with full vertical lines pattern is especially useful when performing dynamic convergence at screen center on left and right sides.

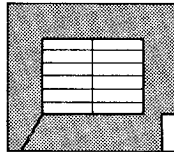

The single vertical line with full horizontal lines pattern is useful when performing dynamic convergence at screen center on top and bottom.

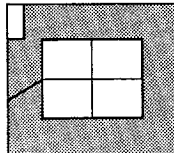

The crosshair is derived from the full crosshatch. Intersection of the two lines corresponds to exact screen center if the receiver is properly adjusted. This pattern is useful for “roughing in” static convergence.

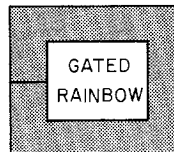

10 color bars raised on a 50% luminance pedestal and gated at  $30^\circ$  intervals are produced for testing and aligning color circuitry. The “reference black” background gives sharp edge definition and aids in recognizing color spill.

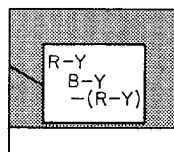

3 color bars derived from the rainbow and gated at  $90^\circ$ ,  $180^\circ$  and  $270^\circ$  respectively, allow the operator to rapidly expedite certain color alignment procedures.

3. **RF SWITCHES and OUTPUTS:** The 1246 delivers 10,000  $\mu$ Volts of well-modulated RF into a 300 $\Omega$  load. Because the units actual output impedance is 50 $\Omega$ , there is never a need to use matching networks between the generator and receiver, except when driving loads considerably less than this value.

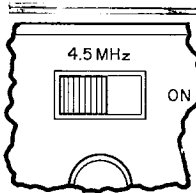

The RF CHANNEL slide switch electronically selects one of two crystal controlled RF carrier frequencies on channel 3 (61.25 MHz) or 4 (67.25 MHz). Simply move the switch to the desired channel.

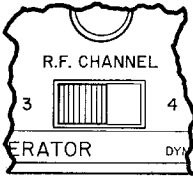

The 4.5 MHz switch energizes an oscillator which inserts a 4.5 MHz subcarrier onto the composite video and blanks the bars in the two color positions to provide an ungated rainbow. A 936 KHz "Herringbone" pattern (4.5 MHz - 3.56 MHz) will appear on the screen to aid in accurately fine-tuning the receiver.

4. **GUN KILLERS:** Three slide switches labelled RED, BLUE, and GREEN, appear on the left-hand side of the front panel.

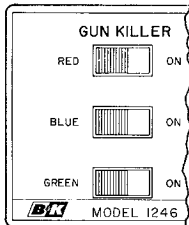

In the ON position (CRT gun off), each switch shorts a respectively color-coded alligator clip through a 100K ohm resistor to the black common lead of the killer cable. Since the resistors are nearest the clip leads, isolation of the instrument is insured and capacitive loading of the CRT grid is kept to a minimum.

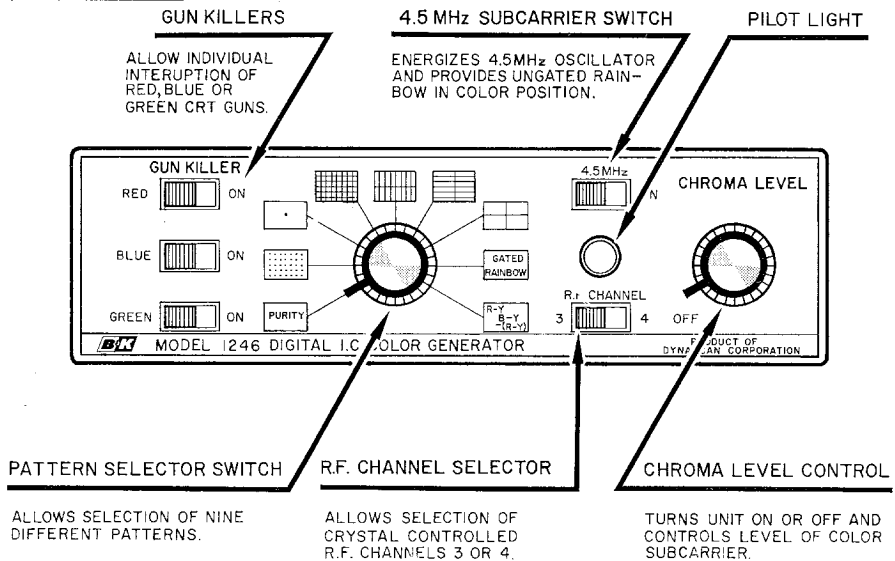

Figure 1.

## B. OPERATION

NOTE: Read this entire section carefully to avoid unnecessary confusion and obtain maximum performance from the 1246.

1. Disconnect all antenna lines from the receiver VHF antenna terminals; attach the 1246 RF cable to these terminals.
2. Tune both the receiver and generator to either channel 3 or 4.
3. Turn the instrument on by rotating the CHROMA LEVEL control clockwise.
4. Rotate the pattern selector to GATED RAINBOW and set the CHROMA LEVEL control to its midpoint position (indicator vertical); advance the receiver color level control approximately  $\frac{1}{4}$  from minimum. Adjust the contrast and brightness to provide a comfortable viewing intensity.
5. Slide the 4.5 MHz switch to the ON position. All bars will disappear.
6. Rotate the receiver fine-tuning until an ungated rainbow with a light herringbone pattern appears; this is due to a beat between the sound and color subcarriers. Adjust the fine-tuning once again for *color with minimum herringbone*. At this point, the receiver IF sound trap has attenuated the 4.5 MHz, and the receiver is properly tuned. Switch off the 4.5 MHz.

NOTE: With certain models, it may be impossible to either locate or tune out the herringbone. This may be due to a poorly aligned sound trap. An alternate method of fine-tuning is presented if this occurs.

### ALTERNATE METHOD OF FINE TUNING:

1. Set the pattern selector to crosshatch, switch off the 4.5 MHz and fine-tune the receiver until a reasonably good display is obtained.
2. Reduce the contrast and brightness controls until both the horizontal and vertical lines are barely visible; one may be brighter than the other, but *both* should be visible.
3. Carefully readjust the fine-tuning for brightest *vertical* lines, then reset the contrast and brightness for a comfortable viewing intensity.

NOTE: The 1246 possesses a high percentage of RF modulation. To obtain the sharpest test pattern and avoid "blooming" of the TV screen display, never operate the receiver with excessive contrast and brightness during convergence or color adjustments.

4. Rotate the pattern selector to **GATED RAINBOW** and set the **CHROMA LEVEL** control to its midpoint position.
5. Advance the receiver color level control until color appears. When color does not appear at all or only with the control near maximum, carefully readjust the fine-tuning. It should only require a slight amount of rotation; excessive rotation indicates tuner or IF misalignment. If this last step fails to produce color, it is likely that a malfunction exists somewhere in the receiver and must be corrected before proceeding.

When the receiver is properly tuned, it is then ready for convergence and color adjustments.

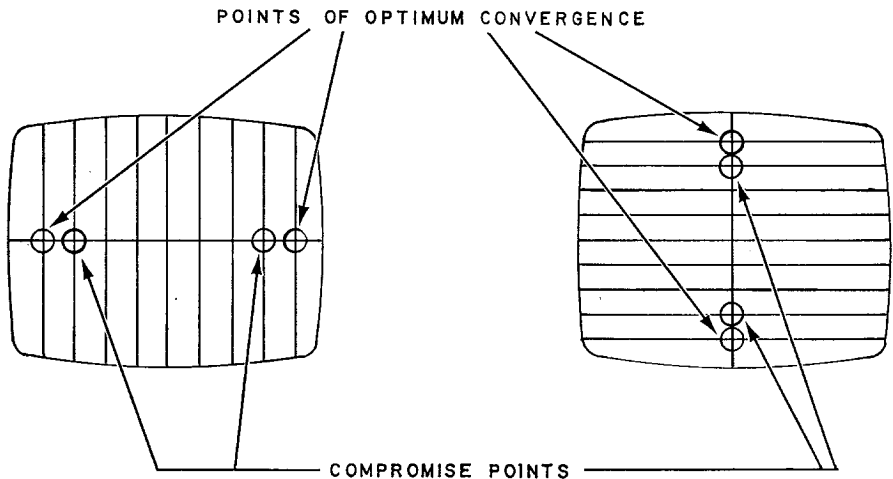

Figure 2.

## CONVERGENCE

A detailed convergence procedure will not be presented here, as there are many excellent and thorough manuals available on this subject; however, extensive field testing results of pattern uses have been compiled and are presented to help speed convergence.

### A. PURITY

The first position of the 1243 selector provides sync and a reference baseline free of video information. This is advantageous when adjusting purity. Older methods required turning to an unused channel or disabling the tuner; "snow" produced by this method can be annoying and cause inaccuracy in set-up. Using this position, the operator can be assured that the adjusted purity condition will be maintained when the convergence procedure is initiated.

### B. STATIC CONVERGENCE

Static, or DC convergence is always performed before and after purity adjustments. The 1246 pattern switch is programmed to provide the necessary dot patterns in the positions following purity. The single center dot pattern is most convenient because it automatically pinpoints screen center and is quickly located when working from behind the receiver, viewing the screen at an angle.

In many instances, it is easier to "rough-in" static convergence with the crosshair pattern. However, for final touch-up, always use the center dot.

### C. DYNAMIC CONVERGENCE

Crosshatch is the recommended pattern for performing dynamic convergence; some servicemen use dots throughout the entire procedure—this is a matter of personal preference. However, misconvergence is most easily seen with horizontal and vertical lines.

The single horizontal with full vertical lines pattern (see Fig. 2) is especially useful when performing dynamic convergence on left and right sides (at center vertically). Elimination of all but the center horizontal line removes any confusion as to the correct points to converge. On a typical receiver, the vertical lines closest to the screens left and right edges would be the optimum choice; difficult convergence problems can be compromised by using the 2nd closest lines.

The single vertical line with full horizontal lines pattern is useful when performing convergence on top and bottom (at horizontal center). Elimination of all but the center vertical lines again removes confusion as to the correct convergence points. On a typical receiver, the horizontal lines closest to the screens top and bottom edges are optimum choice; the 2nd

lines would be the compromised condition. As a final convergence verification, always refer to the full crosshatch pattern.

NOTE: Defocusing, blooming and “kinks” at crosshatch intersections indicate that brightness and contrast are excessive. It is important never to perform convergence in this condition, or accuracy will greatly suffer.

## COLOR ADJUSTMENTS

Service notes should always be consulted when testing and aligning color circuitry. Following the recommended procedure will insure best performance. The next sections refer to a general technique if manufacturer’s data is not available.

### A. HUE SETTING AND RANGE

Step 1. Rotate the 1246 pattern selector to GATED RAINBOW and set the CHROMA LEVEL control to its mid-point position.

Step 2. Adjust the receiver’s saturation, brightness and contrast controls to produce a pleasing color pattern. Ten individual color bars should be visible on the face of the screen (See Fig. 3).

NOTE: Some receivers may only display eight or nine bars; this is due to excessive overscan and/or blanking.

Step 3. Turn the 1246 selector to R-Y, B-Y, —(R-Y). Three color bars, representing the third, sixth and ninth bar out of the gated rainbow should now be visible.

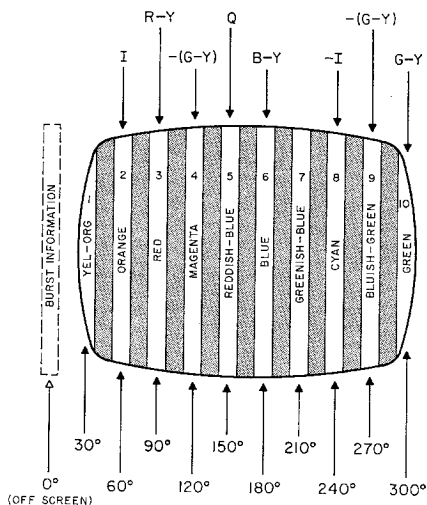

Figure 3. Gated Rainbow

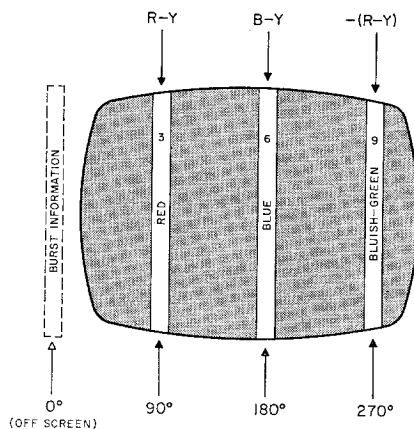

Figure 4. R-Y, B-Y, —(R-Y)

Step 4. Adjust the receiver's hue control to display a red, blue and bluish green bar in this order from left to right (See Fig. 4). If this arrangement cannot be obtained with any setting of the hue control, then internal adjustment of the hue range coil is necessary.

It can be assumed that the color circuits in the receiver are operating properly if these steps produce the correct results.

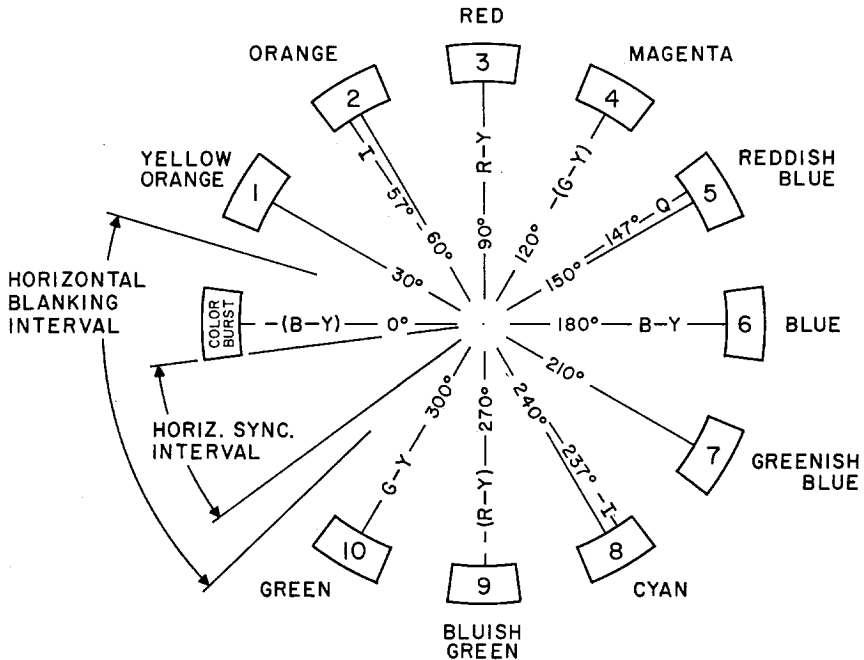

Figure 5. Gated Rainbow Phase Relation

## B. DEMODULATOR ALIGNMENT CHECK

A rapid check of demodulator alignment can be performed without the use of a vectorscope right in the customer's home. This technique is simple and utilizes the color CRT itself as the analysis instrument.

- Step 1. Rotate the 1246 selector to R-Y, B-Y,  $-(R-Y)$  and set the CHROMA LEVEL control to its mid-point position.
- Step 2. Turn the receiver's contrast control to minimum and adjust the brightness for the brightest display possible without blooming; the saturation control should be set to a very low level—just enough to produce color.
- Step 3. Disable the red and green guns of the CRT. Adjust the hue control so that color and shading to the area left and right of the first bar (left hand side of screen) matches the center section of that bar.

- Step 4. Disable the blue and green guns and leave only the red gun active. If the color demodulators are properly aligned, the bar in the center of the screen will match the color and shading of the area to either side of it. A large amount of error usually indicates the need for demodulator alignment.

## **C. COLOR SYNC LOCKING**

The CHROMA LEVEL control on the 1246 varies the amplitude of the color sub-carrier from 0 to 200%. Utilization of this control can help determine if the set will adequately lock on a color signal.

- Step 1. Rotate the 1246 selector to GATED RAINBOW and adjust the CHROMA LEVEL control to its mid-point position; this represents normal color subcarrier amplitude.
- Step 2. Adjust the receiver color control to produce a recognizable color pattern.
- Step 3. Slowly rotate the 1246 CHROMA LEVEL control counterclockwise until the colors become pale and finally disappear—the rate of fading will depend entirely upon the model under test. Most receivers will maintain color sync throughout the entire range of the level control; however, some sets may lose it just before the color disappears, evidenced by their diagonal running. Both of these conditions indicate normal operation of the sync circuits. If a slight reduction of the chroma amplitude from normal causes the color to fall out of lock, synchronization of the receiver may be inadequate.

In the full clockwise position of the CHROMA LEVEL control, the amplitude of the sub-carrier is 200% of sync amplitude. This additional range is helpful in diagnosing receiver conditions, such as RF/IF misalignment or chroma circuit malfunction.

## **D. COLOR FIT**

The 1246 produces color bars that are raised on a luminance pedestal so that spaces between the colors are reference black. When displaying 10 and 3 bar patterns, colors should only be seen in the luminance area; incorrect delay in the video amplifier or incorrect alignment of the band-pass amplifier will cause the colors to overlap or spill into the black region.

## **E. COLOR KILLER**

Color killer threshold can be set while displaying CROSSHATCH; adjust the color killer control of the receiver until the vertical lines start to tear with color. Back this control off until the tear is removed, then give a slight turn more to provide a safety margin.

## DEFLECTION SYSTEM TESTS

A rapid check of receiver scanning can help disclose any abnormal or border-line situations which might exist in the electrical or mechanical components of the deflection system. When evaluating any results from these tests, always use the manufacturer's recommendations as a criterion.

### A. OVERSCAN

1. Rotate the 1246 pattern selector to CROSSHATCH.
2. Adjust receiver contrast and brightness to display sharp, thin lines against a black background.
3. Count the number of vertical and horizontal lines. A typical receiver will display 9 vertical and 9 horizontal lines. A tenth one, however, may just be visible at the screen's edge; this one is outside the normal picture area and should be ignored when performing adjustments.

NOTE: Small-screen receivers have an inherent tendency towards a greater amount of overscan and/or blanking. This phenomenon may result in an 8 x 8 crosshatch instead of a 9 x 9. The same effect will produce a 9 color bar pattern instead of 10.

### B. LINEARITY, SIZE AND CENTERING

The repetitive spacing of the CROSSHATCH pattern provides a stable source with which to perform these tests and adjustments. Abnormal conditions such as pincushion distortion, deflection non-linearity and excessive 60 Hz hum become immediately obvious.

Vertical size and linearity should be adjusted so that all horizontal lines are evenly spaced. Inability to do so usually indicates a vertical deflection problem.

Pincushion distortion is common to a great number of large screen receivers; the outermost vertical and horizontal crosshatch lines are most useful in determining the correct amount of compensation.

A horizontal bar rolling vertically through the crosshatch pattern indicates that 60 Hz hum is entering the receiver circuitry. Excessive amounts of it cause a very noticeable and annoying pattern displacement.

The CROSSHAIR pattern provides 1 vertical and 1 horizontal line that intersect at exact screen center; any visual deviation from it may indicate a need for adjustment.

## THEORY OF OPERATION

(Refer to Figure 6)

Operation of the 1246 is easily understood if its circuits are sectionalized into a logical sequence of dependency:

1. 189 KHz MASTER OSCILLATOR
2. COUNTDOWN CHAIN
3. GATING LOGIC AND PULSE SHAPING NETWORKS
4. PATTERN SELECTOR SWITCH
5. DIGITAL TO ANALOG MIXER/CONVERTER
6. COLOR OSCILLATOR
7. 4.5 MHz OSCILLATOR
8. VHF OSCILLATOR/MODULATOR
9. POWER SUPPLY

The 189 KHz MASTER OSCILLATOR generates timing pulses used to trigger the countdown chain and certain pulse shaping networks. It is composed of IC1a and IC1b, in a high-gain saturating amplifier configuration, with a quartz crystal as the positive feedback element; the output consists of square waves with sharp falling edges.

Thirteen flip-flops comprise the bulk of active circuitry known as the COUNTDOWN CHAIN. These devices are I.C. bistable multivibrators, with an inherent frequency division capability of two. Each flip-flop contains the equivalent of 20 discrete transistors, for a total of 260 semiconductors. A digital feedback technique is used to scale by integers other than 2. This method is simple yet ultra-stable since dependency upon time constants is completely eliminated.

Predetermined output frequencies of the count chain are utilized to generate TV sync and video signals. However, further processing is required to achieve the correct shape. GATING LOGIC and PULSE SHAPING NETWORKS solve this problem by computing the required width of all signals used in reconstructing a composite video waveform. Gates G1 through G4 and G6 through G9 perform the logical "AND" function; G5 is an "OR" gate. Diodes D1 through D26 comprise this gating circuitry. Two pulse shaping networks, known as monostable multivibrators generate vertical lines/dots and color bars. Trimpots on the PC board allow their time constants to be varied. R9, labelled "bar width" is preset at the factory to insure 8 cycles of color burst information. Once adjusted, it is never touched. R5 or "dot size" is also preset to an optimum, but can be readjusted if necessary.

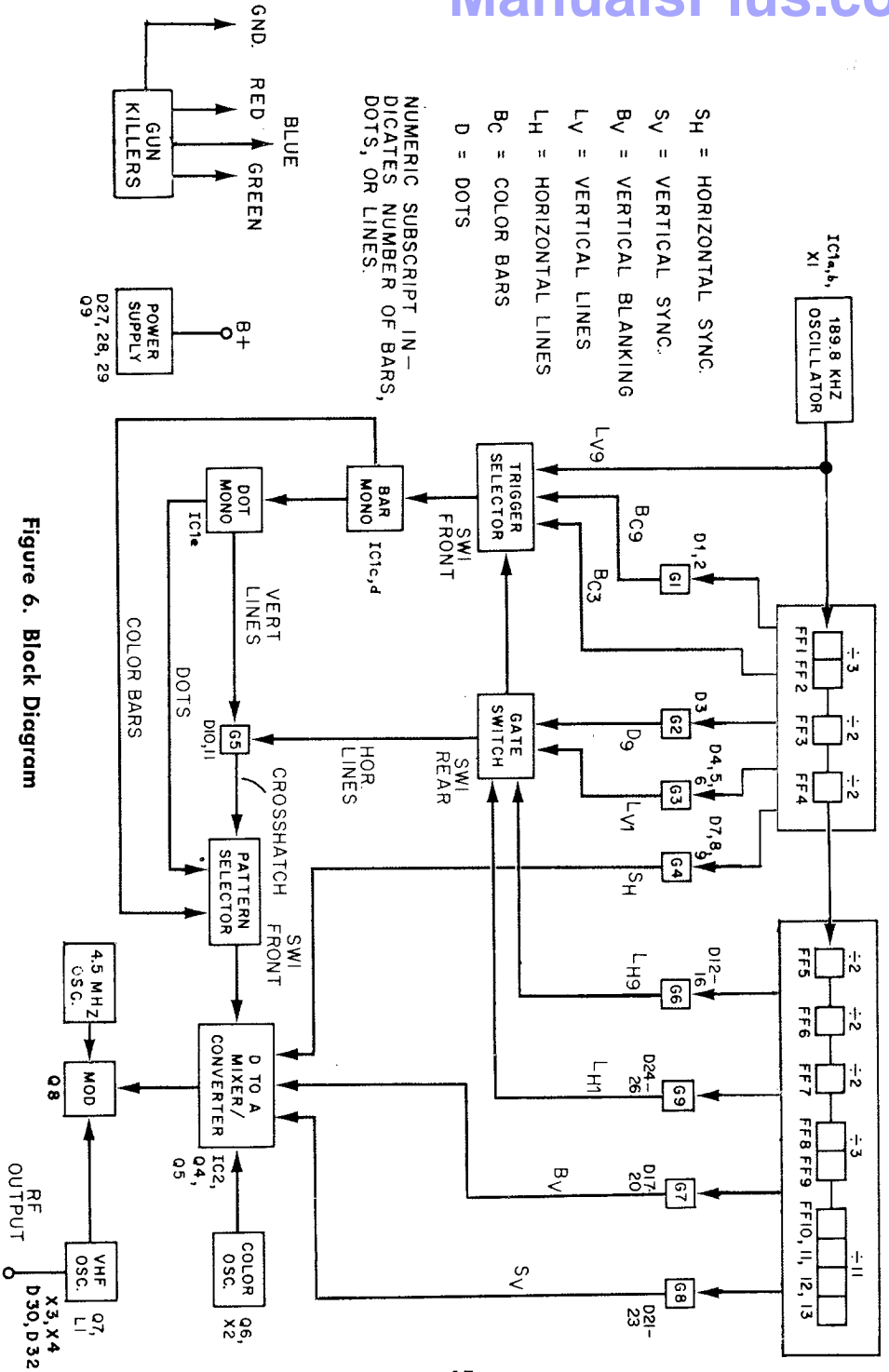

Figure 6. Block Diagram

The PATTERN SELECTOR SWITCH is a front panel rotary selector which allows the instrument to display one of nine pattern arrangements.

The preselected video, sync information and blanking pulses all converge at the DIGITAL to ANALOG MIXER/CONVERTER for reconstruction into a composite video waveform. IC2, Q4, and Q5 are the active devices used to accomplish this conversion, along with a resistive ladder consisting of R45 through R48. These resistors form a simple voltage divider string with corresponding transistor switches that short or open in a time dependent sequence. The resultant output is a series of voltage level shifts relating to sync and video information.

The COLOR OSCILLATOR is actually a sub-section of the D to A converter. Q6 and associated components form a modified crystal-Colpitts oscillator with load resistor R53 as a front panel control; the output is thus variable in amplitude from 0 to 200% of sync level. Power is applied only in the color positions to avoid interference with other patterns.

Transistor Q10 and surrounding components comprise a temperature compensated 4.5 MHz OSCILLATOR which generates the sound subcarrier used as a tuning aid. Capacitor C39 injects a level of 30% total modulation excursion into the modulator. A front panel slide switch that controls power to this circuit also blanks bar patterns to provide an ungated rainbow.

The assembled composite video is sent to the VHF OSCILLATOR/MODULATOR where it is impressed upon a desired RF frequency and routed through the output cable. Q7 and surrounding components form a crystal-controlled VHF oscillator that generates the carrier frequency. A front-panel slide switch controls DC bias to two RF switching diodes, thereby energizing the selected channel crystal. Modulator transistor Q8 is a low-capacity device connected as a diode; this scheme provides temperature compensation and a high modulation percentage. Shielded coax is driven by a 50 Ohm source impedance to drive any load down to this value. Antenna mismatch and standing waves present no problems because of the high level of well-modulated RF and low spurious leakage.

Transformer T1 reduces 117 VAC down to 10 volts for full-wave rectification in the POWER SUPPLY. Q9 is a series-pass power transistor that regulates the raw B+; it is referenced to zener diode D29. Enough unfiltered DC is provided to maintain Q9 in active conduction over a  $\pm 20\%$  line variation, resulting in only a 2% output voltage change. Large filter capacitors reduce AC ripple to a negligible value, which accounts for the clean pattern displays.

## CALIBRATION and MAINTENANCE

The 1246 is aligned and calibrated at the factory for optimum performance. As a result, access to the instrument's interior is only necessary for dot size readjustment—all other trimming controls should not *be touched*. If misalignment occurs either through damage or accidental movement, recalibration is possible by following the procedures in succeeding sections.

### A. DOT SIZE

Trimmer control R5, labeled "DOT SIZE" (see Fig. 7) varies, the width of pulses used to construct dots and vertical lines. It is preset to .25  $\mu$ S, which has been found to produce a sharp, bright dot on the majority of receivers. If readjustment is preferred, simply display a dot pattern and rotate this control until the desired size is obtained. Since vertical lines are also affected, it is wise to inspect the crosshatch pattern; a compromise between optimum dot size and vertical line width may be necessary.

### B. RF OSCILLATOR/MODULATOR

Because the RF carrier of the 1246 is crystal-controlled, it is not necessary to retune L1 when changing channels; it has purposely been damped so that Q7 will oscillate with either crystal. If operation on one channel should cease, rotate L1's slug to see if it can be restored before suspecting component failure.

It is necessary to view the detector output of a working receiver with an oscilloscope when calibrating the MODULATION ADJUST trimmer, R67.

1. Set-up the receiver and generator to display CROSSHATCH.
2. Adjust the oscilloscope to view two vertical fields of the recovered waveform.
3. Rotate R67 until the sync amplitude (upper-half) of the composite signal equals the video amplitude (lower half).

### C. COLOR OSCILLATOR/BAR WIDTH

An oscilloscope and a frequency counter with input impedance of greater than 100K $\Omega$  are needed to perform the following adjustments:

1. Rotate the 1246 selector to GATED RAINBOW and turn the unit on.
2. Attach the frequency counter input to point V (white wire from PC board to CHROMA LEVEL control) and rotate the CHROMA LEVEL control fully clockwise.

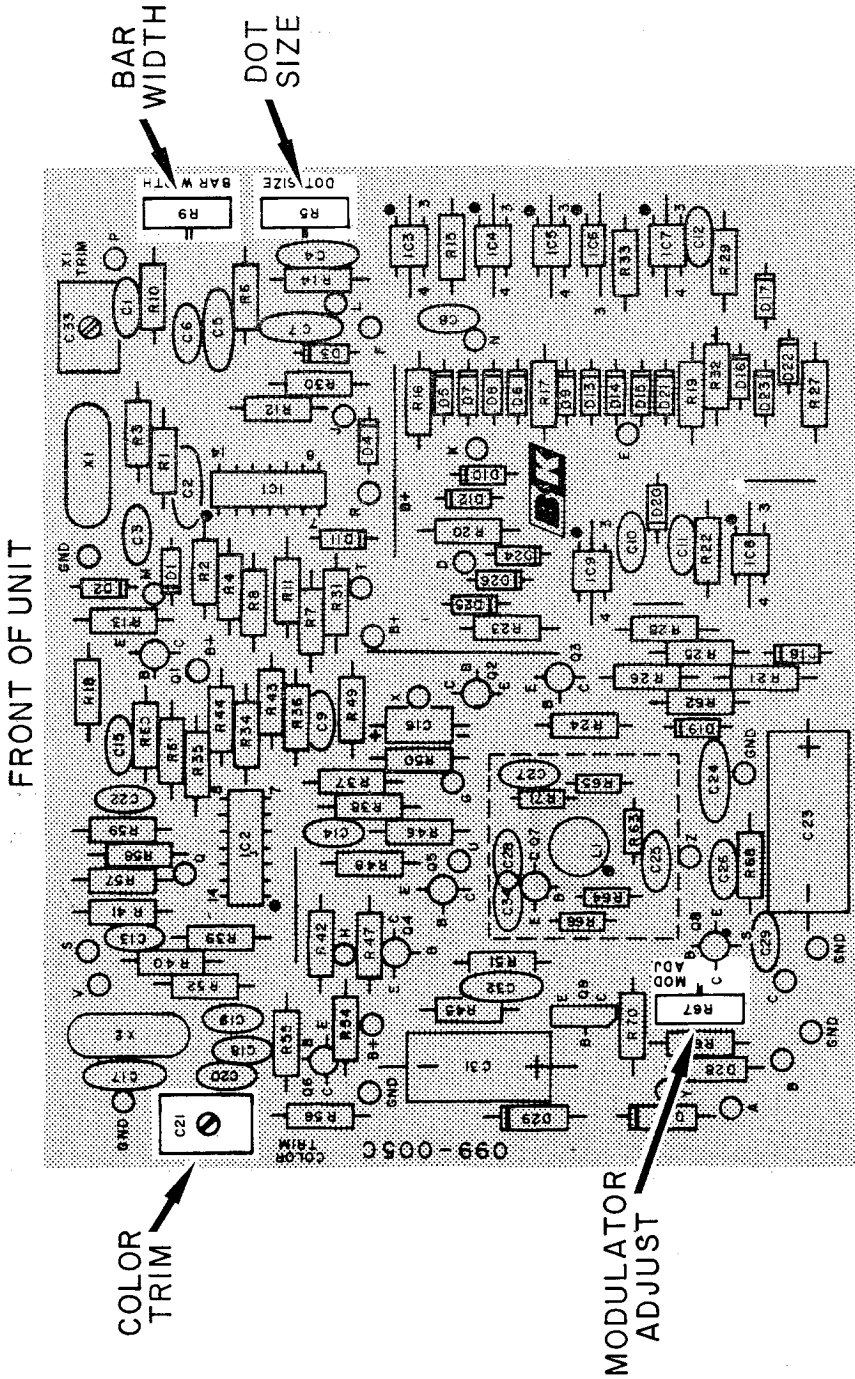

Figure 7. Location of Internal Adjustments

3. Adjust "COLOR TRIM" capacitor (C21) with a non-metallic tool until a reading of 3.563729 MHz is obtained.
4. Attach the input of the oscilloscope to point U and set the sweep to display one horizontal line. Turn the CHROMA LEVEL control on the generator to minimum.
5. Adjust "BAR WIDTH" trimmer R9 for perfectly square waves along the baseline of the displayed horizontal line.

#### D. 4.5 MHz OSCILLATOR

1. Attach the frequency counter to the emitter of Q10 on the small PC board (see Fig. 8).
2. Slide the actuator of the 4.5 MHz front panel switch to ON and adjust L2 for a reading of 4.500 MHz. Calibration is now complete.

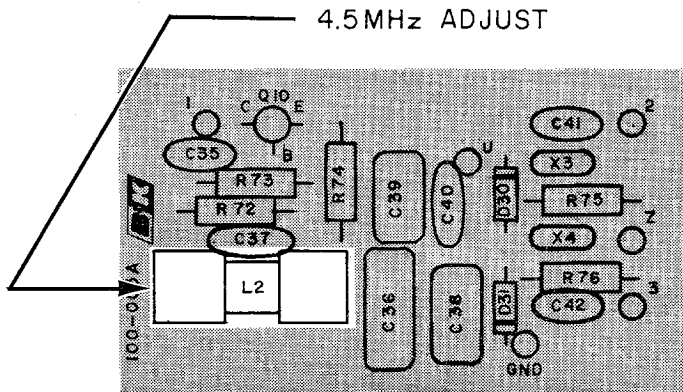

Figure 8.

## WARRANTY SERVICE INSTRUCTIONS

1. Refer to the maintenance section of the instruction manual for adjustments that may be applicable.
2. Slide the actuator of the 4.5 MHz front panel switch to ON and adjust applicable adjustments after such replacement.
3. Defective parts removed from units which are within the warranty period should be sent to the factory, prepaid, with model and serial number of product from which removed, and date of product purchase.
4. If the above mentioned procedures do not correct the difficulty, pack the product securely (preferably double packed). A detailed list of troubles encountered must be enclosed as well as your name and address. Forward prepaid (express preferred) to the nearest B & K authorized service agency.

Contact your local B & K Distributor for the name and location of your nearest service agency, or write to:

*Service Department*

B & K DIVISION OF DYNASCAN CORPORATION

1801 West Belle Plaine Avenue

Chicago, Illinois 60613



### WARRANTY

"B & K warrants that each product manufactured by it will be free from defects in material and workmanship under normal usage and service for a period of ninety days after its purchase new from an authorized B & K distributor. Our obligation under this warranty is limited to repairing, or replacing any product or component which we are satisfied does not conform with the foregoing warranty and which is returned to our factory or our authorized service contractor, transportation prepaid, and we shall not otherwise be liable for any damages, consequential or otherwise. *The foregoing warranty is exclusive and in lieu of all other warranties (including any warranty of merchantability), whether expressed or implied.* Such warranty shall not apply to any product or component (i) repaired or altered by anyone other than B & K or its authorized service contractor (except normal tube replacement) without B & K's prior written approval; (ii) tampered with or altered in any way or subjected to misuse, negligence or accident; (iii) which has the serial number altered, defaced or removed; or (iv) which has been improperly connected, installed or adjusted otherwise than in accordance with B & K's instructions. B & K reserves the right to discontinue any model at any time or change specifications or design without notice and without incurring any obligation. *The warranty shall be void and there shall be no warranty of any product or component if a B & K warranty registration card is not properly completed and postmarked to the B & K factory within five days after the purchase of the product new from an authorized B & K distributor.*"



DYNASCAN CORPORATION

1201 West Belle Plaine Avenue, Chicago, Illinois 60614