

INSTRUCTION MANUAL

ManualsPlus.com

BK PRECISION 2040

CB Signal Generator

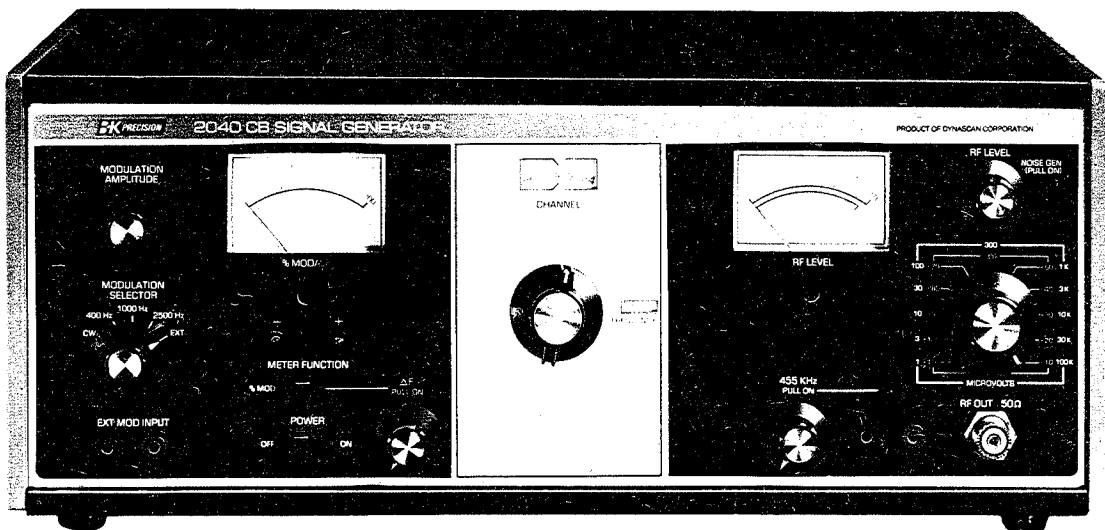

BK PRECISION

A Product of DYNASCAN CORPORATION • 6460 W. Cortland St. • Chicago, Illinois 60635

PRICE \$5.00

TABLE OF CONTENTS

| | Page |
|---|--------|
| INTRODUCTION | 4 |
| ADDITIONAL CB SERVICING DATA | 4 |
| ADDITIONAL CB TEST EQUIPMENT | 4 |
| FEATURES | 5 |
| SPECIFICATIONS | 7 |
| CONTROLS AND INDICATORS AND OPERATOR'S FACILITIES | 9 |
| OPERATING INSTRUCTIONS | |
| Warm-Up | 11 |
| Burnout Protection | 11 |
| Initial Operating Procedure | 11 |
| Ultra-Low Output Levels | 15 |
| CB PERFORMANCE TESTING | |
| Introduction | 16 |
| Test Equipment Required | 16 |
| Test Equipment Hook-Up | 16 |
| Receiver Audio Power and Frequency Response Check | 20 |
| AM Receiver Sensitivity Check | 22 |
| AM Receiver Adjacent Channel Rejection Check | 23 |
| AM Receiver Squelch Sensitivity Check | 24 |
| Receiver AGC Check | 26 |
| Receiver Audio Power and Distortion Check | 28 |
| Receiver ANL Effectiveness Check | 29 |
| Receiver Noise Blanker Effectiveness Check | 30 |
| SSB Receiver Sensitivity Check | 30 |
| SSB Receiver Adjacent Sideband Rejection Check | 31 |
| SSB Receiver Squelch Sensitivity Check | 32 |
| CB RECEIVER ADJUSTMENTS | |
| Synthesizer Frequency Check and Adjustment | 35 |
| CB Receiver Alignment | 36 |
| TROUBLESHOOTING CB TRANSCEIVERS | 37 |
| THEORY OF OPERATION | 37 |
| CALIBRATION PROCEDURE | 39 |
| WARRANTY INSTRUCTIONS | Cov. 3 |
| WARRANTY | Cov. 3 |

INTRODUCTION

The **B & K-Precision Model 2040 CB Signal Generator** is specifically designed for Citizen's Band service work; however, its accuracy and high quality also make it well suited for many laboratory applications. It is intended for testing, troubleshooting and alignment of both AM and SSB Citizen's Band transceivers. It offers all the necessary signal generation capabilities for complete transceiver testing and servicing. It generates a highly accurate and stable RF output with CW, AM or simulated SSB modulation on 50 channels in the 27 MHz CB spectrum. It also provides a separate, fully adjustable 445 kHz CW- or AM-modulated signal, and a selectable noise generator for testing ignition noise suppression circuits. Such full capabilities give you the ability to thoroughly service CB equipment without additional, external equipment. The capability to thoroughly service all types of CB sets should heighten your professionalism in the CB servicing business.

The CB Signal Generator offers many time-saving features such as channel selector switch instead of tuning dial, and internal modulation of 400 Hz, 1000 Hz, and 2500 Hz. These time-saving features will make your CB servicing business more profitable.

The instrument uses the latest design technology. This design not only meets today's needs, but is adaptable to any probable changes required in future CB servicing, such as allocation of more or different frequencies, or assigning channels at 5 kHz intervals.

ADDITIONAL CB SERVICING DATA

One of the finest "guide to CB servicing" handbooks available today is our instruction manual for the **B & K-Precision Model 1040 CB ServiceMaster** (cost, \$5.00). In addition to its information on the Model 1040, it contains an entire section on **HOW TO TROUBLESHOOT CB TRANSCEIVERS**. Even if you're servicing without the aid of a 1040, the instruction manual contains valuable information for technicians just entering the CB servicing field. The information is presented in the practical, highly illustrated, "plain talk" style that is characteristic of all **B & K-Precision** instruction manuals. The handbook covers complete CB performance testing, diagnostic checks, and troubleshooting procedures by symptom. The combined information in this Model 2040 CB Signal Generator instruction manual and the Model 1040 CB ServiceMaster instruction manual, should provide most technicians all the "how-to" data needed to get started in CB servicing.

If your local **B & K-Precision** dealer does not stock the model 1040 instruction manual, order directly from the factory, using the address from the cover of this manual.

ADDITIONAL CB TEST EQUIPMENT

A complete CB service bench consists of the following five items of test equipment or their equivalents. **B & K-Precision** offers a complete line of test equipment including items excellently suited (or specifically designed) for CB servicing.

1. **B & K-Precision Model 2040 CB Signal Generator.**
2. **B & K-Precision Model 1040 CB ServiceMaster.** We highly recommend the use of the CB ServiceMaster because it combines the functions of many test instruments into a single instrument and contains many features for more thorough, simpler and faster testing than is possible with separate instruments. Only two connections are required from the CB ServiceMaster to the transceiver, and these connections do not require changing throughout all performance tests. Connections between the CB ServiceMaster and other test equipment never need changing. If a CB ServiceMaster is *not* used, the following items are required: (Also, connections must be continuously changed to various configurations, depending upon the test being conducted.)
 - 50-ohm dummy load, 5 watts or greater capacity.
 - RF wattmeter, peak and average power reading, 15 watts peak and 5 watts average capacity or greater, forward and reverse reading.
 - VSWR meter.
 - Audio dummy loads of 4 ohms, 8 ohms, and 16 ohms, 5 watts or greater capacity.
 - Audio wattmeter calibrated to read output in watts and dB across 4-ohm, 8-ohm, and 16-ohm load. Should have ranges of 0.1, 1 and 10 watts full scale.
 - Audio distortion meter.
 - 1000 Hz audio generator.
 - Two-tone audio generator for modulating SSB transmitter.
3. **B & K-Precision Model 1801 Digital Frequency Counter** or equivalent. Counter should have upper frequency limit of at least 27 MHz and display accuracy within 100 Hz.
4. **B & K-Precision Model 1403A Oscilloscope** or equivalent. Only 2 MHz bandwidth is required if the CB ServiceMaster is used, but the oscilloscope must be usable to 27 MHz for observing transmitter signals and modulation directly if the CB ServiceMaster is not used.
5. **B & K-Precision Model 1640 Regulated Power Supply** or equivalent. The power supply provides DC power to mobile CB transceivers while on the service bench, and should provide an accurate, well-regulated output of 13.8 volts DC with transmitter keyed or unkeyed. Current capability of 2.5 amps is adequate for most transceivers, but a 3-amp capacity leaves a more comfortable margin.

FEATURES

CB SERVICE-ORIENTED

Specifically designed for servicing Citizen's Band radios. Major considerations included in its design were reliability, the ability to generate all the signals necessary for complete servicing of all CB transceivers, speed and simplicity of operation, and high standards of accuracy.

ADVANCED TECHNOLOGY

Uses many of the latest state-of-the-art circuit developments. Heart of the frequency generation system is a programmable crystal-controlled phase-locked loop (PLL) with a capacity of 50 channels. Fully solid state construction throughout, including solid state LED indicators. Only two filament devices used: light bulbs for illumination of the two front panel meters. All advantages of solid state circuitry are realized: reliability, dependability, long life, low heat, light weight, small size and low power consumption.

ONLY SIGNAL GENERATOR NEEDED

Produces every type and level of RF and IF signal normally needed for servicing all AM and SSB CB transceivers. Performs all signal generator functions without additional equipment for all receiver checks such as receiver sensitivity, both AM and SSB, adjacent channel rejection (selectivity), opposite sideband rejection, squelch threshold and tight squelch sensitivity, AGC characteristic, audio frequency response, audio distortion, noise limiter effectiveness and noise blanker effectiveness.

HUMAN ENGINEERING

All controls and indicators designed for quick, easy, accurate operation. Controls and indicators for related functions are logically grouped, and located for a natural sequence of operation. Controls are labeled for fast recognition to save time and prevent incorrect operation. All meters and controls are direct reading, so no time is wasted and no mistakes are made because of calculations or conversions.

FAST FREQUENCY SELECTION

Channel selector switch provides much faster frequency selection than continuously tunable type signal generator. Simply select

desired CB channel number and forget it. Signal generator is set to the correct frequency more accurately than is possible with most continuously tunable type signal generators.

50 CHANNELS

Channel selector provides 50 channels, to cover the entire 27 MHz Class D Citizen's Band spectrum. Includes all 23 presently authorized CB channels plus the frequencies proposed for CB channels 24 thru 40. Also covers all unassigned channels at 10 kHz increments between assigned channels (for measuring adjacent channel rejection on all assigned channels).

5 PPM ACCURACY

Phase-locked loop uses single high-stability crystal-controlled reference oscillator with temperature-regulated crystal oven for ultra-stable RF output. Frequency and stability maintained within ± 5 parts per million ($\pm 0.0005\%$) on all 50 channels.

CALIBRATED OUTPUT LEVEL

Calibrated output level adjustable over a wide range to accommodate virtually any CB servicing situation. Precision RF attenuator adjusts output level from $1 \mu\text{V}$ to 100 mV in 10 dB steps. Vernier adjustment and meter permit accurate setting to any intermediate level, and as low as $0.3 \mu\text{V}$. Even lower levels can be accurately obtained, if required, using an external 50-ohm, 20 dB pad.

DOUBLE SHIELDED

All 27 MHz generating circuitry is double-shielded, in addition to the cabinet, which prevent any random radiation from disturbing test results at low RF output levels.

BURNOUT PROTECTION

RF output circuitry is capable of dissipating 5 watts RF at 27 MHz for a short period, which will protect the RF attenuator from damage if a CB transmitter is accidentally keyed while the signal generator is connected to the antenna jack of the transceiver.

CW AND AM MODULATION

Both internal and external AM modulation continuously adjustable from 0 to 100%. Percentage of modulation is metered from 0 to 100%.

**400 Hz, 1000 Hz, OR
2500 Hz INTERNAL
MODULATION**

Selectable internal modulation of 400 Hz, 1000 Hz or 2500 Hz provides audio signal at low, center and high end of audio frequency response, permits audio frequency response check without additional equipment.

**SINUSOIDAL PURITY
OF INTERNAL
MODULATION**

Internal modulation signal source has low distortion and may be used as modulating signal for distortion check.

**EXTERNAL
MODULATION**

External modulation capability. Sufficient audio gain to permit use of a gain type CB microphone for modulating the signal generator.

 **Δ F MODE FOR SSB
SERVICING**

Selectable, calibrated vernier frequency adjustment allows output frequency to be offset from indicated channel frequency by 0 to 5 kHz to simulate a single tone upper or lower sideband signal. Δ F mode available on all 50 channels. All modes of modulation available in the Δ F mode. Magnitude of frequency offset accurately displayed on meter. LED indicators show when Δ F mode is on and whether frequency offset is simulating upper or lower sideband signal.

455 kHz OUTPUT

Continuously adjustable level 455 kHz output available for injection into IF section of CB transceivers. This output independent from RF output and can be used separately or simultaneously with RF output. All modes of modulation available for 455 kHz output. Internal modulation level fixed at approximately 30%. On-off selection of 455 kHz output mode from the front panel, and LED indicator lights when circuit is on.

**NOISE GENERATOR
OUTPUT**

Includes built-in standard EIA noise test signal source. Permits testing and servicing of automatic noise limiter (ANL) and noise blanker circuits. On-off selection of noise generator circuit mode from the front panel. Noise signal is routed to transceiver being tested through RF output jack, along with any RF output signal being generated.

**ADAPTABLE TO MEET
FUTURE NEEDS**

This instrument will not become obsolete in the near future. It already covers the frequencies proposed for CB channels 24 thru 40. The instrument can be field-modified to operate on any 50 channels in the 27 MHz spectrum at channel spacings of 5 kHz or 10 kHz, should the FCC authorize frequencies different from those presently under consideration. The number of channels can be expanded to over 100 channels, if necessary, by replacing only the channel selector switch assembly.

**DESIGN
APPLICATIONS**

The versatility and high standards of accuracy make the Model 2040 ideal for CB radio designers in engineering laboratories.

**MANUFACTURING
APPLICATIONS**

The versatility, accuracy, and speed of operation of the 2040 CB Signal Generator are appropriate to fulfill the requirements for testing and calibrating CB radios in manufacturing or re-conditioning facilities.

**TECHNICAL SCHOOL
APPLICATIONS**

This is the ideal signal generator for any course of instruction which includes CB transceiver technology. This instruction manual can serve as the laboratory textbook for many experiments.

**COMPANION TO
B & K-PRECISION
"CB ServiceMaster"**

The B & K-Precision Model 1040 CB ServiceMaster also is designed specifically for CB servicing. It offers numerous features that provide simpler, faster yet more complete CB servicing. The Model 2040 CB Signal Generator has the time-saving features that will do most to complement and enhance the time-saving features of the CB ServiceMaster. Together, these two instruments can make your CB radio servicing more professional and more profitable than with any other combination of CB test equipment available.

SPECIFICATIONS

CB OUTPUT SIGNALS

| | |
|-----------------------------|--|
| RF Output | CW or amplitude-modulated (AM mode). Simulated SSB modulation (ΔF mode). |
| Intermediate Frequency (IF) | 455 kHz output. Can be used independently of RF output. |

FREQUENCY BAND

| | |
|-------------------|--|
| AM and ΔF | Entire 27 MHz Class D Citizen's Band spectrum. |
| IF | 455 kHz. |

FREQUENCY GENERATION SYSTEM

| | |
|------------|--|
| AM | Programmable, crystal-controlled phase-locked loop (PLL) with capacity of 50 channels at consecutive channel spacings of 10 kHz. |
| ΔF | PLL with calibrated vernier permits 0 to ± 5 kHz frequency offset (ΔF). |
| IF | 455 kHz crystal-controlled oscillator. |

CHANNELS

50-channel selector switch. Covers all 23 CB channels presently authorized and all 40 channels under consideration by the FCC, plus all unassigned 10 kHz increments between assigned channels.

ADAPTABILITY TO MEET FUTURE NEEDS

PLL can be reprogrammed to operate on any 50 channels in 27 MHz spectrum at channel spacings of 5 kHz or 10 kHz if FCC should authorize channels different from those presently proposed.

Expansion to over 100 channels possible by replacement of channel selector switch assembly.

FREQUENCY ACCURACY

| | |
|------------|--|
| AM | Within ± 5 ppm ($\pm 0.0005\%$) after 15-minute warm-up, 0° to 50°C . |
| ΔF | Stability within ± 5 ppm after 15-minute warm-up, 0° to 50°C . Frequency offset within $\pm 5\%$ of indicated reading, $\pm 3\%$ F.S. |
| IF | $\pm 0.1\%$, 0° to 50°C . |

OUTPUT LEVEL

| | |
|-------------------|--|
| AM and ΔF | RF attenuator provides 11 steps of output level from -10 to -110 dBm (calibrated for 50-ohm termination) in 10 dB steps. Vernier control provides continuous adjustment from +3 dB above to -10 dB below level selected by RF attenuator. Output level also calibrated in microvolts from 1 μV to 100K μV (100mV) Vernier adjustable down to less than .1 μV . Output level accuracy, $\pm 5\%$ of reading when terminated into 50 ohms, $\pm 3\%$ F.S. |
| IF | Continuously variable uncalibrated output level. |

OUTPUT LEVEL METERING

| | |
|-------------------|--|
| AM and ΔF | Front panel meter calibrated in microvolts and dB. |
| IF | Not metered. |

OUTPUT CONNECTORS

| | |
|---------------------------|---|
| RF Output | UHF (SO-239 type mates with standard PL-259 type CB antenna cable connector). |
| 455 kHz Output | Dual banana jacks. |
| External Modulation Input | Dual banana jacks. |

OUTPUT IMPEDANCE

| | |
|----------------|---------------------|
| RF Output | 50 ohms. |
| 455 kHz Output | Less than 250 ohms. |

MODULATION MODES

| | |
|------------|--|
| AM and IF | CW, external AM, and selectable 400 Hz, 1000 Hz, or 2500 HZ internal AM. |
| ΔF | Simulated single tone SSB modulation of 0 to ± 5 kHz by using selectable calibrated vernier frequency offset (ΔF) function. In addition, all modulation modes of AM operation apply. |

MODULATION AMPLITUDE

| | |
|-------------------|--|
| AM and ΔF | Continuously adjustable from 0 to 100% for internal and external modulation. |
| IF | Fixed 30%, $\pm 10\%$ modulation for internal modulation. External modulation percentage adjustable by varying level of external modulating input. |

MODULATION METERING

| | |
|-------------------|---|
| AM and ΔF | Percentage of modulation monitored on % MOD scale of front panel meter for internal and external modulation. Meter reads 0 to 100% modulation at an accuracy of $\pm 5\%$ of reading, $\pm 3\%$ F.S. Magnitude of frequency offset from selected channel frequency monitored on ΔF scale of front panel meter 0 to ± 5 kHz offset accurate within $\pm 5\%$ of reading, $\pm 3\%$ F.S. |
| IF | Not metered. |

EXTERNAL MODULATION

| | |
|-----------|---|
| Bandwidth | 100 Hz to 10 kHz. |
| Amplitude | Minimum of 1V P-P external input required to produce 100% modulation. Sufficient audio gain in signal generator to permit AM modulation with CB gain microphone. |

NOISE GENERATOR

| | |
|------------------------|---------------------------------|
| Signal Characteristics | Standard EIA noise test signal. |
| Pulse Width | 1 microsecond. |
| Rise/Fall Time | Less than 10 nanoseconds. |
| Repetition Rate | 100 PPS. |

| | |
|---------------------------|---|
| Output Impedance | 50 ohms. |
| Amplitude | Fixed output level of 0.5 V $\pm 10\%$ when terminated into 50 ohms. |
| On-Off Control | Selectable by front panel control. Output at RF OUT jack, superimposed on selected RF output that may be present. |
| BURNOUT PROTECTION | RF attenuator will dissipate 5 watts at 27 MHz for 1 minute without damage. |
| POWER REQUIREMENTS | 105-130 VAC, 60 Hz, 20 watts. |
| SIZE (WDH) | 45.42 cm x 27 cm x 18.42 cm (17.88" x 10.63" x 7.25"). |
| WEIGHT: | 7.82 kg (17¼ lbs.) |

CONTROLS AND INDICATORS AND OPERATOR'S FACILITIES

(Refer to Fig. 1 and 2)

1. **MODULATION AMPLITUDE Control.** Adjusts percentage of modulation for RF output signal (modulation of 455 kHz output signal is fixed at approximately 30%).
2. **% MOD/ Δ F Meter.** Top scale reads percentage of modulation for RF output signal. Bottom scale reads amount of frequency offset from the selected channel frequency for Δ F mode.
3. **Zero Adjust for Meter (2).**
4. **CHANNEL Indicator.** Displays the CB channel number of the RF output.
5. **RF LEVEL Meter.** Provides fine reading of RF output level in microvolts and dBm.
6. **Zero Adjust for Meter (5).**
7. **RF LEVEL/NOISE GEN Control.** Rotation is vernier adjustment of RF output level. Pull control to turn on noise generator; noise generator level is not adjustable.
8. **RF Attenuator.** Selection of RF output level in 10 dB steps from -10 dBm to -110 dBm. Steps are also calibrated in microvolts from 100K down to 1 microvolt.
9. **RF OUT 50 Ω Jack.** RF output jack, 50 ohms impedance.
10. **455 kHz Indicator.** Lights when 455 kHz generator is on.
11. **455 kHz Output Jacks.**
12. **455 kHz Control.** Pull to turn on crystal-controlled 455 kHz generator. Rotation adjusts output level; level is not metered.
13. **FREQUENCY Indicator.** Displays selected channel frequency of RF output signal in MHz.
14. **CHANNEL Selector.** Selects CB channel (frequency) of RF output (selects reference frequency when Δ F is on).
15. **Δ F Control.** Pull to select Δ F RF output, which is tunable \pm 5 kHz above and below the selected channel frequency. Rotation of control provides vernier adjustment of Δ F of output frequency.
16. **(-) Green and (+) Amber Indicators.** The green (-) indicator lights when Δ F is below the selected channel frequency, displayed on frequency indicator (13). Amber (+) indicator lights when Δ F is above the selected channel frequency. One of the indicators is always lighted when Δ F is on. When either indicator flashes on and off, Δ F is tuned almost precisely to the selected channel frequency.
17. **POWER Switch.** Turns signal generator ON and OFF. Meters (2) and (5) are illuminated when power is on.
18. **EXT MOD INPUT Jacks.** Input jacks for external modulation.
19. **METER FUNCTION Switch.** Selects function of meter (2). % MOD position connects meter to read percentage of modulation. Δ F position connects meter to read amount of frequency offset from selected channel frequency.

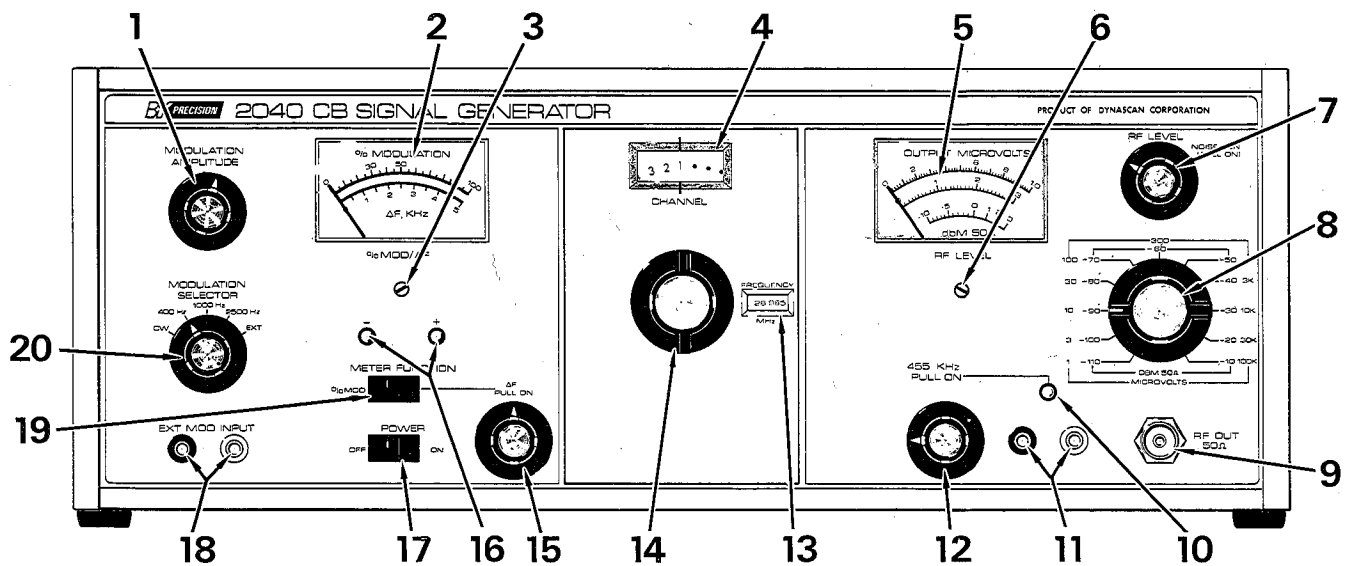

Fig. 1. Controls and indicators and operator's facilities, front panel.

20. **MODULATION SELECTOR Switch.** Selects type of modulation for RF output (in both AM and ΔF modes) and 455 kHz output.
CW: Unmodulated carrier wave.
400 Hz: 400 Hz amplitude modulation.
1000 Hz: 1000 Hz amplitude modulation.
2500 Hz: 2500 Hz amplitude modulation.
EXT: External amplitude modulation by signal applied to EXT MOD INPUT Jacks (18).

21. **Fuse.**
22. **AC Power Cord.** Connects to 120-volt, 60-Hz AC outlet.

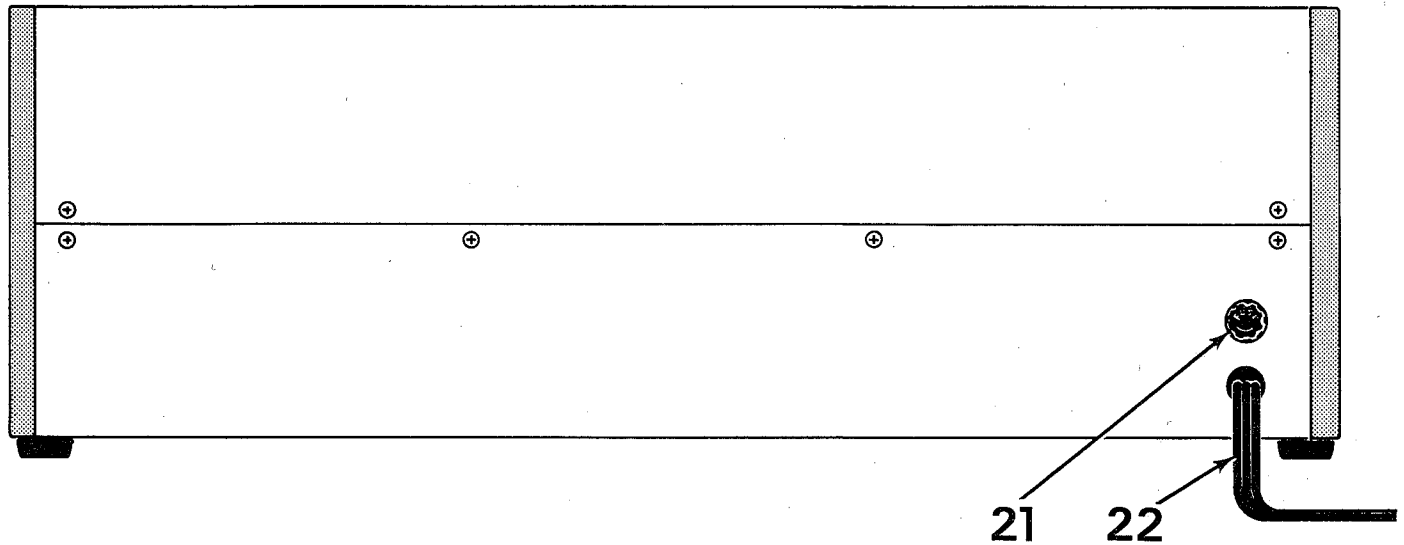

Fig. 2. Controls and indicators and operator's facilities, rear panel.

NOTES

OPERATING INSTRUCTIONS

WARM-UP

Normally, no warm-up time is required before using the 2040 CB Signal Generator. However, if the unit has been disconnected from a 120-volt AC outlet, or power to the AC outlet has been interrupted for any reason, a 15-minute warm-up period is required to reach maximum frequency accuracy and stability of $\pm 0.0005\%$.

The high stability is achieved by using a temperature-regulated crystal heater which requires 15 minutes for complete warm-up and stabilization. The crystal heater circuit becomes active as soon as 120-volt AC power is applied, even when the POWER switch on the CB Signal Generator is turned OFF. Therefore, the instrument may be turned off when not in use, but the crystal heater remains on so that no warm-up time is required when you are again ready to use the signal generator.

If you wish to avoid the warm-up period each morning, we recommend against the practice of nightly shutdown of all AC power to the service bench where the CB Signal Generator is connected. A suitable alternative may be to connect the CB Signal Generator to a separate AC outlet that is not shut down with the service bench.

Many troubleshooting and testing procedures not requiring ultra-stable and accurate frequencies may be conducted without waiting for the warm-up period. Of course, procedures such as receiver alignment, synthesizer checks and adjustment, and receiver sensitivity measurements require a very accurate signal source and should be performed *only* after the full 15-minute warm-up period.

BURNOUT PROTECTION

A CB transmitter should never be keyed when the antenna jack is connected to a signal generator. However, the CB Signal Generator has adequate burnout protection to prevent damage if the transmitter is accidentally keyed for a brief period (less than one minute), and if the Transmitter output is within the FCC legal limit of 4 watts. One method of preventing accidental keying of the transmitter is to remove the microphone while the CB Signal Generator is connected to the transceiver. The ideal answer is to use the B & K-Precision Model 1040 CB ServiceMaster in conjunction with the CB Signal Generator. The CB ServiceMaster *automatically* disconnects the signal generator as soon as it detects any transmitted energy. This is only one of the numerous servicing advantages of using the CB ServiceMaster.

INITIAL OPERATING PROCEDURE

To familiarize yourself with the operating controls and use of the instrument, feed the output of the signal generator into a Citizen's Band transceiver in known good operating condition and perform the following exercises. To demonstrate the full capabilities of the signal generator, the CB transceiver must have both AM and SSB capability and should have both ANL (automatic noise limiter) and noise blanker features. Use a CB base station or a mobile CB unit powered from a bench power supply at 13.8 volts DC.

Refer to Fig. 3 for typical connections and set-up. The numbers in parentheses in the following procedures refer to the controls and indicators as identified in Fig. 1 and 2.

Before applying power to the signal generator, set controls of the CB Signal Generator as listed in steps 1 through 6.

1. POWER switch (17) to OFF.
2. Noise generator off; push in the RF LEVEL/NOISE GEN control (7).
3. 455 kHz generator off; push in 455 kHz control (12).
4. ΔF mode off; push in ΔF control (15).
5. METER FUNCTION switch (19) to % MOD position.
6. MODULATION SELECTOR switch (20) to CW position.
7. Connect AC power cord (22) to a 120-volt, 60-Hz AC outlet.

WARNING

To guard against the danger of electrical shock, always connect to a 3-wire AC outlet. This grounds the case of the signal generator.

8. Set POWER switch (17) to ON. Meters (2) and (5) will be illuminated. Allow the instrument to warm-up for 15 minutes if desired.
9. Connect a 50-ohm coaxial cable from the RF OUT 50 Ω jack (9) of the signal generator to the antenna jack of the transceiver.
10. Turn off transceiver.
11. Connect a DC power cable from the DC power connector of the transceiver to the bench power supply. Observe correct polarity.
12. Set the power supply for 13.8 volts output.
Set controls on the transceiver as follows:
 13. CB-PA switch to CB.
 14. AM-USB-LSB switch to AM.
 15. Squelch control fully unsquelched (fully counter-clockwise).
 16. If transceiver is equipped with adjustable RF gain, set it at maximum.
 17. Set all accessory mode switches to OFF, such as ANL, noise blanker, etc.
 18. Set channel selector to channel 11.
 19. Turn on the transceiver and adjust the volume control so that the speaker background noise is at a convenient listening level.
 20. Set the channel selector (14) of the signal generator to the same channel as the transceiver, channel 11. Note

STARTING CONTROL SETTINGS

CB SIGNAL GENERATOR

1. POWER – OFF
2. NOISE GEN – OFF
3. 455 kHz – OFF
4. ΔF – OFF
5. METER FUNCTION – % MOD
6. MODULATION SELECTOR – CW
7. CONNECT AC POWER
8. POWER – ON, WARM UP
9. CONNECT COAXIAL CABLE

CB TRANSCEIVER

10. POWER – OFF
11. CONNECT POWER CABLE
12. SET POWER SUPPLY FOR 13.8V
13. MODE – CB
14. MODE – AM
15. UNSQUELCHED
16. RF GAIN – MAX. (IF ADJUSTABLE)
17. ACCESSORIES – OFF (IF SO EQUIPPED)
18. CHANNEL 11
19. POWER – ON, ADJUST VOLUME FOR NOISE FROM SPEAKER

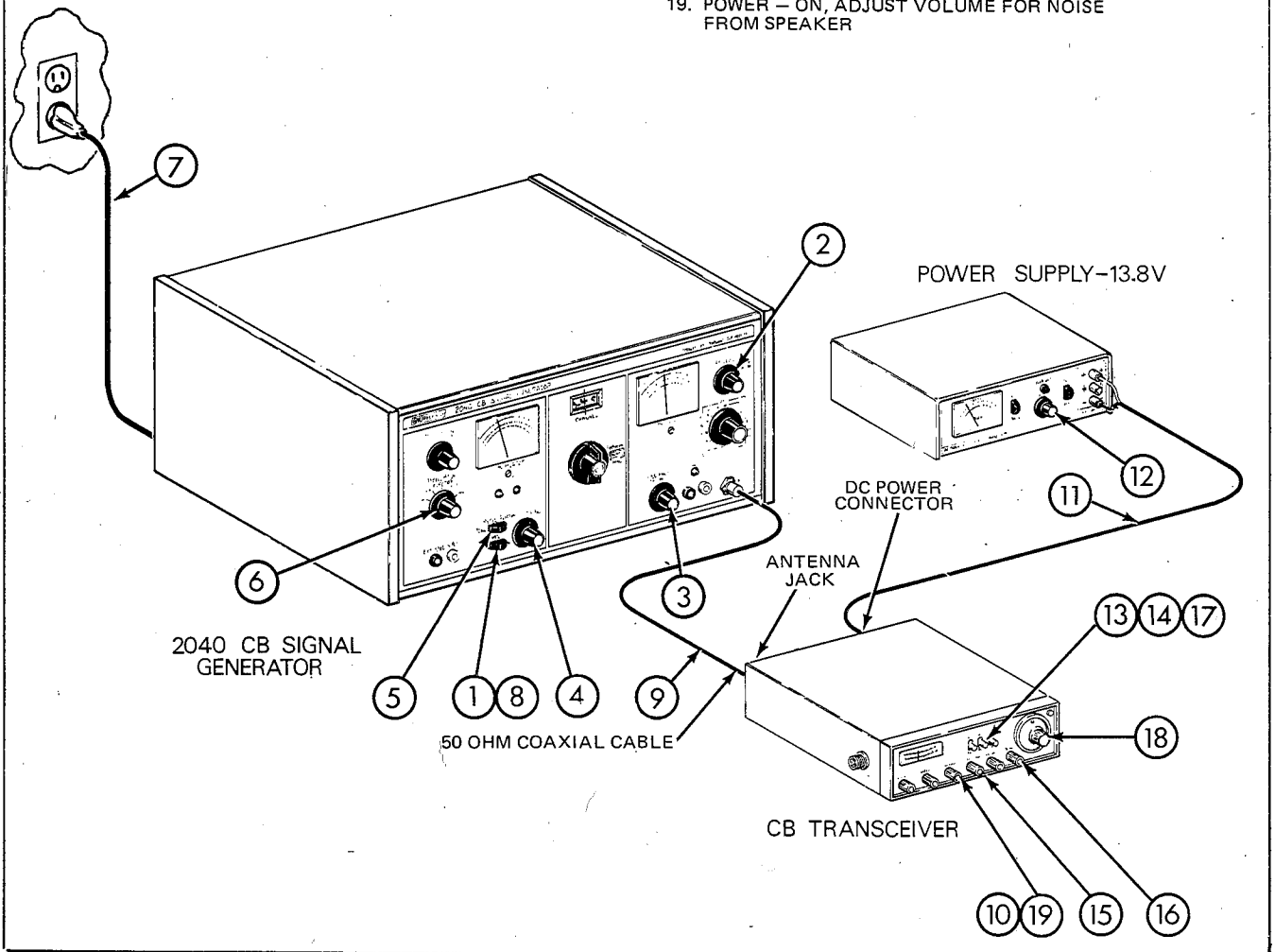

Fig. 3. Connections and set-up for initial operating procedure.

that, unlike conventional signal generators, the signal generator does not have to be carefully tuned to the desired channel frequency. Simply set the channel selector to the desired CB channel; the accurate, stable output of the signal generator is exactly on frequency.

21. Set the RF attenuator (8) to the 1K position and adjust RF LEVEL control (7) for a full-scale reading of 1 on the top scale of RF LEVEL meter (5). This adjusts the signal generator for a 1000 microvolt RF output.
22. Set the MODULATION SELECTOR control (20) to the 1000 Hz position and adjust MODULATION AMPLITUDE control (1) for a reading of 30% on the top scale of % MOD/ Δ F meter (2). A 1000 Hz tone should now be heard in the speaker of the transceiver. Readjust the transceiver volume setting, if desired, for a comfortable listening level.
23. Setting modulation controls.
 - a. Set the MODULATION SELECTOR control (20), in turn, to the 400 Hz, 1000 Hz and 2500 Hz positions.
 - b. For each position, vary the MODULATION AMPLITUDE control (1) from minimum to maximum and note that the meter (2) reading varies from 0 to 100%.
 - c. Note the effect upon sound intensity from the speaker of the transceiver.
 - d. Note that no meter (2) reading is obtained, although modulation continues, when METER FUNCTION switch (19) is set to Δ F.
 - e. Note that no meter (2) reading is obtained and no modulation occurs when MODULATION SELECTOR (20) is placed in the CW position.
24. External modulation.
 - a. Connect an audio signal generator or any other convenient audio signal to the EXT MOD INPUT jacks (18) of the CB Signal Generator. If you have a **B & K-Precision** CB ServiceMaster, use the 1000 Hz and 2-tone audio outputs as the audio signal source.
 - b. Set MODULATION SELECTOR (20) to the EXT position.
 - c. Note that the percentage of modulation as read on meter (2) can be adjusted by MODULATION AMPLITUDE control (1) or by adjusting the level of the external audio signal.
 - d. If a tunable audio signal generator is being used for external modulation, adjust for 30% modulation and tune across the entire audio spectrum from 100 Hz to 10 khz. Note by listening at the speaker of the transceiver that it is most responsive across the approximate 300 to 3000 Hz range.
25. Return the MODULATION SELECTOR (20) to the 1000 Hz position and adjust MODULATION AMPLITUDE control (1) for 30% modulation as read on

meter (2). This is a common setting specified in many CB receiver tests.

26. Adjusting the RF output level.

The following exercises may be performed to familiarize yourself with the use of RF level controls. Use the top (0 to 1) scale of RF LEVEL meter (5) in conjunction with RF attenuator (8) settings of 1, 10, 100, 1K, etc. Use the 0 to 3 meter scale in conjunction with RF attenuator settings of 3, 30, 300, 3K, etc. Use the dBm meter scale for all RF attenuator settings when interested in RF levels express in dB.

- a. Set the RF output level to 500 microvolts.
 - (1) Since the desired level of 500 microvolts is between the coarse settings of 300 to 1K on RF attenuator (8), select the 1K setting.
 - (2) Adjust RF LEVEL control (7) for a reading of .5 on the 0 to 1 microvolt scale of RF LEVEL meter (5).
 - (3) If the transceiver is equipped with an S meter, a fairly high S meter reading should be obtained.
- b. Adjust the RF output level to 2 microvolts.
 - (1) Set RF attenuator (8) to 3 microvolts.
 - (2) Adjust RF LEVEL control for meter reading of 2 on the 0 to 3 microvolt scale.
 - (3) The transceiver audio level will become very low and it may be necessary to increase RF gain and volume controls to hear the 1000 Hz tone from the speaker.
 - (4) If the transceiver is equipped with an S meter, a very low S meter reading will be observed.
- c. With an initial RF level setting of 3 microvolts, increase the output level by 45 dB.
 - (1) Set RF attenuator to 3 microvolts.
 - (2) Adjust RF LEVEL control for full scale meter reading of 3 on 0 to 3 microvolt scale.
 - (3) Note setting of RF attenuator in dBm, which is -110 dBm.
 - (4) Note meter reading in dBm, which is +3 dBm.
 - (5) Add the meter reading (+3 dBm) to the RF attenuator reading (-110 dBm) for the initial RF output level in dBm (-107 dBm). Note that the algebraic sum of +3 and -110 is -107.
 - (6) If we wish to increase the output level by 45 dB, the final desired RF output level is: -107 dBm +45 dB = -62 dBm.
 - (7) Set RF attenuator to -60 dBm position.

(8) Adjust RF LEVEL control for meter reading of -2 on dBm scale. RF output level is now -62 dBm.

27. Using the noise generator.

- a. Set the channel selector (14) so that it is on a different channel from the transceiver.
- b. Turn on noise generator by pulling RF LEVEL/NOISE GEN control (7) outward.
- c. Note noise in speaker of transceiver.
- d. If transceiver is equipped with noise blanker feature, turn on the noise blanker and note reduction in amount of noise in the speaker.
- e. Turn off noise generator by pushing in RF LEVEL/NOISE GEN control (7).

28. Using the ΔF RF output.

The primary use of the ΔF RF output is for testing SSB transceivers. The ΔF RF output frequency is precision tunable above and below the frequency selected by channel selector (14).

- a. Set the signal generator channel selector (14) to channel 11.
- b. Set the transceiver to channel 11 and select USB mode.
- c. Set transceiver RF gain, if so equipped, to maximum.
- d. Set MODULATION SELECTOR (20) to CW.
- e. Set RF output level to 3 microvolts.
- f. Place METER FUNCTION switch (19) in ΔF position.
- g. Pull ΔF control (15) outwards.
- h. Rotate ΔF control (15) so amber (+) indicator (16) lights and meter (2) reads 1 kHz on ΔF (bottom) scale.
- i. A 1000 Hz tone should be heard from the speaker of transceiver and a low S meter reading should be obtained.
- j. Note that the frequency of the audio heard in the speaker varies as the ΔF control (15) is rotated.
- k. Select LSB mode on transceiver.
- l. Rotate ΔF control (15) so that the green (-) indicator (16) lights and meter (2) reads 1 kHz on the ΔF scale.
- m. Note that as the ΔF control (15) is rotated clockwise that the meter (2) reading decreases to zero, the green indicator goes off and the amber indicator goes on, and the meter reading increases from zero.

n. Adjust the ΔF control so that the meter (2) reading is at zero and either the green or amber indicator flashes on and off. At this setting, the ΔF RF output is almost precisely the same as the frequency indicated in FREQUENCY window (13).

o. Turn off the ΔF mode by pushing in ΔF control (15) and note that both the green and amber indicators (16) are off.

29. Using the 455 kHz output.

The 455 kHz output is used to inject a signal directly into the IF portion of a CB transceiver for troubleshooting and alignment.

- a. Disconnect the coaxial cable from the RF OUT 50 Ω jack (9) and the antenna jack of the transceiver.
- b. Select AM mode of operation for the transceiver.
- c. Remove the housing from the transceiver and locate the IF portion.
- d. Connect a shielded cable terminated in a banana plug to the 455 kHz jacks (11).
- e. Loosely couple the 455 kHz signal into the IF portion of the transceiver by placing the probe near an IF coil, or inject the signal directly into any desired circuit point in the transceiver's IF circuit.
- f. Set the MODULATION SELECTOR (20) to 1000 Hz.
- g. Turn on the 455 kHz generator by pulling outward on the 455 kHz control (12). The red 455 kHz indicator (10) should light.
- h. Adjust the 455 kHz output level by rotating the 455 kHz control (12). Listen for a 1000 Hz tone in the speaker and look for an S meter indication. Adjust to the desired level, such as 5 units on the S meter.
- i. Set MODULATION SELECTOR (20), in turn, to 400 Hz and 2500 Hz. Note the change in the speaker of the transceiver. Notice that rotation of the MODULATION AMPLITUDE control (1) has no effect.
- j. Set MODULATION SELECTOR (20) to EXT and connect an audio signal generator (or other suitable audio signal) into the EXT MOD INPUT jacks (18). Notice that the amount of modulation can be controlled by adjusting the amplitude of the external audio signal source but that adjustment of the MODULATION AMPLITUDE control (1) has no effect.

All the controls and indicators have now been used, and you should now be ready to start using the CB Signal Generator for testing and troubleshooting CB transceivers.

ULTRA-LOW OUTPUT LEVELS

The CB Signal Generator provides calibrated RF output levels down to 0.1 microvolt, but occasionally, lower signal levels are required. The most convenient method of obtaining accurate ultra-low RF output levels is to connect a 50-ohm, 20 dB pad in series with the RF output as shown in Fig. 4. The pad should offer an accurate attenuation of 20 dB and it should be purely resistive at 27 MHz. The advantage of a 20 dB attenuation rather than some other value is for simplicity in reading the output level. An attenuation of 20 dB equals a voltage ratio of 10:1; thus, .3 microvolt out of the signal generator equals .03 microvolt out of the 20 dB pad; .1 microvolt out of the signal generator equals .01 microvolt out of the 20 dB pad, etc. Of course, the output level in dBm is -20 dB below the

reading on the signal generator. For example, a -100 dBm level out of the signal generator will be -120 dBm out of the 20 dB pad.

Most commercially available 20 dB pads are equipped with BNC type connectors. Therefore, BNC to UHF adapter cables are required to interconnect the pad between the signal generator and CB transceiver. Refer to Fig. 4 for typical interconnections, including identification of connector types for the adapter cables.

The 20 dB pad must be capable of dissipating 5 watts for a brief period to protect it from burnout if the transmitter is accidentally keyed while connected for ultra-low output levels.

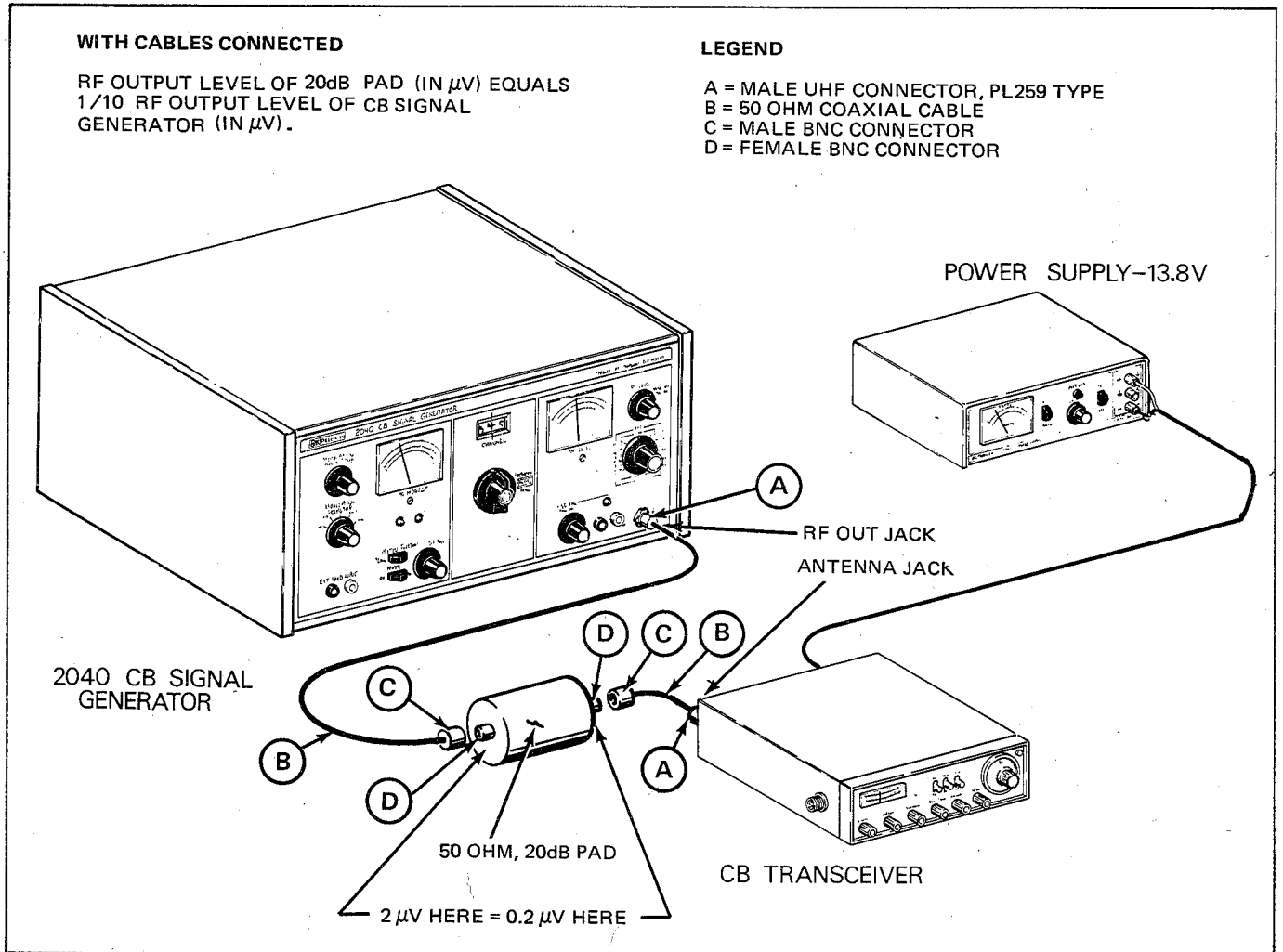

Fig. 4. Typical set-up for ultra-low output levels.

CB PERFORMANCE TESTING

INTRODUCTION

The first step of troubleshooting normally begins with performance testing, which verifies the symptom and localizes the fault. Virtually every AM and SSB receiver performance test requires the use of the CB Signal Generator. The following paragraphs fully describe the procedures for all performance tests in which the CB Signal Generator is normally used.

TEST EQUIPMENT REQUIRED

In addition to the CB Signal Generator, several other pieces of test equipment are required for CB transceiver performance testing. Fig. 5 shows the typical test equipment required for complete CB receiver performance testing. Fig. 6 shows how the test equipment requirements are simplified if the B & K-Precision Model 1040 CB ServiceMaster is used.

1. Power Supply

The power supply provides 13.8 volts DC for mobile transceivers on the service bench. It must supply a well-regulated voltage and be capable of at least 2½ amperes output.

2. Audio Load

The audio load can be as simple as a resistor network which matches the speaker impedance of the transceiver being tested. Since transceiver speaker impedances are usually 4, 8, or 16 ohms, audio loads of all three resistances are needed. They should be capable of dissipating at least 5 watts. A single unit that may be switched to 4 ohms, 8 ohms or 16 ohms is more convenient.

A cable from the audio load normally terminates in a plug that inserts into the external speaker jack of most CB transceivers. Inserting the plug disconnects the internal speaker and applies all speaker signals to the audio load where they are readily accessible for measurement. Terminating the speaker output into a resistive audio load instead of the internal speaker also relieves the technician from listening to the tones required for testing, some of which are at uncomfortably loud volume.

Since additional test equipment is normally connected across the audio load as shown in Fig. 5, several sets of test jacks in parallel with the audio load are very convenient.

The B & K-Precision Model 1040 CB ServiceMaster, shown in Fig. 6, includes a 4-8-16 ohm switchable audio load capable of 10 watts dissipation.

3. Audio Wattmeter (or Audio Voltmeter)

For the most simplified operation, an audio wattmeter calibrated to read audio power from about .1 to 10 watts across 4 ohms, 8 ohms, or 16 ohms audio load, and with scales to read both watts and dB, is desired. The B & K-Precision Model 1040 CB ServiceMaster includes such an audio wattmeter. However, if the CB Servicemaster is not used, audio wattmeters are not commonly available. An audio voltmeter may be used

and its readings converted to watts from the following charts. The audio voltmeter should be equipped with a dB scale for convenience in making sensitivity checks; however, do not use the meter reading as an indication of audio level in dBm. Most audio voltmeters are calibrated to read dBm across 600 ohms impedance.

4. Distortion Meter

A distortion meter, capable of reading harmonic distortion of a 1000 Hz test signal is required for distortion measurements. The CB ServiceMaster includes a distortion meter.

5. Oscilloscope

Although an oscilloscope is not absolutely essential for receiver performance testing, it aids in the evaluation of many tests by making a vivid, visual presentation. It is especially useful when making distortion measurements to observe the waveform.

For receiver checks, only audio frequency signals are observed on the oscilloscope, but the oscilloscope should have sufficient bandwidth for transmitter modulation measurement.

6. Isolation Amplifier and Monitor Speaker

This item is not absolutely essential, but is a valuable and desirable receiver testing aid. When the audio load disconnects the internal speaker, all test results must be read on meters or the oscilloscope. An audible test result is also very handy if its volume can be controlled to a comfortable listening level. The isolation amplifier and monitor speaker provide this capability.

The isolation amplifier may be any audio amplifier with an input impedance of 500 ohms or greater (so that it does not affect the audio load) and adjustable volume.

The CB ServiceMaster includes an isolation amplifier and monitor speaker.

TEST EQUIPMENT HOOK-UP

The illustrations which accompany each test procedure show the absolute minimum of test equipment that can be used to adequately perform the measurement. However, Fig. 5 and 6 show the basic test equipment hook-up recommended for all performance tests. If either of these hook-ups is used, no changes of test equipment connections are needed throughout all the tests. Also, to test the next transceiver, only the connections directly to the transceiver need to be changed.

In addition to the test equipment connections, Fig. 5 and 6 show the initial control settings for the CB Signal Generator and the transceiver. We recommend the settings shown as the standard configuration to which the controls should be returned after each test. All testing instructions in this manual assume that the controls have been placed in this standard configuration at the start of each procedure.

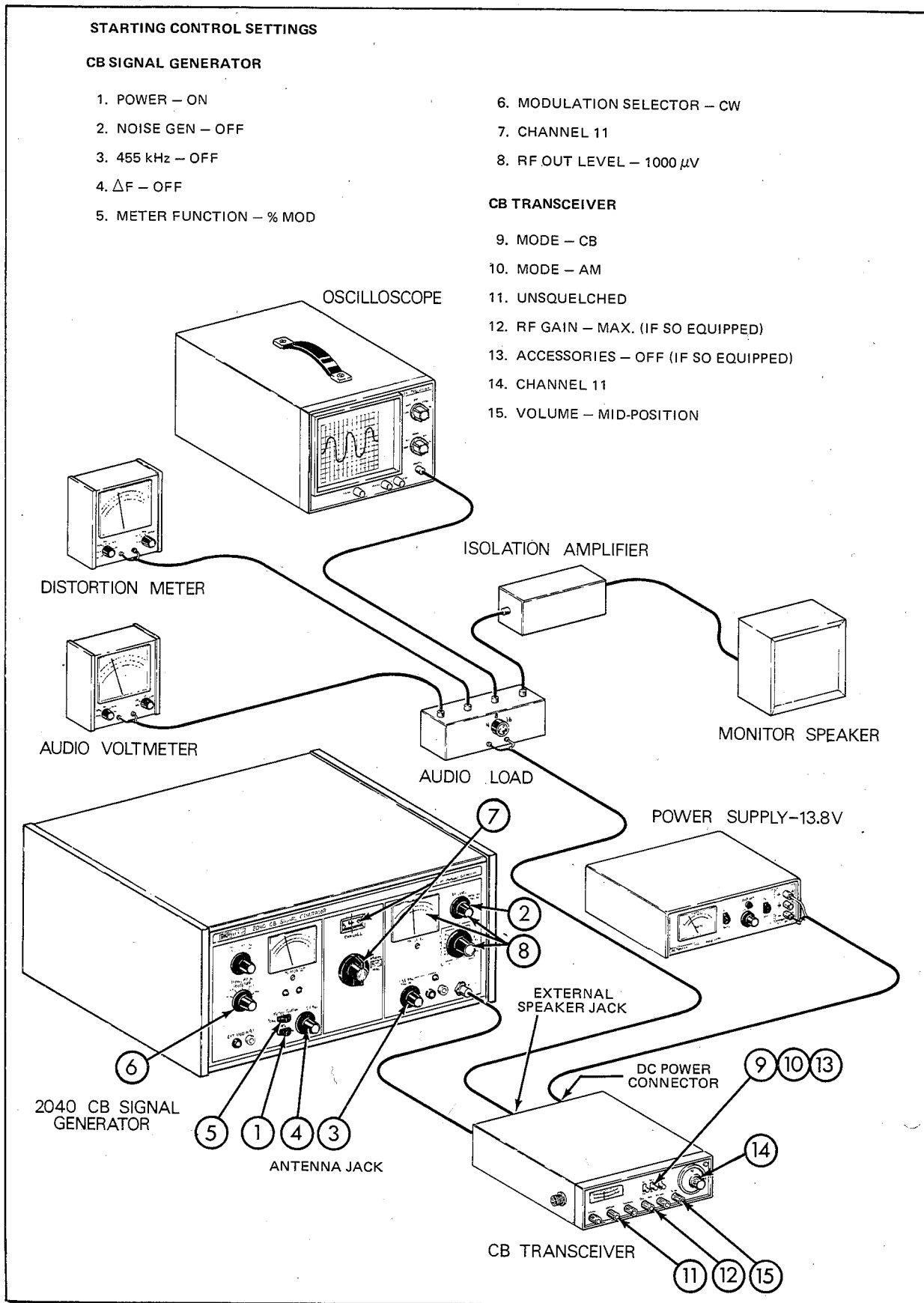

Fig. 5. Typical test equipment hookup for CB performance testing.

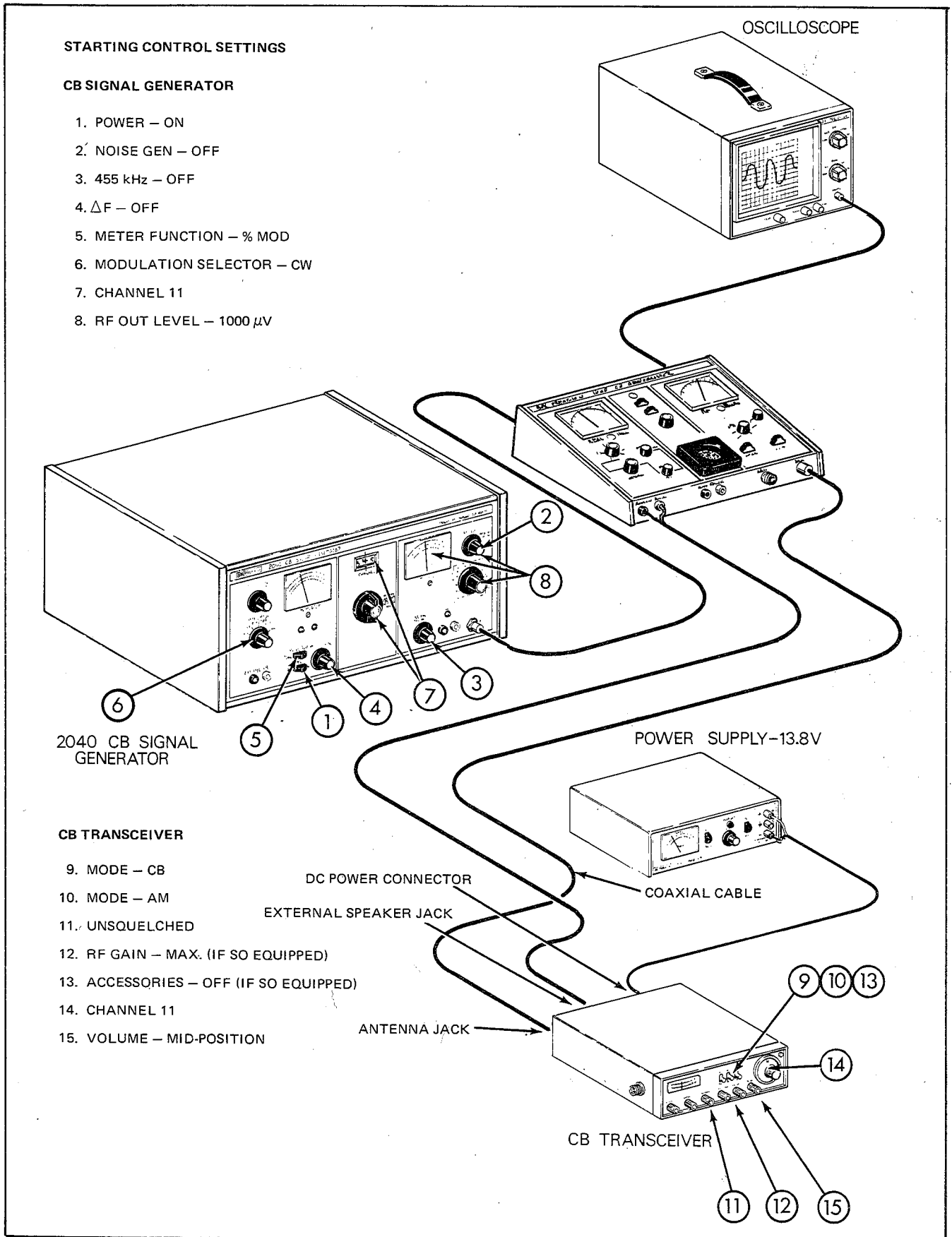
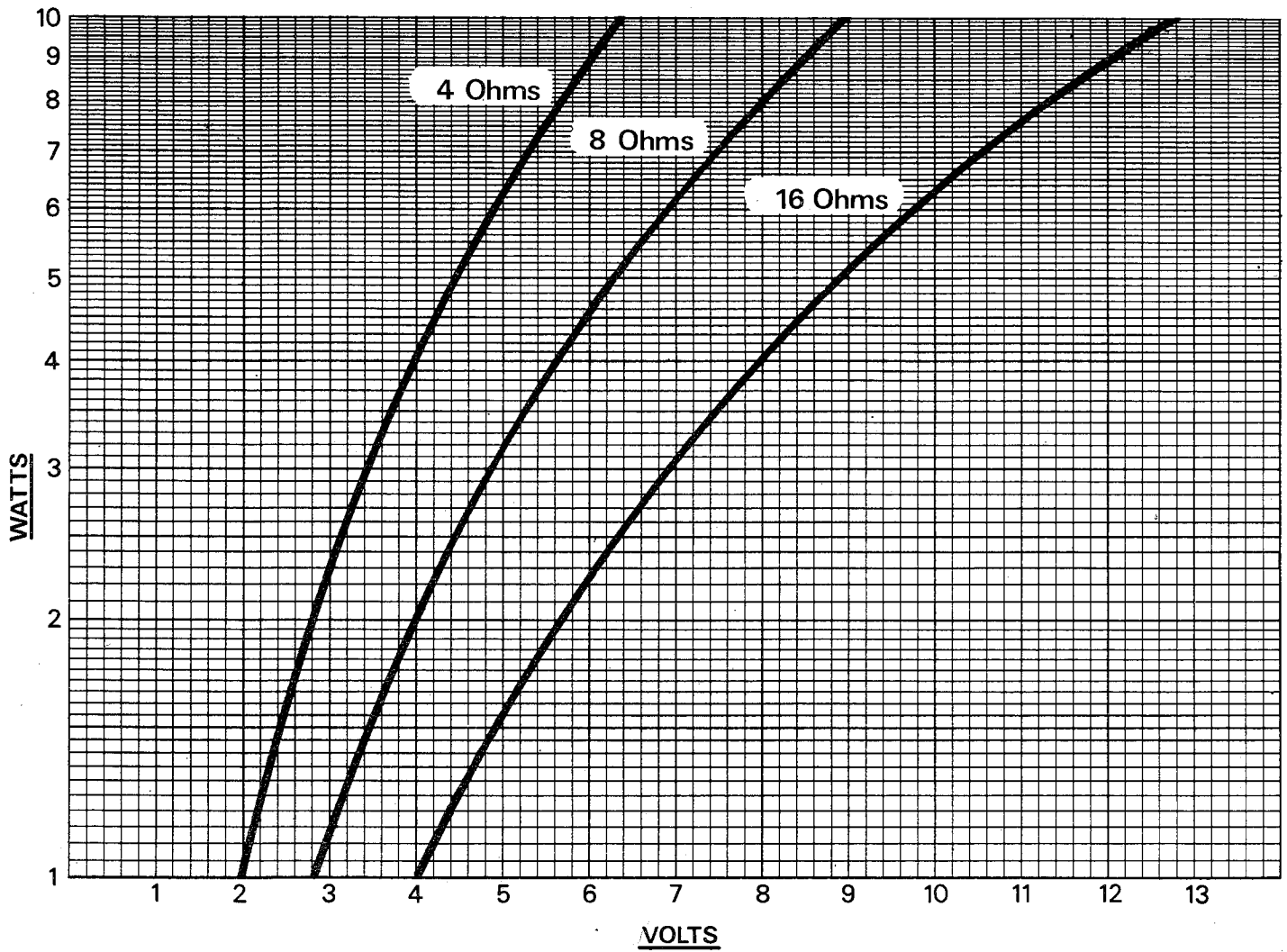

Fig. 6. Typical test equipment hookup, using CB ServiceMaster for performance testing.

Audio Voltage to Audio Power Conversion Chart 1 to 10 Watts



Audio Voltage to Audio Power Conversion Chart

.1 to 1 Watt

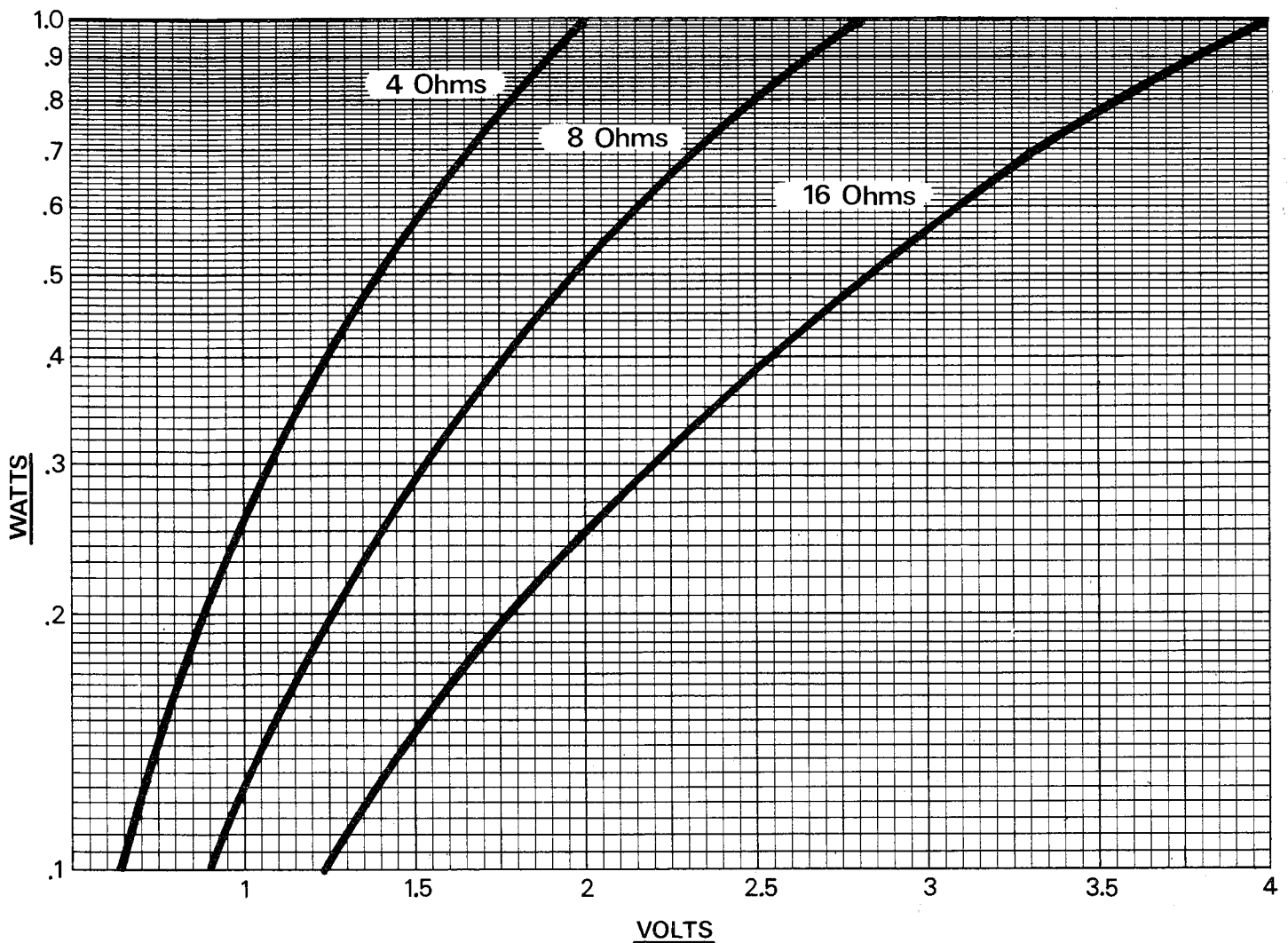

RECEIVER AUDIO POWER AND FREQUENCY RESPONSE CHECK (Refer to Fig. 7)

The receiver audio power check is normally the first receiver check performed. It will quickly determine if the receiver is totally dead. If not, it will check whether the audio section can deliver adequate audio power. If the audio power output is normal, the audio frequency response can be checked almost instantly by comparing the output power at 400 Hz and 2500 Hz to the 1000 Hz reference. This is a good overall check of the receiver's ability to pass all audio signals in the voice communications band.

If distortion measuring equipment is available, it is desirable to check audio power and distortion simultaneously as described in a later check. Testing time will probably be shortened if the distortion check is performed immediately after this check.

This check is applicable to all AM and AM/SSB transceivers and needs to be performed on only one channel.

1. Set the controls on the CB Signal Generator and transceiver as shown in Fig. 5.
2. Set CB Signal Generator controls for 1000 Hz, 30% modulation.
3. Set the RF output level at 1000 microvolts.
4. Set transceiver volume to maximum.
5. Read the audio power on the audio voltmeter (convert to watts using the conversion charts in this manual if necessary). Audio power should equal or exceed the transceiver manufacturer's specification, which is typically 2½ watts or more.

generator to the external modulation jacks of the CB Signal Generator, selecting EXT modulation, and adjusting for 30% modulation with a 1000 Hz signal. The audio signal generator is then tuned from 300 to 3000 Hz (or similar upper and lower limits specified by the transceiver manufacturer), keeping modulation at 30%, and noting the reading on the audio voltmeter. The frequency response should not show dips or peaks, but a smooth response within specification across the entire band.

AM RECEIVER SENSITIVITY CHECK
(Refer to Fig. 8)

This check measures the weakest usable signal level at which the receiver will operate. It is the best overall check of receiver performance that can be made, and is typically one of the first receiver performance tests made. The

sensitivity check is applicable to all AM and AM/SSB CB transceivers. For AM/SSB units, this check should be performed in the AM mode before making subsequent SSB mode checks.

Receiver sensitivity is expressed as the signal level required to produce a 10 dB signal-plus-noise to noise ratio; for example, $1 \mu V = 10 \text{ dB (S+N)/N}$. This means that a 1 microvolt 30% modulated signal into the receiver antenna produces an audio output at least 10 dB above the receiver noise level obtained with a 1 microvolt unmodulated signal. Many specifications include the condition that the 10 dB (S+N)/N sensitivity be obtained at some minimum audio output power; for example, $1 \mu V$ for 10 dB (S+N)/N @ 1/2 watt audio. This is a good specification for overall receiver sensitivity.

1. CONTROLS SET PER FIGURE 5
2. 1000 Hz, 30% MODULATION
3. RF OUT LEVEL TO 10dB (S+N)/N SENSITIVITY SPECIFICATION
4. VOLUME FOR CONVENIENT READING ON AUDIO VOLTMETER
5. SWITCH TO CW MODULATION, AUDIO VOLTMETER READING DROPS
6. READJUST RF OUT LEVEL FOR 10dB DROP WHEN SWITCHING FROM 1000 Hz TO CW MODULATION. RF OUT LEVEL IN μV IS 10dB (S+N)/N SENSITIVITY
7. REPEAT FOR ALL CHANNELS

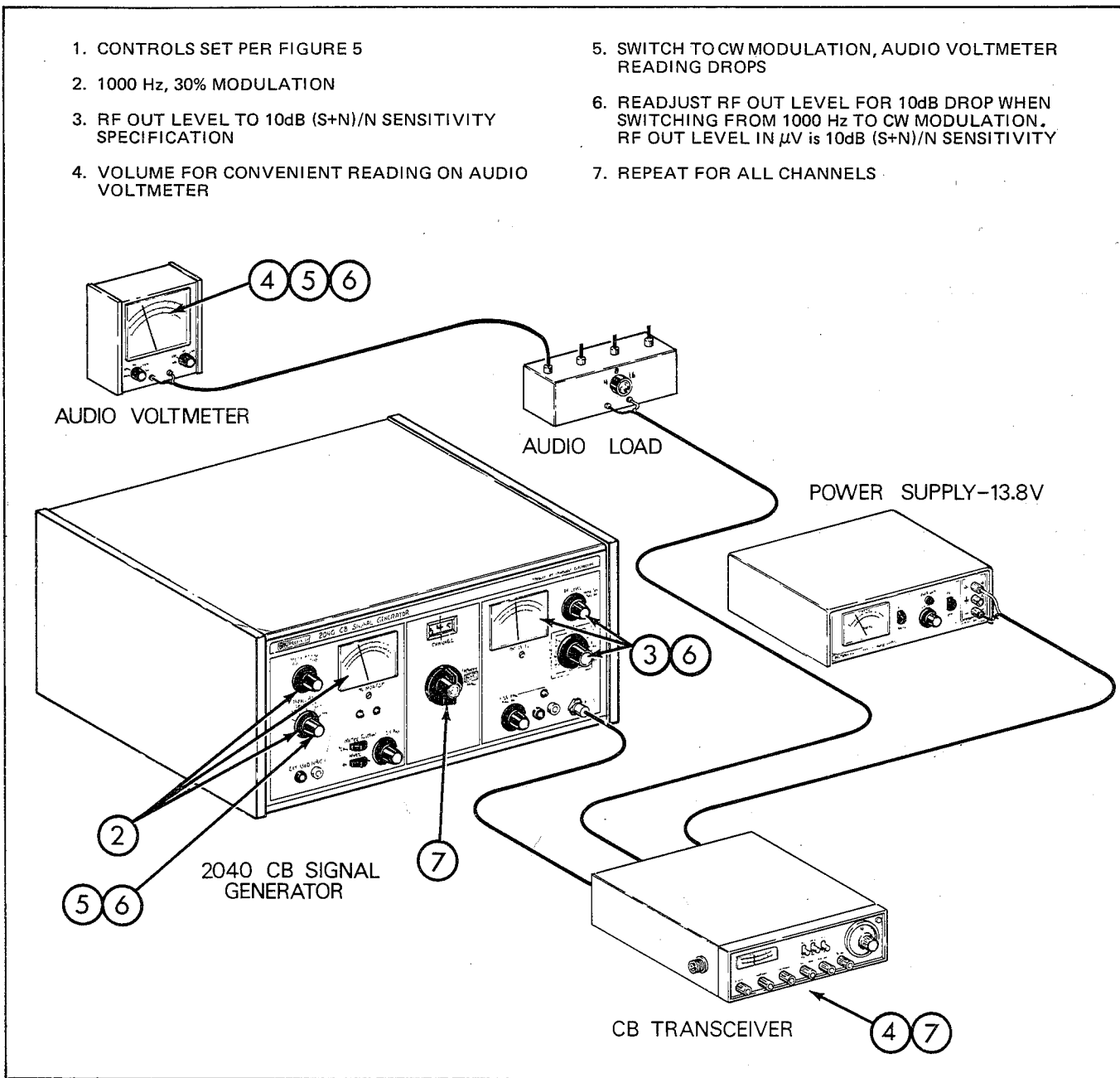

Fig. 8. AM receiver sensitivity check.

1. Set the controls on the CB Signal Generator and transceiver as shown in Fig. 5.
2. Set RF Signal Generator controls for 1000 Hz, 30% modulation.
3. Set the RF output level to the 10 dB (S+N)/N specification of the transceiver being checked, typically 1 microvolt or less.
4. Adjust the transceiver volume control for any convenient reading on the audio voltmeter, such as 0 dB. If no reading can be obtained, the receiver is defective and requires troubleshooting.
5. Switch to CW modulation. The audio voltmeter reading should drop about 10 dB.
6. Readjust the RF output level so that there is an exact 10 dB drop when switching from 1000 Hz to CW modulation. The RF output level in microvolts is the 10 dB (S+N)/N sensitivity of the receiver, and it should equal or exceed the manufacturer's specification.
7. Receiver sensitivity usually needs to be checked on only one channel, but proper operation on all other channels can be rapidly checked as follows:
 - a. Leave the RF output level of the CB Signal Generator set at the step 6 level.
 - b. In turn, set the CB Signal Generator and the transceiver to each channel.
 - c. For each channel, apply 1000 Hz and CW modulation and observe that the audio voltmeter reading drops 10 dB when switching to CW modulation. All channels should have the same sensitivity.

In most cases, it is only necessary to know if the receiver meets or exceeds the manufacturer's specification for sensitivity. To do this, perform steps 1 through 5 only. If the audio voltmeter drops 10 dB or more, the receiver sensitivity is equal to, or better than, its specification.

If receiver sensitivity is less than 0.3 microvolt, use a 20 dB pad as described in the ULTRA-LOW OUTPUT, LEVELS section of this manual.

If the receiver sensitivity is poor, troubleshooting or alignment may be required to correct the problem. Also check the synthesizer frequency as instructed later in this manual. If the synthesizer is off-frequency, poor sensitivity is one of the first noticeable results.

AM RECEIVER ADJACENT CHANNEL REJECTION CHECK (Refer to Fig. 9)

Rejection of adjacent channel signals is very important to prevent strong signals on adjacent channels from causing interference. This check is comparable to a receiver selectivity measurement, it measures the ability of the receiver to reject adjacent channel signals.

This check can be performed on AM or AM/SSB transceivers. For AM/SSB units, the check is performed in the AM mode and need not be repeated for the SSB mode. (However, the SSB ADJACENT SIDEBAND REJECTION CHECK should be performed.)

Typically, adjacent channel rejection is the same for all channels, and need be checked for only one channel. However, certain component failures can cause low adjacent channel rejection only on specific channels. The check should be repeated for each channel exhibiting adjacent channel interference.

1. Set controls on the CB Signal Generator and transceiver as shown in Fig. 5.
2. Set CB Signal Generator controls for 1000 Hz, 30% modulation.
3. Set the RF output level at the 10 dB (S+N)/N sensitivity level.
4. Adjust the volume control on the transceiver for any convenient reading on the audio voltmeter, such as 0 dB. Note this reading for reference.
5. Set the channel selector (14) of the CB Signal Generator to the next higher adjacent setting. (Note that this is an unassigned frequency between channel 11 and channel 12.)
6. Increase the RF output level until the audio voltmeter reads the same value as in step 4. Do not readjust the volume control on the transceiver.
7. Read the RF output level of the CB Signal Generator in dBm and compare the reading with that noted in step 3. The difference between the readings in dB, is the adjacent channel rejection figure. This figure should be at least 30 dB for all CB transceivers, and some high-quality sets may measure 60 dB or more. This figure should exceed the manufacturer's selectivity specification which is usually stated for a 20 kHz bandwidth (± 10 kHz from channel frequency). If the adjacent channel rejection measures in the vicinity of 100 dB, receiver desensitization is probably the cause and the results are invalid. Using the lowest possible reference level in step 3 reduces the probability of receiver desensitization.
8. Switch the CB Signal Generator to channel 10.
9. Normally, the audio voltmeter should read the same as in step 7, which indicates that lower adjacent channel rejection equals higher adjacent channel rejection. If the audio voltmeter reading does not equal the step 7 reading, readjust the RF output level of the CB Signal Generator until it does.
10. The difference between this RF output level and that noted in step 3 is the lower adjacent channel rejection figure.

Repeat the check on all channels where adjacent channel interference has been noted.

1. CONTROLS SET PER FIGURE 5
2. 1000 Hz, 30% MODULATION
3. RF OUT LEVEL 10dB (S+N)/N. NOTE RF OUT LEVEL IN dBm
4. VOLUME FOR CONVENIENT READING ON AUDIO VOLTMETER
5. CHANNEL SELECTOR TO NEXT HIGHER ADJACENT CHANNEL
6. INCREASE RF OUT UNTIL AUDIO VOLTMETER READS SAME AS STEP 4. NOTE RF OUT LEVEL IN dBm
7. REJECTION IN dB = STEP 6 - STEP 3
8. CHANNEL SELECTOR TO NEXT LOWER ADJACENT CHANNEL
9. READJUST RF OUT LEVEL SO AUDIO VOLTMETER READS SAME AS STEP 4. NOTE RF OUT LEVEL IN dBm
10. REJECTION IN dB = STEP 9 - STEP 3

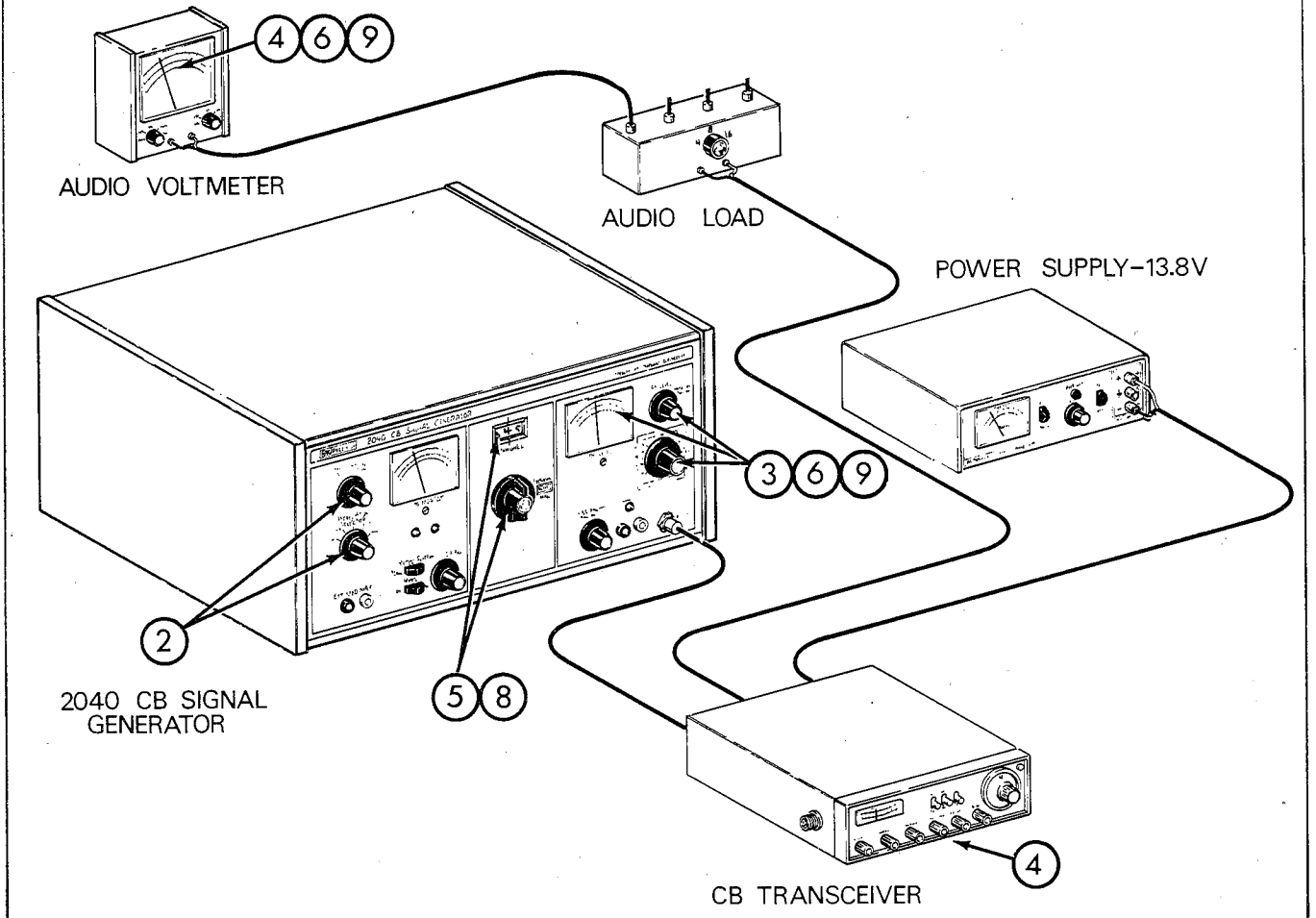

Fig. 9. AM receiver adjacent channel rejection check.

AM RECEIVER SQUELCH SENSITIVITY CHECK (Refer to Fig. 10)

A squelch sensitivity check includes both threshold and tight squelch sensitivity measurements. This check is applicable to all AM and AM/SSB CB receivers. It only needs to be performed on one channel; a midband channel such as 11 is satisfactory.

The squelch threshold sensitivity check measures the weakest signal required to unsquelch the receiver with the squelch control set at threshold. Squelch threshold sensitivity is measured in microvolts. Typically, squelch thresh-

old sensitivity should be less than the specified 10 dB (S+N)/N sensitivity of the receiver, which is usually 1 microvolt or less.

When the receiver is adjusted for tight squelch (squelch control fully clockwise), it should block weak signals but accept strong, locally transmitted signals. The tight squelch sensitivity check measures the signal strength required to unsquelch the receiver with the squelch control set at tight squelch. The sensitivity should not exceed 1000 μ V but may be as low as 30 μ V for some receivers.

1. CONTROLS SET PER FIGURE 5
2. RF OUT LEVEL TO MINIMUM
3. TRANSCIEVER AND SIGNAL GENERATOR TO DIFFERENT CHANNELS
4. ADJUST VOLUME FOR CONVENIENT AUDIO VOLTMETER READING
5. SQUELCH AT THRESHOLD, AUDIO VOLTMETER READING DROPS
6. 1000 Hz, 30% MODULATION
7. TRANSCIEVER AND CB SIGNAL GENERATOR TO SAME CHANNEL
8. SLOWLY INCREASE RF OUT LEVEL UNTIL AUDIO UNSQUELCHES
9. READ RF OUT LEVEL IN μV . THIS IS SQUELCH THRESHOLD SENSITIVITY
10. SQUELCH TO MAXIMUM (TIGHT SQUELCH)
11. INCREASE RF OUT LEVEL UNTIL AUDIO UNSQUELCHES
12. READ RF OUT LEVEL IN μV . THIS IS THE TIGHT SQUELCH SENSITIVITY

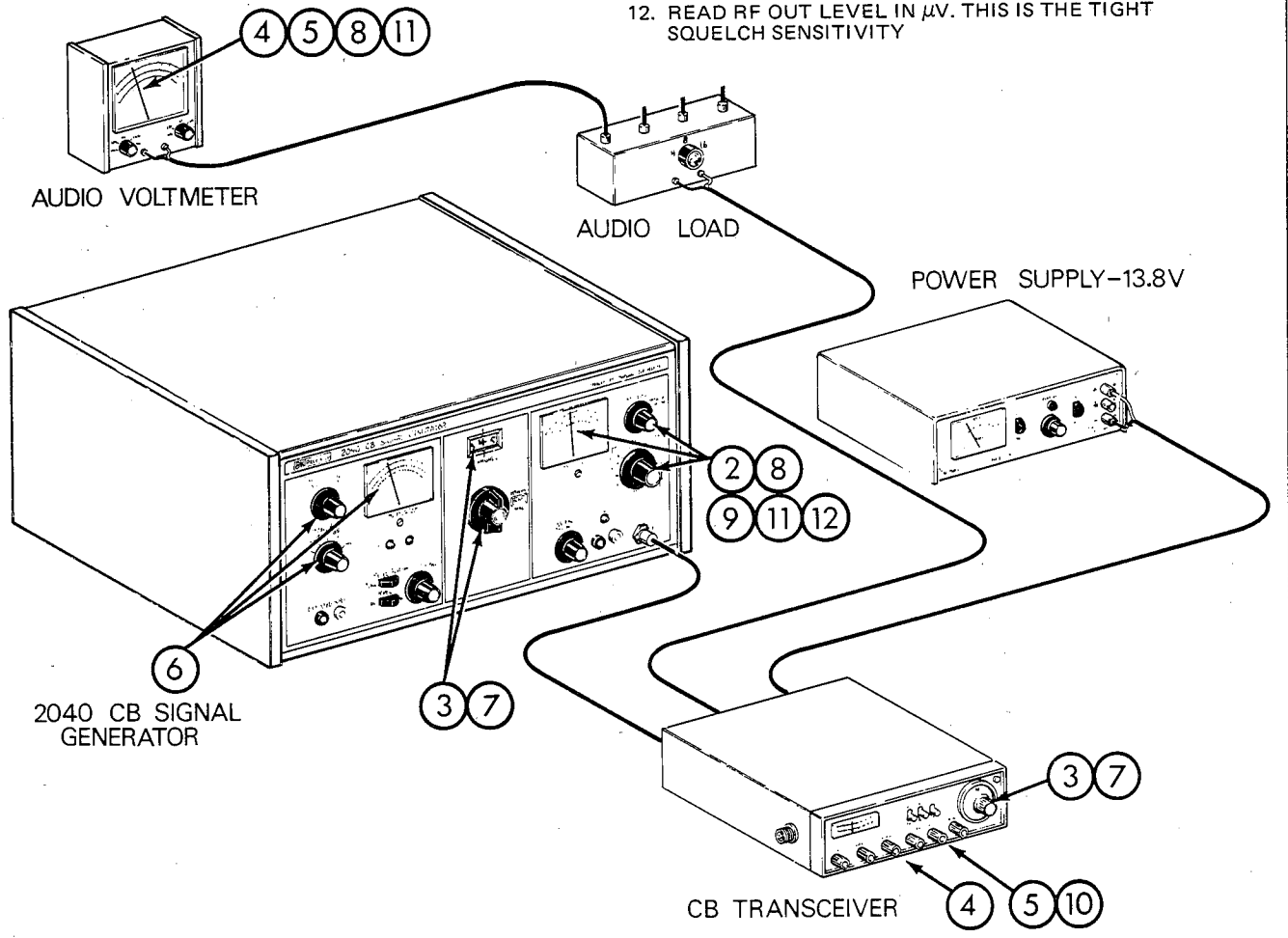

Fig. 10. AM receiver squelch sensitivity check.

1. Set the controls on the CB Signal Generator and the transceiver as shown in Fig. 5.
2. Set the RF output level of the CB Signal Generator to minimum.
3. Leave the transceiver set to channel 11 and switch the CB Signal Generator to any channel except 11.
4. Adjust the volume control of the transceiver for any convenient reading on the audio voltmeter. This is background noise only.
5. Adjust the squelch control of the transceiver to threshold; that is, to the point where the background noise is just squelched (audio voltmeter reading should drop 20 dB or more).
6. Set CB Signal Generator controls for 1000 Hz, 30% modulation.
7. Switch the CB Signal Generator back to channel 11, the same channel as the transceiver.
8. Slowly increase the RF output level of the CB Signal Generator until the audio unsquelches, which will cause the audio voltmeter reading to suddenly increase.

NOTE

If the audio unsquelches as soon as the CB Signal Generator is switched to channel 11, a lower RF output level is required. Use a 20 dB pad as instructed in the **ULTRA-LOW OUTPUT LEVELS** portion of this manual, or be assured of a squelch threshold sensitivity of $0.3 \mu\text{V}$ or less.

9. Read the RF output level in microvolts. This is the squelch threshold sensitivity.
10. Readjust the squelch control setting on the transceiver for tight squelch (fully clockwise).
11. Slowly increase the RF output level of the CB Signal Generator until the audio again unsquelches (point where voltmeter reading suddenly increases).
12. Read the RF output level of the CB Signal Generator in microvolts. This is the tight squelch sensitivity.

RECEIVER AGC CHECK
(Refer to Fig. 11)

This check verifies proper operation of the receiver AGC (automatic gain control) circuit. As the input signal level is changed from 50,000 microvolts to 1 microvolt, the audio output level should not change more than 30 dB. This check needs to be performed only for one channel. This check is applicable to AM and AM/SSB transceivers. For AM/SSB units, no additional check is required for the SSB modes.

1. Set controls of the CB Signal Generator and the transceiver as shown in Fig. 5.
2. Set CB Signal Generator controls for 1000 Hz, 30% modulation.
3. Set the RF output level of the CB Signal Generator to 50,000 microvolts.

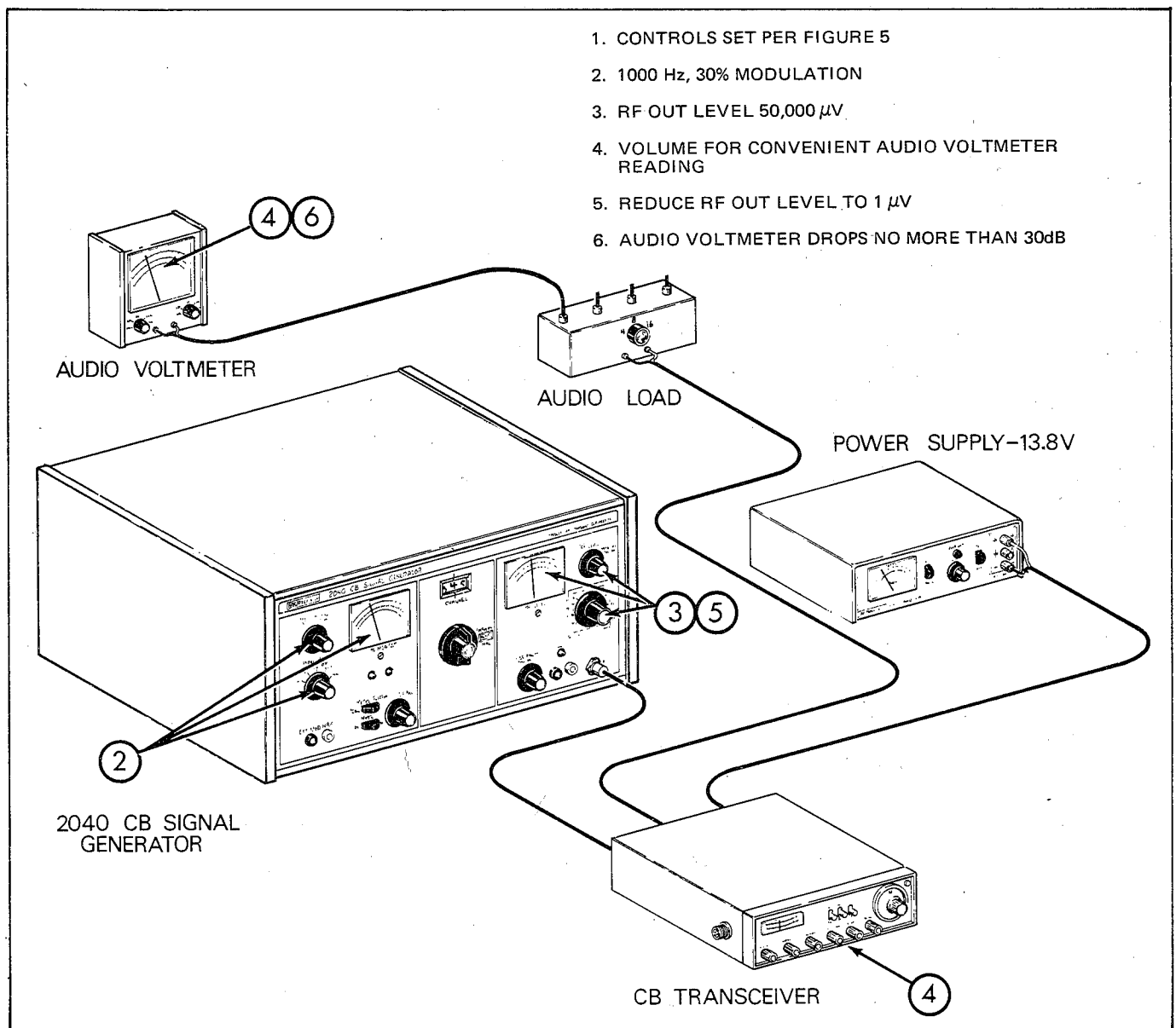

Fig. 11. Receiver AGC check.

4. Adjust the volume control of the transceiver for any convenient reading on the audio voltmeter. A fairly high volume should be used to establish this reference.
5. Slowly reduce the RF output level to $1 \mu\text{V}$ and note that the audio voltmeter reading drops smoothly, without sharp dips or peaks.

6. The audio voltmeter reading at $1 \mu\text{V}$ RF input should be no more than 30 dB below the step 4 reference at $50,000 \mu\text{V}$ RF input.

If the transceiver is equipped with an S meter, it should read maximum at $50,000 \mu\text{V}$ RF input and smoothly decrease to near zero at $1 \mu\text{V}$ RF input.

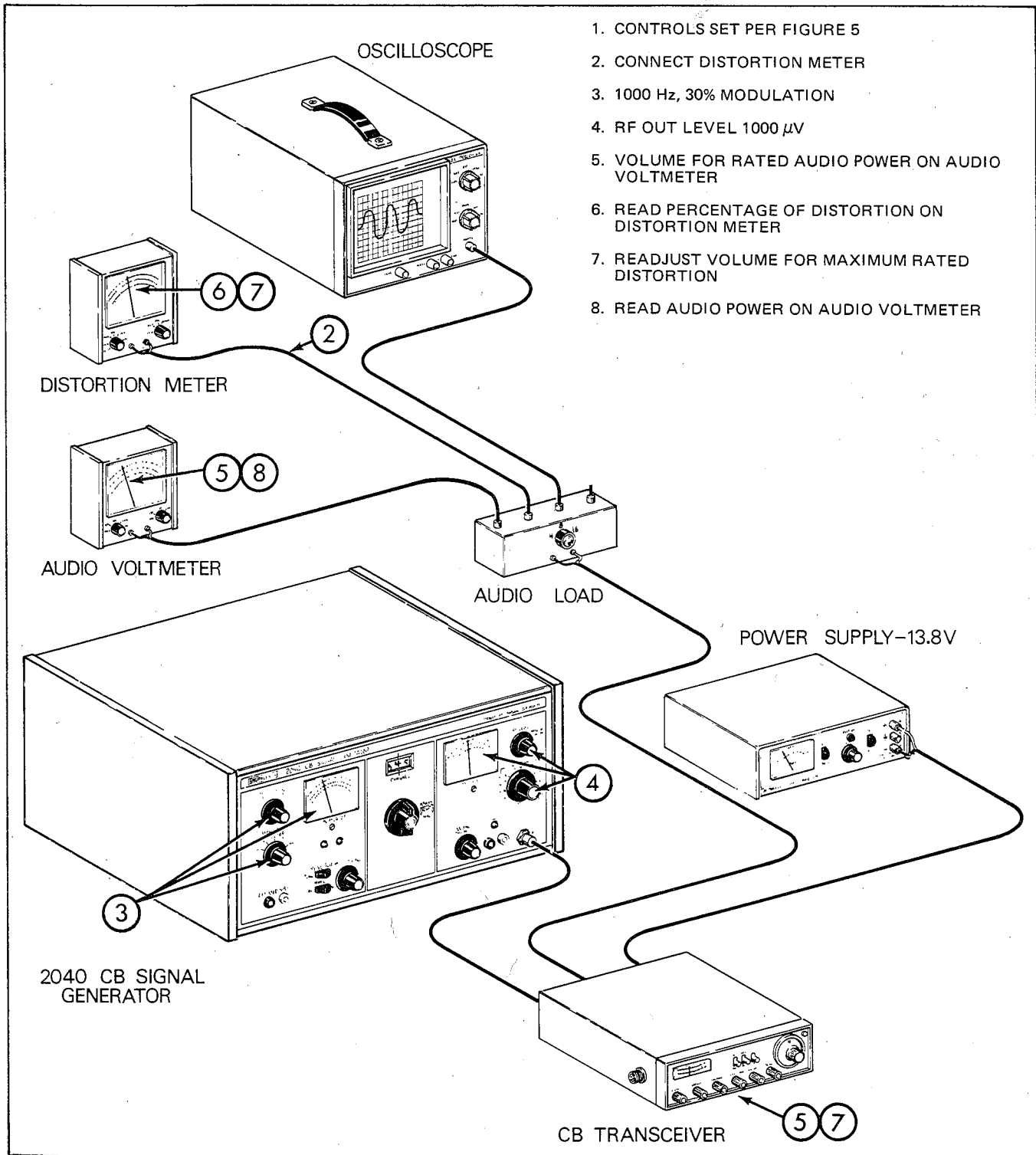

Fig. 12. Receiver audio power and distortion check.

**RECEIVER AUDIO POWER AND DISTORTION CHECK
(Refer to Fig. 12)**

The audio power and distortion check measures the maximum audio power output at a given percentage of distortion (for example, 3 watts @ 10% distortion), which should equal or exceed the transceiver manufacturer's specification. The check is applicable to all AM and AM/SSB transceivers and needs to be performed on only one channel.

1. Set controls of the CB Signal Generator and the transceiver as shown in Fig. 5.
2. Connect a distortion meter across the audio load as shown in Fig. 12. If the test equipment hook-up shown in Fig. 5 or 6 was used for previous tests, no changes are necessary.
3. Set CB Signal Generator controls for 1000 Hz, 30% modulation.
4. Set the RF output level of the CB Signal Generator at 1000 microvolts.
5. Adjust the volume control of the transceiver for the rated audio power output of the transceiver being tested, as read on the audio voltmeter (use voltage-to-power conversion charts provided in this manual, if necessary).
6. Set up the distortion meter to measure 1000 Hz distortion and read the percentage of distortion.
7. Readjust the volume control of the transceiver to obtain maximum rated distortion for the transceiver being tested, as read on the distortion meter.

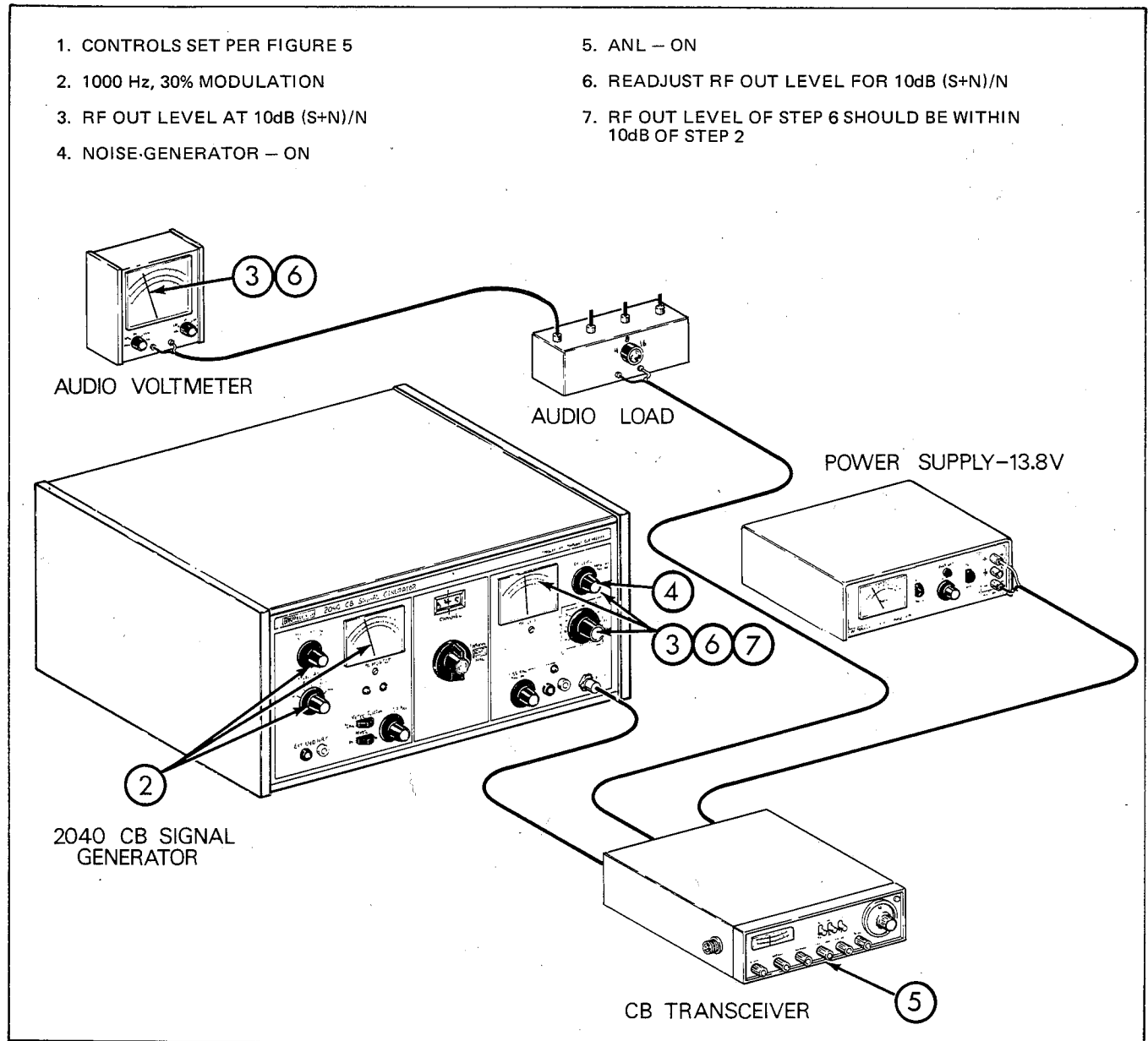

Fig. 13. Receiver ANL effectiveness check.

8. Read the audio output power on the audio voltmeter. The audio power output, in watts, should equal or exceed the transceiver manufacturer's specification at the maximum rated distortion.

RECEIVER ANL EFFECTIVENESS CHECK (Refer to Fig. 13)

Most CB receivers are equipped with an automatic noise limiter (ANL) circuit. The effectiveness of these circuits can be checked only in the presence of noise. The CB Signal Generator includes a noise generator for such checks. The effectiveness is measured by making a 10 dB (S+N)/N sensitivity measurement without noise, and again in the presence of noise. Sensitivity will, of course, be degraded in the presence of noise. The effectiveness of the ANL circuit determines the degree to which it is degraded, which typically should be less than 10 dB.

1. Set controls of the CB Signal Generator and the transceiver as shown in Fig. 5.
2. Set controls of the CB Signal Generator for 1000 Hz, 30% modulation.
3. Set the RF output level of the CB Signal Generator at the 10 dB (S+N)/N sensitivity level.
4. Turn on the noise generator by pulling outward on the RF LEVEL/NOISE GEN control.
5. If the transceiver is equipped with an ANL switch, place it in the on position.
6. Readjust the RF output level of the CB Signal Generator for 10 dB (S+N)/N sensitivity in the presence of noise.
7. The sensitivity in the presence of noise should be within 10 dB of the sensitivity without noise.

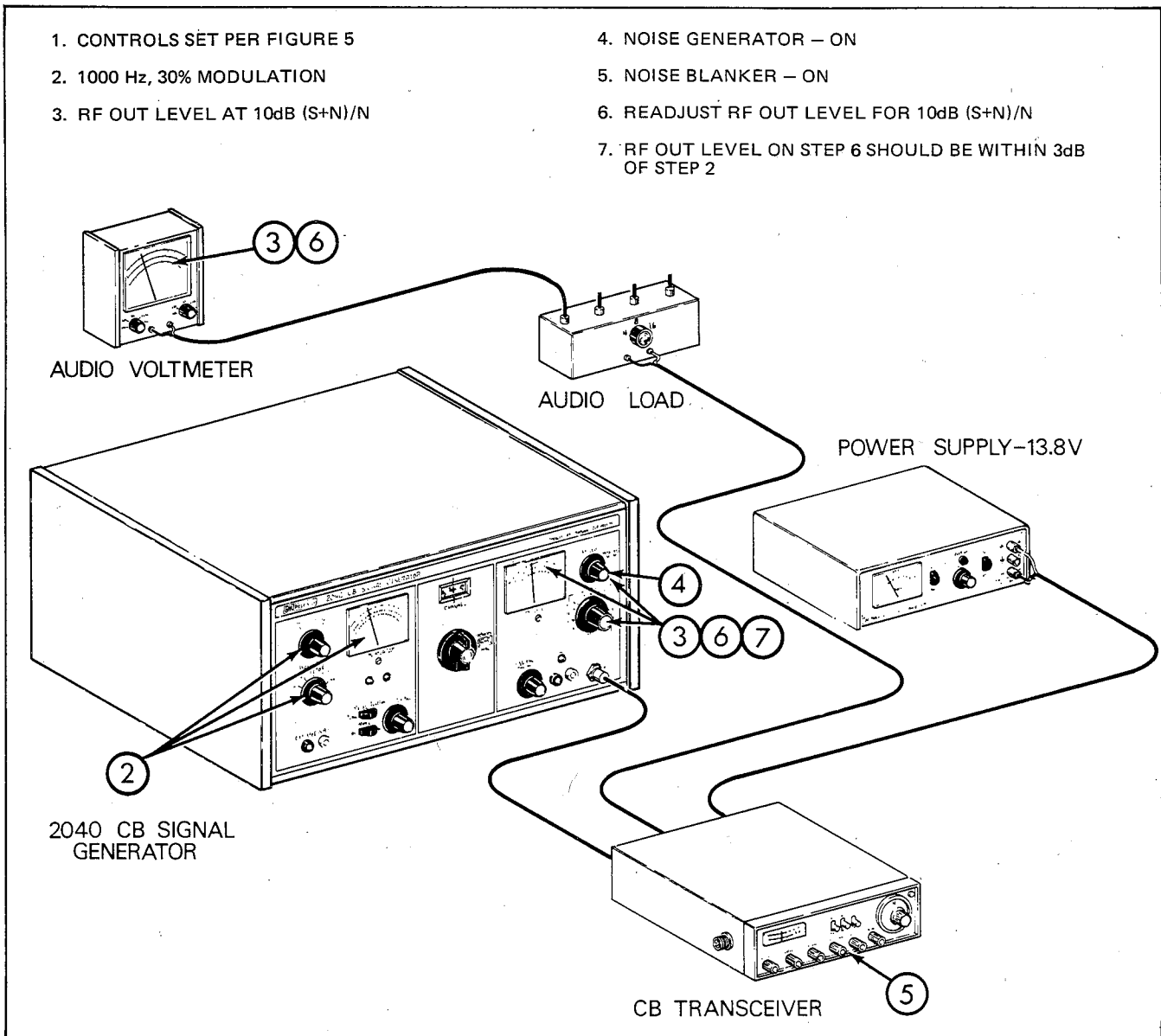

Fig. 14. Receiver noise blanker effectiveness check.

RECEIVER NOISE BLANKER EFFECTIVENESS CHECK (Refer to Fig. 14)

Many CB receivers are equipped with a noise blanker circuit which is intended to eliminate most of the noise from electrical interference such as poorly suppressed vehicle ignitions, electric motors, neon signs, etc. The CB Signal Generator includes a noise generator which generates interference for checking the effectiveness of noise blanker circuits. The effectiveness is measured by making a 10 dB (S+N)/N sensitivity measurement without noise, and again in the presence of noise. With an effective noise blanker, sensitivity should not be degraded more than 3 dB.

1. Set controls of the CB Signal Generator and the transceiver as shown in Fig. 5.
2. Set controls of the CB Signal Generator for 1000 Hz, 30% modulation.
3. Set the RF output level of the CB Signal Generator at the 10 dB (S+N)/N sensitivity level.
4. Turn on the noise generator by pulling outward on the RF LEVEL/NOISE GEN control.
5. Place the noise blanker switch on the transceiver to the on position.
6. Readjust the RF output level of the CB Signal Generator for 10 dB (S+N)/N sensitivity in the presence of noise.
7. The sensitivity in the presence of noise should be within 3 dB of the sensitivity without noise.

SSB RECEIVER SENSITIVITY CHECK (Refer to Fig. 15)

This check measures the weakest usable signal level at which the receiver will receive SSB signals. This check may be used for AM/SSB CB transceivers, and should be performed after the AM mode checks.

SSB receiver sensitivity is expressed in microvolts for 10 dB signal-plus-noise to noise ratio (for example, 0.5 microvolt for 10 dB (S+N)/N). This means that a 0.5 microvolt signal into the receiver antenna input should produce an audio output at least 10 dB above the noise level. Some manufacturers rate sensitivity at a minimum audio level (for example, 0.5 microvolt for 10 dB (S+N)/N @ ½ watt audio). This means that the 0.5 microvolt signal should produce audio at least 10 dB above the background noise level and the audio level should be at least 0.5 watt. This is a good overall specification of receiver performance.

For SSB receiver checks, the CB Signal Generator operates in the ΔF mode, which simulates a single-tone SSB signal. When the signal generator is operated in the ΔF mode and the RF output signal is adjusted 1 kHz above the assigned carrier frequency for the channel, the output signal is exactly that of a suppressed carrier, upper sideband signal

modulated with a single 1 kHz tone. When the RF output signal is adjusted 1 kHz below the assigned carrier frequency for the channel, the output signal is exactly that of a suppressed carrier, lower sideband signal modulated with a single 1 kHz tone.

1. Set controls of the CB Signal Generator and transceiver as shown in Fig. 5.
2. Place the transceiver in the USB mode.
3. Set the CB Signal Generator for CW modulation.
4. Set the RF output level of the CB Signal Generator to the SSB 10 dB (S+N)/N sensitivity specification for the transceiver being checked.
5. Place the CB Signal Generator in the ΔF mode by pulling outward on the ΔF control (15).
6. Set METER FUNCTION switch (19) to the ΔF position.
7. Tune the ΔF control (15) for +1 kHz offset. The amber + indicator (16) should be lighted and ΔF meter (2) should read 1 kHz.
8. Adjust the volume control of the transceiver for any convenient reading on the dB scale of the audio voltmeter. Note the reading for reference.
9. Switch the transceiver to the LSB mode. The audio voltmeter reading will drop sharply.
10. Readjust the RF output level so that there is an exact 10 dB drop in the audio voltmeter reading when the transceiver is switched from USB TO LSB. This RF output level, in microvolts, is the 10 dB (S+N)/N sensitivity for upper sideband operation.
11. Tune the ΔF control (15) for -1 kHz offset. The green indicator (16) should be lighted and ΔF meter (2) should read 1 kHz.
12. Place the transceiver in the LSB mode. The RF output level is already set at the upper sideband sensitivity.
13. Switch the transceiver to the USB mode. The audio voltmeter reading should drop 10 dB.
14. If required, readjust the RF output level for an exact 10 dB drop in the audio voltmeter reading when the transceiver is switched from the LSB to USB mode. This RF output level, in microvolts, is the 10 dB (S+N)/N sensitivity for lower sideband operation.

Check USB and LSB sensitivity for each channel of operation. Sensitivity should be approximately equal for all channels.

If receiver SSB sensitivity is less than 0.3 microvolts, use a 20 dB pad as described in the ULTRA-LOW OUTPUT LEVELS section of this manual.

If the receiver SSB sensitivity specification includes a minimum audio power rating, such as 0.5 microvolt for 10 dB (S+N)/N @ ½ watt audio, measure audio power

output. For the example, set the RF output level of the CB Signal Generator at 0.5 microvolt and note that it is possible to obtain at least 0.5 watt audio output power at maximum volume.

It is not always necessary to measure the sensitivity in microvolts, but merely to note whether or not the receiver meets the manufacturer's specification. In this case, merely set the CB Signal Generator to the specification level and note the audio voltmeter reading. Next, turn off the signal generator (or switch the transceiver to the opposite sideband) and again note the audio voltmeter reading. If there is a 10 dB or greater difference between the meter readings, the receiver meets specification. If there is less

than 10 dB difference between the two meter readings, it does not meet specification.

SSB RECEIVER ADJACENT SIDEBAND REJECTION CHECK
(Refer to Fig. 16)

This check measures the ability of a single-sideband receiver to suppress signals received on the opposite sideband. When the receiver is set for USB reception, any LSB input signals should be suppressed at least 40 dB, and when the receiver is set for LSB reception, any USB input signals should be suppressed at least 40 dB.

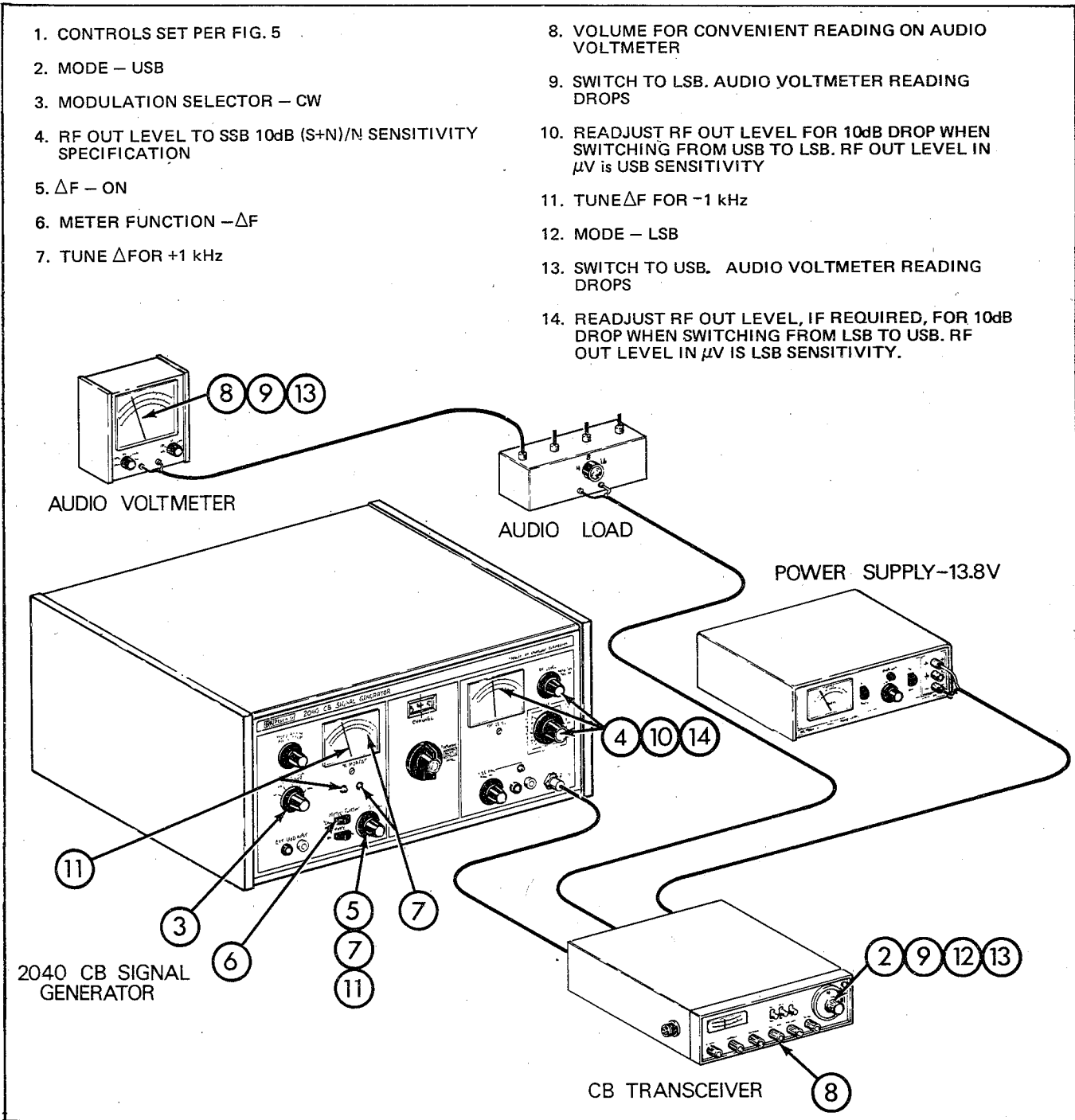

1. CONTROLS SET PER FIG. 5
2. MODE - USB
3. MODULATION SELECTOR - CW
4. RF OUT LEVEL TO SSB 10dB (S+N)/N! SENSITIVITY SPECIFICATION
5. ΔF - ON
6. METER FUNCTION - ΔF
7. TUNE ΔF FOR +1 kHz
8. VOLUME FOR CONVENIENT READING ON AUDIO VOLTMETER
9. SWITCH TO LSB. AUDIO VOLTMETER READING DROPS
10. READJUST RF OUT LEVEL FOR 10dB DROP WHEN SWITCHING FROM USB TO LSB. RF OUT LEVEL IN μV IS USB SENSITIVITY
11. TUNE ΔF FOR -1 kHz
12. MODE - LSB
13. SWITCH TO USB. AUDIO VOLTMETER READING DROPS
14. READJUST RF OUT LEVEL, IF REQUIRED, FOR 10dB DROP WHEN SWITCHING FROM LSB TO USB. RF OUT LEVEL IN μV IS LSB SENSITIVITY.

Fig. 15. SSB receiver sensitivity check.

This check should be performed *after* the SSB RECEIVER SENSITIVITY Check and is applicable to all AM/SSB CB receivers. This check needs to be performed on only one channel. Any channel is satisfactory.

1. Set up equipment for the check by performing steps 1 through 8 of the SSB RECEIVER SENSITIVITY CHECK.
2. Note the RF output level of the CB Signal Generator and the reading of the audio voltmeter for reference.
3. Switch the transceiver to the opposite sideband (LSB)
4. Increase the RF output level until the audio voltmeter reads the same as in step 2.
5. Note the RF output level. Adjacent sideband rejection in dB equals the difference between the RF output level in steps 2 and 4, and should be at least 40 dB.

Repeat the procedure, except set the CB Signal Generator to the LSB Frequency and measure upper sideband rejection.

SSB RECEIVER SQUELCH SENSITIVITY CHECK (Refer to Fig. 17)

This check measures the minimum amount of SSB signal required to unscquelch the receiver when adjusted at squelch threshold, and at tight squelch. The receiver should meet the receiver manufacturer's specification for squelch threshold sensitivity, which is typically 0.5 microvolt or less, and tight squelch sensitivity, which may vary from 30 microvolts to 500 microvolts depending upon the manufacturer. The receiver should not block strong signals, even when set at tight squelch.

This check is applicable to all AM/SSB receivers and should be performed after the SSB RECEIVER SENSI-

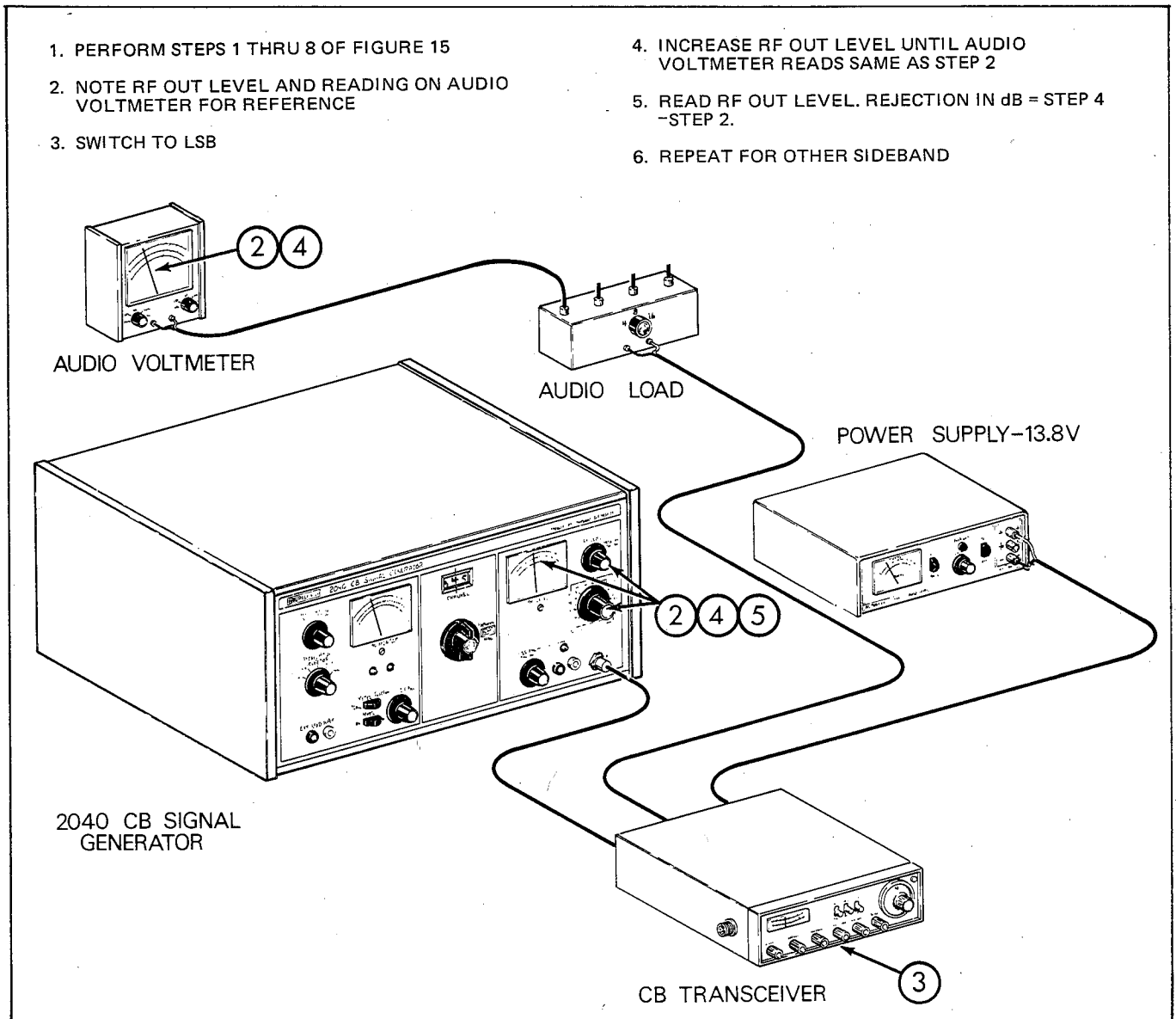

Fig. 16. SSB receiver adjacent sideband rejection check.

TIVITY CHECK. The check is very similar to the squelch sensitivity check for the AM mode except that the receiver is operated in the USB or LSB mode and the CB Signal Generator is operated in the ΔF mode. This check needs to be performed on only one channel; any channel is satisfactory.

1. Set up equipment for the check by performing steps 1 through 10 of the SSB RECEIVER SENSITIVITY CHECK. This sets the RF output level at 10 dB (S+N)/N sensitivity level for the upper sideband.
2. Switch the transceiver to the LSB mode.
3. Adjust the squelch control at threshold, that is, the point where the audio voltmeter suddenly drops at least 20 dB.
4. Set the RF output level of the CB Signal Generator to minimum.

5. Switch the transceiver back to the USB mode.

NOTE

If the audio unscelches as soon as the transceiver is switched to the USB mode, a lower RF output level is required from the CB Signal Generator. Use a 20 dB pad as instructed in the ULTRA-LOW OUTPUT LEVELS procedure in this manual, or be assured that the squelch threshold sensitivity is 0.3 μV or less.

6. Increase the RF output level slowly until the audio unscelches, which will be indicated by a sudden jump in the audio voltmeter reading.
7. Read the RF output level from the CB Signal Generator. This is the SSB squelch sensitivity in microvolts.

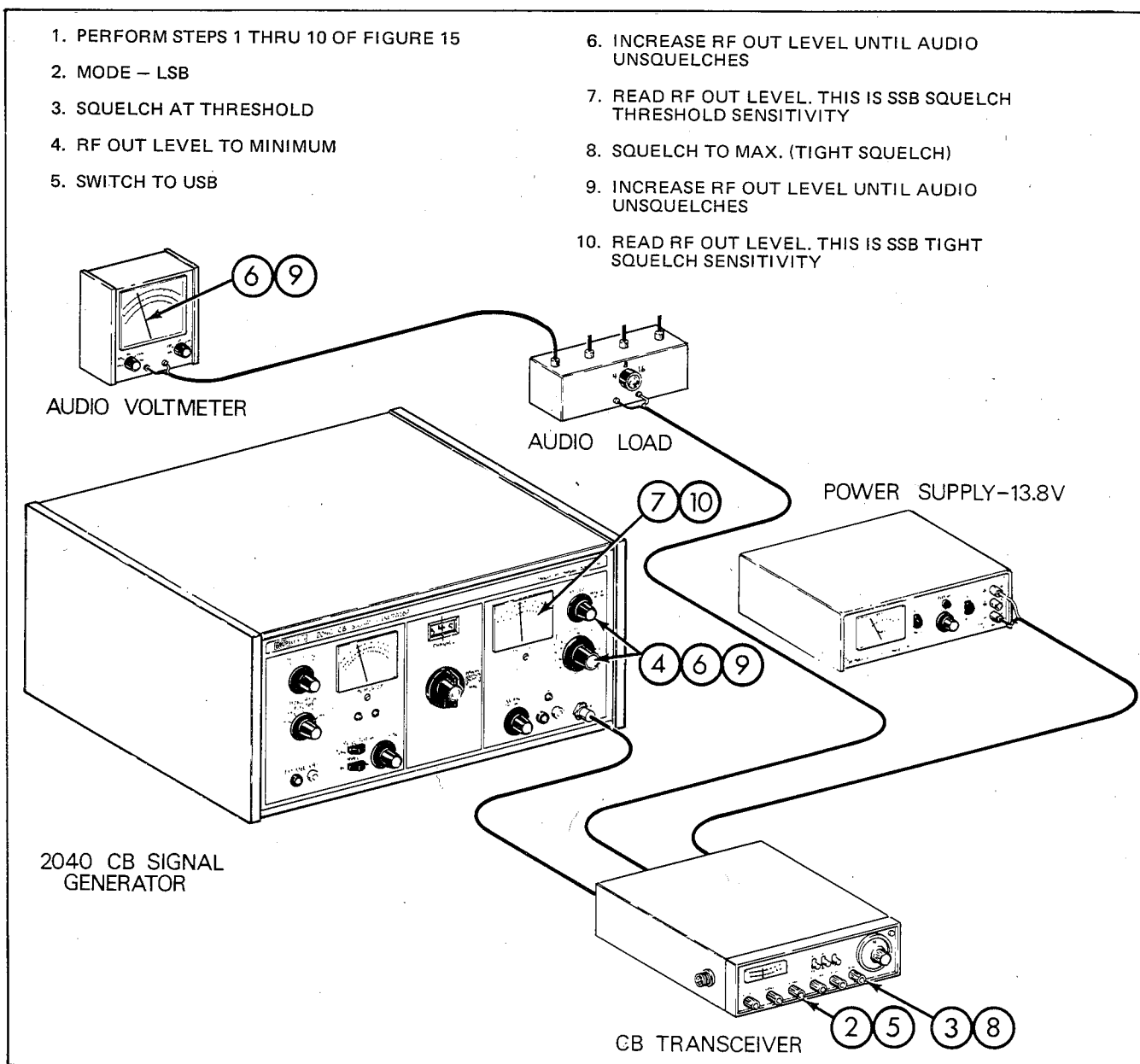

Fig. 17. SSB receiver squelch sensitivity check.

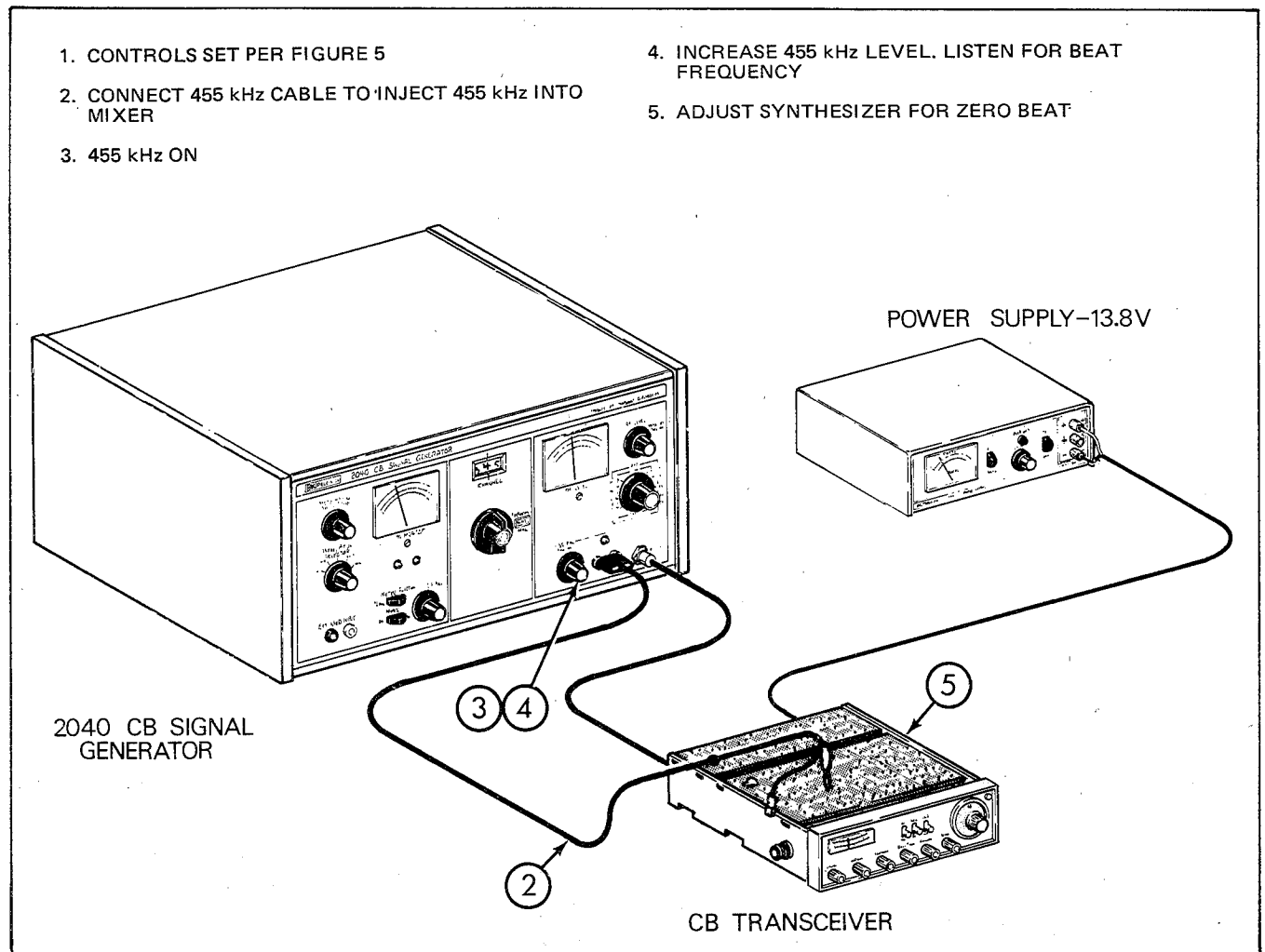

Fig. 18. Synthesizer frequency check and adjustment.

8. Readjust the squelch control of the transceiver to tight squelch (maximum clockwise).
9. Increase the RF output level of the CB Signal Generator until the audio again unsquelches.
10. Read the RF output level of the CB Signal Generator. This is the tight squelch sensitivity in microvolts.

NOTES

CB RECEIVER ADJUSTMENTS

**SYNTHESIZER FREQUENCY CHECK
AND ADJUSTMENT**
(Refer to Fig. 18)

The high accuracy and stability of the CB Signal Generator makes it an ideal frequency standard for determining whether or not the synthesizer circuits of the transceiver are operating accurately on frequency. If receiver sensitivity is low, a synthesizer frequency check is recommended. Poor sensitivity is one of the symptoms of an off-frequency synthesizer.

If the receiver is equipped with a voice lock, clarifier, or similar fine frequency adjustment, it should be adjusted for best receiver sensitivity, which should be near the center of its adjustment range. Internal adjustment to the synthesizer should be made if the operator fine frequency control is not centered during this frequency check.

For best results, make synthesizer frequency checks and adjustments at room temperature. If transceivers are brought in from extreme cold or hot outdoor temperatures, allow the transceiver to stabilize at room temperature for 15 minutes before attempting to make frequency checks or adjustments.

Use the transceiver manufacturer's instructions for identifying frequency adjustments and the frequencies to be adjusted by each. However, the following general set-up and measurement technique can be used for most transceivers:

1. Remove the transceiver from its housing and connect a bench power supply set at 13.8 volts DC. Connect the

RF output of the CB Signal Generator to the antenna jack of the transceiver. Do not connect an audio load, since the internal speaker will be used in this check. Set controls of the CB Signal Generator and transceiver as prescribed in Fig. 5. The important settings are:

- a. Transceiver and signal generator set to same channel.
 - b. CW modulation.
 - c. RF output level at 1000 microvolts.
2. Connect a shielded cable from the 455 kHz output jack (11) of the CB Signal Generator to the transceiver. Loosely couple the 455 kHz signal into a coil in the mixer or early IF stage, or inject the signal directly at the desired test point.
 3. Turn on the 455 kHz generator by pulling outward on the 455 kHz control (12).
 4. Increase the 455 kHz signal level by rotating the 455 kHz control (12) clockwise. Listen for a beat frequency in the speaker of the transceiver.
 5. If the synthesizer is off-frequency from the CB Signal Generator, the mixer will produce a signal that is not exactly 455 kHz. If the IF signal is not exactly 455 kHz, it will beat with the injected 455 kHz signal from the signal generator, producing an audible note in the speaker. Adjust the synthesizer for zero beat.

NOTES

1. CONTROLS SET PER FIGURE 5
2. 1000 Hz, 30% MODULATION
3. ALIGN PER CB TRANSCEIVER MANUFACTURERS INSTRUCTIONS
4. CONNECT 455 kHz CABLE IF 455 kHz INJECTION REQUIRED
5. 455 kHz LEVEL TO MINIMUM THAT PRODUCES USABLE INDICATION ON AUDIO VOLTMETER
6. MINIMUM RF OUT LEVEL THAT PRODUCES USABLE INDICATION ON AUDIO WATTMETER

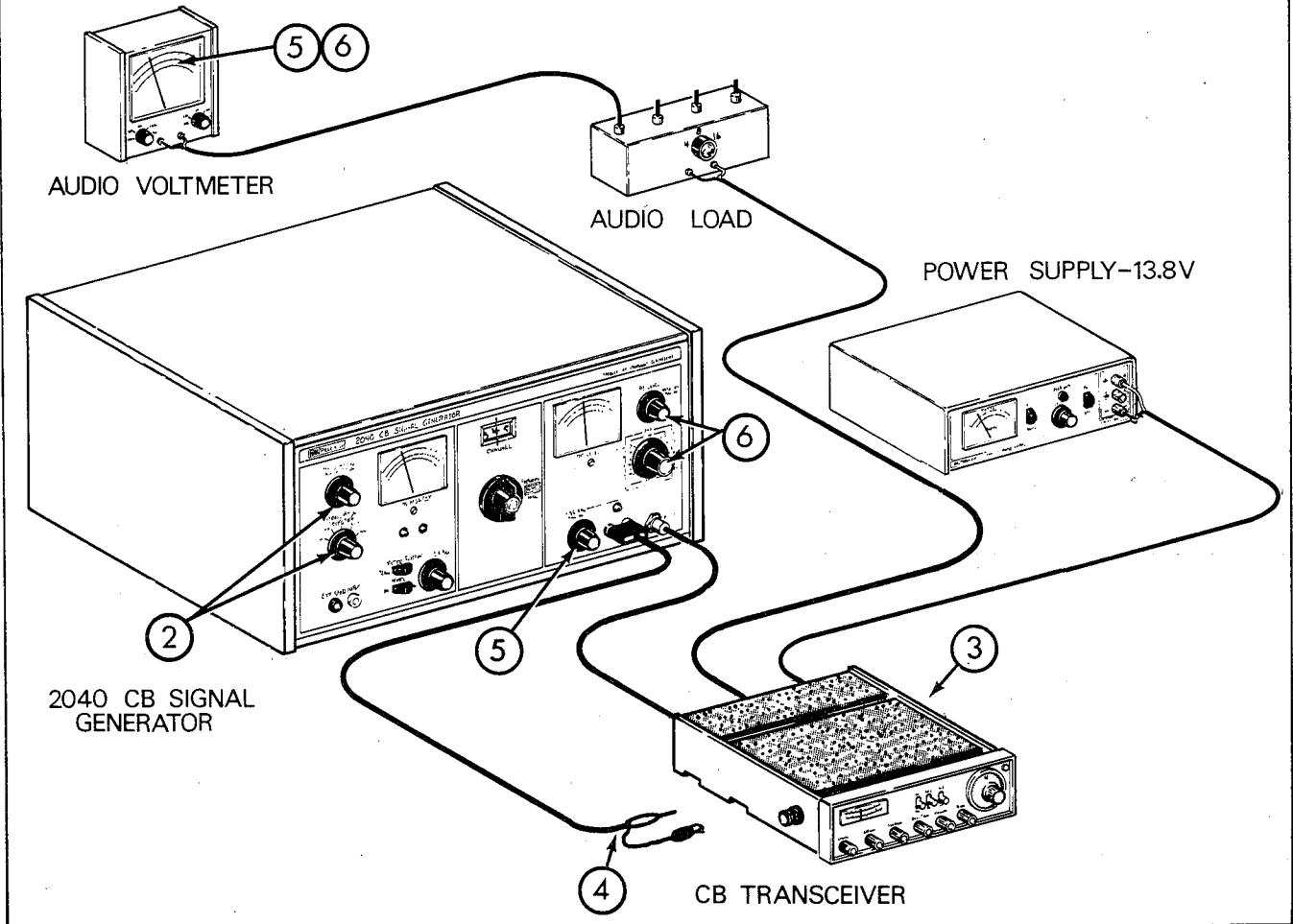

Fig. 19. CB Receiver Alignment.

CB RECEIVER ALIGNMENT (Refer to Fig. 19)

Use the transceiver manufacturer's procedure for receiver alignment, using the CB Signal Generator as directed in the alignment procedure. If it is possible to obtain any output from the receiver with an antenna injected RF signal, there is no need to inject a 455 kHz signal except to verify the accuracy of the synthesizer frequency as described in the previous check. Most alignment procedures follow these general techniques and steps:

1. Connect test equipment and set controls of the CB Signal Generator and transceiver as shown in Fig. 5.
2. Set controls on the CB Signal Generator for 1000 Hz, 30% modulation.
3. If an output is obtainable, perform the SYNTHESIZER FREQUENCY CHECK AND ADJUSTMENT

SYNTHESIZER FREQUENCY CHECK AND ADJUSTMENT and adjust the synthesizer on frequency.

4. If no output is obtainable, inject 455 kHz signal into the IF section of the receiver.
5. Align the IF section of the receiver. Keep the RF signal or 455 kHz signal level at the lowest possible level that will still give a usable indication on the audio voltmeter.
6. As soon as the IF section is aligned sufficiently to pass signal injected at the antenna, remove the 455 kHz injection. Keep signal level low to prevent saturating amplifiers and obscuring tuning peaks.
7. Align the RF section of the receiver. Readjust the RF output of the signal generator to lower levels as alignment adjustments are peaked.

TROUBLESHOOTING CB TRANSCEIVERS

The B & K-Precision Model 2040 CB Signal Generator is invaluable in troubleshooting CB transceivers, especially receiver circuits. The 455 kHz and RF outputs of the signal generator may be injected in the signal substitution method of troubleshooting. In this method of troubleshooting, injection starts nearest the speaker and progresses stage by stage toward the antenna until no output is obtained. The point at which the injected signal fails to produce an output is the defective circuit. The signal generator may also be used with the signal tracing method of troubleshooting. With this method, the signal is injected at the antenna or any desired intermediate point and the presence of signal is checked by a voltmeter, oscilloscope, or some similar measuring device. Measurement starts at the point of signal injection and progresses stage by stage toward the speaker until no signal is measured. The stage at which the signal disappears is the defective stage.

THEORY OF OPERATION

The Model 2040 CB generator utilizes a phase-locked-loop circuit to generate 50 CB channels. These channels are selectable by a front panel switch which gives a more accurate and faster channel selection than a continuously tunable type generator. A unique feature of the 2040 is the ΔF mode in which the generator can be tuned ± 5 kHz from the center of each channel. The output signal can be amplitude-modulated by any of 3 internal oscillators or an external signal. The signal also can be attenuated by use of the attenuator and RF level control from 100mV rms to less than .1 μ V rms. Another unique feature of the 2040 is that an impulse noise generator is provided internally for noise blanker measurements. Refer to block diagram (Fig. 20) and schematic diagram for references made in the theory of operation.

DETAILED THEORY OF OPERATION

PHASE LOCK LOOP

The heart of the 2040 is the phase lock loop circuit. Refer to the section labeled PLL of block diagram. Two frequencies are provided to the PLL section by the reference frequency section. One is the master frequency and the other is the mixer frequency. The voltage-controlled oscillator (VCO) operates at the desired channel output frequency. The VCO is mixed with the mixer frequency (20.48 MHz) and the difference is applied to the programmable divider. The programmable divider divides this difference frequency by a preset integer. The frequency from the programmable divider is applied to the phase/frequency detector. The other input to the phase/frequency detector is the master frequency, which is divided down to 5 kHz. The phase/frequency detector compares the frequency and phase of the two input signals and generates output pulses which indicate the phase and frequency difference of the two input signals. These pulses create an error voltage which is applied to the integrating low pass filter. This error voltage moves the VCO frequency so as to phase-lock the two incoming signals at the phase/frequency detector. To change the channel, all that is required is to change the divisor of the programmable divider. For example, at channel 1 the VCO is operating at 26.965 MHz which is mixed with the mixer frequency of 20.48 MHz and

the difference frequency of 6.485 MHz is applied to the programmable divider. For channel 1, the channel switch programs the divider to divide by 1297 which gives a 5 kHz input to the phase/frequency detector. Changing the divider ratio to 1299 by means of the channel switch will create an error voltage which so moves the frequency of the VCO that a 5 kHz signal appears at the phase/frequency detector. Therefore, the VCO frequency must move to 26,975, giving a 6.495 MHz output from the mixer which when divided by 1299 is 5 kHz. Expressed mathematically:

$$f_{VCO} = f_{(mixer)} + (N) f_{(master)}$$

where f_{VCO} is the VCO output frequency (channel frequency); $f_{(mixer)}$ is the doubled 10.240 MHz signal from the VCXO (see schematic); N is the programmable divider ratio set by the channel switch; and $f_{(master)}$ is the 5 kHz reference, derived from the 10.240 master frequency oscillator.

ΔF CIRCUIT

The 2040's ΔF capability permits tuning the VCO output over the range of ± 5 kHz from the center of the frequency set by the channel switch.

The 10.240 MHz signal, which is doubled and then used as $f_{(mixer)}$, is generated by a voltage-controlled crystal oscillator (VCXO). This is a very stable oscillator whose output frequency can be varied slightly by applying a DC control voltage. This control voltage can come from two sources. When the ΔF capability is not being used (ΔF switch off), the VCXO is part of another phase-locked-loop circuit. The output frequency of the VCXO is compared by a phase/frequency detector with the 10.240 MHz master frequency. The phase/frequency detector generates output pulses which indicates the difference in phase and frequency between VCXO output and the master frequency. These pulses are sent through a low pass filter and this gives a DC error voltage proportional to the phase and frequency difference. The error voltage is the control voltage for the VCXO. It moves the output frequency of the VCXO until it matches, in phase and frequency, the 10.240 MHz master oscillator.

Therefore, in the non- ΔF mode, the two crystal oscillators (VCXO and master frequency oscillator) are "locked" together.

When the ΔF capability is being used (ΔF switch on), the VCXO control voltage comes from a voltage divider whose output is varied by the ΔF control. The ΔF control now can vary the VCXO output frequency around a center frequency of 10.240 MHz. The VCXO frequency is doubled and used as the mixer frequency in the channel frequency PLL circuit. Therefore, if the VCXO frequency is changed slightly, the VCO frequency will also have to change slightly to keep the VCO phase-locked with the master frequency. This is how the ΔF control varies the output frequency of the Model 2040.

ΔF METER

The amount the VCO output frequency is varied from the center frequency is given by the ΔF meter. The pulses generated by the phase/frequency detector in the ΔF PLL circuit are filtered and amplified and then applied to a frequency-to-voltage converter. The further the VCXO

frequency is from the master frequency, the greater the frequency of the pulses from the phase/frequency detector, and the larger the voltage out from the frequency-to-voltage converter. This voltage drives the ΔF meter. In addition, the error pulses are used to turn on the appropriate ΔF LED.

OVEN CIRCUIT

In order to provide the outstanding frequency stability of the Model 2040, the reference crystal oscillators are kept in an "oven" which maintains a temperature of approximately 65°C. The oven and the oven control circuits are always on as long as the AC power cord is plugged in, whether or not the Model 2040 power switch is on.

AUDIO CIRCUITRY

The Model 2040 contains three low-distortion audio oscillators, factory-set at 400 Hz, 100 Hz, and 2.5 kHz ($\pm 3\%$). Any of these, or an external audio signal, can be switched to the input of a buffer amplifier whose output goes to the RF level amplifier. The output of the audio buffer amplifier also inputs to an AC-to-DC converter. The DC output from this converter is proportional to the peak-to-peak level of the audio signal, and this DC output drives the % MOD meter.

RF OUTPUT CIRCUITRY

The RF level amplifier provides a DC signal to control the RF output level of the final modulation stages of the Model 2040. This DC signal is set with the RF level pot. The DC signal also drives the RF level meter.

In addition, the RF level amplifier further amplifies the audio signals from the audio buffer amplifier to provide a large enough audio signal level for the modulation stage.

The RF output from the VCO and VCO buffer is fed into the modulator. If no audio signal is added (modulator selector switch in CW position), the RF signal is amplified and fed into the input of the attenuator assembly.

As mentioned above, the output level of the modulator is controlled by the DC signal from the RF level amplifier. If an audio signal is added (modulator selects switch in 400, 1000 or 2500 Hz, or ext. position with ext. signal), the modulator will output an AM signal, the carrier at the VCO output frequency, the modulation at the audio frequency. The percent of modulation is controlled by the mod. amplitude pot, a voltage divider at the output of the audio buffer amplifier.

ATTENUATOR

The final stage of the Model 2040 is the precision attenuator which provides a calibrated RF output level from 1 μ V to 100mV in 10dB steps. The attenuator is a set of four attenuator pads, each contained in its own shielded compartment. The attenuator pads are 10dB, 20dB, 30dB, and 40dB, determined by a network of precision resistors. Various pads are switched into series with the RF signal from the modulator to provide the required dB's of attenuation, from no pads (0 dB attenuation) to all four (10+20+30+40 = 100 dB of attenuation).

The switching is done by a cam and microswitch arrangement, turned by the attenuator control.

NOISE GENERATOR

Also contained within the attenuator assembly is a standard EIA noise signal source. This is a circuit that generates pulses of 1 μ SEC width, and repetition rate of 100PPS. The rise/fall time of the pulse is less than 10 nSec. The noise generator output is fed directly to the RF output connector, along with any RF signal. The noise generator is disabled by the noise generator switch, which grounds a control line.

A protective circuit of clamping diodes provides burnout protection for the attenuator assembly.

455 KHZ

The Model 2040 contains a 455 kHz crystal oscillator to provide a source for IF adjustment of CB transceivers. The output level of the 455 kHz signal is variable, and the 455 kHz signal can be modulated. The modulation signal comes from the output of the audio buffer amplifier, allowing a 400 Hz, 1000 Hz, 2000 Hz or external modulation frequency. The percent modulation is a constant (not adjustable) 30%.

CALIBRATION PROCEDURE

EQUIPMENT REQUIRED

1. RF millivoltmeter, good down to 5mV, $\pm 1\%$ (such as Boonton Model 92BD).
2. Exact 50 Ω termination for RF millivoltmeter.
3. Frequency counter; 28 MHz, 1 PPM accuracy.
4. Oscilloscope; 28 MHz with X10 Probe. (B & K-Precision Model 1474).

PROCEDURES (Refer to Fig. 21 for adjustment locations)

- A. RF output level adjust.
 1. With POWER OFF, zero RF LEVEL meter with meter adjust screw.
 2. Turn POWER ON.
 3. Set:
 - a. MODULATION SELECTOR to CW position.
 - b. ΔF OFF.
 - c. CHANNEL 19.
 - d. 455 kHz OFF.
 - e. RF LEVEL full CCW.
 - f. NOISE GEN. OFF.
 - g. Attenuator to 100 K μ V position.
 4. Connect RF millivoltmeter, terminated in 50 Ω , to RF output connector of Model 2040.

5. Adjust trimpot R70 for a minimum reading on RF millivoltmeter.
6. Turn RF LEVEL to 3 o'clock position.
7. Turn attenuator to 10 K μ V position.
8. Adjust R39 for a reading on the RF millivoltmeter of 10.0 mV.
9. Adjust R46 for a reading of exactly 1.0 on the RF LEVEL meter.

B. Modulation adjustment (with cover off).

1. Set:
 - a. POWER ON.
 - b. MODULATION SELECTOR to CW position.
 - c. METER FUNCTION switch to % MOD.
 - d. Δ F OFF.
 - e. CHANNEL 19.
 - f. 455 KHZ OFF.
 - g. MODULATION AMPLITUDE to 4 o'clock position.
 - h. Attenuator in 100 K μ V position.
2. Zero % MOD./ Δ F meter with meter adjust screw.
3. Connect RF out to scope with X10 probe.
4. Adjust RF LEVEL for approx. 0.7 on the RF LEVEL meter.
5. Connect frequency counter to brown wire going to outer shield box. (Last feed-thru cap on shield box when facing front of unit.)
6. Turn MODULATION SELECTOR to 400 Hz.
7. Adjust R10 for a frequency of 400 Hz, \pm 4 Hz.
8. Adjust R13 for a 100%-modulated waveform on the scope.
9. Turn MODULATION AMPLITUDE pot CCW, until the scope shows a 50%-modulated waveform.
10. Adjust R50 for a reading of 50 on the % MOD. meter.
11. Turn MODULATION SELECTOR to 1000 Hz.
12. Adjust R19 for a frequency of 1000 Hz, \pm 5 Hz.
13. Adjust R22 for a reading of 50 on % MOD. meter.
14. Turn MODULATION SELECTOR to 2500 Hz.
15. Adjust R28 for a frequency of 2500 Hz, \pm 5 Hz.
16. Adjust R31 for a reading of 50 on % MOD. meter.

C. Frequency and Δ F adjustment.

1. Plug unit in and let it warm up at least 15 minutes.
2. Remove outer shield housing top, and inner shield housing top.
3. Set:
 - a. POWER ON.
 - b. MODULATION SELECTOR to CW position.
 - c. Δ F OFF.
 - d. CHANNEL 1.
 - e. RF LEVEL full CW.
 - f. NOISE GEN. OFF.
 - g. Attenuator to 100 K μ V position.
 - h. METER FUNCTION switch to Δ F.
4. Connect frequency counter to RF output.
5. Pull styrofoam cork out of styrofoam oven.
6. Adjust trimmer capacitor C307 for a frequency of from 26.96500 to 26,965015 MHz.
7. Replace oven cork.
8. Adjust R54 to zero % MOD./ Δ F meter.
9. Pull Δ F ON.
10. Adjust Δ F pot for the yellow (+) LED ON and a frequency of between 26.969950 and 26.970050 MHz.
11. Adjust R52 for Δ F meter reading of 5 kHz.

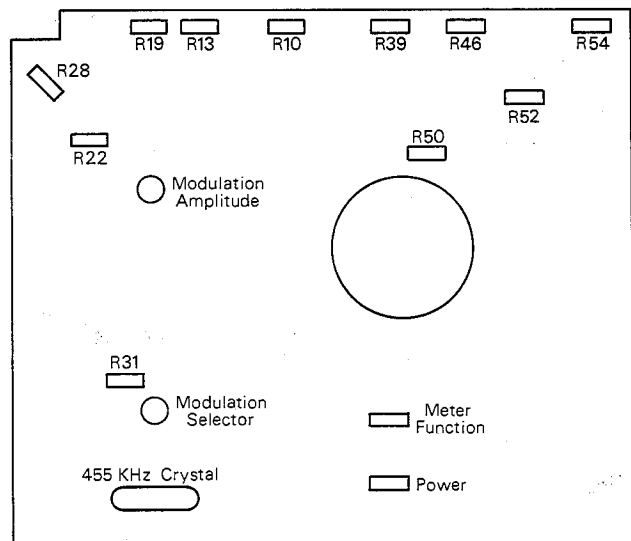

Calibration diagram.

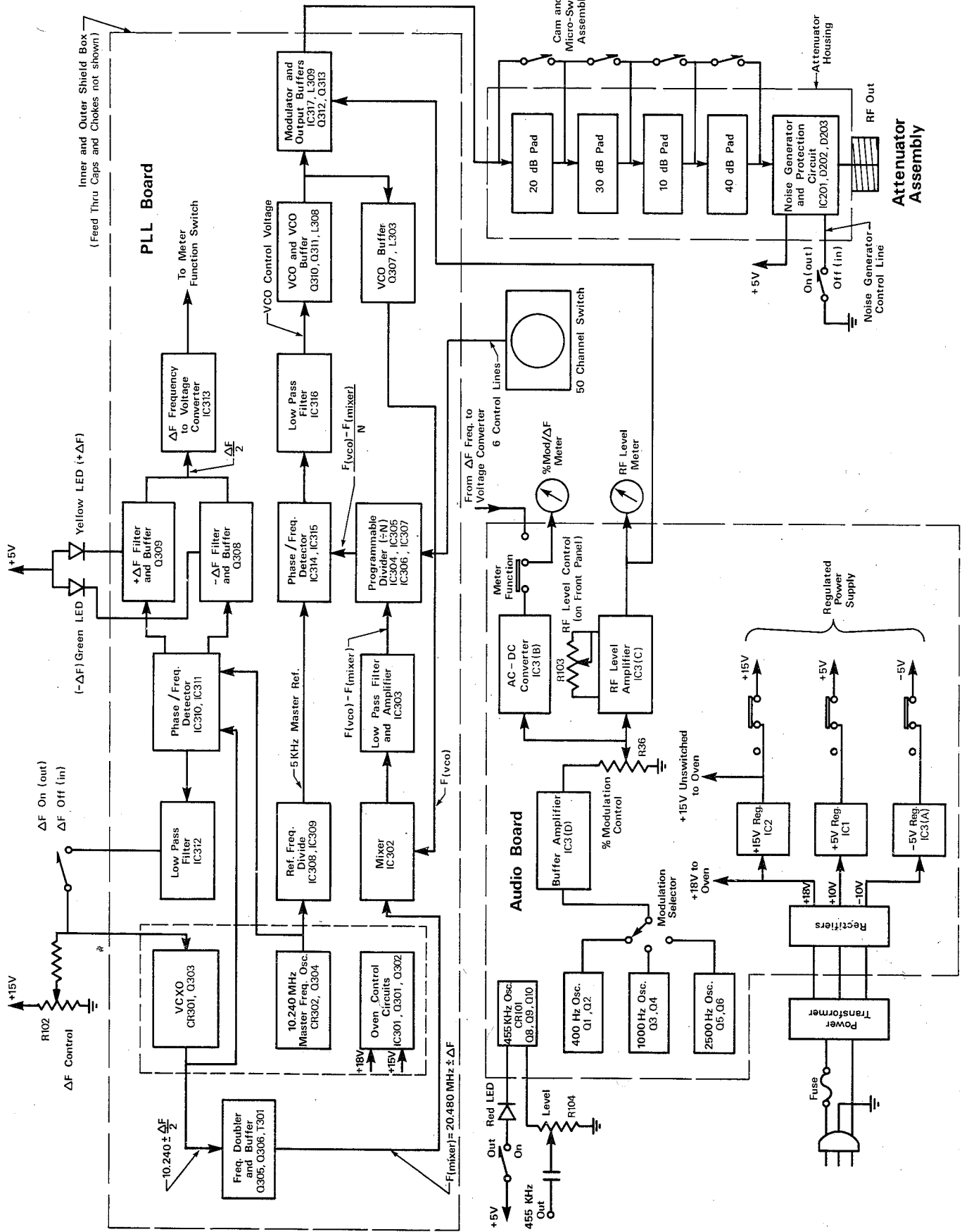

WARRANTY SERVICE INSTRUCTIONS

1. Refer to the MAINTENANCE section of your B & K-Precision instruction manual for adjustments that may be applicable.
2. Defective parts removed from units which are within the One Year Limited Warranty period, should be sent PREPAID to the Service Department listed below. Be sure to state the model and serial number of the unit from which the parts were removed and date the unit was purchased. These parts will be exchanged at no charge, under the terms of the Warranty.
3. If the above-mentioned procedures do not correct the problem you are experiencing with your unit, pack it securely (preferably in the original carton or double-packed). Enclose a letter describing the problem and include your name and address. Deliver to, or ship PREPAID (UPS preferred) to the nearest B & K-Precision authorized service agency (see list enclosed with unit).

If your list of authorized B & K-Precision service agencies has been misplaced, contact your local distributor for the name of your nearest service agency, or write to:

Service Department

B & K-Precision Product Group
DYNASCAN CORPORATION
2815 West Irving Park Road
Chicago, Illinois 60618



ONE YEAR LIMITED WARRANTY

DYNASCAN warrants that each product manufactured by it will be free from defects in material and workmanship under conditions of normal use and service for a period of one (1) year from the date of purchase from an authorized DYNASCAN distributor. DYNASCAN will, at its option, repair or replace any product or component not conforming with the foregoing warranty and which is returned, transportation prepaid, to our factory or our authorized service contractor. *DYNASCAN shall not otherwise be liable for any damages, consequential or otherwise.* DYNASCAN makes no other express warranties. *Any implied warranties (including any warranty of merchantability) are limited in duration to (1) one year from the date of purchase.* This warranty does not apply to (i) damage resulting from unauthorized alterations and repairs, misuse, negligency or accident; or (ii) damage resulting from improper installation, connection or adjustment otherwise than in accordance with DYNASCAN's authorized Instruction Manual. This warranty is void if the serial number has been altered, defaced or removed. DYNASCAN reserves the right to discontinue any model at any time or change specifications or design without notice and without incurring any obligation. To register this warranty, the enclosed DYNASCAN warranty registration card should be completed and mailed to DYNASCAN CORP., 6460 W. Cortland Street, Chicago, Illinois 60635, within ten (10) days after date of purchase.