



**RV75**

**SYNTHESIZED  
REMOTE VFO**

**OPERATOR'S MANUAL**



©R. L. DRAKE COMPANY 1982

PRINTED IN U.S.A.



## TABLE OF CONTENTS

PAR. #	DESCRIPTION	PAGE
CHAPTER I	INTRODUCTION .....	1-1
1-1	General Description .....	1-1
1-2	Specifications .....	1-2
1-3	Accessories .....	1-2
CHAPTER II	INSTALLATION .....	2-1
2-1	Unpacking .....	2-1
2-2	Location .....	2-1
2-3	Internal Programming .....	2-1
2-4	Equipment Interconnection .....	2-2
CHAPTER III	OPERATION .....	3-1
3-1	Front Panel Controls .....	3-1
3-2	Fixed Frequency Programming .....	3-3
3-3	7-Line Programming .....	3-5
3-4	5-Line Programming .....	3-7
3-5	Performance Checks .....	3-9
CHAPTER IV	THEORY OF OPERATION .....	4-2
4-1	Block Diagram Description .....	4-2
4-2	Digital Board Description .....	4-5
4-3	RF and Analog Board Description ....	4-10
4-4	Fixed Board Description .....	4-13
CHAPTER V	MAINTENANCE .....	5-1
5-1	Service Information .....	5-1
5-2	General .....	5-1
5-3	Test Equipment Requirements .....	5-2
5-4	Disassembly and Assembly Procedures .....	5-3
5-5	Alignment Procedures .....	5-5

## LIST OF ILLUSTRATIONS

FIGURE	DESCRIPTION	PAGE
3-1	Front Panel Controls .....	3-1
3-2	Rear Panel Switches .....	3-3
3-3	7-LINE Programming Example .....	3-5
3-4	5-LINE Programming Example .....	3-8
4-1	Block Diagram .....	4-1
5-1	Test Cable Schematic .....	5-3
5-2	Test Waveforms .....	5-9
5-3	Digital Board Pictorial .....	5-15
5-4	RF and Analog Board Pictorial .....	5-16
5-5	Fixed Programming Board Schematic .....	5-17
6-1	Digital Board Schematic .....	*
6-2	RF and Analog Board Schematic .....	*

\* inside pocket in back of manual



## I. INTRODUCTION

### 1-1 GENERAL DESCRIPTION

The RV-75 is a synthesized remote VFO designed for use with all 5-Line and 7-Line transceivers and receivers. The RV-75 provides a high degree of frequency control flexibility with crystal controlled frequency stability. The RV-75 output frequency is synthesized in 10 Hz increments for smooth frequency control without jumps and the weighted flywheel of the optical shaft encoder provides a smooth, solid feel.

The unique "Variable Rate Tuning Oscillator\*" circuitry of the RV-75 provides a versatile and easy to use tuning method. When rotating the tuning knob slowly, the 2 kHz/rev. tuning rate allows very precise frequency setting. As the rate of rotation increases, the tuning rate increases linearly up to 25 kHz/rev. or higher if desired. The higher tuning rate allows smooth and rapid frequency changes without requiring a separate control for tuning rate. The smooth increase in tuning rate while still maintaining a 10 Hz resolution avoids "jumping" over desired signals.

The RV-75 also provides for two fixed frequencies in addition to the tuned frequency. The fixed frequencies are programmed by switches accessible from the rear panel. The 750 kHz tuning range provides generous overtravel of the band edges. The "RIT" function allows the receiver to be offset from the transmitter at least +/- 200 Hz.

\*Patented



## 1-2 SPECIFICATIONS

Output Frequency:	4850.00 kHz to 5600.00 kHz
Frequency Coverage:	7-LINE 200 kHz below to 50 kHz above even 500 kHz points — e.g. 13800.00 kHz to 14550.00 kHz
	5-LINE 150 kHz below to 100 kHz above even 500 kHz points — e.g. 13850.00 kHz to 14600.00 kHz
	NOTE: Unless an additional range crystal is used on the TR-5, 29.6 to 29.7 MHz cannot be tuned with the RV-75.
Freq. Stability/Temp:	+/- 15ppm from +5 to +55 deg. C
Freq. Stability/Time:	No more than +/- 50 Hz change during the first hour. No more than +/- 25 Hz/hr. after the first hour.
Tuning Rate:	2 kHz/revolution to 25 kHz/rev. depending upon tuning rate
Frequency Resolution:	Tuned in 10 Hz increments
Power Requirements:	11-16 VDC — supplied by transceiver or receiver
Dimensions:	
Depth:	13 in. (33 cm.) excluding knobs
Width:	6.8 in. (17.3 cm.)
Height:	4.5 in. (11.5 cm.) excluding feet
Weight:	3.6 in. (1.63 kg.)

## 1-3 ACCESSORIES

The 1544 Adapter Kit available from the R. L. Drake Company is required if the RV-75 is to be used with the R-7(A) or the R-7(A)/TR-7(A) combination.



## II. INSTALLATION AND SET UP

### 2-1 UNPACKING

Carefully remove the RV-75 from the shipping carton and examine the unit for evidence of damage. If any damage is discovered, immediately notify the transportation company responsible for delivery or return the unit to the dealer from whom it was purchased. Keep the shipping carton and all packing material for inspection by the transportation company or the dealer. Keeping the packing material in any case is recommended as shipment of the unit is much easier should it ever be necessary to return the unit for service.

#### NOTE

Fill out the enclosed warranty card and return it to the R. L. Drake Co. within 10 days of purchase to insure registration and validation of the warranty.

Before proceeding with hook-up, it is strongly recommended that the operator become familiar with the sections of this manual covering location, internal programming, interconnection, front panel controls, and the performance checks.

### 2-2 LOCATION

The RV-75 should be positioned for maximum operator convenience. The location of the RV-75 is not critical however, placement adjacent to or on top of any power supply is not recommended.

### 2-3 INTERNAL PROGRAMMING

For operator convenience and compatibility between 7-LINE and 5-LINE equipment, the power-up frequency, the frequency change versus tuning knob rotation, and the frequency change versus RIT control rotation are preset at the factory but can be changed.



The reprogramming is accomplished by reversing jumper plugs on the P.C. cards within the RV-75. The following chart lists the functions of the RV-75 as supplied from the factory and the options available to the operator.

	7-LINE	5-LINE
Initial freq. at power on as supplied	XX.250 kHz	XX.155 kHz
with J-107 reversed	XX.150 kHz	XX.255 kHz
with J-107 removed	XX.050 kHz	XX.355 kHz
Clockwise rotation of the tuning knob causes displayed frequency to:		
as supplied	increase	decrease
with J-104 reversed	decrease	increase
Clockwise rotation of the RIT control causes receiver frequency to:		
as supplied	increase	decrease
with J-204	decrease	increase

Refer to figs. 5-3 and 5-4 for the locations of the connector plugs and to par. 5-4 for access to the P.C. boards.

## 2-4 EQUIPMENT INTER-CONNECTION

2-4.1 For connection to a 7-LINE transceiver, connect the 8-pin plug of the RV-75 to the jack labeled RV-7 on the rear of the transceiver. Connect the phono cable supplied from the jack labeled "RIT SWITCH" on the rear of the RV-75 to the 12-pin adapter plug that is supplied. Insert the adapter plug into the 12-pin socket on the rear of the transceiver labeled "ACCESSORIES". If the accessory connector is already being used, such as for a VLF antenna, cut the phono plug from one end of the phono cable, strip the outer insulation back about 1" from the end, twist the shield away from the inner insulator, and strip the inner



insulator back about 1/4" from the center conductor. Solder a 10K resistor, 1/4W or greater, from pin 1 to the center conductor and the shield to pin 3.

### **CAUTION**

Use tubing or plastic tape over the shield and resistor to prevent contact with other pins of the accessory plug or damage will occur to circuitry within the transceiver.

2-4.2 For connection to a 5-LINE transceiver, connect the 8-pin plug from the RV-75 to the jack on the rear of the transceiver labeled RV-5/75. Connect the phono cable supplied from the jack on the rear of the RV-75 labeled "RIT SWITCH" to the jack on the rear of the transceiver labeled "EXT. MUTE".

2-4.3 Connection to a 7-LINE receiver or the TR-7(A)/R-7(A) combination requires the use of the R-7/RV-75 Adapter Kit Model 1554. Refer to the instructions enclosed with the Adapter Kit for the various interconnect options.

### III. OPERATION

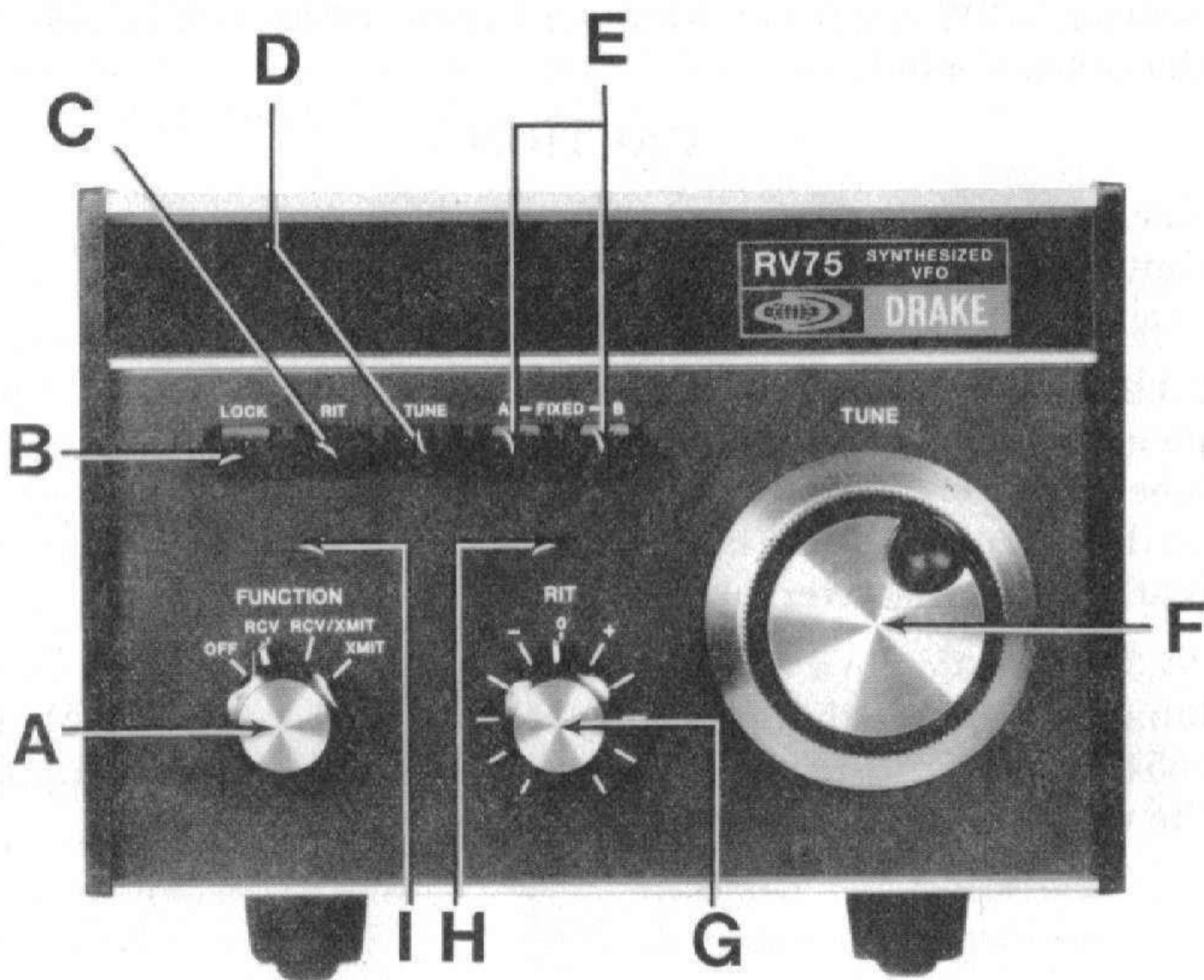

Figure 3-1 Front Panel Controls

#### 3-1 FRONT PANEL CONTROLS

A. **FUNCTION SWITCH** — Enables the RV-75 and determines whether the RV-75 will control the frequency in receive, transceive or transmit.

B. **LOCK** — Disables the main tuning knob when depressed. The frequency will remain at the last frequency selected by the main tuning unless a **FIXED** button is depressed or the transceiver/receiver is turned off.



C. RIT — Receiver Incremental Tuning — Enables the RIT control to offset the received frequency from the transmit frequency at least  $\pm 200$  Hz when depressed. If a cable is not connected to the RIT SWITCH jack on the rear of the RV-75, the RIT is inoperative.

D. TUNE — Enables the main tuning knob to control the frequency when depressed unless the LOCK button is depressed.

E. FIXED A and FIXED B — Selects the output frequencies determined by the setting of the programming switches on the rear panel and 'locks' the main tuning knob. Refer to par. 3-2 for programming information.

F. MAIN TUNING KNOB — Adjusts the output frequency when the TUNE button is depressed and the LOCK button is not depressed. Refer to par. 2-3 for programming freq. change versus knob rotation and to par. 5-4 for top cover removal and 5-7.1 for variable rate adjustment.

G. RIT CONTROL — Varies the receive frequency in relation to the transmit frequency when the RIT pushbutton is depressed. Refer to par. 2-3 for programming frequency change versus knob rotation.

H. RIT INDICATOR — Lights when RIT pushbutton is depressed. Indicates that the transmit frequency may vary from the receive frequency.

I. POWER INDICATOR — Lights when the function switch is in any position but OFF. Indicates that the RV-75 will control the frequency in receive, transmit or both.

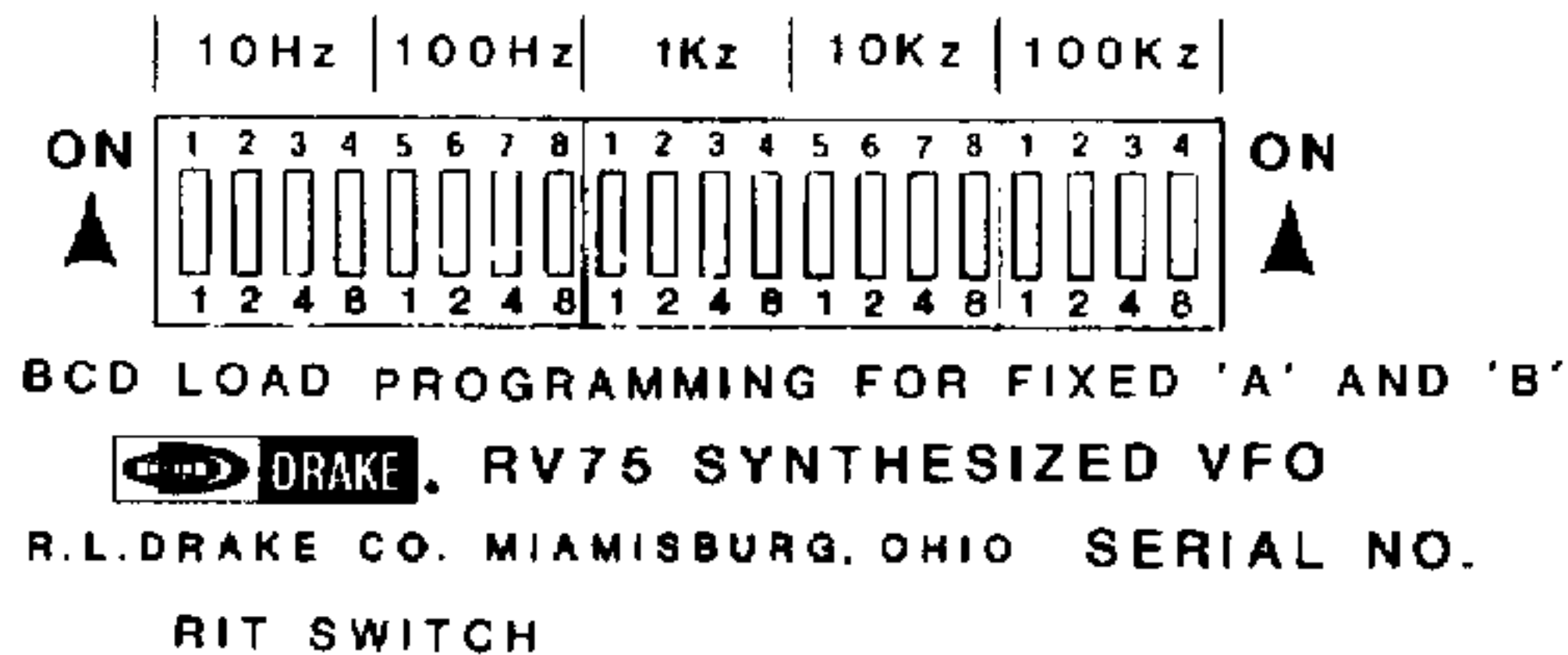
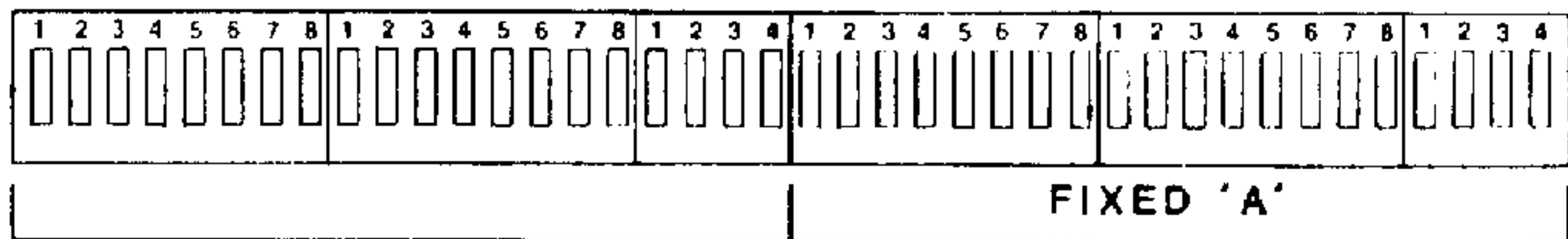

Figure 3-2 Rear Panel Controls and Connections

### 3-2 FIXED FREQUENCY PROGRAMMING

While following the discussion on fixed programming, refer to fig. 3-2 or to the rear panel of the RV-75. Fixed frequency programming is accomplished by setting the switches that are accessible from the rear panel. Note that the 40 switches are divided into two groups of 20, designated A and B. Each group of 20 switches programs one frequency from 100 kHz through 10 Hz. Each group of 20 switches is divided into 5 digits of four line Binary Coded Decimal (BCD) information. Each group of four switches is designated on the label with the frequency digit that each group controls.

Note that, on the label, each switch within the groups of four is designated across the top with the numbers 1 thru 8 or 1 thru 4 and across the bottom with the numbers 1, 2, 4, or 8. The numbers across the top are for switch identification only and correspond to the numbers imprinted above each switch. The top numbers may be used as an aid in locating appropriate switches. The numbers on the label below each switch are the BCD values for each switch within the group of four. In the remainder of this discussion



decimal values will be used. The decimal values of each group of four are the sum of the BCD values of all switches in the 'ON' or up position within each group of four.

Examples: decimal 9 = switches with BCD values 1 and 8 in the up position

decimal 7 = switches with BCD values 1, 2, and 4 in the up position

decimal 6 = switches with BCD values 2 and 4 in the up position

The decimal values in the remainder of this section will use conventional notation, that is, the most significant digit (100 kHz) to the left. When setting the switches, keep in mind that the most significant group of switches (100 kHz) is on the right.

The RV-75 determines the carrier frequency of the equipment to which it is connected. The digit readout on the equipment displays the carrier frequency. If CW or AFSK is to be used on a fixed programmed frequency and absolute frequency accuracy is required, the frequency programmed must compensate for the difference between the displayed frequency and the actual RF output frequency. The following procedures will detail the methods for programming and determining offset.

The first steps in programming are to select the desired frequency and mode. After selecting the frequency and mode, determine the band to be used and the lowest even 500 kHz point of that range such as 14000.00 or 35000.00kHz. Note that even though the least significant digit of the digital display is 100 Hz, the frequency will be programmed to 10 Hz. Be sure to include the 10 Hz digit when following the programming procedure. The steps for programming 7-LINE and 5-LINE equipment are different and will be detailed separately. If, after following either procedure, the BCD value obtained is less than 20000 or greater than 95000, an error has been made. Recheck calculations. After setting the switches, check the digital display to verify the frequency.



### 3-3 7-LINE FIXED FREQUENCY PROGRAMMING

- (1) Select the desired frequency and mode
- (2) Determine the range to be used and the lowest even 500 kHz point
- (3) Subtract 200.00 kHz from the lowest even 500 kHz point
- (4) Subtract the frequency at (3) from the desired frequency at (1). Ignore the decimal point.
- (5) Determine offset and direction. See NOTE 1
- (6) Add or subtract offset
- (7) Add 20000
- (8) Set the switches to the number obtained at step (7).

Examples:

<p><b>FIXED B = 14345.67 kHz USB</b></p> <ol style="list-style-type: none"> <li>(1) 14345.67</li> <li>(2) 14000.00</li> <li>(3) <math>14000.00 - 200.00 = 13800.00</math></li> <li>(4) <math>14345.67 - 13850.00 = 49567</math></li> <li>(5) USB = 00000</li> <li>(6) <math>54567 - 00000 = 54567</math></li> <li>(7) <math>54567 + 20000 = 74567</math></li> <li>(8) See fig. 3-3(a)</li> </ol>	<p><b>FIXED A = 3.615.50 kHz CW</b></p> <ol style="list-style-type: none"> <li>3615.00</li> <li>3500.00</li> <li><math>3500.00 - 200.00 = 3300.00</math></li> <li><math>3615.50 - 3300.00 = 31550</math></li> <li>CW = -00080</li> <li><math>31550 - 00080 = 31470</math></li> <li><math>31470 + 20000 = 51470</math></li> <li>See fig. 3-3(b)</li> </ol>
--	---

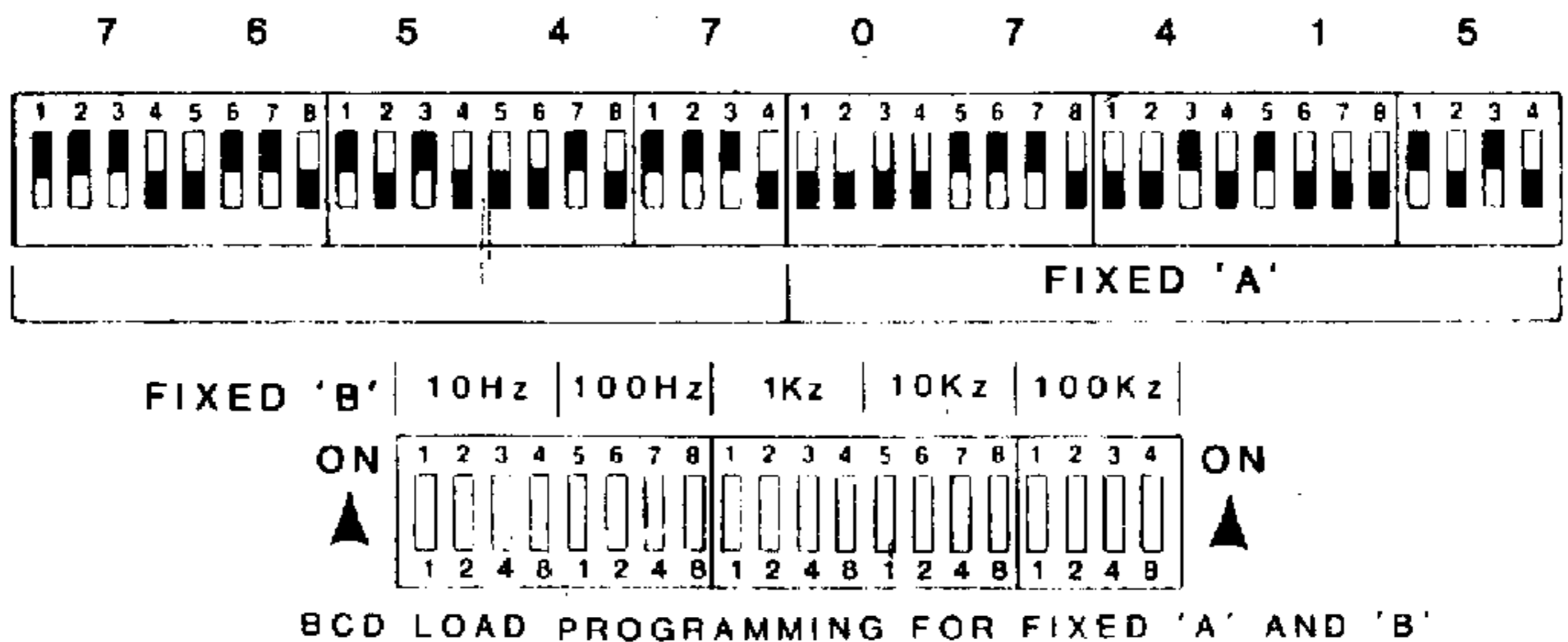

Figure 3-3 Programming For 7-Line



### Note 1

The offsets to the nearest 10 Hz are as follows:

AM, USB, or LSB 00000

CW minus (-) 00080

RTTY minus (-) the mark tone audio frequency to the closest 10 Hz, e.g. 1275 Hz would be -00127. If AFSK is being used on USB the offset would be plus (+).



### 3-4 5-LINE PROGRAMMING

As the 5-LINE employs a different IF scheme than the 7-LINE and range crystals for each band, the offset for each band and mode will be different. If frequent programming is anticipated, it is recommended that the offsets for each band and mode be determined and recorded in the space provided in the NOTES section. The procedure to determine offset is contained in steps (1) thru (6) of the following procedure.

- (1) Select the desired frequency, mode, and band.
- (2) Determine the lowest even 500 kHz point of the band to be used such as 14000.00 or 3500.00
- (3) Select FIXED A or B on the RV-75 and program the channel selected for decimal 80000.
- (4) Set the band and mode desired on the transceiver and energize the transceiver.
- (5) Record the displayed frequency.
- (6) Subtract the lower frequency at (2) and (5) from the higher frequency ignoring the decimal point. The amount of offset is the difference between the two frequencies to the closest 10 Hz. If the frequency at (5) is greater than the frequency at (2), the offset is (-) minus. If the frequency at (2) is greater than the frequency at (5), the offset is plus (+).
- (7) Subtract 150 kHz from the lowest even 500 kHz point (2)
- (8) Subtract the frequency at (7) from the desired frequency at (1).
- (9) Add or subtract the offset.
- (10) Subtract the number at (9) from 95000.
- (11) Set the switches to the number obtained at step (10).



### Examples:

FIXED B = 14345.67 kHz USB	FIXED A = 3615.50 kHz CW
(1) 14345.67 USB	3615.50 CW
(2) 14000.00	3500.00
(3) —	—
(4) —	—
(5) 14003.20	3496.10
(6) $14003.20 - 14000.00 = -00320$	$3500.00 - 3496.10 = +00390$
(7) $14000.00 - 150.00 = 13850.00$	$3500.00 - 150.00 = 3350.00$
(8) $14345.67 - 13800.00 = 54567$	$3615.00 - 3350.00 = 26550$
(9) $49567 - 00320 = 49247$	$26550 + 00390 = 26940$
(10) $95000 - 49247 = 45753$	$95000 - 26940 = 68060$
(11) see fig. 3-4(A)	see fig. 3-4(B)

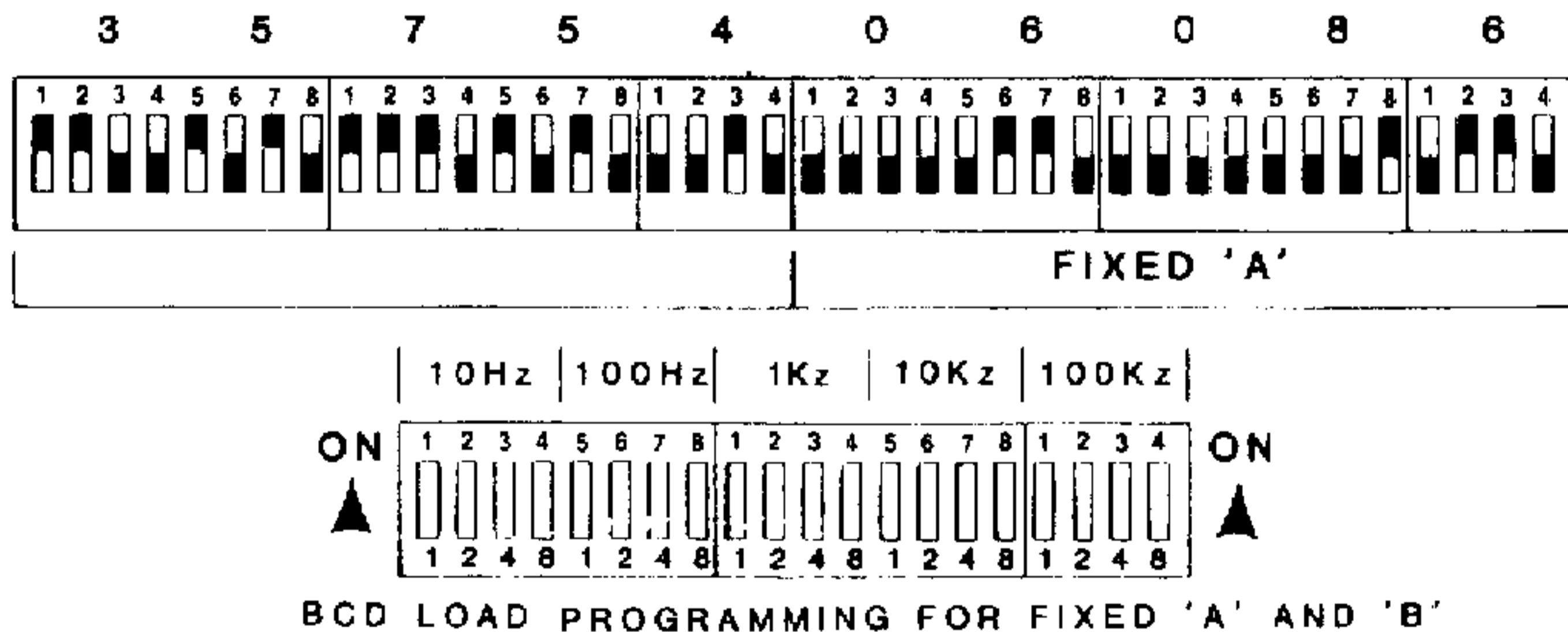

Figure 3-4 Programming For 5-Line



### 3-5 PERFORMANCE CHECKS

Prior to "on-the-air" use, it is recommended that the following performance checks be made to verify the proper operation of the RV-75 and to familiarize the operator with the controls and functions. In the following checks, it is assumed that the internal programming options are as supplied from the factory. Any terms or frequencies in parenthesis refer to operation with 5-LINE equipment if different than 7-LINE equipment.

Connect the RV-75 as indicated in par. 2-4 of this manual. Program the FIXED A switches for 20000 and the FIXED B switches for 95000. Turn the RV-75 function switch to OFF, center the RIT control, and depress the TUNE button. All other buttons should be out.

Set the transceiver bandswitch to 14 MHz, USB, turn the microphone gain and the carrier control fully CCW, and energize the equipment. The displayed frequency should be at the PTO setting of the transceiver. To verify that it is controlling the frequency; set the frequency to 14300.0 kHz.

Turn the RV-75 function switch to RCV. The yellow LED should light and the displayed frequency should be 14250.0 (14150.0 +/-10 kHz). Rotate the RV-75 main tuning knob slowly several revolutions clockwise. The displayed frequency should increase (decrease) smoothly 2 kHz per revolution. Rotate the tuning knob counter-clockwise. The frequency should decrease (increase) smoothly at 2 kHz per revolution. Stop turning the knob and note the frequency.

Depress the LOCK button. Rotate the tuning knob several revolutions in each direction. The frequency should not change. Depress the RIT button. The Green LED should light and the frequency should not change if the RIT control is centered. Rotate the RIT control fully CW. The displayed frequency should increase (decrease) at least 100 Hz. Rotate the RIT control fully CCW. The displayed frequency should decrease (increase) at least 100 Hz



from the frequency noted with the control centered. Return the RIT control to center.

Turn the RV-75 function switch to OFF. The displayed frequency should be 14300.00 kHz. Return the function switch to RCV. The frequency should be that which was noted prior to depressing the LOCK button. Depress the LOCK button to unlock.

Turn transceiver power off, wait a few seconds, and then turn power back on. The displayed frequency should be 14250.0 (14150 +/- 10 kHz). Depress the FIXED A button. The TUNE button should pop out and the displayed frequency should be 13800.00 kHz (14600.0 +/- 10 kHz). Rotate the RV-75 tuning knob several revolutions and then depress the TUNE button. The FIXED A button should pop out and the displayed frequency should be 14250.0 kHz (14150.0 +/- 10 kHz). Depress the FIXED B button. The TUNE button should pop out and the displayed frequency should be 14550.0 (13850.0 +/- 10 kHz). Rotate the tuning knob several turns and then depress the TUNE button. The FIXED B button should pop out and the displayed frequency should be 14250.0 kHz (14150 +/- 10 kHz).

Key the transmitter by depressing the key or the PTT. On 5-LINE transceivers do not use the LOCK KEY function. The displayed frequency should be 14300.0 kHz. Unkey the transmitter. The displayed frequency should be 14250.0 (14150.0 +/- 10 kHz). Place the RV-75 function switch in the RCV/XMIT position. The displayed frequency should not change. If using 5-LINE equipment, adjust the RV-75 tuning knob for 14250.0 kHz.

Rotate the RIT control for a frequency of 14250.1 kHz. Key the transmitter. The frequency should return to 14250.0 kHz. Rotate the RIT control from end to end to insure that the frequency does not change. Return the RIT control to center. Unkey the transmitter. Switch the RV-75 function switch to XMIT. The displayed frequency should be 14300.0 kHz. Key the transmitter. The frequency should be 14250.0 kHz. Rotate the RIT control and insure



that the frequency does not change. Unkey the transmitter and depress the RIT button to unlock.

Turn the function switch to RCV and note the frequency. Rotate the RV-75 tuning knob quickly one revolution. The frequency should change about 25 kHz. Rotate the tuning knob CW until the frequency will no longer increase (decrease). The frequency should be 14.550 MHz (13.850 MHz +/- 10 kHz). Rotate the tuning knob CCW until the frequency will no longer decrease (increase). The frequency should be 13.800 MHz (14.600 MHz +/- 10 kHz).

On any band, use the transceiver PTO and tune in a strong carrier or calibrator signal. Note the S-Meter reading. Turn the PTO in the direction that causes the audio tone to increase in frequency until the S-Meter drops 20 dB or 4 S-Units. Note the frequency. Switch the RV-75 to the RCV position and adjust the frequency for the same frequency and audio tone. Rotate the transceiver PTO several kHz either side of the signal. No change in the audio tone should be detectable while the RV-75 is selected and the transceiver PTO is varied. Switch the RV-75 to the XMIT position and adjust the transceiver PTO for the same audio tone. Rotate the RV-75 tuning knob several revolutions back and forth. No change in the audio should be detectable while the transceiver PTO is selected and the RV-75 is varied.

Place the RV-75 in the RCV function and select the widest selectivity filter in the transceiver. Slowly tune the RV-75 across the signal. Listen for any jumps or turn-around in frequency. It is normal to detect a slight 'tick' every 1/2 revolution.

If the procedure has been followed, all functions have been checked and the operator should be familiar with the controls and functions. One item should be emphasized at this point.

---

**WARNING**

---

Any time the equipment is energized, the operator should be aware of the position of the RV-75 function switch and the last frequency to which the RV-75 was tuned. Anytime the function switch is in the XMIT or RCV/XMIT position the RV-75 will control the transmit frequency. Any time the function switch is in the XMIT position the operator should know what the output frequency will be when the key or PTT is depressed. Lack of awareness may cause out-of-band transmission.

---

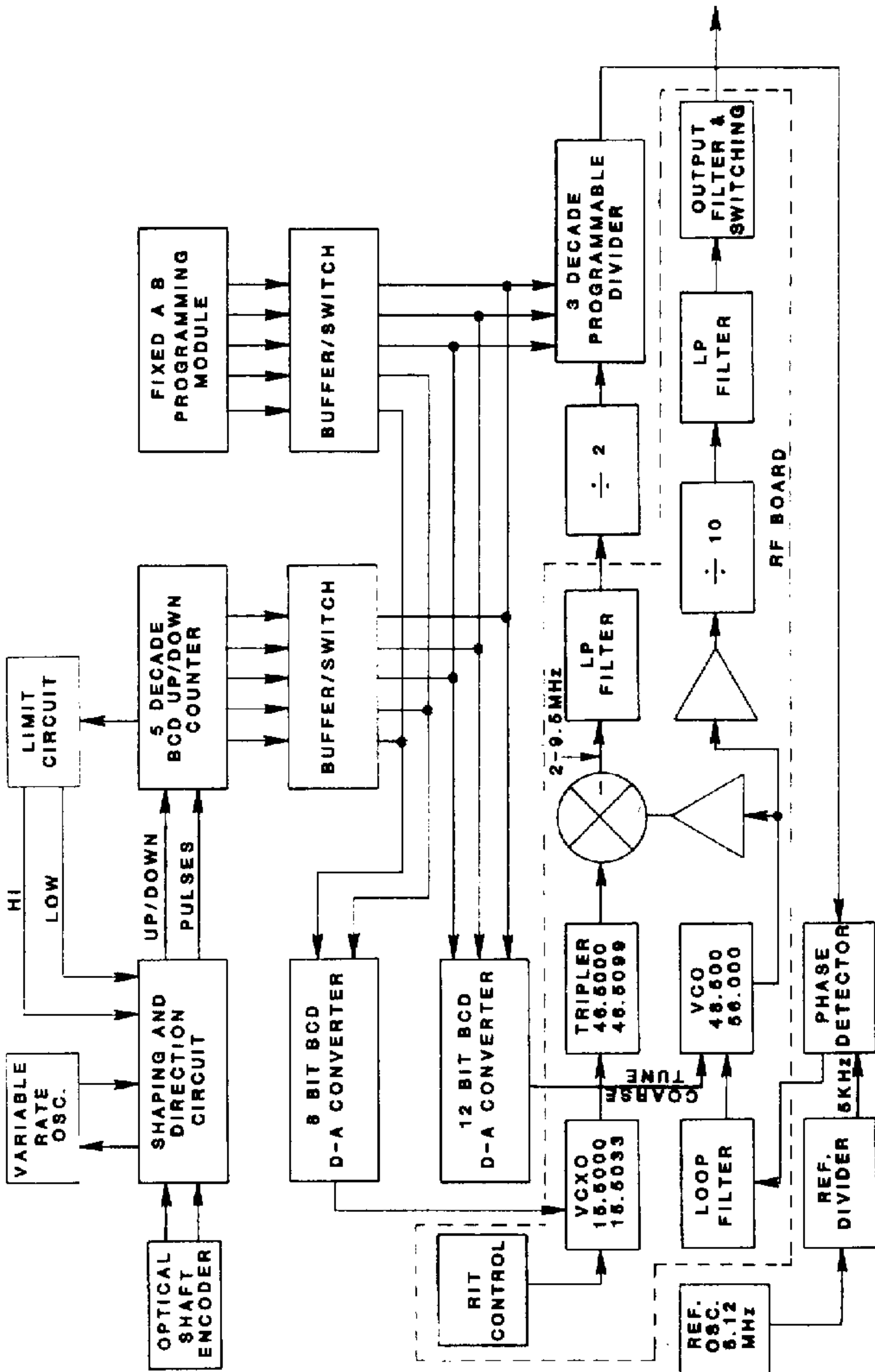

Figure 4-1 Block Diagram



## IV THEORY OF OPERATION

### 4-1 GENERAL

Refer to the block diagram fig, 4-1. The RV-75 output frequency can be determined by either the main tuning knob or the preprogrammed frequencies. The main tuning knob is connected to an optical shaft encoder that provides two pulse train outputs as the tuning knob is rotated. The two pulse trains are fed to the direction determining and pulse shaping circuits.

The direction determining circuit determines the direction of knob rotation from the phase difference between the two pulse trains. The outputs of the shaping and direction circuits are an up/down (clockwise/counter-clockwise) signal and pulses that are applied to the 5 decade up/down counter. The shaping circuit also determines the speed of knob rotation. As the rate of rotation increases, the variable rate oscillator is enabled which adds additional pulses to those generated from the shaft encoder inputs. The direction circuit also accepts inputs from the limit circuit and inhibits the pulses out when the RV-75 is at its upper or lower frequency limit.

The pulses cause the 5 decade up/down counter to increment or decrement depending on the state of the up/down control signal. The output of the counter is 5 digits of binary-coded-decimal (BCD) information. Each digit consists of 4 lines of information. The limit circuitry examines the BCD information and prevents the counter from incrementing above the upper limit or decrementing below the lower limit.

The 20 lines of output information from the decade counter are applied to the buffer/switch circuitry. The switches are devices that can either pass the information unchanged or can be turned off. When in the TUNE mode, the switches connected to the decade counter are turned on and the information applied to the digital-to-analog (D-A) converters and the programmable dividers comes from the 5 decade up/down counter. When in the fixed mode, the switches connected to the up/down counter are turned off, the switches from the fixed program module are turned on, and the information to the D-A converters and the programmable divider is supplied by the FIXED module.

The FIXED programming module consists of two sets of 20 switches and isolation diodes. The FIXED A and B switches determine which set of 20 switches is enabled.

The two least significant digits of information from either the 5 decade counter or the FIXED module are applied through the buffer/switches to the 8-bit D-A converter. The three most significant digits of information are applied through the buffer/switches to the 12-bit D-A converter and to the 3 decade programmable divider.

The D-A converters take the digital information at their inputs and generate an output voltage proportional to the value of the BCD input information. The 8-bit converter can generate 100 different voltages corresponding to 00 thru 99 BCD. The 12-bit converter can generate 1000 different voltages corresponding to 000 thru 999 BCD.



The output of the 8-bit converter is applied to the voltage controlled crystal oscillator (VCXO). The analog input voltage varies the VCXO frequency from 15.500 MHz to 05.5033 MHz. The frequency changes in 100 Hz steps of 33.3 Hz each. The VCXO also has an analog input from the RIT circuit. This control voltage will vary the frequency at least  $\pm 600$  Hz from the frequency set by the D-A input voltage. The VCXO output is tripled to 46.5000-46.5099 MHz  $\pm 2$  kHz depending upon the RIT circuit. If the RIT is not enabled, the output will be 46.5000 MHz for a BCD input of 00 to the 8-bit D-A and 46.5099 MHz for a BCD input of 99.

The output of the tripler is applied to one input of a mixer. The other mixer input is supplied by the voltage controlled oscillator (VCO). The VCO is tuned over the range of 48.5 MHz to 56.0 MHz by two input voltages. The coarse tune input from the 12-bit D-A converter tunes the VCO close to the desired output frequency. The control line input from the loop filter "locks" the VCO to the exact frequency. The VCO output is buffered and applied to the mixer and to the divide-by-ten.

The output of the mixer is a signal within the 2.0 MHz to 9.5 MHz range. The mixer output is filtered and applied to a divide-by-two prescaler. The prescaler output is fed to the programmable divider. The divide-by number is set by either the 3 most significant digits of the 5 decade up/down counter or by the switches on the FIXED module. The divide-by or load number will be between 200 and 950. The output of the programmable divider is fed to one input of the phase detector.

The other input to the phase detector, the reference input, is a 5 kHz signal derived from a stable 5.12 MHz crystal oscillator. The output of the crystal oscillator is divided by 1024 to generate the 5 kHz signal. The phase detector generates an output control voltage proportional to the frequency or phase difference between the two inputs. If the frequency from the programmable divider is greater than 5 kHz, the voltage out of the phase detector will decrease causing the VCO frequency to decrease until the divider



output is 5 kHz. The output voltage will increase if the output of the programmable divider is less than 5 kHz. If the output of the divider is 5 kHz, the voltage from the phase detector will not change. The loop filter removes any 5 kHz signals on the control line and sets the synthesizer lock-up time.

The VCO output is buffered and applied to a divided-by-ten. The output of the divider is filtered to remove the high frequency components. After filtering, the signal is enabled or disabled depending upon the function selected and whether the transceiver is in the transmit or receive mode.

## 4-2 DIGITAL BOARD

Refer to the Digital Board schematic, fig. 6-1, located in the pocket inside the rear cover of this manual. The Digital Board contains all of the control circuitry, the counters and dividers, the reference oscillator, and the phase detector.

### Shaping and Direction Circuitry

The shaping and direction determining circuitry is comprised of U-101, U-102, U-103, U-105A, and the components associated with these devices. Optical switches U1 and U2 contain an LED and a photo-transistor with a slot for the encoder disc between the source and the detector. As the tuning knob is rotated, the encoder disc alternately blocks and passes the light. When light passes through the disc, the photo-transistor turns on and the voltage at P-102 pins 1 or 8 will go low. R-101 and R-105 adjust the current through the photo-transistor so that the outputs of the Schmidt trigger buffers, U-101A and U-101B, are symmetrical square waves. The outputs of U-101A and U-101B are connected through reversing plug P-104 to the exclusive NOR gate U-105A. If the signals from the optical switches are 90 degrees out of phase, the output of U-105A will be a pulse train with a 50% duty cycle at twice the frequency of the optical switch input signals. The spacing between the optical switches is mechanically adjustable to set the phase relationship.



The output of U-105A is differentiated by C-101, R-107, and R-108 and applied to U-101D which generates narrow spikes from the differentiated waveform. The output of U-101D is connected thru R-119, R-110, and R-124 to the clock input of the first counter of the 5 decade up/down counter chain.

The outputs of U101A and B are also connected through P-104 to U-101C and J-K flip-flop U-102. If plug P-104 is in the position shown on the schematic and if the tuning knob is rotated clockwise, the rising edge of the square-wave at U-102 pin 3 will occur while U-102 pin 6 is high and U-102 pin 5 is low. If the 5-decade counter chain is not at it's upper limit, indicated by U-102 pin 4 being low, then the Q output at pin 1 will be high. If the knob is rotated CCW and the counter chain is not at it's lower limit, indicated by U-102 pin 7 being low, then the rising edge of the square-wave at pin 3 occurs while pin 6 is low and pin 5 is high. The Q output will be low. The Q output is connected through R-118 to the up/down control pins of the counters.

The square wave at U-102 pin 3 is also differentiated by C-102 and R-109 and fed to buffer U-101E. The narrow spikes from U-101E are inverted, rectified by CR103, and filtered by C-103. The voltage of TP-5 is a DC level proportional to the rate of rotation of the main tuning knob. When the voltage reaches about 3.5 VDC, Q-102 will start conducting and enable the astable multivibrator U-103 which generates pulses in addition to those generated by U-101D. The faster the tuning knob is rotated, the greater the voltage at TP-5. As Q-102 conducts more current, U-103 generates a greater number of pulses, and the tuning rate increases. R-115 determines the rate of rotation at which Q-102 begins to conduct.

When the LOCK or either of the FIXED switches is depressed, Q-101 turns on and prevents any pulses from being generated.



## Five Decade UP/DOWN Counter And Limit Circuits

The up/down counter chain is comprised of U-106 through U-110. Each device is a programmable BCD up/down counter. The voltage at pin 10 controls the counting direction. When pin 10 is high, the counters count up. If pin 10 is low, the counters count down. The clock inputs for each counter are pins 5 and 15. Pin 7 is the carry/borrow output. When counting up, a pulse will be generated at pin 7 when the counter increments from 9 to 0. The carry pulse causes the following counter to increment one count. When counting down, a borrow pulse is generated when the counter decrements from 9 to 0. The borrow pulse causes the following counter to decrement by one count. The counters are presettable. When pin 1 is high, whatever is present at the 'P' inputs will be latched at the 'Q' outputs. When power is applied, the charging current through C-107 generates a positive pulse that is applied to pin 1 of each device. U-106, U-107, and U-108 will be preset to 0. U-109 will be preset to 5. Depending upon the position of P-107, U-110 will be preset to either 4, 5, or 6.

The limit circuit is comprised of U-104 and U-105B, C, & D. When both inputs of an exclusive NOR gate are in the same state, the output is high. When the counter chain is in the count down mode. U-104A pin 1 will go high when the counter attempts to count from 20000 to 19999. When U-104A pin 1 goes high, the output of U-102 is forced to go high regardless of the J and K inputs and the counter chain will increment back to 20000 on the next clock pulse. Continuing to attempt to tune the counter chain lower will cause the counter chain to alternate between a count of 19999 and 20000. In the count up mode, the output of U-104B will go high at a count of 95000. When U-104B pin 13 is high. The output of U-102 is forced low and the counter will count back down.

### Buffers/Switches

The buffer/switches, U-111 thru U-117 provide the switching between the up/down counter and the fixed programming board, and also drive the D-A converters and programmable divider. The device outputs can be placed in a high impedance state by a logic 1 or high on the control pins, 1 or 15. When in the TUNE position, the control pins of the buffers connected to the 5 decade counter are pulled low by the switch, and the inputs to the D-A converters and programmable divider follow the BCD information from the up/down counter. When either FIXED button is depressed, the TUNE button will pop out, the TUNE control line will be pulled high by R-129, and the control pins of the devices connected to the FIXED board connector will be pulled low by the switch. The BCD information to the D-A converters and programmable divider will come from the FIXED board via P-101.

### Digital-to-Analog Converters

The 8-bit converter is comprised of resistors R-134 thru R-141. The 12-bit converter is comprised of resistors R-142 thru R-156. The operation of both converters is identical except for the number of bits. The operation of the 8-bit converter will be detailed. All resistors in the converter are connected to a common point, the output. The other end of each resistor is tied to an output of a buffer/switch. When a bit is low, the resistor is connected via the buffer/switch to GND. When a bit is high, the resistor is connected via the buffer/switch to +9V. For each BCD value, a unique combination of resistors will be connected in parallel to +9V and to GND. If the output of the up/down counter or the FIXED board were xxx81, R-141 and R-134 would be in parallel and connected to +9V. All other resistors would be connected in parallel to GND. The voltage at the common point would be determined by the voltage divider formed by the parallel combination of R-141 and R-134 connected to the supply and the other 6 resistors in parallel and connected to GND. The resistor values are in a BCD sequence so that the output voltage is directly proportional to the BCD value of the digital inputs.



### Programmable Divider

The programmable divider is comprised of amplifier Q-103 and dividers U-118, U-119, and U-120. The amplifier input is the 2-9.5 MHz IF signal from the RF board. The signal is amplified and applied to the TTL flip-flop, U-118, connected as a divide-by-2. The output frequency of U-118 is 1/2 of the input. R-161 pulls the output up to 9V to insure a good level for the programmable divider. U-119 and U-120 are BCD programmable dividers. The divider chain will divide the input signal by the BCD number at the program inputs. As an example; if the input at pin 9 of U-119 is 1 MHz and the load number is 200, the output at U-120 pin 3 will be 5 kHz. When the loop is locked, which is the normal condition, the output of the programmable divider will be 5 kHz. The output of the divider is applied to one input of the phase detector.

### Reference Oscillator and Divider

The reference oscillator provides a 5.12 MHz signal that is divided down to 5 kHz. The oscillator is comprised of U-122A and the associated circuitry. The signal out is buffered by U-122B. The output of U-122B is divided by 4 by U-123A & B and applied to the dual divide-by-16, U-124. The total division is as follows: 2, 2, 16, 16 for a total division of 1024. The output at U-124 pin-6 is a stable 5 kHz signal that is applied to the reference input of the phase detector, U-121.

### Phase Detector

U-121 generates an analog voltage that is proportional to the phase difference between the rising edge of the signals it's inputs, pins 3 & 14. As explained in the general theory of operation, the analog voltage from the phase detector will drive the VCO in the direction to maintain a 5 kHz signal at the output of the programmable divider.



## 4-3 RF AND ANALOG BOARD

Refer to the RF and Analog board schematic, figure 6-2, located in the pocket inside the rear cover of this manual.

### VCXO and Buffer Circuitry

The Voltage Controlled Crystal Oscillator is comprised of Q-206 and associated circuitry. The major frequency determining elements of the oscillator are Y-201, CR-216, L-209, L-210, and the feed-back elements C-238 and C-239. The oscillator operates in the 15.500 MHz to 15.503 MHz range. The frequency is determined by the capacitance of the voltage variable capacitor CR-216. The voltage applied to CR-216 is determined by the 8-bit D-A converter on the Digital board and the setting of the coarse and fine tune frequency adjust pots R-227 and R-228. A minor frequency determining element is CR-209. The voltage applied to CR-209 is determined by the RIT control circuitry. Diodes CR-212, CR-213, and CR-214 provide temperature compensation for CR-216.

The collector of the oscillator transistor, Q-206, is tuned to the third harmonic of the oscillator frequency by L-211, C-242, and C-243. The oscillator output is a signal within the 46.0000 MHz to 46.5099 MHz range. The output of the VCXO is applied to the buffer amplifier Q-207.

The buffer provides gain and additional selectivity to reduce output frequencies other than the third harmonic. The collector of the buffer is tuned by L-212, C-244, and C-245. The output of the buffer is applied through R-239 to one input of the double balanced mixer. The other input to the double balanced mixer is provided by the VCO.

### Voltage Controlled Oscillator

The VCO is a push-pull oscillator comprised of Q-201 and Q-202 and associated circuitry. The major frequency determining elements of the VCO are L-203, CR-203 and, CR-204. The VCO is tuned over the range of 48.5 MHz to 56.0 MHz. The voltage applied to the coarse tune diode, CR-204, is determined by the output of the



12-bit D-A converter. The voltage applied to CR-203 is determined by the phase detector, U-121, located on the Digital board. The loop low pass filter is comprised of R-206, R-207, and C-213. The operating point of the oscillator transistors is stabilized by R-202, R-203, CR-201, and CR-202. The oscillator transistors, Q-201 and Q-202, are matched at the factory and should be replaced as a set if necessary. Two outputs are taken from the VCO and applied to the mixer buffer and the logic buffer.

### VCO Buffers

The mixer buffer, Q-205, amplifies the signal to the +7 dbm level required by the mixer and prevents any impedance variations of the mixer from affecting the VCO. T-201 provides an impedance match between the collector of Q-205 and the mixer.

The logic buffer is comprised of source follower, Q-203, and amplifier Q-204. The source follower provides a very high impedance input to prevent loading the VCO and a low impedance output to drive Q-204. The amplifier provides the necessary gain to insure that the signal applied to U-201 meets the requirements for a TTL logic signal. Diodes CR-205 and CR-206 stabilize the operating point of the amplifier.

### Decade Divider, Low Pass Filter, and Output Switching

The 48.5 MHz to 56.0 MHz signal from the logic buffer is applied to decade divider U-201. The output of U-201 is a signal in the range of 4.85 MHz to 5.60 MHz. The output, after being attenuated by R-216 and R-217, is applied to the low pass filter comprised of L-204, C-222, C-223, and C-224.

The output switching is accomplished by the function switch, S-1, the transceiver, and by CR-207. In the RCV mode P-206 pin 4 will be at the supply voltage. In the XMIT mode P-206 pin 5 will be high. In the RCV/XMIT mode both lines will be high. The transceiver PTO switching circuit monitors these lines and will cause P-206 pin 2 to go high whenever the transceiver is in the mode selected by the RV-75. When P-206 pin 2 is high, CR-207 is forward biased through L-205 and the RV-75 will control the transceiver



frequency. When P-206 pin 2 is low, CR-207 is reverse biased and the internal PTO will control the frequency.

#### Double Balanced Mixer and IF Low Pass Filter

The double balanced mixer is comprised of T-202, T-203 and diodes CR-208 thru CR-211. The mixer generates the sum and difference of the VCXO frequency and the VCO frequency. The difference frequency is selected by the IF low pass filter consisting of C-229, L-207, C-230, C-231, C-232, L-208, C-233, and C-234. The IF output signal will be within the 2.0 MHz to 9.5 MHz range and is applied to the programmable divider buffer, Q-103 located on the Digital board.

#### RIT Control

The RIT control circuitry is comprised of U-202, Q-208, and associated circuitry. U-202 is a quad bilateral switch. When the control input, pins 13, 5, 12, or 6, of a section is high, the input and output pins are connected together. If the control input is low, no connection is made between the input and output pins. When the RIT button is depressed, pin 12 will be high connecting pins 10 and 11 together. If the transceiver is in the RCV mode, Q-208 will be turned off. If the transceiver is in the RCV mode and the RIT button depressed, pins 11 and 10, and control pins 5 and 6 will be high. The high at pin 6 turns on U-202D and pins 9 and 13 will go low because of the GND at pin 8. The low at pin 13 turns off U-202B. The high at pin 5 turns on U-202C and the voltage applied to CR-217 is determined by the setting of the front panel RIT control R-1. With the RIT button depressed and the transceiver in the XMIT mode, Q-208 will be turned on and pins 11, 10, 6, and 5 will be low. Sections C and D will be turned off and pins 9 and 13 will be pulled high by R-251 turning on section B. The voltage applied to CR-217 will be determined by the setting of R-241.

If the RIT button is not depressed, pin 12 will be low, sections A, C, and D will be turned off, and section B will be turned on regardless of the state of Q-208.



#### 4-4 FIXED BOARD DESCRIPTION

Refer to the FIXED board schematic, figure 5-5. The FIXED board consists of two sets of 20 switches, isolation diodes and pull-down resistors. When either FIXED A or B is selected, the common line for that group of switches is connected to +9V. Any switch in the closed position will cause that line to be high. If a switch is not closed, the line will be pulled to GND by the resistors. The diodes prevent interaction between the selected and unselected group of switches. The outputs of the FIXED board are connected to the buffer/switches that are selected by the fixed line on the Digital board.



## V. MAINTENANCE

### 5-1 SERVICE INFORMATION

The R. L. Drake Company will check, align, and repair your RV-75 at the factory on time and material basis. Warranty repair considerations are described on the inside front cover of this manual.

Please write or call the factory for authorization before returning your unit for alignment and/or service. Address your request for authorization to:

R. L. DRAKE COMPANY  
540 Richard Street  
Miamisburg, OH 45342  
ATTN: Customer Service Dept.  
Telephone: (513) 866-3211

### 5-2 GENERAL

Careful consideration has been given to minimizing the maintenance requirements of the RV-75. If a problem should arise, check all external connections before proceeding with troubleshooting or alignment. Remove the top and bottom covers and inspect all connectors for proper mating.

The 5-Line and 7-Line equipment is internally fused. If the equipment will not give a power-on indication, check the internal fuse.

The alignment procedure is designed to align the RV-75 to specification and as a troubleshooting aid. Each section of the alignment procedure verifies the proper operation of a block of circuitry. Before proceeding with alignment, the operator should be familiar with the theory of operation and the location of the test and adjustment points. Refer to figures 5-3 and 5-4 at the end of this section for location.



Unless a malfunction is present, the only adjustments that might need to be performed will be to adjust the frequency of the crystal oscillators. The alignment procedure specifies what steps may be skipped if frequency adjustment is all that is being performed. If a malfunction is present, the entire procedure should be performed and the steps that cannot be performed satisfactorily should be noted.

It is possible that a problem might occur that cannot be resolved using the alignment and troubleshooting information in this section. If this occurs, it is recommended that the unit be returned to the dealer or that the Customer Service Department be contacted. Be sure to describe the malfunction in detail including information regarding external connections, control settings, accessories in use, performance checks or alignment steps that cannot be performed, and the serial number of the unit.

Alignment and/or service of the RV-75 should not be performed by anyone unless thoroughly familiar with solid state circuitry and servicing techniques.

### 5-3 TEST EQUIPMENT REQUIREMENTS

The following is a list of the required and optional test equipment for alignment and service:

#### REQUIRED

- (1) An operational 5-Line or 7-Line transceiver or a test cable constructed as shown in figure 5-3.

- (2) A frequency counter capable of counting a 60 MHz signal. The counter must have at least 10 Hz accuracy and 1 Hz resolution at 5 MHz.
- (3) An oscilloscope with at least a 50 MHz bandwidth.
- (4) An analog voltmeter, either a VTVM or a VOM with at least 20K ohms/volt impedance.
- (5) Two insulated clip leads at least 6" long.

OPTIONAL

- (6) A CMOS compatible logic probe

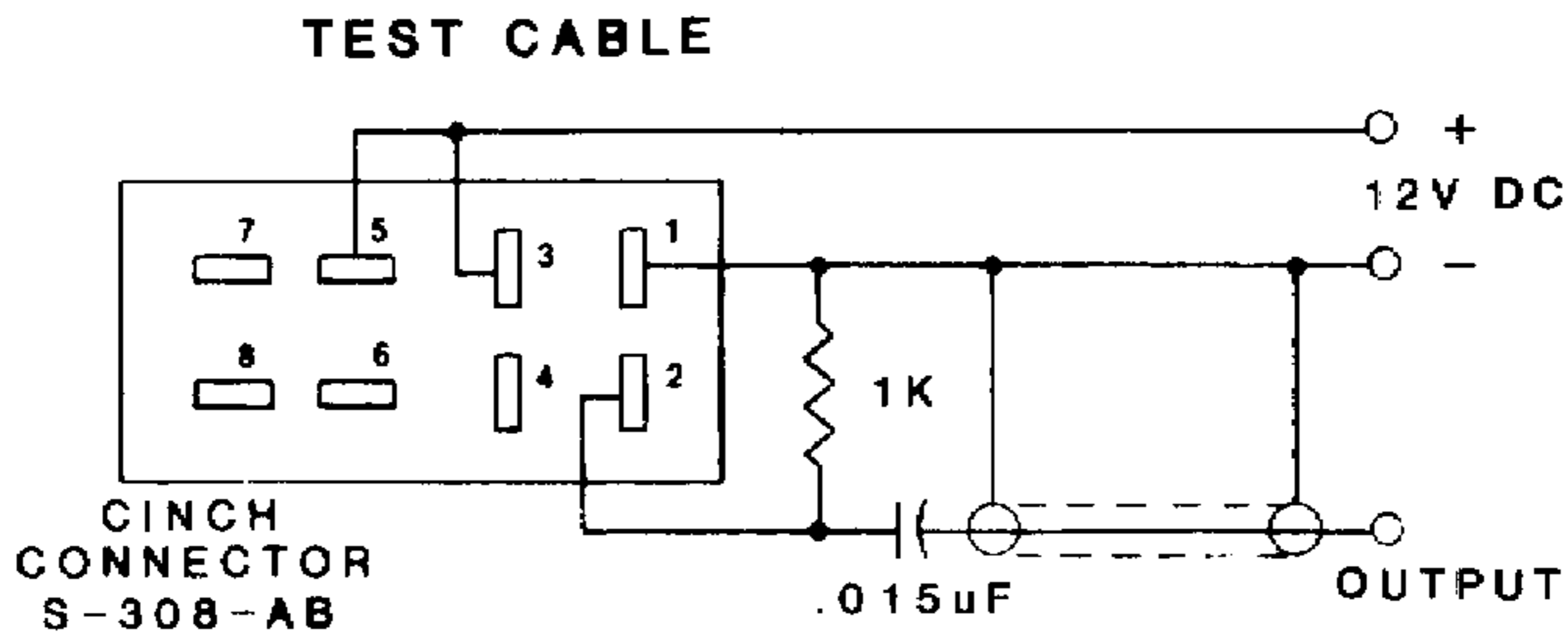

*Figure 5-1 Test Cable*

## 5-4 DISASSEMBLY AND ASSEMBLY PROCEDURES

### Top Cover Removal

Remove the two screws on each side of the grey cover on the bottom and slide the cover to the rear.

### Bottom and Back Cover Removal

Remove the two screws from each side of the bottom cover and the two screws on each side at the rear. Slide the bottom and back



cover to the rear.

The alignment procedure and most troubleshooting can be accomplished without removing the P.C. boards from the RV-75. If it should be necessary, however, to remove any boards, follow the procedures below.

#### Fixed Programming Board Removal

The FIXED board is removed by simply pulling straight up to disengage the board from the connector. Do not apply any side force or bent connector pins may result.

#### Digital Board Removal

Remove the FIXED board as detailed above. Carefully disconnect all plugs from the circuit board. Remove the four screws at each corner of the board and slide the board to the rear until the pushbutton switches are clear of the front panel. Lift out.

#### RF and Analog Board Removal

Remove the main tuning knob and dial skirt by loosening the setscrew in the knob. Remove the other knobs by pulling straight off of the shafts. It may be necessary to pry the knobs off from the rear using a straight-slot screwdriver. Use several thicknesses of heavy cloth to prevent marring the front panel or bezel. Remove the screw located behind the dial skirt and then remove the front panel from the bezel. Remove the two screws from each side of the chassis holding the P.C. board mounting plate and slide the mounting plate to the rear until free from the chassis. Remove the R.F. and Analog board from the mounting plate by removing the four screws at each corner of the board.

#### ASSEMBLY

The RV-75 should be re-assembled in the reverse order of disassembly. Insure that the two LED's extend through the front panel before tightening the front panel screw. BEFORE APPLYING POWER OR REINSTALLING THE COVERS, CHECK ALL CONNECTORS FOR PROPER PLACEMENT AND ORIEN-



TATION. PLUGGING A CONNECTOR IN A PIN OFF OR TO THE WRONG PLUG MAY CAUSE DAMAGE TO THE RV-75 OR TO THE TRANSCEIVER.

## 5-5 ALIGNMENT PROCEDURES

If frequency setting or checking is the only procedure to be performed, remove the top cover. If a complete alignment or troubleshooting is to be performed, remove both the top and bottom covers.

### 5-5.1 INITIAL SET-UP

Program FIXED A for a BCD value of 95000 and FIXED B for a value of 20099. Place jumper plug P-107 in the normal position for the 7-Line. Place the RV-75 in the TUNE position, RIT off, and the function switch to OFF. Insert a shorting plug in the RIT Switch jack on the rear of the RF and Analog board. Connect the RV-75 to the transceiver or test cable and turn the function switch to the RCV position. If frequency setting is the only procedure to be performed, proceed to step 5-5.3.

If the oscilloscope being used has a channel 1 or channel 2 vertical output signal, it is recommended that the counter be connected to the scope so that the signals can be observed and counted without the need to disconnect the scope and reconnect the counter.

The initial oscilloscope and counter control setting should be as follows:

OSCILLOSCOPE	
VERTICAL SENS.	2V/DIV
VERTICAL COUPLING	DC
SWEEP SPEED	.5 $\mu$ S/DIV
TRIGGER LEVEL	+
TRIGGER SLOPE	DC
TRIGGER MODE	AUTO
TRIGGER SOURCE	INTERNAL
COUNTER	
INPUT COUPLING	DC



## 5-5.2 VOLTAGE REGULATOR CHECKS

- A.) Measure the 9V Digital board regulator output at TP-111. The voltage should be 9VDC  $\pm$ .5V. Note the voltage.
- B.) Measure the RF board 9V regulator output at the TP indicated in figure 5-4. The voltage should be within  $\pm$ .2V,  $\pm$ .5V of the Digital board regulator output.
- C.) Measure the RF board 5V regulator output at the TP indicated in figure 5-4. The voltage should be 5VDC  $\pm$ .5V.
- D.) Measure the Digital board 5V regulator output. The voltage should be 5VDC  $\pm$ .5V.

## 5-5.3 REFERENCE OSCILLATOR FREQUENCY ADJUSTMENT

- A.) Connect the oscilloscope/counter to TP-114. Adjust C-116 for exactly 1.280000 MHz. If frequency setting is the only procedure being performed, proceed with the VCXO final adjustment, step 5-7.2.
- B.) Connect the oscilloscope/counter to TP-115. Set the oscilloscope SWEEP SPEED to .2 mS/DIV. The counter should indicate 5.000 kHz.

## 5-5.4 OPTICAL INTERRUPTER BIAS ADJUSTMENT

- A.) Connect the oscilloscope to TP-101 and the voltmeter to P-104 pin 3.
- B.) While rotating the tuning knob, adjust R-101 for a reading of 1/2 the 9V regulator output  $\pm$ .2VDC.
- C.) Rotate the tuning knob and note on the oscilloscope that the bottom of the waveform swings to within 1V of GND, and that the top of the waveform swings to within 1V of the 9V regulator output.
- D.) Connect the oscilloscope to TP-102 and the voltmeter to P-104 pin 4.



E.) Repeat steps B.) and C.) except adjust R-105.

### 5-5.5 OPTICAL INTERRUPTER MECHANICAL ADJUSTMENT

- A.) Connect the voltmeter to TP-103. Rotate the tuning knob smoothly. The meter should indicate  $1/2$  the 9V regulator output  $\pm .5V$ . If not, proceed with step B.).
- B.) Loosen the two optical interrupter mounting screws shown in figure 5-3 until the mounting plate will just move if slight pressure is applied.
- C.) While rotating the tuning knob smoothly and monitoring the voltage, slide the mounting plate to the left or right until the voltage measures  $1/2$  of the 9V regulator output  $\pm .5VDC$ .
- D.) Tighten the two screws and recheck the voltage. Repeat steps B.) and C.) if necessary.

### 5-5.6 VARIABLE RATE TUNING OSC. CHECK

- A.) Connect the oscilloscope to TP-104 and the voltmeter to TP-105. Set the oscilloscope SWEEP SPEED to  $50 \mu S/DIV$ . and TRIGGER SLOPE to -. Rotate the VRTO adjust pot, R-115, fully CCW and then  $1/4$  turn CW.
- B.) Rotate the tuning knob and verify that the voltage changes with the speed of rotation.
- C.) Rotate R-115 CW until pulses appear on the oscilloscope. The voltmeter should indicate  $4V \pm 1.5V$ .
- D.) Return R-115 to  $1/4$  of rotation.

### 5-5.7 DIRECTION DETERMINING CHECK

- A.) Connect the oscilloscope to TP-108.
- B.) While rotating the tuning knob slowly CW, monitor the oscilloscope. The oscilloscope should indicate a DC level of 9V without any bounces or glitches.



C.) Rotate the tuning knob slowly CCW. The oscilloscope should indicate a 0V level without any bounces or glitches.

### 5-5.8 5-DECADE UP/DOWN COUNTER CHECK

A.) Connect the oscilloscope/counter to TP-107. Set oscilloscope SWEEP SPEED to 10 mS/DIV.

B.) Connect a clip lead from GND. to TP-108.

C.) Connect a clip lead from TP-114 to TP-106.

D.) The counter should indicate 12 Hz +/- 1 Hz.

### 5-5.9 D-A CONVERTERS AND LIMIT CIRCUIT CHECKS.

A.) Connect the oscilloscope to P-106 pin 1.

B.) Set oscilloscope controls as follows:

VERTICAL SENSITIVITY	1V/div.
SWEEP SPEED	10 $\mu$ S/div.
TRIGGER SLOPE	+

C.) Adjust the oscilloscope trigger level for a waveform as shown in figure 5-2a. Examine the waveform. The sawtooth waveform should not have any discontinuities greater than 1/2 of a minor division on the oscilloscope.

D.) Connect the oscilloscope to P-106 pin 8 and set the TIME/DIV. switch to 10 mS/div. Adjust the oscilloscope trigger level for a waveform as shown in figure 5-2b.



- E.) Examine the waveform. The sawtooth waveform should not have any discontinuities greater than 1/2 of a minor division on the oscilloscope.
- F.) Depress the FIXED A pushbutton. The oscilloscope should indicate a straight line at approx. 5V.
- G.) Depress the FIXED B pushbutton. The oscilloscope should indicate a straight line at approx. 1V.
- H.) Depress the TUNE pushbutton. Remove the clip lead grounding TP-108. Adjust the oscilloscope trigger level for a stable display and insure the waveform appears as shown in figure 5-2c.
- I.) Remove the clip lead between TP-114 and TP-106.

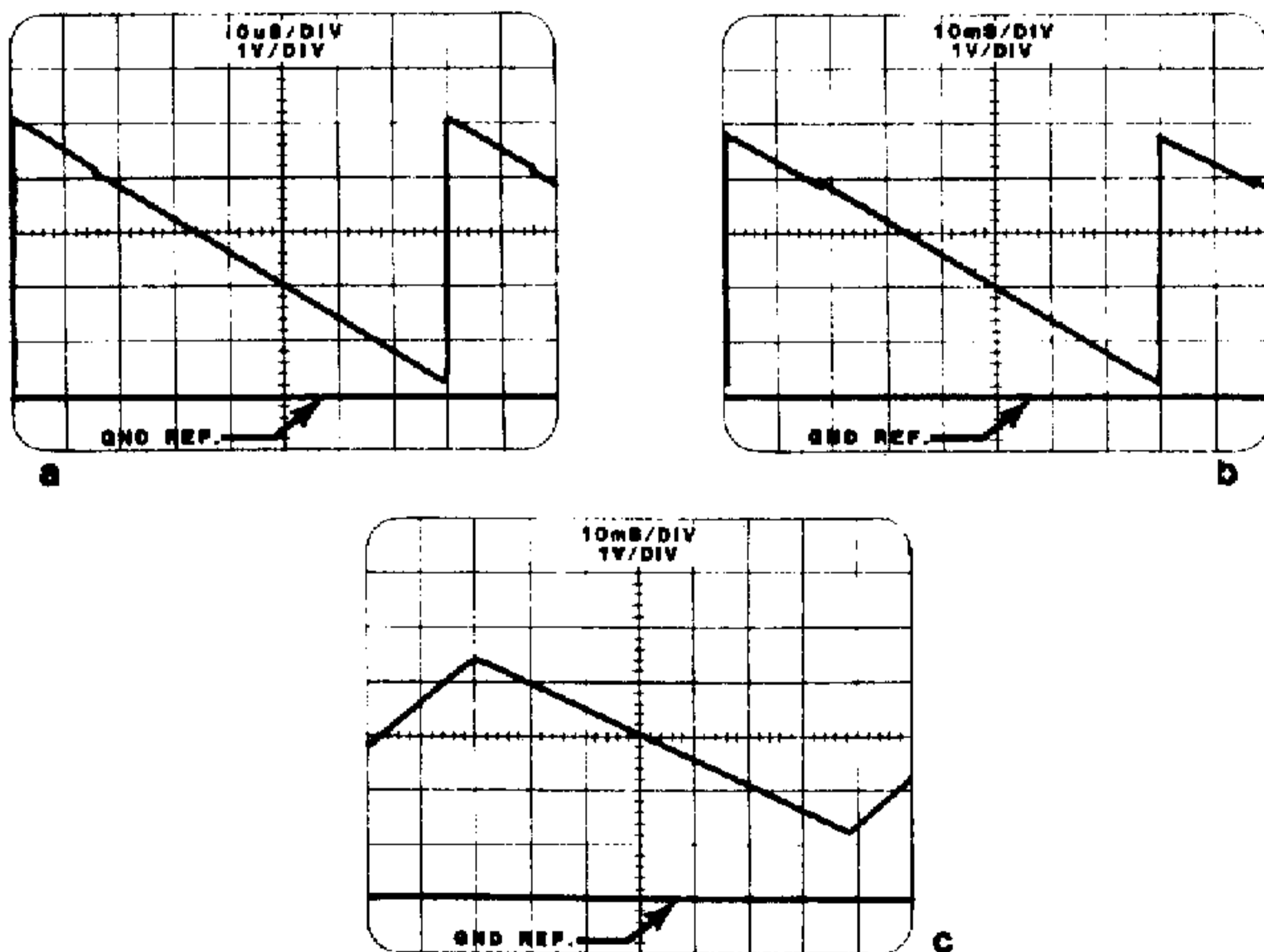

Figure 5-2 Oscilloscope Waveforms



## 5-5.10 PROGRAMMABLE DIVIDER CHECK

A.) Set oscilloscope controls as follows:

VERTICAL SENSITIVITY    2V/div.  
 SWEEP SPEED                    .2 mS/div.

B.) Connect the oscilloscope to TP-113.

C.) Unplug the connector from P-105 and connect a clip lead from P-105 pin 2 to GND.

D.) Connect a clip lead between TP-114 and TP-112.

E.) Turn the transceiver or test supply power OFF and then back ON. The counter should indicate 984 Hz +/-1 Hz.

F.) Depress the FIXED A pushbutton. The counter should indicate 673 Hz.

G.) Depress the FIXED B pushbutton. The counter should indicate 3200 Hz.

H.) Connect the voltmeter to P-103 pin 2. The voltmeter should indicate 9V.

I.) Turn transceiver or test supply power off. Disconnect the clip leads and reconnect P-105. The coax shield should go to pin 1.

This concludes the Digital board tests and checks. Proceed with the RF and Analog board tests.

## 5-6 RF AND ANALOG BOARD

If any adjustments are made to the RF and Analog board, the entire procedure from step 5-6.1 through Final Adjustment must be performed.

The voltages mentioned in this section are the peak-to-peak voltages as displayed on a 50 MHz oscilloscope. Voltages will vary if an oscilloscope with a different bandwidth is used. When making RF voltage measurements with an oscilloscope, the ground clip



for the probe should be less than 4" long and connected to a GND. point close to the circuitry being measured.

The oscilloscope sweep speed and vertical sensitivity should be adjusted to display several cycles of the desired signals and the sweep trigger controls adjusted for a stable display.

Set the oscilloscope controls as follows:

VERTICAL SENS.	.5V/DIV.
VERTICAL COUPLING	DC
SWEEP SPEED	20 nS/DIV.

### 5-6.1 INITIAL SET-UP

Depress the TUNE, RIT, and LOCK pushbuttons. Center the front panel RIT control. Verify that the FIXED channels are programmed as per 5-5.1 and that the shorting plug is inserted in P-208. Place the RV-75 in the RCV position and turn the transceiver or test supply power ON.

### 5-6.2 VCXO COARSE ADJUSTMENTS

- A.) Connect the oscilloscope/counter to the VCXO TP.
- B.) Adjust L-211 and L-212 for maximum signal as displayed on the oscilloscope/counter. The signal should be at least 1.5V P-P. The counter should be indicating in the 46 MHz range. Note the displayed frequency.
- C.) Depress the RIT pushbutton to unlock. If the frequency is not within +/-10 Hz of that in step B.), adjust the RIT centering pot, R-241, for the same frequency.
- D.) Depress the FIXED B pushbutton. If the frequency is not within +/-100 Hz of 46.509900 MHz, adjust L-210 for the correct frequency.
- E.) Depress the FIXED A pushbutton. If the frequency is not within +/-100 Hz of 46.500000 MHz, set R-228 to center and adjust R-227 for the correct frequency.



F.) Repeat steps D.) and E.) until the frequency is 46.509900 MHz +/-100 Hz in FIXED B and 46.500000 MHz +/-100 Hz in FIXED A.

### 5-6.3 VCO ADJUSTMENT AND BUFFER AMP CHECKS

A.) Connect the voltmeter to P-201 pin 2 and the oscilloscope/counter to the VCO Logic Buffer test point. Set the oscilloscope VERTICAL COUPLING to DC. Set VERTICAL SENS. to .5V/DIV.

B.) Depress the LOCK pushbutton to unlock and depress the TUNE pushbutton.

C.) Adjust L-203 for a voltmeter reading of 5.5V. The counter should indicate about 53 MHz.

D.) Examine the waveform. The top of the waveform should be at least 2.2V above GND. The bottom of the waveform should be no more than .5V above GND.

E.) Depress the FIXED A button. The counter should indicate about 56 MHz. The voltmeter reading should be between 4.5V-7.5V and the oscilloscope waveform should be within the limits defined in step D.).

F.) Depress the FIXED B button. The counter should indicate about 48.5 MHz. The voltmeter reading should be between 4.5V-7.5V and the oscilloscope waveform should be within the limits defined in step D.).

G.) Connect the oscilloscope/counter to the Mixer Buffer TP and measure the P-P voltage in the FIXED B, FIXED A, and the TUNE position. The voltage should be at least 1.5V P-P at all frequencies.

### 5-6.4 VCXO FINE ADJUSTMENT

A.) Connect the oscilloscope/counter to the IF Output TP and depress the TUNE pushbutton. Set oscilloscope SWEEP SPEED to 100 nS/DIV. and VERTICAL SENS. to .05V/DIV.



- B.) Adjust L-211 and L-212 for maximum signal level. The P-P voltage should be at least 100 mV.
- C.) Connect the oscilloscope/counter to the RF Output TP, insure that the front panel RIT control is centered, and depress the FIXED A and RIT pushbuttons. Note the frequency reading.
- D.) Depress the RIT button to unlock and adjust the RIT centering pot, R-241, for exactly the same frequency as noted in step C.).
- E.) Depress the RIT button several times and insure that the frequency is the same. Re-adjust R-241 if necessary.
- F.) Depress the FIXED B pushbutton. Adjust L-210 for exactly 4.850990 MHz.
- G.) Depress the FIXED A pushbutton. Adjust R-228 for exactly 5.600000 MHz.
- H.) Repeat steps F.) and G.) as often as necessary so that the frequencies are within 1 Hz of the desired. If R-228 runs against the stop, adjust R-227 slightly to bring R-228 within range.

### 5-6.5 RIT CIRCUIT CHECKS

- A.) Depress the FIXED A and RIT pushbuttons.
- B.) Rotate the front panel RIT control to each limit and insure that the frequency changes at least  $\pm 200$  Hz from 5.600000 MHz. Leave the control at one end of rotation.
- C.) Switch the RV-75 to the RCV/XMIT mode and remove the shorting plug from P-208. The frequency should return to 5.600000 MHz.

### 5-7 FINAL ADJUSTMENT

Turn transceiver or test supply power OFF. Install bottom and back cover. If a transceiver is being used for alignment, pull the 8-pin plug connected to the transceiver out of the socket far

enough to connect the scope probe to pin 1 of the connector. If a test cable is being used, connect the counter to the RF Output.

### 5-7.1 VRTO ADJUSTMENT

- A.) Turn transceiver or test supply power ON and depress the TUNE pushbutton. Note the frequency reading.
- B.) Rotate the main tuning knob quickly one revolution and then note the frequency reading. If the frequency change is less than approximately 25 kHz, rotate R-115 on the Digital board slightly clockwise. If the frequency change is greater than approximately 25 kHz, rotate R-115 CCW.
- C.) Repeat step B.) if necessary.

NOTE: The setting of 25 kHz is the setting as supplied from the factory. If, after becoming familiar with the operation and “feel” of the VRTO, it is desired to change the setting, R-115 may be adjusted to provide any convenient increase in tuning rate. Adjusting R-115 fully CCW will disable the VRTO feature.

### 5-7.2 VCXO FINAL ADJUSTMENT

- A.) Turn transceiver or test supply power ON. Depress the FIXED B pushbutton. Adjust L-210, accessible through the hole in the bottom cover closest to the rear panel, for a frequency readout of 4.850990 MHz.
- B.) Depress the FIXED A pushbutton. Adjust R-228, accessible through the hole closest to the centerline of the RV-75, for a frequency readout of 5.600000 MHz. Shining an inspection light through the L-210 access hole will aid in locating the slot in R-228.
- C.) Repeat steps A.) and B.) as often as necessary to obtain the correct frequencies.

This completes the alignment procedure. Turn transceiver or test supply power OFF, disconnect any test equipment, and install top cover.

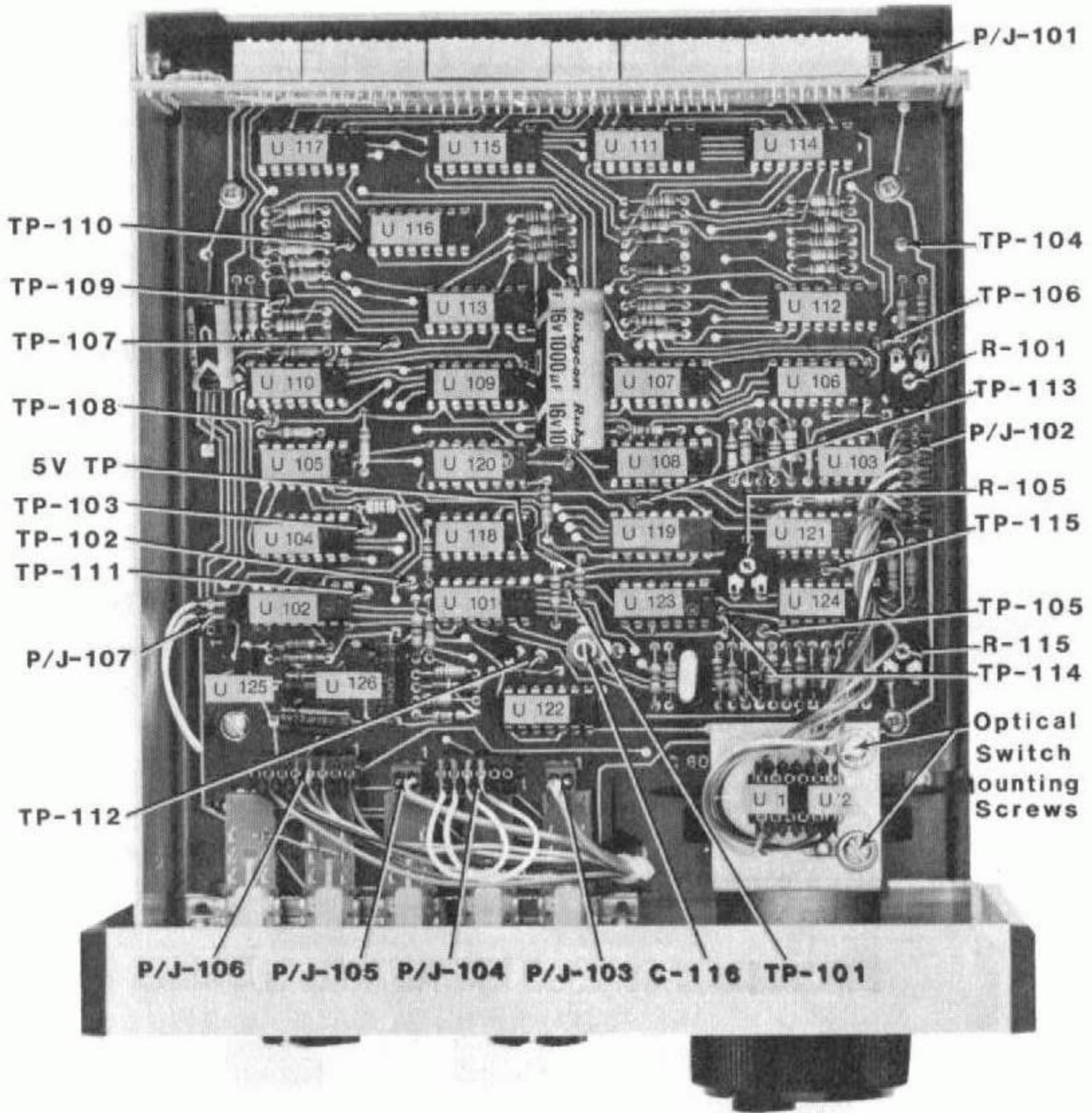

Figure 5-3 Digital Board

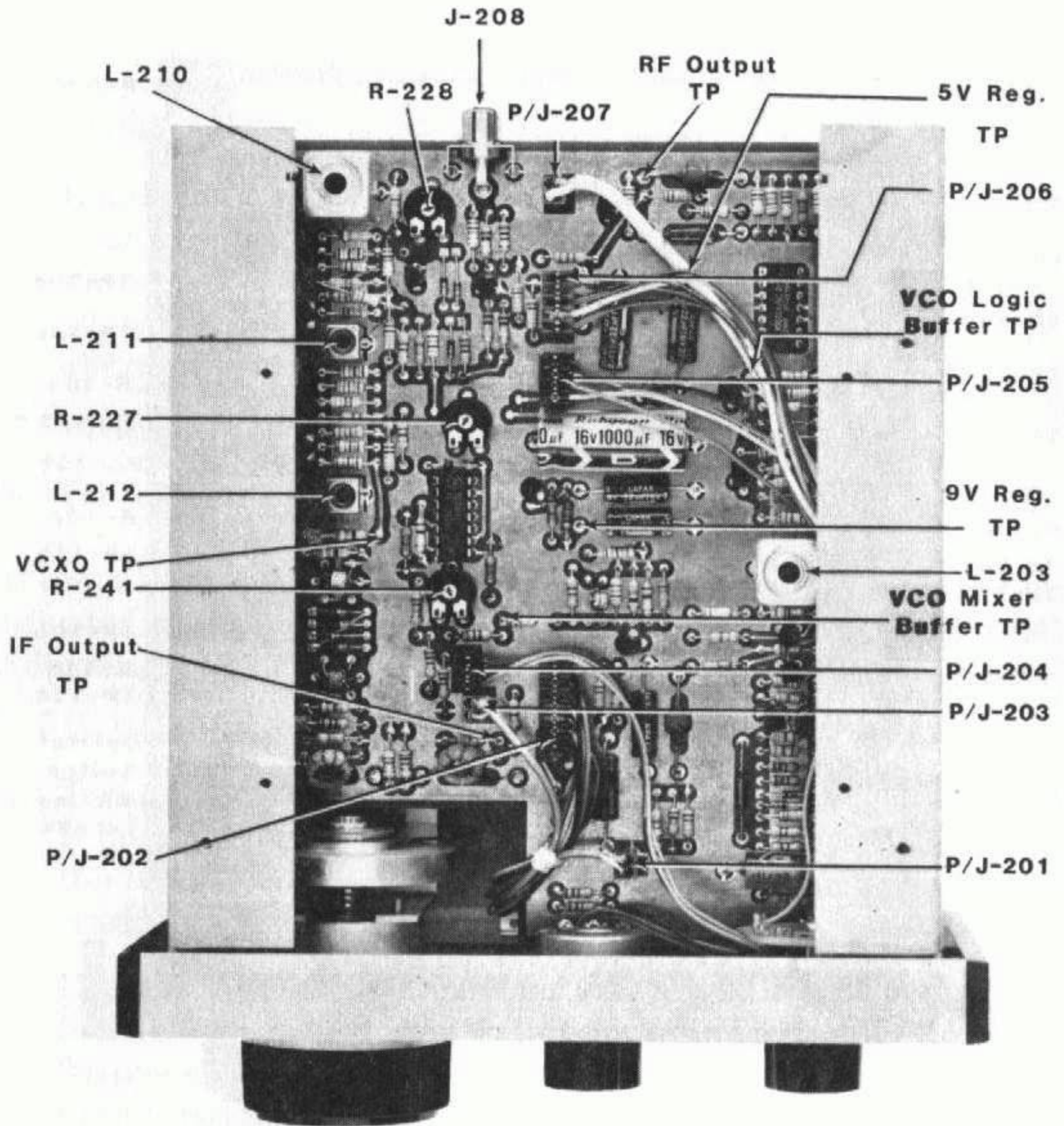

Figure 5-4 RF And Analog Board

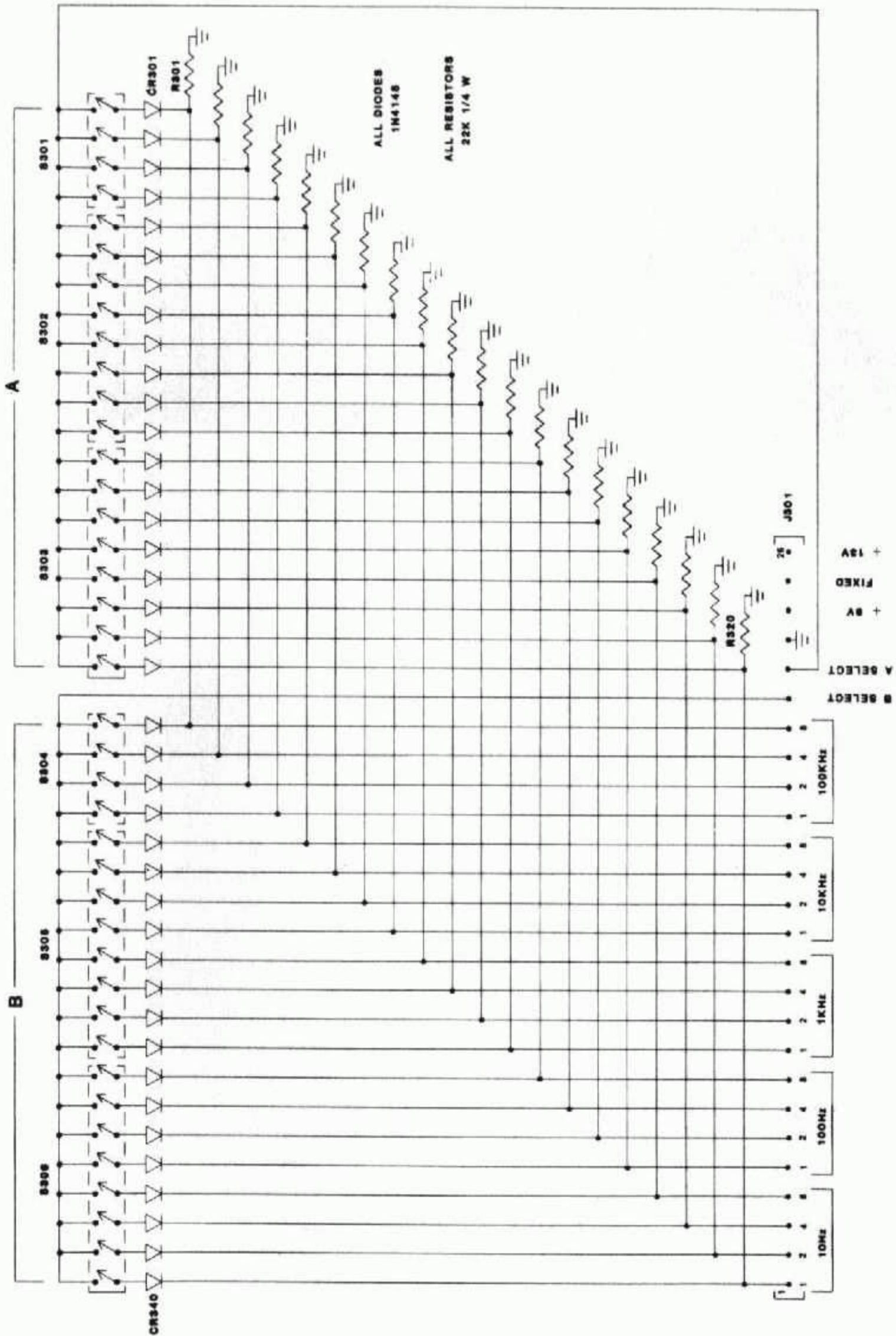

Figure 5-5 Fixed Board Schematic