

installation and operating instructions for skyrider panoramic model sp-44

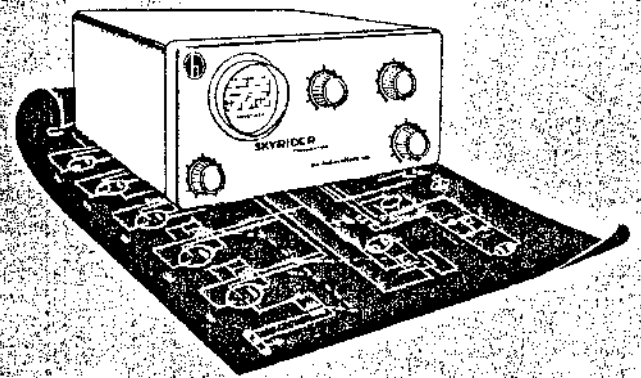

MAY 1946

94-177

the hallicrafters co.

MANUFACTURERS OF RADIO AND ELECTRONIC EQUIPMENT, CHICAGO 16, U. S. A.

**INSTALLATION AND OPERATING
INSTRUCTIONS
FOR
SKYRIDER PANORAMIC MODEL SP-44**



Figure 1. Skyrider Panoramic Model SP-44 Front View.

The Model SP-44 Skyrider Panoramic is a device designed for operation in conjunction with a companion receiver for the purpose of monitoring up to 200 kilocycles of the radio spectrum visually and to analyze the characteristics from your own or other transmitter. Percent of modulation, distortion, carrier shift, parasitic radiations, key clicks, or practically any other trouble that is likely to occur in amateur transmitters can be identified with ease.

With the Model SP-44 Skyrider Panoramic you can keep track of all stations in a "round table" QSO and can locate operating frequencies which are comparatively free from QRM. A phone jack on the rear of the chassis permits audible monitoring of all signals within a 200 kilocycle range at one time. No modifications are necessary in your receiver in order to connect the adapter to a receiver and it in no way interferes with normal receiver operation. This adapter may be used with any receiver being an i-f frequency between 450 and 470 kilocycles.

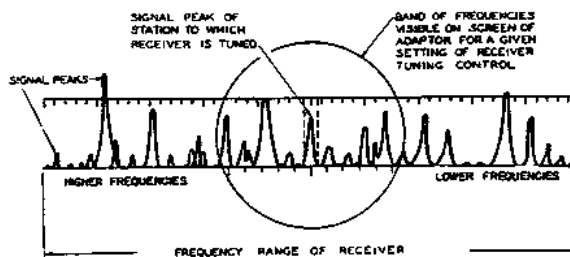

Figure 2. Portion of the Radio Spectrum.

PRE-INSTALLATION CHECK:

1. Insert the line cord plug into power outlet and turn the **CENTERING** control clockwise, thus turning the unit on. In a half minute or more a base line should appear on the screen. If it does not, see whether the tubes are lighted by looking through the rear of the cabinet, and if they are make the following adjustments:

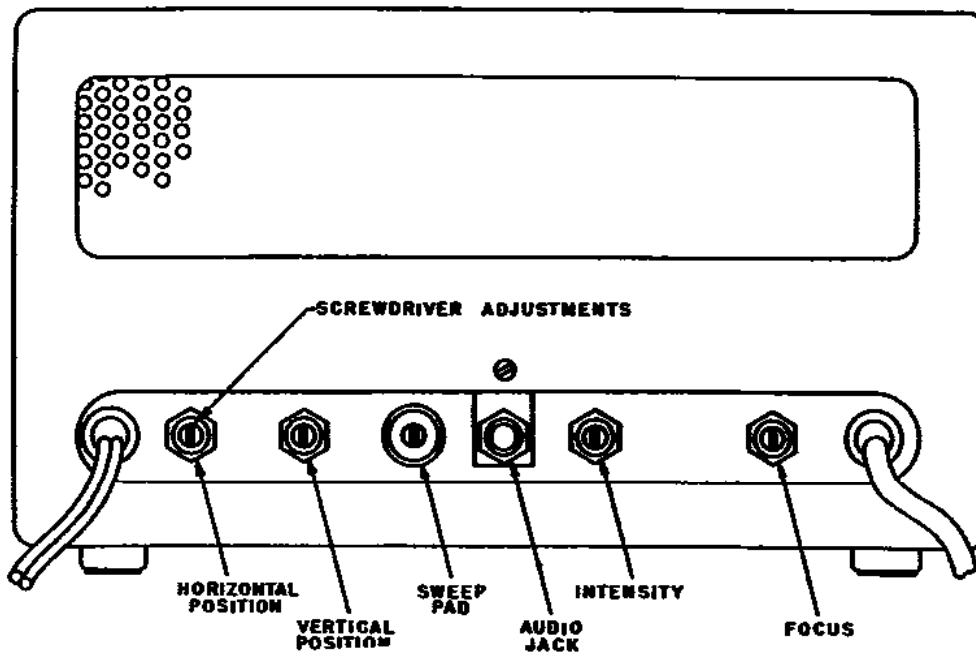

Figure 4. Skyriders Panoramic Model SP-44, view showing operating control functions.

A. Adjust the screw driver controls—Intensity and Focus, for optimum brightness and sharpness of the baseline on the cathode ray tube screen. Note: reduction of the intensity and proper adjustment of the focus control produces a sharp base line. Bring the cathode ray tube base line so that it coincides with the lowest horizontal line on the screen by means of the Vertical Position control. Then, if necessary, adjust the horizontal position control so that the baseline is approximately centered along the horizontal axis.

2. Turn the **SENSITIVITY** control up so maximum (clockwise). The baseline may break up into "grass" deflections near each and which is due to noise pick up. This is not abnormal however. (Note:—the **SCANNING WIDTH** control must be turned so maximum and the **CENTERING** control may need adjustment to obtain noise at both ends of the screen. The base line should be clear from one end to the other.

3. Turn off the adapter a-c power by turning the **CENTERING** control counter-clockwise to OFF.

INSTALLATION.

1. Connect the Skyriders Panoramic so the companion receiver as follows:

A. Bring in r-f cable through back or top of receiver.

B. Remove converter tube from socket and push plate pin of tube through the spiral spring on cable. The spring should bind tightly.

C. Replace tube in socket being careful so avoid injuring the insulating sleeve on resistor pig-tail lead so that no short develops between the lead and chassis or other tube pins. (The input i-f transformer and other components could burn out if this happened.

D. Fasten alligator clip so chassis ground point near the converter tube. (Note: It is important that the resistor and clip assembly be kept close to the chassis to prevent oscillation.

2. Insert a headset cord plug into the audio output jack on the rear of the unit (use crystal headphones because of their high impedance). If a speaker is to be used, connect it through an audio amplifier to the audio jack. (Note: The input grid return resistor of the audio amplifier must be approximately 500,000 ohms and the shunt capacity of the input must be held at a minimum to prevent distortion of the patterns on the cathode ray tube screen.

HOW TO OPERATE THE SKYRIDER PANORAMIC

Only the basic operating procedures are described in these instructions.

VISIBLE PANORAMIC

1. Turn on the Skyrider Panoramic and receiver and wait for the base line to appear.

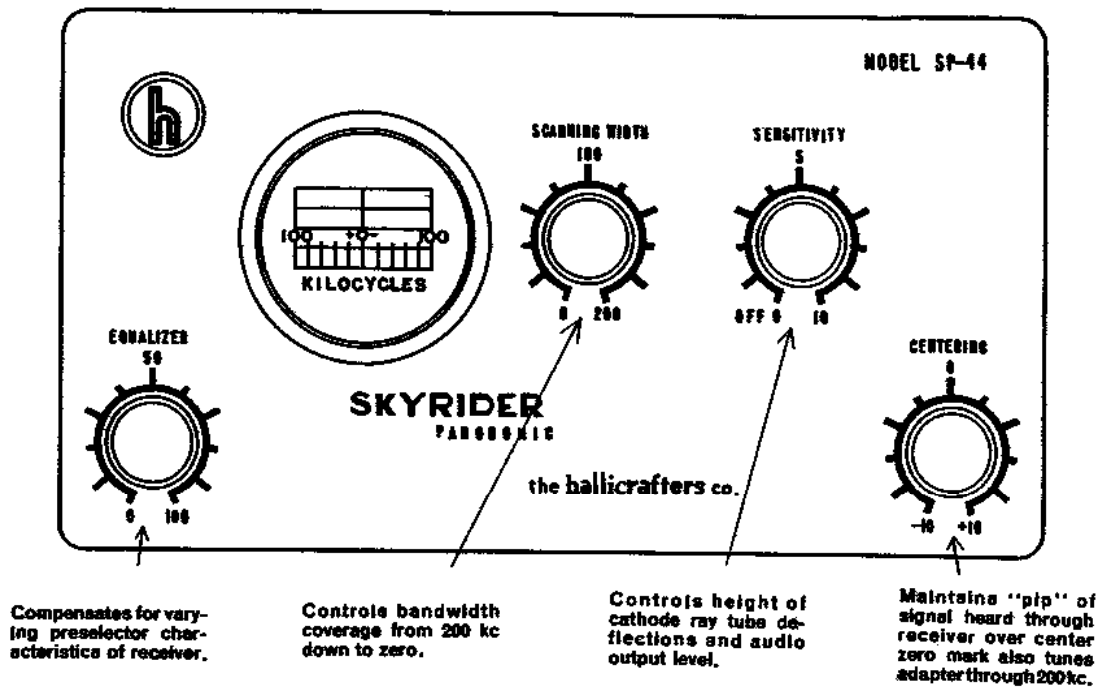

Figure 5. Skyrider Panoramic Model SP-44, view showing adjustment controls.

2. Set the companion receiver controls, where applicable, as follows:

SENSITIVITY	NEAR MAXIMUM
VOLUME	NORMAL
SELECTIVITY <i>switch</i>	NORMAL
A.V.C.	OFF
CRYSTAL PHASING	NOT USED
B.F.O.	OFF WHEN NOT RECEIVING CW.
A.N.L.	OFF
ANTENNA <i>trimmer</i>	NORMAL

3. Set the SCANNING WIDTH control for maximum sweep (200) and turn the SENSITIVITY control approximately half way clockwise.

Operating Hint: Always keep the SENSITIVITY control as low as possible so that the level of noise and spurious response is kept at minimum. This makes it easier to compare weak signals that are close to strong ones.

4. Tune the receiver slowly and soon one or more signals will appear on the cathode ray tube screen. The deflections move across the screen as the tuning dial on the receiver is rotated. The signal heard through the receiver should appear directly over the center or zero mark on the screen. If this does not happen, make the following adjustments:

A. Tune in a voice or music modulated signal and center the deflection with the CENTERING control.

B. Slowly rotate the SCANNING WIDTH control to almost zero and maintain the broadening deflection centered.

C. Return the SCANNING WIDTH control to maximum. The deflection should remain over the zero mark on the screen, but if it shifts off center, adjust the Horizontal Position control for final centering. It may be necessary to maintain and restore the centered position as the equipment warms up.

D. Adjust the EQUALIZER control so that the height of a deflection "pip" remains as constant as possible as it passes across the screen while the receiver is tuned. Each band on the receiver may require a different setting of this control. In performing this adjustment and for general operation of the Panoramic Adapter, it is best to cut off the A.V.C. in the receiver since the signal appearing at the center of the screen may control the height of all other signals. Should the receiver be tuned to a strong signal, the weaker adjacent signals may be reduced in height or they will not appear at all.

As the receiver is tuned from a low to a high frequency, the signal deflections will move across the screen from left (plus) to right (minus). The reverse is true when tuning from a high to a low frequency. Those signals appearing on the plus side of the zero mark are higher in frequency than the station heard through the receiver by the amount indicated by the screen calibrations, each calibration mark being equal to 20 kilocycles. (Note:—The signals appearing on the minus side of zero are true only when the local oscillator in the receiver tracks above the incoming signal. The reverse is true when the frequency of the incoming signals are higher than the local oscillator frequency. Refer to Figure 6 for illustration showing the determination of a single frequency at maximum scanning width.

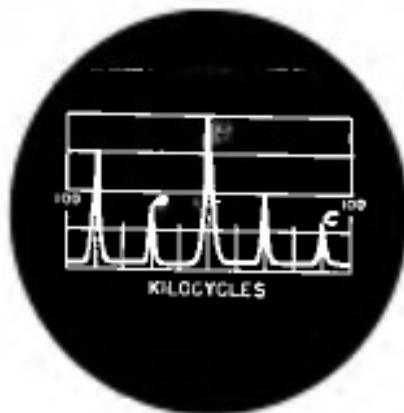

- A—Signal 40KC above signal heard through receiver.*
B—Signal heard through receiver.
C—Signal 80KC below signal heard through receiver.

Figure 6. Illustration showing determination of a single frequency at maximum scanning width.

INTERPRETATION OF SIGNALS

With a little experience it is possible to recognize visually the character of various types of signals without listening to them. However, the Sky rider Panoramic can show only what the radio receiver is able to receive and no more. A poorly adjusted receiver cannot be expected to give good results even with a perfectly adjusted adapter. The following illustrations show patterns of various signals received on the panoramic screen.

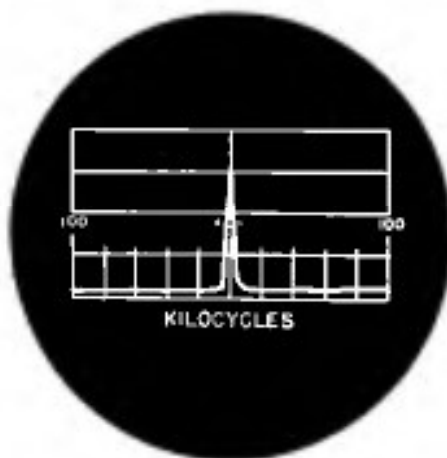

(Unmodulated Carrier)

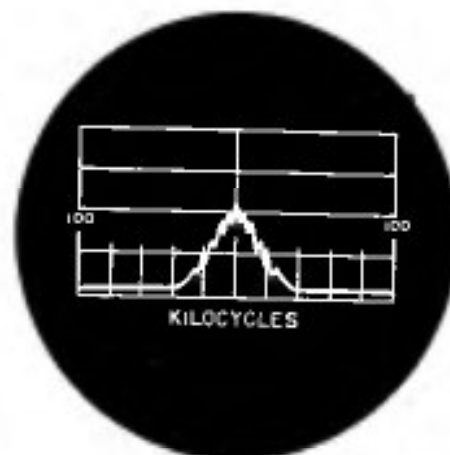

(Amplitude Modulated Carrier at Reduced Sweepwidth)

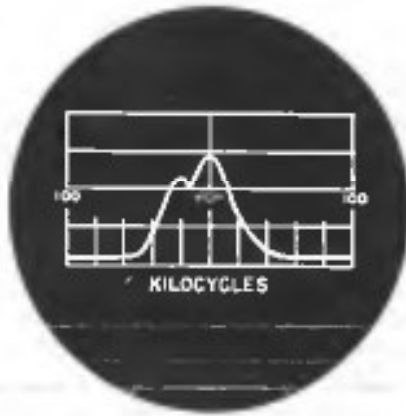

Single Side Band Signal

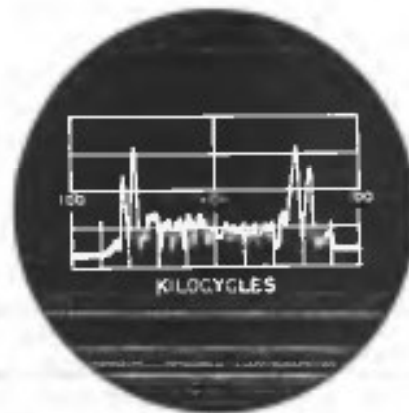
Frequency Modulated Signal
at Reduced Sweepwidth

CW Signal

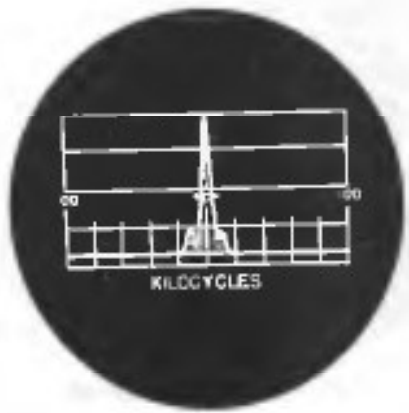
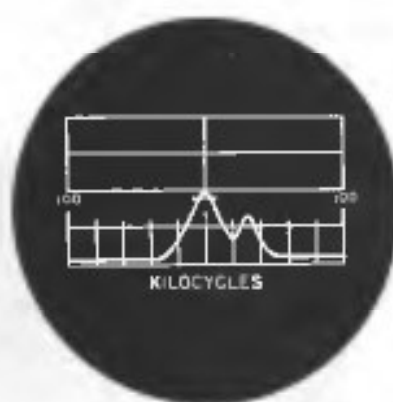
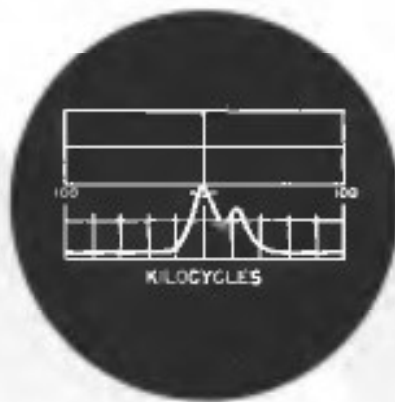
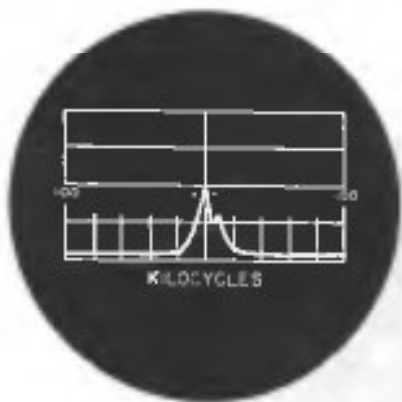
MCW Signal
at Reduced Sweepwidth**Appearance of two interfering signals as scanning width is reduced.**

Transient Disturbances:—Those disturbances received as noises in the receiver, are of two types, periodic and aperiodic transients.

Periodic transients, such as produced by automobile ignition, motors, vibrators, buzzers, etc., appear as signals moving along the frequency sweep base line in one direction or another. Thus, an automobile which is accelerating will produce a set of deflections which may move first in one direction, slow down, stop, and move in the opposite direction.

This is caused by the fact that the Skyrider Panoramic is sweeping at a fixed rate (25 or 30 times per second), whereas the transient occurs at a variable rate. The images stand still on the screen when there is synchronism between the two. If the transient disturbance is synchronized with the 50 or 60 cycle line, the "noise" appears as a fixed signal which, however, only varies in height. Such deflections may appear like amplitude modulated signals or like steady carriers. Aperiodic transients, such as static, appear as irregular deflections and flashes along the whole frequency sweep axis.

Tube Noises—These are due to too great an amplification of the receiver, Skyrider Panoramic or both, appearing as varying irregularities along the frequency sweep axis. Proper adjustment of the SENSITIVITY controls should reduce or eliminata this disturbance.

(Example—If it is desired to observe 120 kilocycles of the band, any deflection 60 kilocycles from the center mark is selected.)

3. Rotate SCANNING WIDTH control counter-clockwise until selected deflection or pip just runs off screen.
4. Tune receiver to center of portion of band to be observed.

VISIBLE SINGLE SIGNAL OBSERVATION

1. Adjust the adapter and receiver as for visible panoramic operation.
2. Reduce SCANNING WIDTH to zero slowly while pip is maintained at center.
3. Adjust CENTERING or receiver tuning for maximum deflection or pip.
4. Adjust adapter SENSITIVITY control so that when no modulation is present, the straight horizontal trace is to coincide with the center-horizontal line on the screen.
5. For visual examination of any one signal on either side of the screen without affecting reception of the signal heard through the receiver. The following procedure can be used:
 - A. Rotate CENTERING control to that the signal to be examined is directly over the zero mark.
 - B. Reduce the SCANNING WIDTH control to zero.
 - C. Trim the CENTERING frequency control for maximum upward deflection of the signal trace.

Signals will appear in the following manner during this type of operation.

1. Constant carrier—The base line is elevated above its normal position.
2. An amplitude Modulated Carrier—The modulating waveform shows on the screen.
3. CW Signal—The base line rises and falls in step with the transmitter keying.
4. Synchronous Noise—The base line is broken up into "grass" deflections. Clear areas may be present.
5. MCW Signal—The baseline is elevated above its normal position and as the transmitter is keyed the baseline rises and falls back to the elevated position.

Images—If the receiver allows "images" to pass (due to poor image rejection of the R.F. circuits), these will be distinguished from normal signals by the fact that they move in an opposite direction when the companion receiver is tuned. Such images are most likely to appear on the higher frequency ranges of the receiver.

Harmonics—Harmonics produced in the receiver by the beat of very strong signals with harmonics of the oscillator, will be distinguished from other signals by the fact that they move on the screen more rapidly (with tuning) than the normal signals. (Twice as fast for second harmonic spurious signals.) Generally, a reduction in the sensitivity of the receiver will eliminata this type of spurious signal.)

Disthermy Apparatus—This type of apparatus when using an unfiltered or a-c supply will produce a periodic disturbance which will cause a deflection to appear on certain portions of the screen and disappear on other portions. This due to the fact that such equipment emits a signal pulsating in synchronism with the power line. On the other hand, the Skyrider Panoramic too, is sweeping

the spectrum in synchronism with the line but at a lower frequency (30 cycles). Only when a certain phase relationship exists, is it possible for the adapter to receive those pulses.

Spurious Signals.—If the signal strength exceeds a certain value, the deflection caused by any signal breaks up into a series of parallel deflections, somewhat similar to side bands. These spurious signals can take place either in the receiver or adapter on extremely strong signals. A slight reduction in the sensitivity of the adapter will eliminate this type of distortion.

AUDIBLE PANORAMIC

For 200 kilocycle monitoring—

1. Plug a pair of crystal phones or an audio amplifier into the audio output jack at the rear of the adapter chassis.
2. Adjust the adapter the same as for visible panoramic.
3. Tune the receiver to the center of 200 kilocycle portion of the band to be monitored.
4. Select desired station on cathode ray tube screen and tune in with the receiver.
5. Control the loudness of the buzz with the SENSITIVITY and SCANNING WIDTH controls.

For less than 200 kilocycle monitoring—

1. Tune receiver to any crowded band.
2. Select desired station shown as deflection or pip on screen.

AUDIBLE SINGLE SIGNAL OBSERVATION

This type of operation is used for listening simultaneously to a station heard through the receiver and to a second signal up to 100 kilocycles on either side of this station.

With the phones or audio amplifier plugged into the adapter and the equipment adjusted for visible panoramic:

1. Tune the receiver to any desired signal.
2. Tune the panoramic adapter to the second signal by first centering its deflection on the screen with the CENTERING control.
3. Gradually turn the SCANNING WIDTH control to zero at the same time the deflection is restored to center, should it shift sidewise.
4. Trim the CENTERING control for maximum volume and thereafter—
5. Use the SENSITIVITY control to obtain the desired audio level.

Other stations may be tuned in on the adapter, one at a time, simply by turning the CENTERING control while the SCANNING WIDTH control is set at zero. However to tune in signals of known frequency, it is best to restore the adapter to visible panoramic operation and select the deflection of a signal whose frequency is known with respect to the station heard through the receiver. The same procedure described in the paragraph above, is used to tune in this signal through the adapter.

OWNER'S MAINTENANCE

REPLACING TUBES:—It will be necessary to remove the adapter chassis in order to replace tubes. This can be accomplished by removing the three screws which hold the cover to the front panel and one screw at the rear. When replacing tubes, check the tube type carefully and replace with the correct type. Refer to the top view of the adapter chassis and to the illustration below for the correct location of each tube. Use precaution when replacing cathode ray tube.

PERIODIC ADJUSTMENTS:—This adapter has been carefully adjusted at the factory and should not require any further adjustments until it requires new tubes in the r-f amplifier and converter stages or shows signs of loss in sensitivity or requires service work on these stages. Adjustment should not be attempted by inexperienced persons as maximum performance is obtained only by intelligent alignment.

In the event your Skyrider Panoramic requires service or repairs, contact your nearest Hallicrafter's distributor, who is authorized to handle service and repairs of Hallicrafter's products after warranty has run out.

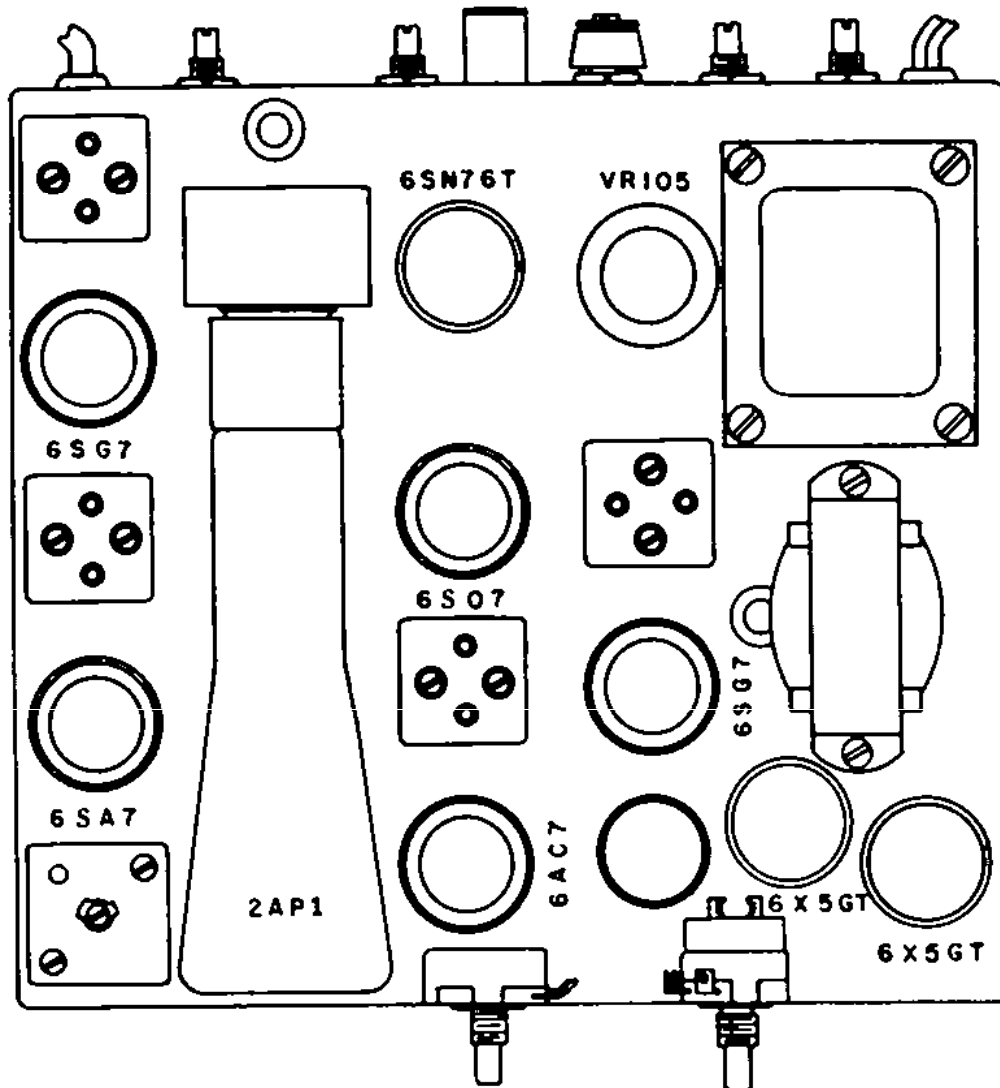

Figure 7. Skyrider Panoramic Model SP-44, top view showing tube locations.

REMOVAL AND INSERTION OF THE CATHODE-RAY TUBE

a. TUBE REMOVAL.

(1) Remove the rubber strip around the tube shield. Seize one side of its seam, underneath the shield, and gently pull it away from the front of the panel.

(2) Push the shield slightly forward through the panel.

(3) Carefully pry the tube out of its socket with a screwdriver.

(4) Remove the grommets at the rear end of the shield.

(5) Tilt the rear end of the shield upward and remove the tube.

b. TUBE INSERTION.

(1) Place the tube into the shield. Position the Panoramic screen in the shield.

(2) Insert the shield into the front panel.

(3) Place the rubber grommet in the side holes of the shield. The *long* end of the grommet goes inside the shield.

(4) Line up the shield and tube key with the socket.

(5) Insert the tube into the socket. To do this, hold the socket bracket and gently push on the *center* of the Panoramic screen.

(6) Ease the rubber strip into the clearance between the shield and front panel. Start at the bottom of the shield and gradually work the strip completely around the shield.

(7) Fit the Panoramic screen snug against the tube by gently pushing the shield back into the chassis.

SERVICE BULLETIN FOR SKYRIDER PANORAMIC MODEL SP-44

GENERAL: The model SP-44 Skyrider Panoramic is a device designed for operation in conjunction with a companion receiver for the purpose of monitoring up to 200 kc of the radio spectrum visually. This adaptor may be used with any receiver having an I-F frequency between 450 and 470 kc.

REAR PANEL CONNECTIONS: Consists of a line cord with plug, phone jack for monitoring purposes, and R-F coupling cable to companion receiver.

POWER SUPPLY DATA: 105-125 volts AC, 50-60 cycles, power drain is approximately 55 watts.

TUBE TYPES AND FUNCTIONS: 6SG7 R-F amplifier, 6SA7 converter, 6SG7 I-F amplifier, 6SQ7 detector-video amplifier, 6AC7 reactor, VR-105 voltage regulator, 6SN7 saw tooth generator and amplifier, 2AP1 cathode ray tube, 6X5 low voltage rectifier, 6X5 high voltage rectifier.



Compensates for varying prospector characteristics of receiver.

Controls bandwidth coverage from 300 kc down to zero.

Controls height of cathode ray tube deflections and audio output level.

Maintains "pip" of signal heard through receiver over center zero mark also tune adapter through 300kc.

Fig. 1. Skyrider Panoramic Model SP-44, view showing operating controls.

a. ALIGNMENT PROCEDURE. — Allow the PANADAPTOR to reach operating temperature to assure stable operation. This may require 10-20 minutes. Adjust the screwdriver controls, INTENSITY and FOCUS, for optimum brightness and sharpness of the baseline trace. Note: Reduction of the intensity and proper adjustment of the Focus control produces a sharp baseline. Bring the baseline trace in coincidence with the lowest horizontal line on the screen by means of the VERTICAL POSITION Control.

Adjust the HORIZONTAL POSITION Control

so that the baseline is approximately centered along the horizontal axis.

Determine whether the horizontal sweep is synchronized to half the line of frequency by introducing hum into the grid (pin #2) of the 6SQ7 (use finger or screwdriver). A double hump should appear on the baseline if the circuit is operating correctly. If it does not; refer to the Troubleshooting Chart.

The Panoramic screen is used as the alignment indicator. Signals should be kept below the saturation level by limiting the signal generator output voltage.

continued

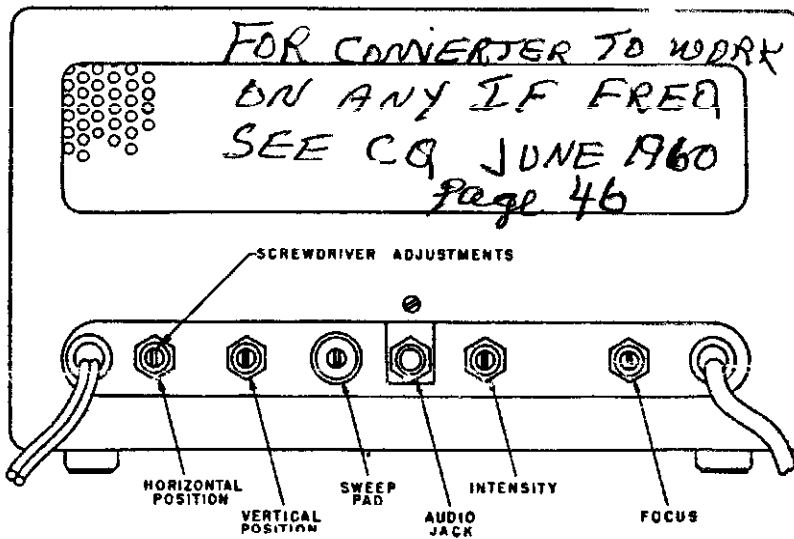

Fig. 2. View showing operating control functions

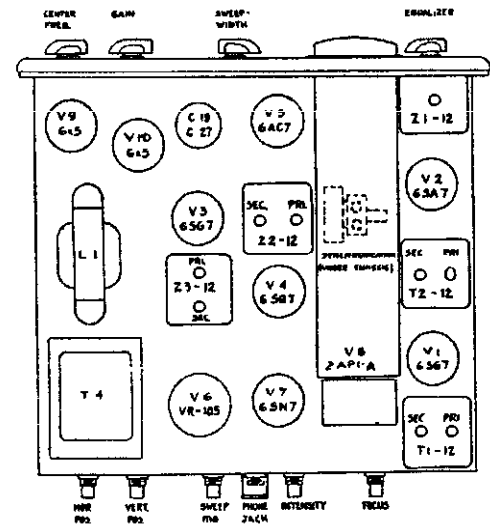

Fig. 3. Top View of Chassis.

continued from page 1

Alignment of	Signal Generator Output	Position of Controls	Procedure
I.F. Amplifier	226KC unmodulated to pin #8 of V2.	SWEEPWIDTH at zero position. CENTER FREQ. turned extreme counter-clockwise.	Entire baseline deflects upward. Adjust the trimmers in the I.F. transformers (Z2-12, Z3-12) for maximum deflection.
F.M. Oscillator	455KC (or I.F. of the receiver) unmodulated to pin #8 of V2.	SWEEPWIDTH at maximum. SWEEP PAD set half way. CENTER FREQ. at center or zero position.	A "pip" will appear on the screen. Adjust the trimmer in the oscillator transformer Z1-12, to bring "pip" to the center of the screen. Turn the SWEEPWIDTH control to almost zero for more accurate indications of proper trimmer adjustment. Return the SWEEPWIDTH control to maximum and adjust the HORIZONTAL POSITION control so that the "pip" is directly over the zero mark on the screen.
Linearity of Sweep	355KC - 555KC (or I.F. of the receiver ± 100 KC) unmodulated to pin #8 of V2.	SWEEPWIDTH at maximum. CENTER FREQ. at center or zero position.	Set the signal generator for 555KC (or receiver I.F. +100KC) and bring the "pip" to the -100KC mark by means of the SWEEP PAD. Shift the signal generator frequency to 355KC (or receiver I.F. -100KC). The "pip" should be at the +100KC mark. If the linearity is incorrect, the deflections appear more than 10KC or $\frac{1}{2}$ division from each end with 455KC or I.F. deflection in the center of the screen. Some correction is possible by trial and error adjustment of the oscillator trimmer (Z1-12) and the CENTER FREQ. control. If after the adjustment is made the CENTER FREQ. control knob is off center for a 455KC (or receiver I.F.) deflection at the zero mark on the screen, unscrew and reset the knob to the center position.
R.F. Bandpass Amplifier	355KC - 545KC (or I.F. of receiver) ± 90 KC) unmodulated to a 50K resistor in series with the full length of input cable to the PANADAPTOR.	Set GAIN to maximum. Turn EQUALIZER fully clockwise. Set CENTER FREQ. control to zero.	Set the signal generator at 545KC (or receiver I.F. +90). Back off the side side trimmers on both R.F. transformers (T1-12, T2-12) and align the top trimmers for maximum deflection. Shift signal generator to 365KC (or receiver I.F. -90) and tune the two side trimmers for maximum deflection. Repeat both adjustments. The ratio of the peak to center heights (peak to valley) should be greater than 20:1.

TROUBLE SHOOTING CHART.

<u>Symptom</u>	<u>Causes and Cures</u>	<u>Symptom</u>	<u>Causes and Cures</u>
1. No illumination of the cathode ray tube, V8.	<ol style="list-style-type: none"> AC power is off. <ol style="list-style-type: none"> See if tubes are lit. Fuse inside chassis burned out. Check ON-OFF switch. INTENSITY and FOCUS controls out of adjustment. Defective cathode ray tube, or rectifiers V9, V10. Defective high voltage power supply. Tubes not seated properly in sockets. Shorted filter condensers C17, C18. Open resistors R16, R34. 		<ol style="list-style-type: none"> Test PANADAPTOR for center deflection with a signal generator set at 455KC (or LF. of receiver) to the input (disconnected from receiver). Increase SWEEPWIDTH control to maximum sweep.
2. Baseline trace cannot be made sharp and bright.	<ol style="list-style-type: none"> AC power input below 115V. Check high voltage power supply (V10). Defective cathode ray tube. Check condition of INTENSITY and FOCUS controls for possible opens. Check resistance of R16, R36, R37 and R39. 	7. Whole baseline moves vertically when receiver is tuned.	<ol style="list-style-type: none"> F.M. sweep is not operating, and set behaves as though the SWEEPWIDTH control is set at zero. Check V5. Use an oscilloscope to check sawtooth at pin #4 of V5. Strong local stations coming through the receiver and beating against one another in the input stages of the PANADAPTOR to produce 226KC. Remedy would be to align receiver or install wave traps.
3. Baseline trace cannot be made to coincide with screen baseline.	<ol style="list-style-type: none"> Check high voltage power supply (V10). Check V4 if unable to get vertical position. Check R31. Check the voltage on the cathode ray tube deflection plates against the voltages specified on the Voltage Chart. 	8. Baseline remains at top of the screen regardless of tuning.	<ol style="list-style-type: none"> I.F. amplifier may be oscillating. Change V3, V6. Check C4, C28. Compare V3 voltage against voltage chart. Video amplifier V4 may be inoperative. Change V4. Compare V4 voltages against Voltage Chart.
4. Stationary spot on the screen.	<ol style="list-style-type: none"> Check V7. Trace the sawtooth voltage with an oscilloscope from the blocking oscillator V7 to V8. Check R18, R20. 	9. Low gain. Able to hear weak signals but cannot see them on PANADAPTOR screen.	<ol style="list-style-type: none"> Check all tubes. Most likely to be weak V3, V4. Check voltages, especially screen voltage of V3. Misaligned I.F. transformers. <i>Note:</i> Do not attempt alignment until <i>absolutely</i> certain that alignment is at fault.
5. Jumpy baseline or flickering images.	<ol style="list-style-type: none"> Sawtooth Generator is not synchronized to half the line frequency. Change V7. Check the values of the resistors and condensers R18, R19, R20, R21, C20, C21. Feed the AC voltage from pin No. 7. of "V4" through a 500 mmf condenser to pin No. 2 of the same tube. Adjust synchronization potentiometer under the chassis until two stationary peaks appear on the screen, when the adjustment is completed, remove the AC voltage from pin No. 2. 	10. Symptoms of misalignment.	<ol style="list-style-type: none"> Do not attempt alignment until the set has been thoroughly checked for faults. Be sure that the error limits, as given in the specifications, for the PANADAPTOR, are exceeded before concluding that alignment is necessary.
6. No signals.	<ol style="list-style-type: none"> Check connection to receiver. Turn up GAIN control. Check operation of the receiver. 	<ol style="list-style-type: none"> Low gain. "Pips" too wide. The double peaked response of the hand pump amplifier is not peaked at points 10KC from each end of the scale. Frequency range of signals on the screen is other than 200KC at maximum sweep-width. Range of the CENTER FREQUENCY control is less than 200KC. Pip generated by an unmodulated signal is non-symmetrical. 	

VOLTAGE CHART.

Voltmeter 1,000 ohms per volt.
Line voltage 115V

Circuit Symbol	Type	Function	PIN NUMBER										
			1	2	3	4	5	6	7	8	9	10	11
V1	6SG7	R. F. Amplifier.....	0	0	17	0	17	115	6.3AC	380			
V2	6SA7	Converter.....	0	0	380	105	0	0	6.3AC	-1.3			
V3	6SG7	I. F. Amplifier.....	0	0	2.4	0	2.4	115	6.3AC	380			
V4	6SQ7	Det. Video Amp.....	0	0	0	0	0	125	6.3AC	0			
V5	6AC7	Reactor.....	0	0	0	0	3.3	105	6.3AC	360			
V6	VR105	Voltage Reg.....			380		105			380			
V7	6SN7	Sawtooth Gen. and Amplifier.....	0	60	5	-0.2	3	0	6.3AC	0			
V8	2AP1-A	CRT Indicator.....	-420	-420	140	-100	0	SL	160	175	155	-490	-420
V9	6 x 5	L. V. Rectifier.....			325AC			325AC	6.3AC	390			
V10	6 x 5	H. V. Rectifier.....			-700			-700	6.3AC	325AC			

Notes:—GAIN at minimum, SWEEPWIDTH at maximum, all other controls at normal position. SL indicates slight movement.

VOLTAGE CHART.

Voltmeter 25,000 ohms per volt.
Line voltage 115V.

Circuit Symbol	Type	Function	PIN NUMBER										
			1	2	3	4	5	6	7	8	9	10	11
V1	6SG7	R. F. Amplifier.....	0	0	20	0	20	120	6.3AC	380			
V2	6SA7	Converter.....	0	0	380	105	0	0	6.3AC	-3.0			
V3	6SG7	I. F. Amplifier.....	0	0	2.7	0	2.7	120	6.3AC	380			
V4	6SQ7	Det. Video Amp.....	0	0	0	0	0	150	6.3AC	0			
V5	6AC7	Reactor.....	0	0	0	0	3.4	105	6.3AC	360			
V6	VR105	Voltage Reg.....			380		105			380			
V7	6SN7	Sawtooth Gen. and Amplifier.....	0	150	8.2	-7.3	50	0	6.3AC	0			
V8	2AP1-A	CRT Indicator.....	-480	-600	165	-380	0	115*	185	250	185	-650	-600
V9	6 x 5	L. V. Rectifier.....			325AC			325AC	6.3AC	390			
V10	6 x 5	H. V. Rectifier.....			-740			-740	6.3AC	325AC			

Notes:—GAIN at minimum, SWEEPWIDTH at maximum, all other controls at normal position. *Voltage reading varies according to scale used.

RESISTANCE CHART.

Circuit Symbol	Type	Function	PIN NUMBER										
			1	2	3	4	5	6	7	8	9	10	11
V1	6SG7	R. F. Amplifier.....	0	0	200	20	200	40K	0	50K			
V2	6SA7	Converter.....	0	0	50K	70K	20K	5	0	15K			
V3	6SG7	I. F. Amplifier.....	0	0	500	1 Meg.	500	40K	0	50K			
V4	6SQ7	Det. Video Amp.....	0	500K	0	0	500K	250K	0	0			
V5	6AC7	Reactor.....	0	0	0	500K	1K	70K	0	53K			
V6	VR105	Voltage Reg.....			0	50K	70K			50K			
V7	6SN7	Sawtooth Gen. and Amplifier.....	2 Meg.	550K	20K	1.3Meg.	3.5Meg.	0	0	0			
V8	2AP1-A	CRT Indicator.....	2.5Meg.	2.5Meg.	250K	1.5Meg.		1 Meg.	75K	150K	75K	2.5Meg.	2.5Meg.
V9	6 x 5	L. V. Rectifier.....		0	270	2.5Meg.	250		0	50K			
V10	6 x 5	H. V. Rectifier.....		0	3 Meg.	3 Meg.	3 Meg.		0	250			

Notes:—GAIN and SWEEPWIDTH at maximum, all other controls at normal position. K=1,000 ohms, Meg.=megohms, all other resistances are in ohms.

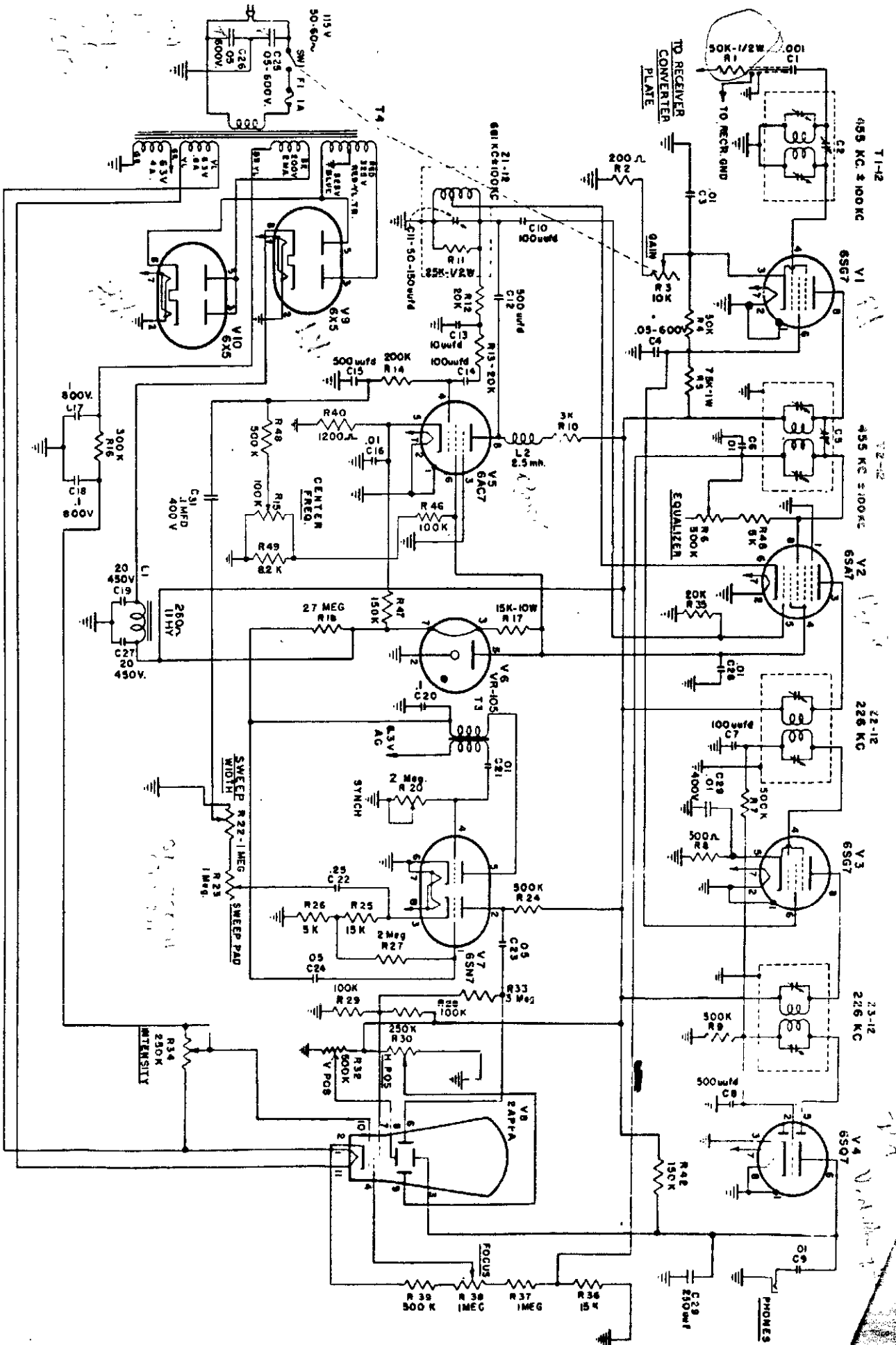

- NOTES
1. ALL CONDENSER VALUES ARE IN μ S EXCEPT AS NOTED.
 2. RESISTOR VALUES DESIGNATED "K" ARE IN THOUSANDS (OHMS).
 3. C19 AND C27 CAN BE 2" IS MFD.-450V.

Fig. 4. Circuit Diagram, For Skyrrider Panoramic Model SP-44

89C243-A