

**Assembling  
and Using Your...**

**Heathkit**

**AUDIO  
ANALYZER**

**MODEL AA-1**

**HEATH COMPANY**

*A Subsidiary of Daystrom Inc.*

**BENTON HARBOR, MICHIGAN**

# STANDARD COLOR CODE — RESISTORS AND CAPACITORS

## AXIAL LEAD RESISTOR

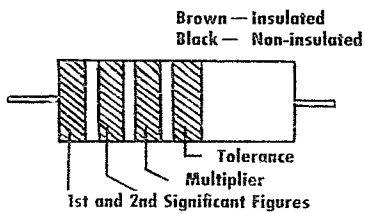

Wire wound resistors have 1st digit band double width

| INSULATED UNINSULATED Color | FIRST RING BODY COLOR First Figure | SECOND RING END COLOR Second Figure | THIRD RING DOT COLOR Multiplier |
|-----------------------------|------------------------------------|-------------------------------------|---------------------------------|
| BLACK                       | 0                                  | 0                                   | None                            |
| BROWN                       | 1                                  | 1                                   | 0                               |
| RED                         | 2                                  | 2                                   | 00                              |
| ORANGE                      | 3                                  | 3                                   | ,000                            |
| YELLOW                      | 4                                  | 4                                   | 0,000                           |
| GREEN                       | 5                                  | 5                                   | 00,000                          |
| BLUE                        | 6                                  | 6                                   | 000,000                         |
| VIOLET                      | 7                                  | 7                                   | 0,000,000                       |
| GRAY                        | 8                                  | 8                                   | 00,000,000                      |
| WHITE                       | 9                                  | 9                                   | 000,000,000                     |

## DISC CERAMIC RMA CODE

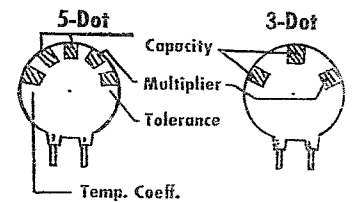

## RADIAL LEAD DOT RESISTOR

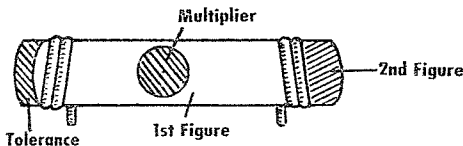

## 5-DOT RADIAL LEAD CERAMIC CAPACITOR

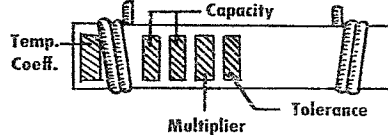

## EXTENDED RANGE TC CERAMIC HICAP

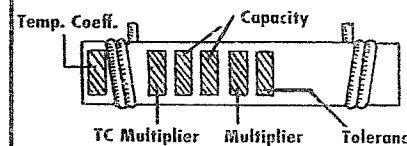

## RADIAL LEAD (BAND) RESISTOR

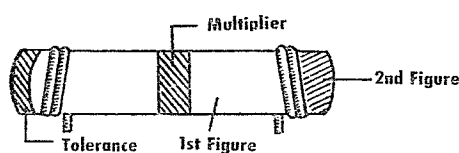

## BY-PASS COUPLING CERAMIC CAPACITOR

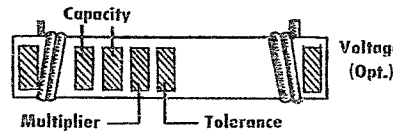

## AXIAL LEAD CERAMIC CAPACITOR

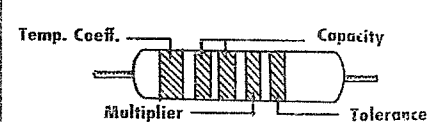

The standard color code provides all necessary information required to properly identify color coded resistors and capacitors. Refer to the color code for numerical values and the zeroes or multipliers assigned to the colors used. A fourth color band on resistors determines tolerance rating as follows: Gold = 5%, silver = 10%. Absence of the fourth band indicates a 20% tolerance rating.

The physical size of carbon resistors is determined by their wattage rating. Carbon resistors most commonly used in Heathkits are 1/2 watt. Higher wattage rated resistors when specified are progressively larger in physical size. Small wire wound resistors 1/2 watt, 1 or 2 watt may be color coded but the first band will be double width.

## MOLDED MICA TYPE CAPACITORS

### CURRENT STANDARD CODE

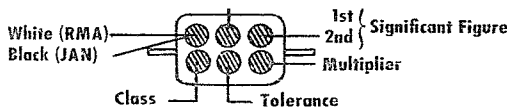

JAN & 1948 RMA CODE

### RMA 3-DOT (OBSOLETE) RATED 500 W.V.D.C. ± 20% TOL.

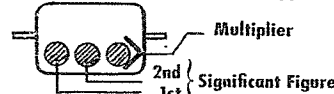

### BUTTON SILVER MICA CAPACITOR

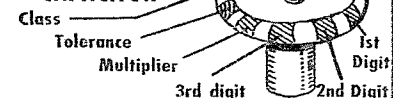

### RMA (5-DOT OBSOLETE CODE)

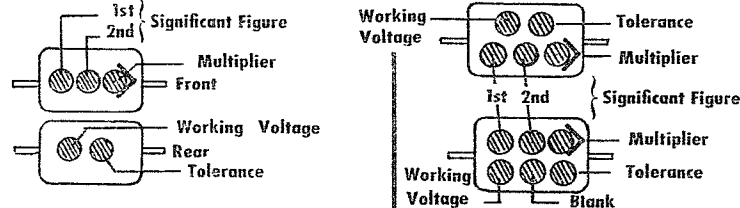

### RMA 6-DOT (OBSOLETE)

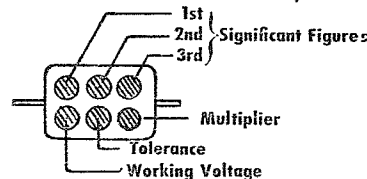

### RMA 4-DOT (OBSOLETE)

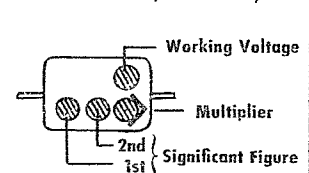

## MOLDED PAPER TYPE CAPACITORS

### TUBULAR CAPACITOR

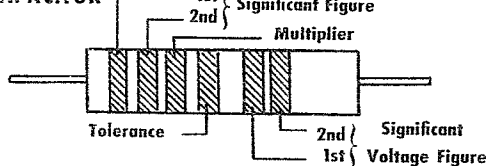

Normally stamped for value

### MOLDED FLAT CAPACITOR

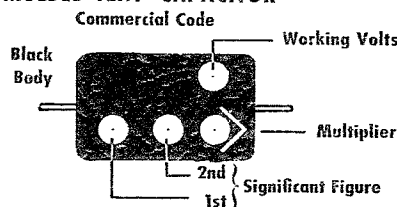

### JAN. CODE CAPACITOR

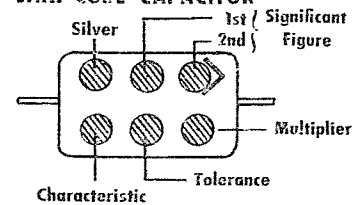

A 2 digit voltage rating indicates more than 900 V. Add 2 zeros to end of 2 digit number.

The tolerance rating of capacitors is determined by the color code. For example: red = 2%, green = 5%, etc. The voltage rating of capacitors is obtained by multiplying the color value by 100. For example: orange = 3 × 100 or 300 volts. Blue = 6 × 100 or 600 volts.

In the design of Heathkits, the temperature coefficient of ceramic or mica capacitors is not generally a critical factor and therefore Heathkit manuals avoid reference to temperature coefficient specifications.

# ASSEMBLY AND OPERATION OF THE HEATHKIT AUDIO ANALYZER MODEL AA-1

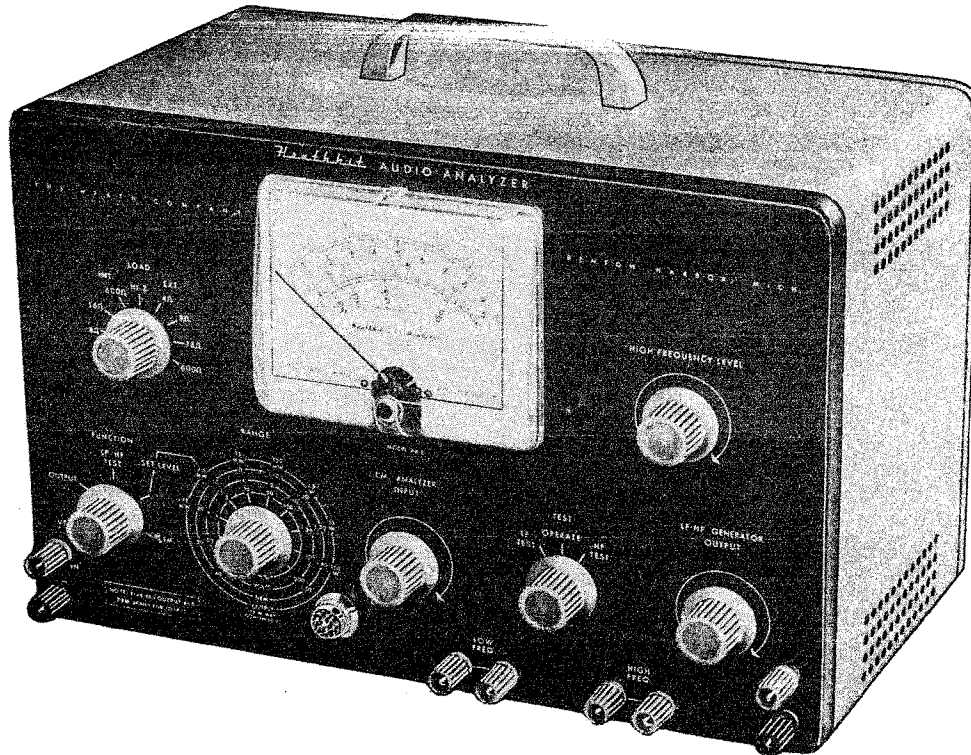

## SPECIFICATIONS

### Frequency Response:

|                                     |                                 |
|-------------------------------------|---------------------------------|
| AC VTVM.....                        | 10 cycles to 100 kc $\pm 1$ db. |
| Wattmeter .....                     | 10 cycles to 50 kc $\pm 1$ db.  |
| I.M. Analyzer High Pass Filter..... | 2000 cps to 12000 cps.          |
| I.M. Analyzer Low Pass Filter ..... | 10 cps to 600 cps.              |

### Sensitivity:

|                     |   |
|---------------------|---|
| AC VTVM.....        | 10 millivolts full scale maximum.   |
| Wattmeter .....     | .15 milliwatts full scale maximum.  |
| I.M. Analyzer ..... | .04 volts minimum high frequency signal required<br>or .17 volts of LF and HF energy mixed 4:1. |

### Range:

|                     |  |
|---------------------|--|
| AC VTVM.....        | .01, .03, .1, .3, 1, 3, 10, 30, 100, 300 volts RMS<br>full scale.  |
| DBM.....            | -40, -30, -20, -10, 0, +10, +20, +30, +40, +50<br>reads from -65 to +52 dbm.   |
| Wattmeter .....     | .15 mw, 1.5 mw, 15 mw, 150 mw, 1.5 w, 15 w,<br>150 w full scale. Maximum continuous power 25<br>watts, intermittent power to 50 watts. |
| I.M. Analyzer ..... | 1%, 3%, 10%, 30%, 100% full scale.   |

### Input Impedance:

|                     |  |
|---------------------|--|
| AC VTVM.....        | 1 megohm or 4, 8, 16 or 600 $\Omega$ , switch selected.                          |
| I.M. Analyzer ..... | 1 megohm or 4, 8, 16 or 600 $\Omega$ , switch selected.                          |
| Wattmeter .....     | 4, 8, 16 or 600 $\Omega$ internal load, 10,000 $\Omega$ across<br>external load. |

**Output Impedance:**

Low and High Frequency Output..... 3000 Ω (600 Ω when shunted with 750 Ω resistor).

**Internal Generator Frequencies:**

Low Frequency..... 60 cycles.

High Frequency..... Approximately 6 kc.

**Accuracy:**

AC VTVM and Wattmeter..... Within 5% of full scale.

I.M. Analyzer..... Within 10% of full scale.

**General:**

Multipliers..... Precision type.

Meter..... 4 1/2" streamlined case with 200 microampere movement.

Meter Rectifier..... Germanium diode bridge.

Tube Complement..... 1 - 12AT7

1 - 12AU7

1 - 12AX7

1 - 6C4

1 - 6X4

Power Supply..... Transformer, full wave rectifier.

Power Requirements..... 105-125 volts 50/60 cycles 20 watts.

Dimensions..... 13" wide x 8 1/2" high x 7" deep.

Net Weight..... 9 lbs.

Shipping Weight..... 13 lbs.

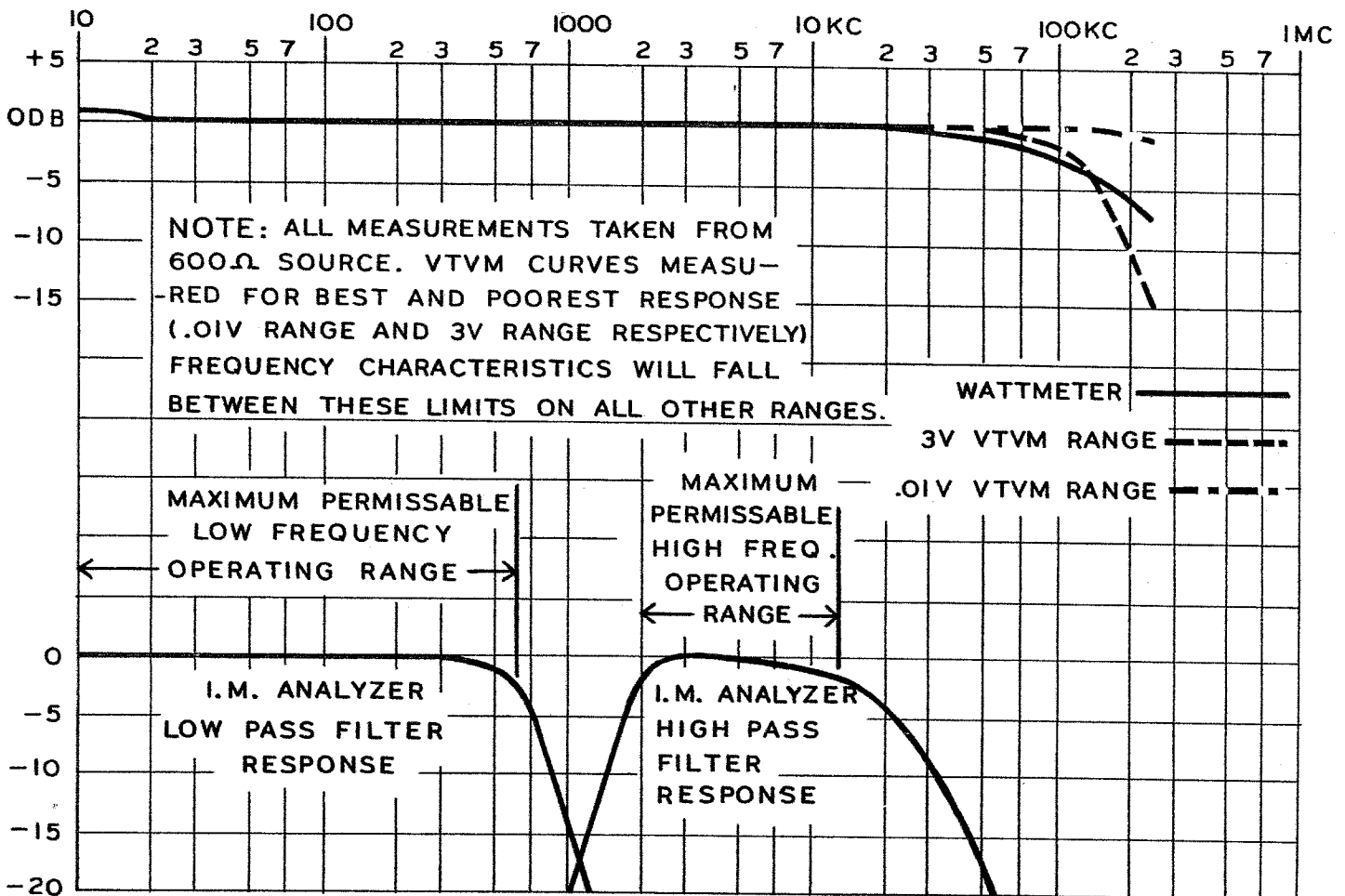

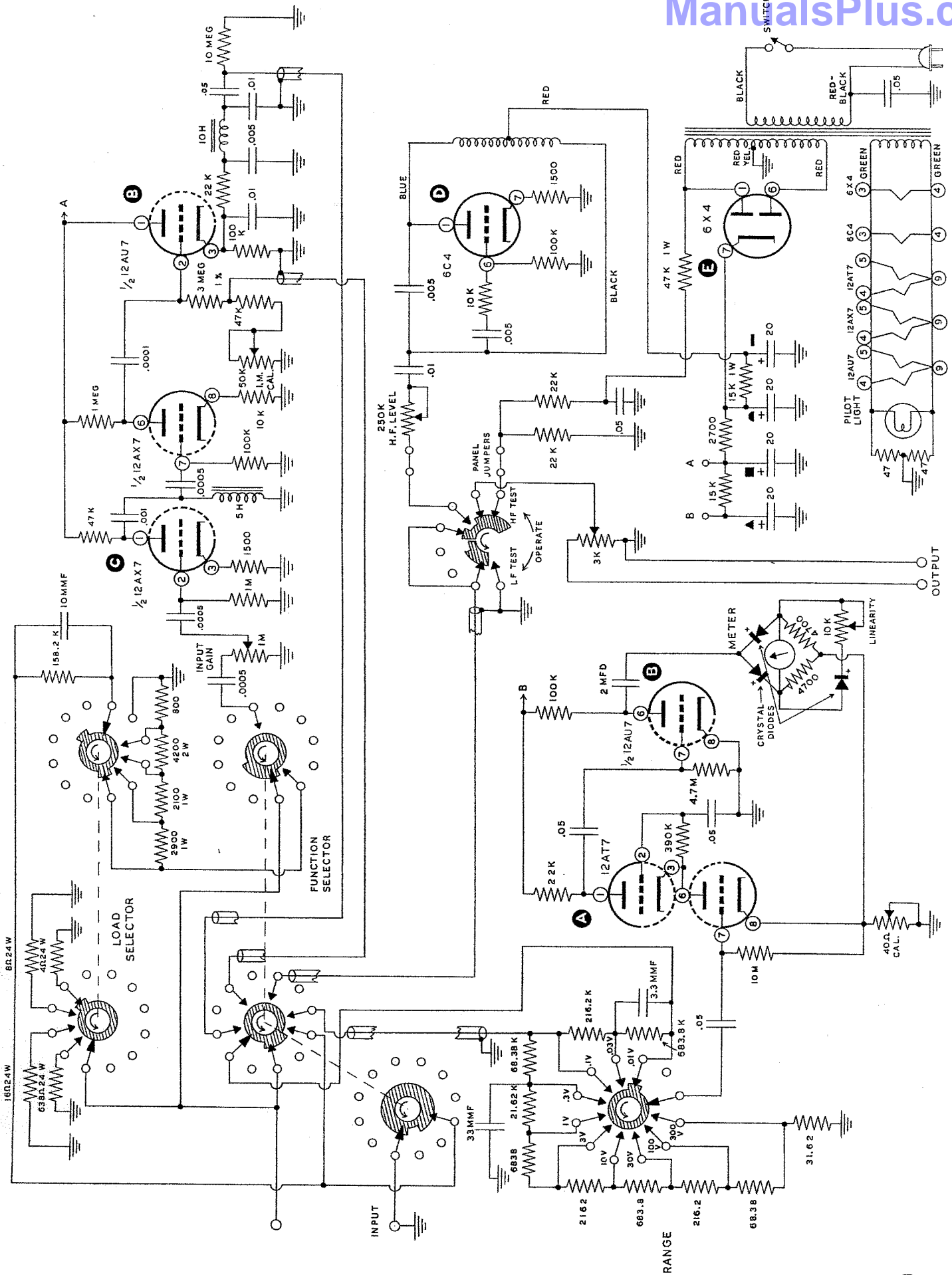

HEATHKIT AUDIO ANALYZER MODEL AA-1

## INTRODUCTION

The Heathkit Audio Analyzer model AA-1 is a unique instrument, logically combining the functions of three important and useful audio test devices. Careful design allows a maximum in performance, flexibility and utility at the lowest possible cost. Care exercised in the construction of the instrument will be well rewarded with stable, trouble-free service.

Functions of the audio wattmeter, high sensitivity AC VTVM and intermodulation analyzer are all available in one instrument, which gives the operator a chance to make a very thorough analysis of audio equipment performance without the necessity of cluttering the workbench with various instruments and a sometimes bewildering number of test leads. Power output, noise, gain, overload and intermodulation characteristics can be determined quickly and accurately using the two sets of test leads furnished and the flexible switching system incorporated in the analyzer. Non-inductive load impedances of 4, 8, 16 and 600  $\Omega$  are built in and can be selected for any function by rotating the load selector switch to the desired resistance. A high impedance position is also provided for stage-to-stage and other high impedance circuit analyses.

Low and high frequencies are generated within the instrument and they can be taken out separately for testing purposes or mixed for I. M. measurements.

## CIRCUIT DESCRIPTION

**A. C. VOLTMETER:** Three stages are employed to provide the amount of gain required to give a 10 millivolt full scale sensitivity. A 12AT7 tube is connected in a cascode type circuit which provides very high gain with relatively low noise level. Signal is applied to the control grid through the input selector switch and VTVM decade. The first half of the tube acts as a conventional voltage amplifier. Its plate load is made up of the plate resistance of the second half of the tube and the 22 K $\Omega$  resistor connected to B+. Voltage amplified by the first half of the tube is connected directly to the cathode of the second half, causing it to swing exactly the same amount. Gain in the second half of the tube is accomplished by effectively tying the grid to ground through a .05  $\mu$ fd condenser and isolating the grid from the cathode with a 390 K $\Omega$  resistor. Thus, the grid remains at a fixed potential while the cathode voltage is varied, causing the tube to act as though the grid potential were changing. Operation is much the same as a grounded grid amplifier. Loading for the second half of the 12AT7 is provided by a 22 K $\Omega$  resistor. Energy from the second half of the 12AT7 is coupled through a .05  $\mu$ fd condenser to the grid of the meter amplifier, one half of a 12AU7 tube. Additional current amplification takes place in this tube and output energy is coupled to the meter rectifier through a 2  $\mu$ fd capacitor.

Two diodes are used in a half-wave bridge circuit to furnish D. C. current for the 200 micro-ampere meter. Current returns to ground through the 4700  $\Omega$  resistors and the calibration control which complete the bridge. Since the 4700  $\Omega$  resistors return to the cathode of the VTVM input stage, inverse feedback is applied. Calibration is obtained by adjusting the calibration control which varies the cathode resistance. A change of resistance in the cathode of the input stage will change the amount of feedback and consequently, the gain.

Most crystal diodes have a non-linear characteristic at low voltage levels causing non-linearity or poor decading to be evident at the low end of the meter scale. Compensation for this characteristic is provided in case it should become evident. Detector non-linearity is compensated for by making the meter movement non-linear in the opposite direction. Another diode and a variable resistor are shunted across the meter allowing adjustment of meter linearity, thus providing excellent decading accuracy.

**WATTMETER:** Measurement of power requires the use of the AC VTVM previously described, and precision compensation networks to correct the voltage in relation to the power dissipated in the high wattage load resistors. Since the power dissipated is related to the voltage out of the input network, the meter scale can be calibrated directly in watts, or power. External or internal loads of 4, 8, 16 or 600  $\Omega$  are selected by rotating the load selector switch to the desired position. The voltage correcting resistors are automatically connected in the correct sequence at the same time. Output from this network is connected to the VTVM decade or range switch. Power output can be read in DBM or watts on the red meter scales.

**INTERMODULATION ANALYZER:** Operating principles of an intermodulation analyzer are much the same as a broadcast radio. Mixed low and high frequencies are fed into the analyzer, which amplifies the high frequencies but rejects all low frequencies except those actually modulating the higher frequency. This modulated high frequency signal is set to a pre-determined level and is then detected or demodulated. The remaining signal will appear as a low frequency component and is passed through a low-pass filter to remove any residual H. F. component. Whatever signal is left is intermodulation and is indicated on the meter in percentage.

A 12AX7 tube is used as a high pass amplifier. Signal is fed through the input switch to the level control through a small capacitor. Output from the control goes through another small capacitor to the grid of the first half of the 12AX7 I. M. amplifier. Small values of capacity tend to attenuate low frequencies without seriously affecting high frequencies. Amplification of the high frequency takes place in the first half of the tube and output is taken from the plate through a capacitor to an LC type high-pass filter and to the grid of the second half of the tube. The signal is amplified further here and coupled to the grid of the detector through a condenser. Two resistors and a potentiometer make up the grid load for the detector and this network is used to calibrate the analyzer. A calibrated portion of the signal is taken out of the network and fed to the VTVM as a reference when setting the operating level for I. M. measurement.

One half of a 12AU7 is used as an infinite impedance or cathode follower detector for the high frequency signal amplified by the 12AX7. Signal is rectified or detected at the grid and any modulation that may be present will be evident at the cathode of the 12AU7. Some high frequency component will still be present, but this is bypassed to ground in the low-pass filter which follows the cathode. Only low frequency signals are passed by the filter and output from this point is connected to the VTVM through the selector switch.

#### SWITCHING

**LOAD SELECTOR:** Load resistances of 4, 8, 16 and 600  $\Omega$  are selected as desired by rotating this switch. These resistances are available at all times and for all functions. A high Z (impedance) position is also provided for voltage and I. M. measurements in high impedance circuits. When external loads such as speakers are to be used, correct power measurements can still be made by switching to the proper impedance under external load. No power measurements can be made when the switch is in the HI Z position.

**FUNCTION SELECTOR:** All instrument functions are selected by the FUNCTION switch. In the first position, the input terminals are connected directly to the VTVM decade and the instrument operates as a 1 megohm input AC VTVM, unless the load selector is on one of the internal load positions.

The next function is power and the output of the wattmeter voltage-correcting divider is connected to the VTVM decade. At the same time, the input terminals are connected to the input of the dividing network. Impedance of the dividing network is 10 K $\Omega$ , so it must be disconnected for all other functions of the analyzer.

Measurement of low and high frequency test level is done in the LF-HF test position of the switch. The voltmeter will accurately indicate the true amount of signal output for each frequency separately and allows the proper ratio to be set at any desired output level. Signal from the output is connected directly to the VTVM decade through the selector switch in this position.

Initial adjustment for IM measurement is made with the switch in the SET LEVEL position. High frequency from the reference source at the grid of the 12AU7 detector is connected to the VTVM decade in this position. Proper level is obtained by placing the RANGE switch in the designated (.3 volt) position.

In the full clockwise position, the VTVM decade is connected to the output of the I. M. analyzer and low frequency intermodulation component is read directly on the meter.

**RANGE SWITCH:** VTVM decading is accomplished by use of the RANGE switch. This controls all of the functions of the AUDIO ANALYZER and the proper meter scales are marked on the front panel in terms of full scale readings. Precision 1% resistors are used and decading is arranged so that the attenuation is 10 db per step.

**TEST SWITCH:** Operating levels of the low and high frequencies can be checked individually by placing the switch in the appropriate position marked on the front panel. In the L. F. position, only the low frequency component will be available at the output terminals. Low frequency will also go to the meter when the FUNCTION switch is in the LF HF TEST position. When placed in the H. F. position, performance is the same except that only the high frequency will be available. This switch must be in the OPERATE position at all times except when the levels are being adjusted or when only one frequency is being used for testing purposes. All signal to the FUNCTION switch is shorted out in the OPERATE position to prevent high frequency cross-feed interference, which can lead to misleading results. The low to high frequency ratio set by use of the switch will hold true when in the OPERATE position and for practically all settings of the OUTPUT control without the necessity of resetting the ratio.

#### POWER SUPPLY

The power supply employs a 6X4 full wave rectifier with well filtered DC output. Plate voltage for the rectifier and filament voltage for all tubes is furnished by the power transformer, as well as voltage for the low frequency signal source. Separate filtering systems are used for the high frequency oscillator and the analyzer to insure complete isolation. Resistors are used to drop the high AC rectifier plate voltage down to a level compatible with the high frequency oscillator and a condenser is connected between two of the resistors and ground to remove all harmonic content. This insures a pure 60 cycle waveform for low frequency test purposes.

#### NOTES ON ASSEMBLY AND WIRING

The Heathkit Audio Analyzer model AA-1, when constructed in accordance with the instructions in the manual, is a high-quality instrument capable of many years of trouble free service. We therefore urge you to take the necessary time to assemble and wire the kit carefully. Do not hurry the work and you will be rewarded with a greater sense of confidence, both in your instrument and your own ability.

This manual is supplied to assist you in every way to complete the instrument with the least possible chance for error. We suggest that you take a few minutes now and read the entire manual through before any work is started. This will enable you to proceed with the work much faster when construction is started. The large fold-in pictorials are handy to attach to the wall above your work space. Their use will greatly simplify the completion of the kit. These diagrams are repeated in smaller form within the manual. We suggest that you retain the manual in your files for future reference, both in the use of the instrument and for its maintenance.

**UNPACK THE KIT CAREFULLY AND CHECK EACH PART AGAINST THE PARTS LIST.** In so doing, you will become acquainted with each part. Refer to the charts and other information shown on the inside covers of the manual to help you identify any parts about which there may be question. If some shortage is found in checking the parts, please notify us promptly and return the inspection slip with your letter to us. Hardware items are counted by weight and if a few are missing, please obtain them locally if at all possible.

Read the note on soldering on the inside of the back cover. Crimp all leads tightly to the terminal before soldering. Be sure both the lead and terminal are free of wax, corrosion or other foreign substances. Use only the best rosin core solder, preferably a type containing the new activated fluxes such as Kester "Resin-Five," Ersin "Multicore," or similar types.

**NOTE: ALL GUARANTEES ARE VOIDED AND WE WILL NOT REPAIR OR SERVICE INSTRUMENTS IN WHICH ACID CORE SOLDER OR PASTE FLUXES HAVE BEEN USED. WHEN IN DOUBT ABOUT SOLDER, IT IS RECOMMENDED THAT A NEW ROLL PLAINLY MARKED "ROsin CORE RADIO SOLDER" BE PURCHASED.**

Resistors and controls generally have a tolerance rating of  $\pm 20\%$  unless otherwise stated in the parts list. Therefore a 100 K $\Omega$  resistor may test anywhere from 80 K $\Omega$  to 120 K $\Omega$ . (The letter K is commonly used to designate a multiplier of 1000.) Tolerances on condensers are generally even greater. Limits of +100% and -50% are common for electrolytic condensers. The parts furnished with your Heathkit have been specified so as to not adversely affect the operation of the finished instrument.

In order to expedite delivery to you, we are occasionally forced to make minor substitutions of parts. Such substitutions are carefully checked before they are approved and the parts supplied will work satisfactorily. By checking the parts list for resistors, for example, you may find that a 120 K $\Omega$  resistor has been supplied in place of a 100 K $\Omega$  as shown in the parts list. These changes are self-evident and are mentioned here only to prevent confusion in checking the contents of your kit.

We strongly urge that you follow the wiring and parts layout shown in this manual. The position of wires and parts is quite critical in this instrument and changes may seriously affect the characteristics of the circuit.

#### STEP-BY-STEP ASSEMBLY INSTRUCTIONS

THE HEATHKIT AA-1 AUDIO ANALYZER IS A COMPLEX INSTRUMENT AND WE VERY STRONGLY URGE THAT THE STEP-BY-STEP INSTRUCTIONS BE FOLLOWED EXACTLY, RATHER THAN WIRING FROM THE PICTORIALS AND SCHEMATIC EXCLUSIVELY. SPECIAL INSTRUCTIONS REGARDING SEQUENCE OF ASSEMBLY AND LEAD LENGTHS ARE GIVEN TO MAKE THE CONSTRUCTION OF THE KIT AS EASY AS POSSIBLE. WIRING AND MOUNTING OF PARTS IN IMPROPER ORDER MAY RESULT IN THE NECESSITY OF RE-DOING WORK PREVIOUSLY ACCOMPLISHED.

The following instructions are presented in a simple, logical, step-by-step sequence to enable you to complete your kit with the least possible confusion. Be sure to read each step all the way through before you start to do it. When the step is completed, check it off in the space provided.

We suggest that you do the following before any work is started:

1. Attach the large fold-in pictorials to the wall above your work bench.
2. Go through the entire assembly and wiring instructions. This is an excellent time to read the entire instruction section through and familiarize yourself with the procedure.
3. Lay out all parts so that they are readily available. Refer to the general information inside the front and back covers of this manual to help you identify components.

In assembling the kit, use lockwashers under all nuts, unless otherwise specified. Tube sockets are mounted inside the chassis, the filter condenser mounting wafer is mounted above or on top of the chassis. Other details of construction are included where pertinent in the instructions.

- (✓) Place the chassis upside down on the bench. Note that the apron of the chassis has five symmetrically located holes in it. Place this side away from you. The chassis will then be as shown in Figure 1.
- (✓) Mount a 9-pin tube socket at location A. Use 3-48 screws and nuts. No lockwashers are used with 3-48 hardware. Make sure that the gap between pins 1 and 9 is toward the front chassis apron. Refer to Figure 3 and note clockwise pin numbering sequence.
- (✓) In a similar fashion, install a 9-pin tube socket at location B. The socket should be oriented in the same direction as A.
- ( ) In the same manner, mount a 9-pin socket at C, observing socket orientation as before.

Figure 1

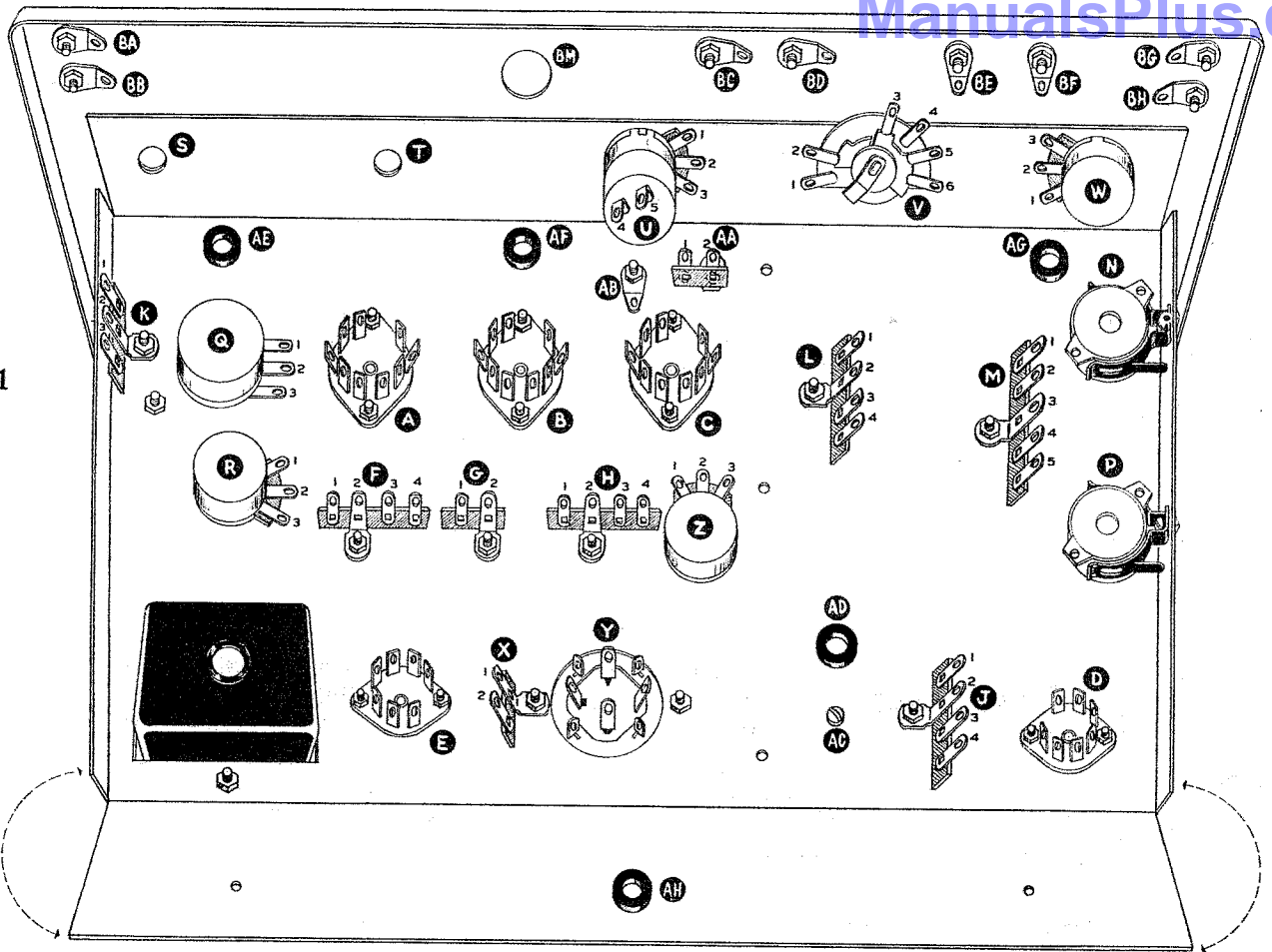
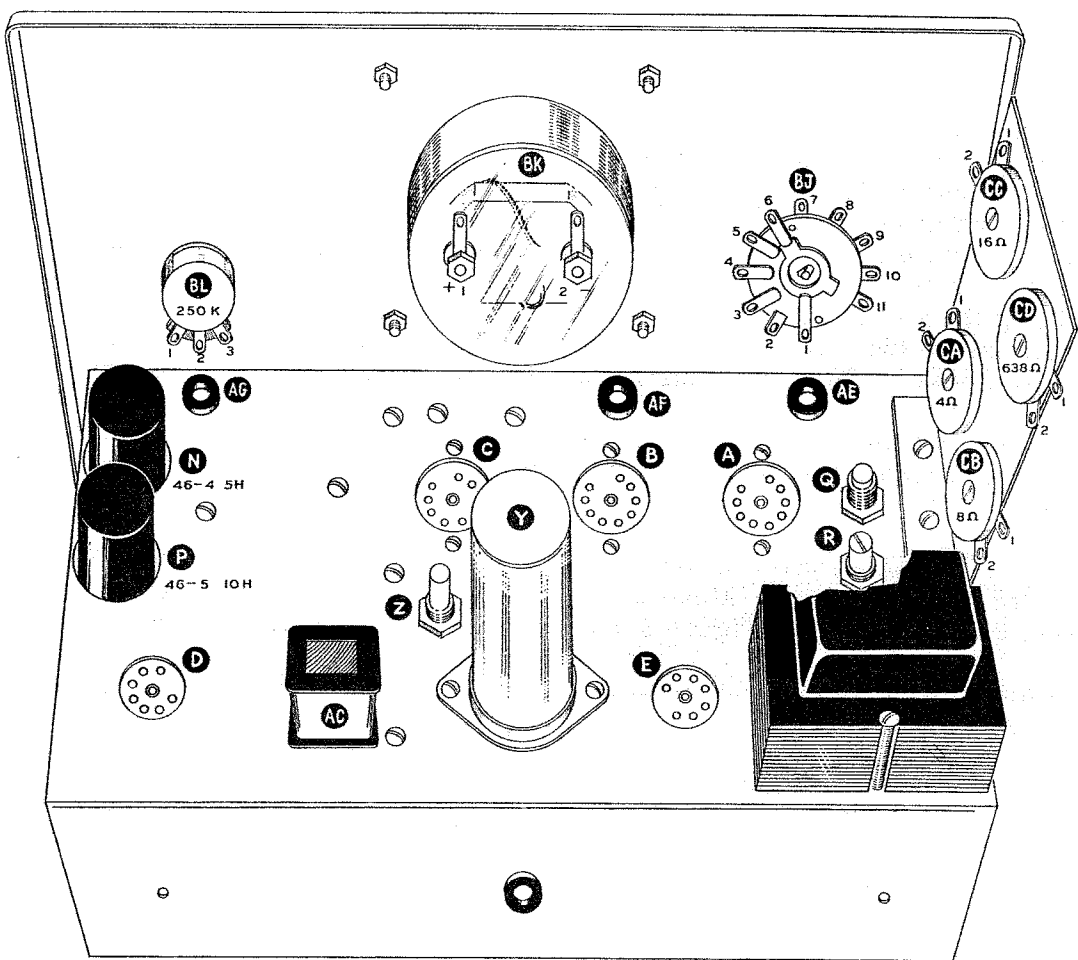

Figure 2



- (✓) Install a 7-pin tube socket at location D with 3-48 hardware. The blank space between pins 1 and 7 is toward the center of the chassis.
- (✓) Mount a 7-pin tube socket at location E with the space between pins 1 and 7 toward the chassis center.

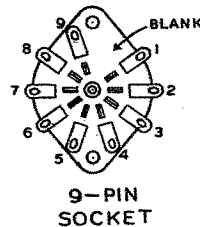
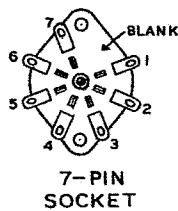

Figure 3

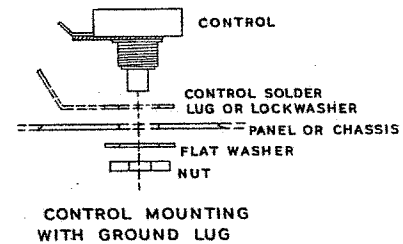

Figure 4

- (✓) Mount a 4-lug terminal strip at F as shown in Figure 1, using a 6-32 screw, lockwasher and nut.
- (✓) In the same fashion, install a 2-lug terminal strip at G.
- (✓) Install a 4-lug terminal strip at H with 6-32 hardware.
- (✓) Mount a 4-lug terminal strip at J as shown. Use the hole nearest socket D.
- (✓) Mount a 4-lug terminal strip at L as shown.
- (✓) Install a 5-lug terminal strip at M with 6-32 hardware.
- (✓) Secure a 2-lug terminal strip at AA. Note that this item is of the opposite type to the other two 2-lug strips.
- (✓) Mount a solder lug at AB. Use a 6-32 screw and nut only, for the solder lug incorporates a self-locking feature.
- (✓) Install the flat filter condenser mounting wafer at location Y, on top of the chassis. Secure the right hand side with 6-32 hardware first, then place a 6-32 screw through the wafer, chassis, 2-lug terminal strip X, a lockwasher and nut on the left side. Refer to Figure 1.
- (✓) Mount a 40  $\Omega$  wirewound control at location Q, using a lockwasher between the control and the chassis and a 3/8-32 nut on top of the chassis, as illustrated in Figure 4. Orient the lugs as shown. Bend the lugs upward if necessary to clear socket A.
- (✓) In the same manner, install a 10 K $\Omega$  control at R.
- (✓) Similarly, mount a 50 K $\Omega$  control at Z.
- (✓) Mount rubber grommets in holes AD, AE, AF, AG and AH.
- (✓) Secure a spring clip to the right hand chassis flange at location N, with a small 6-32 x 3/16 screw. The head of the screw goes inside the chassis, through the holes provided in the spring clip, the mounting hole in the flange, a #6 lockwasher and nut. Observe Figure 5. Do not use a 6-32 x 3/8 screw, for it will protrude too far and make it difficult to install the instrument in its cabinet when completed.
- (✓) In the same fashion, install a spring clip at P.
- (✓) Mount the power transformer in the large cut-out at the left rear part of the chassis. Secure with 8-32 nuts and lockwashers at the underside of the chassis. Do not remove nuts holding the transformer shells together.
- (✓) Install the multisection filter condenser on the wafer at hole Y. Make sure that the unmarked terminal is toward terminal strip J as shown. Fasten the condenser in place by twisting the mounting lugs with pliers.

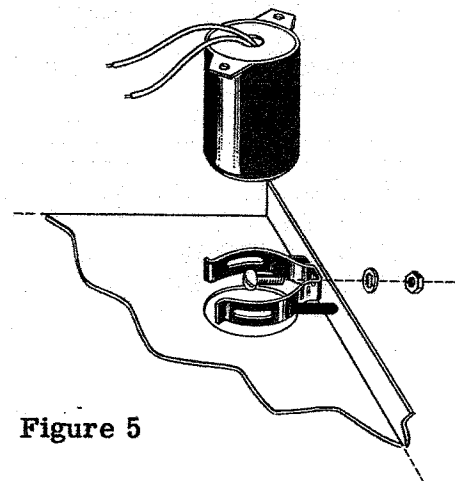

Figure 5

- (✓) Mount the high frequency oscillator coil on top of the chassis with a #6 sheet metal screw through hole AC from the bottom. Dress the coil leads through grommet AD.
- (✓) Install the load resistor mounting bracket on top of the chassis with 6-32 screws through the two holes designated K. Note that a 3-lug terminal strip is installed underneath the chassis at the hole nearest the front chassis apron. The bracket flange goes toward the chassis center so that the vertical portion is flush with the chassis edge. Check with Figures 1, 2 and 6. Bend the 3-lug terminal strip back if necessary to avoid the possibility of short circuits.

- (✓) Mount four power resistors on the bracket as shown in Figure 6. A 10-32 flat head screw goes through each resistor, the bracket, a large washer and 10-32 nut. Note that the resistors mount inside the bracket. Place the 4  $\Omega$  unit at CA, 8  $\Omega$  at CB, 16  $\Omega$  at CC and 638  $\Omega$  at CD. Bend the resistor lugs back slightly to prevent shorting to the bracket.

- (✓) On the front panel, mount a binding post base at BA. Place the post through a flat fiber washer, the panel, a solder lug and 6-32 nut. Orient the solder lug as shown in Figure 1. See Figure 7.
- (✓) In the same manner, install a binding post base at BG.

- (✓) Mount a binding post base at BH, placing the base through a shoulder fiber washer, the panel, a flat fiber washer, a solder lug and nut as in Figure 7. Make sure the shoulder washer is properly seated before tightening.
- (✓) In the same fashion, install binding post bases at BF, BE, BD, BC and BB in order, using shoulder and flat washers and orienting the solder lugs as shown in Figure 1.

- (✓) Mount the front panel on the chassis by placing a 1 megohm potentiometer with switch through hole U in the chassis and the corresponding center hole in the panel. Use a lockwasher between the control and chassis and a flat metal washer between panel and control nut. Orient control as shown in Figure 1.
- (✓) Identify the LF-HF test switch V on Figure 1 and install it at location V in the same fashion.
- (✓) In the same manner, mount a 3000  $\Omega$  control at W, orienting it as shown.

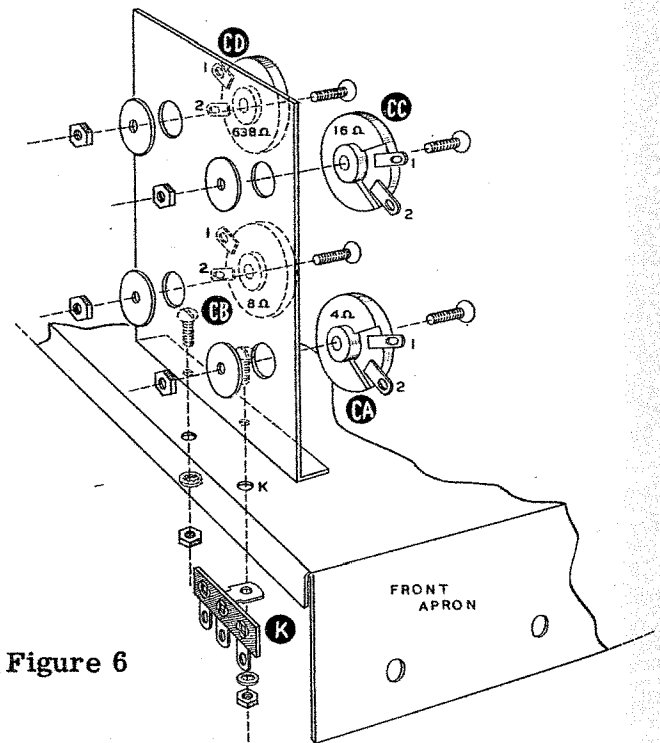

Figure 6

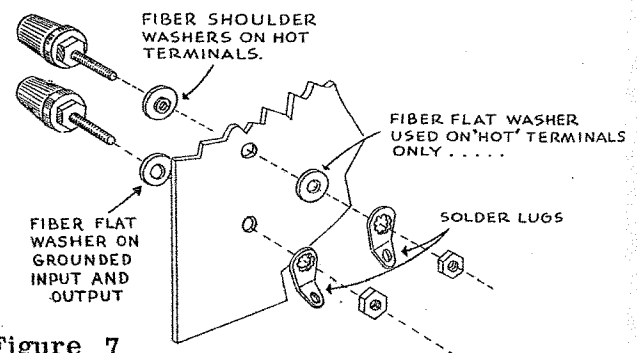

Figure 7

#### WIRING OF THE AA-1 AUDIO ANALYZER

**NOTE: ALL GUARANTEES ARE VOIDED AND WE WILL NOT REPAIR OR SERVICE INSTRUMENTS IN WHICH ACID CORE SOLDER OR PASTE FLUXES HAVE BEEN USED. WHEN IN DOUBT ABOUT SOLDER, IT IS RECOMMENDED THAT A NEW ROLL PLAINLY MARKED "ROSIN CORE RADIO SOLDER" BE PURCHASED.**

Pictorial 1 is a representation of the completed main chassis wiring. We again suggest that you use the large fold-in pictorials for reference as the work progresses. They are duplicates of the pictorials in the manual.

Read the note on the inside rear cover concerning wiring and soldering.

Refer to Pictorial 1. Note that each component part has been given a code designation which corresponds with the identification used during the assembly of the kit. In addition, each terminal on the part has also been assigned a number.

When the instructions read, "Connect one end of a 100 K $\Omega$  resistor to B3 (NS)," it will be understood that the connection is to be made to contact pin 3 of tube socket B. The abbreviation "NS" indicates that the connection should not be soldered as yet, for other wires will be added. When the last wire is installed, the terminal should be soldered and the abbreviation "S" is used to indicate this.

Unless otherwise indicated, all wire used is insulated. Wherever there is a possibility of the bare leads on resistors and condensers shorting to other parts or to chassis, the leads should be covered with insulated sleeving. This is indicated in the instructions by the phrase "use sleeving." Bare wire is used where the lead lengths are short and the possibility of short circuits non-existent.

Leads on resistors, condensers and transformers are generally much longer than they need to be to make the indicated connections. In these cases, the excess leads should be cut off before the part is added to the chassis. In general, the leads should be just long enough to reach their terminating points. Not only does this make the wiring much neater, but in many instances the excessively long leads will actually interfere with proper operation of the instrument.

The pictorials indicate actual chassis wiring, designate values of the component parts and show color coding of leads where pertinent. We very strongly urge that the chassis layout, lead placement and grounding connections be followed exactly as shown. While the arrangement shown is probably not the only satisfactory layout, it is the result of considerable experimentation and trial. If followed carefully, it will result in a stable instrument operating at a high degree of accuracy and dependability.

Please note particularly that the VTVM circuit makes no connection to chassis except at the input terminals. This use of insulated ground return is common practice in high sensitivity instruments and is very important. Improper grounding will result in instability and excessively high residual readings.

Space has been provided for you to check off each operation as it is completed. This is particularly important in wiring and it may prevent omissions or errors, especially where your work is interrupted frequently as the wiring progresses. Some kit builders have also found it helpful to mark each lead in colored pencil on the pictorial as it is added.

#### STEP-BY-STEP WIRING INSTRUCTIONS

- (✓) Cut the two green leads of the power transformer to a length sufficient to reach pins 3 and 4 of socket E. Strip and tin the leads and connect one wire to E3 (NS) and the other to E4 (NS).
- (✓) Connect a 47  $\Omega$  resistor (yellow-violet-black) from socket E3 (NS) to terminal strip X1 (NS). Dress this component close to the chassis.
- (✓) In the same manner, connect a 47  $\Omega$  resistor from E4 (NS) to X1 (NS).
- (✓) Run a piece of bare wire from socket A4 (NS) to A5 (S).
- (✓) Connect a length of bare wire from socket A3 (NS) to A6 (S).
- (✓) Connect a bare wire from socket B4 (NS) to B5 (NS).
- (✓) Connect a bare wire from socket C4 (NS) to C5 (NS).
- (✓) Connect a wire from a ground lug on condenser Y (S) to terminal strip X1 (NS).



- (✓) Cut a piece of wire to a length of 9 1/2". Cut another to a length of 11 1/2". Strip and tin both ends of both wires. Connect one end of the shorter wire to socket E3 (NS) and one end of the longer wire to E4 (NS).
- (✓) Twist the two wires together up to 1" from the end of the shorter wire and connect this lead to socket C4 (S).
- (✓) Connect the adjacent wire end to C9 (NS). Dress the wire under the edge of control Z as shown.
- (✓) Cut two wires to a length of 2 3/4". Strip and tin both ends and connect the end of one wire to socket C9 (NS). Connect an end of the other wire to C5 (NS).
- (✓) Twist the two wires together one turn and connect one end to socket B9 (NS). Connect the adjacent end to B4 (S). Dress the wires tightly to the chassis and away from unused socket pins.
- (✓) In the same fashion, cut two more wires to a length of 2 3/4". Connect one wire to B9 (S) and the other to B5 (S).
- (✓) Twist these wires one turn and connect a free end to A9 (S) and the adjacent end to A4 (S). Dress as before.
- (✓) Cut two wires to a length of 12 1/4". Strip and tin both ends and connect the end of one wire to socket E4 (S). Connect the end of the other wire to E3 (S). Twist the wires together and dress them along the back edge of the chassis toward socket D. Leave the other ends free temporarily.
- (✓) Run a piece of bare wire from control R1 (NS) to R2 (NS).
- (✓) Cut a wire to a length of 12". Strip and tin both ends and connect one end to control R2 (S). Dress the wire as shown, behind terminal strips F and G, between G and H and sockets B and C, and up through grommet AF. Leave the other end free.
- (✓) Cut a wire to a length of 11". Prepare as before and connect one end to terminal strip F3 (NS). Dress this wire along with the other up through grommet AF. Identify this, the + meter wire, with a piece of tape or by bending the free end over in some manner, so that it will be easily recognizable later on.
- (✓) Connect a .05  $\mu$ fd condenser from socket E2 (NS) to terminal strip X1 (NS).
- (✓) Connect the red-black lead of the power transformer to socket E2 (NS).
- (✓) Run the black transformer lead to E5 (NS).
- (✓) Connect the red-yellow transformer lead to terminal strip F2 (S).
- (✓) Connect one of the red transformer leads to socket E1 (NS).
- (✓) Connect the other red lead to socket E6 (S).
- (✓) Run a wire from socket E7 (S) to filter condenser Y $\blacktriangle$  (NS).
- (✓) Connect a wire from condenser Y $\blacksquare$  (NS) to socket B1 (NS).
- (✓) Run a wire from condenser Y $\blacktriangle$  (NS) to terminal strip F4 (NS).
- (✓) Install a 15 K $\Omega$  1 watt resistor (brown-green-orange) from condenser Y $\blacktriangle$  (NS) to Y $\blacksquare$  (NS).
- (✓) Connect a 2700  $\Omega$  resistor (red-violet-red) from Y $\blacktriangle$  (S) to Y $\blacksquare$  (NS).
- (✓) Connect a 15 K $\Omega$  resistor (brown-green-orange) from Y $\blacksquare$  (S) to Y $\blacktriangle$  (S).
- (✓) Run a wire from panel ground lug BA (NS) to control Q1 (NS). Dress the wire tight to the chassis and panel.
- (✓) Connect a bare wire from control Q1 (NS) to Q2 (S).
- (✓) Connect a wire from Q1 (NS) to socket B8 (NS).
- (✓) Connect a wire from Q3 (NS) to socket A8 (S).
- (✓) Install a 10 megohm resistor (brown-black-blue) from control Q3 (NS) to socket A7 (NS).
- (✓) Connect a 390 K $\Omega$  resistor (orange-white-yellow) from socket A3 (S) to A2 (NS).
- (✓) Mount a 4.7 megohm resistor (yellow-violet-green) from socket B7 (NS) to B8 (NS).
- (✓) Connect a 2  $\mu$ fd condenser from socket B6 (NS) to terminal strip F1 (NS).
- (✓) Run a 22 K $\Omega$  resistor (red-red-orange) from terminal F4 (NS) to socket A1 (NS). (Use sleeving.)

- (✓) Connect a .05  $\mu$ fd condenser from socket A1 (S) to socket B7 (S). Mount this component close to the chassis in the direction shown.
- (✓) Connect a .05  $\mu$ fd condenser from socket A2 (S) to socket B8 (NS). Dress this condenser over the .05  $\mu$ fd condenser previously installed as shown.
- (✓) Connect a 100 K $\Omega$  resistor (brown-black-yellow) from terminal strip F4 (S) to socket B6 (S).
- (✓) Connect a 4700  $\Omega$  resistor (yellow-violet-red) from control Q3 (NS) to control R1 (NS).
- (✓) Install a 4700  $\Omega$  resistor from terminal strip F3 (NS) to control Q3 (S).
- (✓) Connect a crystal diode from terminal strip F1 (NS) to control R1 (S). The end designated with a dot, bar, + sign or K is the cathode end and must connect to F1. Leave the leads fairly long and hold the lead with a clamp or pliers between the connection and the diode to prevent heat damage.
- (✓) In the same manner, connect a crystal diode from terminal strip F1 (S) to F3 (NS). The + or cathode end connects to F3.
- (✓) Likewise, connect a diode from terminal strip F3 (S) to control R3 (S). The + or cathode end connects to R3.
- (✓) Connect a 1500  $\Omega$  resistor (brown-green-red) from socket C3 (S) to terminal strip AA2 (NS). Dress close to the chassis.
- (✓) Install a 1 megohm resistor (brown-black-green) from socket C2 (NS) to terminal AA2 (NS).
- (✓) Connect a 100 K $\Omega$  resistor (brown-black-yellow) from socket C7 (NS) to ground lug AB (NS).
- (✓) Run a 10 K $\Omega$  resistor (brown-black-orange) from socket C8 (S) to ground lug AB (S).
- (✓) Connect a 47 K $\Omega$  resistor (yellow-violet-orange) from socket B1 (NS) to socket C1 (NS). (Use sleeving).
- (✓) Install a 1 megohm resistor (brown-black-green) from socket B1 (S) to socket C6 (NS).
- (✓) Connect a 1000  $\mu$  $\mu$ f ceramic condenser (brown-black-red or marked .001) from socket C1 (S) to terminal strip AA1 (NS).
- (✓) Connect a 500  $\mu$  $\mu$ f ceramic condenser (green-black-brown or marked) from socket C7 (S) to terminal strip AA1 (NS). Use sleeving and dress over the top of the 47 K $\Omega$  resistor connected to C1.
- (✓) Run a wire from terminal strip H2 (NS) to control Z3 (S).
- (✓) Run a 3 megohm precision resistor from socket B2 (NS) to terminal strip H4 (NS). (Use sleeving.)
- (✓) Connect a 100  $\mu$  $\mu$ f ceramic condenser (brown-black-brown or marked) from socket B2 (S) to socket C6 (S).
- (✓) Connect a bare wire from control Z1 (S) to Z2 (NS).
- (✓) Install a 47 K $\Omega$  resistor (yellow-violet-orange) from control Z2 (S) to terminal strip H4 (NS).
- (✓) Connect a .01  $\mu$ fd condenser (brown-black-orange or marked) from socket B3 (NS) to terminal strip H2 (NS).
- (✓) Connect a 22 K $\Omega$  resistor (red-red-orange) from socket B3 (NS) to terminal strip H3 (NS).
- (✓) Run a 100 K $\Omega$  resistor (brown-black-yellow) from socket B3 (S) to terminal strip H2 (NS).
- (✓) Install a .005  $\mu$ fd condenser from terminal strip H3 (NS) to terminal strip X1 (NS).
- (✓) Connect a .01  $\mu$ fd condenser (brown-black-orange or marked) from H1 (NS) to X1 (S).
- (✓) Run a .05  $\mu$ fd condenser from terminal strip H1 (NS) to terminal strip G1 (NS).
- (✓) Connect a 10 megohm resistor (brown-black-blue) from terminal strip G1 (NS) to G2 (NS).
- (✓) Run a wire from control U1 (S) to panel ground lug BA (NS). Dress the wire along the edge of the chassis and front panel as shown.

#### WIRING OF LOAD SELECTOR SWITCH

- (✓) Identify the load selector switch, which has eleven lugs, six on back of the wafer and five on the front side of the same wafer. The number 1 lug is the long lug to the right of the wafer mounting post at the rear section.
- (✓) Connect an 800  $\Omega$  precision resistor from switch BJ2 (NS) to BJ3 (NS).
- (✓) Connect a 4200  $\Omega$  resistor from BJ3 (S) to BJ4 (NS). Make sure that the resistor leads clear all other switch elements.

- (✓) Install a 2100  $\Omega$  resistor from BJ4 (S) to BJ5 (NS).
- (✓) Connect a 2900  $\Omega$  resistor from BJ5 (S) to BJ6 (NS).
- (✓) Cut a wire to a length of 5 1/2". Strip and tin both ends and connect one end to BJ2 (NS). Leave the other end free.
- (✓) Prepare a wire 2 1/2" long as before. Connect one end to BJ2 (S).
- (✓) Cut a wire to a length of 3 1/4". Prepare as before and connect one end to BJ1 (S).
- (✓) Prepare a wire 6 1/2" long and connect one end to BJ6 (S).
- (✓) Connect a wire 6 3/4" long to BJ7 (S). Leave the other end free.
- (✓) Connect a wire 5 3/4" long to BJ8 (S).
- (✓) Connect a wire 3 1/2" long to BJ9 (S).
- (✓) Connect a wire 4 1/2" long to BJ10 (S).
- (✓) Connect a wire 1 1/2" long to BJ11 (S).
- (✓) Before installing the switch, the power resistors should be partially wired. Refer to Pictorial 2 on Page 16 and connect a wire from resistor CC2 (NS) to resistor CD2 (S).

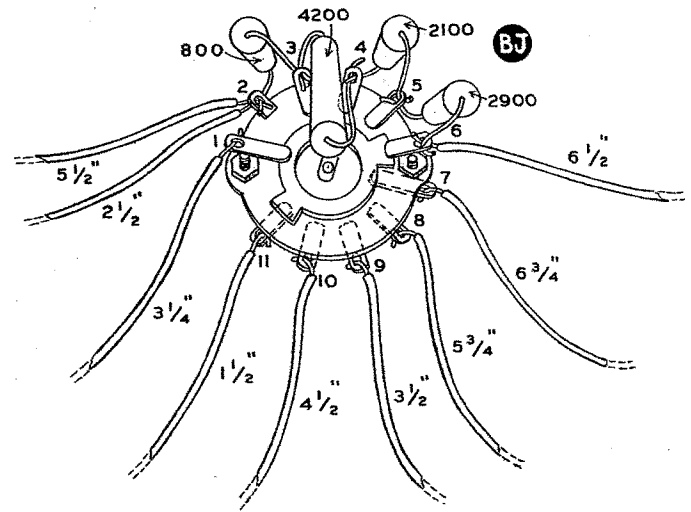

LOAD SELECTOR SWITCH

Figure 8

- (✓) Run a wire from CA2 (NS) to CB2 (S).
- (✓) Connect a wire from CA2 (NS) to CC2 (S).
- (✓) Mount the load selector switch at BJ on the panel with a lockwasher, flat washer and nut. Dress the wires from BJ1, the long wire from BJ2 and from BJ6 together and place them through grommet AE as the switch is mounted. Wire BJ6 should be dressed over the front of the switch. Wire BJ7 should be straight out and short BJ2, BJ8, BJ9, BJ10 and BJ11 bent straight back. Contact BJ1 should be straight down toward grommet AE.
- (✓) Connect the wire from BJ8 to 638  $\Omega$  resistor CD1 (S). Dress the wire close to the cooling bracket as shown.
- (✓) In the same manner, connect the wire from BJ9 to 16  $\Omega$  resistor CC1 (S).
- (✓) In a similar fashion, connect the wire from BJ10 to 8  $\Omega$  resistor CB1 (S).
- (✓) Run the wire from BJ11 to 4  $\Omega$  resistor CA1 (S).
- (✓) Connect the short wire from BJ2 to 4  $\Omega$  resistor CA2 (S).
- (✓) Dress the long wire from BJ2 and grommet AE tight to the chassis and front panel and connect the free end to panel ground lug BA (NS).
- (✓) Dress the wire from BJ6 tight to the chassis toward terminal strip K3. Leave the end free until the selector switch is installed.
- (✓) Connect the remaining wire from BJ1 and grommet AE to terminal strip K1 (NS).
- (✓) Run the wire from BJ7 around the outside edge of the chassis and connect it to panel binding post lug BB (NS). Dress the wire tight to the panel and chassis apron edge.

- (✓) Cut a piece of insulated shielded wire to a length of 8". At one end, cut away about 3/4" of outside insulation and braid, leaving the insulated center conductor only. See Figure 9. Strip about 1/4" of insulation from the center conductor and tin the exposed wire.

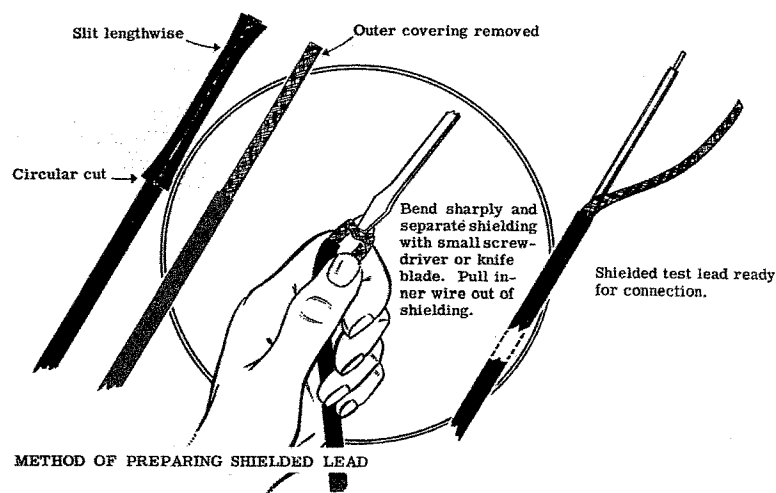
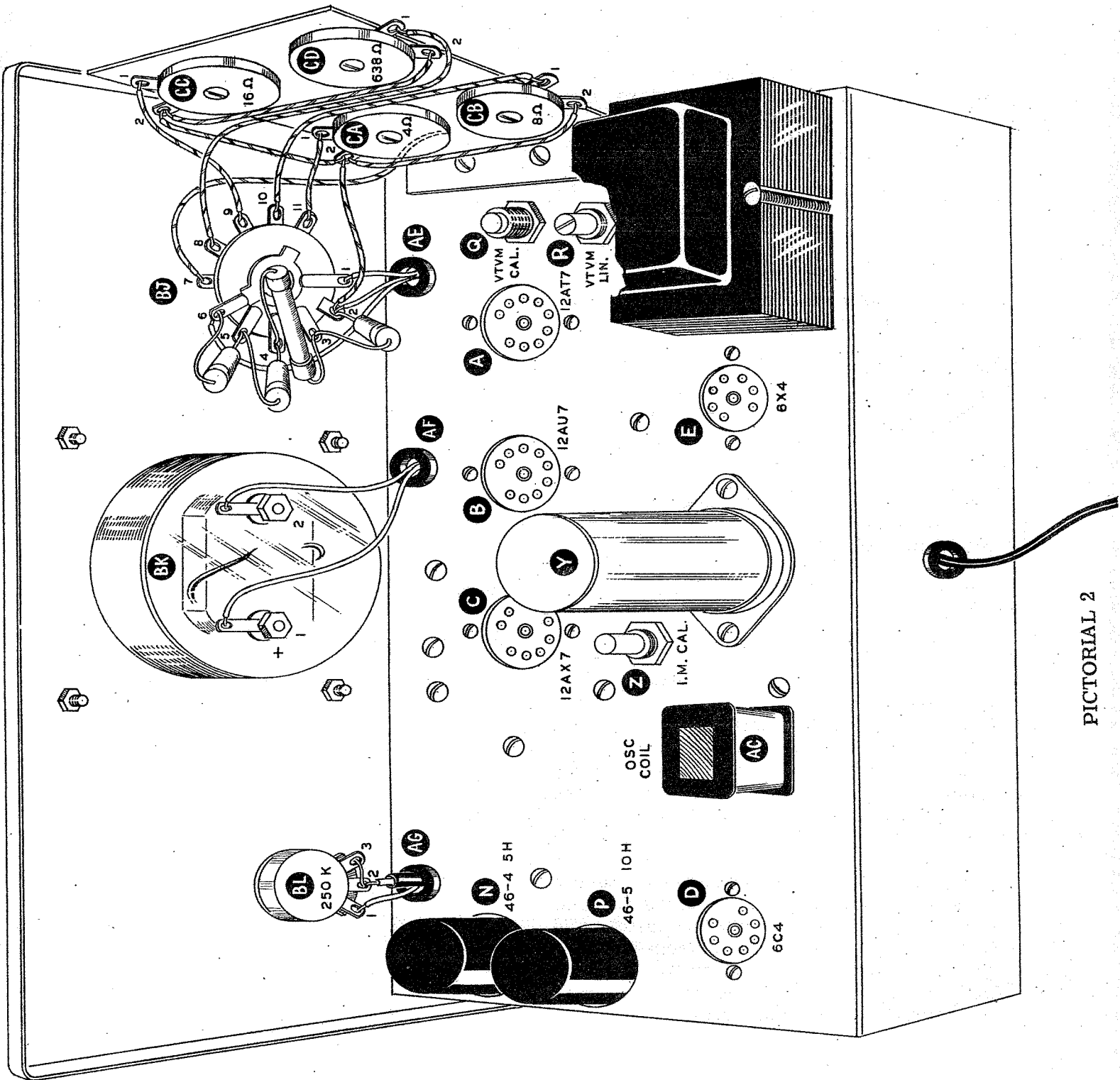

Figure 9



PICTORIAL 2

- (✓) At the opposite end of the cable, cut away 3/4" of outside insulation. Push the metal braid back until a bulge develops near the end of the outside insulation. Bend the wire over double at the bulge point, separate the strands of the braid and pull the inner conductor through the hole. Prepare the center conductor as before.
- (✓) Connect the end with the braid clipped off to control U3 (S).
- (✓) Connect the opposite end center conductor to terminal strip K3 (NS) and the adjacent braid to K2 (S).
- (✓) Install a 500  $\mu\text{mf}$  ceramic condenser (green-black-brown or marked) from control U2 (S) to socket C2 (S).
- (✓) Connect a 47 K $\Omega$  1 watt resistor (yellow-violet-orange) from terminal strip L3 (NS) to L4 (NS).
- (✓) Install a .05  $\mu\text{fd}$  condenser from L4 (NS) to L2 (NS).
- (✓) Connect a 22 K $\Omega$  resistor (red-red-orange) from L1 (NS) to L4 (S). (Use sleeving.)
- (✓) Install a 22 K $\Omega$  resistor (red-red-orange) from L1 (NS) to L2 (S).
- (✓) Connect a wire from L1 (S) to panel solder lug BC (S). Dress the wire tight to chassis and panel, allowing room for future installation of the shield plate.
- (✓) Connect the blue or blue white wire appearing through grommet AD to socket D1 (NS).
- (✓) Run the black wire from grommet AD to terminal strip J1 (NS).
- (✓) Connect a .005  $\mu\text{fd}$  condenser from socket D1 (S) to terminal strip J1 (NS).
- (✓) Install a .005  $\mu\text{fd}$  condenser from J1 (NS) to J3 (NS). Dress tight to the chassis.
- (✓) Connect a .01  $\mu\text{fd}$  condenser (brown-black-orange or marked) from J1 (S) to J4 (NS).
- (✓) Run a 1500  $\Omega$  resistor (brown-green-red) from J2 (NS) to D7 (S).
- (✓) Connect a 100 K $\Omega$  resistor (brown-black-yellow) from J2 (NS) to D6 (NS).
- (✓) Install a 10 K $\Omega$  resistor (brown-black-orange) from J3 (S) to D6 (S).
- (✓) On top of the chassis, mount a 250 K $\Omega$  control at location BL on the panel with a lockwasher, flatwasher and nut. Orient the contacts as shown.
- (✓) Run a bare wire from control BL2 (NS) to BL3 (S).
- (✓) Cut a piece of insulated shielded lead to a length of 7 1/2". Cut away 3/4" of outside insulation at one end and pull the center insulated conductor through a hole in one side of the braid as before. Cut away about 1/4" of insulation from the end of the inner wire.
- (✓) At the opposite end, cut away 3/4" of the insulation and shielding braid, leaving 3/4" of the inner conductor exposed. Cut about 1/4" of insulation from this end of the wire.
- (✓) Place the end with the braid cut off up through grommet AG and connect the end to control BL2 (S).
- (✓) At the opposite end, connect the center conductor to terminal strip J4 (S) and the adjacent braid end to J2 (S).
- (✓) Connect a wire from control BL1 (S) through grommet AG, to panel solder lug BF (S). Dress close to chassis and panel.
- (✓) Connect a wire from control W1 (S) to panel solder lug BG (NS).
- (✓) Connect a wire from switch V6 (S) to panel solder lug BD (S).
- (✓) Run a bare wire from control W2 (S) to switch V5 (S).
- (✓) Connect a bare wire from panel solder lug BE (S) to switch V4 (S).
- (✓) Run a bare wire from switch V3 (S) to V2 (NS).
- (✓) Connect a wire from switch V1 (NS) to panel solder lug BG (S).
- (✓) Connect a bare wire from control W3 (S) to panel solder lug BH (S).
- (✓) Push the 46-4 5h choke through the clip at N, nearest the front chassis apron, from the bottom.
- (✓) In the same manner, install the 46-5 10h choke at location P.
- (✓) Run a wire from the choke N mounting lug nearest the front chassis apron (S) to terminal strip M3 (NS). Clean the lug with steel wool, sandpaper or emery cloth to secure a good connection. Leave plenty of slack in the wire so that it will be possible to rotate the choke later on.

- (✓) In the same fashion, connect a wire from choke P mounting lug nearest the back chassis apron (S) to terminal strip M3 (NS).
- (✓) Connect the green wire of choke N to terminal strip M1 (NS). Keep the choke leads as short as possible.
- (✓) Run the black wire of choke N to M2 (NS).
- (✓) Connect the white wire of choke P to M4 (NS).
- (✓) Connect the black wire of choke P to M5 (NS).
- (✓) Identify the function selector switch which has two wafers with a metal shield between. Note that the #1 contact is a long clip on the front of the front wafer, next to a wafer mounting post. The #2 contact is a long clip on-the back side of the front wafer, etc.
- (✓) Cut a piece of insulated shielded wire to a length of 9". Cut away 3/4" of rubber outside insulation and pull the center conductor through the side of the braid near the end of the outside insulation as before.
- (✓) At the opposite end, cut away 3/4" of outside insulation and braid, leaving only the center conductor. Connect this end to switch S5 (S). Leave the other end free.

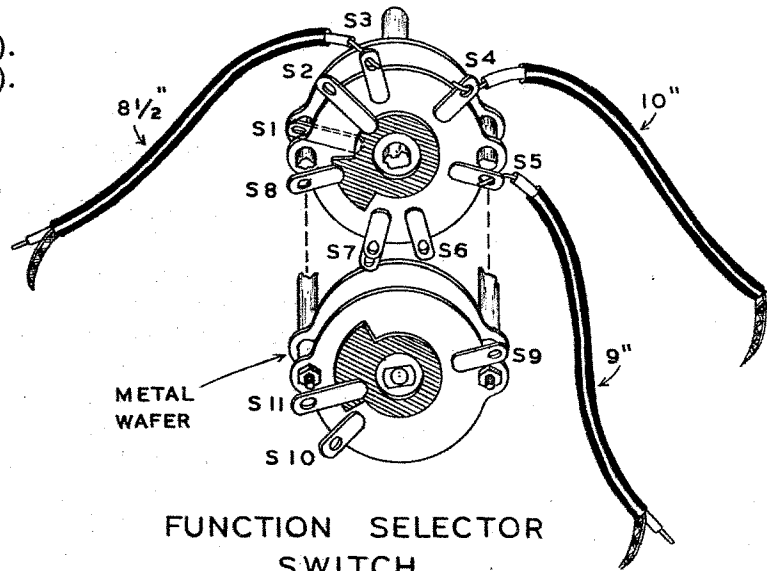
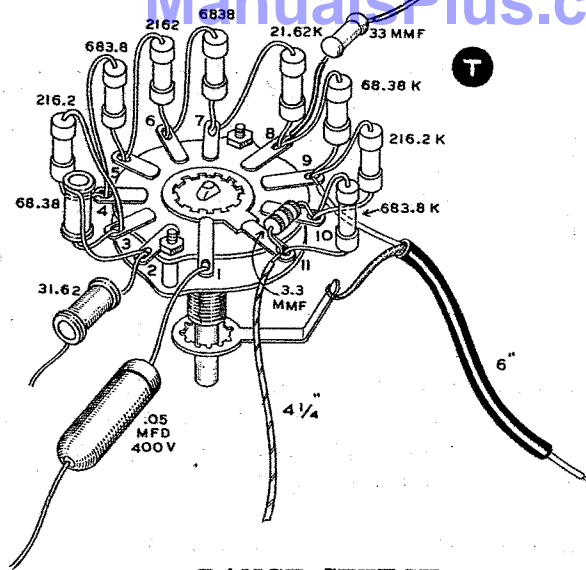

Figure 10

- (✓) In the same fashion, prepare an insulated shielded wire 10" long. At one end strip 3/4" of insulation and braid away, and at the opposite end, strip 1" of insulation and pull the center wire through the side of the braid near the end of the outer insulation.
- (✓) Connect the end with the braid removed to switch S4 (S). See Figure 10.
- (✓) In the same manner, prepare an insulated shielded cable 8 1/2" long, stripping 3/4" of outer insulation at both ends. At one end, pull the center conductor through a hole in the braid as before. At the other end, cut the braid away.
- (✓) Connect the end with the braid removed to switch S3 (S).
- (✓) Mount the switch at location S on the panel using a lockwasher, flat washer and nut. Note that contact S1 is oriented straight down toward the bottom panel edge, looking at the instrument from the top. Dress the cables from S3 and S4 under the switch and around controls Q and R as shown. The cable from S5 is dressed along the chassis under control U.
- (✓) Connect the center conductor of the long cable from S4 to terminal strip H4 (S) and the adjacent braid to H2 (S). Dress as shown.
- (✓) Connect the center conductor of the cable from switch S3 to terminal strip G1 (S) and the adjacent braid to G2 (S).
- (✓) Connect a bare wire from panel solder lug BA (S) to switch S1 (S).
- (✓) Run a bare wire from switch S8 (NS) to S11 (S). (Use sleeving.)
- (✓) Connect a bare wire from panel solder lug BB (S) to switch S8 (S).
- (✓) Connect the free wire appearing through grommet AE (from BJ6) to switch rear wafer S10 (S).
- (✓) Install a 500  $\mu\mu\text{f}$  ceramic condenser (green-black-brown or marked) from terminal strip K3 (S) to switch S9 (S). (Use sleeving.)
- (✓) Identify the Range switch T which has 10 short contacts. Note that contact #1 is the long one to the left of a wafer mounting post.
- (✓) Connect a 68.38  $\Omega$  resistor from switch T2 (NS) to T3 (NS). See Figure 11 on the following page.
- (✓) Install a 216.2  $\Omega$  resistor from T3 (S) to T4 (NS).

- (✓) Connect a 683.8 Ω resistor from T4 (S) to T5 (NS).
- (✓) Run a 2162 Ω resistor from T5 (S) to T6 (NS).
- (✓) Install a 6838 Ω resistor from T6 (S) to T7 (NS).
- (✓) Connect a 21.62 KΩ resistor from T7 (S) to T8 (NS).



RANGE SWITCH

Figure 11

- (✓) Cut one lead of a 33 μmf condenser (orange-orange-black or marked) to a length of 3/4". Connect this end to T8 (NS). (Use sleeving.) Leave the other end free.
- (✓) Connect a 68.38 KΩ resistor from T8 (S) to T9 (NS).
- (✓) Install a 3.3 μmf condenser (orange-orange-white or marked) from T10 (NS) to T11 (NS). Keep the leads short and dress close to the switch as shown.
- (✓) Install a 216.2 KΩ resistor from T9 (NS) to T10 (NS).
- (✓) Connect a 683.8 KΩ resistor from T10 (S) to T11 (NS).
- (✓) Cut one lead of a 31.62 Ω resistor to a length of 1/2" and connect it to T2 (S). Leave the other end free.
- (✓) Similarly, cut one lead of a .05 μfd condenser to a length of 1 1/4" and connect it to T1 (S).
- (✓) Cut a wire to a length of 4 1/4", strip and tin both ends and connect one end to T11 (S).
- (✓) Cut a piece of insulated shielded cable to a length of 6". Cut away 3/4" of outside rubber insulation at both ends and 3/4" of braid at one end as before. At the other end, pull the center wire through a hole in the side of the braid. Strip and tin both ends.
- (✓) Connect the center conductor at the end with the braid intact, to switch T9 (S).
- (✓) Slip the lockwasher with a long ground lug attached, over the switch shaft with the lug toward T9. Solder the shielded lead braid to this lug.
- (✓) Mount the switch-lockwasher assembly at location T, making sure that the lockwasher ground lug does not accidentally short out any of the components. Orient the switch as shown, with the blank space between pins T1 and T11 toward the chassis.
- (✓) Connect the .05 μfd condenser from T1 to socket A7 (S). (Use sleeving.) Dress the condenser toward control Q and chassis, as far from the condenser connected to A1 as possible.
- (✓) Connect the 31.62 Ω resistor from T2 to control Q1 (S).
- (✓) Run the wire from T11 to switch S2 (S).

- (✓) Connect the center conductor of the shielded lead from T9 to switch S6 (S).
- (✓) Connect the free end of the 33 μmf condenser from T8 to socket B8 (S). (Use sleeving.)
- (✓) Install a 158.2 KΩ precision resistor from terminal strip K1 (NS) to switch S7 (NS). Note that S7 is a double contact. Place the lead at this end through both contacts.

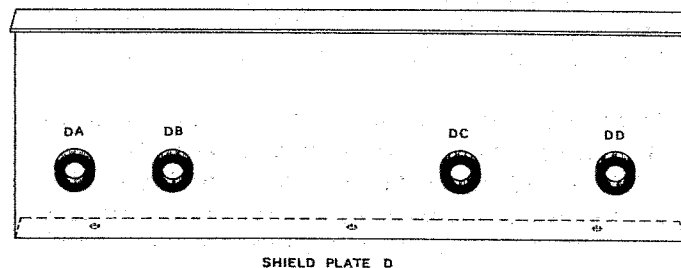

Figure 12

- (✓) Connect a 10 μmf condenser (brown-black-black or marked) from K1 (S) to S7 (S). Solder both S7 contacts securely.
- (✓) Refer to Figure 12 and install rubber grommets in shield plate D at locations DA, DB, DC and DD. Note that DA and DB are the two holes closest together.

- (✓) Place the shielded wire from switch S5 through grommet DA and the twisted pair of leads from socket E through grommet DD. Mount the shield plate on the chassis with 6-32 hardware, making sure that the mounting flange is toward terminal strip L.
- (✓) Connect the center conductor of the shielded wire appearing through grommet DA to switch V2 (S) and the adjacent braid end to V1 (S).
- (✓) Connect one of the wires appearing through grommet DD to socket D3 (S) and the adjacent wire to D4 (S). Dress the wires tight to the chassis and back apron.
- (✓) Run the red wire appearing through grommet AD, through grommet DD and connect it to condenser Y = (S).
- (✓) Connect a wire from socket E1 (S) through grommet DD to terminal strip L3 (S).
- (✓) Cut a wire to a length of 15" and strip and tin both ends.
- (✓) In the same fashion, cut and prepare a wire 14" long. Holding one end of each wire even, twist the two wires together.
- (✓) Place the end of the twisted pair which has the wires even, through grommet DA from terminal strip L side and connect one of the leads to control switch U4 (S). Connect the adjacent wire to U5 (S).
- (✓) At the opposite end, place the leads through grommet DD and connect the longer lead to socket E5 (S). Connect the adjacent end to terminal strip X2 (NS). Dress the wires tight to the chassis and shield bracket.
- (✓) Cut a piece of spiral shielding to a length of 2 3/4". At one end, unroll about 1" length of wire as shown in Figure 13. Connect this wire to terminal strip M3 (NS). Place the opposite end through grommet DB, leaving the end flush with the opposite edge of the grommet. Dress the shield away from terminal strip L1 to avoid possible short circuits.
- (✓) In the same manner, prepare a piece of spiral shield 4 1/4" long. Unroll about 1" of wire at one end and connect to terminal strip M3 (S). Place the opposite end through grommet DC leaving the free end about 1 1/2" through DC.
- (✓) Cut a piece of wire to a length of 4 1/4". Strip and tin both ends and place the wire through the shielding at grommet DB. Connect one end to terminal strip AA1 (S) and the opposite end to terminal strip M1 (S).
- (✓) Prepare a wire 4" long as before and place it through spiral shield DB. Connect one end to AA2 (S) and the opposite end to M2 (S). Recheck the dress of the shield to make sure no possibility of short circuits exist.
- (✓) In the same manner, prepare a wire 5 3/4" long and run it through spiral shield DC. Connect one end to terminal strip H3 (S) and the opposite end to M4 (S).
- (✓) Likewise, prepare a wire 6" long and run it through shield DC. Connect one end to H1 (S) and the opposite end to M5 (S).
- (✓) Mount the pilot light assembly at location BM on the front panel, observing Figure 14 and Pictorial 1. Make sure that the lamp socket bracket is oriented as shown, for it is used as a shield between the lamp and range switch. Install the bulb before securing the jewel.
- (✓) Cut two wires to a length of 4". Strip and tin all ends and twist together. At one end of the twisted pair, connect one lead to socket C9 (S) and the adjacent wire to C5 (S).

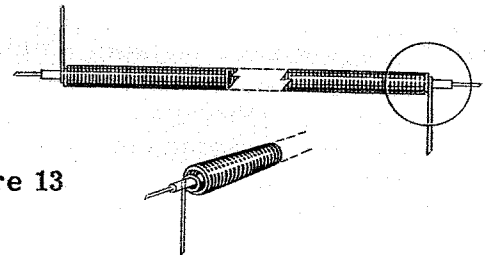
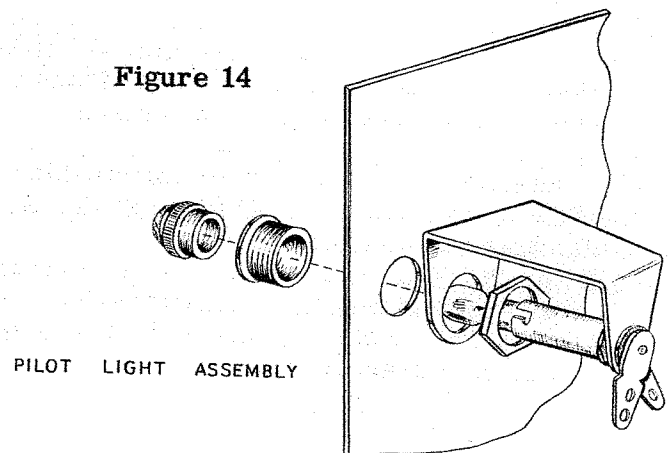

Figure 13

Figure 14



- (✓) At the opposite end, connect one wire to pilot socket BM1 (S) and the other to BM2 (S). Dress the wires away from all components as shown.
- (✓) Pass a line cord through grommet AH and tie a knot about 3" from the end to provide strain relief. Connect one of the wires to terminal strip X2 (S) and the adjacent wire to socket E2 (S).
- (✓) Mount the meter movement at location BK, using the hardware furnished.
- (✓) Connect the wire previously identified with a marked tape or by bending to the + meter terminal BK1 (S).
- (✓) Connect the remaining wire appearing through grommet AF to terminal BK2 (S).
- (✓) Two red and two black test leads 3' long are furnished with the kit. Prepare all four by stripping about 1/4" of insulation from all ends. At one end of each wire, solder an alligator clip in place. Tin the opposite ends. Slip the red and black insulating sleeves over the banana plugs so that the holes line up and push the wire in the back of the plug as far as it will go. Secure each assembly with a 4-40 set screw.
- (✓) Insert set screws in the knobs and install them on all switch and control shafts. Index each knob at the extreme counterclockwise position and then rotate the knob through its range to make sure that indexing is correct.
- (✓) Install red binding post caps at BB and BH.
- (✓) Mount black binding post caps at BA, BC, BD, BE, BF and BG.
- (✓) On front of the panel, install a bare wire jumper from binding post BC to BD. Tighten securely.
- (✓) In the same fashion, run a bare wire jumper from binding post BE to BF.

**IMPORTANT WARNING: MINIATURE TUBES CAN BE EASILY DAMAGED WHEN PLUGGING THEM INTO THEIR SOCKETS. THEREFORE, USE EXTREME CARE WHEN INSTALLING THEM. WE DO NOT GUARANTEE OR REPLACE MINIATURE TUBES BROKEN DURING INSTALLATION.**

- (✓) Insert the 12AT7 in socket A, the 12AU7 in socket B, the 12AX7 in socket C and the 6C4 in socket D. Do not install the 6X4 rectifier yet.
- (✓) Install the handle on the instrument case, using 10-24 screws and lockwashers.
- (✓) Mount the rubber feet in the bottom of the cabinet by pushing the small ends through the holes provided and rotating until they lock in place.

This completes the construction of your Heathkit AA-1 Audio Analyzer. Carefully recheck each operation for accuracy. Remove any solder splashes, wire clippings or other foreign material. Inspect the wiring to make sure all components and wires are dressed to avoid shorts to each other or to chassis. Make sure all connections are securely soldered and that excess solder has not accidentally flowed down to the chassis from terminal lugs, socket pins, etc.

### TESTING THE COMPLETED INSTRUMENT

If an ohmmeter is available, check the DC resistance between pin 7 of 6X4 socket E and ground. The resistance should be at least 20,000  $\Omega$  after one minute. If lower, carefully recheck wiring for an error. Give special attention to the connections around 6X4 socket E, the filter condenser and socket B.

Make sure that the line switch is off by rotating the I. M. ANALYZER INPUT control to its full counterclockwise position. Connect the line cord to a 105-125 volt 50/60 cycles AC outlet. **DO NOT CONNECT THIS INSTRUMENT TO A DC (DIRECT CURRENT) LINE. SERIOUS DAMAGE TO THE POWER TRANSFORMER WILL RESULT.** Do not attempt to use this instrument on a 25 cycle source, for it will not operate and the transformer will be damaged.

Turn the instrument on by rotating the ANALYZER INPUT control clockwise until a click is heard. The filaments of all tubes and the pilot light should light. Now insert the 6X4 rectifier tube in socket E. Check the rectifier to see if the plates show color or the tube shows a bright violet glow. If so, turn the instrument off immediately and recheck the wiring for an error or short circuit. If any difficulty is experienced, the power should be disconnected and the steps outlined under "IN CASE OF DIFFICULTY" followed.

### CALIBRATION OF THE INSTRUMENT

Before attempting calibration, turn VTVM CAL. control Q to its extreme clockwise position and LINEARITY control R to its extreme counterclockwise position. Place the LOAD SELECTOR switch in the HI-Z position, the FUNCTION switch at VTVM and the RANGE switch to its full clockwise or 300 volt position. Connect a pair of test leads to the IN terminals and to the 110 volt AC line. Connections can be made to a plug or unused line cord or to terminal strip X2 and socket E2, making sure that the clips are well insulated from each other and all other parts. (CAUTION: The 110 volt line is dangerous. Proceed with due care.) Adjust CALIBRATE control Q until the meter needle reads 117 volts on the 300 volt scale. If an accurate AC meter is at hand, the meter can be calibrated against it if there is reason to believe the line voltage is higher or lower than this.

(NOTE: Never connect the input across the 110 volt line unless the LOAD SELECTOR switch is in the 600  $\Omega$  or HI-Z position. The 4, 8, and 16  $\Omega$  resistors will burn out if 110 volts is applied with the switch placed in one of these positions.)

To adjust meter linearity, disconnect the input from the 110 volt line. Rotate the FUNCTION switch to LF HF TEST and the TEST switch to LF TEST. Place the RANGE switch in the 3 or 10 volt position and adjust the LF HF GENERATOR OUTPUT control for a reading near or at full scale. Write the reading down for reference purposes and do not touch the output control again until adjustments are completed. Move the RANGE switch up one position in a clockwise direction and note the reading on the correct scale. It should be exactly the same voltage as written down. If not, return the RANGE switch to its original setting and with the meter needle near full scale, rotate the LINEARITY control R until the meter moves downscale slightly. Re-adjust control Q until the original reading is obtained once again and repeat the procedure. Adjustment is complete when good decading is obtained at all settings of the RANGE switch. In some cases, it may be necessary to disconnect the control entirely from the circuit in order to obtain good linearity. This will be necessary only in cases where an exceptionally well balanced pair of diodes are used in the bridge rectifier.

No calibration of the Wattmeter is necessary since the AC VTVM is automatically corrected for power readings by use of precision resistors.

I. M. Analyzer calibration is a more complex operation and may be done in many different ways. Basically, a signal producing 10% IM is applied to the analyzer section and after the input control is adjusted to produce full scale reading on the 10% IM range, the IM CAL. control is set for full scale reading on the SET LEVEL positions of the FUNCTION and RANGE switches.

Before attempting to calibrate the IM Analyzer, the high and low pass filter chokes should be oriented for minimum hum pickup. Any hum picked up by the chokes will be reflected as erroneous IM readings and will also cause excessively high residual readings on lower IM% scales.

Adjustment is accomplished as follows: Set the LOAD switch to HI-Z, FUNCTION to VTVM and the RANGE switch to .3 volts to start. Remove the 12AX7 tube C from its socket. Set the LEVEL and OUTPUT controls to the extreme counterclockwise positions. Connect a test lead to the "hot" input terminal and the opposite end to terminal strip M1. Move the RANGE switch to the right or left as necessary to obtain a satisfactory meter indication. Rotate choke N until a minimum reading is obtained. This completes the adjustment of the high pass filter choke.

Using the same control set up as before, connect the hot input lead to terminal strip H1. Connect another test lead to the grounded input terminal and the opposite end to H3. Rotate choke P for a minimum reading as before, adjusting the RANGE setting as necessary to maintain satisfactory indication. This completes the adjustment of the low pass filter choke.

It is unlikely that a complete null will be obtainable, but there need not be cause for concern since the small amount of pickup remaining after the chokes are tuned will not upset the accuracy of the I. M. Analyzer. Replace the 12AX7 tube C.

A satisfactory method of calibration, using a minimum of equipment requires an audio oscillator and a pair of resistors of approximately 10 K $\Omega$  each, furnished with the kit. The signal that will cause 10% IM may be generated by mixing the signal from the IM generator section with the signal from the audio oscillator in a voltage ratio of 10:1 and with a frequency difference of 60 to 100 cycles. An alternate calibrating method is also described in case no additional equipment is available.

Make up the calibrating resistor set by soldering the ends of two 10 K $\Omega$  and one 4.7 K $\Omega$  resistors together as shown in Figure 15. Place the TEST switch in the HF TEST position to remove the 60 cycle signal from the generator output, leaving only the 6000 cycle signal.

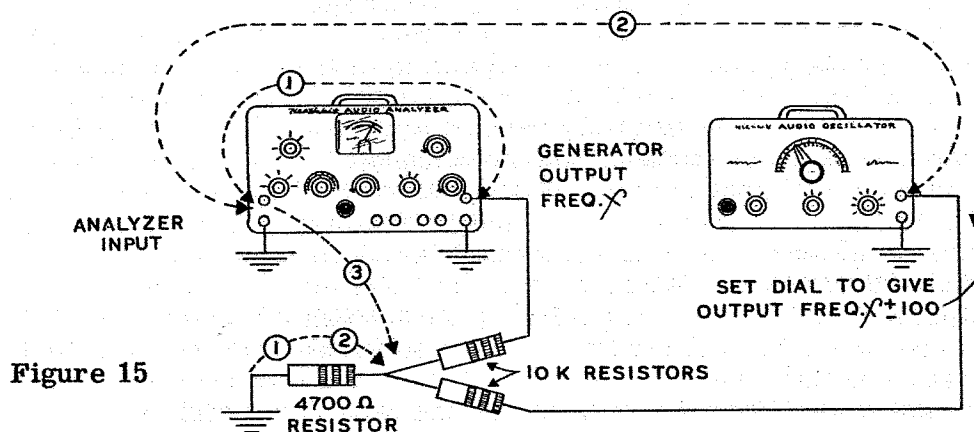

Figure 15

Study Figure 15. Note that some connections are designated by the use of solid lines and some are represented with broken lines. Solid line connections are kept throughout the complete calibrating procedure which follows, while broken line connections are kept only for the part of the calibration procedure in which they are specifically referred to by number.

- A. Make the solid line connections as follows: Connect one of the matched resistors to the hot output terminal and through the 4.7 K $\Omega$  resistor to ground. Connect the other 10 K $\Omega$  resistor to the audio oscillator output terminal and through the same 4.7 K $\Omega$  resistor to ground.
- B. Set the FUNCTION switch to VTVM, LOAD switch to HI-Z and the ANALYZER INPUT and GENERATOR OUTPUT controls to minimum or extreme counterclockwise positions. Set the RANGE switch to 10 volts and connect the input terminal of the AA-1 to the junction of the three resistors, as indicated by dotted line #3 in the sketch.

Adjust the audio oscillator to zero beat with the AA-1 internal generator output. To obtain this beat, set the HIGH FREQUENCY LEVEL and GENERATOR OUTPUT controls on the AA-1 to maximum. Also set the output from the audio oscillator to maximum. Turning the audio oscillator through the 6000 cycle signal from the AA-1 will cause the meter pointer to swing with the beat note.

- C. After zero beat has been obtained, set the audio oscillator to a new frequency about 60-100 cycles higher or lower. Remove connection #3. Make the two connections #1 as follows: Short the 4.7 K $\Omega$  resistor and connect the input terminal to the AA-1 generator output. Adjust the HIGH FREQUENCY LEVEL and GENERATOR OUTPUT controls to give a suitable reading (somewhere near the maximum obtainable) on the 30 volt range.
- D. Remove connections #1 and make connections #2, shifting the input terminal lead from the output of the AA-1 generator to the output of the audio oscillator. Keep the short across the 4.7 K $\Omega$  resistor.

Adjust the output control on the audio oscillator to give the same meter deflection as obtained in the paragraph above but on the 3 volt range. Thus, a voltage ratio of 30:3 or 10:1 is established.

- E. Remove all connections #2 and make connection #3. This removes the short across the 4.7 K $\Omega$  resistor and connects the input of the analyzer to the junction of the three resistors. Making these connections applies the desired mixed signal to the analyzer and will result in a carrier with 10% modulation at the detector in the analyzer. Set the RANGE switch to 10% IM and the FUNCTION switch to % IM. Adjust the IM ANALYZER INPUT control for full scale meter deflection. Next, set the FUNCTION switch to SET LEVEL and the RANGE switch to the indicated SET LEVEL position (3% IM). Adjust the IM CALIBRATE control Z for full scale deflection of the meter.

If an audio oscillator is not available, practical calibration of the IM analyzer section can be accomplished by modulating the internal high frequency oscillator with a 60 cycle waveform. To accomplish this, set up the instrument as follows: Set the TEST switch to HF TEST, FUNCTION switch to % IM, RANGE switch to 10% IM and the LOAD switch to HI-Z. The indicator line on the HIGH FREQUENCY LEVEL and LF HF GENERATOR OUTPUT control knobs should be turned straight up, assuming that they have been properly indexed when installed. Adjustment of the output controls is not critical so approximate positions are adequate. Connect a test lead between the hot output terminal and the hot input terminal of the analyzer. Connect another test lead from either of the LOW FREQ. binding posts to the cathode of the high frequency oscillator, pin 7 of socket D. This applies 60 cycle energy to the cathode of the oscillator, modulating it approximately 6.4%. Adjust the IM ANALYZER INPUT control until the meter reads 6.4% on the 10% scale. Next, set the FUNCTION switch to SET LEVEL and the RANGE switch to the SET LEVEL or 3% IM position and adjust IM CALIBRATE control Z for a full scale reading at the SET LEVEL point. Remember that using this procedure may result in an error of approximately 10% in indicated reading. The first calibrating procedure is recommended when high accuracy is required.

This completes the calibration of your AA-1 Audio Analyzer. Install the instrument in the cabinet, securing with self-tapping screws through the holes in the back.

#### OPERATION OF THE AA-1 AUDIO ANALYZER

A review of the circuit description in the front of the manual might be helpful. Operation of all controls and circuits is described in detail and a full understanding of instrument functions will greatly increase its usefulness in the audio lab. Some applications are outlined here which describe the basic operations and some other applications are suggested with the hope that they will be a guide to other advanced uses of the analyzer. Thorough familiarity with the flexible switching system incorporated will enable the operator to find many other uses for the unit, making it a very valuable and often used piece of equipment.

## USING THE AC VTVM

**Reading Voltages:** The AC voltmeter has 10 separate voltage ranges allowing measurements up to 300 volts RMS. Frequency response is  $\pm 1$ db from 10 cps to 100 kc. The markings on the RANGE switch refer to full scale readings.

When the instrument is set to the lower ranges, the meter may show a residual indication. This is caused by the extreme sensitivity of the circuit. To check for zero indication, the instrument power plug should be reversed in the AC outlet until a minimum reading is obtained. Zero reading should be evident when the input terminals are shorted together. Any residual indication will have no effect on the accuracy of these ranges when readings are made, due to the low impedance nature of the circuits being tested.

The meter scale is marked 0-3 and 0-10 for voltage measurements. When making measurements on the .03, .3, 3, 30 or 300 volt ranges, read the 0-3 meter scale and adjust the decimal for the correct voltage.

**Example:** Using the .03 range, the meter reads 2. For correct voltage, move the decimal point two places to the left, i. e. .02 volts.

When making measurements on the .01, .1, 1, 10 or 100 volt ranges, read the 0-10 meter range and adjust the decimal for the correct voltage.

**Example:** Using the .1 volt range, the meter reads 6.4. For correct voltage, move the decimal two places to the left, i. e. .064 volts.

Due to the high sensitivity of the instrument, the input terminals should not be touched when the meter is set for the lower ranges. Stray electric fields, picked up by the human body will deflect the pointer beyond full scale. Repeated banging may bend the pointer.

Although the pointer may bend by overloading, the electronic circuit is self-limiting. Because of this self-limiting, the maximum current through the meter movement under extreme overload conditions is yet within the safety factor of the meter coil windings. Although the meter may not burn out from severe overloading, other circuit components can be damaged by prolonged overloads.

**Using the Decibel Scale:** Because the human ear does not respond to the volume of sound in proportion to the signal strength, a unit of measure called the "bel" was adopted. The "bel" is more nearly equivalent to human ratios. Normally the reading is given in 1/10 of a "bel" or "decibel." Different signal levels are adopted by various manufacturers as standard or "0" decibels. The trend within the last few years has been toward the use of 1 milliwatt into a 600  $\Omega$  load as "0" db. This reference has been given a special designation of "dbm." This Heathkit is calibrated to read in "dbm" when connected across a 600  $\Omega$  load.

When using the AA-1 for db measurement, adjust the RANGE switch until there is a reading on the decibel scale. The meter reading is then either added to or subtracted from the range indication.

**Example:** Range +20 db, meter indicates -5 db, actual value is +15 db.  
Range -10 db, meter indicates -4 db, actual value is -14 db.

Since the decibel is a power ratio or voltage ratio, it may be used as such without specifying the reference level. Thus for instance, a fidelity curve may be run on an amplifier by feeding in a signal of variable frequency but constant amplitude. At a reference frequency of say 400 cycles, make an initial reading on the AC voltmeter, connected to the output. A suitable load, such as a speaker or the built-in resistors should be connected to the amplifier output during the test. As the input frequency is varied, amplitude held constant, the output level variation may be noted in db above and below the specified reference level.

When making comparative measurements, the circuit impedances must be considered. Such is the case when measuring overall gain through an amplifier. If the input impedance is the same as the output impedance, the db gain can be measured directly with the AA-1. In the case where the input and output impedance differ, it is necessary to correct each reading mathematically to a common reference level.

**Complex Waveforms:** This instrument, like most AC voltmeters, is calibrated to read the Root Mean Square (RMS) value of a pure sine wave. This is 70.7% of the peak voltage.

As characteristic of most rectifier type instruments, the meter deflection is proportional to the average value of the input waveform. Thus when measuring oddly shaped waves (square, saw-toothed, pulse), the meter reading must be given special interpretation. Special reading on this subject will be found in the bibliography.

#### SETTING UP INSTRUMENT AS AC VOLTMETER

Three switches are used to make AC voltage measurements. These are the LOAD, FUNCTION and RANGE switches. The TEST switch should always be in the OPERATE position when the VTVM is used, unless single frequency measurements employing one of the internal generators are being done. Set the FUNCTION switch to VTVM, the LOAD switch to the desired impedance (4, 8, 16 or 600  $\Omega$  int. or ext. if used at the output of an amplifier, HI-Z if used at other points) and the RANGE switch to the necessary voltage. Read the voltage from the second ring from center on the RANGE switch and the meter. Test leads are connected to the analyzer input, with the bottom or ground lead connected to ground in the unit under test and the top or "hot" lead to the appropriate test point.

#### AC VTVM APPLICATIONS

AC voltages at any point in practically any type of circuit can be measured with the VTVM. Filament voltage, power line voltage, noise, output and gain measurements can be made quickly and accurately by connecting the test leads across the point where information is desired. Voltage gain is measured stage by stage or overall by measuring input voltage versus output voltage, dividing the output by the input voltage. Checks at the secondary of an output transformer for voltage gain are not feasible however, since the last stage in a power amplifier provides power gain at low impedance, rather than voltage gain.

Ripple on the output of power supplies can be measured by connecting the input of the analyzer across the supply. If the voltages encountered are relatively high, a .01 or .05  $\mu$ fd condenser should be connected in series with the test lead and input, to keep DC off of the VTVM decade.

Amplifier noise measurements are made by running the amplifier to full output power at a reference frequency such as 400 or 1000 cycles and then turning off the signal source, leaving it connected to the amplifier input. The reading in volts or db should be noted at full output and read again after the signal source is killed. The difference between the two readings is the noise output level in volts or db below the specified output.

#### USING THE WATTMETER

The model AA-1 has seven separate wattage and db ranges allowing measurements up to 50 watts (on the 150 watt range) and +47 db. The markings on the switch refer to full scale power readings.

To read power output from an amplifier, the FUNCTION switch must be set to the OUTPUT position and the LOAD switch set to one of the impedances under internal or external load. The appropriate internal load resistors will be connected to the amplifier output if the switch is in one of the internal load positions. If an external load such as a speaker is used, the switch should be set to the appropriate position under EXT. load. Power ranges are selected by use of the RANGE switch, reading the outer ring. Note that the red meter scales are read for power output and db when the FUNCTION switch is in the output position.

**Example:** The amplifier has a 16  $\Omega$  output. Connect the ground side of the amplifier to the bottom terminal of the analyzer input. The "hot" side of the output transformer secondary winding is connected to the upper of "hot" input terminal. Set the LOAD selector switch to the 16  $\Omega$  INT. load position and the RANGE switch to 150 watts. **DO NOT USE AN EXTERNAL LOAD RESISTOR OF ANY TYPE. PROPER LOADING IS MAINTAINED WITHIN THE INSTRUMENT.** Amplifier power output will be indicated directly on the meter. Rotate the RANGE switch to the left as necessary to give satisfactory meter deflection.

Indication of power output is obtained by connecting the output of a sine wave audio oscillator to the amplifier input. The power output will be indicated directly on the output scale. If necessary, turn the RANGE switch to the left until adequate deflection of the meter needle is obtained. Measurements can be made at 60 and 6000 cycles by use of the AA-1 internal generators, or at other frequencies if an audio oscillator is employed.

For best results, the RANGE switch should always be set to give an approximate center scale reading. This will maintain a higher degree of accuracy, since the readings will be close to the calibration point.

**CAUTION:** The load resistors are rated at 24 watts continuous power dissipation. Powers above this up to 50 watts can be handled safely only if the power is applied intermittently. Do not use at power levels higher than 25 watts for periods exceeding three minutes.

To obtain 60 cycles for testing purposes from the AA-1, set the TEST switch to the LF TEST position and connect the output of the analyzer to the input of the amplifier. Output level can be controlled by use of the LF HF GENERATOR OUTPUT control. If 6000 cycles is desired, observe exactly the same procedure, except that the TEST switch will be in the HF TEST position. Additional control of high frequency level can be obtained with the use of the HIGH FREQUENCY LEVEL adjustment.

Maximum amplifier power output is obtained when the meter needle fails to deflect further when the amplifier input is increased. For best indication, an oscilloscope should be connected across the analyzer input terminals, for the scope will show distortion and overload before the meter will. Output of an amplifier will sometimes increase beyond the overload point, but the additional power consists mainly of distortion products.

Noise measurements can be made as before, by noting db at full output. The audio source is then turned off and the RANGE switch turned to the left until a reading is obtained, if any. Again, note the db reading. Subtract the noise reading from the full power reading, which will give the noise below full power output. In the case of exceptionally quiet amplifiers, it may be necessary to take advantage of the wider range of the AC VTVM in order to obtain a satisfactory reading. Where this is the case, observe the instructions under AC VTVM APPLICATIONS.

Frequency response and power curve measurements are easily accomplished using the AA-1 wattmeter section. Again, the audio generator should be connected to the amplifier input. If possible, the output of the audio generator should be metered to insure constant output level. The output of the amplifier connects to the analyzer input as before. Set the audio oscillator and amplifier to the desired output and run the response, keeping the output of the generator at the same level. The curve can be plotted in db or watts as indicated on the output meter.

When desired, the AA-1 output meter can be used with an external load such as a speaker, a low impedance line or an external resistance. When this is done, the instrument is bridged across the output leads at the external load or at the amplifier output, with the LOAD selector switch set to EXT. load and to the proper impedance. Readings obtained will then be exactly the same as if the internal load resistance were used. The switch must be set to the proper impedance however, for the same compensating resistors are used with the external load. Proper indication of power cannot be obtained at impedances other than 4, 8, 16 or 600  $\Omega$ .

The instrument can be left bridged across a line without indicating, if necessary, by placing the LOAD selector switch in the HI-Z position. This disconnects the VTVM from the circuit, leaving only the compensating resistors connected across the load circuit.

**CAUTION:** The LOAD selector switch should never be rotated when energy is applied to the analyzer input. If it becomes necessary to change impedance settings, the input to the amplifier under test should be killed, or the amplifier turned off. Damage to the meter needle due to violent slamming against the stops will be avoided if this precaution is observed.

Highly accurate monitoring of output level for recording or program feed purposes can be accomplished by connecting the analyzer across the amplifier output leads and setting the LOAD selector switch to the proper impedance under EXT. load. Circuit ballistics are such that the instrument makes an excellent db meter.

Set up of cross-over networks in multiple speaker systems is easy using the power scales of the AA-1. A variable frequency audio oscillator should be connected to the audio amplifier input, and the analyzer to the output of one of the crossover network sections. All remaining sections should be loaded with speakers or resistors. Set the LOAD switch to the appropriate network impedance under INT. load and run a response on the network, noting the output level. Next, the analyzer is connected across another section, returning the original load to the section previously tested and the procedure repeated. A very useful picture of network performance can be obtained in this manner.

If complex waveforms are to be measured, the information under USING THE AC VTVM should be observed.

Occasionally it may be necessary to measure power at levels higher than 50 watts, especially when public address systems are being tested or serviced. Power measurements up to 100 watts continuous or 200 watts intermittent can be made by dissipating a major portion of the power externally. Four resistors of the same value as the amplifier output impedance are required, one of which is one of the internal resistors in the AA-1. The power ratings of the other three resistors should be at least 25 watts and non-inductive types are recommended. Two of the resistors should be connected in series and the other external resistor connected in series with the internal load resistor in the analyzer. The two combinations should be connected in parallel, as shown in Figure 16. Set the LOAD selector switch to the same value of resistance as the external resistors under INT. LOAD. Read the power on the appropriate meter scale and multiply the reading by 4 to obtain the true power output reading. One quarter of the total power will be dissipated in each resistor, so the readings will be just as accurate as if the amplifier were fed directly into the analyzer.

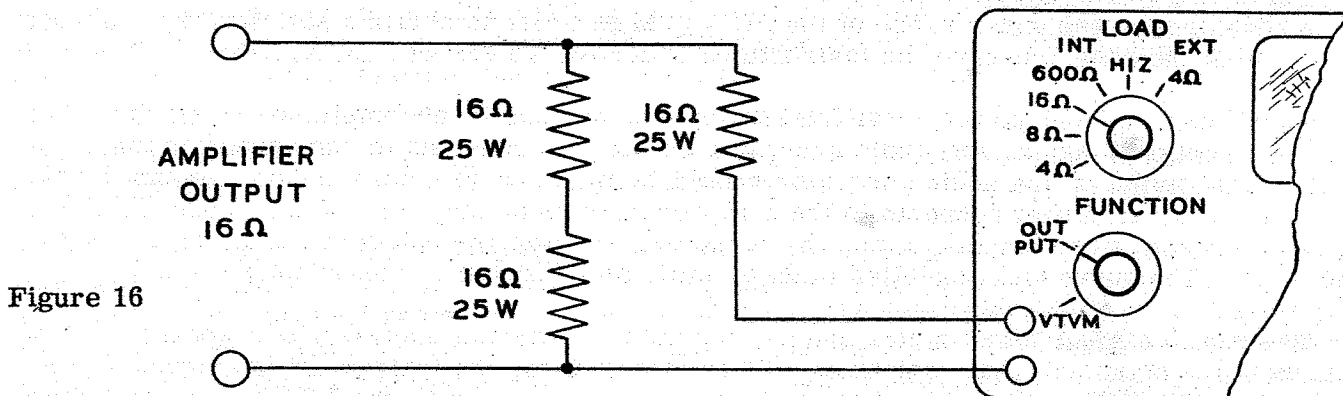

**Example:** The amplifier has a 16  $\Omega$  output. Three 16  $\Omega$  25 watt resistors will be connected as shown and the LOAD switch set to 16  $\Omega$  under INT. LOAD. Turn on the amplifier and note the meter reading. Assuming that the meter reads 20 watts, the amplifier output will be 4 x 20 watts, or 80 watts. If the amplifier has a 4 or 8  $\Omega$  output, 4 or 8  $\Omega$  resistors will be used and the LOAD switch set to the same value as the external resistors and the amplifier impedance.

## USING THE INTERMODULATION ANALYZER

The IM analyzer section of the AA-1 is designed to function in accordance with the standard test conditions as formulated by the Society of Motion Picture Engineers (SMPE). Flexibility of the instrument permits a variety of other sets of conditions to be used.

Standard conditions require a signal output from the generator to consist of a low frequency signal and a high frequency signal, in a ratio of 4:1 and this is obtained as follows:

Place the FUNCTION switch in the LF HF TEST position, the RANGE switch in a position indicating a voltage approximating that to be used and the TEST switch to LF TEST. Advance the GENERATOR OUTPUT control to give the desired amount of voltage. Next, switch TEST to HF TEST and advance the HIGH FREQUENCY LEVEL control to give a reading just 1/4 of the reading obtained on LF TEST. Return the TEST switch to OPERATE, as the proper ratio is now set.

Example: LF TEST is set to 2 volts on the 3 volt range. HF TEST will be set to .5 volts on the same range.

Other voltages can be set in the same ratio, using whatever is needed to drive the amplifier under test to the desired output. Adjustment of output voltage can be done over a fairly wide range, using the LF HF GENERATOR OUTPUT control without changing the ratio substantially as long as the HIGH FREQUENCY LEVEL control is not touched.

Connect the output terminals of the analyzer to the amplifier input. If the output control cannot be adjusted to the desired input level of the equipment under test, additional attenuation may be inserted. Note that the generator output impedance is 3000  $\Omega$ . Shunting the output terminals with a 750  $\Omega$  resistor will result in a net output impedance of 600  $\Omega$ .

Connect the output terminals of the amplifier under test to the AA-1 input and set the LOAD switch to the proper load impedance (4, 8, 16 or 600  $\Omega$  if used at the output of an amplifier, HI-Z if used for stage by stage analysis). The output level may be determined by switching to OUTPUT or VTVM on the FUNCTION switch. Next, place the FUNCTION switch in the SET LEVEL position and the RANGE switch to the point indicated by the line between the two switches (3% IM). Advance the IM ANALYZER INPUT control to the "set level" mark on the meter. Place the RANGE switch in the 30% IM position and rotate the FUNCTION switch to %IM. Read the distortion figure on the appropriate meter scale (0-10 scale for 1, 10 and 100% and 0-3 scale for 3 or 30%). Move the RANGE switch to the right or left as needed to give a satisfactory indication.

Note that the frequency response of the equipment under test must be reasonably flat between the limits of the low and high frequency signals used, to prevent misleading indications. Also notice that the equipment under test may range all the way from a single component part to a complex device such as a speech amplifier-modulator-transmitter-monitor chain, or wire or tape recorder-playback amplifier system.

Phonograph pickups and preamplifiers may be checked by using standard IM test records, provided that the signal frequencies and level ratios are within the limitations of the analyzer section as described under circuit specifications.

### THEORY OF INTERMODULATION

For any device involving input and output signals, a plot of the instantaneous input and output signals will give an input-output characteristic.

For exact reproduction in electronic amplifiers, it is readily evident that a linear characteristic is necessary.

The inherent curvature of tube characteristics and non-linearity of other circuit elements, such as transformers, make a linear I-O characteristic not readily obtainable.

Although generally a very small portion of the characteristic may be considered substantially linear, at increased signal input levels additional curvature gives cause to a condition known as overload.

Curvature of the I-O characteristic gives rise to distortion which is known as "non-linear distortion." There are three methods presently used for determining this non-linear distortion: the harmonic distortion test, the intermodulation test by the SMPE method and the intermodulation test by the CCIF method.

The harmonic distortion test measures the amplitude of the individual or combined harmonics generated by the equipment under test, when a pure sine wave signal is applied. The result is expressed as a percentage of the pure signal.

The SMPE method measures the interaction of two pure sine wave signals of different frequencies when passed through the equipment under test. This method uses standard test conditions as prescribed by the SMPE and the result is expressed as a modulation percentage of one signal upon the other.

The CCIF method uses a similar principle under a different set of standard test conditions.

While these three methods all express their findings in "percent distortion," there is no evidence to substantiate one method better or more complete than another, nor is there any fixed relationship between the percentage figures obtained by the three methods.

It should be further pointed out that it is impossible to predict from a harmonic distortion measurement what percentage of intermodulation distortion may be present in a system. Conversely, a system relatively free of intermodulation distortion might conceivably generate moderate amounts of harmonic distortion at specific frequencies.

Essentially, two-signal operation of a device with a non-linear I-O characteristic results in modulation of one signal by the other signal. This modulation produces sidebands adjacent to the signal acting as carrier.

To illustrate, assuming input frequencies of 60 and 3000 cycles, non-linear operation would cause 60 cycle modulation of the 3000 cycle signal, resulting primarily in an output containing the following frequencies:

$$\begin{array}{ll} 60 \text{ cycles} & 3000 + 60 = 3060 \text{ cycles} \\ 3000 \text{ cycles} & 3000 - 60 = 2940 \text{ cycles} \end{array}$$

The inherent harmonic distortion caused by non-linear operation results in additional frequencies. Second harmonic distortion, for instance, adds the following frequencies:

$$\begin{array}{ll} 2 \times 60 = 120 \text{ cycles} & 2 \times 3000 \mp 60 = 6060 \text{ cycles} \\ 2 \times 3000 = 6000 \text{ cycles} & 2 \times 3000 - 60 = 5940 \text{ cycles} \\ 3000 + 2 \times 60 = 3120 \text{ cycles} & 2 \times 3000 + 2 \times 60 = 6120 \text{ cycles} \\ 3000 - 2 \times 60 = 2880 \text{ cycles} & 2 \times 3000 - 2 \times 60 = 5880 \text{ cycles} \end{array}$$

The harmonic distortion of a single frequency signal results in addition of harmonics to the original signal. In speech and music, this would result in a change in timbre or tone color.

The intermodulation distortion of multi-frequency signals results in addition of harmonically unrelated frequencies. As these additional frequencies are clustered around the original frequencies, they tend to blur the original signal. The location in the middle and upper region of the audible spectrum, at which the sensitivity of the human ear is high, makes these additional frequencies distinctly noticeable although their relative amplitude may be small.

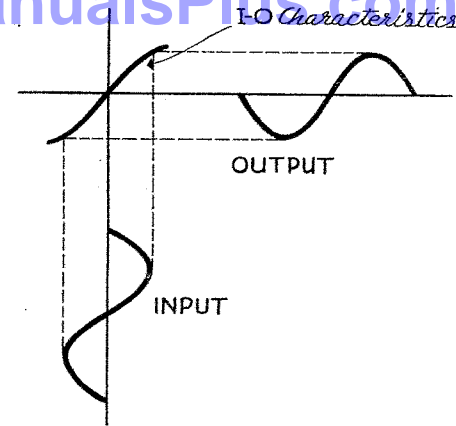

Figure 17

The more seriously audible effects of IM distortion make its measurement highly urgent in equipment intended for use in conjunction with audible reproduction of multi-frequency signals.

#### USE OF THE VOLTMETER FOR MULTIPLE FREQUENCY MEASUREMENTS

It should be noted that the two-frequency signal used for IM testing alters the generally accepted relationship between the RMS, average and peak values, which only hold true for a single sine wave. In the case of a single frequency signal, the meter will indicate the RMS value, while responding to the average value of the signal. In the case of the complex waveform of a two-frequency signal, the meter will respond to the average value of that signal, but the altered relationship between average and RMS values will cause a discrepancy in the indication. Such discrepancies will generally not be importantly large.

However, the difference in peak value of single and two-frequency signals that give equal meter indications may be quite substantial.

To enable suitable correlation of the measurement of various characteristics, such as harmonic distortion, IM distortion and square wave response, it is frequently found desirable to establish reference levels of voltage or power based on the peak value.

To properly evaluate the non-linearity of the I-O characteristic by different methods, the same portion of that characteristic should be used in each of the methods. Peak value indicates the maximum excursion of the signal on the I-O characteristic without regard to waveform. Thus, proper correlation may be obtained through the use of peak values.

Since most measurements are made with single frequency signals, and output levels are customarily expressed in RMS voltage or power, the levels of non-sinusoidal signals are frequently converted to equivalent RMS single frequency levels.

Thus, the RMS value of a two-frequency signal may be 8 volts, but because of the waveform the peak value may be as great as encountered in a single frequency signal of 10 volts RMS. This 10 volt level is called the "Equivalent single frequency RMS value."

For power levels calculated on the basis of the meter reading, the factor should be approximately  $1.25 \times 1.25$  or 1.56. For voltage ratios other than 4:1, the proper voltage factor is most readily determined through comparison of the meter reading and the peak value observed on an oscilloscope.

#### USING THE ENTIRE INSTRUMENT

Up to this point, each section of the instrument has been treated individually, pointing out the various functions and some uses for each function. In actual practice, all of these measurements can be made, one right after the other, without altering the connections between the equipment under test and the Audio Analyzer in any way. An example of a typical test run follows, and a diagram is furnished to illustrate the method of connecting equipment together.

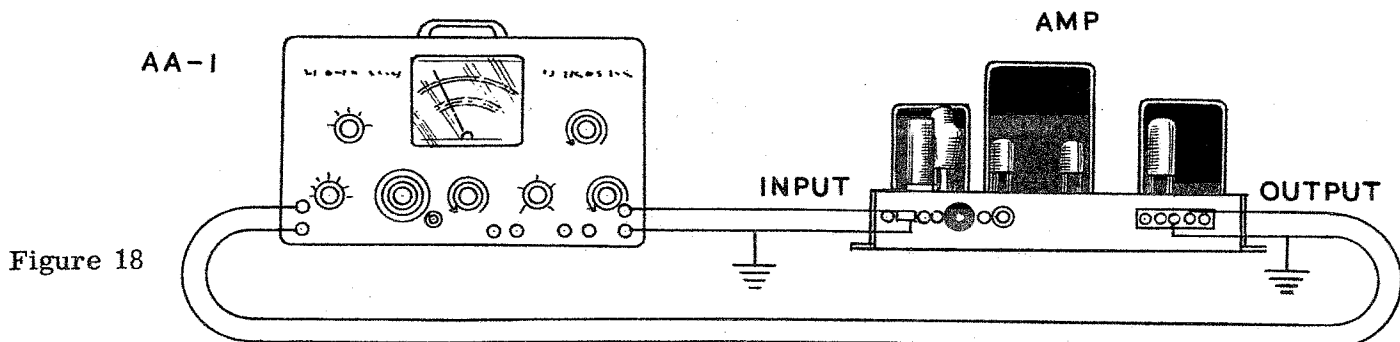

Figure 18

To start the set-up, output from the analyzer is connected to the amplifier or preamplifier input, using the test leads furnished. The other set of test leads is connected to the amplifier output, usually at the loudspeaker terminals unless a high impedance circuit is to be tested.

Assuming an amplifier with a  $16\ \Omega$  output, the output leads will be connected to the analyzer input, with ground of the amplifier to ground of the analyzer. The LOAD switch will be set to  $16\ \Omega$  under INT., the FUNCTION switch to OUTPUT, RANGE switch to 150 watts, TEST switch to LF TEST or HF TEST, depending on whether 60 or 6000 cycles is desired for measuring purposes. Output is adjusted to a satisfactory level with the OUTPUT control. The amplifier gain or the analyzer OUTPUT control is advanced until a reading is obtained. Maximum power output is evident when the meter needle stops going upscale with increasing input or shows a slight dip before going on upscale. This reading gives the maximum power output available from the amplifier and provides a reference reading in db for the next measurement, noise. Output from the generator is killed by either removing the jumpers between the LOW FREQ. and HIGH FREQ. binding posts or by connecting jumpers between each of the sets of connectors and one of the ground terminals on the analyzer. Noise readings will be obtained by decading down on the RANGE switch until a readable indication is evident. Subtracting the lower db reading from the higher will give the noise level in db below full output. If the amplifier is exceptionally quiet, it may be advantageous to reset the amplifier to max. output and switch to the analyzer VTVM function and repeat the procedure. Accurate readings will be obtained in either manner.

To test IM, the FUNCTION switch is set to LF HF TEST and the 4:1 ratio established at the desired level. The TEST switch is then set to OPERATE and the FUNCTION switch to SET LEVEL, with the RANGE switch in the indicated position. Adjust the meter needle to the "set level" mark by advancing the ANALYZER INPUT control and then switch to %IM on the FUNCTION dial and read %IM directly, advancing the RANGE switch if necessary.

Note that all measurements were made with the same connections between units and an accurate analysis of amplifier performance made in a minimum of time. Many additional measurements can be made with the use of a separate audio oscillator, such as frequency response, power response, etc. If a separate generator is used, the output terminals of the analyzer are not employed, except for IM measurements.

IM measurements at frequencies other than furnished by the analyzer can be made with an audio oscillator. If different low frequencies are desired, the jumper between the LOW FREQ. binding posts should be removed and the separate oscillator connected between the IN post and ground. (CAUTION: Do not touch the left hand LOW FREQ. post when the jumper is removed or when the test switch is in the HF TEST position. Approximately 50 volts AC is on this terminal under these conditions. While not dangerous, the shock can be annoying.) Level adjustment can be accomplished as before, using the TEST switch. In some cases, it might be desirable to connect a small value resistor between the generator and the analyzer input, especially if the generator has a very low impedance output. Different high frequencies can be used by removing the jumper between the HIGH FREQ. terminals and connecting the generator between the IN terminal and ground. To avoid interference from the oscillator in the analyzer, it is usually advisable to connect a jumper between the right hand HIGH FREQ. terminal and ground, rotating the HIGH FREQUENCY LEVEL control to its maximum clockwise position. If different high or low frequencies are used, they must be kept within the limits of the high and low pass filters in the analyzer as outlined on the specification page in the front of the manual.

#### ACCURACY

The accuracy of the meter movement is within 2% of full scale. Precision resistors used in the divider circuits are held within 1%. Some slight error may be introduced by the circuit itself. Final accuracy of the VTVM and output meter should be within 5% of full scale at the calibrating frequency. For the IM analyzer, accuracy of the readings obtained depend largely on the care used in the calibrating process. If properly calibrated, the accuracy may be expected to fall well within 10%.

In actual practice, inaccuracies do not usually fall in the same direction, consequently some tend to cancel out others. Therefore, it should be expected that the accuracy of the AA-1 will fall well within the described limits.

## ACCESSORY INSTRUMENTS

A stable, high sensitivity, wide band oscilloscope is very useful for all types of audio work. Some uses have already been outlined in this manual and many other applications can be found as outlined in many books on the subject, as well as magazine articles. A scope is especially useful for determining overload points in various stages, phase shift, instability and balance.

Many additional useful measurements can be made with a stable, wide range audio oscillator. An audio generator of some type is required to make frequency and power response runs and to analyze unusual phenomena at specific frequencies. It is quite important that the distortion and output impedance be quite low.

As mentioned previously, an amplifier with excellent IM characteristics may still have a fairly high harmonic distortion content. Use of a Harmonic Distortion Analyzer along with the AA-1 insures completely clean performance from an amplifier, once set up properly.

DC voltage measurements are always important in the adjustment and servicing of audio equipment. A 20,000  $\Omega$  per volt multimeter is very handy and will not load the circuit under test excessively. Where measurements must be made in high impedance circuits, a VTVM is recommended. Loading is kept at an absolute minimum with this type of instrument and true indications will always exist.





Many instruments with the qualifications listed above will be found in the Heathkit catalogs, flyers and advertisements. Every possible effort has been made at the Heath Company to provide the audio enthusiast and serviceman with a wide variety of high quality, low cost test equipment for a large number of applications.

## IN CASE OF DIFFICULTY

1. Recheck the wiring. Trace each load in colored pencil on the pictorial and schematic as it is followed in the instrument. Most cases of difficulty result from wrong connections. Often having a friend check the wiring will reveal a mistake consistently overlooked.
2. If possible, compare tube socket voltages with those shown on the voltage chart, Figure 19. The readings should be within 20% of those tabulated, if a vacuum tube voltmeter is used. Other type meters may give lower readings due to loading effects. If the voltage fails to compare with the value shown, check further into the circuit involved by checking the various components (resistors, tubes, condensers, etc.).

## VOLTAGE CHART

All readings are taken with a Heathkit 11 megohm vacuum tube voltmeter. All readings are DC voltages measured to chassis, unless otherwise specified. Variations up to 20% are normal and do not indicate trouble in most cases.

| SOCKET<br>TUBE TYPE | Pin 1   | Pin 2 | Pin 3   | Pin 4 | Pin 5   | Pin 6          | Pin 7   | Pin 8 | Pin 9 |
|---------------------|---|-------|---|-------|---|----------------|---|-------|-------|
| A<br>12AT7          | 180   | 65    | 100   | Fil.  | Fil.  | 100            | NS  | NS    | Fil.  |
| B<br>12AU7          | 300   | NS    | 20  | Fil.  | Fil.  | 35             | NS  | 0     | Fil.  |
| C<br>12AX7          | 250   | NS    | 2   | Fil.  | Fil.  | 130            | NS  | 1.7   | Fil.  |
| D<br>6C4            | 210   | NC    | Fil.  | Fil.  | NC  | -60            | 11  |       |       |
| E<br>6X4            | 250-300<br>VAC  | *     | Fil.  | Fil.  | *   | 250-300<br>VAC | 325   |       |       |
| FILTER CONDENSER    |  - 325 |       |  - 300 |       |  - 240 |                |  - 230 |       |       |

NC - no connection to this contact.

NS - not significant.

\*Voltage between pins 2 and 5 - 115 volts AC. Line voltage - 115 volts 60 cycles.

Fil. - voltage between two terminals so marked approximately 6.3 volts AC.

Readings were taken under the following conditions: LOAD at HI-Z, FUNCTION at VTVM, RANGE at 300 V, TEST at OPERATE and LEVEL and OUTPUT CONTROLS fully counterclockwise.

Carefully recheck the color codes on resistors, condensers and transformer leads. If there is a question concerning the color of a transformer lead, scraping the insulation lightly with a knife may help to identify the color quickly.

Some common troubles are listed below along with trouble shooting procedures which may be helpful in locating the source of difficulty.

#### INSTRUMENT COMPLETELY INOPERATIVE

If the instrument fails to operate, check the tubes to see if the filaments are lit. If there is no evidence of heating, measure across the end of the AC line inside the chassis. Lack of AC energy at this point indicates either an open line cord or imperfect connection at the outlet. The AC cord can be checked quickly with an ohmmeter. When voltage is obtained at this point, the voltmeter should be moved to connect across the black and black-red power transformer primary leads. No voltage at this point when the power switch is turned on indicates a defective switch on the back of the INPUT control or a wiring error.

Should voltage be present at all points in the 110 volt AC circuit, a short in the filament or rectifier plate or cathode circuits can be suspected. Careful visual inspection will usually reveal the source of trouble. If not, all tubes should be removed and the power transformer disconnected from the circuit. Ohmmeter checks for wiring shorts can then be made and the power transformer checked for open windings.

#### AC VTVM INOPERATIVE

If the VTVM will not operate, it will be impossible to get any indication from the other functions of the analyzer. Therefore, the VTVM should always be checked first when the entire instrument fails to operate properly.

Check the FUNCTION and RANGE switches against the pictorials and schematic to make sure the switches are constructed properly and all connections to these switches for proper order and short circuits. Special attention should be given to the shielded leads, for a practically invisible piece of braid can short against the center conductor, completely shorting out all signal. Once sure that the switching is all right, checks should be made at pins 1 and 6 of socket A, and pin 6 of B to see if proper B+ is present. Checks should also be made at pins 7 of A and 7 of B to make sure B+ is not present. Any positive potential at these points indicates a leaky coupling condenser. Calibrate control Q should be measured with an ohmmeter to make sure continuity exists. Check the 12AT7 and 12AU7 tubes, giving special attention to heater-to-cathode leakage in the 12AT7.

Consistent full scale reading of the meter indicates that the VTVM is oscillating. Careful re-dress of leads and components will usually clear this up. Rotate control Q rapidly back and forth a few times to insure good contact and at the same time, make sure too much feedback does not exist. This is done by rotating the control to its full counterclockwise position before attempting to calibrate the VTVM. Also check the 2  $\mu$ fd coupling condenser for excessive leakage.

Downscale readings on the meter indicate that the crystal diodes have been installed backwards. Proper readings will be obtained by reversing the connections to the meter, or reversing all of the diodes, whichever is more convenient.

If there is a reason to suspect the meter or meter rectifiers, they can be checked as follows:

Disconnect one end of each crystal diode from the circuit and connect an ohmmeter across each one in turn and note the reading. Next, reverse the connections to the diodes and note the reading again. The back to front ratio should be at least 50:1 or the diode is defective and should be replaced. To check the meter movement, connect a 10,000  $\Omega$  resistor to either meter terminal, disconnecting one of the circuit leads at the same time. Connect a single 1.5 volt flashlight battery to one side of the meter and the resistor, observing polarity. No deflection of the meter needle indicates an open or defective movement. **DO NOT** connect an ohmmeter or battery directly across the meter terminals, since this will burn the movement out almost immediately.

#### OUTPUT METER INOPERATIVE

If the VTVM will operate but the instrument will not measure power output, the trouble must lie in the switching. Attention should be given to the LOAD and FUNCTION switches to make sure the switches and connections are correct. All precision resistors on the LOAD switch should be checked out, as well as the 158.2 K $\Omega$  unit connecting to the FUNCTION switch. Inspect terminal strip K for short circuits as well as the shielded cables involved.

#### IM ANALYZER INOPERATIVE

A high-gain hi-pass amplifier is used in the IM section and any flaw in the amplifier will cause improper performance. Check the 12AX7 tube and if possible, substitute another for comparison purposes. Inspect all terminal strips, shielded cables and tube socket pins for shorts between terminals and to ground. Make sure the proper filter choke is installed at the correct location and connected properly. Check chokes for continuity.

Sometimes a signal tracing technique can be used to isolate the trouble to one stage. First, connect a test lead between the output of the analyzer and the input and set a 4:1 ratio of the internal generators just as if actual IM measurement were to be made. Set the FUNCTION switch to SET LEVEL and the RANGE switch to the appropriate position. Make sure the TEST switch is in the OPERATE position. Advance the IM ANALYZER INPUT control slowly and note whether or not any reading is evident. If a full scale reading can be obtained, the trouble lies in the 12AU7 stage and after. If not, something in the 12AX7 stage is at fault.

Assuming the 12AX7 stage is imperfect, a simple test can be made as follows. Switch FUNCTION to VTVM, LOAD to HI-Z and advance the INPUT control about 1/4 or 1/2 open. Connect one test lead between the output terminal and terminal strip K3. Connect another test lead to the input and the other end to socket C2. An AC reading should be evident. If necessary, rotate the INPUT, OUTPUT and RANGE controls for a satisfactory reading. Use low levels to avoid overloading. Next, connect the input lead to C1 and observe the reading. It should be considerably higher than at C2. (CAUTION: High voltages are present in these circuits. Proceed with due care.) If everything is all right at this point, connect the input lead to C7. The reading should be somewhat lower than at C1. The next test point is at C6. Look for a higher reading once again. Next is B2 which should be approximately the same as C6. Readings up to this point indicate that the high gain amplifier is operating properly. Final check is made by connecting the test input lead to terminal strip H4. Signal should be present, but at considerably lower amplitude. No signal indicates a shorted cable or terminal strip, or possibly a defect at control Z.

Proper indications to this point would seem to indicate that trouble lies in the low-pass filter. To test this, place the TEST switch in the LF TEST position and connect the output lead to B2. Other control settings will remain as before. Connect the input test lead to B2 and note the level. Next, connect the input lead to B3. The level should be slightly lower than at B2. The next check points in order are terminal strips H3, H1 and G1 with approximately the same or slightly lower readings being evident at each terminal in order. A sudden drop in level at any point indicates a possible short circuit on the associated terminal strip or some defect around the FUNCTION switch.

### INTERNAL GENERATORS INOPERATIVE OR DEFECTIVE

Lack of 60 cycle energy at the output can most likely be traced to terminal strip L and its associated components. Make sure that all components are all right and that proper connections have been made between L and socket E and L and the TEST switch. Check the LOW FREQ. binding posts for short circuits, making sure the shoulder insulating washers are properly centered. Inspect the TEST switch and associated connections carefully.

No high frequency output indicates a defect around the 6C4 tube, socket D, terminal strip J, the HIGH FREQUENCY LEVEL control and its associated shielded wire, the TEST switch or the HIGH FREQ. binding posts. Oscillation can be checked for by setting up the analyzer as a HI-Z VTVM as before and connecting the input test lead to J4. Lack of AC voltage indicates that there is no oscillation and checks of the tube, oscillator coil (continuity) and components are in order. If energy is present, check all other components mentioned above.

The 6000 cycle frequency specified for the high frequency oscillator is not necessarily exact, since variations in components will cause corresponding variations in frequency. While it is likely that the frequency can be adjusted by changing condensers etc., this procedure is not necessary. Frequency variations will in no way alter measurement accuracy as long as the frequency remains within the limits of the high pass filter.

The OUTPUT control is common to both generators and can be suspected if there is no output from either generator at any time, regardless of the position of the TEST switch. Insulation on the output terminals should also be checked, for a short at this point will completely disable the output.

### REPLACEMENTS

Material supplied with Heathkits has been carefully selected to meet design requirements and ordinarily will fulfill its function without difficulty. Occasionally improper instrument operation can be traced to a faulty tube or component. Should inspection reveal the necessity for replacement, write to the Heath Company and supply all of the following information:

- A. Thoroughly identify the part in question by using the part number and description found in the manual parts list.
- B. Identify the type and model number of kit in which it is used.
- C. Mention the order number and date of purchase.
- D. Describe the nature of defect or reason for requesting replacement.

The Heath Company will promptly supply the necessary replacement. Please do not return the original component until specifically requested to do so. Do not dismantle the component in question as this will void the guarantee. If tubes are to be returned, pack them carefully to prevent breakage in shipment as broken tubes are not eligible for replacement. This replacement policy does not cover the free replacement of parts that may have been broken or damaged through carelessness on the part of the kit builder.

### SERVICE

In event continued operational difficulties of the completed instrument are experienced, the facilities of the Heath Company Service Department are at your disposal. Your instrument may be returned for inspection and repair for a service charge of \$5.00 plus the cost of any additional material that may be required. **THIS SERVICE POLICY APPLIES ONLY TO COMPLETED INSTRUMENTS CONSTRUCTED IN ACCORDANCE WITH THE INSTRUCTIONS AS STATED IN THE MANUAL.** Instruments that are not entirely completed or instruments that are modified in design will not be accepted for repair. Instruments showing evidence of acid core solder or paste fluxes will be returned not repaired.

The Heath Company is willing to offer its full cooperation to assist you in obtaining the specified performance level in your instrument. Factory repair service is available for a period of one year from the date of purchase or you may contact the Engineering Consultation Department by mail. For information regarding the possible modification of existing kits, the volumes listed in the Bibliography section are recommended. They can be obtained at or through your local library, as well as at any electronic outlet store. Although the Heath Company sincerely welcomes all comments and suggestions, it would be impossible to design, test, evaluate and assume responsibility for proposed circuit changes for specific purposes. Therefore, such modifications must be made at the discretion of the kit builder according to information which will be much more readily available from some local source.

#### SHIPPING INSTRUCTIONS

Before returning a unit for service, be sure that all parts are securely mounted. Attach a tag to the instrument giving name, address and trouble experienced. Pack in a rugged container, preferably wood, using at least three inches of shredded newspaper or excelsior on all sides. **DO NOT SHIP IN THE ORIGINAL KIT CARTON AS THIS CARTON IS NOT CONSIDERED ADEQUATE FOR SAFE SHIPMENT OF THE COMPLETED INSTRUMENT.** Ship by prepaid express if possible. Return shipment will be made by express collect. Note that a carrier cannot be held liable for damage in transit if packing, in HIS OPINION, is insufficient.

#### SPECIFICATIONS

All prices are subject to change without notice. The Heath Company reserves the right to discontinue instruments and to change specifications at any time without incurring any obligation to incorporate new features in instruments previously sold.

#### WARRANTY

The Heath Company limits its warranty of parts supplied with any kit (except tubes, meters and rectifiers, where the original manufacturer's guarantee only applies) to a period of three (3) months from the date of purchase. Replacement will be made only when said part is returned postpaid, with prior permission and in the judgment of the Heath Company was defective at the time of sale. This warranty does not extend to any Heathkits which have been subjected to misuse, neglect, accident and improper installation or applications. Material supplied with a kit shall not be considered as defective, even though not in exact accordance with specifications, if it substantially fulfills performance requirements. This warranty is not transferable and applies only to the original purchaser. This warranty is in lieu of all other warranties and the Heath Company neither assumes nor authorizes any other person to assume for them any other liability in connection with the sale of Heathkits.

The assembler is urged to follow the instructions exactly as provided. The Heath Company assumes no responsibility or liability for any damages or injuries sustained in the assembly of the device or in the operation of the completed instrument.

#### HEATH COMPANY

Benton Harbor, Michigan

#### BIBLIOGRAPHY

It is impossible to discuss all the various aspects of the AC Voltmeter, Output Meter and Intermodulation Analyzer in this construction manual. The following list of articles, while quite incomplete, may aid you in obtaining further information.

Instrument for Intermodulation Measurements; Electronics, p. 134, March 1948  
 Intermodulation Testing; Wireless World, June 1951  
 Intermodulation Analyzer for Audio Systems; Audio Engineering, July 1950  
 Simplified Intermodulation Measurements; Audio Engineering, November 1950  
 Linearity Tests With an Oscilloscope; Radio and Television News, June 1950  
 The Measurement of Non-Linear Distortion; General Radio Co. Technical Publication B-3  
 Vacuum Tube Voltmeters, 2nd Edition, Rider, J. F.  
 An Electronic A. C. Voltmeter; Radio and Television News, February 1951  
 A Vacuum Tube Voltmeter for Audio Frequencies; Electronics, December 1940  
 Vacuum Tube Voltmeter Using Feedback; Electronics, September 1938  
 Practical Sound Engineering; Radio and Television News, May 1951

| PART No.          | PARTS Per Kit | DESCRIPTION                           | PART No.                                   | PARTS Per Kit | DESCRIPTION                    |
|-------------------|---------------|---------------------------------------|--|---------------|--------------------------------|
| <b>Resistors</b>  |               |                                       | <b>Controls-Switches</b>                   |               |                                |
| 1-1               | 2             | 47 $\Omega$                           | 10-9                                       | 1             | 10 K $\Omega$ control          |
| 1-11              | 2             | 1500 $\Omega$                         | 10-11                                      | 1             | 50 K $\Omega$ control          |
| 1-13              | 1             | 2700 $\Omega$                         | 10-14                                      | 1             | 250 K $\Omega$ control         |
| 1-16              | 3             | 4700 $\Omega$                         | 10-27                                      | 1             | 3000 $\Omega$ control          |
| 1-20              | 4             | 10 K $\Omega$                         | 11-16                                      | 1             | 40 $\Omega$ wire wound control |
| 1-21              | 1             | 15 K $\Omega$                         | 19-26                                      | 1             | 1 megohm control w/switch      |
| 1-22              | 4             | 22 K $\Omega$                         | 63-32                                      | 1             | 1 pole 3 pos. Test switch      |
| 1-25              | 2             | 47 K $\Omega$                         | 63-90                                      | 1             | 2 pole 5 pos. Function switch  |
| 1-26              | 4             | 100 K $\Omega$                        | 63-91                                      | 1             | 2 pole 9 pos. Load switch      |
| 1-32              | 1             | 390 K $\Omega$                        | 63-93                                      | 1             | 1 pole 10 pos. Range switch    |
| 1-35              | 2             | 1 megohm                              | <b>Meter-Diodes</b>                        |               |                                |
| 1-40              | 2             | 10 megohm                             | 407-29                                     | 1             | Meter                          |
| 1-71              | 1             | 4.7 megohm                            | 56-2                                       | 3             | Crystal diode                  |
| 1-7A              | 1             | 47 K $\Omega$ 1 watt                  | <b>Transformer-Chokes</b>                  |               |                                |
| 1-26A             | 1             | 15 K $\Omega$ 1 watt                  | 46-4                                       | 1             | 5h choke                       |
| 2-22              | 1             | 31.62 $\Omega$ precision              | 46-5                                       | 1             | 10h choke                      |
| 2-23              | 1             | 68.38 $\Omega$ precision              | 51-5                                       | 1             | Oscillator coil                |
| 2-25              | 1             | 216.2 $\Omega$ precision              | 54-5                                       | 1             | Power transformer              |
| 2-28              | 1             | 683.8 $\Omega$ precision              | <b>Sheet Metal Parts</b>                   |               |                                |
| 2-31              | 1             | 2162 $\Omega$ precision               | 200-M73                                    | 1             | Chassis                        |
| 2-33              | 1             | 6838 $\Omega$ precision               | 203-67F87                                  | 1             | Panel                          |
| 2-39              | 1             | 21.62 K $\Omega$ precision            | 204-M79                                    | 1             | Resistor bracket               |
| 2-40              | 1             | 68.38 K $\Omega$ precision            | 205-M37                                    | 1             | Shield plate                   |
| 2-42              | 1             | 216.2 K $\Omega$ precision            | 211-1                                      | 1             | Handle                         |
| 2-45              | 1             | 683.8 K $\Omega$ precision            | 90-24                                      | 1             | Cabinet                        |
| 2-49              | 1             | 3 megohm precision                    | <b>Pilot Light Assembly</b>                |               |                                |
| 2-89              | 1             | 158.2 K $\Omega$ precision            | 252-12                                     | 1             | Nut                            |
| 2-23A             | 1             | 800 $\Omega$ precision 1 watt         | 412-1                                      | 1             | #47 lamp                       |
| 2-24A             | 1             | 2100 $\Omega$ precision 1 watt        | 412-1                                      | 1             | Jewel                          |
| 2-25A             | 1             | 2900 $\Omega$ precision 1 watt        | 434-22                                     | 1             | Socket                         |
| 2-7B              | 1             | 4200 $\Omega$ precision 2 watt        | 455-1                                      | 1             | Bushing                        |
| 3-1X              | 1             | 4 $\Omega$ 24 watt ww non-inductive   | <b>Wire</b>                                |               |                                |
| 3-2X              | 1             | 8 $\Omega$ 24 watt ww non-inductive   | 89-1                                       | 1             | Line cord                      |
| 3-3X              | 1             | 16 $\Omega$ 24 watt ww non-inductive  | 206-4                                      | 1             | length Spirashield             |
| 3-4X              | 1             | 638 $\Omega$ 24 watt ww non-inductive | 340-2                                      | 1             | length Bare wire               |
| <b>Condensers</b> |               |                                       | 341-1                                      | 2             | length Black test lead 3'      |
| 21-7              | 1             | 33 $\mu$ f ceramic                    | 341-2                                      | 2             | length Red test lead 3'        |
| 21-9              | 1             | 100 $\mu$ f ceramic                   | 343-2                                      | 1             | length Shielded test lead      |
| 21-13             | 3             | 500 $\mu$ f ceramic                   | 344-1                                      | 1             | length Hookup wire             |
| 21-14             | 1             | 1000 $\mu$ f ceramic                  | 346-1                                      | 1             | length Spaghetti               |
| 21-28             | 1             | 10 $\mu$ f ceramic                    | <b>Sockets-Terminal Strips-Wafer-Knobs</b> |               |                                |
| 21-33             | 1             | 3.3 $\mu$ f ceramic                   | 431-10                                     | 1             | 3-lug terminal strip           |
| 23-2              | 3             | .005 $\mu$ fd molded                  | 431-11                                     | 1             | 5-lug terminal strip           |
| 23-17             | 1             | 2 $\mu$ fd metalized tubular          | 431-12                                     | 4             | 4-lug terminal strip           |
| 23-3              | 3             | .01 $\mu$ fd molded                   | 431-14                                     | 2             | 2-lug terminal strip           |
| 23-61             | 6             | .05 $\mu$ fd molded                   | 431-16                                     | 1             | 2-lug terminal strip           |
| 25-21             | 1             | 20-20-20-20 $\mu$ fd 450 volt         | 434-15                                     | 2             | 7-pin tube socket              |
| <b>Tubes</b>      |               |                                       | 434-16                                     | 3             | 9-pin tube socket              |
| 411-4             | 1             | 6C4                                   | 462-19                                     | 7             | Knob                           |
| 411-24            | 1             | 12AT7                                 | 481-1                                      | 1             | Condenser mounting wafer       |
| 411-25            | 1             | 12AU7                                 |  |               |                                |
| 411-26            | 1             | 12AX7                                 |  |               |                                |
| 411-64            | 1             | 6X4                                   |  |               |                                |

| <u>PART</u><br><u>No.</u>                 | <u>PARTS</u><br><u>Per Kit</u> | <u>DESCRIPTION</u>                  |
|---|--------------------------------|-------------------------------------|
| <b>Binding Post Assemblies-Insulators</b> |                                |                                     |
| 70-5                                      | 2                              | Banana plug insulator, black        |
| 70-6                                      | 2                              | Banana plug insulator, red          |
| 73-1                                      | 9                              | Grommet                             |
| 100-M16B                                  | 6                              | Binding post cap, black             |
| 100-M16R                                  | 2                              | Binding post cap, red               |
| 253-1                                     | 8                              | #6 flat fiber washer                |
| 253-2                                     | 6                              | #6 shoulder fiber washer            |
| 259-1                                     | 9                              | #6 solder lug                       |
| 427-2                                     | 8                              | Binding post base                   |
| 438-13                                    | 4                              | Banana plug assembly less insulator |
| <b>Hardware</b>                           |                                |                                     |
| 208-2                                     | 2                              | Spring clip                         |
| 250-2                                     | 10                             | 3-48 screw                          |
| 250-7                                     | 2                              | 6-32 x 3/16 screw                   |
| 250-8                                     | 3                              | #6 sheet metal screw                |
| 250-9                                     | 15                             | 6-32 x 3/8 screw                    |
| 250-19                                    | 2                              | 10-24 screw                         |
| 250-38                                    | 4                              | 10-32 flat head screw               |
| 250-43                                    | 7                              | 8-32 headless set screw             |
| 252-1                                     | 10                             | 3-48 nut                            |
| 252-3                                     | 25                             | 6-32 nut                            |
| 252-4                                     | 2                              | 8-32 nut                            |
| 252-5                                     | 4                              | 10-32 nut                           |
| 252-7                                     | 10                             | 3/8-32 control nut                  |
| 253-10                                    | 7                              | Control flat washer                 |
| 253-19                                    | 4                              | #10 steel washer                    |
| 254-1                                     | 16                             | #6 lockwasher                       |
| 254-2                                     | 2                              | #8 lockwasher                       |
| 254-3                                     | 2                              | #10 lockwasher                      |
| 254-4                                     | 9                              | 3/8 lockwasher                      |
| 259-10                                    | 1                              | Control solder lug                  |
| 260-1                                     | 4                              | Alligator clip                      |
| 261-1                                     | 4                              | Rubber feet                         |
| 595-100                                   | 1                              | Manual                              |

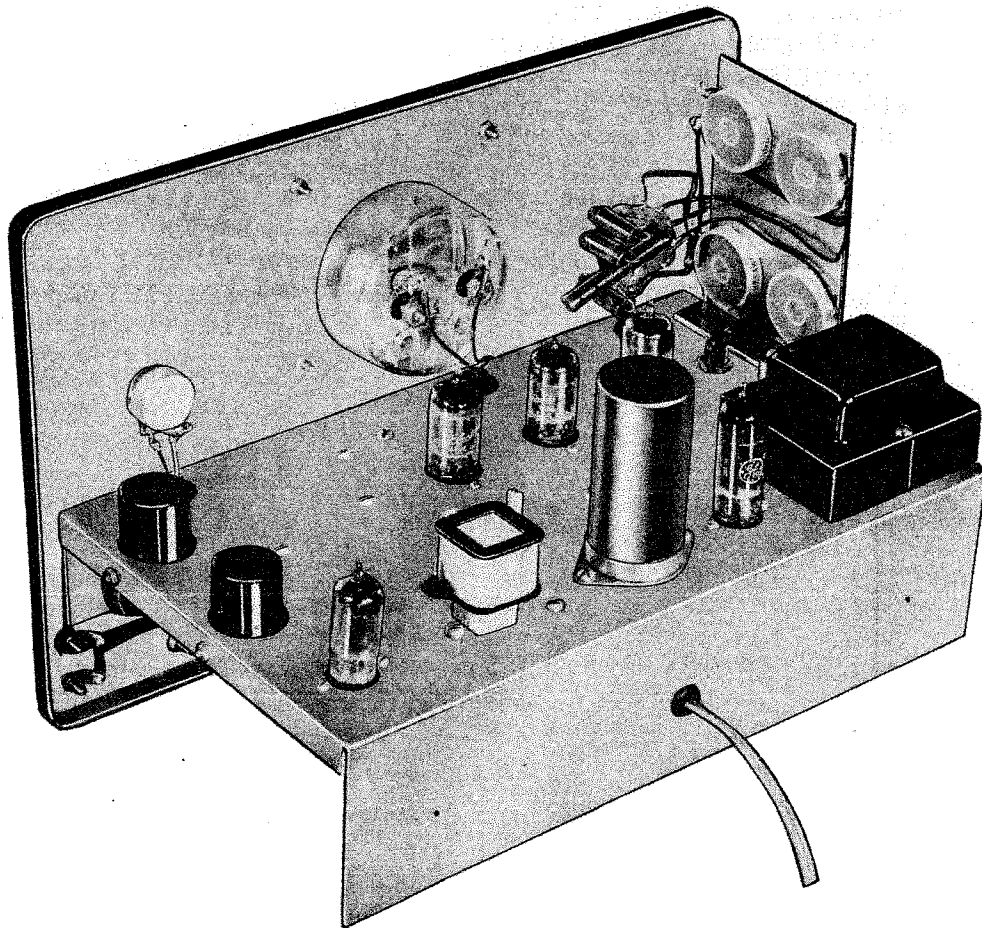
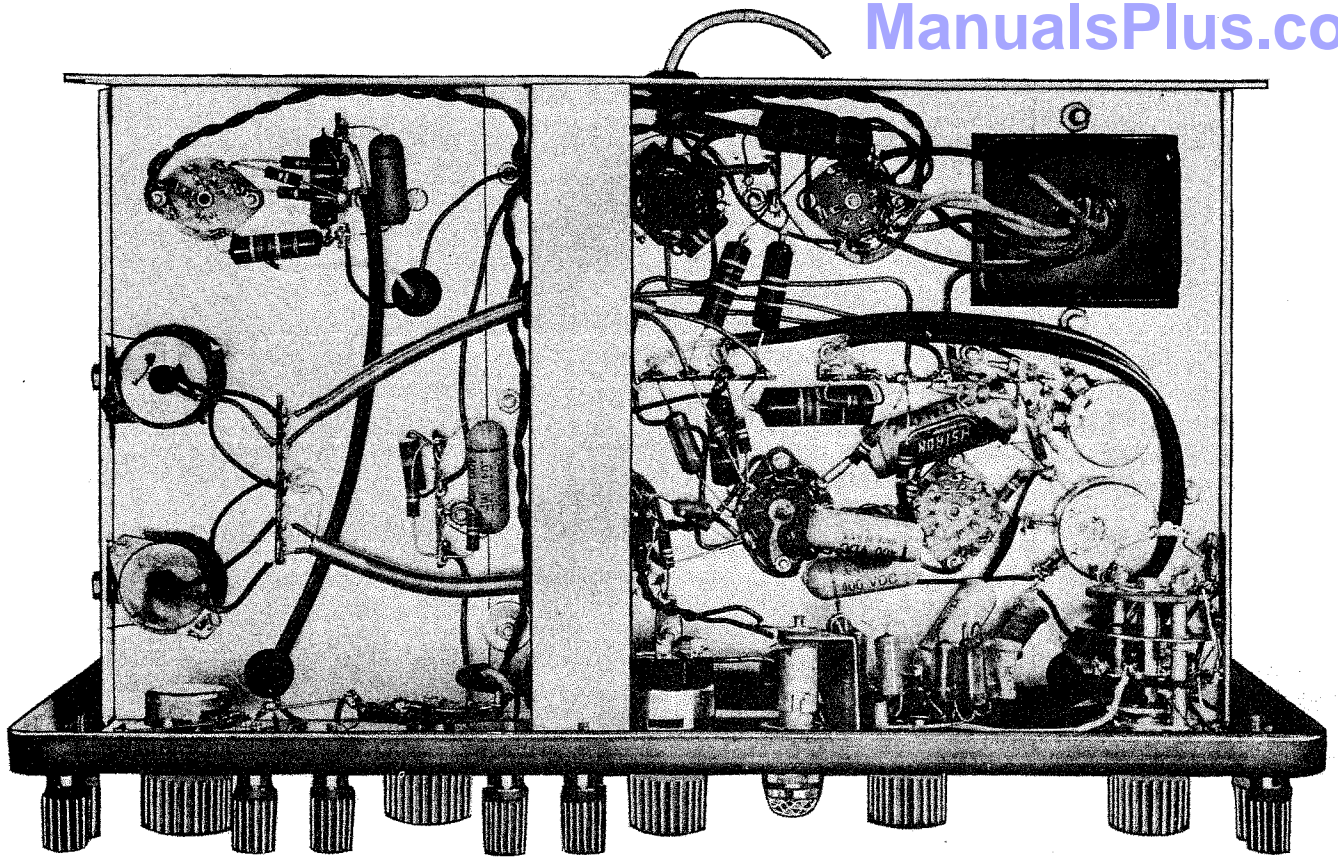

## HELPFUL KIT BUILDING INFORMATION

Before attempting actual kit construction read the construction manual through thoroughly to familiarize yourself with the general procedure. Note the relative location of pictorials and pictorial inserts in respect to the progress of the assembly procedure outlined.

This information is offered primarily for the convenience of novice kit builders and will be of definite assistance to those lacking thorough knowledge of good construction practices. Even the advanced electronics enthusiast may benefit by a brief review of this material before proceeding with kit construction. In the majority of cases, failure to observe basic instruction fundamentals is responsible for inability to obtain desired level of performance.

### RECOMMENDED TOOLS

The successful construction of Heathkits does not require the use of specialized equipment and only basic tools are required. A good quality electric soldering iron is essential. The preferred size would be a 100 watt iron with a small tip. The use of long nose pliers and diagonal or side cutting pliers is recommended. A small screw driver will prove adequate and several additional assorted screw drivers will be helpful. Be sure to obtain a good supply of rosin core type radio solder. Never use separate fluxes, paste or acid solder in electronic work.

### ASSEMBLY

In the actual mechanical assembly of components to the chassis and panel, it is important that the procedure shown in the manual be carefully followed. Make sure that tube sockets are properly mounted in respect to keyway or pin numbering location. The same applies to transformer mountings so that the correct transformer color coded wires will be available at the proper chassis opening.

Make it a standard practice to use lock washers under all 6-32 and 8-32 nuts. The only exception being in the use of solder lugs—the necessary locking feature is already incorporated in the design of the solder lugs. A control lock washer should always be used between the control and the chassis to prevent undesirable rotation in the panel. To improve instrument appearance and to prevent possible panel marring use a control flat nickel washer under each control nut.

When installing binding posts that require the use of fiber insulating washers, it is good practice to slip the shoulder washer over the binding post mounting stud before installing the mounting stud in the panel hole provided. Next, install a flat fiber washer and a solder lug under the mounting nut. Be sure that the shoulder washer is properly centered in the panel to prevent possible shorting of the binding post.

### WIRING

When following wiring procedure make the leads as short and direct as possible. In filament wiring requiring the use of a twisted pair of wires allow sufficient slack in the wiring that will permit the twisted pair to be pushed against the chassis as closely as possible thereby affording relative isolation from adjacent parts and wiring.

When removing insulation from the end of hookup wire, it is seldom necessary to expose more than a quarter inch of the wire. Excessive insulation removal may cause a short circuit condition in respect to nearby wiring or terminals. In some instances, transformer leads of solid copper will have a brown baked enamel coating. After the transformer leads have been trimmed to a suitable length, it is necessary to scrape the enamel coating in order to expose the bright copper wire before making a terminal or soldered connection.

In mounting parts such as resistors or condensers, trim off all excess lead lengths so that the parts may be installed in a direct point-to-point manner. When necessary use spaghetti or insulated sleeving over exposed wires that might short to nearby wiring.

It is urgently recommended that the wiring dress and parts layout as shown in the construction manual be faithfully followed. In every instance, the desirability of this arrangement was carefully determined through the construction of a series of laboratory models.

### SOLDERING

Much of the performance of the kit instrument, particularly in respect to accuracy and stability, depends upon the degree of workmanship used in making soldered connections. Proper soldered connections are not at all difficult to make but it would be advisable to observe a few precautions. First of all before a connection is to be soldered, the connection itself should be clean and mechanically strong. Do not depend on solder alone to hold a connection together. The tip of the soldering iron should be bright, clean and free of excess solder. Use enough heat to thoroughly flow the solder smoothly into the joint. Avoid excessive use of solder and do not allow a flux flooding condition to occur which could conceivably cause a leakage path between adjacent terminals on switch assemblies and tube sockets. This is particularly important in instruments such as the VTVM, oscilloscope and generator kits. Excessive heat will also burn or damage the insulating material used in the manufacture of switch assemblies. Be sure to use only good quality rosin core radio type solder.

|                                     |  |   |  |                                       |  |                                   |  |
|-------------------------------------|--|---|--|---------------------------------------|--|-----------------------------------|--|
| Antenna<br>General                  |  | Resistor<br>General   |  | Neon Bulb                             |  | Receptacle<br>two-conductor       |  |
| Loop                                |  | Resistor<br>Tapped  |  | Illuminating<br>Lamp                  |  | Battery                           |  |
| Ground                              |  | Resistor Variable   |  | Switch<br>Single pole<br>Single throw |  | Fuse                              |  |
| Inductor<br>General                 |  | Potentiometer   |  | Switch<br>double pole<br>single throw |  | Piezoelectric<br>Crystal          |  |
| Air core<br>Transformer<br>General  |  | Thermistor  |  | Switch<br>Triple pole<br>Double throw |  | 1000 = K                          |  |
| Adjustable<br>Powdered Iron<br>Core |  | Jack<br>two conductor   |  | Switch<br>Multipoint or<br>Rotary     |  | 1,000,000 = M                     |  |
| Magnetic Core<br>Variable Coupling  |  | Jack<br>three conductor                                       |  | Speaker                               |  | OHM = Ω                           |  |
| Iron Core<br>Transformer            |  | Wires<br>connected  |  | Rectifier                             |  | Microfarad = MF                   |  |
| Capacitor<br>General                |  | Wires<br>Crossing but<br>not connected                        |  | Microphone                            |  | Micro<br>Microfarad = MMF         |  |
| Capacitor<br>Electrolytic           |  | A. Ammeter<br>V. Voltmeter                                    |  | Typical tube symbol                   |  | Binding post<br>Terminal strip    |  |
| Capacitor<br>Variable               |  | G. Galvanometer<br>MA. Milliammeter<br>uA. Microammeter, etc. |  |                                       |  | Wiring between<br>like letters is |  |

# **HEATH COMPANY**

*A Subsidiary of Daystrom Inc.*

THE WORLD'S FINEST ELECTRONIC EQUIPMENT IN KIT FORM

**BENTON HARBOR, MICHIGAN**