

# HEATHKIT<sup>®</sup> MANUAL

*for the*

## ACTIVE ANTENNA

Model HD-1424

595-3469-02

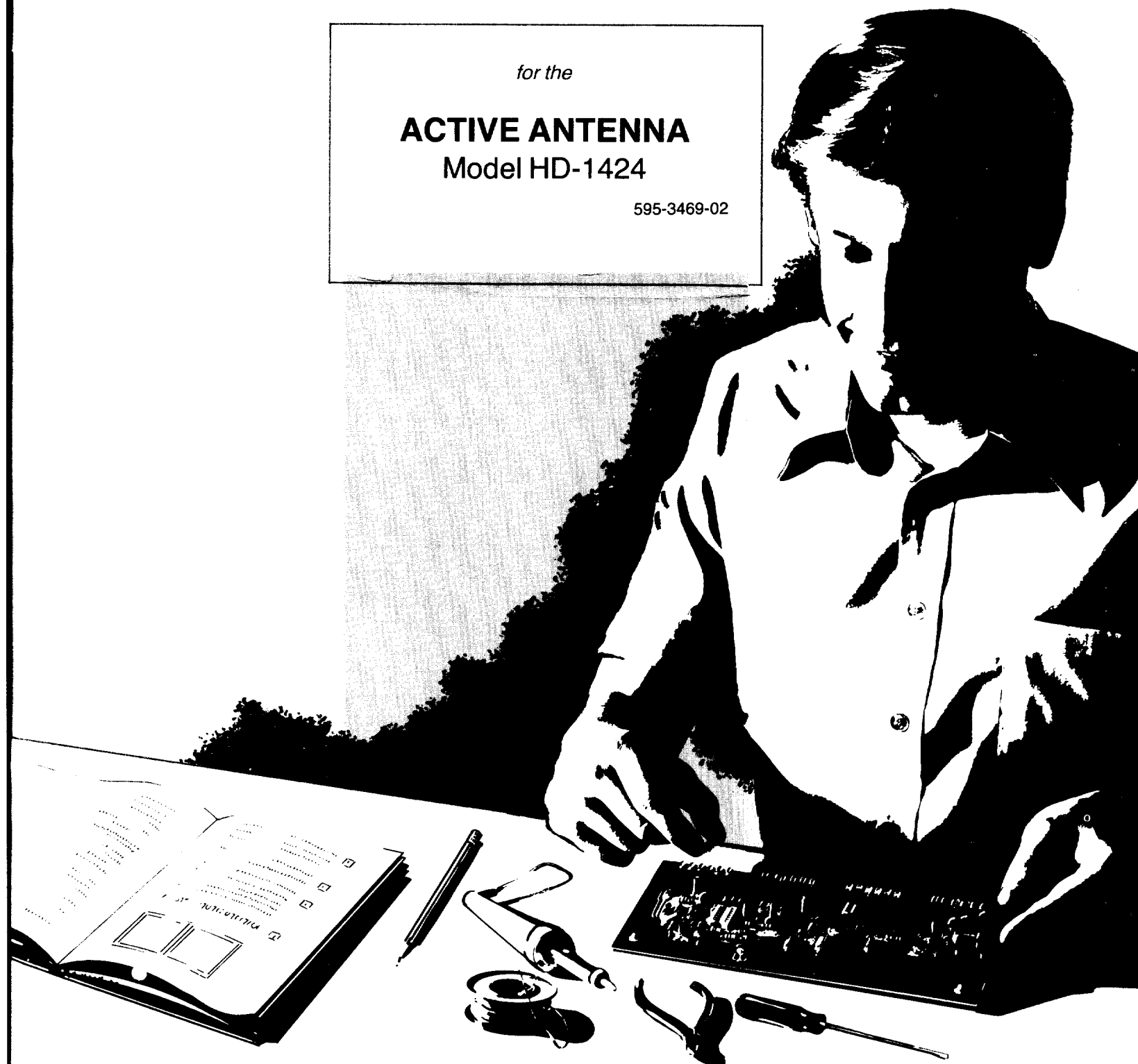

# Heathkit® Manual

*for the*

## **ACTIVE ANTENNA**

Model HD-1424

595-3469-02

HEATH COMPANY  
BENTON HARBOR, MICHIGAN 49022

**Copyright ©1985**  
Heath Company  
*All Rights Reserved*  
Printed in the United States of America

---

## TABLE OF CONTENTS

Introduction .....	3	In Case of Difficulty .....	21
Assembly Notes .....	4	Visual Checks .....	21
Parts List .....	7	Troubleshooting Chart .....	22
Step-by-Step Assembly .....	9	Specifications .....	23
Circuit Board Assembly .....	9	Circuit Description .....	24
Circuit Board Checkout .....	14	Semiconductor Identification .....	25
Chassis Assembly .....	14	Circuit Board X-Ray View .....	26
Initial Tests .....	18	Schematic .....	Illustration Booklet, Page 10
Installation and Operation .....	19	Warranty .....	Inside front cover
Installation .....	19	Customer Service .....	Inside rear cover
Operation .....	19		

## INTRODUCTION

The Heathkit Model HD-1424 Active Antenna provides reception of radio signals between 300 kHz and 30 MHz when you cannot put up an outside antenna. The wide frequency range covers all of the international broadcast bands, high-frequency amateur bands, and many other service bands.

In addition, its circuitry and tuned- input allow it to function as a preselector for both indoor and outdoor antennas. It also functions as an antenna

preamplifier when you use it with an external 50-ohm antenna.

The telescoping antenna and provision for a standard 9-volt battery provide complete portability. An OFF/ON switch automatically bypasses the circuitry whenever it is turned off.

The easy assembly and simple connection to a receiver will provide many hours of listening enjoyment.

**PARTS**

**Resistors** are identified in Parts Lists and steps by their resistance value in Ω (ohms), kΩ (kilohms), or MΩ (megohms). They are usually identified by a color code of four or five color bands, where each color represents a number. These colors (except for the last band, which indicates a resistor's "tolerance") will be given in the steps in their proper order. Therefore, the following color code is given for information only. NOTE: Occasionally, a "precision" or "power" resistor may have the value stamped on it.

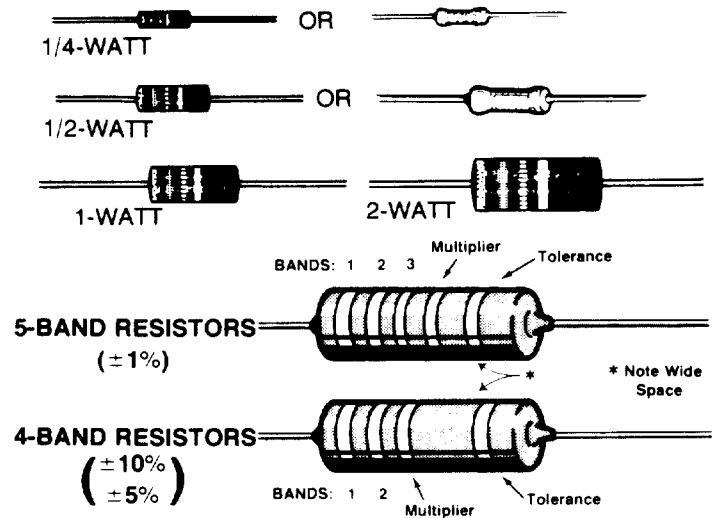

Band 1 1st Digit	
Color	Digit
Black	0
Brown	1
Red	2
Orange	3
Yellow	4
Green	5
Blue	6
Violet	7
Gray	8
White	9

Band 2 2nd Digit	
Color	Digit
Black	0
Brown	1
Red	2
Orange	3
Yellow	4
Green	5
Blue	6
Violet	7
Gray	8
White	9

Band 3 (if used) 3rd Digit	
Color	Digit
Black	0
Brown	1
Red	2
Orange	3
Yellow	4
Green	5
Blue	6
Violet	7
Gray	8
White	9

Multiplier	
Color	Multiplier
Black	1
Brown	10
Red	100
Orange	1,000
Yellow	10,000
Green	100,000
Blue	1,000,000
Silver	0.01
Gold	0.1

Resistance Tolerance	
Color	Tolerance
Silver	± 10%
Gold	± 5%
Red	± 2%
Brown	± 1%
Green	± .5%
Blue	± 25%
Violet	± .1%
Gray	± .05%

**Capacitors** will be called out by their capacitance value in μF (microfarads) or pF (picofarads) and type: ceramic, Mylar\*, electrolytic, etc. Some capacitors may have their value printed in the following manner:

EXAMPLES:

151K = 15 × 10 = 150 pF  
 759 = 75 × 0.1 = 7.5 pF

NOTE: The letter "R" may be used at times to signify a decimal point: as in: 2R2 = 2.2 (pF or μF).

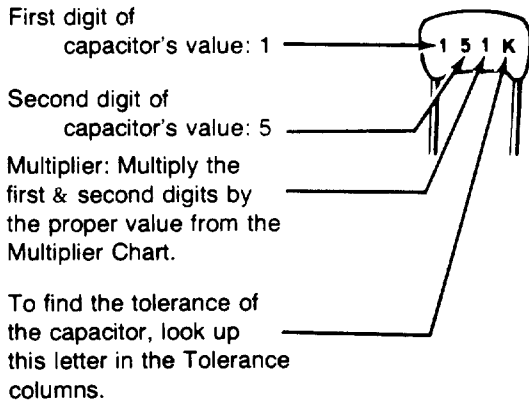

MULTIPLIER		TOLERANCE OF CAPACITOR		
FOR THE NUMBER:	MULTIPLY BY:	10 pF OR LESS	LETTER	OVER 10 pF
0	1	±0.1 pF	B	
1	10	±0.25 pF	C	
2	100	±0.5 pF	D	
3	1000	±1.0 pF	F	± 1%
4	10,000	±2.0 pF	G	±2%
5	100,000		H	±3%
			J	±5%
8	0.01		K	±10%
9	0.1		M	±20%

\*DuPont Registered Trademark.

## PARTS LIST

Unpack the kit and check each part against the following list. The key numbers correspond to the numbers on the "Parts Pictorial." Do not remove components from the tape until you use them in a step. If a part is packed in an individual envelope with the part number on it, identify the part; then return it to the envelope until a step calls for it. Do not throw away any packing material until you account for all of the parts.

To order a replacement part, always include the PART NUMBER. Use the Parts Order Form furnished with this kit. If a Parts Order Form is not available, refer to "Replacement Parts" inside the rear cover of this Manual.

KEY No.	HEATH Part No.	QTY.	DESCRIPTION	CIRCUIT Comp. No.
---------	----------------	------	-------------	-------------------

### CAPACITORS

A1	21-147	2	47 pF (47K) ceramic	C2, C104
A1	21-75	1	100 pF (100K) ceramic	C101
A1	21-176	8	.01 $\mu$ F (.01M) ceramic	C102, C103, C105, C106, C107, C108, C109, C111

### CONTROL—SWITCHES

B1	10-1054	1	1000 $\Omega$ (1 k) control	R1
B2	60-20	1	Slide switch	SW1A/B/C
B3	63-1398	1	Rotary switch	SW2

### SHEET METAL PARTS

C1	90-1357-1	1	Cover
C2	200-1506-1	1	Chassis
C3	204-2257	1	Angle bracket
C4	204-2915	1	Capacitor mounting bracket

### HARDWARE

NOTE: Hardware packets are marked to show the size of the hardware they contain (HDW#4, or HDW #6 & #8, etc.). You may have to open more than one packet to locate all of the hardware of any one size (#6, for example).

KEY No.	HEATH Part No.	QTY.	DESCRIPTION	CIRCUIT Comp. No.
---------	----------------	------	-------------	-------------------

### HARDWARE (Cont'd.)

#### #3 Hardware

D1	250-49	2	3-48 $\times$ 1/4" screw
D2	252-1	2	3-48 nut
D3	254-7	2	#3 lockwasher

#### #4 Hardware

E1	250-1412	8	4-40 = 3/8" screw
E2	252-2	8	4-40 nut
E3	254-9	7	#4 lockwasher
E4	259-9	1	#4 solder lug

#### #6 Hardware

F1	250-1282	1	6-32 $\times$ 1/8" setscrew
F2	250-230	2	6-32 $\times$ 3/16" setscrew
F3	250-1325	2	6-32 $\times$ 1/4" screw
F4	250-1432	4	#6 $\times$ 3/8" sheet metal screw
F5	250-1425	4	6-32 $\times$ 1/2" black screw
F6	250-1430	1	6-32 $\times$ 1/2" stainless steel screw
F7	252-3	14	6-32 nut
F8	253-35	1	#6 fiber flat washer
F9	253-741	1	#6 shoulder washer
F10	254-1	9	#6 lockwasher
F11	259-1	2	#6 solder lug

KEY No.	HEATH Part No.	QTY.	DESCRIPTION	CIRCUIT Comp. No.
---------	----------------	------	-------------	-------------------

**Other Hardware**

G1	252-4	1	8-32 nut	
G2	252-7	3	Control nut	
G3	253-734	2	Control flat washer	
G4	254-2	1	#8 lockwasher	
G5	254-5	2	Control lockwasher	
G6	259-10	1	Control solder lug	

**TRANSISTORS**

NOTE: Transistors may be marked for identification in any of the following four ways:

1. Part number.
2. Type number
3. Part number and type number.
4. Part number with a type number other than the one listed.

H1	417-290	1	MRF502	Q103
H2	417-931	2	PN4858	Q101, Q102

**SOCKETS—CONNECTORS**

J1	432-798	1	Battery snap connector	
J2	432-866	2	Spring connector	
J3	432-1030	1	2-pin socket shell	
J4	436-5	2	Coaxial jack	J2, J3
J5	436-28	1	Phone jack with hardware	J1

**WIRE—SLEEVING**

343-15	31"	Shielded cable
344-165	15"	Red solid wire
344-172	24"	White solid wire
346-6	1	Sleeving (1-1/4" long)

**MISCELLANEOUS**

K1	26-171	1	10-350 pF variable capacitor	C1
K2	45-74	1	.47 $\mu$ H choke	L101
K3	45-606	1	1 $\mu$ H choke (brn-gold-blk)	L107
K3	45-634	1	82 $\mu$ H choke (gry-red-blk)	L104
K4	75-743	1	Insulator	
	85-3093-1	1	Circuit board	
K5	142-128	1	Collapsible antenna	
K6	208-42	1	Battery clamp	
K7	261-29	4	Foot	

KEY No.	HEATH Part No.	QTY.	DESCRIPTION	CIRCUIT Comp. No.
---------	----------------	------	-------------	-------------------

**MISCELLANEOUS (Cont'd.)**

K8		1	Blue and white label*	
K9	412-633	1	LED (light-emitting diode)	D1
K10	455-44	1	Snap-in bearing	
K11	462-1152	3	Knob	
K12	490-14	1	Allen wrench	
	597-260	1	Parts Order Form*	
		1	Assembly Manual (See Page 1 for the part number.)	

Solder

\* These items may be packed inside the Manual.

**TAPED COMPONENT CHART**

NOTE: These parts are taped on a strip which was checked before shipment. Since these parts are taped in the order of assembly, it is not necessary to check them against the following list.

**RESISTORS**

NOTE: The following resistors are rated at 1/4-watt and have a tolerance of 5%. A 5% tolerance is indicated by a fourth color band of gold.

6-101-12	3	100 $\Omega$ (brn-blk-brn)	R101, R104, R107
6-221-12	2	220 $\Omega$ (red-red-brn)	R102, R105
6-391-12	1	390 $\Omega$ (org-wht-brn)	R109
6-471-12	1	470 $\Omega$ (yel-viol-brn)	R108
6-104-12	1	100 k $\Omega$ (brn-blk-yel)	R106
6-185-12	1	1.8 M $\Omega$ (brn-gry-grn)	R103

**CHOKES**

45-626	1	3.3 $\mu$ H (org-org-gold)	L102
45-631	1	22 $\mu$ H (red-red-blk)	L103
45-621	1	100 $\mu$ H (brn-blk-brn)	L105
45-635	1	1 mH (brn-blk-red)	L106

## INITIAL TESTS

NOTE: You will need a high-impedance input ohmmeter to perform the following tests. If you do not have one, proceed to the "Installation and Operation" section.

Refer to Pictorial 3-1 for the following steps.

If you do not obtain the correct indications in the following steps, check for solder bridges on the circuit board or wiring errors. Be sure you obtain the correct indication in each step before you proceed to the next step.

NOTE: Do not install a battery or connect a power source to the unit until a step directs you to do so.

- ( ) Be sure the OFF/ON switch is OFF and the BAND switch is at D.
- ( ) Connect your negative (or common) ohmmeter lead to the chassis. Leave this lead connected to the chassis until a step directs you to disconnect it.
- ( ) Set the ohmmeter to the R  $\times$  10 range.
- ( ) Touch the positive ohmmeter lead to switch SW1 lug 7. The ohmmeter should indicate between 120 and 180 ohms.
- ( ) Touch the positive ohmmeter lead to switch SW1 lug 8. The ohmmeter should indicate infinity with the OFF/ON switch off and between 120 and 180 ohms with the switch on.

- ( ) Touch the positive ohmmeter lead to tuning capacitor C1 lug 2. The ohmmeter should indicate zero ohms.
- ( ) Set the ohmmeter to the R  $\times$  100 range.
- ( ) Touch the positive ohmmeter lead to control R1 lug 3. The ohmmeter should indicate between 700 and 1200 ohms.
- ( ) Touch the positive ohmmeter lead to control R1 lug 2. The ohmmeter will vary from zero ohms to between 700 and 1200 ohms as you rotate the control.
- ( ) Disconnect the ohmmeter leads from the chassis.

Refer to Pictorial 3-2 for the following steps.

NOTE: You may wish to read the "Installation and Operation" section and determine whether or not you will need to install a battery before you perform the next two steps.

- ( ) Position the battery snap wires out of the way so they will not interfere with the cover when you perform the next step. If you do not wish to install a battery, neatly fold the wires and place the battery snap connector inside the battery clamp.
- ( ) Use four #6  $\times$  3/8" sheet metal screws to mount the cover onto the chassis.

This completes the "Initial Tests." Proceed to "Installation and Operation."

## INSTALLATION AND OPERATION

### INSTALLATION

Refer to Pictorial 4-1 as you read the following information.

The Active Antenna may be powered either from an external power source or a battery. We recommend, however, that you use an external power source, one that is capable of supplying 6 to 14-volts DC at 45 milliamperes. (The jack requires a 2.5 millimeter subminiature plug with the tip positive.) The Heathkit Model PS-2350 Power Cube is ideal for this purpose. Connect the power source to jack J1 on the rear of the chassis. NOTE: When you use this jack, it automatically disconnects the internal battery (if one is present).

If you decide to use a battery, use an alkaline 9-volt transistor battery (NEDA #1604). Some representative manufacturers and their type numbers are listed below:

Eveready #522  
Mallory #M1604A  
Duracell #MN1604

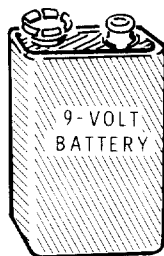

To install a battery, remove the sleeving from the battery snap contacts, push the battery snap onto the battery, and then push the battery into the battery clamp to hold it in place. See Detail 4-1A.

Use a suitable length of coaxial cable to connect the Receiver jack on the rear of the chassis to the antenna input of your receiver. CAUTION: If you use your Active Antenna with a transceiver, **do not** transmit while it is connected. To do so will damage the Active Antenna or transceiver.

If you wish to use an external antenna, connect it to the Antenna jack on the rear of the chassis.

### OPERATION

Refer to Pictorial 4-2 for the following steps.

You can leave the Active Antenna connected to your receiver at all times. When the slide switch is in the OFF position, the antenna signal is connected directly to the Receiver jack.

To use your Active Antenna, perform the following steps:

1. Push the OFF/ON switch to ON. The LED will light to indicate that power is being applied to the circuitry.
2. Set the GAIN control to 2.
3. Set the BAND switch to the desired frequency range as follows:
  - A 3—.6 MHz (300—600 kHz)
  - B .7—1.5 MHz (700—1500 kHz)
  - C 1.6—4 MHz
  - D 4—12 MHz
  - E 12.5—30 MHz
4. Set the TUNING dial to the desired frequency. Note that the five scales on the dial match the positions of the BAND switch.
5. Tune your receiver to the desired frequency.
6. Extend the collapsible antenna (if you are not using an external antenna). IMPORTANT: Do not extend the collapsible antenna if you use an external antenna.
7. Adjust the TUNING dial on the Active Antenna for maximum signal strength (as determined by the receiver's meter or your ears).

## NOTES:

- A. Always preset the Active Antenna TUNING dial to the desired frequency before you adjust it for maximum signal strength. If you do not do this, you could inadvertently tune the Active Antenna to a receiver image or a strong, unrelated signal that is overloading your receiver.
- B. The Active Antenna may pick up noise that is generated by fluorescent lights, electric motors, microwave ovens, television sets, computers, and other electronic devices. You may find it necessary to turn those devices off while you use your Active Antenna.
8. Increase the GAIN control to the desired level. You will obtain best results with this control set at some point less than fully clockwise. Too much gain could cause strong signals to overload your receiver.

NOTE: Oscillations can occur on some frequencies when you use the Active Antenna with portable receivers and set the GAIN control too high. This is especially a problem with receivers that have plastic cabinets. You can recognize this type of oscillation by one or more of the following symptoms:

- A. Unmodulated carriers as you tune the TUNING control through the frequency range.
- B. Stations appear and disappear as you tune the TUNING control.
- C. You may hear stations other than your desired station.

This completes the "Installation and Operation" of your Active Antenna.

## IN CASE OF DIFFICULTY

Begin your search for any trouble that occurs after assembly by carefully following the steps listed below in the "Visual Checks." After you complete the "Visual Checks," refer to the "Troubleshooting Charts."

NOTE: Refer to the "Circuit Board X-Ray View" (Page 26) for the physical location of parts on the circuit board.

### VISUAL CHECKS

1. Recheck the wiring. Trace each lead with a colored pencil on the Pictorial as you check it. It is frequently helpful to have a friend check your work. Someone who is not familiar with the unit may notice something that you have consistently overlooked.
2. About 90% of the kits that are returned to the Heath Company for repair do not function properly due to poor connections and soldering. Therefore, you can eliminate many troubles by making sure all connections are sol-

dered as described in Detail 1-1A. Be sure there are no solder "bridges" between circuit board foils.

3. Check to be sure all transistors are in their proper locations. Make sure each lead is connected to the proper point.
4. Check the values of the parts. Be sure in each step that you wired the correct part into the circuit, as shown in the Pictorial. It would be easy, for example, to install a 680  $\Omega$  (blue-gray-brown) resistor where a 68  $\Omega$  (blue-gray-black) resistor should be installed.
5. Check for bits of solder, wire ends, or other foreign matter which may be lodged in the wiring.
6. A review of the "Circuit Description" may also help you determine where the trouble is.

NOTE: In an extreme case where you are unable to resolve a difficulty, refer to the "Customer Service" information inside the rear cover of this Manual. Your Warranty is located inside the front cover.

## Troubleshooting Chart

The following chart lists problems and possible causes of some troubles you might encounter. If a particular part is mentioned (Q3 for example) as a possible cause, check that part and any other components connected to it to see that they are installed

and/or wired correctly. Also check for solder bridges and poor connections in the surrounding area. It is also possible, on rare occasions, for a part to be faulty and require replacement.

CONDITION	POSSIBLE CAUSE
Unit does not function; LED does not light.	<ol style="list-style-type: none"> <li>1. Dead battery.</li> <li>2. Jack J1 or wiring.</li> <li>3. Switch SW1 or wiring.</li> <li>4. Solder bridge on circuit board.</li> </ol>
Unit does not function; LED does light.	<ol style="list-style-type: none"> <li>1. Wiring error.</li> <li>2. Connection to your receiver.</li> </ol>
Unit does not tune on some frequencies.	<ol style="list-style-type: none"> <li>1. Coils L101—L106.</li> <li>2. Capacitor C1 or wiring.</li> <li>3. Switch SW2 wiring.</li> </ol>
Unit does not tune on any frequency.	<ol style="list-style-type: none"> <li>1. Coils L101—L106.</li> <li>2. Capacitor C1 or wiring.</li> <li>3. Wiring error.</li> <li>4. Connection to your receiver.</li> </ol>

## SPECIFICATIONS

Frequency Range .....	300 kHz to 30 MHz.
Antenna Provision .....	Collapsible (supplied), or external 50 ohm.
Power Requirements .....	9-volt alkaline battery (NEDA #1604) or external 6 to 14-volt DC (45 mA) source. Model PS-2350 power cube recommended.
Dimensions (overall) .....	2-1/4" H × 5-1/8" W × 5" D. (5.7 × 13 × 12.7 cm)
Weight .....	1.4 lb. (0.6 g).

---

The Heath Company reserves the right to discontinue products and to change specifications at any time without incurring any obligation to incorporate new features in products previously sold.

## CIRCUIT DESCRIPTION

Refer to the Schematic Diagram while you read the following description. The component numbers are arranged in the following groups to help you locate specific parts on the Schematic, circuit board, and chassis:

1—99 Parts mounted on the chassis.

101—199 Parts mounted on the circuit board.

Signals coming from the collapsible antenna or an external antenna via Antenna jack J3 pass through a preselector and a preamplifier (Q101 through Q103) before they are applied to a receiver.

When power is applied to the Active Antenna, signals are applied to a tuned-input filter formed by variable capacitor C1 and coils L101 through L106. Band switch SW2 allows you to select the coil or coils necessary to place the desired frequency within the tuning range of C1.

Transistors Q101 and Q102 each operate in a source-follower configuration to provide amplification for the filtered signal. Transistor Q103 is a high-level amplifier which further amplifies the signal so it can drive the output through Receiver jack J2 into a 50-ohm load at the receiver.

Jack J1 allows you to connect an external power supply, such as the Heathkit Model PS-2350 Power Cube. When you connect a power source to this socket, the internal battery is automatically disconnected from the circuit.

OFF/ON switch SW1 turns the Active Antenna off and on. When this switch is in the Off position, signals coming from the antenna are automatically bypassed around the preselector and preamplifier circuits to Receiver jack J2.

## SEMICONDUCTOR IDENTIFICATION

### DIODE

<u>COMPONENT NUMBER</u>	<u>HEATH PART NUMBER</u>	<u>MAY BE REPLACED WITH</u>	<u>KEY NUMBER</u>
D1	412-633	LED	A1

### TRANSISTORS

<u>COMPONENT NUMBER</u>	<u>HEATH PART NUMBER</u>	<u>MAY BE REPLACED WITH</u>	<u>KEY NUMBER</u>
Q101	417-931	PN4858	B1
Q102	417-931	PN4858	B1
Q103	417-290	MRF502	B2

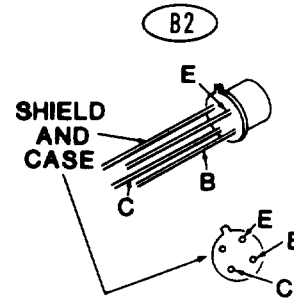
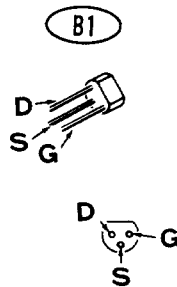
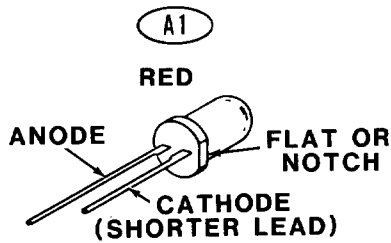

## CIRCUIT BOARD X-RAY VIEW

NOTE: To find the PART NUMBER of a component for the purpose of ordering a part:

- A. Find the circuit component number (R105, C103, etc.) on the X-Ray View.
- B. Locate this same number in the "Circuit Component Number" column of the "Parts List."
- C. Adjacent to the circuit component number, you will find the PART NUMBER and DESCRIPTION which must be supplied when you order a replacement part.

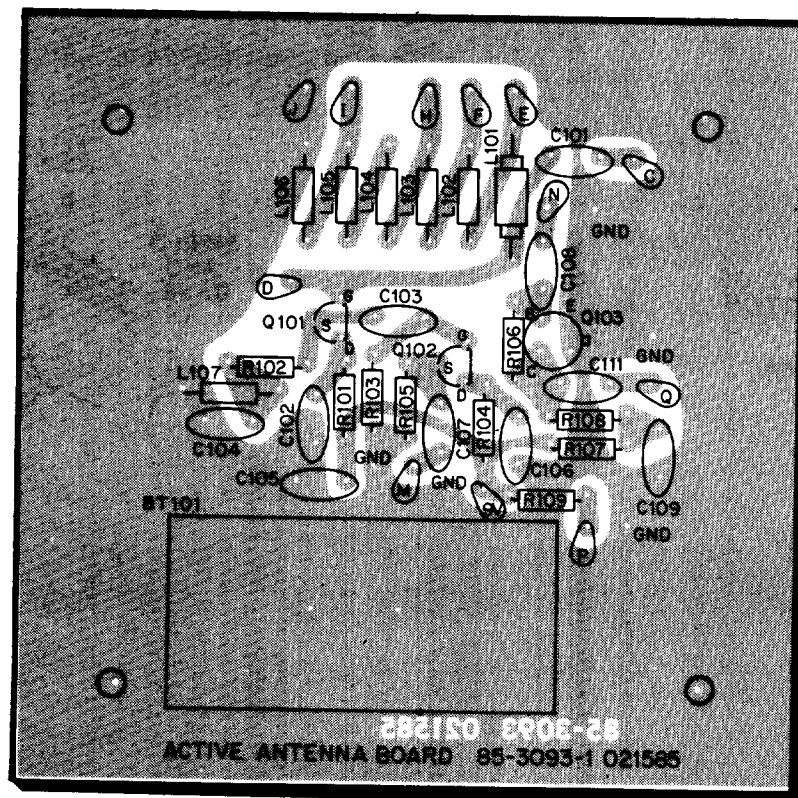

(Shown from the component side.)

# ILLUSTRATION BOOKLET

Part of 595-3469-02

## Parts Pictorial

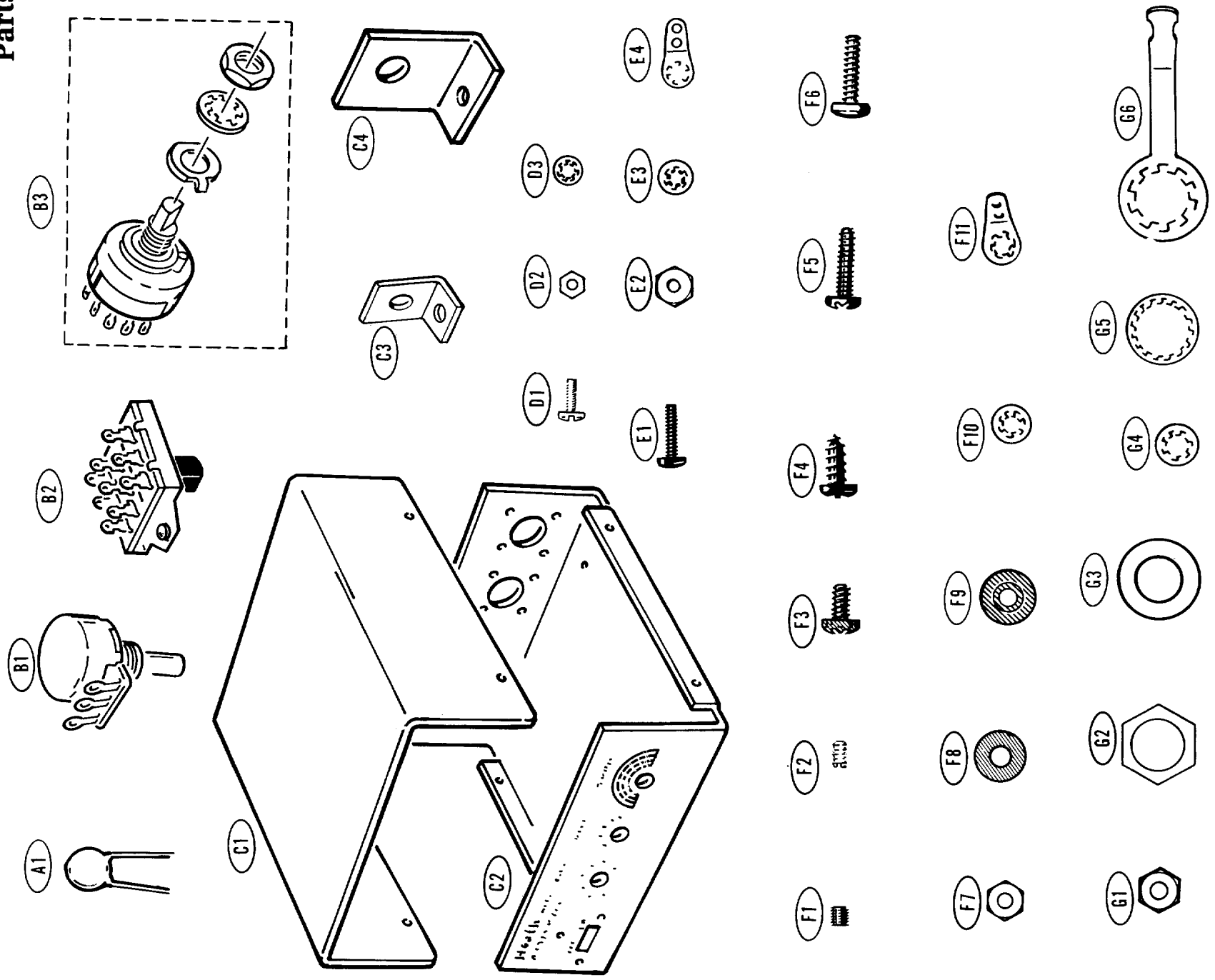
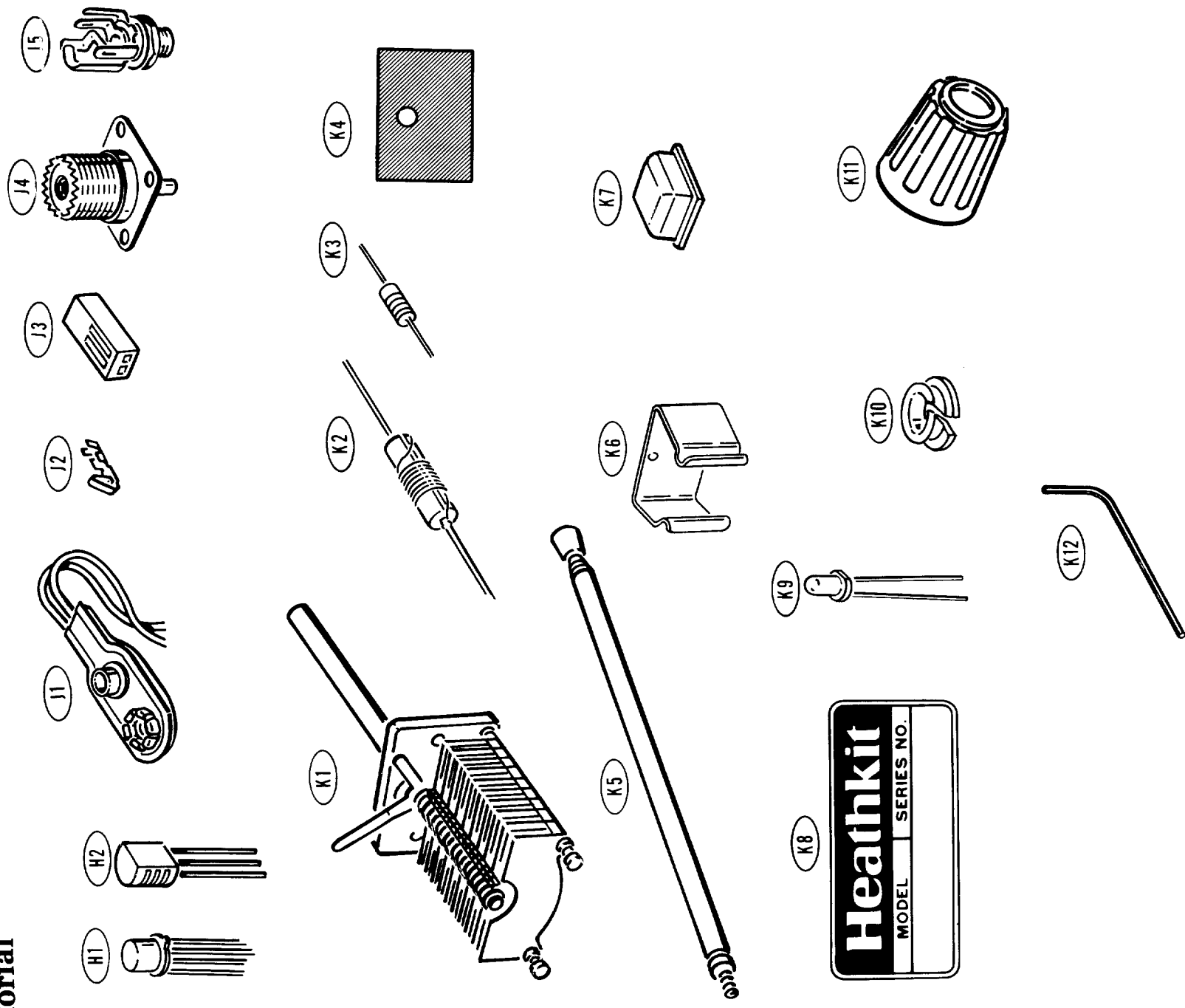

### A GOOD SOLDER CONNECTION

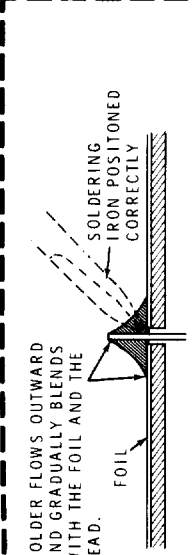

SOLDER FLOWS OUTWARD AND GRADUALLY BLENDS WITH THE FOIL AND THE LEAD.

FOIL

SOLDERING IRON POSITIONED CORRECTLY

When you heat the lead and the circuit board foil at the same time, the solder will flow evenly onto the lead and the foil. The solder will make a good electrical connection between the lead and the foil.

---

### POOR SOLDER CONNECTIONS

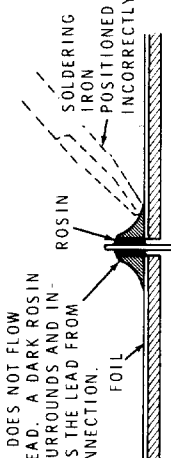

SOLDER DOES NOT FLOW ONTO LEAD. A DARK ROSIN BEAD SURROUNDS AND INSULATES THE LEAD FROM THE CONNECTION.

ROSIN

FOIL

SOLDERING IRON POSITIONED INCORRECTLY

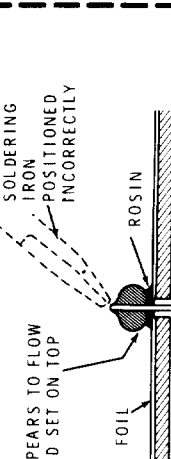

SOLDERING IRON POSITIONED INCORRECTLY

ROSIN

FOIL

SOLDER APPEARS TO FLOW INWARD AND SET ON TOP OF FOIL

When the lead is not heated sufficiently, the solder will not flow onto the lead as shown above. To correct, reheat the connection and, if necessary, apply a small amount of additional solder to obtain a good connection.

When the foil is not heated sufficiently the solder will blob on the circuit board as shown above. To correct, reheat the connection and, if necessary, apply a small amount of additional solder to obtain a good connection.

---

### SOLDER BRIDGES

A solder bridge between two adjacent foils is shown in photograph A. Photograph B shows how the connection should appear. A solder bridge may occur if you accidentally touch an adjacent previously soldered connection, if you use too much solder, or if you "drag" the soldering iron across other foils as you remove it from the connection. A good rule to follow is: always take a good look at the foil area around each lead before you solder it. Then, when you solder the connection, make sure the solder remains in this area and does not bridge to another foil. This is especially important when the foils are small and close together. NOTE: It is alright for solder to bridge two connections on the same foil.



A

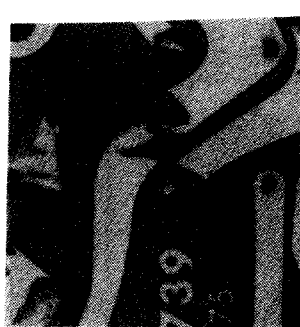

B

### SOLDER BRIDGE

Use only enough solder to make a good connection, and lift the soldering iron straight up from the circuit board. If a solder bridge should develop, turn the circuit board foil-side-down and heat the solder between connections. The excess solder will run onto the tip of the soldering iron, and this will remove the solder bridge. NOTE: The foil side of most circuit boards has a coating on it called "solder resist." This is a protective insulation to help prevent solder bridges.

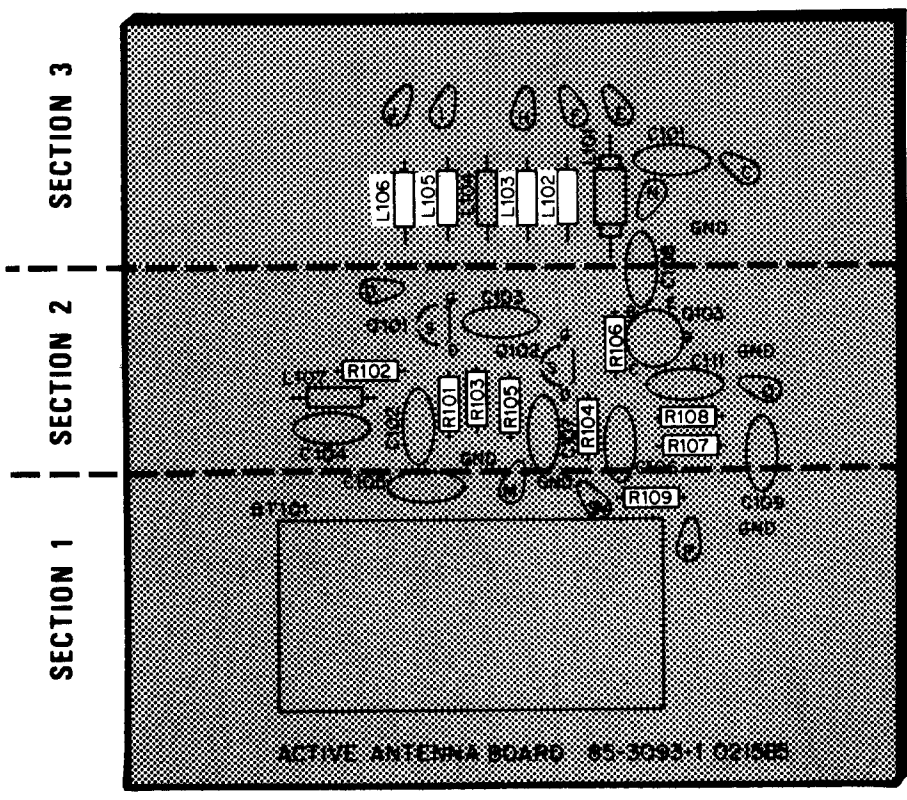

PICTORIAL 1-1

Detail 1-1A

PICTORIAL 1-2

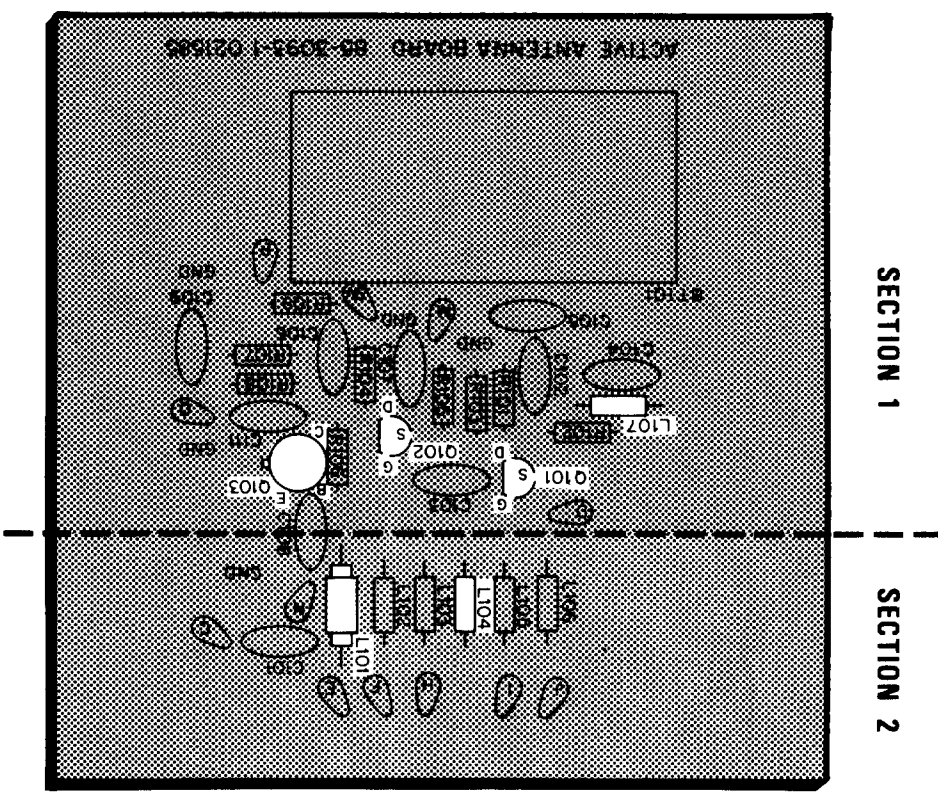

PICTORIAL 1-3

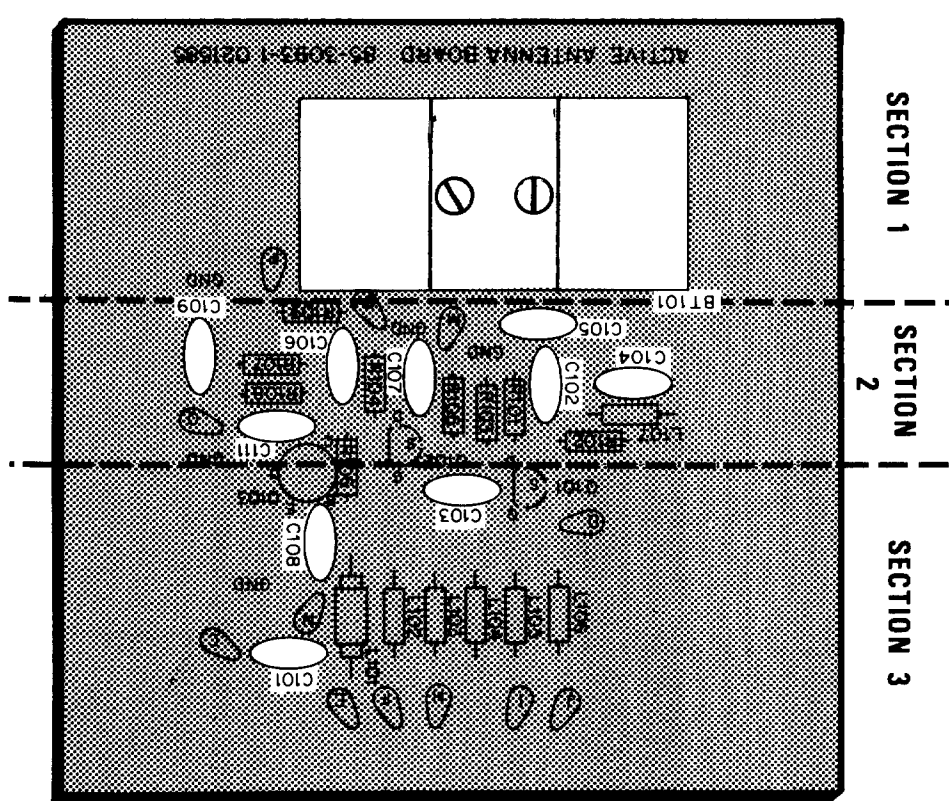



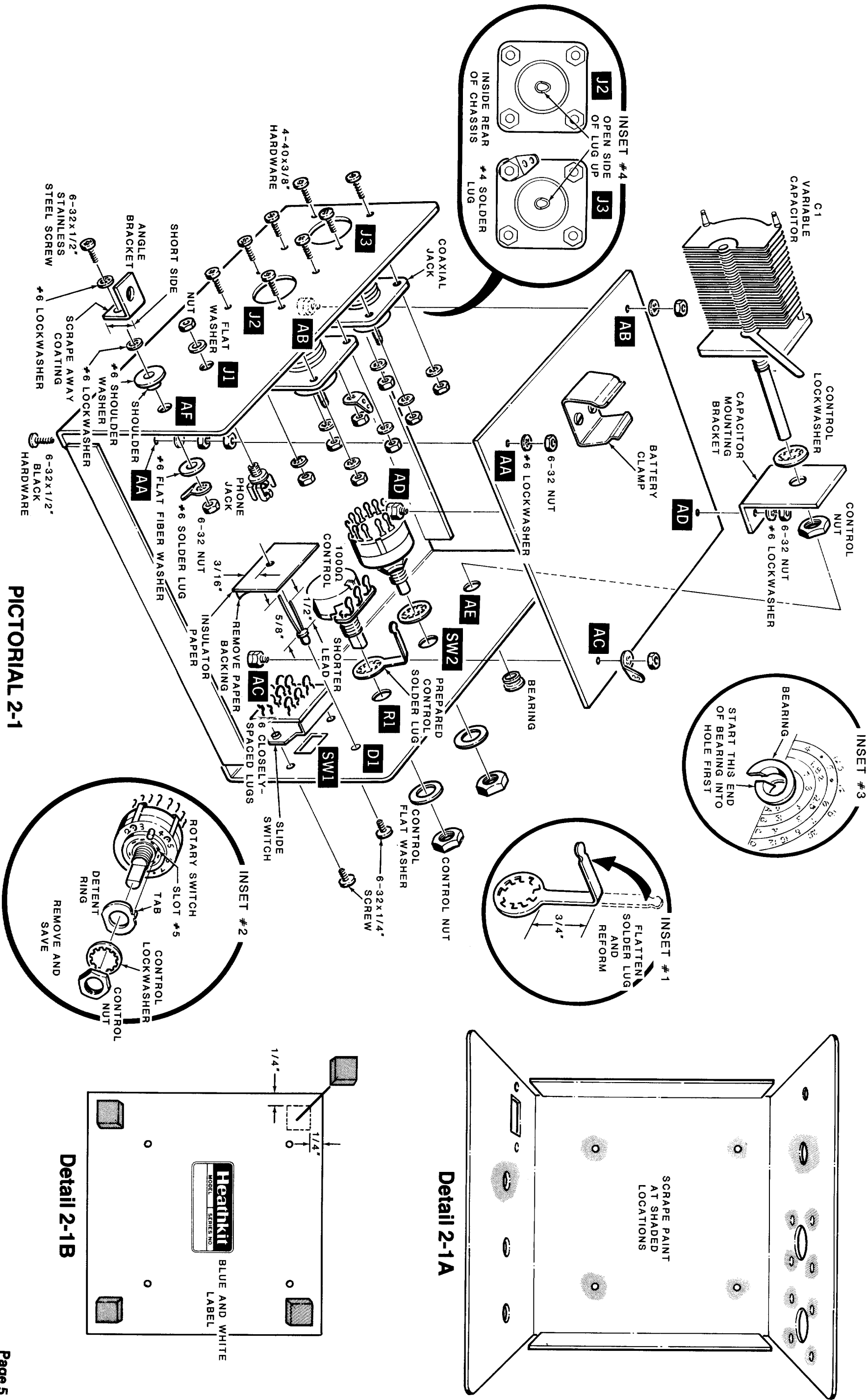

PICTORIAL 2-1

Detail 2-1A

Detail 2-1B



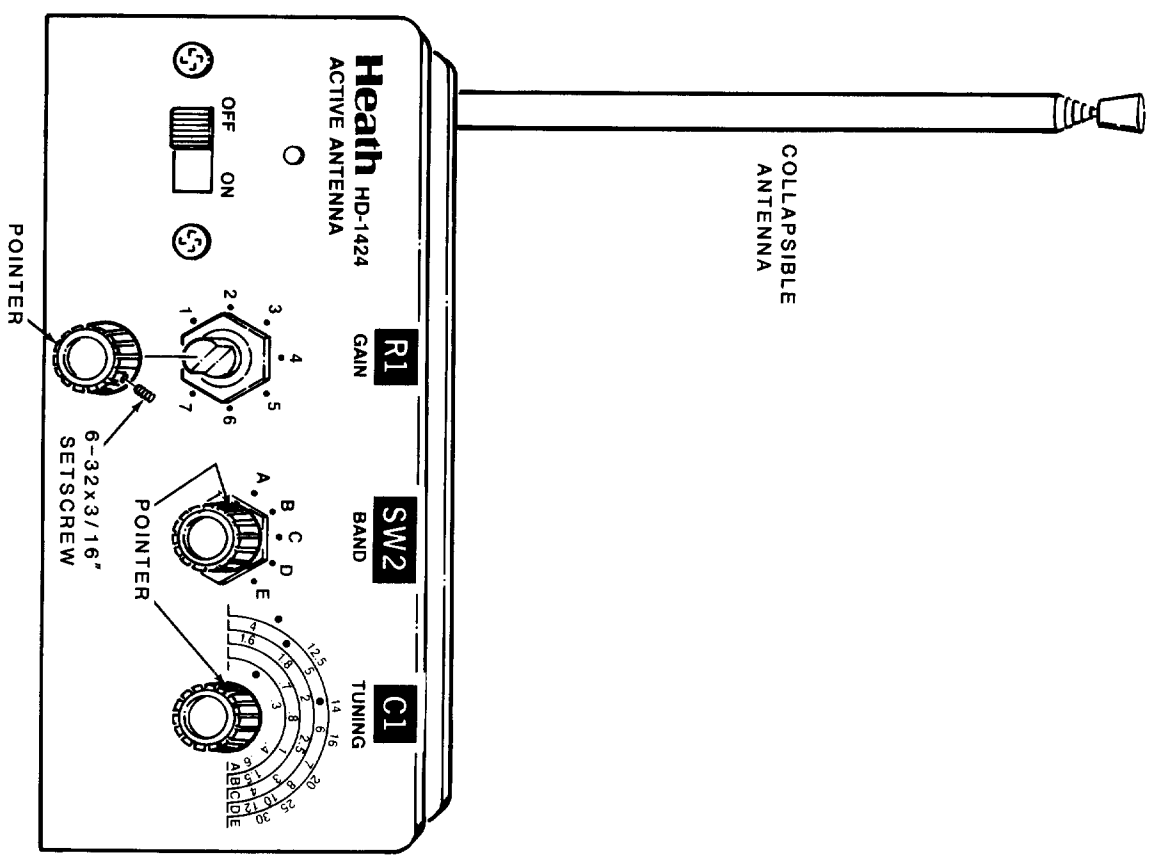

PICTORIAL 2-3

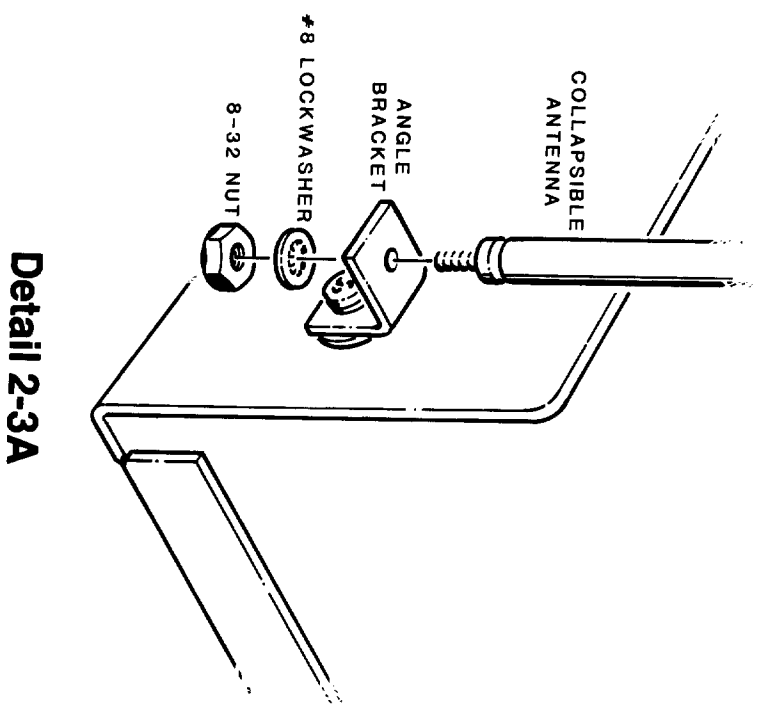



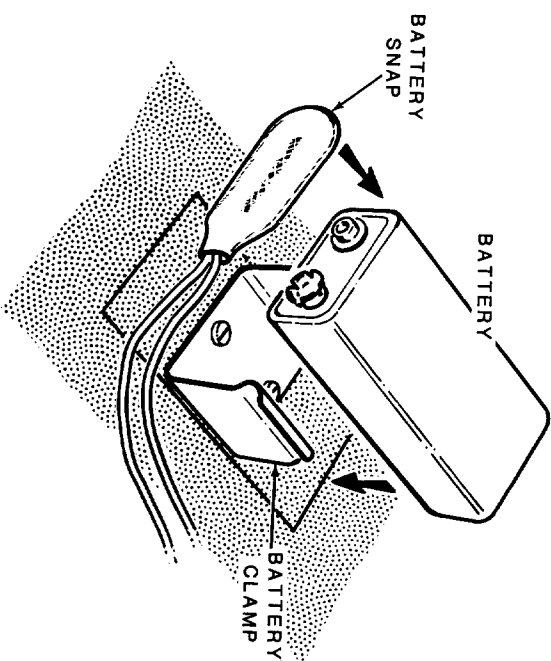

Detail 4-1A

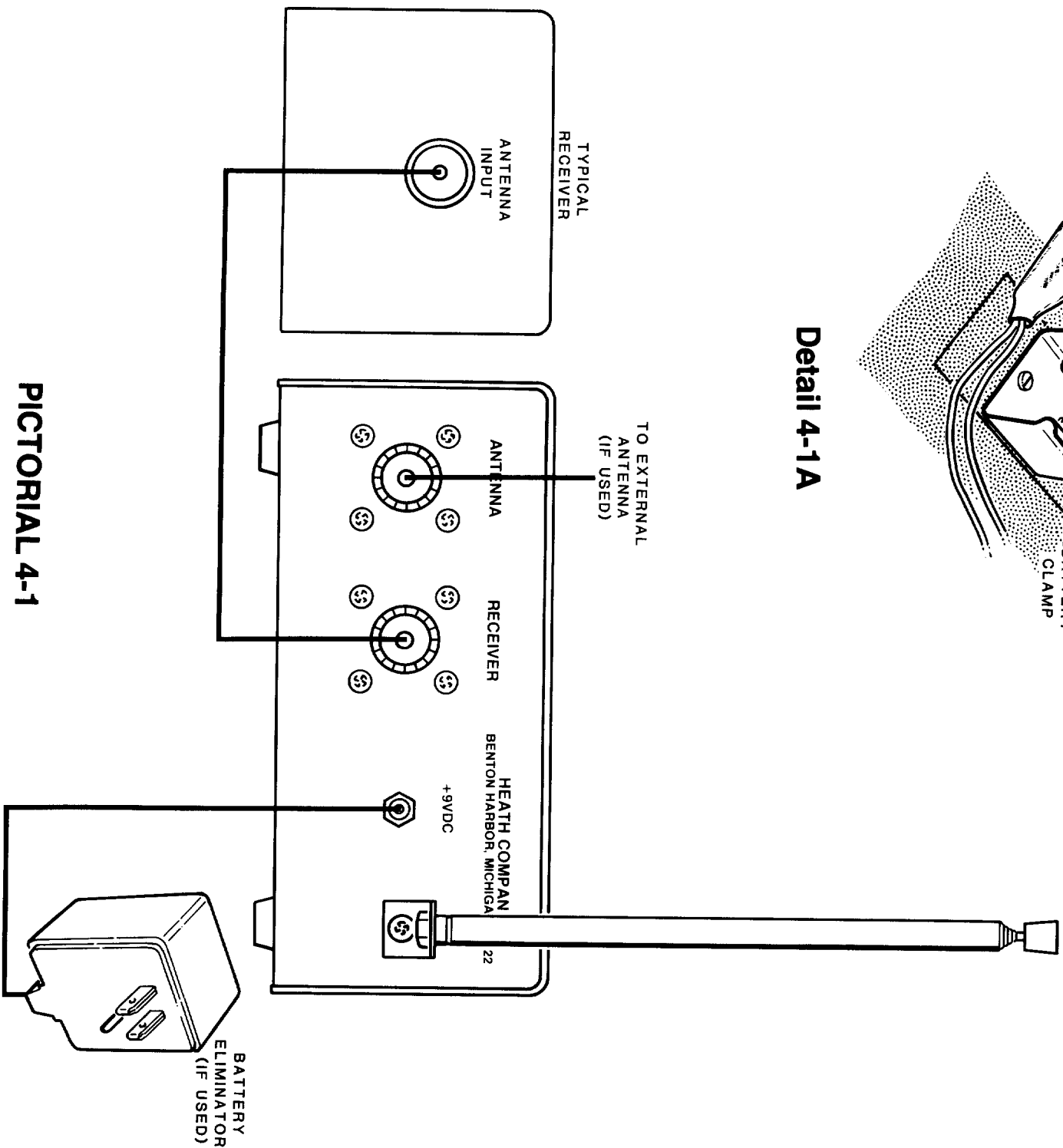

PICTORIAL 4-1

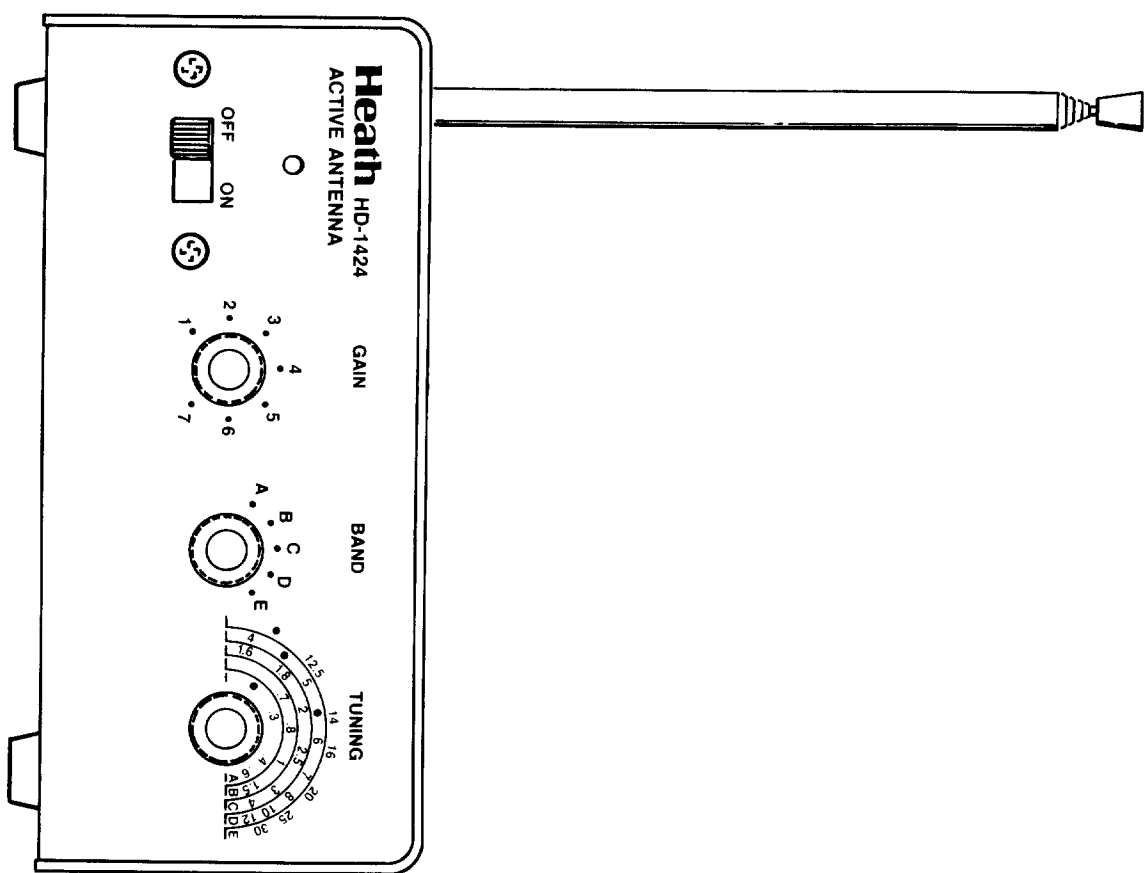



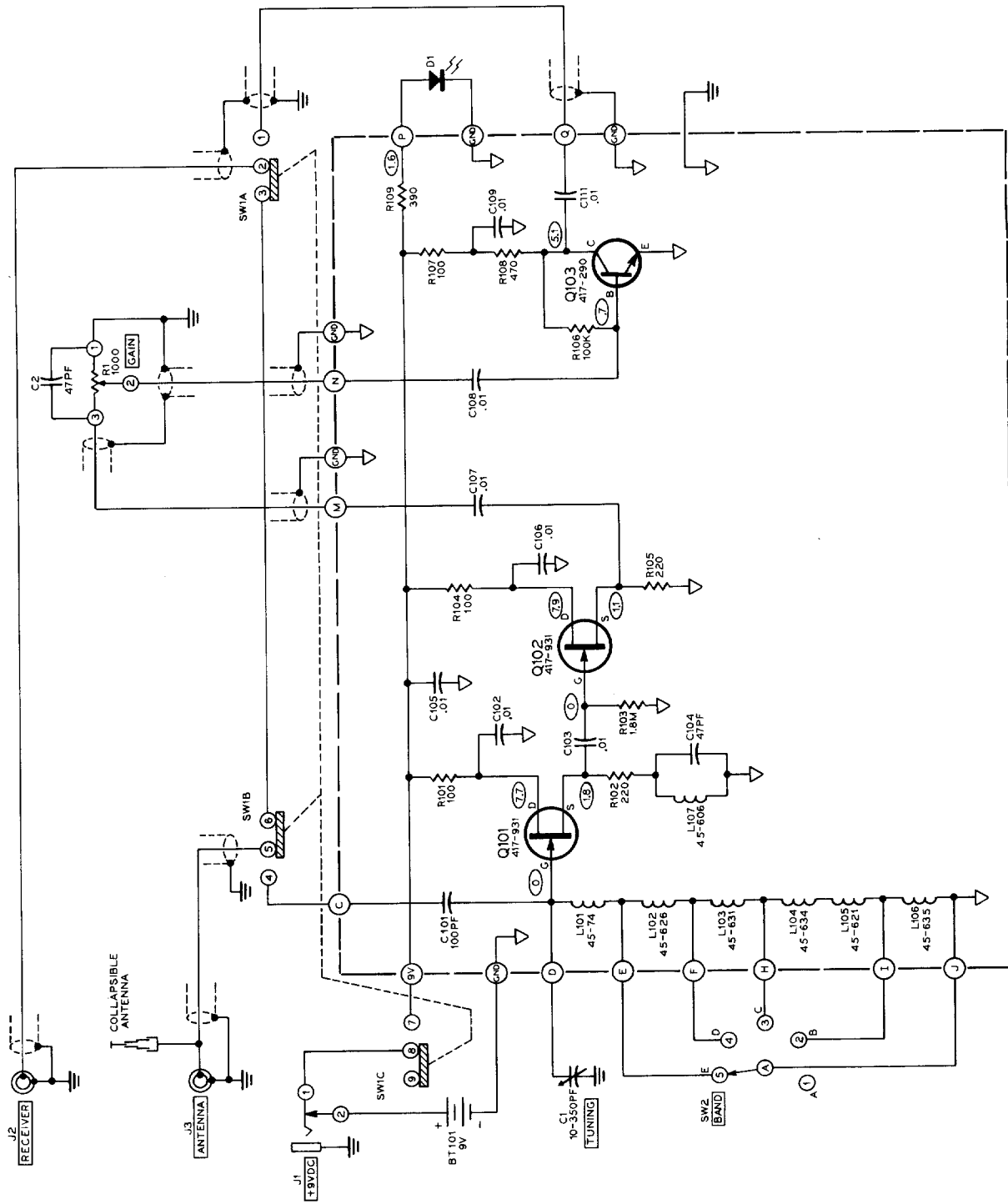

PICTORIAL 4-2

### SCHEMATIC OF THE HEATHKIT® MODEL HD-1424 ACTIVE ANTENNA



**NOTES:**

1. All resistors are rated at 1/4-watt and have a 5% tolerance unless otherwise noted. Resistor values are in ohms (k = 1,000; M = 1,000,000).
2. Capacitor values are in  $\mu$ F (MICROFARADS) unless otherwise noted (pF = PICOFARADS).
3.  This symbol indicates a connection to the circuit board.
4.  This symbol indicates chassis ground.
5.  This symbol indicates circuit board ground.
6.  This symbol indicates a DC voltage taken with a high-input impedance voltmeter from the point indicated to chassis ground (voltages are  $\pm 20\%$ ).
7. Refer to the "X-Ray View" for the physical locations of parts on the circuit board.
8. Switch SW1 is shown in the OFF position.