

6/12/75

TF 30 SIN 6560719
PS29 SIN 2555516
TEL # 605-339-0100

PS29 MINUTE MAN TRIGGERED SWEEP OSCILLOSCOPE



INSTRUCTION MANUAL

SENCORE

"the all american line"

SENCORE SAFETY REMINDERS

When testing electronic equipment, there is always a danger present. Unexpected high voltages can be present at unusual locations in defective equipment. The technician should become familiar with the device he is working on and observe the following precautions.

1. An isolation transformer should always be used on equipment having the chassis tied to one side of the AC power line. The case of the PS29 is connected to the earth ground side of the AC line through the third wire of the line cord. If the chassis of the equipment being serviced is connected to the other side of the AC line, a severe shock hazard will be present. In addition, as soon as the PS29 ground lead is connected to the chassis the resultant short circuit will fuse the ground clip of the scope to the chassis of the equipment being serviced, and blow the fuse to your service bench.
2. When making test lead connections to high voltage points, remove the power. If this cannot be done, be sure to avoid contact with other equipment or metal objects. Place one hand in your pocket as a safety precaution and stand on an insulated floor to reduce the possibility of shock.
3. Discharge filter capacitors before connecting test leads to them. Capacitors can store a charge that could be dangerous to the technician.
4. Be sure your equipment is in good order. Broken or frayed test leads can be extremely dangerous and can expose the technician to dangerous potentials.
5. Remove the test leads immediately after the test has been completed to reduce the possibility of shock.
6. Do not work alone when working on hazardous circuits. Always have another person close by in case of accident. Remember, even a minor shock can be the cause of a more serious accident, such as falling against the equipment, or coming in contact with higher voltages.

TABLE OF CONTENTS

SENCORE SAFETY REMINDERS	Page 1
DESCRIPTION	Page 5
INTRODUCTION	
FEATURES	
SPECIFICATIONS	Page 5
VERTICAL	
HORIZONTAL	
GENERAL	
CONTROLS	Page 6
INTENSITY - PULL ON	
VERTICAL POSITION	
FOCUS	
HORIZONTAL POSITION	
GAIN	
INPUT AMPLIFIERS	Page 7
TV VERTICAL	
TV HORIZONTAL	
3.58MHz VARISPEED	
SWEEP GENERATOR 60Hz	
VECTOR B-Y	
5X EXPAND	
VARISPEED	
INPUT COUPLING	Page 8
DC BALANCE	
SYNC	
Z AXIS INPUT	
SWEEP OUTPUT	
OPERATING INSTRUCTIONS	Page 8
SET UP	
TV VERTICAL AND TV HORIZONTAL	
SWEEP GENERATOR 60Hz	Page 9
VECTOR B-Y	
PROBE COMPENSATION	
EXT. HORIZONTAL, VECTOR AND 60Hz	Page 9
APPLICATIONS	Page 10
AC VOLTAGE MEASUREMENTS	
DC VOLTAGE MEASUREMENTS	
Measuring the DC Level of an AC Signal	
Time and Frequency Measurements	
Time Measurements using the Calibrated Time Base	
Frequency Measurements using Calibrated Time Base	
Frequency Measurements using Lissajous Figures	
Frequency Measurements using the Modulated Ring	
PHASE SHIFT BETWEEN SIGNALS	Page 11
VECTOR SERVICING	Page 11
Troubleshooting with the Vector Pattern	

SQUARE WAVE TESTING WITH THE PS29	Page 14
RISE TIME MEASUREMENTS	Page 14
COIL AND TRANSFORMER TEST	Page 15
USING THE PS29 WITH A SWEEP GENERATOR	Page 16
DETECTOR PROBE	Page 16
CIRCUIT DESCRIPTION	Page 17
HV POWER SUPPLY AND CRT BLANKING	
LOW VOLTAGE POWER SUPPLY	Page 18
VERTICAL AMPLIFIER	
TIME BASE - SYNC AND TRIGGER	Page 19
SWEEP GENERATOR	
AUTO BASELINE	Page 20
CALIBRATION	Page 20
POWER SUPPLIES	
Low Voltage	
High Voltage	
Astigmatism	
VERTICAL AMPLIFIER	Page 21
DC Balance	
Output Bias	
Vertical Calibration	
Attenuator Frequency Compensation	
10:1 Attenuator Compensation	Page 22
100:1 Attenuator Compensation	
1000:1 Attenuator Compensation	
TIME BASE	Page 22
SWEEP OUTPUT BIAS	
TRIGGER BALANCE	
STABILITY	Page 23
SWEEP SPEED AND SWEEP WIDTH	
5X EXPAND AND POSITION	
CRT TILT ADJUSTMENT	
CONVERSION TO 220VAC	
DISASSEMBLY INSTRUCTIONS	Page 24
CASE	
CRT	Page 24
SERVICE PROCEDURES	Page 24
TROUBLESHOOTING	Page 24
BOARD LAYOUTS	Page 27
SERVICE AND WARRANTY	Inside Back Cover

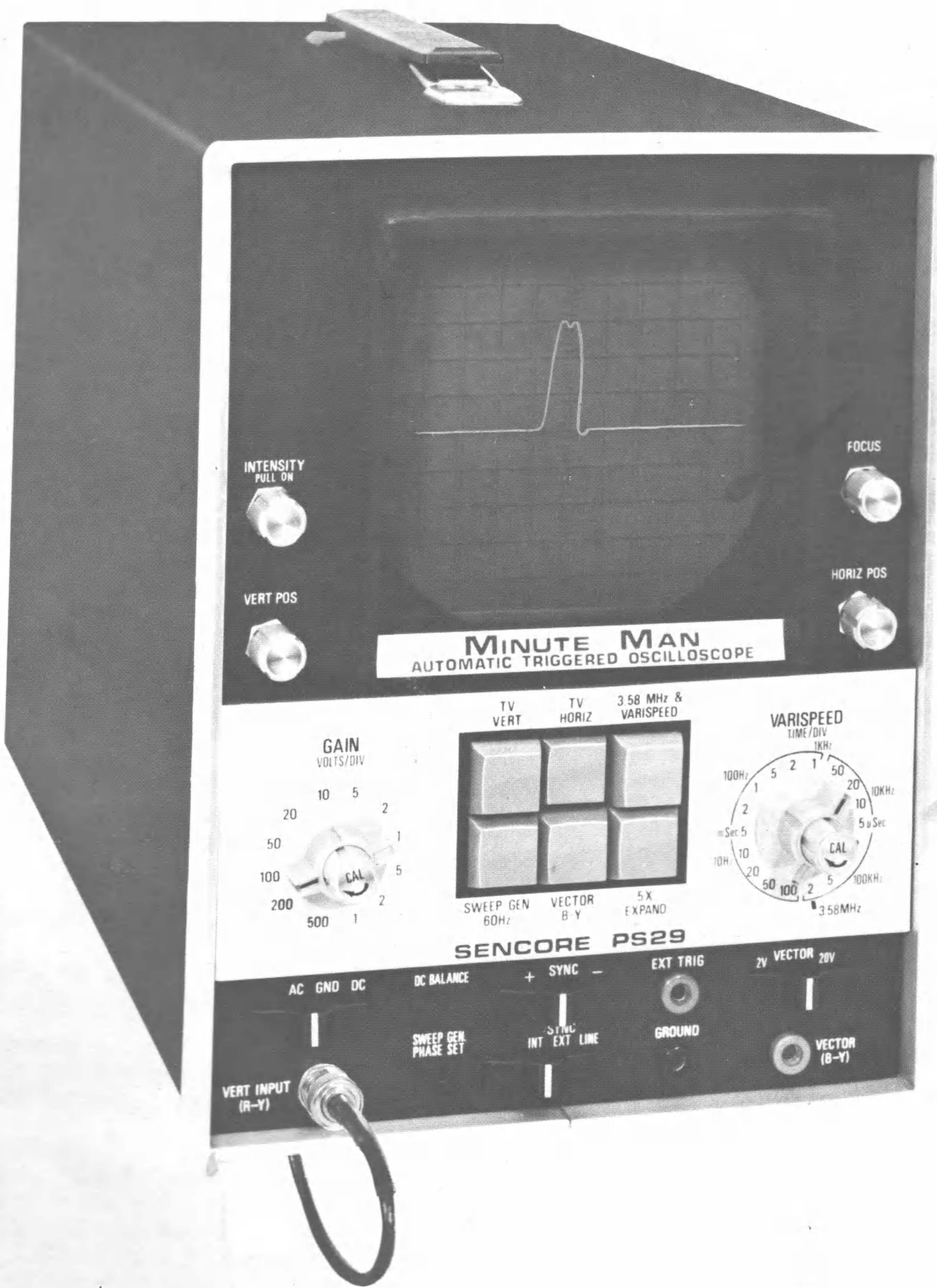

*PS29 Minute Man
Automatic Triggered
Pushbutton Oscilloscope*

DESCRIPTION

INTRODUCTION

The rapid changes which are taking place in electronics today are causing engineers, technicians and instructors to take a critical look at the equipment they will need to keep pace with these changes. The dramatic increase of solid state components being used has created different test equipment requirements than the tube circuits of the past. The increased use of integrated circuits and modular construction in the television receiver are other important facts to consider.

What do all these changes mean to the area of oscilloscopes? First, the lower potentials used in these circuits and the much lower signal levels call for an instrument with increased sensitivity if it is to be practical for the servicing of these new solid state sets. More emphasis is being placed on speed in critical waveform analysis. The technician must be able to obtain his critical waveforms quickly and they must be clear and jitter free. The instrument to fill these applications requires triggered operation and it must be simple to operate and provide full versatility and range capability.

The PS29 fulfills these requirements and more. Push-button ease of operation has been one of the important design considerations of the PS29. The simple push of a button will lock any color TV waveform on the screen with automatic triggering. The automatic triggering and built-in TV sync separators eliminate any need for stability or trigger level controls. The PS29 incorporates the latest in solid state design to assure long and trouble free service. A glance at other features of this practical instrument will point out its many uses and advantages.

FEATURES

*** EXTREMELY STABLE automatic triggered sweep with full bandwidth capability.

*** PUSHBUTTON SELECTION of TVV, TVH, variable speed, sweep generator 60Hz, vector, and 5X expand. Sync separator automatically added in TVV and TVH sweep positions for rock solid display of complex TV waveforms. 60Hz provided for line sweep and vector for external sweep signals.

*** CALIBRATED VARISPEED TIME BASE rates from .2 microsecond to .1 second per division in 18 positions.

*** VERTICAL INPUT SENSITIVITY of 10mV/cm direct. 100mV/cm with low capacity probe. Input

attenuator calibrated to read directly when using low capacity probe. Gain continuously variable between attenuator positions.

*** BANDWIDTH of DC to 8MHz -3DB, usable to 15MHz. Negligible overshoot, typically 1% or less.

*** FRONT PANEL correlation between sweep speed and frequency for ease of operation. Sweep speed continuously variable between steps.

*** HIGH INPUT IMPEDANCE of 10 megohm shunted by 11pf using low capacity probe. 1 megohm shunted by 40pf at input terminals.

*** FULLY PROTECTED Field Effect Transistor input. Maximum input voltage with Low Capacity Probe is 5000 volts peak-to-peak AC, or 1000 volts DC. This allows measurements of signals that can destroy other oscilloscopes.

*** ILLUMINATED full size 10x10cm grid PLUS illuminated vector grid. No separate grids to change or become misplaced.

*** RETRACTABLE TIP on special 5KV low capacity probe for ease of connection in hard to reach places.

*** SOLID STATE for dependable accuracy and reliability. 2KV regulated CRT supply with DC blanking for brightest, sharpest trace possible.

SPECIFICATIONS

VERTICAL

Sensitivity	.1V/div to 500V/div calibrated for direct reading of p-p volts with low capacity probe. Gain continuously variable between range positions.
Bandwidth	DC to 8MHz -3DB. Usable to 15 MHz (4 div deflection).
Overshoot	Negligible, 1% or less phase linear circuit design.
Calibration	Accuracy \pm 5%. Typically 2-3%.
Rise Time	45 nanoseconds
Input Voltage	5KV p-p AC or 1KV DC maximum through low cap probe. 1000V maximum direct input.

Input Impedance 10 megohm shunted by 11pf using Low Cap Probe. 1 megohm shunted by 40pf at input.

HORIZONTAL

Sweep Speed 0.2 microseconds/div to 0.1 sec/div in 18 calibrated ranges. Continuously variable between ranges.

TVV and TVH Both with built-in TV sync separator, and pushbutton selection.

Time Base Accuracy $\pm 5\%$. Typically 2-3%.

Sweep Expand 5X, 5% accuracy

Triggering Automatic triggering for signals above .5cm p-p as displayed. (400mV p-p minimum for external triggering 10V p-p maximum external).

Trigger Source Selection Internal, External, Line, positive or negative polarity.

External Trigger Input Impedance 500K paralleled by 40pf.

Vector/External Uncalibrated, approximately 2 or 20 volts per division. With 5X expand approximately .4 volts/div or 4 volts/div.

Bandwidth 1MHz 3DB

Input Impedance 1 megohm shunted by 40pf

GENERAL

Z Axis Input 5V p-p for visible modulation. 10K input impedance AC coupled.

Sweep Output 15V p-p sawtooth at Horizontal sweep rate, AC coupled.

CRT 5UP1 (F) flat face 5" round with P1 phosphor, shielded.

CRT Supply 2000V regulated

Retrace Suppression DC coupled unblanking pulse to grid of CRT

Graticule 10X10cm grid with 30° vector reference, edge light

Power 105-130VAC 50-60Hz 60 watts

Size 8"x10½"x16"

Weight 25 pounds

CONTROLS

INTENSITY — PULL ON

This control is to be pulled out to turn the PS29 on. Rotation of the control adjusts the brilliance of the trace. Trace brilliance may vary somewhat during operation of the PS29 when using the 5X expand at higher frequencies. If the PS29 is to be operated under a standby condition for any length of time. It is recommended that the intensity be reduced to prevent burning the face of the CRT.



VERTICAL POSITION

This control normally adjusts the vertical position of the trace for centering purposes.

FOCUS

This control adjusts the sharpness of the trace. Adjust for sharpest trace in the center of the screen.

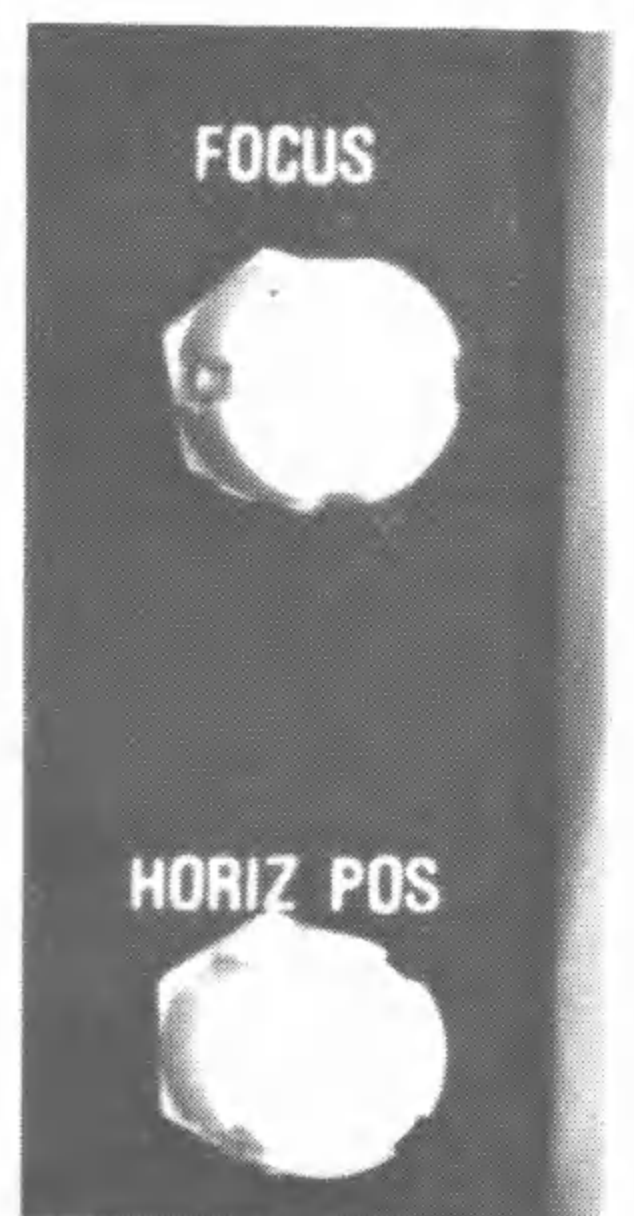

HORIZONTAL POSITION

This control adjusts the horizontal position of the trace in all functions, for centering any portion of the waveform.

GAIN

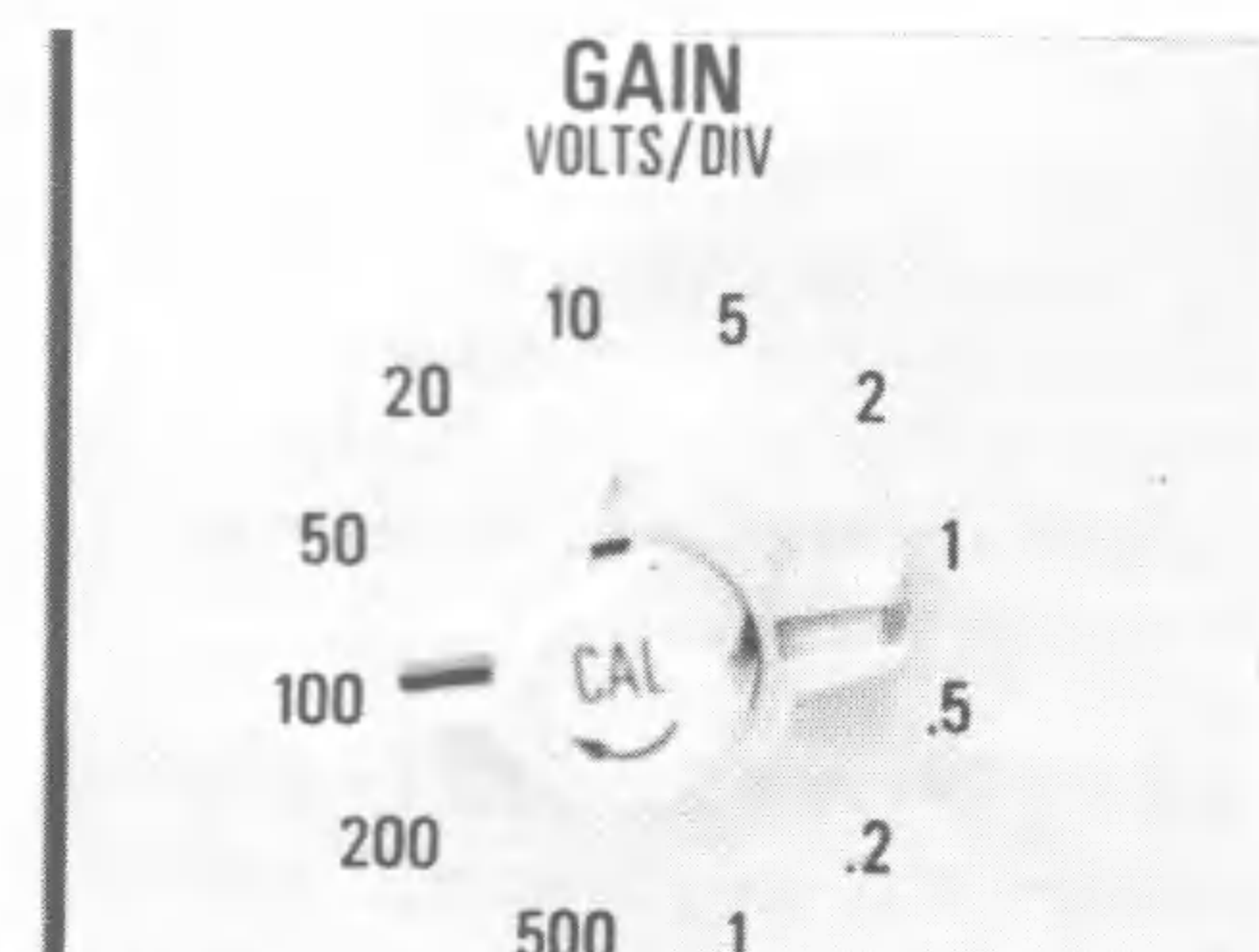

This switch adjusts the input sensitivity of the vertical amplifier, and is calibrated in volts per division. The center knob of this switch is a vernier control that

adjusts the sensitivity of the amplifier between switch positions. For normal operation with calibrated input this control should be turned fully clockwise until it snaps into the detent provided.

INPUT AMPLIFIERS

The input amplifiers are calibrated to read input voltage directly when using the Lo Cap Probe. No multiplication of readings is required when using the Lo Cap Probe. The maximum input voltage with this probe is 5000 volts peak-to-peak AC or 1000 volts DC. When a direct probe is used, all readings of the input voltage are multiplied by .1. The maximum input voltage direct is 1000 volts DC plus peak AC.

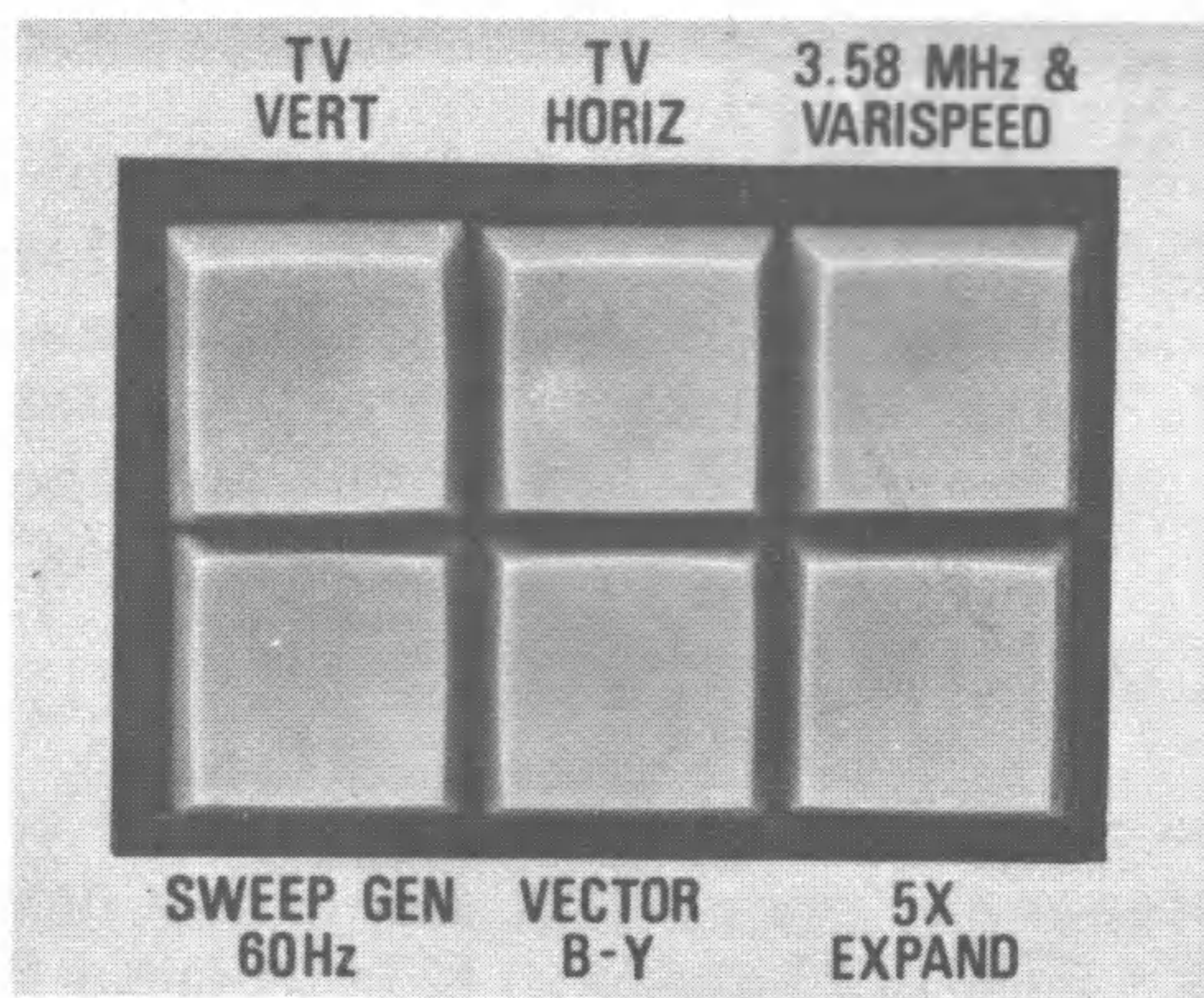

TV VERTICAL

This pushbutton automatically provides a pre-set horizontal sweep frequency to display two cycles of the TV vertical signal. This switch also connects the TV sync separator to trigger the trace automatically on the vertical sync signal.

TV HORIZONTAL

This pushbutton automatically provides a pre-set horizontal sweep frequency to display two cycles of the TV horizontal signal. This switch also connects the TV sync separator to trigger the trace automatically on the horizontal sync pulse.

3.58MHz VARISPEED

This pushbutton enables the VARISPEED control to display any horizontal frequency from 1Hz to 500KHz, depending on the VARISPEED control setting. 3.58MHz is displayed when the VARISPEED control is set to the .2microsecond/division position with this button pushed.

SWEEP GENERATOR 60Hz

This button connects the 60Hz line signal to the horizontal deflection amplifiers. The phase can be adjusted by the SWEEP GEN PHASE SET screwdriver adjustment on the lower portion of the panel.

VECTOR B-Y

This button connects the blue input jack to the horizontal deflection amplifier. Sensitivities of 2 volts/division and 20 volts/division are provided for this signal or, with the use of the 5X expand, sensitivities of .4 volts/division or 4 volts/division are obtained. The 30° vector grid is lit automatically when this function is used.

5X EXPAND

This pushbutton multiplies the gain of the horizontal amplifier by five for any of the above functions. The portion of the trace that normally occupies the center two horizontal divisions of the screen will be expanded to the full 10 horizontal divisions on the screen.

VARISPEED

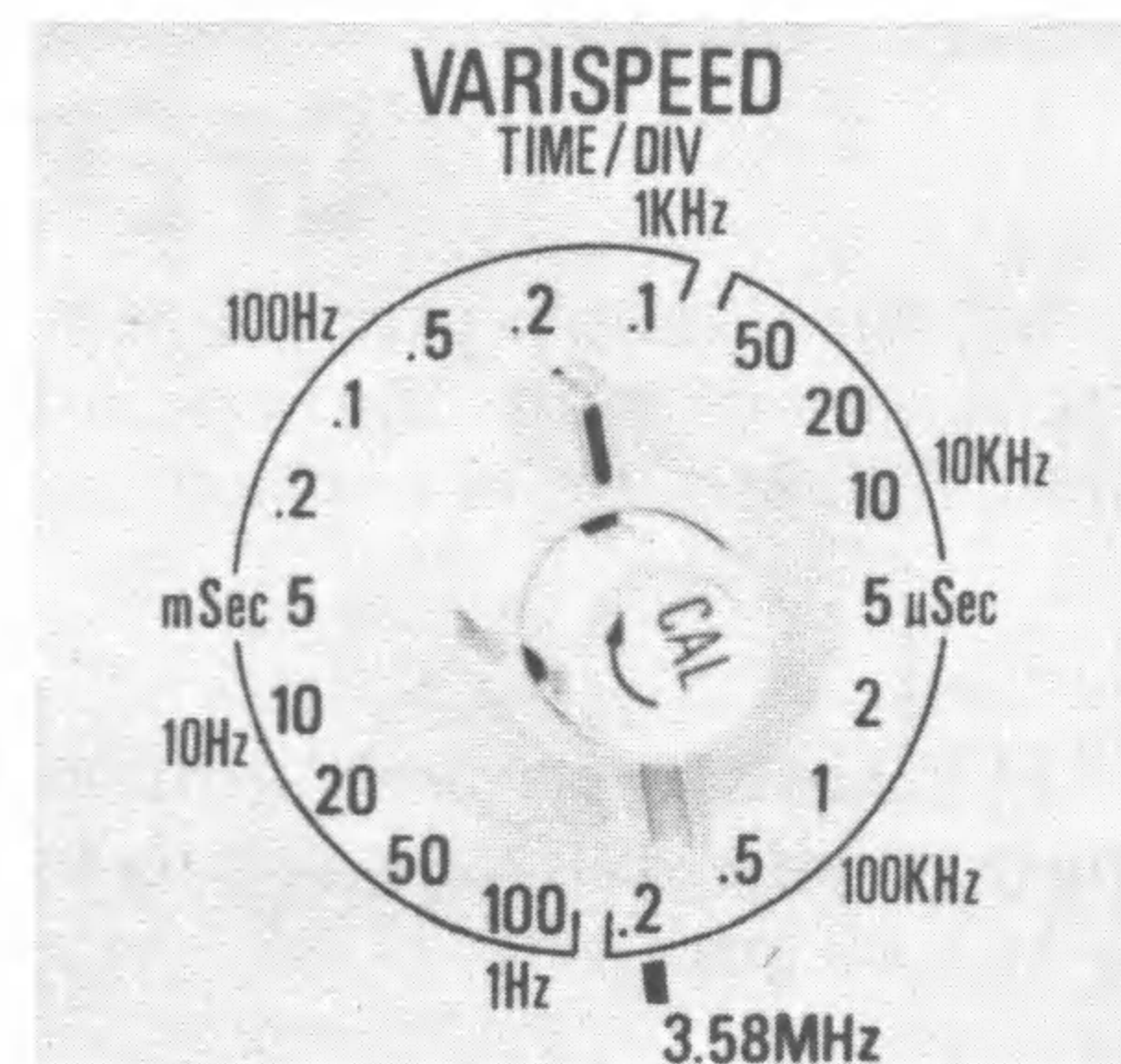

This control consists of two separate sections. The first is an outer switch showing sweep rate per division. This switch also shows the approximate sweep rate in cycles per second to aid the technician in determining the correlation between time base rates and frequency. The second section is the small knob in the center of the outer switch. This control operates as an uncalibrated fine frequency control in all sweep positions and with the 3.58MHz VARISPEED button depressed. For normal operation of the calibrated sweep speeds, this control should be turned to the clockwise end of its rotation until it snaps into the detent provided.

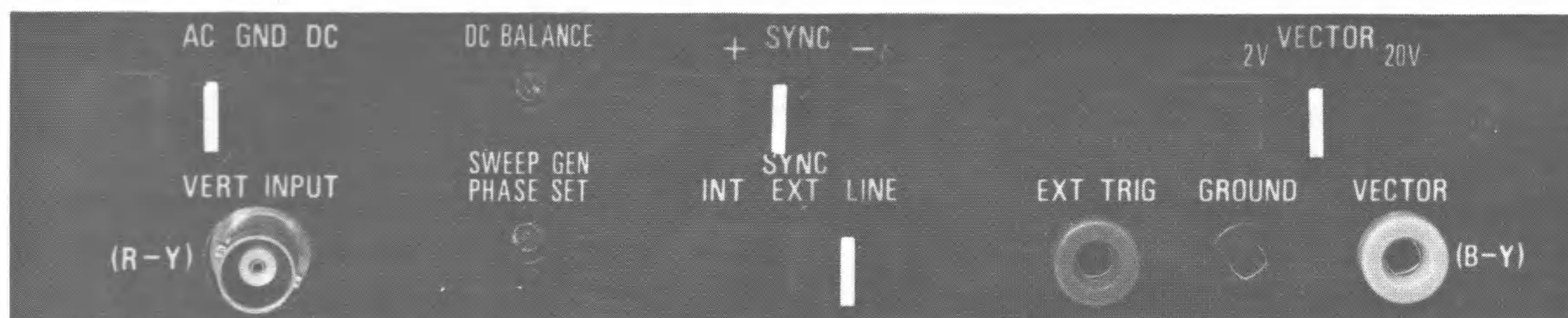

INPUT COUPLING SWITCH

This switch is used to select the method of coupling the input signal to the amplifier. Use the AC COUPLED position for normal peak-to-peak waveform measurements. Use the DC COUPLED position when you wish to measure DC voltage. Use the center ground position to establish a zero reference with the trace.

DC BALANCE

This control is used to maintain the DC balance of the amplifier. Its function is similar to the zero adjust control on a VTVM. Should this control require adjustment, follow the procedure outlined in the CALIBRATION section of this manual.

SYNC

The upper SYNC switch on the lower panel of the PS29 selects the polarity of the pulse used to trigger the horizontal signal. It can be set for either positive (+) or negative (-) sync pulses, depending on the polarity of the signal being observed.

The lower SYNC switch on the lower panel of the PS29 selects the source of the sync signal. On the INT position, the sync pulses of the signal being observed are separated by the sync separator and are used to trigger the trace. The EXT position is used when an external sync signal is injected into the EXT TRIG input jack. The trace is triggered by 60Hz line voltage when this switch is in the LINE position.

Z AXIS INPUT

The Z Axis input on the rear panel is used when you desire to intensity modulate the CRT beam. Connect the modulating signal of approximately 5 volts peak-to-peak between the Z Axis input and the ground input.

SWEEP OUTPUT

This jack, on the rear panel, supplies a 15 volt peak-to-peak sawtooth signal with frequency determined by the VARISPEED switch. It is isolated from the time base circuit for protection. Its uses include coil and flyback testing.

OPERATING INSTRUCTIONS

This section contains a simple procedure that you can use to get acquainted with the operation of the controls on the PS29 Minute Man Oscilloscope.

SET UP

1. Plug the PS29 into a properly grounded AC outlet and pull the intensity control knob to turn the unit on. Note the 10X10 grid is lit.
2. Use the LOW CAPACITY PROBE to connect a 60Hz signal into the VERT INPUT. Depress the VARISPEED pushbutton and adjust the VARISPEED control to 10m sec/division. Set the SYNC switches to + and INT positions. Adjust the GAIN control for the desired signal height. You should see six cycles across the screen.
3. Adjust the FOCUS and INTENSITY controls for a sharp trace with usable brightness. Adjust the HORIZ POS control so that the trace starts at the left edge of the 10X10 grid. Adjust the VERT POS control for proper centering of the trace.

4. Depress the 5X EXPAND pushbutton and note the expansion of the trace to display slightly more than one cycle across the screen.

5. Push the 5X EXPAND again to unlatch the switch and return the PS29 to its original operation. Rotate the inner knobs on the GAIN and VARISPEED controls to note the action of these adjustments. Return each of these to their fully clockwise detent positions.

TV VERTICAL AND TV HORIZONTAL

Connect a stable color bar generator such as the Sencore CG169 to the antenna terminals of a properly operating television receiver. Turn the pattern selector of the color bar generator to the crosshatch pattern and adjust the receiver's fine tuning, brightness and contrast controls to properly display the crosshatch pattern. Use the LO CAP

PROBE to connect the base or control grid of the first video amplifier stage to the VERT INPUT. Adjust the controls of the PS29 as follows:

TV VERT button depressed. GAIN switch on 1 volt/div. SYNC switch to INT, INPUT COUPLING switch to AC. Set the SYNC POLARITY switch to the positive (+) position if the sync pulses at the test point are positive, and to the negative (-) position if the sync pulses are negative. Turn the color bar generator pattern selector to the color bar position, and push the 5X EXPAND button. Note how the waveform is expanded, and rotate the HORIZ POS control to any desired section of the full trace. Push the 5X EXPAND button to unlatch the switch and return the trace to the normal vertical waveform. Adjust the HORIZ POS control so that the trace begins on the left of the 10X10 grid.

Depress the TV HORIZ pushbutton to obtain one cycle of the TV horizontal waveform. This may also be expanded, if desired, using the 5X EXPAND pushbutton.

SWEEP GENERATOR 60Hz

Use the LO CAP PROBE to connect approximately 6.3 volts AC 60Hz from a filament circuit in the receiver to the VERT INPUT. Depress the SWEEP GEN 60Hz pushbutton and adjust the GAIN switch for about 8 divisions of vertical deflection.

Adjust the SWEEP GEN PHASE SET screwdriver adjustment and note how this control effects the phase relationship between the input signal and the internal 60Hz line sweep. Rotate the small center knob of the VARISPEED switch counter-clockwise until the display is two horizontal divisions wide and note that this control now functions as a horizontal gain control. Depress the 5X EXPAND pushbutton and note that the expansion also expands the horizontal sweep in the SWEEP GEN function. Then return the PS29 to normal operation by turning the center knob of the VARISPEED control fully clockwise to its detent position and unlatch the 5X EXPAND pushbutton.

VECTOR B-Y

Connect a color bar generator to a properly operating television receiver and tune the receiver to properly display the color bars. Depress the VECTOR B-Y pushbutton and connect the VERT INPUT to the output of the R-Y amplifier or other R-Y test point on the chassis, using the LO CAP PROBE. Inject the signal from a B-Y test point on the chassis into the VECTOR B-Y input. Adjust the GAIN switch for the desired pattern height and 2V-20V for the desired width. It may be necessary to change the horizontal sweep sensitivity by means of the 5X EXPAND as

well. Fine adjustment of the horizontal sensitivity is possible by rotating the center knob on the VARISPEED control.

PROBE COMPENSATION

The 39G80 low capacity probe contains an adjustable compensation capacitor. The adjustment of this capacitor should be checked frequently to insure accurate square wave reproduction. A good square wave source may be used for compensation purposes. Use the probe to be compensated to connect the test waveform to the VERT INPUT. Depress the VARISPEED button and set SYNC switches to + and INT. Adjust GAIN, VERT POS, HORIZ POS, INTENSITY FOCUS and VARISPEED controls for 5 cycles of signal and a sharp viewable trace near the center of the 10X10 grid. Adjust the probe compensation capacitor for the correct waveform as shown in Fig. 1.

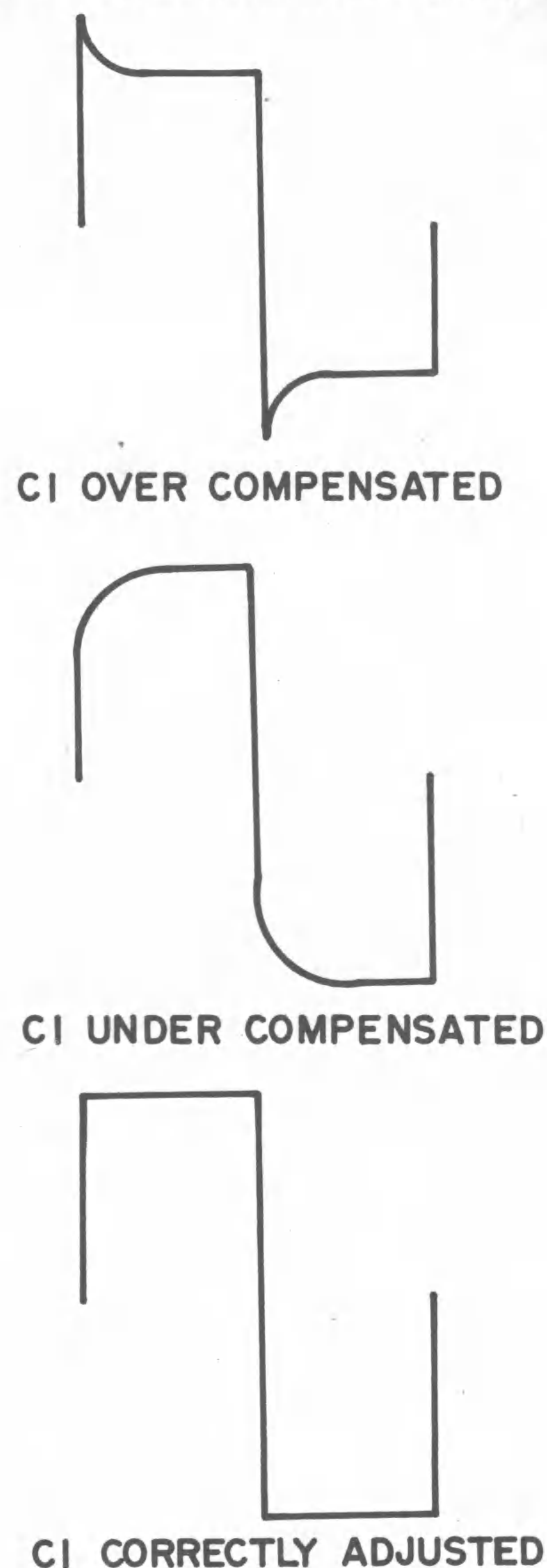

Fig. 1. Effect of C1 on square wave response.

APPLICATIONS

AC VOLTAGE MEASUREMENTS

The measurement of AC voltages is one of the more important uses for an oscilloscope. The calibrated inputs of the PS29 make possible very accurate measurements using the following procedure:

1. Use the LO CAP PROBES to connect the signal to be measured to the VERT INPUT. If the amplitude of the voltage to be measured is in doubt, start with the GAIN switch set to the 500 position. Set the INPUT COUPLING switch to the AC position.
2. Adjust the controls on the PS29 to display approximately two cycles of the signal, with an amplitude of at least one vertical division.
3. Use the 10X10 grid to measure the vertical distance between the points on the waveform that you wish to measure. Be sure that the small center knob of the GAIN switch is turned full clockwise. When measuring small voltages, the width of the trace can be a significant part of the total distance, so make all measurements from the same side of the trace.

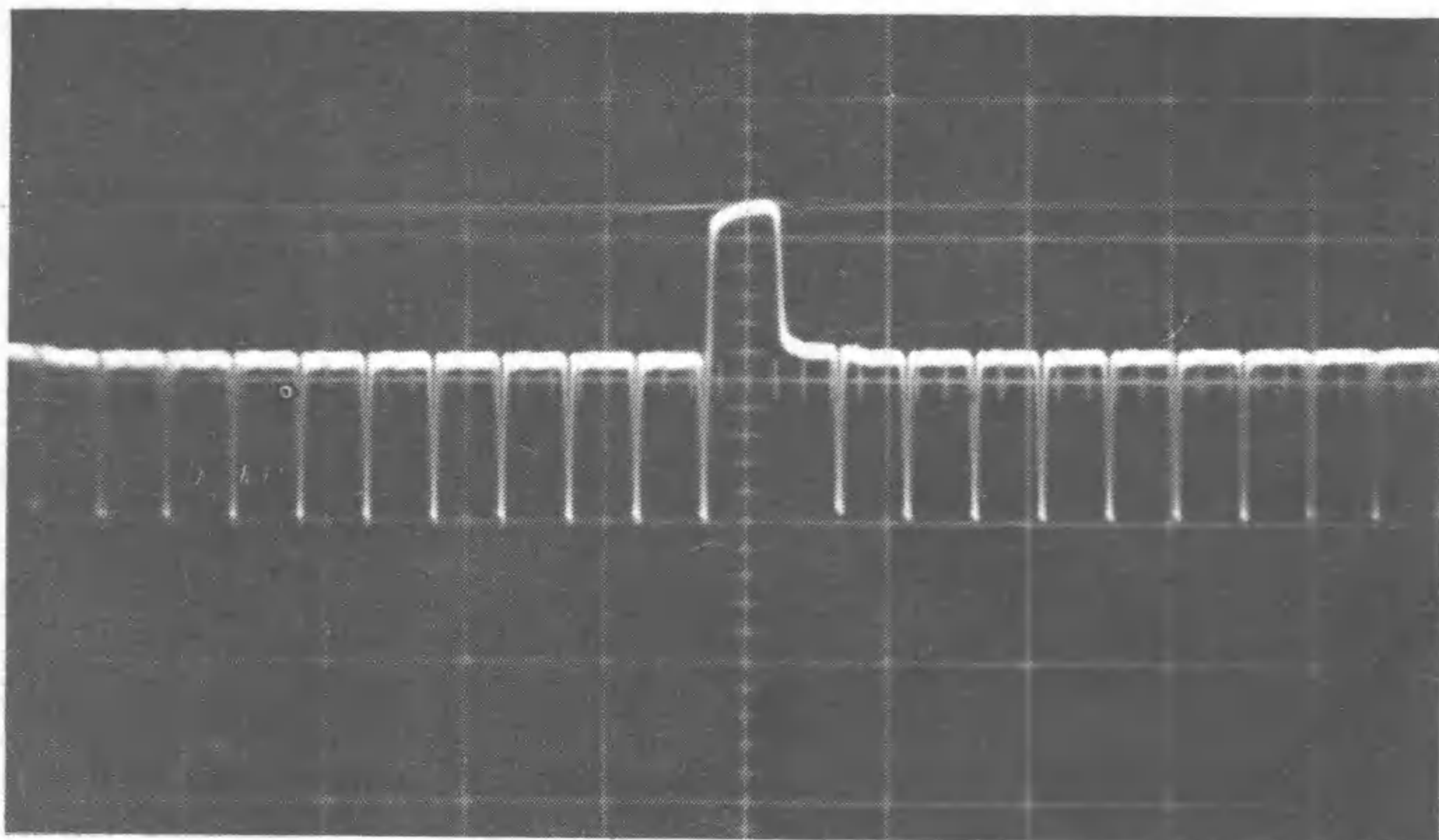

Fig. 2. Measuring peak-to-peak voltages.

4. Multiply the distance measured by the setting of the GAIN switch. The result is the voltage between the two points measured. In the composite video waveform shown in Fig. 2, the total distance from the tip of the sync pulse to the most negative point is 2.2 divisions. The setting of the GAIN switch is 2 VOLT/DIV, so the total peak-to-peak amplitude of the signal is 4.4VP-P. The distance from the tip of the sync pulse to the blanking level is 1 division so the amplitude of the sync pulse is 2V.

DC VOLTAGE MEASUREMENTS

The use of the DC coupled scope to measure both DC as well as AC signals can speed servicing in many

circuits, especially solid state. With the DC coupled scope, servicing can be faster as you will not need to keep switching back and forth between the scope and the DC voltmeter.

1. Set the INPUT COUPLING switch to the center ground position.
2. Use the VERT POS control to center the trace on the major horizontal grid line position.
3. Set the coupling switch to DC and connect the probe to the point where the signal is to be measured. Start with GAIN switch set to 500 VOLT/DIV and slowly turn the switch clockwise until the trace moves up or down between three and four centimeters. An upward movement indicates a positive voltage, a downward movement a negative voltage.
4. Note the number of centimeters or divisions the trace has moved from the center graticule line and multiply this by the setting of the vertical input switch. If the trace moves up 4 divisions and the GAIN switch is set to 10volts/div., the voltage would be 10volts/div. X4div=+40 volts.

MEASURING THE DC LEVEL OF AN AC SIGNAL

The DC level of an AC signal is often more important than the actual signal amplitude. The DC coupled PS29 makes the critical level measurements accurately using the following procedure:

Follow the set up procedure for DC voltage measurements. In the composite video waveform in Fig. 3, the DC level of the blanking level is 2 divisions at 1volt/div. or 2 volts. The DC level of the top sync pulses in 3 divisions, or 3 volts. The DC level of the negative tips of the video information is 1 division at 1 volt per division or 1 volt.

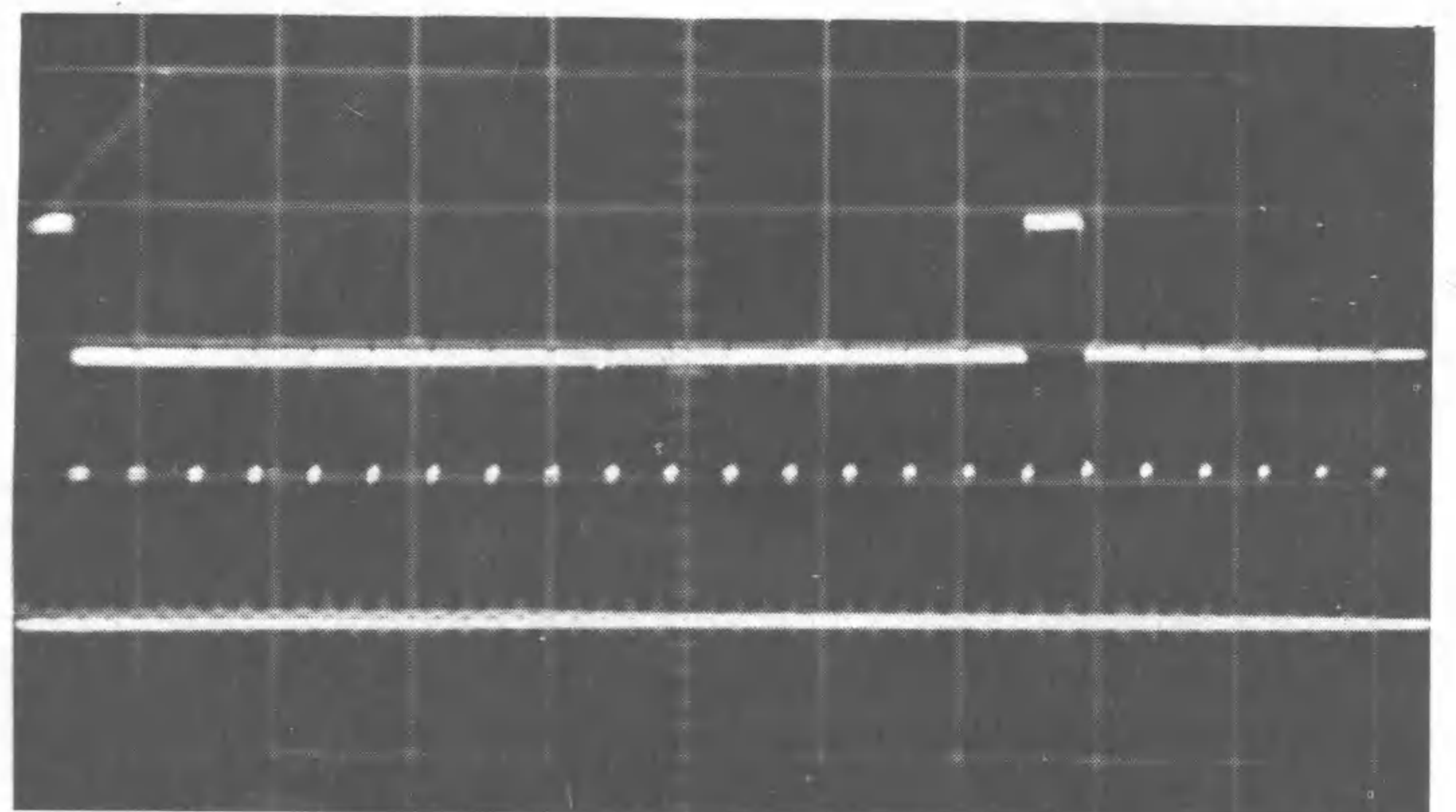

Fig. 3. Measuring DC level of video signal.

TIME AND FREQUENCY MEASUREMENTS

The following sections outline several methods of measuring time and frequency. The versatility of the PS29 makes text book results possible on even the most complex procedures.

TIME MEASUREMENTS USING THE CALIBRATED TIME BASE

The calibrated time base method of measuring frequency is the easiest one to use, because the only equipment needed is the PS29 Minute Man.

1. Connect the signal to be measured to the VERT INPUT of the PS29, and adjust the controls to display one or two cycles of the signal. Be sure that the small center knob of the VARISPEED switch is in the full clockwise position, and depress the VARI-SPEED button.
2. Use the 10X10 grid to measure the horizontal distance between the two points that you wish to measure.
3. Multiply the distance measured by the setting of the VARISPEED control. Fig. 4 shows the waveform at the grid of the horizontal output tube in a television receiver. The width of the negative going pulse measured between points B and C is 1.1 divisions. The setting of the VARISPEED switch is 10uSec/Div, so this pulse is 11uSec wide. The horizontal distance for one complete cycle of the drive signal, as measured between points A and C is 6.3 divisions, so one complete cycle is 63uSec long.

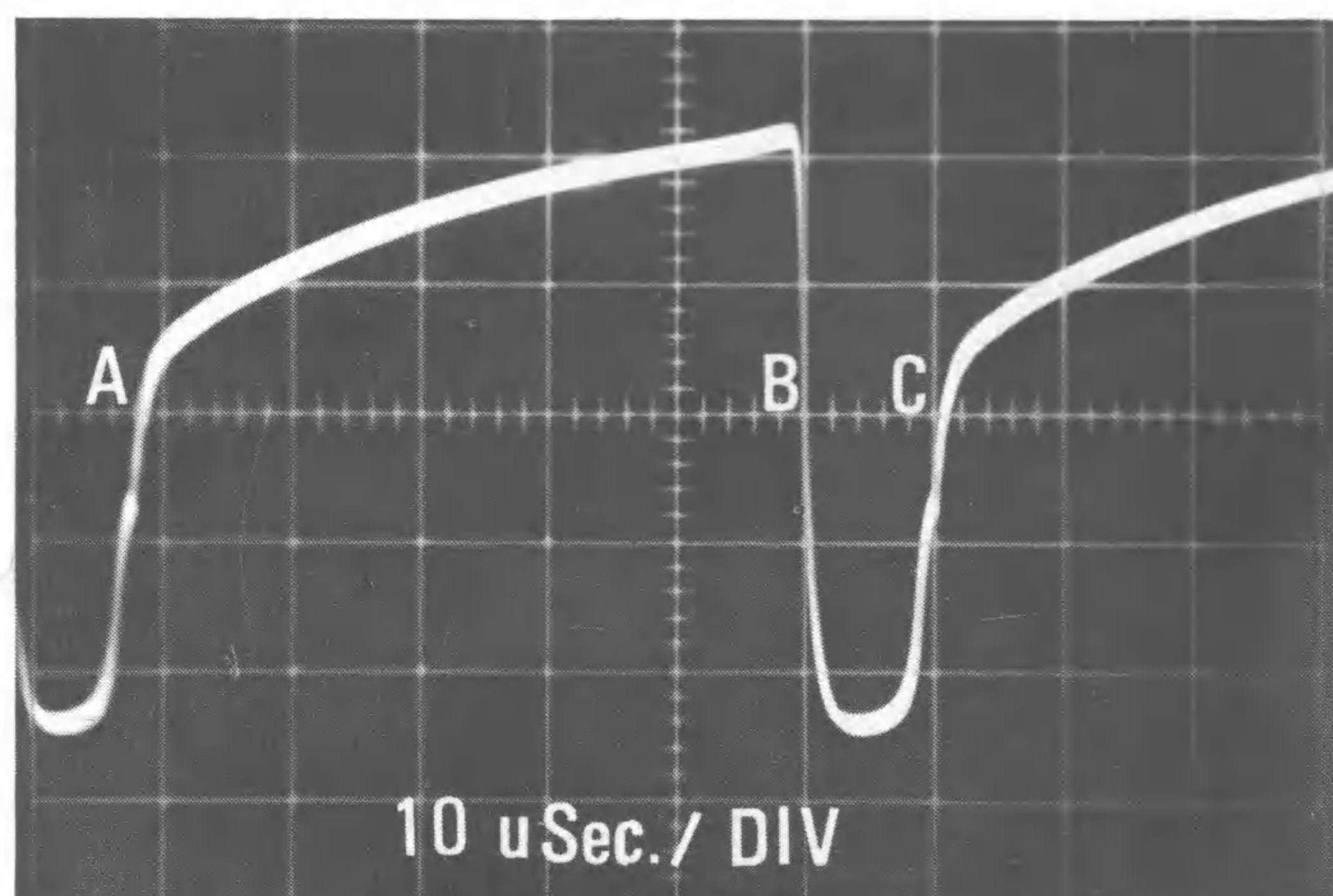

Fig. 4. Time measurement with PS29

FREQUENCY MEASUREMENTS USING CALIBRATED TIME BASE

The formula for finding frequency if time is known is:

$$\text{Frequency} = \frac{1}{\text{Time in seconds for one cycle}}$$

The time for one cycle in Fig. 4 was 63uSec., or .000063 seconds. 1 divided by .000063 equals 15,850Hz, or very close to the horizontal frequency of 15,750Hz.

FREQUENCY MEASUREMENTS USING LISSAJOUS FIGURES

The sensitivity and bandwidth of the PS29 VECTOR mode allow this type of measurement to be made from even the output of an RF generator up to 5MHz.

1. Connect the known frequency to the VERT INPUT, and the unknown frequency to the VECTOR B-Y input.
2. Press the VECTOR B-Y button and adjust the PS29 controls so that the entire pattern is visible on the screen.
3. Adjust the known signal frequency so that the pattern holds steady, and count the number of vertical and horizontal loops.
4. Use the following formula to find the unknown frequency.

$$\text{Known frequency} \times \frac{\text{Number of hor. loops}}{\text{Number of vert. loops}}$$

The examples of Fig. 5 show several patterns, and the frequency that they represent. The known frequency used in the example is 600Hz.

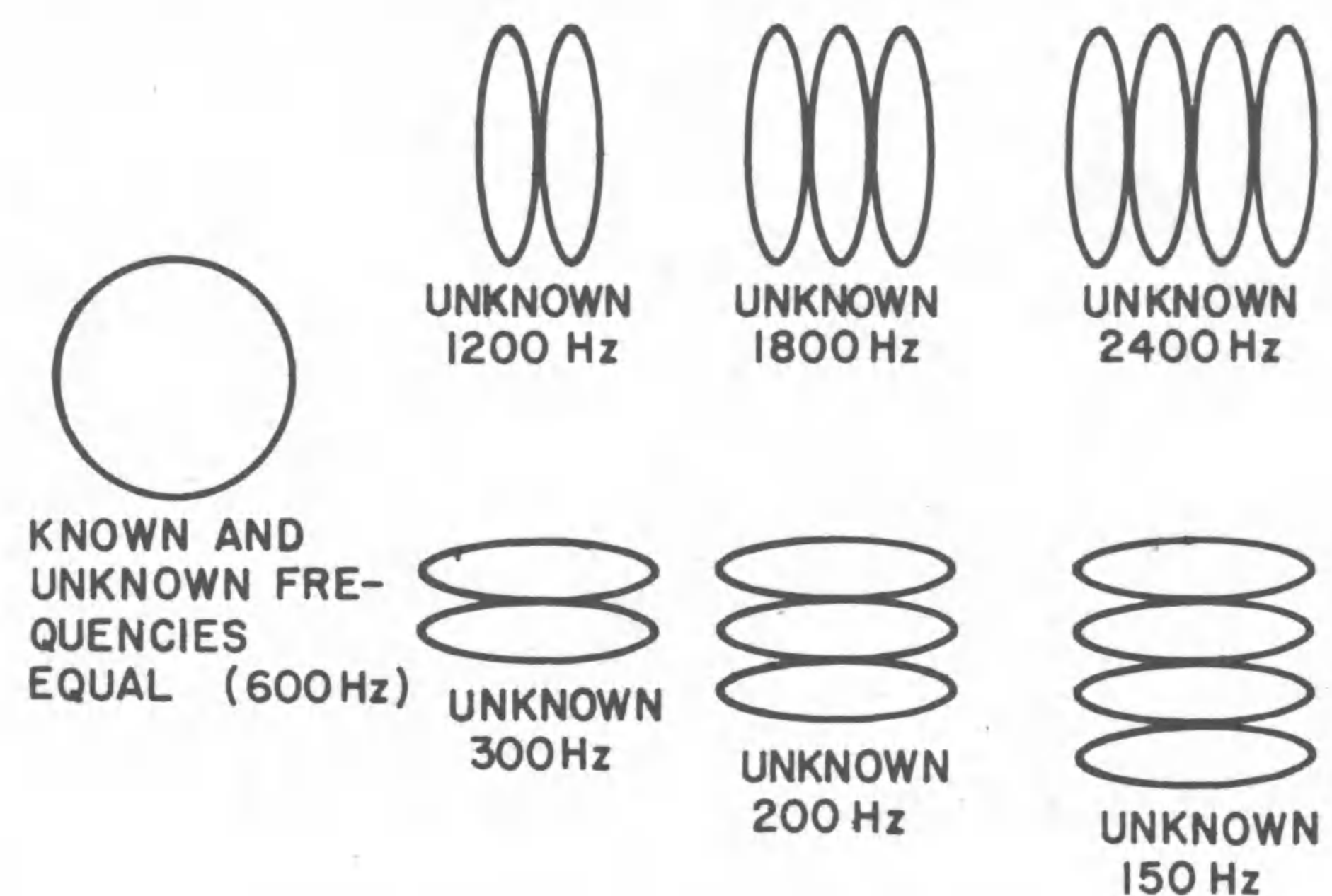

Fig. 5. Typical Lissajous patterns.

FREQUENCY MEASUREMENTS USING THE MODULATED RING

The VECTOR mode of the PS29 and the "Z" Axis input, are used to obtain a modulated ring pattern. Simply count the number of segments and multiply by the known frequency to find the unknown. This method will only work where the unknown frequency is higher than the known frequency.

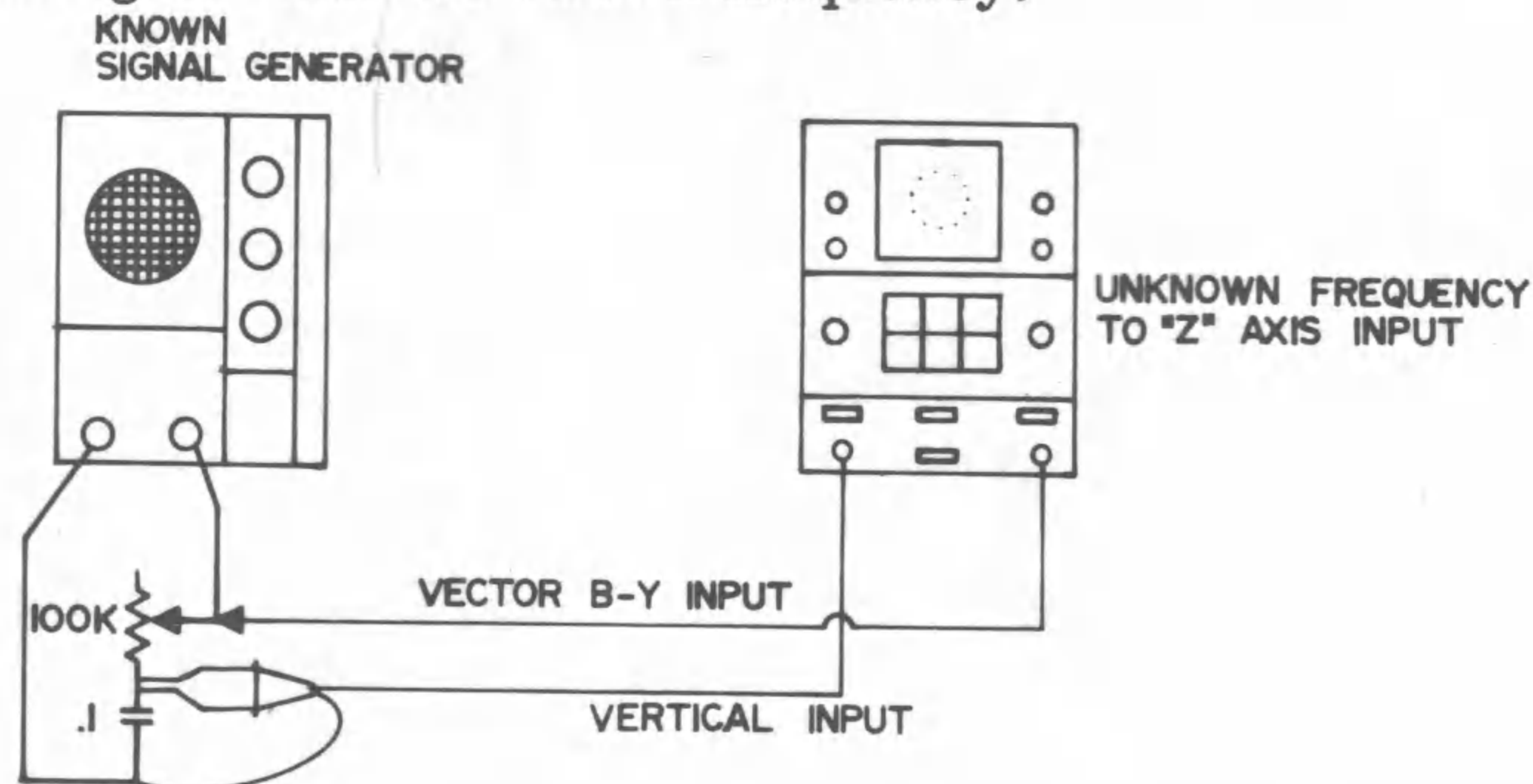

Fig. 6. Connections for frequency measurements using modulated ring method.

1. Connect the signal generator to a phase shift network as shown in Fig. 6. The network shown is for audio frequencies and the component values may need to be reduced for higher frequencies.
2. Connect the PS29 as shown and press the VECTOR B-Y button.
3. Adjust the control in the network until a circle or a near circle is obtained on the scope screen.
4. Apply the unknown frequency to the rear "Z" Axis jack on the PS29. Adjust the generator until the pattern stands still. Count the number of line segments to find the unknown frequency. The 11 segments shown in Fig. 7 indicate that the unknown is higher than the known frequency. Note that the shape of the overall circle is dependent upon the phase shift network and not the frequencies involved.

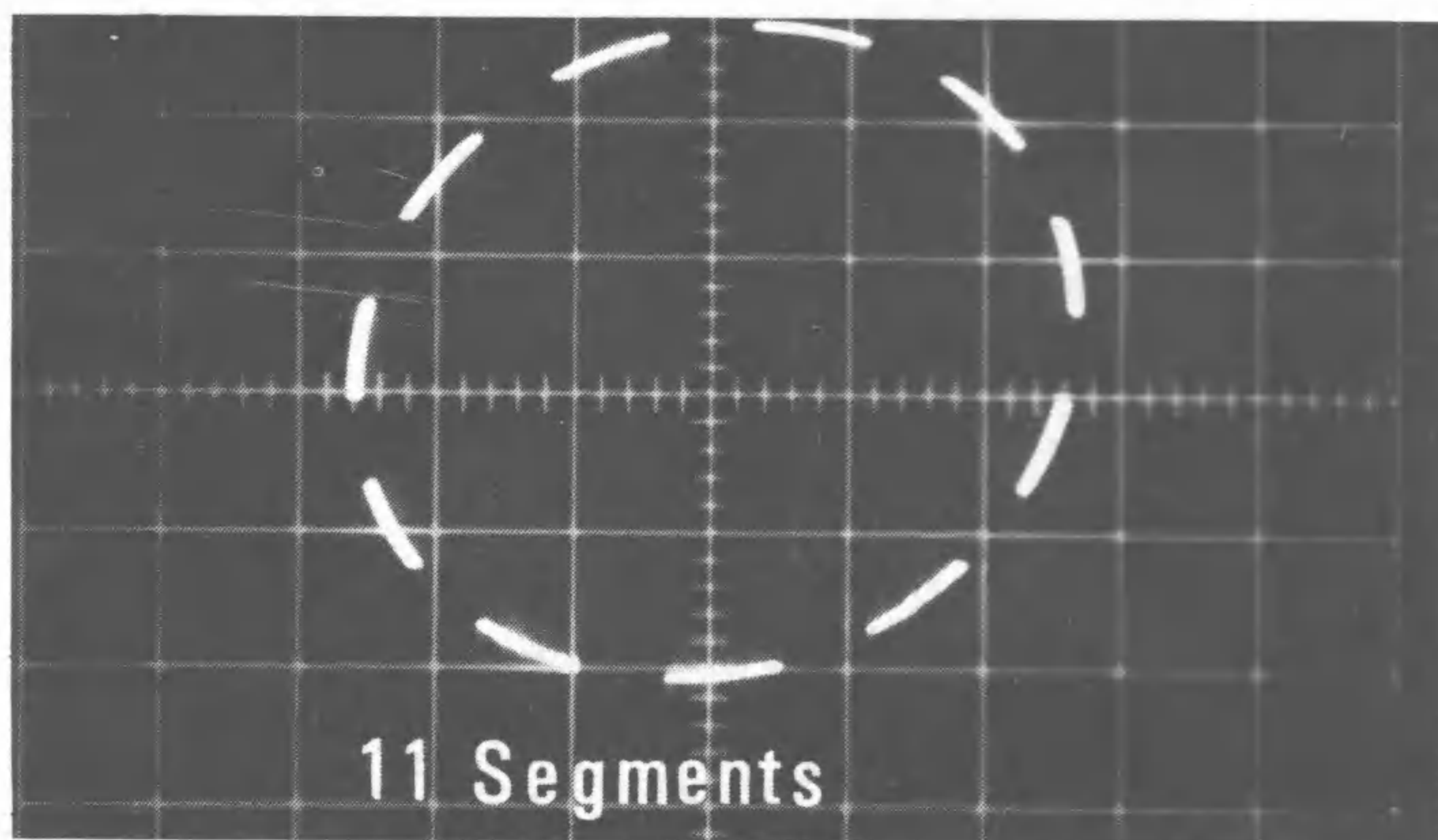

Fig. 7. Modulated ring showing unknown frequency 11 times the known frequency.

PHASE SHIFT BETWEEN SIGNALS

The closely matched horizontal and vertical channels of the PS29 VECTOR mode allow phase shift measurements on signals to 5MHz.

1. Press the VECTOR B-Y button and AC couple the VERT INPUT to one of the signals. Adjust the GAIN and trace position for a vertical line four divisions high centered on the scope screen.
2. Disconnect VERT INPUT and AC couple the second signal into the VECTOR B-Y input. Adjust the 2V-20V switch and the VARISPEED vernier and HORIZ POS controls for a horizontal line four division long centered on the scope screen.
3. Reconnect VERT INPUT to the first signal and use the following formula to find the phase angle. For Fig. 8.

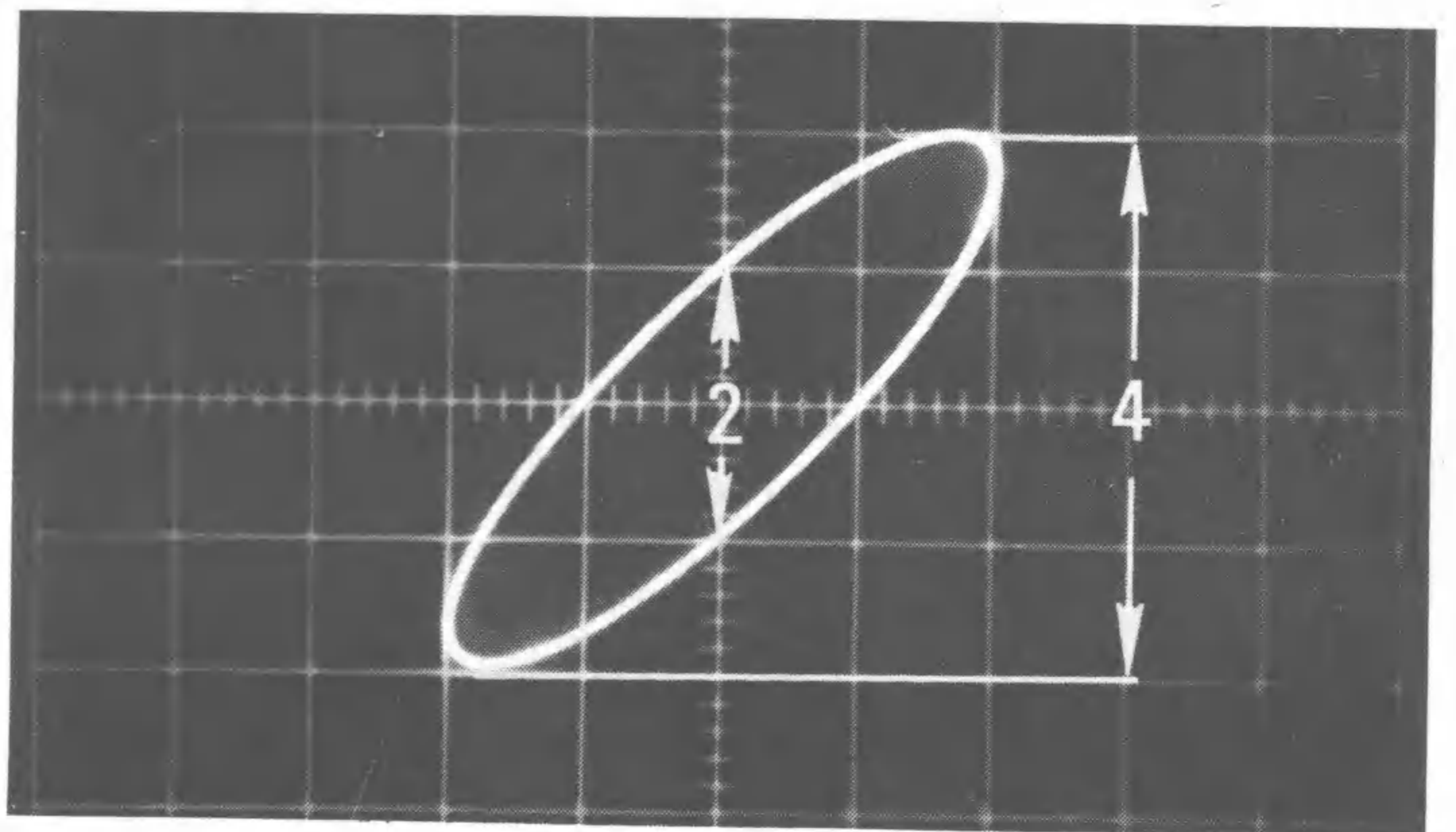

Fig. 8. Measuring phase shift between signals.

$$\begin{aligned} \text{Sine of Angle} &= \frac{\text{Divisions Inside Oval}}{\text{Divisions Outside Oval}} \\ \text{Sine of Angle} &= \frac{2}{4} \\ \text{Sine of Angle} &= .5 \\ \text{Angle} &= 30^\circ \end{aligned}$$

VECTOR SERVICING

The use of a vector scope to service color television receiver circuits is increasing in popularity. The vectorscope along with a good color bar generator is a very useful tool for troubleshooting and aligning the color circuits. Proper phase shift of the 3.58MHz oscillator, bandpass alignment and frequency of the 3.58 are some of the important points that can be checked with the vector pattern.

The front panel VECTOR inputs of the PS29 make vector servicing even faster and easier than before. Here is the procedure for obtaining the vector pattern.

1. Connect a standard color bar generator such as the Sencore Color King to the television receiver antenna terminals and use the 4.5MHz sound carrier to properly fine tune the receiver.
2. Depress the VECTOR B-Y button. Connect the VERT INPUT probe to the output of the R-Y amplifier or other R-Y test point on the chassis. Connect the VECTOR B-Y input to the B-Y test point.
3. Adjust the GAIN and 2V-20V switches to the settings that give a viewable pattern on the scope screen.

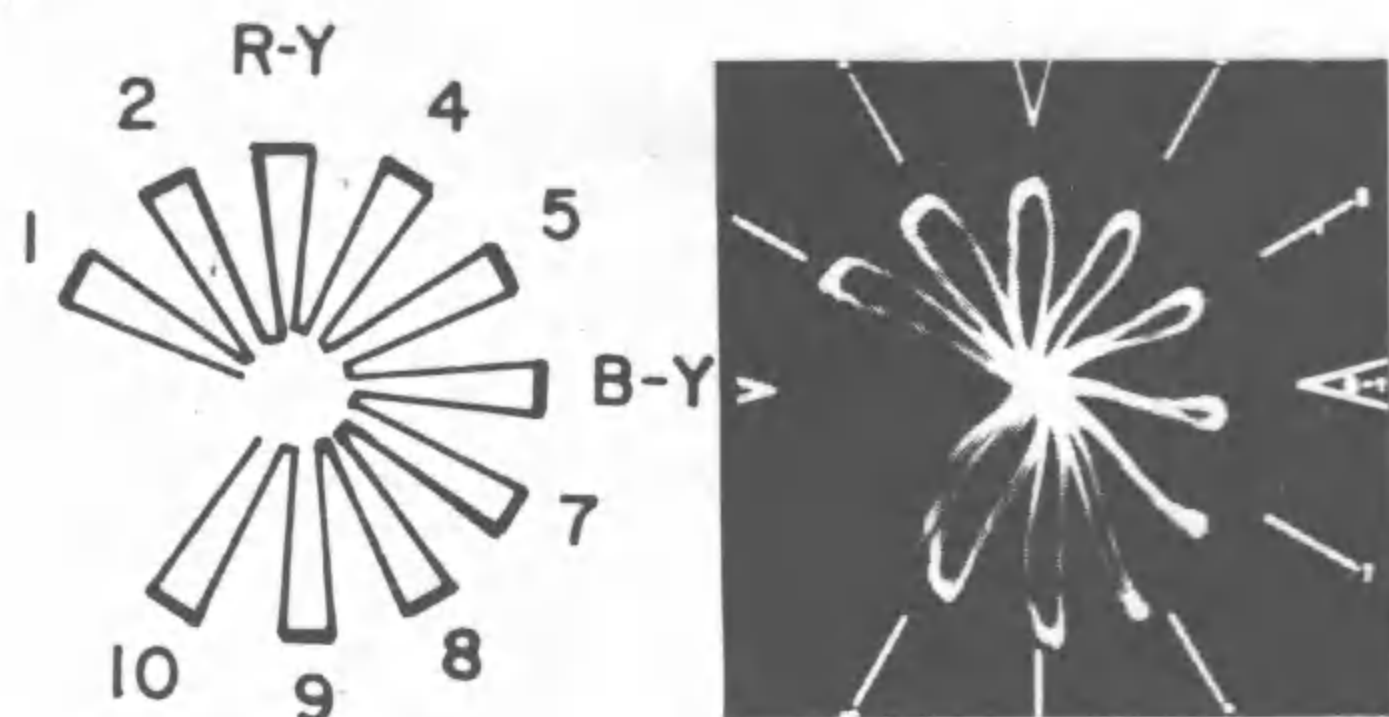

Fig. 9. Ideal and typical Vector patterns.

If the sensitivity settings of the GAIN and 2V-20V switches are not the same, a distorted vector pattern will result. If the switches are set to different settings, and the pattern is good, then a trouble exists in the receiver. The photo in Fig. 9 is a good vector pattern. Note that the good pattern is close to that of the ideal.

TROUBLESHOOTING WITH THE VECTOR PATTERN

Defects in the color circuits of any color receiver can be isolated by using the vector pattern. Here are a few of the more common troubles and how they will appear on the vector scope; Weak or Loss of Red: The photo in Fig. 10 indicates a weak R-Y signal. The vertical amplitude of the vector pattern is low, and the pattern appears squeezed in the vertical direction. Note that the blue or B-Y signal appears to have the

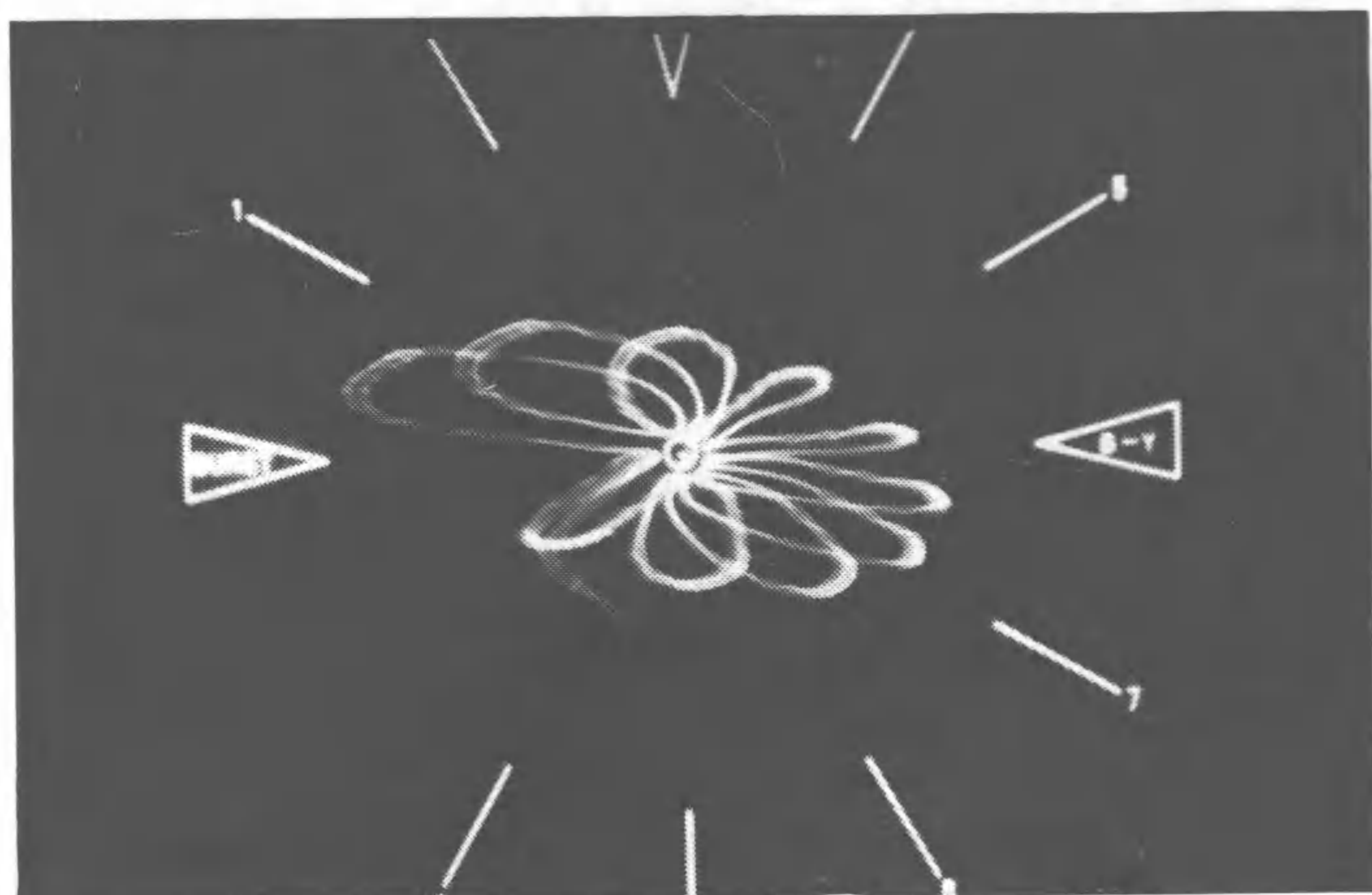

Fig. 10. Vector pattern showing weak red signal.

correct amplitude of signal. Here, a check of the R-Y difference amplifier and the demodulator circuits should locate the problem.

Weak or Loss of Blue: A weak blue or B-Y signal is indicated by a pattern that is narrow horizontally as

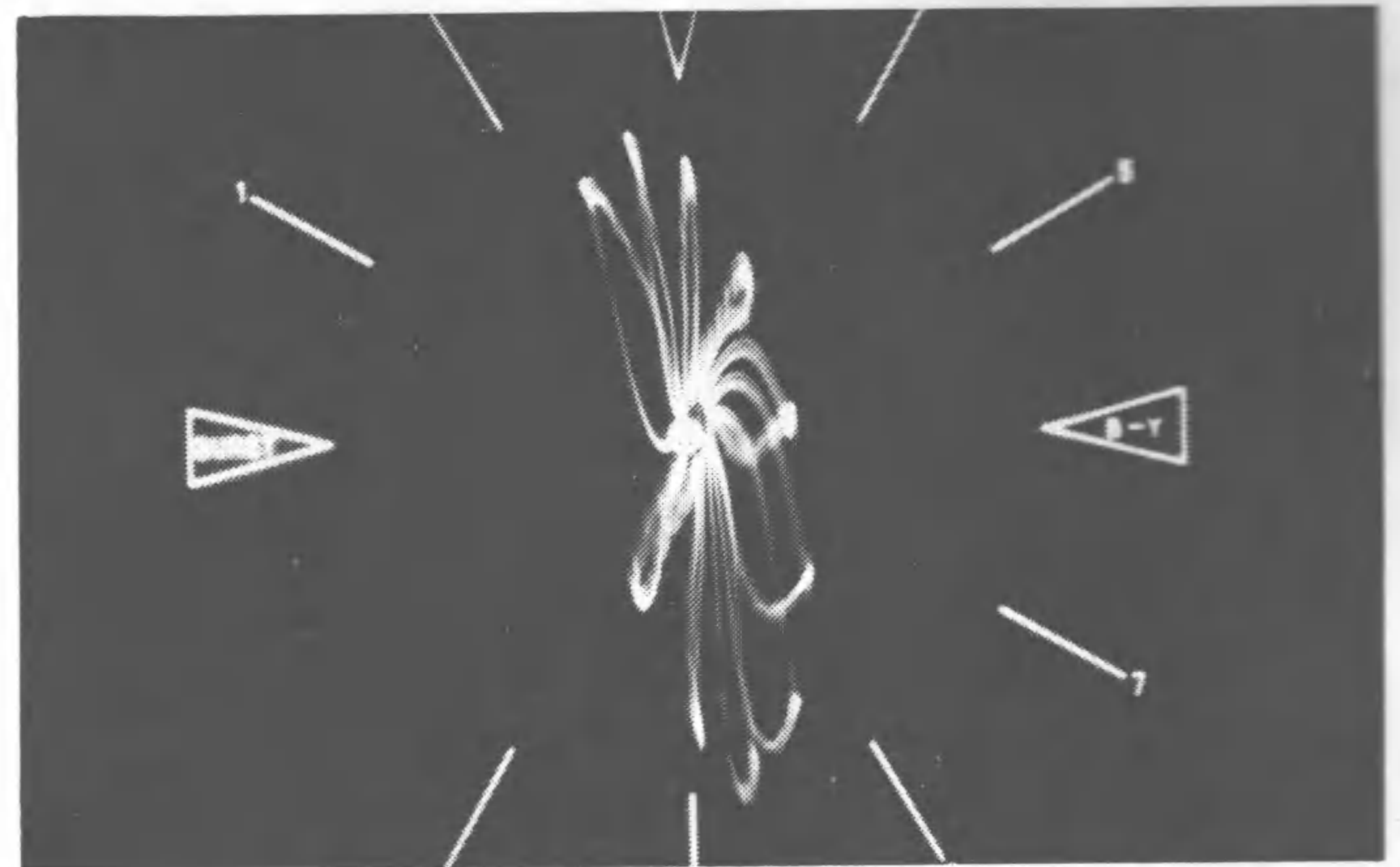

Fig. 11. Vector pattern showing weak blue signal.

shown in Fig. 11. A check of the B-Y difference amplifier and the demodulator stage should locate the problem.

Incorrect Phase Angle: The phase angle between the R-Y and B-Y signal is from 90 to 120 degrees, depending upon the receiver and the manufacturer. This angle is adjustable in most of the older receivers and is fixed in the newer sets. To set the phase angle, connect the scope and obtain a vector pattern as previously described.

Set the third or R-Y bar to its proper position and note the position of the sixth or B-Y petal. It should fall between the B-Y mark (90°) and the number 7 (120°) on the vector graticule. Adjust the demodulator phase transformer to position the B-Y petal on its correct mark. The R-Y petal will move slightly. It should be repositioned with the tint control to its proper mark and the position of the B-Y petal rechecked.

Most of the newer receivers have fixed components and do not require adjustment. If one of these fixed components is replaced, the angle should be checked to be sure that you are on or close to the proper angle. An off value part can shift the angle so it is difficult for your customer to obtain flesh tones.

Total loss of Color: A total loss of color will result in no pattern except the blanking as shown in Fig. 12. The color oscillator, color killer, bandpass amplifier or demodulator could be at fault.

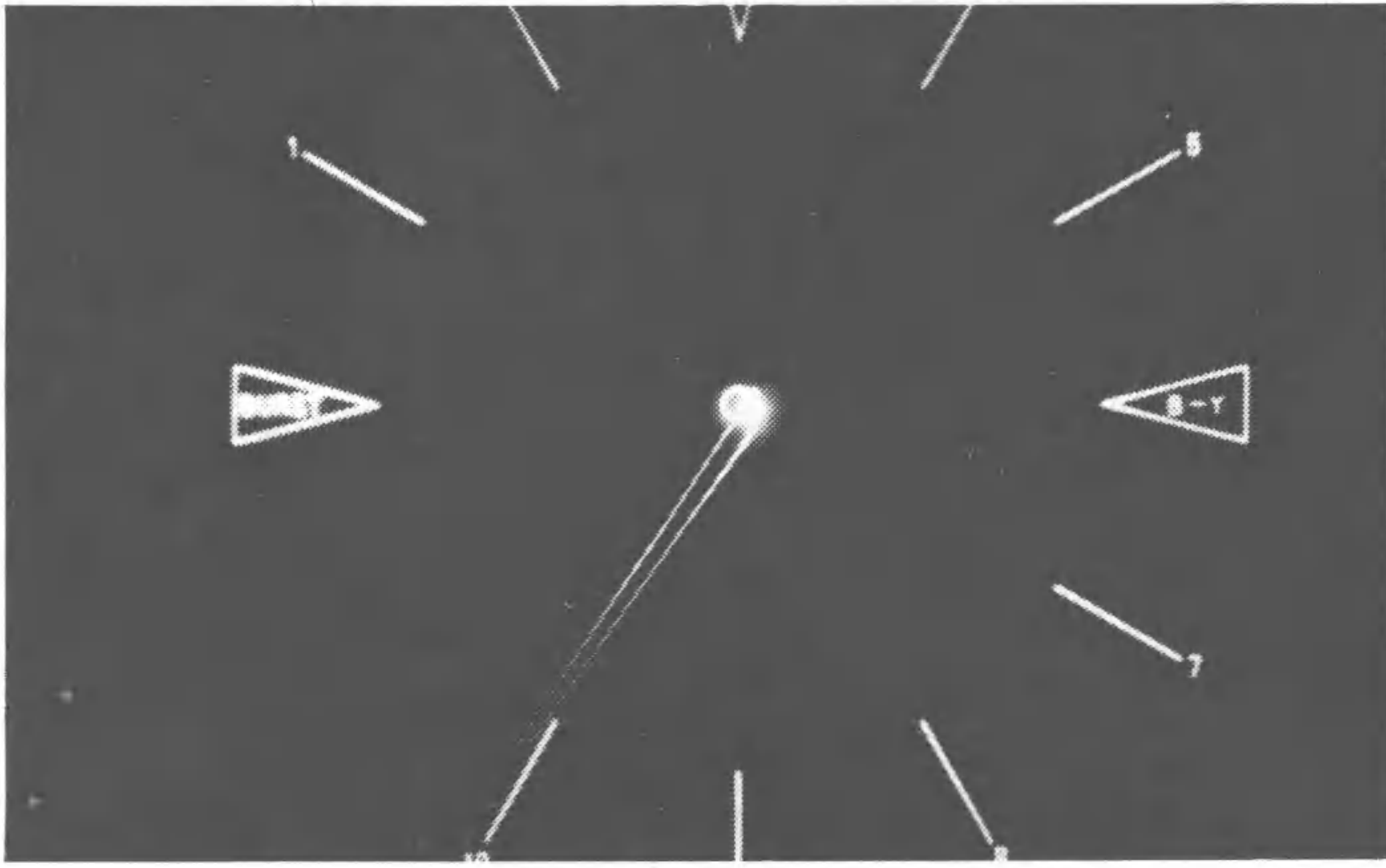

Fig. 12. Vector pattern obtained with no color output.

Solid State Chroma Amplifiers: In many of the newer receivers, transistors are being used to drive the picture tube. The signal level is still quite high at this point, but the cathodes are being driven and not the control grids as was done with tube receivers. The probes must be connected to the cathodes of the CRT to obtain a vector pattern on these receivers. This will give an upsidedown and backwards looking pattern. This is normal. The important points about the vector pattern still remain the same. Use the 9 on the vector-grid as the R-Y mark, the BURST as the B-Y mark, it will also be necessary to shunt the video information to ground to obtain a clean vector pattern. To do this, temporarily connect a 20mfd electrolytic capacitor from the base of the video amp to ground.

SQUARE WAVE TESTING WITH THE PS29

Square wave testing of audio and video amplifier is a standard procedure with many advanced technicians. The response of the amplifier as well as many circuit troubles are easily determined by the shape and distortion present in the square wave. Loss of high frequency response, phase shift, poor low frequency response and ringing are a few of the problems that can be found with this method.

1. Connect a square wave generator to the input of the amplifier to be tested.
2. Connect VERT INPUT to the output of the amplifier. It can be connected across the speaker or across a resistor in place of the speaker. The resistor is preferred as the noise from the speaker can be annoying.
3. Compare the resultant waveform with the input and the ones shown in Fig. 13. The best check on audio amplifiers is to use a low frequency, a mid

frequency and a high frequency. Frequencies of 60Hz, 400Hz, and 2KHz will check the amplifier at all extremes that it will encounter in normal use. If the amplifier passes a clean square wave, the response is about 10 times the frequency used. For example, if the 2KHz square is good, then the frequency response is good to at least 20,000 Hertz.

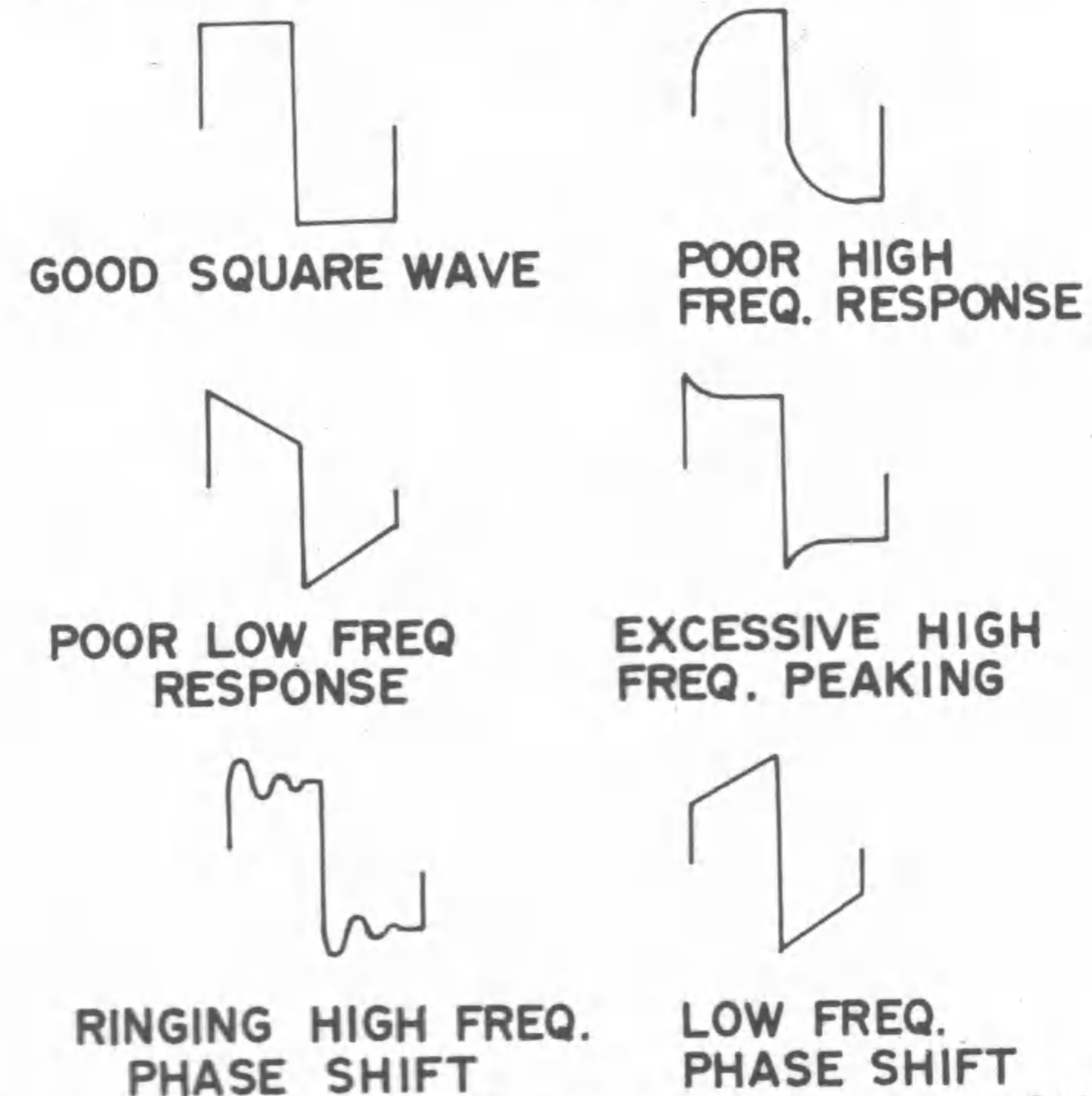

Fig. 13. Distorted square wave resulting from poor frequency response.

If the output square wave is not clean or like the input, trace the signal back to see which stage causes the distortion.

RISE TIME MEASUREMENTS

Rise time is that time between the 10% and 90% points on the leading edge of a pulse. Use the calibrated time base and the 5X expand on the PS29 to make this measurement.

1. Connect the PS29 to observe the desired pulse, depress the VARISPEED button and adjust the controls to obtain at least one cycle on the scope screen.
2. Adjust the GAIN switch, and its center knob so that the waveform is exactly 5 divisions high on the scope screen.
3. Use the VERT POS and HORIZ POS controls to center the waveform on the major vertical grid line, so that it is exactly 2½ divisions above and below the major horizontal grid line, as shown in Fig. 14.
4. Depress the 5X EXPAND button to activate the 5X expand, and adjust the HORIZ POS control, so that the 10% point of the leading edge crosses at the intersection of the horizontal and vertical grid lines as shown in Fig. 15.
5. Measure the horizontal distance in graph screen divisions between the 10% and 90% points on the leading edge.

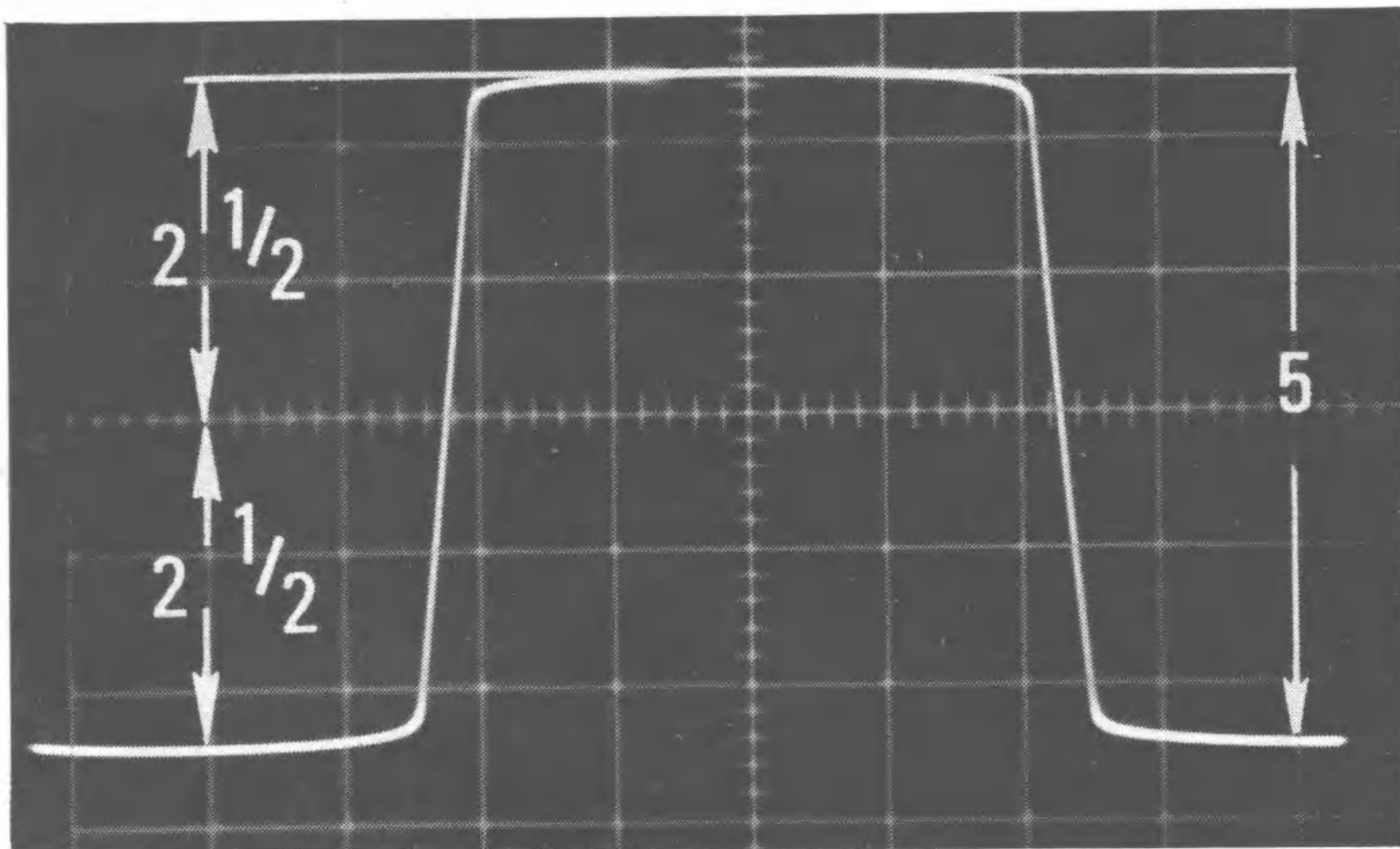

Fig. 14. Centering waveform for rise time measurement.

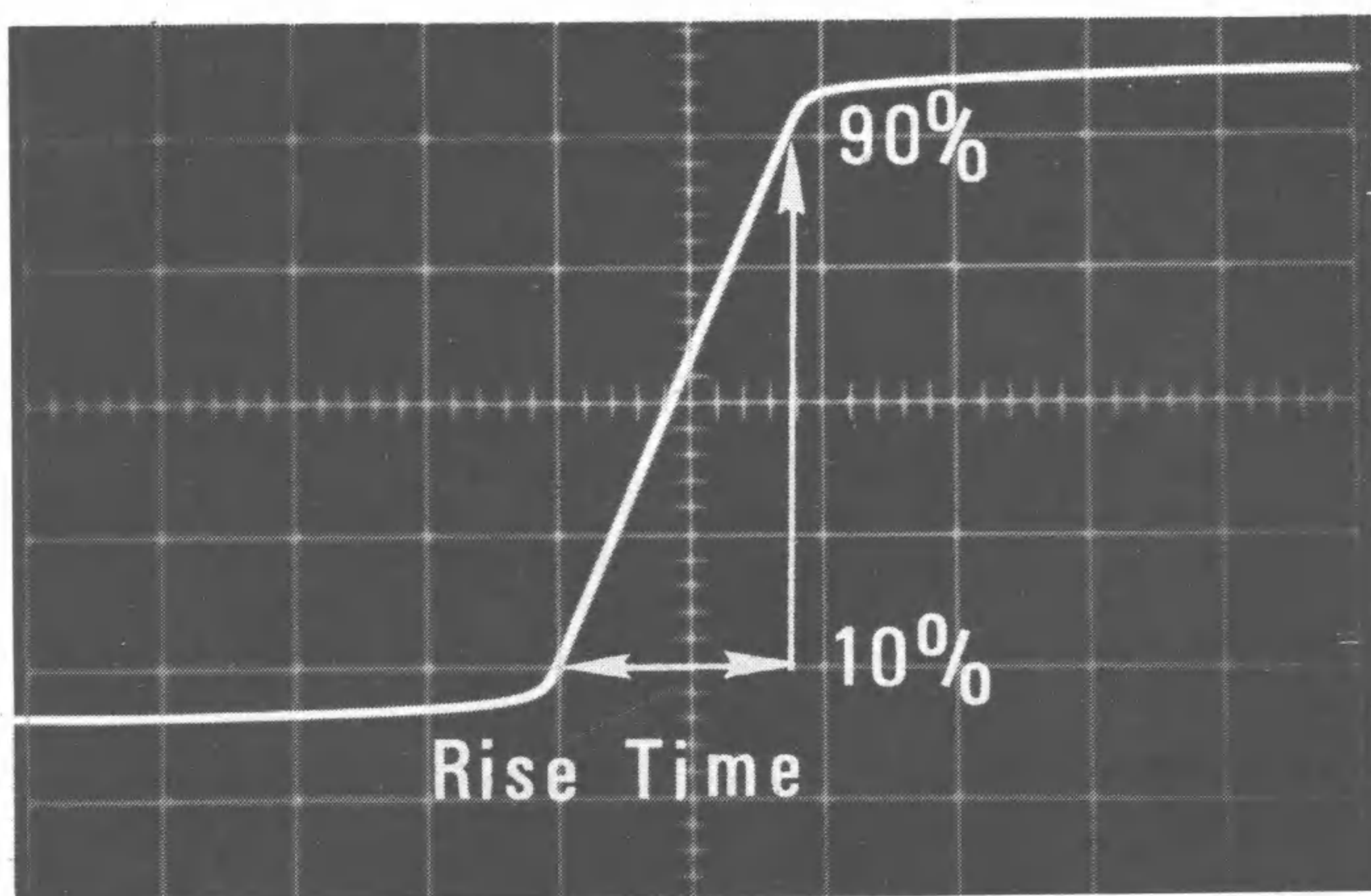

Fig. 15. Measuring rise time.

6. The rise time equals the distance measured in step 5, divided by 5 for the 5X expand, and multiplied by the setting of the VARISPEED switch. In Fig. 15 the distance is 1.8 divisions, and the setting of the VARISPEED switch is 20uSec/DIV.

$$\begin{aligned} \text{Rise Time} &= \frac{1.8\text{DIV}}{5} \times 20\text{uSEC/DIV} \\ &= 7.2\text{uSec} \end{aligned}$$

COIL AND TRANSFORMER TEST

Shorted turns and defective coils can be located by a shock exciting technique. A good coil with a high Q will produce a damped wave effect on the scope screen. A defective coil will have less of a damped wave. Follow the procedure below, with Fig. 16 to test the flyback transformer in a television receiver.

1. Connect the SWEEP OUTPUT signal from the rear of the PS29 through a 100pf capacitor to the plate lead from the High Voltage Rectifier.

2. Connect the VERT INPUT to the plate lead from the High Voltage rectifier and the ground lead to the plate lead from the Horizontal Output tube.

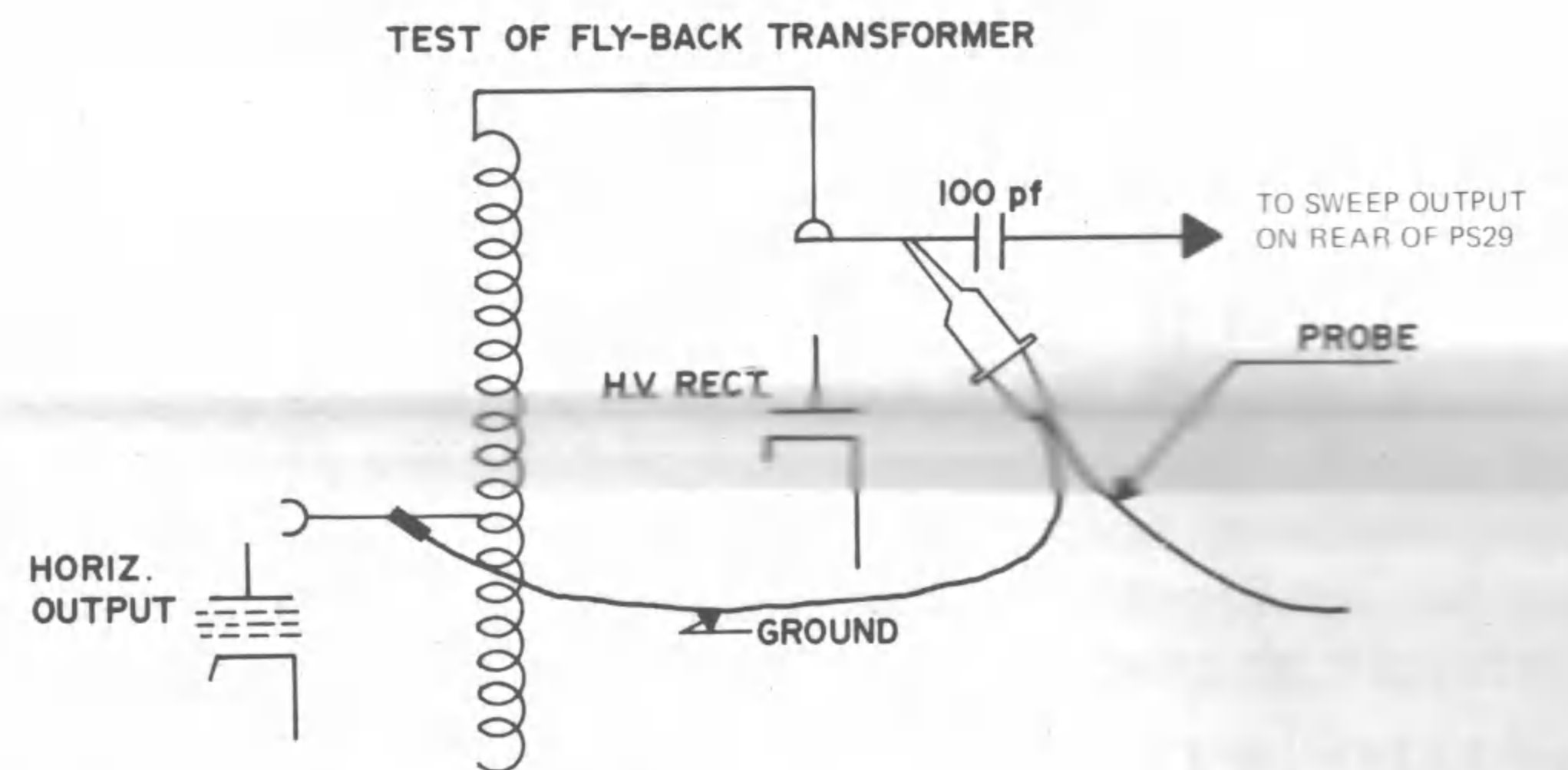

NOTE: Turn power off when making test.

Fig. 16. Connections for transformer ringing test.

3. Depress the VARISPEED button, and set the VARISPEED switch to .1mSec/DIV.

The pattern produced by a good flyback transformer is shown in Fig. 17. Note the length of the damped wave. The pattern produced by a flyback transformer with a shorted turn is shown in Fig. 18. Note the much shorter length of the damped wave.

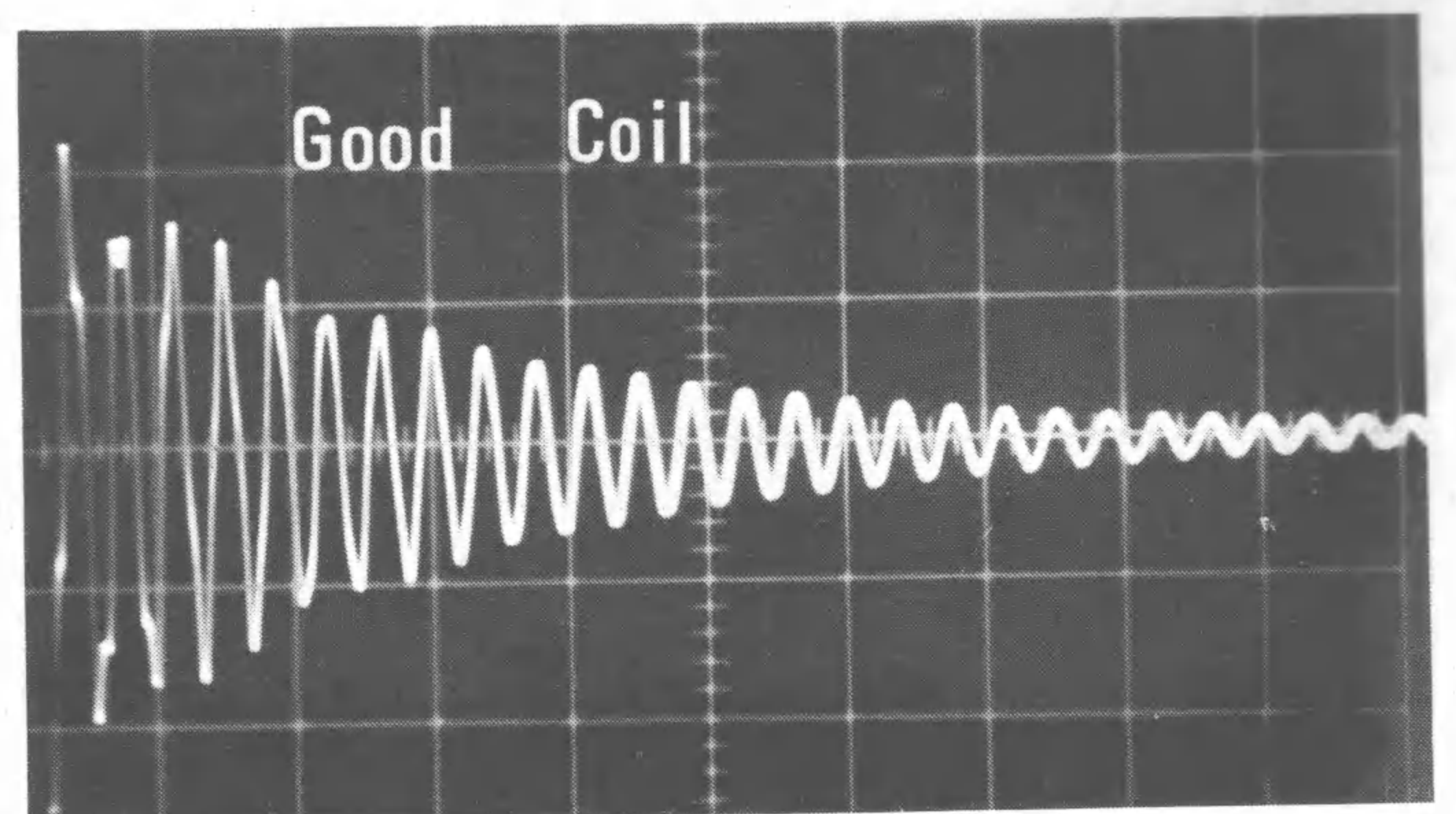

Fig. 17. Waveform of good transformer.

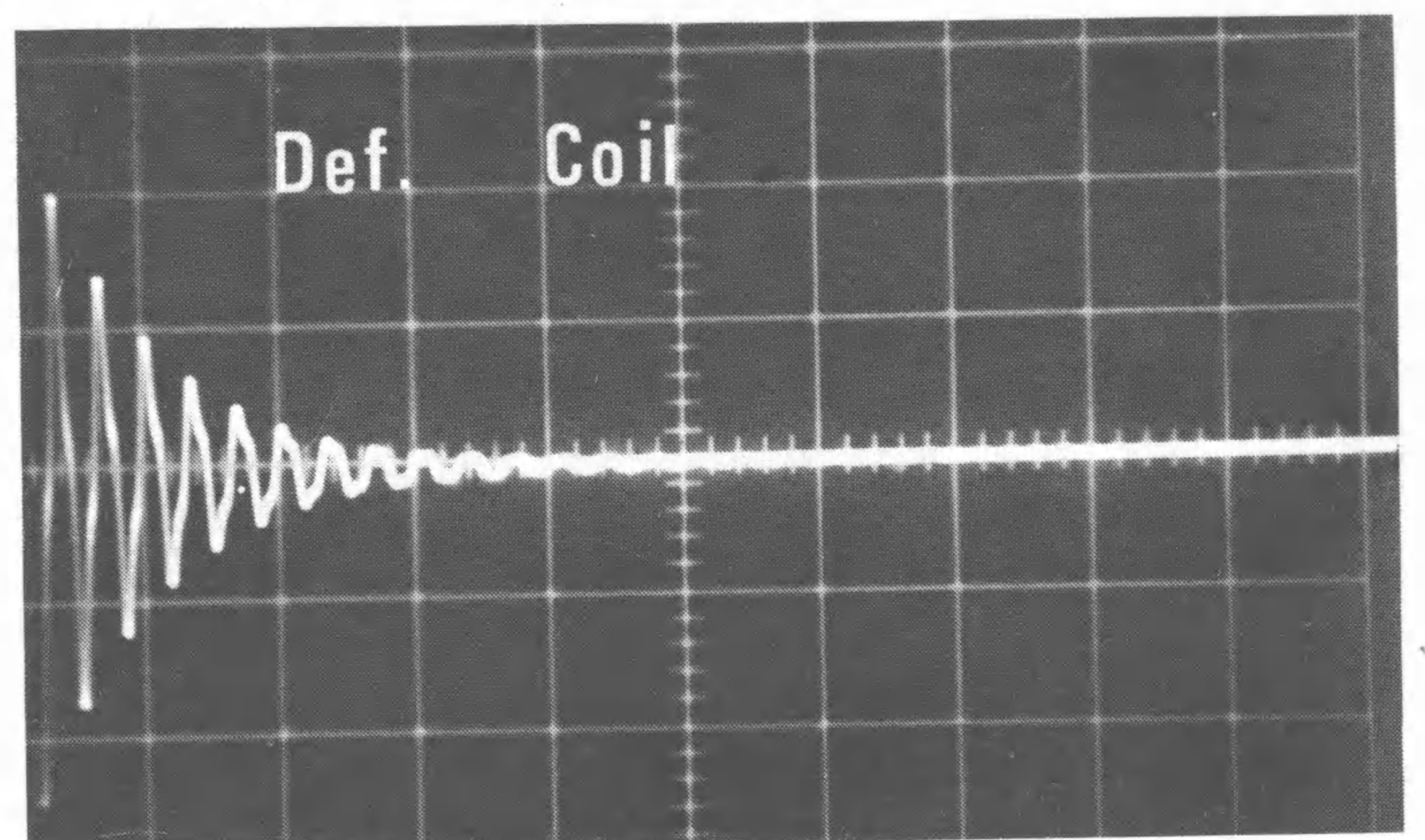

Fig. 18. Rapid decrease in oscillations indicate defective transformer.

The test for the horizontal winding of the deflection yoke is similar to the flyback test.

1. Unplug the yoke from the chassis and connect the SWEEP OUT signal and the VERT INPUT to the high side of the horizontal deflection winding.

2. Connect the ground lead to the low side of the winding and set the VARISPEED switch to 10uSec/DIV.

The indication for a good and bad yoke are similar to the results shown in Fig. 17 and 18.

USING THE PS29 WITH A SWEEP GENERATOR

1. Use one of the 39G80 LOW CAP PROBES to connect the sweep generators scope vertical cable to the VERT INPUT of the PS29. Set the GAIN switch to the .5 volt/DIV. NOTE: A cable is available from your nearest Sencore regional office to connect the PS29 directly to sweep generators such as the Sencore SM152 and SM158. This BNC to phone plug cable, part number 39G47, is priced at \$8.00. This cable provides a direct connection to the PS29 input, therefore it will be necessary to use a .1 multiplier for the GAIN calibrations to maintain accurate peak-to-peak measurements.

2. For sweep generators that provide a scope horizontal signal, connect that signal to the VECTOR B-Y input of the PS29 and depress the VECTOR push-button.

Adjust the generators phase control for a pattern with no fold over. For sweep generators that do not provide a scope horizontal signal, push the SWEEP GEN 60Hz button and adjust the SWEEP GEN PHASE SET for a pattern with no fold over.

Fig. 19 shows the ideal response of the IF amplifiers in a modern color receiver. The color carrier (42.17MHz) and the video carrier (45.75MHz) are at the 50% points on the curve, and are directly across from each other. The adjacent channel video carrier (39.75MHz), the co-channel sound carrier (41.25MHz) and the adjacent channel sound carrier (47.25MHz) are on the base line indicating proper trap action. 41.67MHz and 42.67MHz mark the limit of the receivers color response. Note that 41.67MHz, 42.17MHz and 42.67MHz form a straight line, with equal spacing between markers.

Fig. 20 shows the ideal response of the chroma band-pass amplifiers in a modern color receiver. This curve was obtained using a Sencore SM152 sweep and marker generator, and injecting a VSM signal into the mixer stage of the tuner. 3.08MHz and 4.08MHz mark the limits of the receivers' color response, and

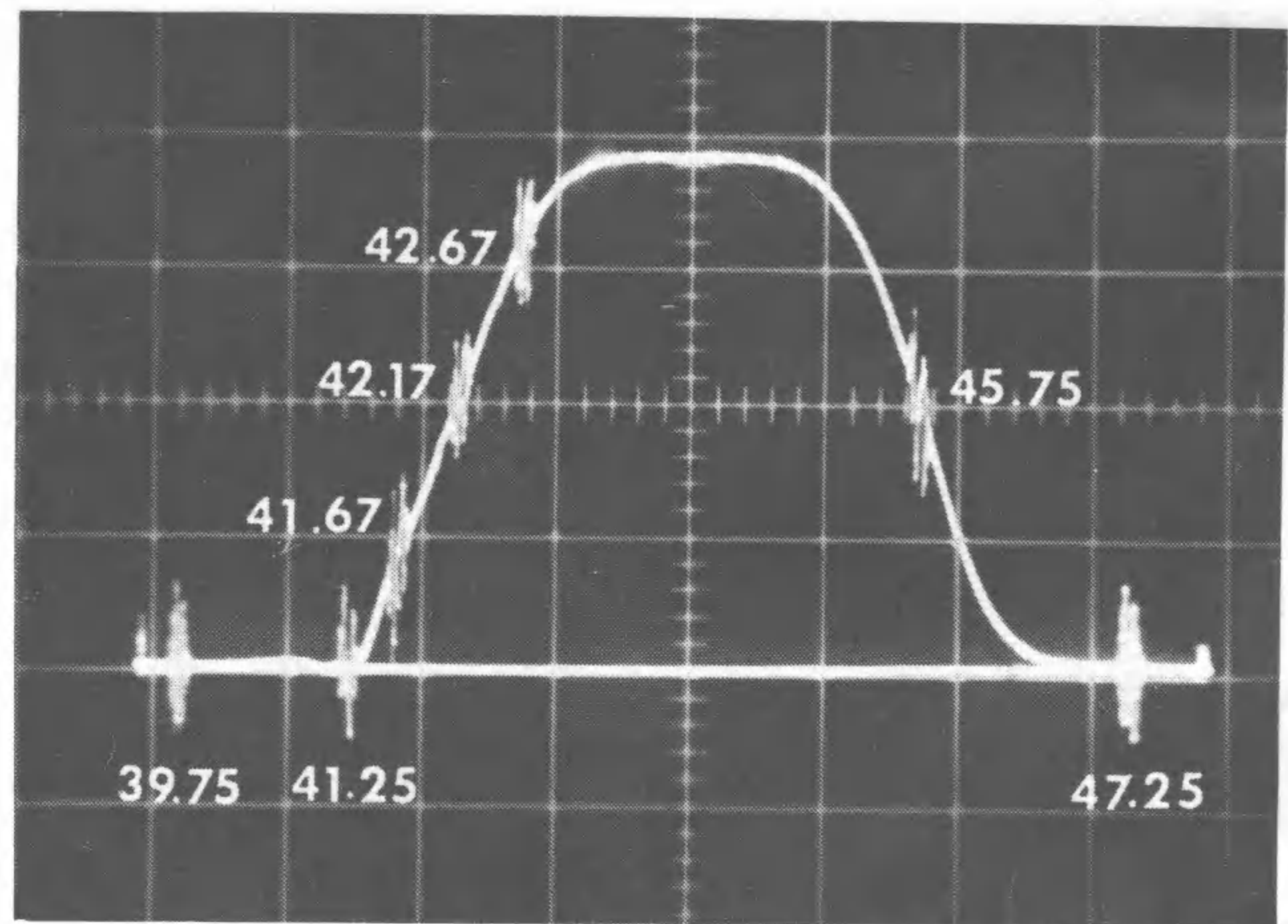

Fig. 19. Ideal IF response curve of color receiver.

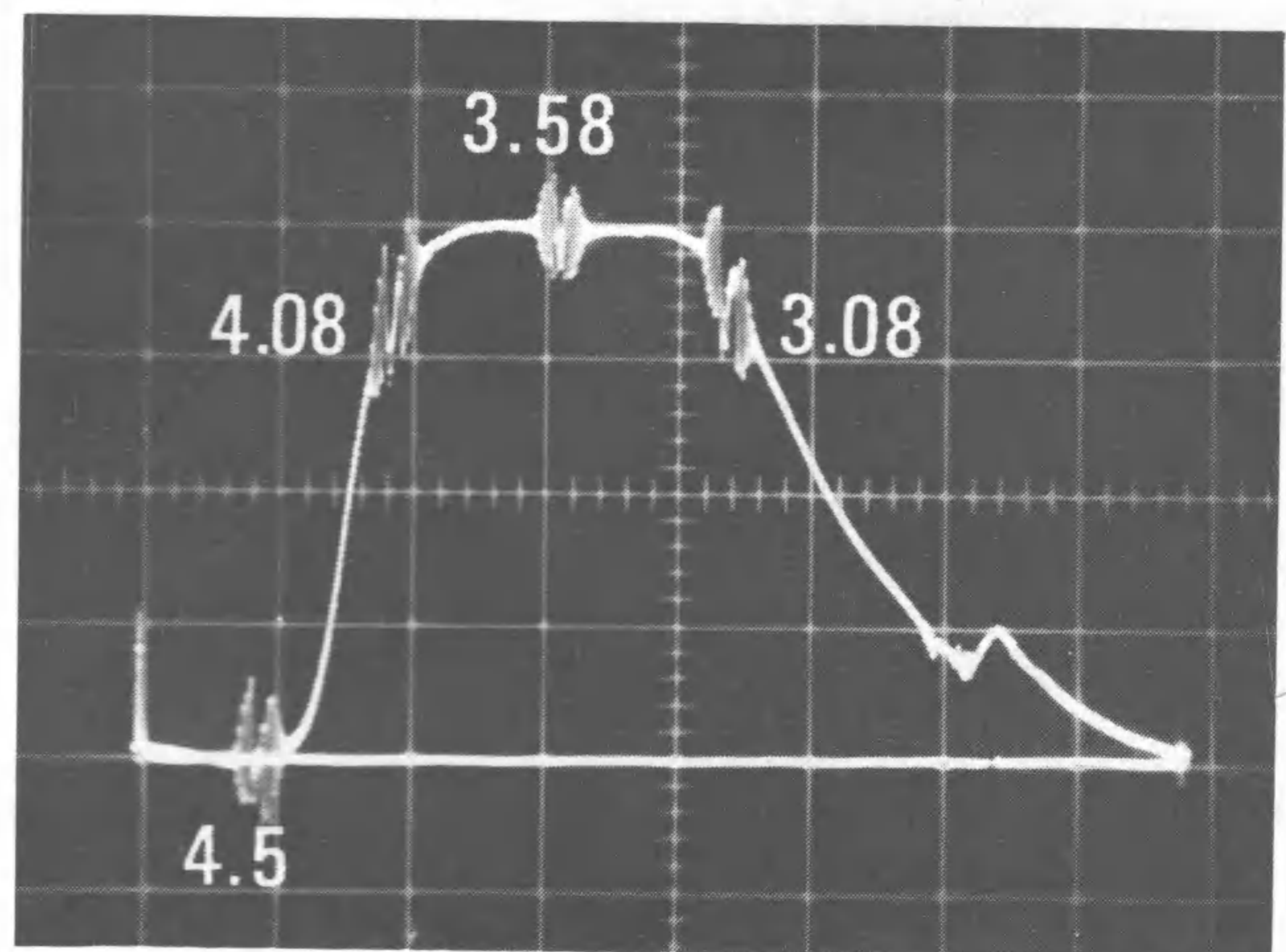

Fig. 20. Ideal chroma response curve.

they should fall at the 80% points on the curve as shown. The color carrier 3.58MHz is shown properly centered on the top of the response curve. The sound carrier (4.5MHz) is on the base line, indicating proper trap action.

STEREO AND TV TRIGGERING

One stereo signal that is difficult to trigger on properly is the LEFT or RIGHT multiplex signal from the SG165 Stereo Analyzer. To observe this waveform with proper stability it is suggested that the PS29 EXT TRIGGER be used. Simply connect the EXT TRIG input on the PS29 to the receiver speaker lead and switch to EXT SYNC. On TV sets where the sync pulses are low or those sets where the sync bars are blanked out as they pass through the color section, it is suggested that the PS29 be set to EXT SYNC and a wire from the EXT TRIG jack be laid next to the TV. This will pick up enough 15,750 signal to lock solid for stable display of the TV signal.

CIRCUIT DESCRIPTION

HV POWER SUPPLY AND CRT UNBLANKING

The PS29 incorporates a 2000 volt high voltage, regulated power supply of advanced design, normally found only in much higher priced equipment. Instead of a 60Hz supply with all the inherent problems of high voltage breakdown and large physical size, the PS29 uses an oscillator supply operating at 100KHz. The smaller physical size of the 100KHz transformer and capacitors results in a savings in weight and increased reliability.

TR204 and the primary of T201 are the active components of the oscillator circuit. Resonance at 100KHz is determined by the capacitance and inductance of TR201 primary winding. One secondary of T201 provides CRT cathode voltage of -2000VDC. The high voltage AC is rectified by CR208 and filtered by C210 - C214. High voltage DC is provided to the CRT filament through R224. This voltage maintains zero potential between CRT cathode and filament. A series of resistors including R226 - R230 and the focus control provide CRT focus voltage and also a feedback path to the input of the high voltage regulator transistor TR203 which controls the bias on the high voltage oscillator TR204.

Should the high voltage potential decrease, this change is felt as a more positive bias on TR202. TR202 conducts more which in turn increases forward bias on TR203. TR203 conducts harder to place a more positive bias on TR204 causing the oscillator to run harder. T201 secondary then provides higher AC potential which raises the high voltage DC potential to a quiescent level determined by the setting of the HVAdjust Control R201.

When the PS29 has been operating and is turned off and immediately turned on again the CRT is hot and at that time operating with positive bias because there is no high voltage. This extra load may cause the high voltage oscillator to not start oscillating. TR204 would be carrying excessive current and would burn out, except, we have provided a protection stage, TR201, which removes the excess load of the CRT and allows the oscillator to function normally. If the oscillator does not function, excessive current is drawn through TR204 and R209 which biases TR201 on. A positive potential developed across R210 is felt at the emitter of TR207. TR206 is turned off and TR208 is turned on which in turn shuts off TR209 and turns on TR210. With TR210 on, R246 is placed at ground potential which removes the positive bias on the CRT grid and consequently removes the load

on T201 which allows TR204 circuit to break into oscillation. TR201 is then biased off returning the op-amp regulator to normal operation. CR206, CR207 and R223 constitute a protection circuit which will not allow the CRT grid to become positive with respect to the cathode, should the grid high voltage rectifier circuit fail.

The other secondary of T201 provides approximately -2050 volts for the CRT control grid. This supply is floating so that unblanking and intensity control can be applied to the CRT grid. Control is accomplished through an op-amp composed of TR206, TR208, TR209, TR210 and associated components. Control point from this network is located at the junction of R246 and the collectors of TR209 and TR210.

Intensity is controlled by a negative voltage from the INTENSITY control on the front panel applied to the emitter of the grounded base op-amp driver, TR107. A current level through TR207 and TR206 determines the conduction of TR209 which in turn determines the positive potential at the control point (R246). A feedback loop through R247 to the base of TR206 and TR208 determines the conduction of TR209 and TR210 to bring the control point (R246) to a quiescent point determined by the INTENSITY control setting. The control voltage from TR209 and TR210 is coupled to the high voltage supply through R246 controlling the bias on the CRT grid.

ASTIG ADJ Control, R237, provides approximately 120VDC to CRT grids 2 and 4 for astigmatism adjustment.

Unblanking of the CRT during trace time is accomplished through TR205 and TR211. The waveform from the unblanking circuit on the time base board is composed of positive and negative pulses approximately around zero reference. The positive portion of the waveform causes TR205 to conduct which reverse biases TR207 causing a negative pulse at R246 which blanks the CRT during retrace. The negative going portion of the unblanking waveform shuts off TR205 and turns on TR211 which forward biases TR207. This produces a positive pulse at R246 which is DC coupled to the CRT grid to unblank the CRT during trace time.

Z Axis, trace intensity, modulation is accomplished by injecting the modulating signal into the Z Axis jack on the back of the PS29 case. This signal is fed through C217 and R232 to the CRT bias op-amp driver TR207. The modulating signal then controls bias of the CRT grid to display intensity modulation corresponding to the waveform of the Z Axis signal.

LOW VOLTAGE POWER SUPPLY

The Low voltage power supply uses full-wave rectification of AC from T1 to provide regulated plus 25 volts and minus 25 volts and unregulated plus 30 volts and plus 240 volts. The plus and minus 25 volt supplies are voltage regulated up to approximately 280 milliamps of current load and are short protected. A short across either supply will cause that voltage to drop to zero and current limiting circuitry will limit short circuit current to approximately 50 milliamps. Now let's follow the circuitry. CR303 and CR304 provide rectification for the positive 25 volt regulated supply. Filtered DC from C302 is provided through R301 and TR302, regulator transistor, to the supply output. R310 provides output voltage adjustment. TR303 and TR304 are arranged in a differential amplifier configuration to give regulation control over TR302. Let us now assume a heavier load is applied to the supply output causing the voltage to decrease. This decrease in voltage is felt on the base of TR304 causing it to conduct less. Since TR303 is fixed biased by zener diode CR307, TR303 must conduct more current through the base-emitter junction of TR302. This causes TR302 to conduct heavier, supplying more current to the load and raising the output voltage to the quiescent level established by voltage adjustment, R310. R305 and C403 are included in the differential amplifier circuit to reduce regulator gain at high frequencies to prevent oscillation.

Current limiting is accomplished by R301, R302, R307 and TR301. Should a short circuit load be applied to the supply, excessive current will momentarily be drawn through R301 which will bias TR301 into heavy conduction. This places less forward bias on TR302, causing it to reduce conduction and limit the load current to approximately 50 milliamps. Current will continue to be drawn through R301, R302 and R307 to maintain conduction of TR301 for the duration of the short circuit load, thus preventing damage to the supply circuitry.

DC voltage is provided for the negative 25 volt regulated supply from CR305, CR306 and C303. The negative voltage adjusted is R321. The negative supply regulator operates exactly as the positive supply regulator, only with the voltage polarities reversed.

CR308 and CR309 are protection diodes used to prevent voltages of opposite polarity from feeding back into their respective supplies should a circuit failure occur.

C305 and C306 filter high frequencies to ground to prevent possible oscillation if high frequencies should happen to be fed back to the supply from other circuits.

VERTICAL AMPLIFIER

The signal at the front panel VERT INPUT jack is coupled to the input of the vertical amplifier through the INPUT COUPLING switch. When this switch is in the DC position the signal is direct coupled to the vertical amp. In the AC position the signal is AC coupled through C1, a .1mfd capacitor, to the input of the vertical amp. In the GND position, the input signal is grounded through C1 and R1, while the vertical amp input is tied directly to ground.

Once inside the vertical amp, the input signal must be attenuated to a level that will not overdrive the FET inputs. The attenuation ratios are: 1:1, 10:1, 100:1, and 1000:1, and are selected by SW101A and SW101B. The capacitors in the attenuators are used for frequency compensation. C102, C108 and C112 are low frequency compensation adjustments while C103, C109 and C113 are used for high frequency compensation adjustment. The input FET TR102A is connected, along with TR101, as an augmented source follower to match the 1 meg input impedance to the low impedance transistor circuitry. TR102A is protected by CR101 and CR102 which clamp the input to plus and minus 8.2 volts. Augmented source follower TR102B along with R2, DC BALANCE control, provide a DC reference for the balanced differential amplifiers which follow. TR105A and TR105B are balanced differential current amplifiers which provide the push-pull signal to drive the voltage amplifiers which follow. TR104, the constant current source provides a fixed amount of current for TR105A and TR105B. As a signal from TR102A causes TR105A to conduct more current, TR105B must conduct less because of the fixed amount of current available from TR104. This action provides the push-pull signal from TR106 and TR110 needed to drive the succeeding voltage amplifiers. DC balance of TR105A and TR105B circuit is provided by a DC level to the base of TR105B from TR103. This level, adjusted by R2, DC BALANCE, is used to maintain stable trace position with no signal input, while changing GAIN switch positions. The GAIN switch, while selecting the proper input attenuator, also selects resistors between the emitters of TR105A and TR105B to change the gain of this stage in accordance with the display sensitivity selected.

Vertical position is provided by R138, R3A VERT POS control and R145 between collectors of TR105A and TR105B which changes the DC level from TR106 and TR110 by changing the bias condition on those transistors.

The first stage of voltage amplification takes place in TR107, TR108, TR109 and TR111. Part of the signal from TR111 collector is used to drive TR112 from

which the signal is taken to provide sync signal to the SYNC SELECT switch. A voltage divider consisting of R3B and R4, ganged to VERT POS control, provides a compensating bias to the base of TR112 to maintain a constant DC operating level of TR112. This prevents the trace from blinking off when vertical trace position is changed, due to the charge and discharge time of coupling capacitor C134.

Voltage drive signal from TR108 and TR111 is applied to the bases of TR114 and TR116, the output driver transistors. TR115 is a constant current source supplying the output stages. As a positive signal is applied to TR114, a negative signal is applied to TR116. TR114 will conduct more current through TR113, output transistor, and TR116 will conduct less current through TR117 maintaining push-pull signals provided to the CRT vertical deflection plates.

Bias control R170 is provided to adjust the DC operating current of the output stage and will be covered in the calibration section of this manual.

TIME BASE SYNC AND TRIGGER

The INT-EXT line switch located on the front panel selects the source of the sync signal while the polarity switch selects either the positive or negative portion of the signal for triggering of the sweep. In INT position of the sync switch the sync signal is taken from the vertical amplifier board, using the displayed signal as the trigger source. In the EXT position a signal may be applied to the EXT TRIG jack and used as a trigger source. In the LINE position a small 60Hz AC voltage is used for triggering the sweep. Let us assume the INT position is selected and the polarity switch is in the + position. The signal used for sync will be the signal applied to the VERT INPUT. This signal from the vertical amplifier is applied to the gate of TR401A while the gate of TR401B is grounded through R423. TR401 through TR408 comprise an augmented source follower - differential amplifier similar to the input stages of the vertical amplifier. The output taken from the collector of TR406 will always be positive regardless of the sync signal polarity selected. This amplified signal from TR406 is fed through the 3.58MHz and VARISPEED switch SW401A to either the sync separator TR409 (with TV VERT or TV HORIZ button pushed) or to the shaper Schmitt trigger TR416 with the VARISPEED button pushed. First let's follow the signal with the TV VERT button pushed. The signal is fed to the base of TR409, sync separator, through C414 and R428. The positive sync signal is amplified and inverted from the collector. The inverted vertical sync pulses are integrated by R432, C417, R433 and C418 and again inverted by TR411. The positive

integrated vertical pulses are fed through C419 to the shaper Schmitt trigger TR416 by way of the TV VERT switch. With the TV HORIZ button pushed differentiated horizontal sync pulsed from TR410 are fed to the Schmitt trigger TR416.

The Schmitt trigger, comprised of TR416, 417 and associated components, produces a square wave at the same rate as the sync signal applied regardless of the sync signal waveform. A trigger point on the positive going sync signal causes TR416 to start conducting, decreasing the conduction of TR417. The positive feedback from TR417 to TR416 hastens the switching, causing TR417 to cutoff rapidly. At the appropriate point on the negative going portion of the sync signal the action is sharply reversed turning on TR417. This square wave is fed to the next Schmitt trigger TR418 and TR419 which controls the ramp generator.

SWEEP GENERATOR

Schmitt trigger TR418, TR419 and complementary emitter followers TR420 and TR421 is actually a bi-stable multivibrator. A positive trigger pulse fed into the base of TR418 flips the circuit to a positive DC level output from the emitter followers TR420 and TR421. This positive level is fed to Ramp Generator transistor TR424 turning it off. TR425 is turned on momentarily by a pulse through C434. This pulls the cathode of CR419 negative which allows the timing capacitor, selected by SW402B, to charge through TR429 and its emitter resistor, selected by SW402C, back to -25 volt supply. This capacitor charging produces the linear negative going ramp (sweep). This ramp is applied to a P-channel FET, TR430, connected as a source follower. The output from this stage goes to three circuits. First the sweep is fed to the sweep output transistor where it is inverted and fed to the SWEEP OUT jack on the rear panel of the scope. Second output is to the reset transistor, TR422, which turns on at the end of the sweep and resets the Schmitt trigger, turning on TR424. This allows the timing capacitor to discharge in preparation for another sweep. The third sweep output goes to the sweep output amplifiers through SW601A and 601B. CRT unblanking pulses are taken from TR418 to the high voltage board to unblank the CRT during sweep time. The sweep output amplifiers are theoretically similar to the vertical output amplifiers. They are a combination of differential and push-pull amplifiers. Horizontal position is accomplished by R6 which controls the reference level on the base of TR434 while the base of TR435 receives the sweep signal and amplifies and converts the signal to push-pull at the output of TR433 and TR436. Sweep width is adjusted by R516 which controls the gain of the amplifier stages. 5X centering is adjusted by R512 which controls balance of the

differential amps. R517 and 5X Cal, R518, is switched in to increase amplifier gain during use of the 5X function. Operating current levels in the output stages are adjusted by Bias adjustment R529 which controls the current available from the constant current source TR439 thus determining the operating level of the output transistors. These adjustments will be covered in the calibration procedure.

AUTO BASELINE

Auto baseline circuitry is provided to give a sweep presentation in the absence of a sync signal. This circuitry consists of TR412 through TR415 and associated components.

Positive sync pulses from TR417 are coupled to the base of TR412 where they are amplified, rectified and a positive DC level is fed to TR413 which turns on, flipping the Schmitt trigger, TR414 and TR415. With TR415 in an on state a negative voltage is present at the stability control, R463. This voltage, applied to the base of TR418 through CR418 and R468, holds TR418 in a triggerable state which prevents a free running sweep.

In the absence of input signal no pulses are fed to TR412. TR413 turns off and the Schmitt trigger, TR414 and TR415, flips to the opposite state. TR415 turns off and a slightly positive voltage is felt at R463. This positive voltage biases TR418 to the point where the trigger circuit and ramps generator will free run giving a sweep on the CRT.

EXT. HORIZONTAL, VECTOR AND 60Hz

With the VECTOR button pushed, an external signal may be used for vector display or for external horizontal sweep such as used with Sweep Generator alignment equipment.

The vector or horizontal signal is fed through the 2-20 volt switch located on the front panel, either direct in the 2 volt position or through a 10:1 attenuator in the 20 volt position, to the VECTOR switch SW601B and on to the External Horizontal Amplifier. This amplifier consists of TR427, TR428 and associated circuitry. CR421 and 422 are protection diodes for TR427, source follower. R489 is the External Horizontal sweep amplitude control. This control is ganged with the Sweep Speed Vernier located as the center knob of the Time Base switch. This control determines the signal level fed to TR428 and thus the signal level sent to the output amp and on to the CRT horizontal deflection plates.

With the SWEEP GEN 60Hz button pushed 60Hz AC voltage is sent to the External Horizontal Amplifier and the output amplifier and presented as a sweep trace on the CRT. The phase of this 60Hz AC voltage is adjustable by means of R5, SWEEP GEN PHASE SET screwdriver adjustment located on the front panel.

CALIBRATION

POWER SUPPLIES LOW VOLTAGE

1. Connect a meter, set for + DC volts, between ground and the cathode of CR308.
2. Adjust R310 for a meter reading of +25VDC.
3. Connect the meter, set for - DC volts, between ground and the anode of CR309.
4. Adjust R321 for a meter reading of - 25VDC.

HIGH VOLTAGE

CAUTION: DISCONNECT POWER BEFORE PROCEEDING.

1. Connect a meter capable of measuring over 2000 VDC between ground and the junction of R224 and C211.

2. Turn on power and adjust R201 for a meter reading of - 2000VDC.
3. REMOVE POWER! -- Reconnect meter ACROSS R225 and set meter range to read at least 10 volts DC.
4. Reconnect power and push the VECTOR switch on the PS29.
5. Turn INTENSITY control fully clockwise.
6. Adjust R214 for a meter reading of 9.6VDC.
7. REMOVE POWER! -- Disconnect the meter from the high voltage circuitry.

ASTIGMATISM

1. Connect the vertical input through the low cap probe, 39G80, to the white or red wire from the right hand grid light to the terminal strip mounted on the CRT shield chassis.

2. Adjust scope vertical and horizontal controls for a presentation of approximately 3 cycles, 6cm peak-to-peak on the scope.
3. Adjust the intensity for a normal viewable presentation.
4. Adjust the FOCUS Control and R237 for the most uniform trace thickness across the screen.

VERTICAL AMPLIFIER DC BALANCE

NOTE: It is not necessary to remove the PS29 from its case to adjust DC BALANCE. A mis-adjustment of the DC BALANCE will result in a position shift of the trace as the vertical GAIN switch is switched in the 1, 2, 5 sequence.

1. Depress the VARISPEED button, adjust the VARISPEED switch to the 1 mSec position and set the INPUT switch to the GND position.
2. Set the GAIN switch to the .5 position and center the trace on the major horizontal grid line with VERT POS Control.
3. Switch the GAIN switch to the .1 position and adjust DC BALANCE Control to bring the trace back to the reference line.
4. Switch the GAIN switch back to the .5 position and check that the trace is on the reference line. If not, repeat steps 2 and 3 above.

OUTPUT BIAS

1. Set input switch to GND position.
2. Measure the DC voltage at the collectors of TR113 and TR117 and adjust the VERT POS Control until both collectors indicate equal voltage.
3. Using a meter set to read +300VDC, measure B+ voltage at the junction of R165 and R166 and note this voltage.
4. Place the meter probe back on the collector of TR113 and adjust R170 until the meter reads 100 volts less than the reading noted in step 3 above.

VERTICAL CALIBRATION

The vertical amplifier calibration adjustments (R127, R131 and R134) are vertically mounted at the edge of the vertical amplifier PC board. Access to these controls for adjustment is left side of scope, lower

edge of the vertical PC board. All that is necessary to calibrate the PS29 vertical amplifier is an accurate DC voltage source.

1. Depress the VARISPEED button, adjust the SPEED switch to 1 mSec position, turn the center knob of the GAIN switch fully clockwise and set the INPUT switch to the GND position.
2. Connect the PS29 through the low cap probe to the voltage source, adjust the voltage source for 1 volt, adjust the VERT POS Control to center the trace on the major horizontal grid line, and set the GAIN switch to the .5 position.
3. Push the INPUT switch to the DC position and adjust R127 for a trace deflection of 2 divisions.
4. Return the INPUT switch to the GND position, set the GAIN switch to the .2 position and readjust the VERT POS Control if necessary to center the trace on the major horizontal grid line.
5. Push the INPUT switch to the DC position and adjust R131 for a trace deflection of 5 divisions.
6. Return the INPUT switch to the GND position, adjust the voltage source for .5 volts, set the GAIN switch to the .1 position and recenter the trace if necessary.
7. Push the INPUT switch to the DC position and adjust R134 for a trace deflection of 5 divisions.

ATTENUATOR FREQUENCY COMPENSATION

A square wave generator capable of producing a truly square waveform of at least 2VPP at approximately 1000Hz is required to perform the following frequency compensation procedure for the vertical input attenuators.

The first step in compensating the input attenuators on the PS29 is to match the probe compensation to the input capacitance of the vertical amplifier. Proceed as follows:

SYNC	INT
POLARITY	POSITIVE
VARISPEED	.5 mSec
GAIN	.5

DEPRESS VARISPEED BUTTON

SQUARE WAVE GENERATOR:

AMPLITUDE	2VPP
FREQUENCY	1000Hz

1. Use the 39G80 low cap probe to connect the 2VPP output of the square wave generator to the vertical input.
2. Adjust the probe compensation adjustment capacitor for a square wave with a flat top.

10:1 ATTENUATOR COMPENSATION

1. With the 2VPP square wave signal still applied to the vertical input, set the GAIN switch to the 1 position.
2. Adjust C103 for a square corner on the leading edge of the square wave.
3. Adjust C102 to remove any tilt on the top of the square wave.
4. Repeat steps 2 and 3 as necessary to obtain best response to the square wave signal.

In order to adjust the 100:1 and 1000:1 attenuators you will need at least a 200VPP square wave. If you do not have such a signal available, the circuit shown below should provide a square wave good enough for attenuator compensation.

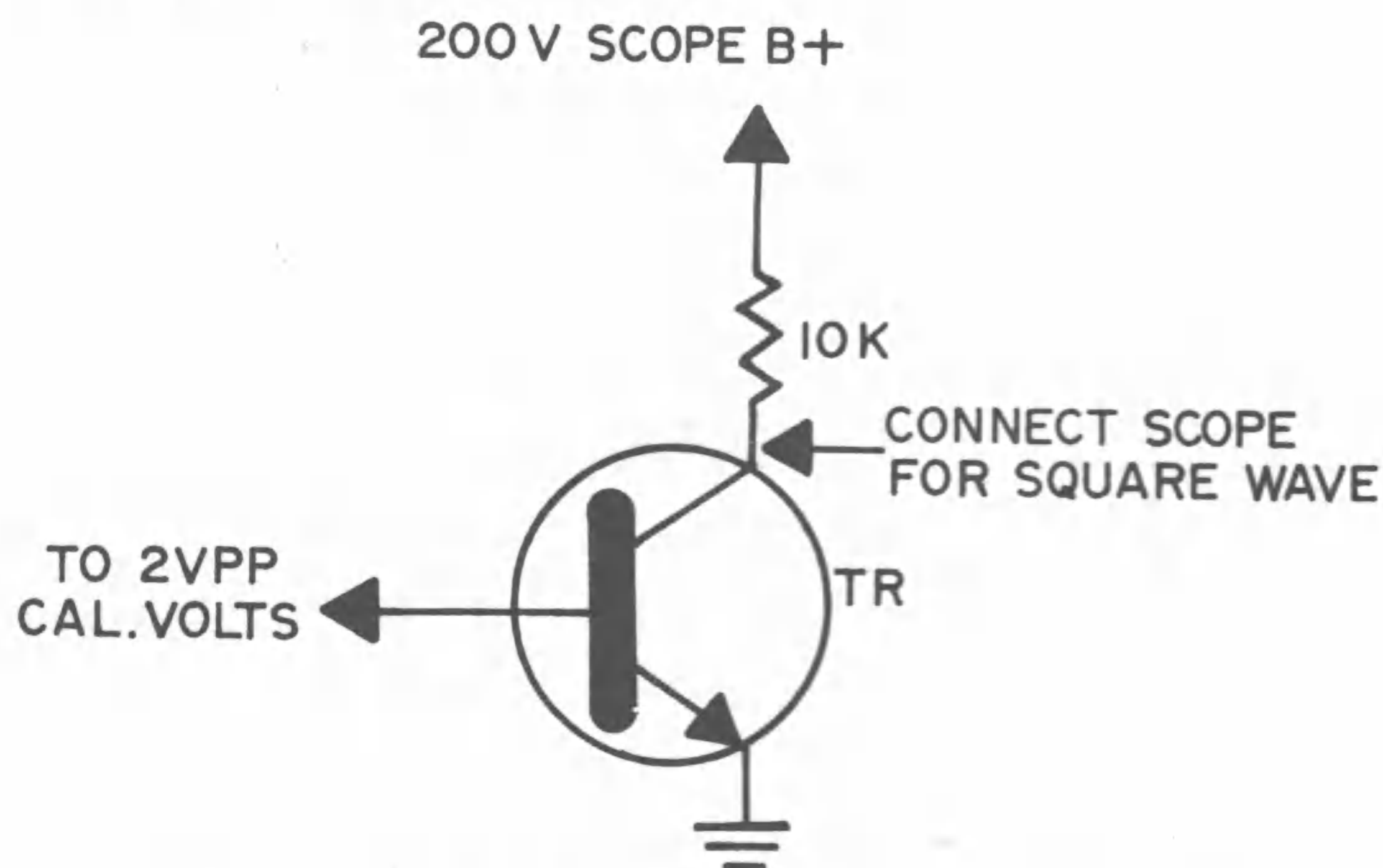

Circuit for 200V PP calibration square wave.

TR is a NPN Silicon with a V_{ce} of at least 200 volts and a power dissipation of 3 to 5 watts. This type is used as the video output transistor in some TV receivers.

100:1 ATTENUATOR COMPENSATION

1. Use the 39G80 probe to connect a 200VPP square wave into the vertical input and set the GAIN switch to the 50 position.
2. Adjust C109 for a square corner on the leading edge of the square wave.

3. Adjust C108 to remove any tilt on the top of the square wave.
4. Repeat steps 2 and 3 as necessary.

1000 : 1 ATTENUATOR COMPENSATION

1. With the 200VPP square wave still applied to the vertical input, set the GAIN switch to the 100 position.
2. Adjust C113 for a square corner on the leading edge of the square wave.
3. Adjust C112 to remove any tilt on the top of the square wave.
4. Repeat steps 2 and 3 as necessary.

TIME BASE SWEEP OUTPUT BIAS

1. Depress the VECTOR button and push vertical input switch to the GND position.
2. Measure the DC voltage at the collectors of TR437 and TR441 and adjust the HORIZ POS Control until both collectors indicate equal voltage.
3. Using a meter set to read +300VDC, measure the B+ voltage at the junction of R524 and R525 and note this voltage.
4. Place the meter probe back on the collector of TR437 and adjust R529 until the meter reads 100 volts less than the reading noted in step 3 above.

TRIGGER BALANCE

1. Connect the vertical input through the low cap probe, 39G80, to the white or red wire from the right hand grid light to the terminal strip mounted on the CRT shield chassis.
2. Set the VARISPEED switch to the 10 mSec position and the GAIN switch for a vertical deflection of $\frac{1}{2}$ cm or less.
3. Push the SYNC polarity switch to the + position and adjust R412 until trace sync is lost then back R412 off slightly until solid sync returns.
4. Change SYNC polarity switch to the - position and adjust R412 until trace sync is lost then back R412 off until solid sync returns.

- Repeat steps 3 and 4 until solid sync is obtained on both + and - positions of the SYNC polarity switch.

STABILITY

- Apply a signal through the low cap probe to the vertical input from the white or red wire on the terminal strip mounted on the CRT shield chassis. (See TRIGGER BALANCE, step 1.).
- Adjust the vertical GAIN switch for a vertical display of approximately 2 cm.
- Disable the Auto Baseline Circuit by grounding the collector of TR413 with a jumper between the collector and emitter of this transistor.
- Push the vertical input switch to GND position and adjust R463 until the baseline trace just appears. Note the physical position of the rotor tab on R463.
- Push the vertical input switch to the AC position and adjust R463 until the trace just disappears and note the physical position of the rotor tab on R463.
- Adjust the position of R463 to $\frac{1}{2}$ the distance between the positions noted in steps 4 and 5 above and remove the jumper wire grounding the collector of TR413.

SWEEP SPEED AND SWEEP WIDTH

Set controls as follows:

INPUT SWITCH	GND
SYNC POLARITY	POSITIVE
SYNC	INT
GAIN	2
VARISPEED	2 mSec
VARISPEED BUTTON	DEPRESSED

- Connect the vertical input to the white or red wire connected to the terminal strip mounted on the CRT shield chassis. (See TRIGGER BALANCE, step 1.).
- Adjust R516 for a trace 11 cm long.
- Push the vertical input switch to the AC position and adjust the HORIZ POS Control so that the waveform crosses the major horizontal grid line at the left edge of the graticule.
- Be sure that the center knob of the VARISPEED switch is fully clockwise and adjust R480 so that one cycle of the 60Hz waveform is 8.3 cm long.

5X EXPAND AND POSITION

Set controls as follows:

VERT INPUT SWITCH	AC
SYNC	INT
SYNC POLARITY	POSITIVE
GAIN	5
VARISPEED	5mSec
VARISPEED BUTTON	DEPRESSED
5X EXPAND BUTTON	RELEASED

- Connect the VERT INPUT to the white or red wire connected to the terminal strip mounted on the CRT shield chassis. (See TRIGGER BALANCE, step 1.).
- Adjust the centerknob of the VARISPEED switch for 5 complete cycles of 60Hz signal in 10 cm.
- Push the 5X EXPAND button and adjust R518 for 1 complete cycle in 10 cm.
- Adjust the HORIZ POS control to position the positive signal peak on the major vertical grid line.
- Release the 5X EXPAND button and adjust R512 to position the positive peak nearest the major vertical grid line right on the major vertical grid line.
- Repeat steps 4 and 5 until the trace does not shift when the 5X EXPAND button is depressed.

CRT TILT ADJUSTMENT

Adjust the front panel controls to produce a clean horizontal trace with no vertical deflection. Loosen one phillips head screw on each side of the front CRT mounting bracket. Rotate the CRT until the trace is aligned with the horizontal grid lines. Retighten the mounting bracket screws.

CONVERSION TO 220VAC

The PS29 is provided with a split primary transformer designed for use with 110VAC or 220VAC operation. It is factory wired for 110VAC operation but can be converted to 220VAC by removing two jumpers and installing one other. Remove the two solid wire jumpers found on the terminal strip just ahead of the fuse holder and place one jumper between the two terminals holding the WHITE and BLK/RED wires.

Replace the fuse with $\frac{3}{4}$ amp standard fuse for 220VAC operation.

DISASSEMBLY INSTRUCTIONS

CASE

The case of the PS29 is in two parts, designed for easy assembly and disassembly. Remove 3 phillips head screws from each side of the case. Lift the top section with the handle straight up and off. Lift the chassis assembly up and out of the bottom section of the case. Reverse this procedure for reassembly.

CRT

Remove the Grid and Vector lights, above the front of the CRT, from their shields by grasping the base of

the rubber boot and pulling straight back. Lay them over the side of the CRT shield chassis. Remove 1 phillips head screw from each side of the front CRT bracket clamp band. Lay the band aside. Remove 2 phillips head screws holding the rear CRT shield - bracket assembly. Lift the rear of the CRT above the chassis enough to remove the CRT socket. With the socket removed lift the CRT back, up and out of the chassis. Reverse this procedure to reinstall the CRT. Refer to adjustment procedure for CRT trace tilt adjustment.

SERVICE PROCEDURES

The PS29 is a complex instrument and repair should only be attempted by a technician qualified and experienced in the repair of miniature solid state electronic equipment.

For those who wish to service their own PS29, we have included a series of trouble charts to help isolate the section in which the problem is located. Included in the manual, are both the component side view and foil side view of the printed circuit boards. The foil side view of the board shows the location of all transistors and adjustments.

To aid in locating a particular component, the PS29 schematic reference numbers have been coded to indicate which section of the PS29 the component is located in.

The coding is as follows:

1 - 99	CHASSIS
100 - 199	VERTICAL AMPLIFIER BOARD
200 - 299	H.V. POWER SUPPLY
300 - 399	L.V. POWER SUPPLY
400 - 599	MAIN TIME BASE BOARD
600 - 699	TIME BASE SWITCH BOARD

TROUBLESHOOTING

NO HORIZONTAL SWEEP
(Normal Vertical Deflection)

Push SWEEP GEN 60Hz button

If sweep appears, trouble is located on time base board in circuits TR418 - TR426 and TR429 - TR431.

If no sweep appears check circuits TR427, 428 and TR434 - TR441.

NO TRACE

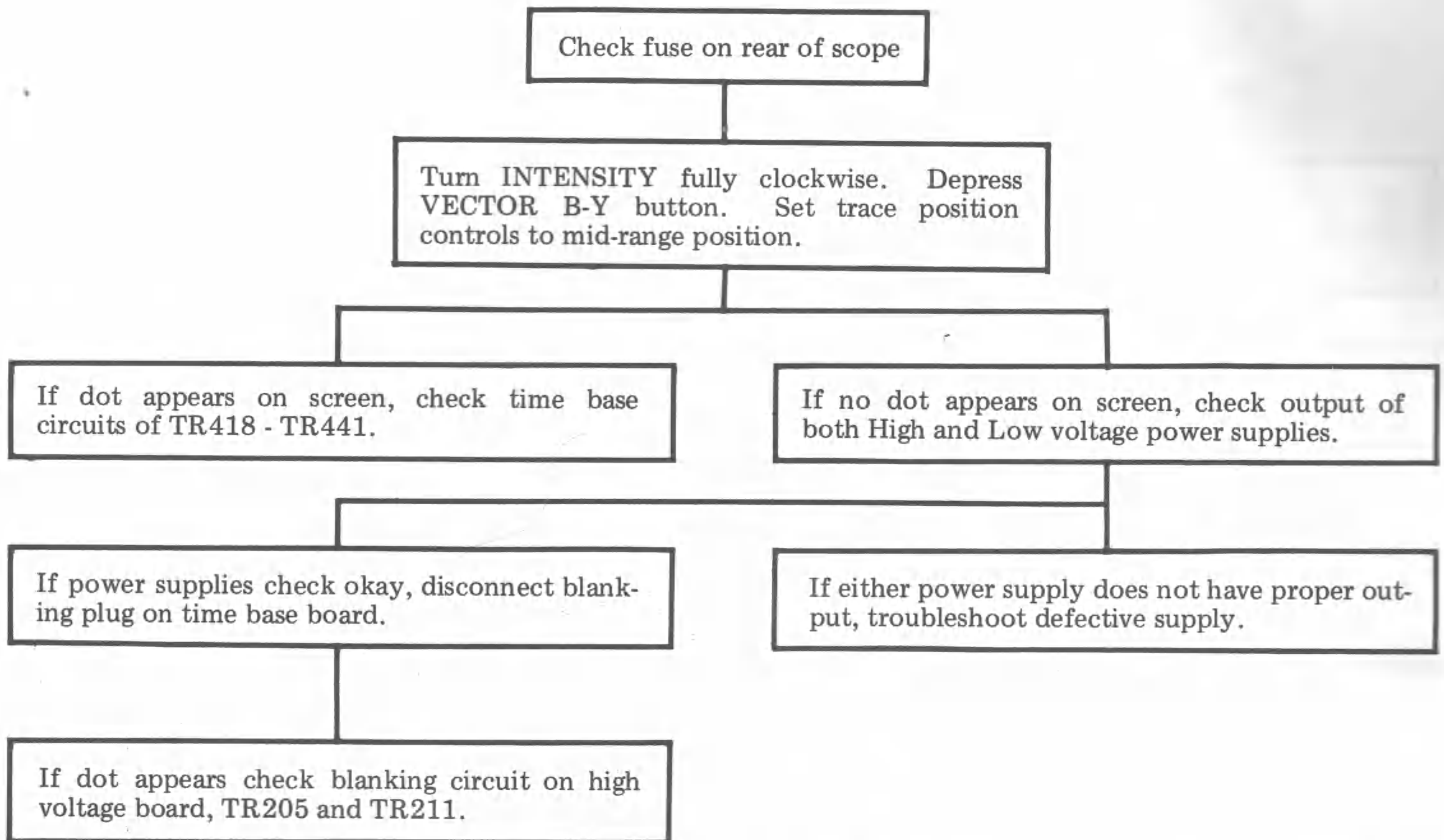
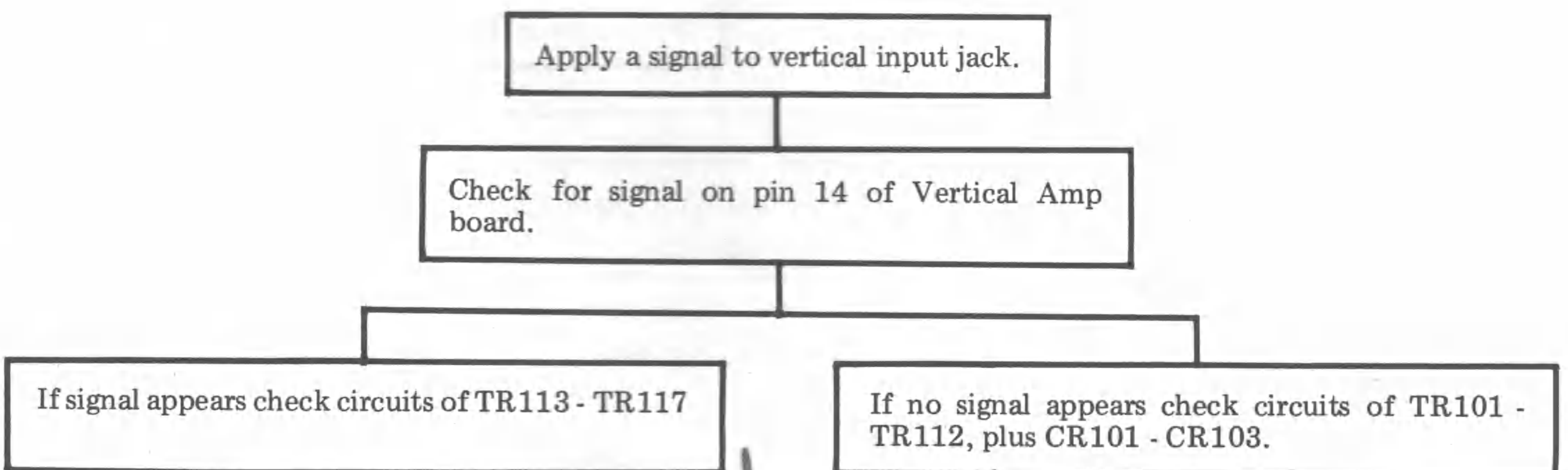
NO VERTICAL DEFLECTION
(Horizontal Sweep Normal)

UNSTABLE SYNC

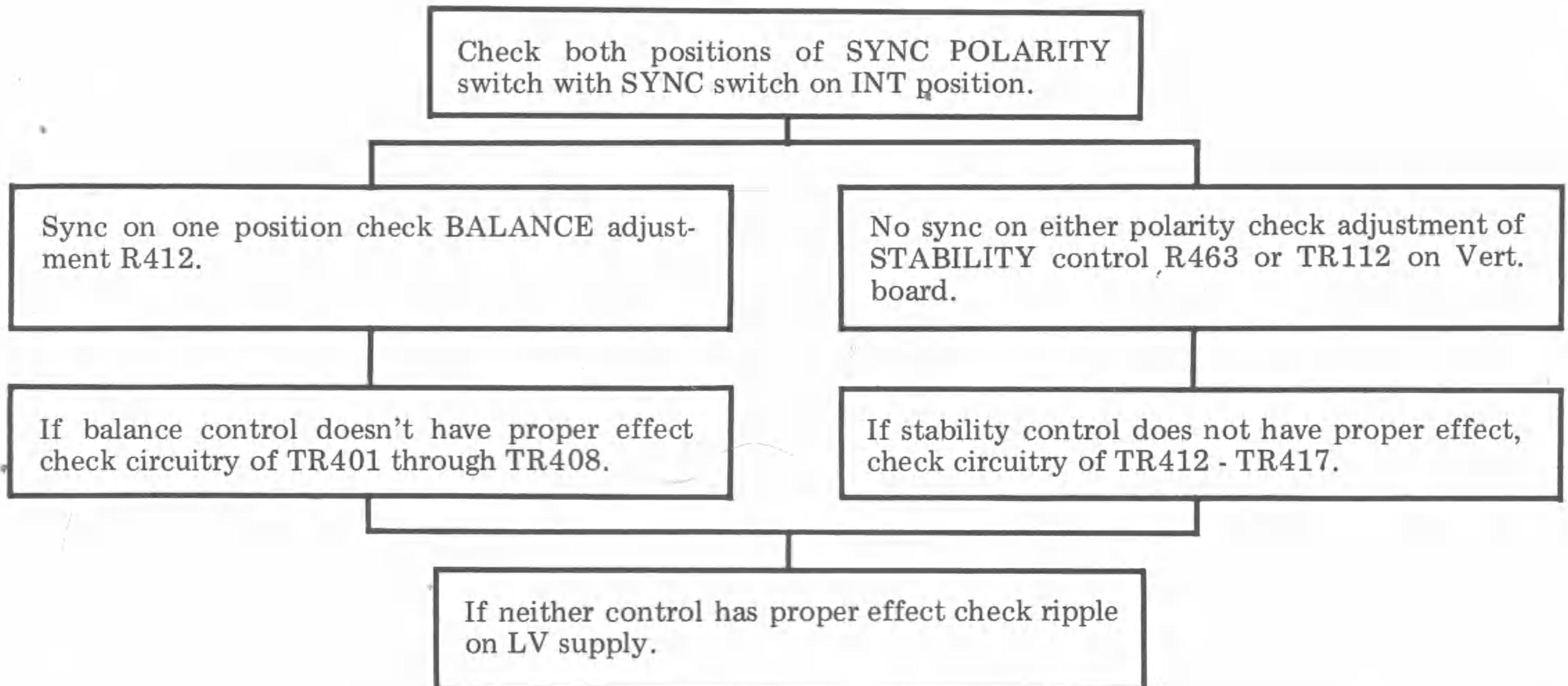
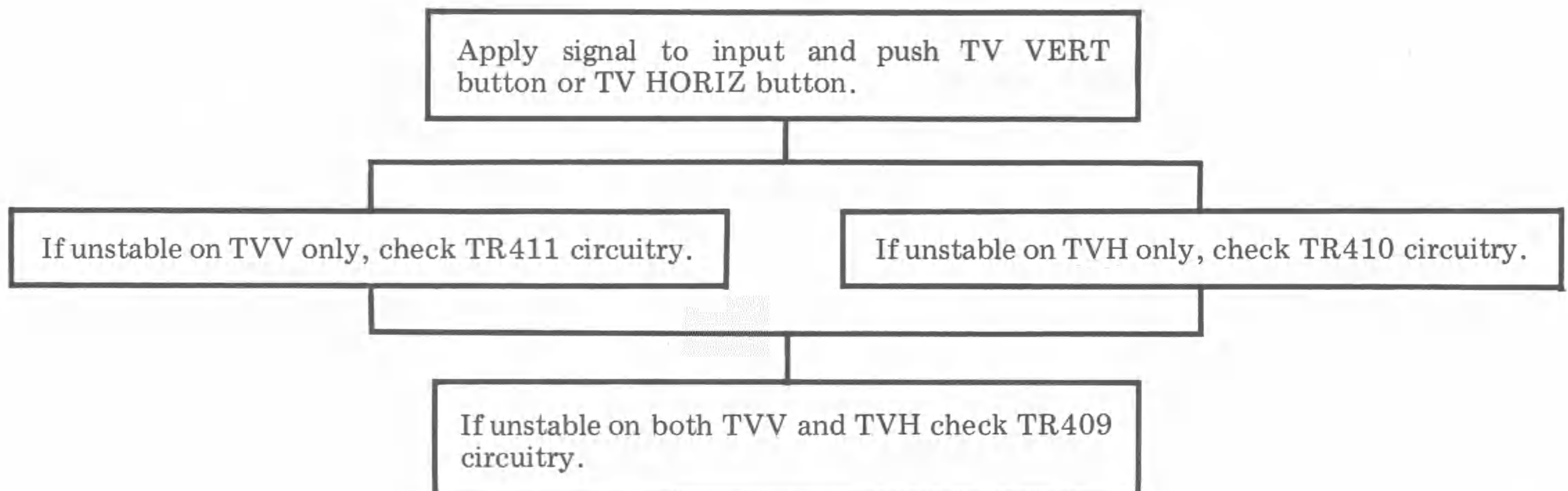
UNSTABLE SYNC TVV OR TVH
(Other Sync Normal)

BOARD LAYOUTS FOR PS29

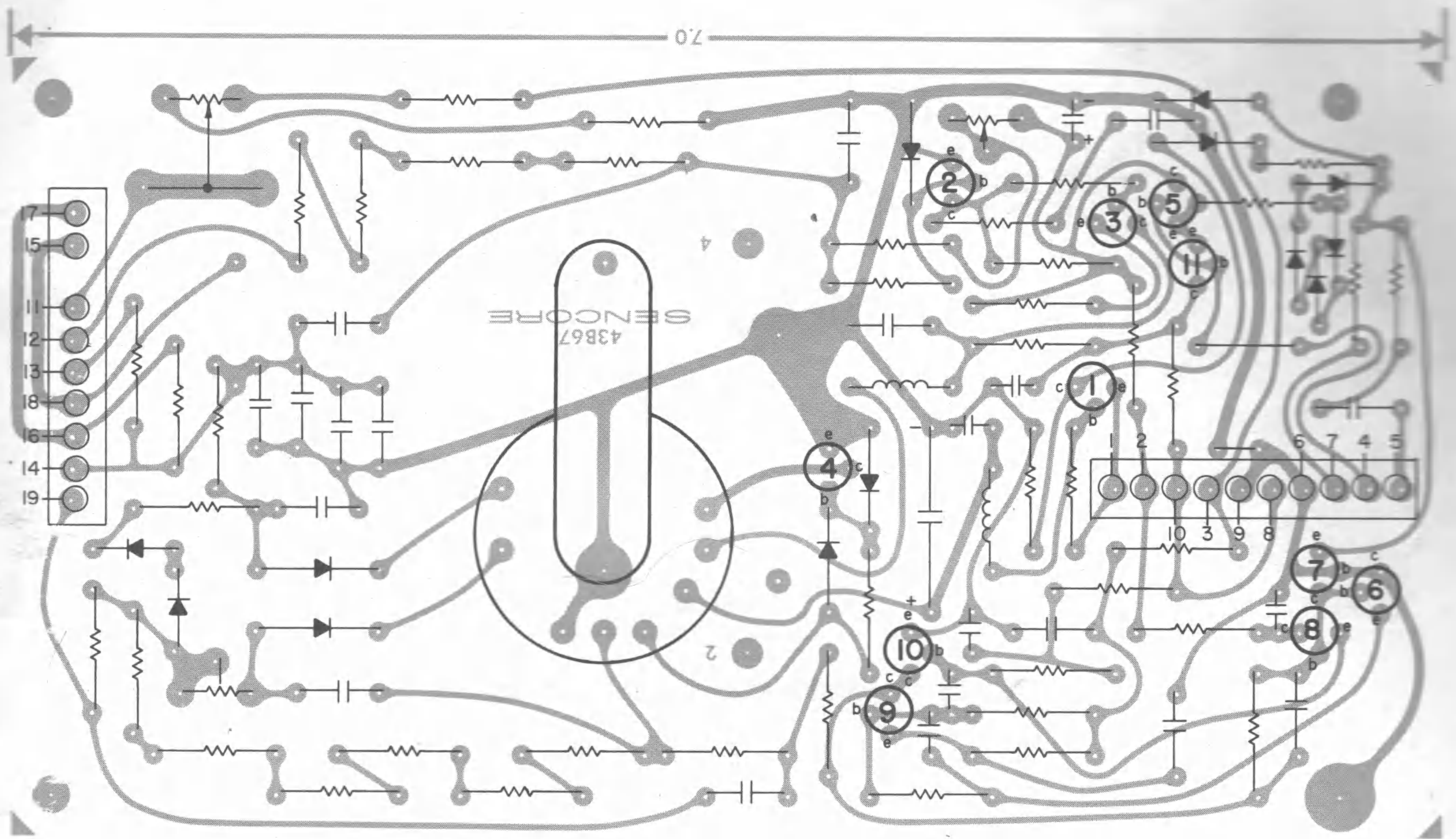

Fig. 21-A. Foil side view with board legend.

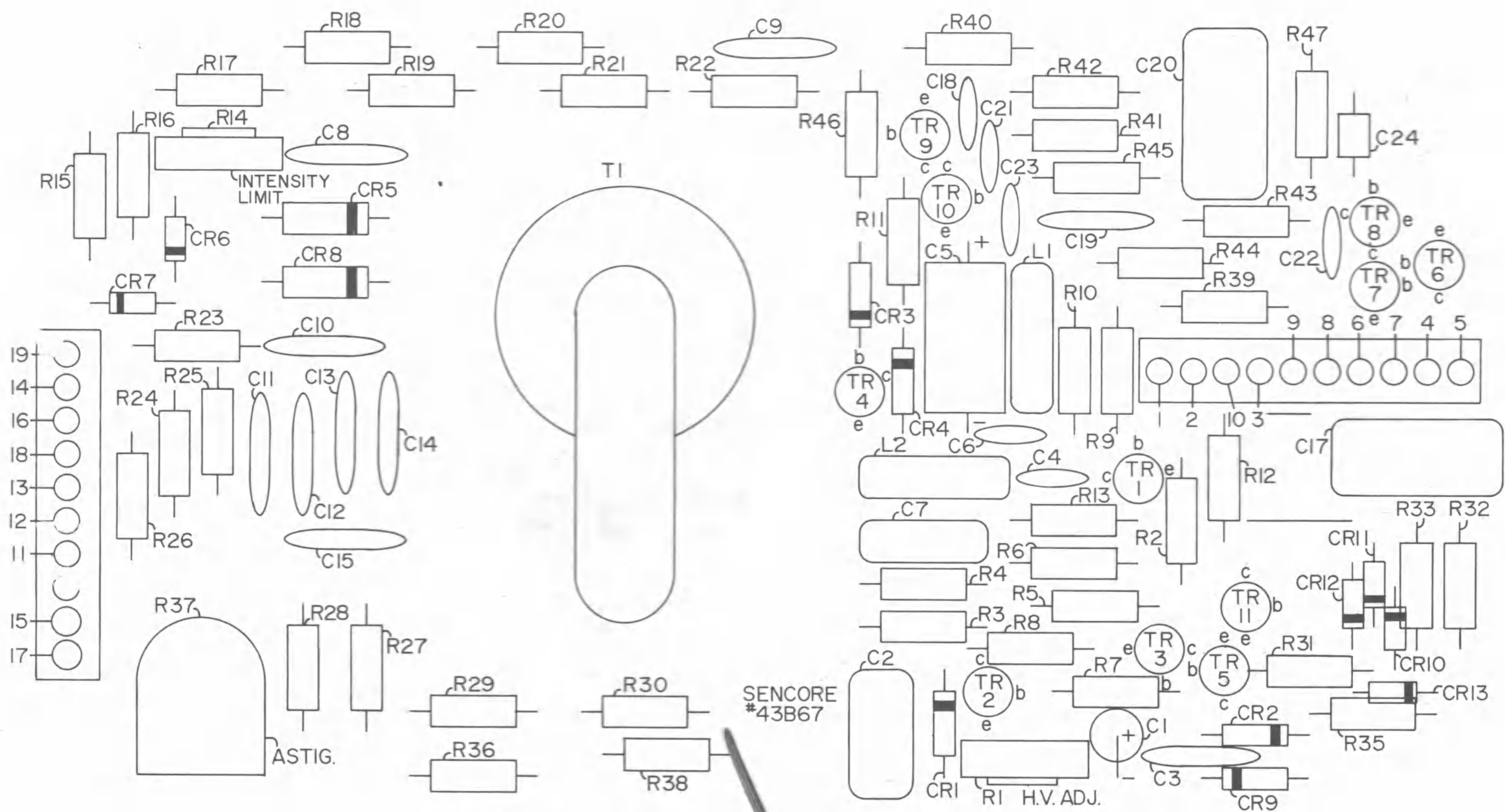

Fig. 21-B. Component side view.

(FOLD OUT FOR BOARD LAYOUTS)

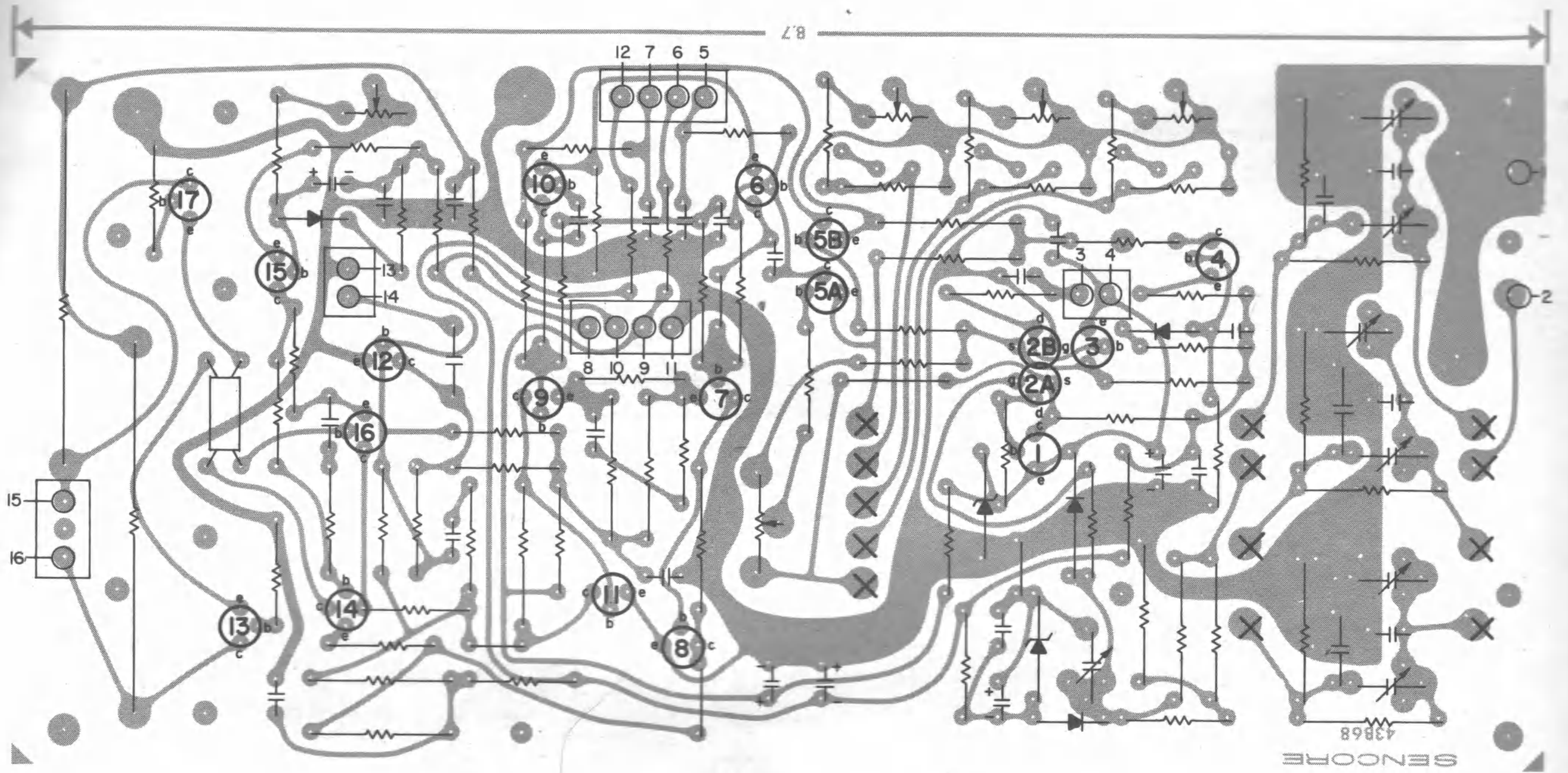

Fig. 22-A. Foil side view with board legend.

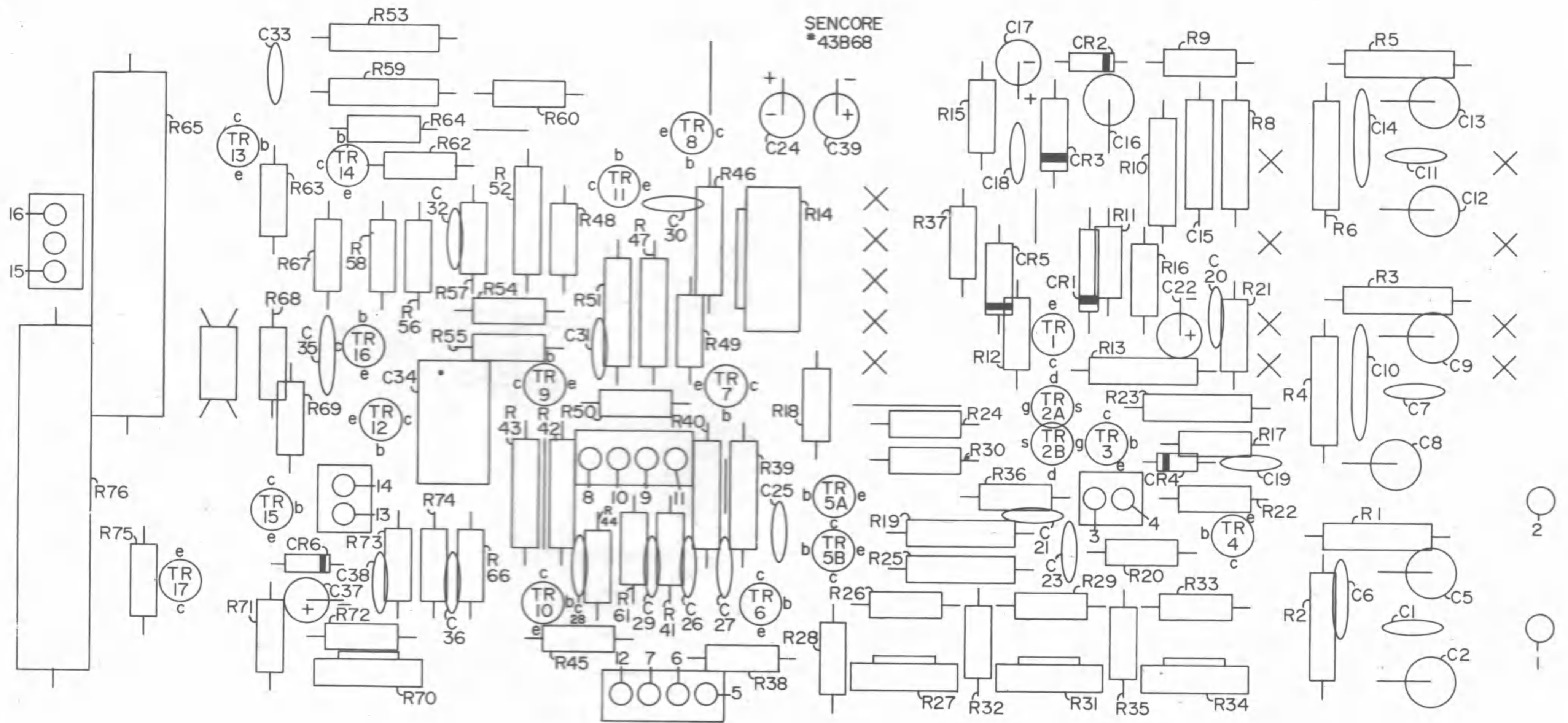

Fig. 22-B. Component side view.

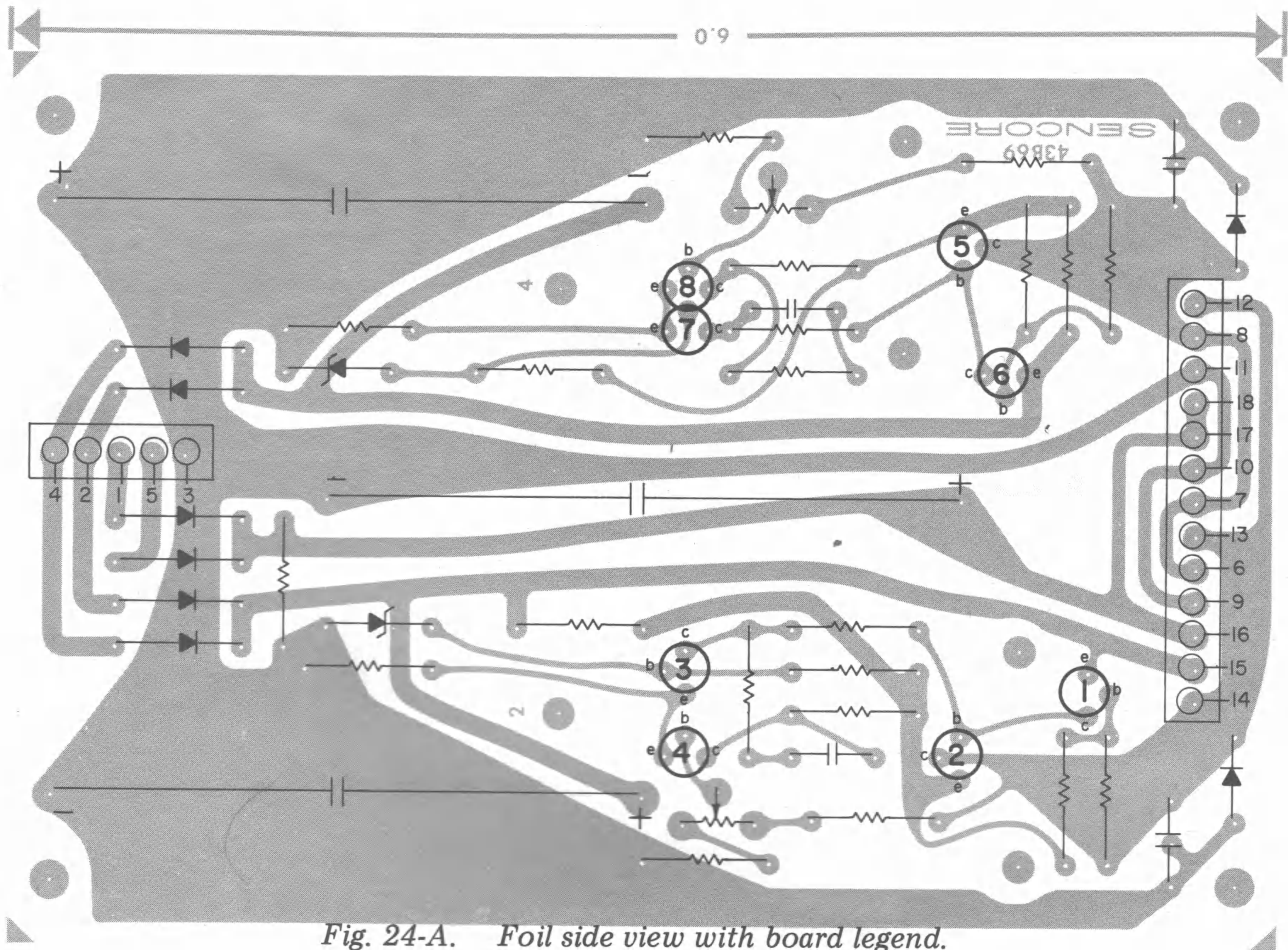

Fig. 24-A. Foil side view with board legend.

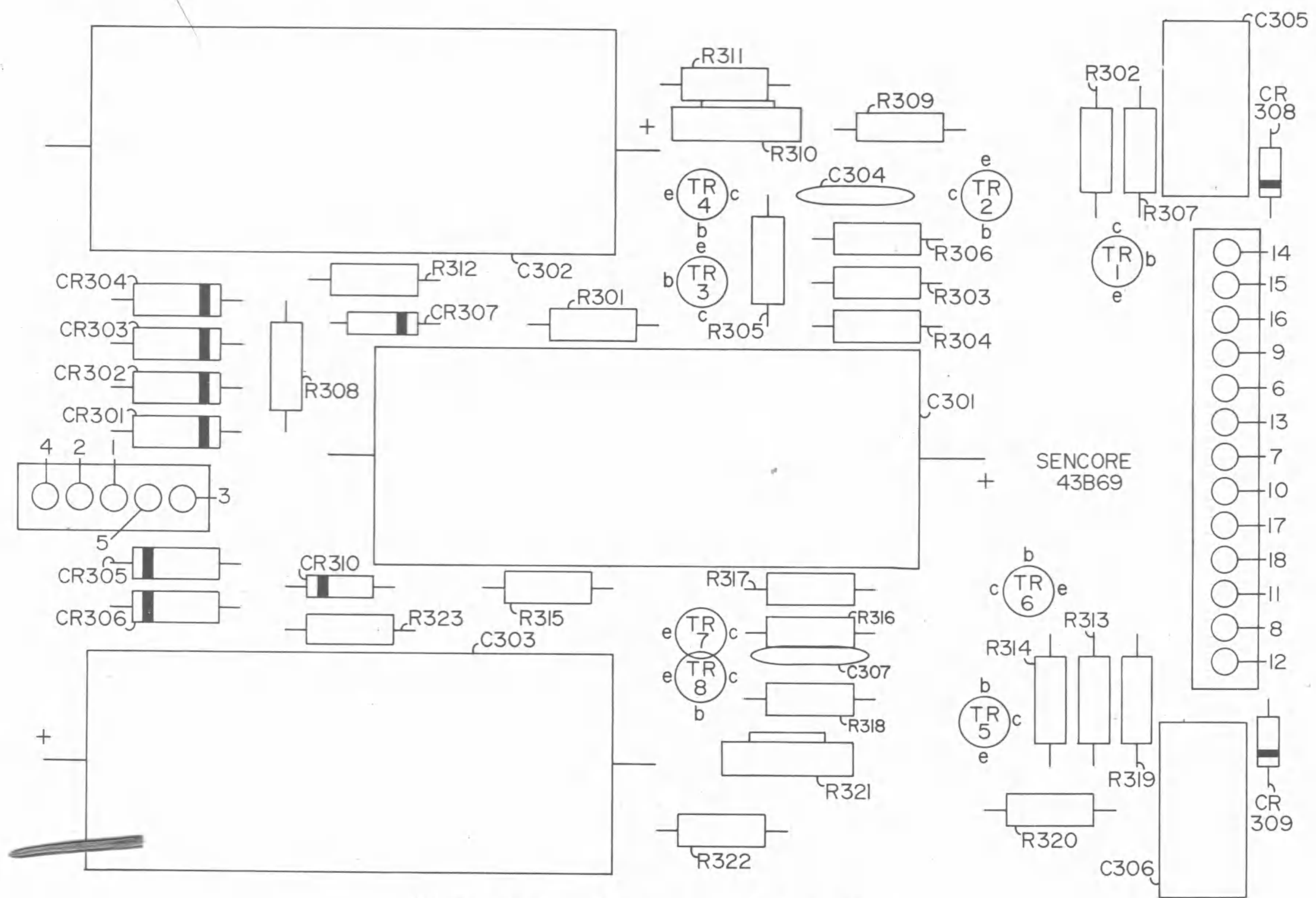

Fig. 24-B. Component side view.

SERVICE AND WARRANTY

You have just purchased one of the finest oscilloscopes on the market today. The Sencore PS29 has been inspected and tested twice at the factory and has passed a rugged use test, by our Quality Assurance Department, to insure the best quality instrument to you. If something should happen, the PS29 is covered by a standard 90 day warranty as explained on the warranty policy enclosed with your instrument.

Sencore has six regional offices to serve you. Instruments to be serviced should be returned to the nearest regional office, by UPS if possible. Parcel Post should only be used as a last resort. Instruments should be packed with the original packing materials or equivalent, and double boxed to insure safe arrival at the regional office. The blue and white display carton IS NOT an acceptable shipping container. When returning an instrument for service, be sure to state the nature of the problem to insure faster service.

If you wish to repair your own PS29 Oscilloscope, we have included a schematic, trouble chart, and parts list. Any of these parts may be ordered directly from the regional office nearest you.

We reserve the right to examine defective components before an in warranty replacement is issued.

SENCORE REGIONAL OFFICES:

Sencore Central East
4105 Duke Street
Alexandria, VA 22304
703 751-3556

Sencore Western
833 Mahler Road
Burlingame, CA 94010
415 697-5854

Sencore Southeastern
2459 Roosevelt Hwy. Suite B-9
College Park, GA 30337
404 768-0606

Sencore Central
2711 B. Curtis St.
Ellsworth Industrial Park
Downers Grove, Ill. 60515
312 852-6800

Sencore Central West
3200 Sencore Drive
Sioux Falls, SD 57107
605 339-0100

Sencore Northeastern
1593 H Central Avenue
Albany, NY 12205
518 869-0996



SENCORE

3200 SENCORE DRIVE, SIOUX FALLS, SOUTH DAKOTA 57107

PS 29 OPERATION ADDENDUM

On higher input frequencies it may be noticed that the displayed signal may have minor trigger jitter on the horizontal plane. This condition is normal for the type of triggering circuit used in the PS29.

This horizontal jitter can be eliminated by rotating the time base calibrate knob slightly counter clockwise out of the detent position and adjusting this control slightly until the jitter disappears. This action will affect time base calibration very slightly but only by a negligible amount.



SENCORE

3200 SENCORE DRIVE, SIOUX FALLS, SOUTH DAKOTA 57107

Form 1037

Printed in U.S.A.

SCHEMATIC AND PARTS LIST

PS 29

MINUTEMAN TRIGGERED SWEEP OSCILLOSCOPE

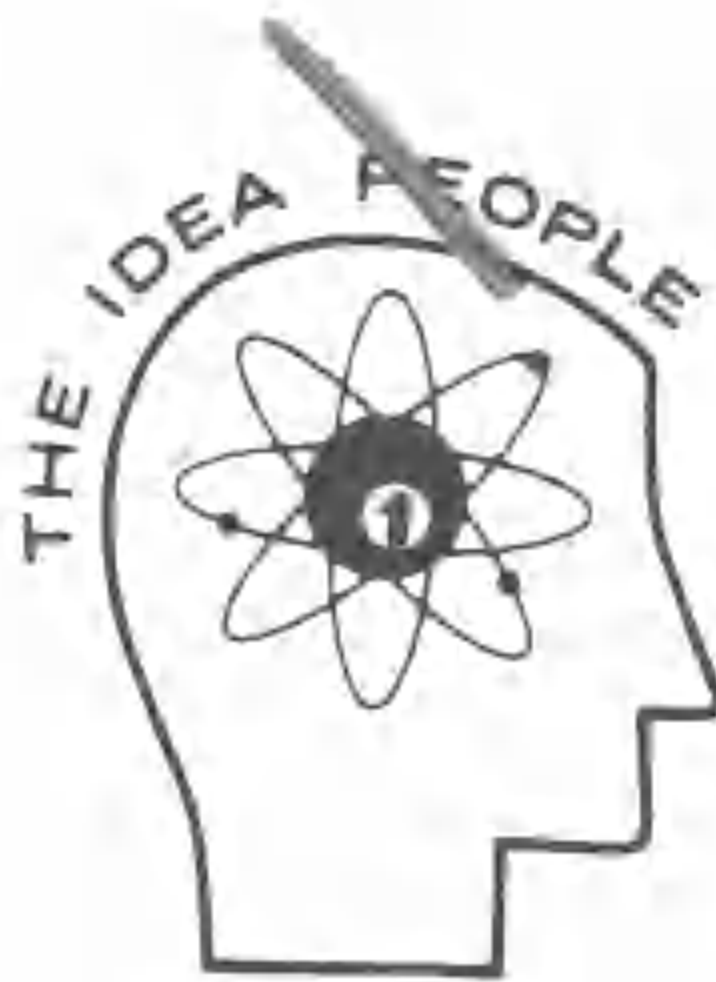

SENCORE

3200 SENCORE DRIVE, SIOUX FALLS, SOUTH DAKOTA 57107

PS29 PARTS LIST

SCHEMATIC REF. NO.	PART NO.	DESCRIPTION	PRICE
MAIN CHASSIS			
	8A115	Escutcheon, Front Panel, Bottom	8.50
	8B111	Escutcheon, Front Panel, Top	1.25
	8B114	Nameplate, Bezel	.25
	8C116	Scope Bezel	1.00
	110C314	Casewrap, Top	8.50
	110C315	Casewrap, Bottom	10.25
R7	14A41 - 1115	111K, 1/2W, 1% Resistor	.75
R8	14C29 - 9005	900K, 1/2W, 1% Resistor	.75
R2	15B15 - 1	2K, 30% Linear Miniature Control	1.50
R3A, R3B	15C1 - 41	10K/10K, 30% Linear, Dual Control	1.50
R5	15B15 - 2	200K, 30% Linear Miniature Control	1.50
R6	15C1 - 23	10K, 30% Linear Control	1.75
R9, SW5	15C10 - 3	25K with Pushbutton Switch	2.25
R10	15C1 - 40	2 Meg, 30% Linear Control	1.50
	18G20	CRT 5UP1	34.75
	20G13	Grid Lamp No. 44	.50
	21A58	Pushbutton, Gray	1.00
	21A60	Small Control Knob	3.25
	21A61	Gain and Varispeed Knob	4.25
	21A62	Slide Switch Cap	1.25
C1	24G316	.1uf, 20%, 600V MYLAR	.75
C2	24G104	.1uf + 80, - 20, 100V, Disc	1.25
C3	24G217	300pf, 5%, 63V Poly	.25
C4	24G317	36pf, 5%, 500V Disc	.25
SW1, SW3	25G64	2P3T Slide Switch	1.00
SW2, SW4	25G203	2P2T Slide Switch	.50
	26G113	Banana Jack (specify color)	.25
	26G125	BNC Jack	1.50
	26A187	CRT Socket	1.75
	26G188	Grid Bulb Socket	1.25
T1	28B61 -	Power Transformer	15.00
	63A11	Screen, Green Filter	.50
	63A13	Black Paper Mask	.50
	63B12 - 1	Grid Graticule	1.75
	63B12 - 2	Vector Graticule	1.75
	63A13	Black Paper Mask	.25
	64B22 - 1	Light Shield, Grid	.25
	64B22 - 2	Light Shield, Vector	.25
	64B28	Fuse Holder	1.00
VERTICAL AMPLIFIER BOARD			
R101	14C29 - 9005	900K, 1/2W, 1%	.75
R102	14A41 - 1115	111K, 1/2W, 1%	.75
R103, 110	14A41 - 9905	990K, 1/2W, 1%	.75
R104	14C29 - 1014	10.1K, 1/2W, 1%	.75
R105	14C29 - 1006	1Meg., 1/2W, 1%	.75
R106, 140, 142	14C29 - 1003	1K, 1/2W, 1%	.75
R108	14C29 - 1004	10K, 1/2W, 1%	.75
R113, 123, 146, 147, 151, 152	14C29 - 5103	5.1K, 1/2W, 1%	.75
R119, 125	14C29 - 2003	2K, 1/2W, 1%	.75
R139, 143	14C29 - 2553	2.55K, 1/2W, 1%	.75
R153, 159	14C29 - 1243	1.24K, 1/2W, 1%	.75
R165, 176	14A52 - 7	4K, 10W, 5%	.25
R127	15C7 - 15	200 Ohm, 30%, P.C. Mtg.	.75
R131	15C7 - 3	500 Ohm, 30%, P.C. Mtg.	.75
R134, 170	15C7 - 14	5K, 30%, P.C. Mtg.	.75
TR101, 103, 107, 108, 109, 111	19A16 - 1	2N5227	.50
TR102A, B	19A31	2N3958 Dual FGT	7.75
TR104, 106, 110, 112	19A4 - 1	2N5172	.50
TR105A, B	19A21	TD101	3.25
TR113, 117	19A23 - 2	D40N3	2.00
TR114, 116	19A29 - 1	MJE180	1.75
TR115	19A7 - 1	2N3563/SE3002	.50
C101	24G314	15pf, 5%, 500V	.25

TR206, 211	19A16 - 1	2N5227	.50
TR207	19A7 - 1	2N3563/SW3002	.50
TR209	19A32	2N5401	1.25
TR210	19A23 - 1	D40N1	1.75
C207	24G321	.015uf MYLAR	.25
C208, 209, 210, 211, 212, 213, 214	24G305	.005uf, 3KV	.25
C215	24G304	.001uf, 3KV	.25
C217	24G288	.1uf MYLAR	.50
C220	24G309	.22uf MYLAR	.25
C224	24G322	.56pf Composition	.25
T201	28B59A	High Voltage Transformer Coil	4.75
T201	28B60	HV Transformer Core	1.00
T201	55A20	Wireform, XFMR, Mtg.	.50
L201	46A62	200uh, Choke	.50
L202	46A61	33uh - PF Series	.50
CR201, 202, 203, 204, 206, 207, 209, 210, 211, 212, 213	50C5 - 2	1N4148	.25

LOW VOLTAGE POWER SUPPLY

R301, 313	14B73 - 1	1 Ohm, 1/2W, 10%	.25
R310, 321	15C7 - 14	5K, Vert. P.C. Mtg.	.75
CR301, 302	16S5	Rectifier, 800V, P.I.V.	.50
CR303, 304, 305, 306	16S10	Rectifier, 400V, P.I.V.	.50
TR301, 307, 308	19A16 - 1	2N5227	.50
TR302	19A30	MJE170	1.50
TR303, 304, 306	19A4 - 1	2N5172	.50
TR305	19A29 - 1	MJE180	1.75
CR307, 310	50C4 - 3	12V, 10% 80mA Zener	.75
CR308, 309	50C5 - 2	1N4148	1.50

PROBE

Low Capacity	39G80	10:1 for PS29	
Demodulator	14A74 - 1 39G41	Voltage Doubler	20.00

Prices in effect at date of printing and are subject to change without notice.
When ordering parts, please specify model number, part number and description.
Service and parts invoices are C.O.D. Please include remittance (check or money
order) with your order to save C.O.D. charges. Minimum billing \$3.00.

C102, 103, 108, 109 112, 113, 116	24G311	1 - 6pf Tubular Trimmer	.50
C106, 107, 111	24G34	12pf, 10%, 1KV Disc	.25
C110	24G318	360pf, 5%, Poly	.25
C114	24G319	.0056uf, 10%, Poly	.25
C115	24G323	1100pf, 5%, 630V	.25
C134	24G288	.1uf, MYLAR	.50
SW101	25B200	Switch, Rotary	12.50
CR101, 102	50C5 - 4	1N456 (selected)	1.00
CR103, 105	50C4 - 1	8.2V Zener	.75
CR104, 106	50C5 - 2	1N4148	.25

MAIN TIMEBASE BOARD

R401	14C29 - 2215	221K, 1/2W, 1%	.75
R402	14C29 - 8454	84.5K, 1/2W, 1%	.75
R403	14C8 - 331	330 Ohm, 1W, 10%	.25
R520	14C7 - 122	1.2K, 1W, 5%	.25
R525, 535	14A52 - 7	4K, 10W, 5%	.25
R536	14A41 - 6675	667K, 1/2W, 1%	.75
R537	14A41 - 3335	333K, 1/2W, 1%	.75
R538	14C29 - 1335	133K, 1/2W, 1%	.75
R539	14A41 - 6674	66.7K, 1/2W, 1%	.75
R540	14A41 - 3334	33.3K, 1/2W, 1%	.75
R541	14C29 - 1334	13.3K, 1/2W, 1%	.75
R542	14A41 - 6673	6.67K, 1/2W, 1%	.75
R543	14A41 - 3333	3.33K, 1/2W, 1%	.75
R544	14C29 - 13333	1.33K, 1/2W, 1%	.75
R412	15C7 - 9	100 Ohm, Vert. P.C. Mtg.	.75
R463, 516, 529	15C7 - 14	5K, Vert. P.C. Mtg.	.75
R480, 512	15C7 - 2	10K, Vert. P.C. Mtg.	.75
R482, 489	15C16 - 1	1.5K/10K, Dual	3.00
R518	15C7 - 17	1K, Vert. P.C. Mtg.	.75
TR401A, B	19A31	2N3958 Dual FET	7.75
TR402, 403, 421, 422, 423, 424, 426, 433, 434, 435, 436	19A16 - 1	2N5227	.50
TR404, 418, 419	19A7 - 1	2N3563/SE3002	.50
TR405 - 417, TR420, 425, 428, 429, 431, 432, 439	19C4 - 1	2N5172	.50
TR427	19A19	MPF102	.75
TR430	19A20	2N5461	1.50
TR437, 441	19A23 - 2	D40N3	2.00
TR438, 440	19A29	MJE180	1.25
C408, 409	24G309	.22uf, MYLAR	.25
C414	24G289	.47uf, MYLAR	.75
C438	24G320	.1uf, MYLAR	.25
C439	24G311	3 - 6pf, Trimmer	.50
C443	24G288	.1uf, MYLAR	.50
C455	24G226	.5uf, 1% Poly	4.50
C456	24G227	.05uf, 1% Poly	.50
C457	24G228	.005uf, 1% Poly	.50
C458	24G229	480pf, 1% Poly	.50
SW402	25B199	Switch, Rotary	9.50
SW401	25B201 - 1	Switch, Rotary	3.25
CR401	50C4 - 12	10V, 10% Zener	.50
CR402, - 412			
CR414, - 425	50C5 - 2	1N4148	.25

TIMEBASE SWITCH BOARD

C601	24G288	.1uf, MYLAR	.50
C602	24G287	.01uf, MYLAR	.50
SW601	25B201 - 2	Switch, Pushbutton	3.75

HIGH VOLTAGE POWER SUPPLY

R209	14B73 - 1	1 Ohm, 1/2W, 10%	.25
R201	15C7 - 11	50K, Vert. P.C. Mtg.	.75
R214	15C7 - 26	1 Meg. Vert. P.C. Mtg.	.75
R237	15C7 - 27	50K, Horiz. P.C. Mtg.	.75
CR205, 208	16G16	Rectifier, 8KV, P.I.V.	2.50
TR201, 203	19A14 - 1	2N4248	.50
TR202, 205, 208	19A4 - 1	2N5172	.50
TR204	19A29 - 2	MJE181	1.75

VERTICAL PREAMP P.C. BOARD NO. 43B68

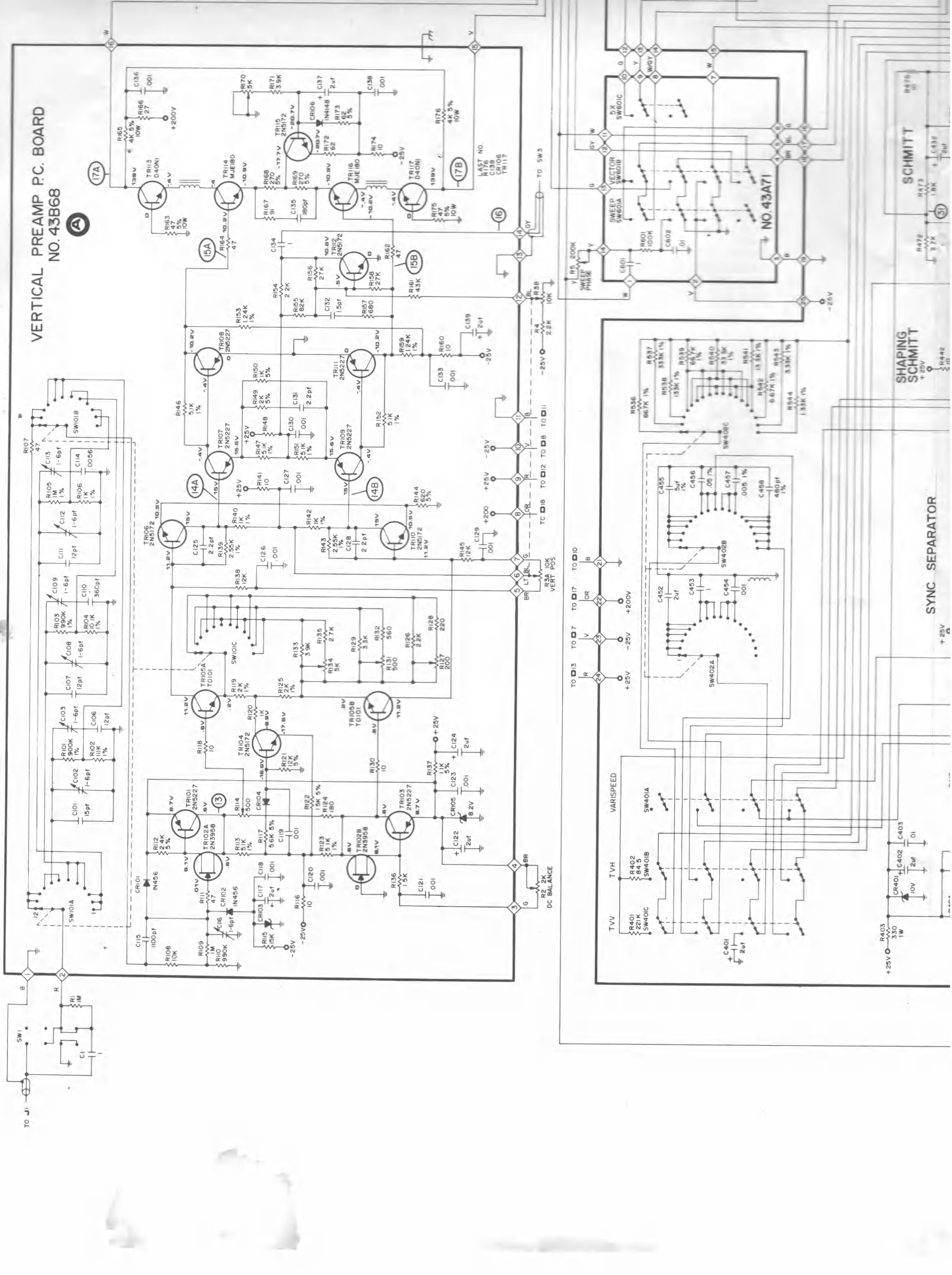

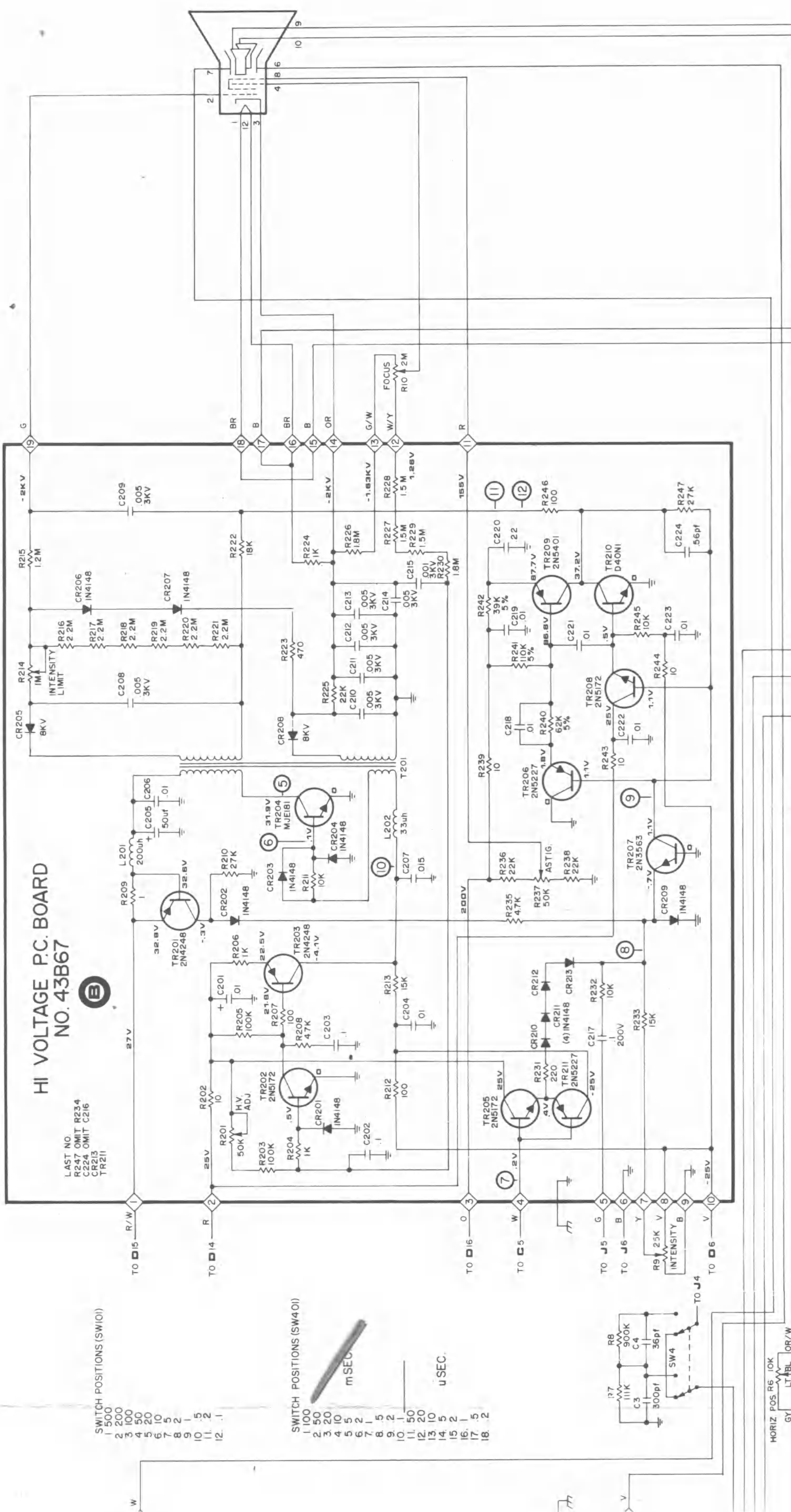

- SWITCH POSITIONS (SW101)
- 1 500
 - 2 200
 - 3 100
 - 4 50
 - 5 20
 - 6 10
 - 7 5
 - 8 2
 - 9 1
 - 10 .5
 - 11 .2
 - 12 .1

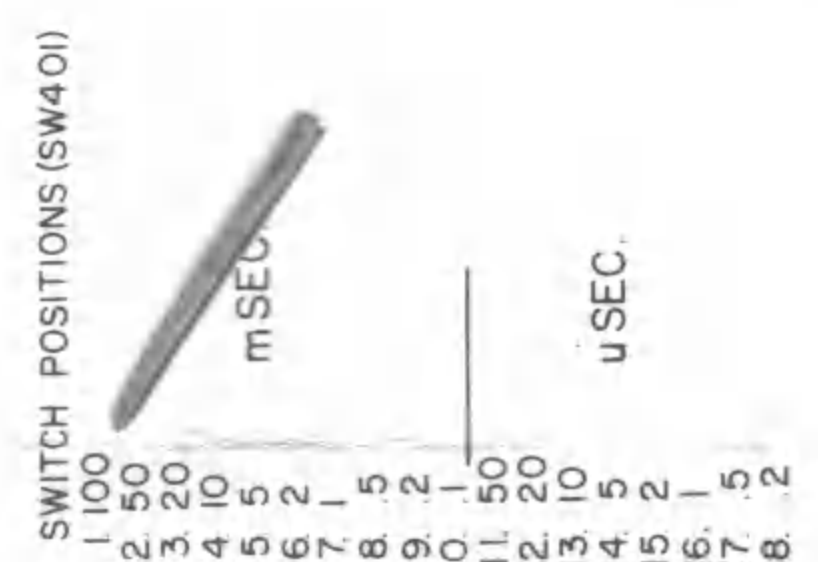

- TO SW1 < J1 INPUT
- TO C4 < J2 EXTERNAL TRIGGER
- TO A11 < J3 GROUND
- TO SW4 < J4 VECTOR
- TO B5 < J5 Z AXIS
- TO B6, D9 < J6 GROUND
- TO C6 < J7 SWEEP OUTPUT

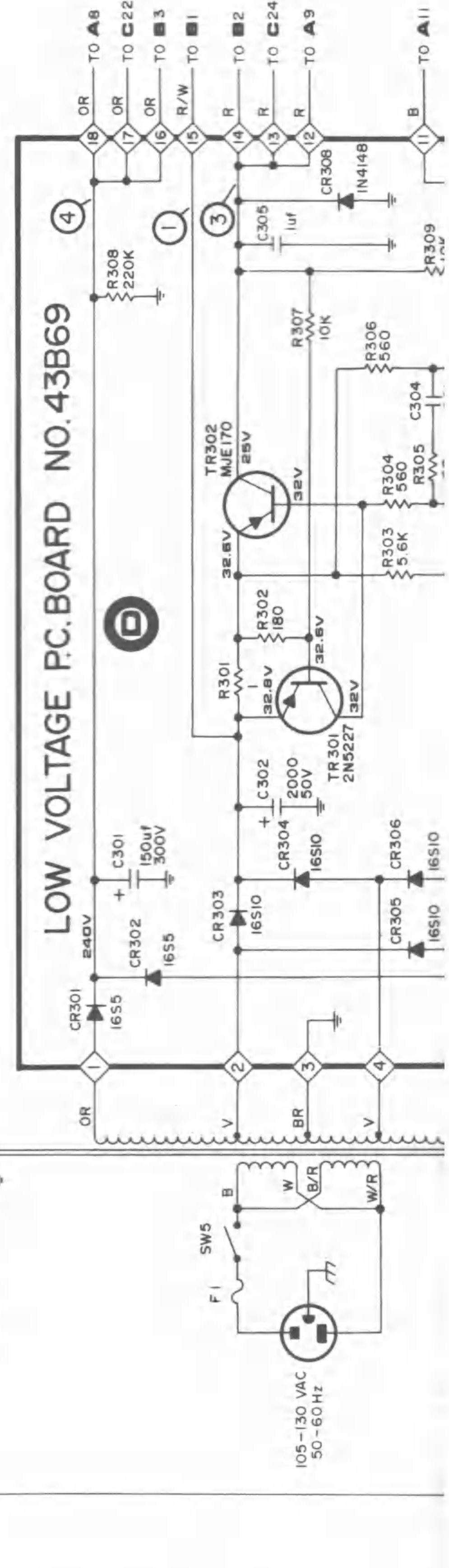
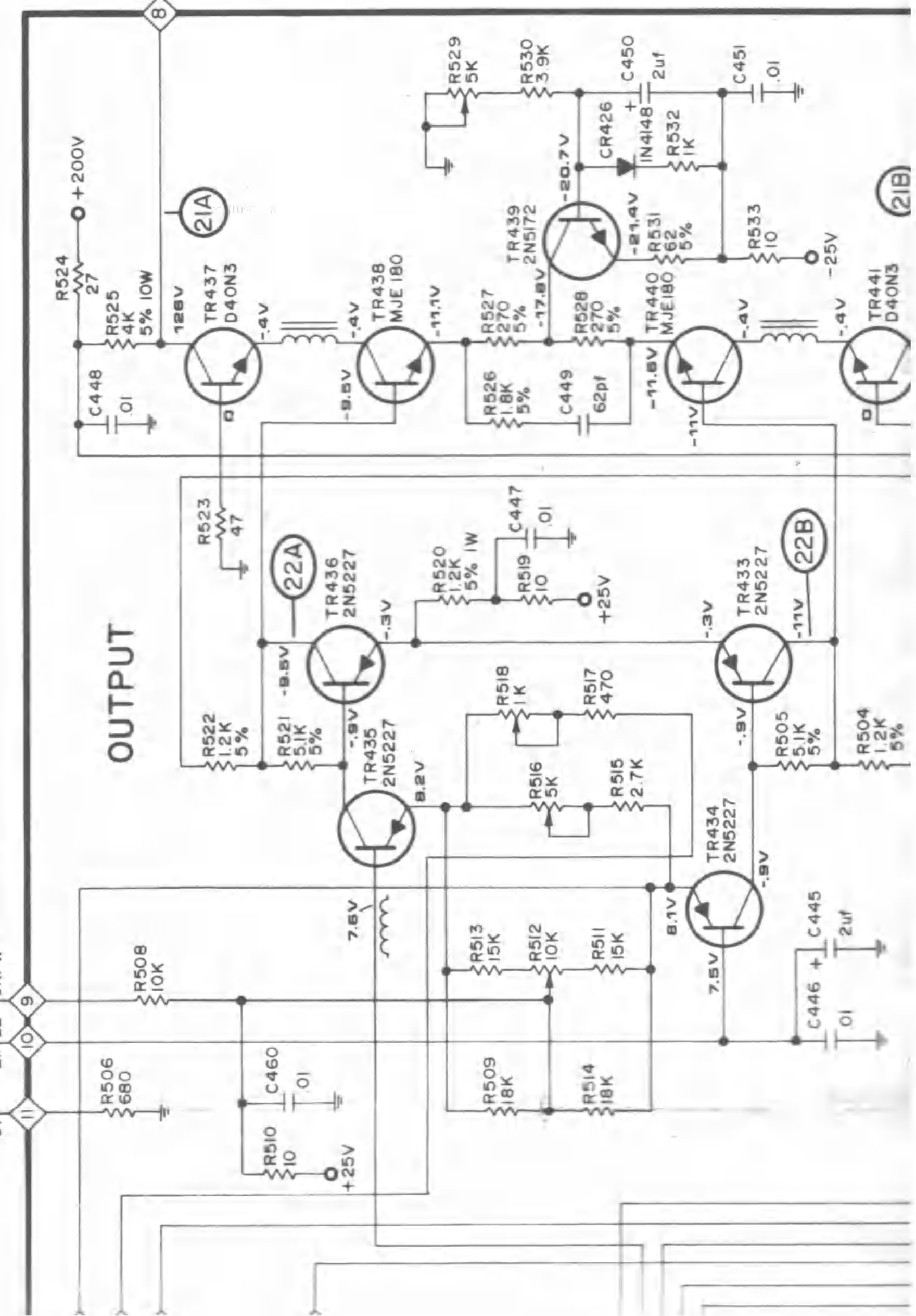

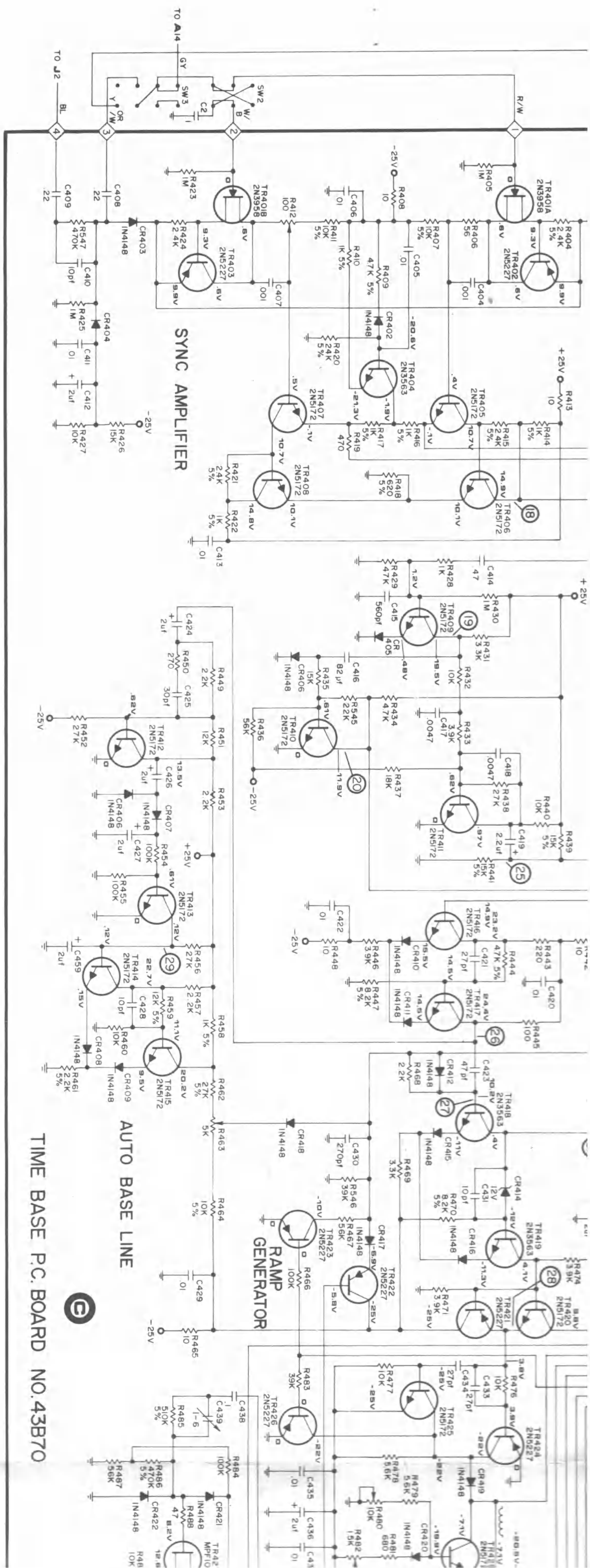

TIME BASE P.C. BOARD NO. 43B70

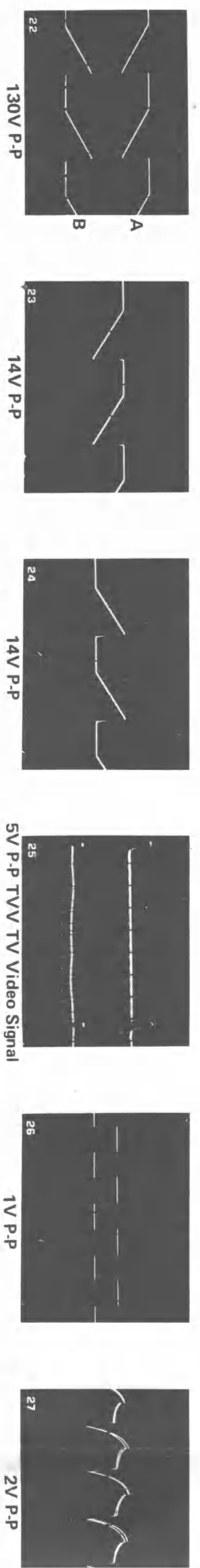
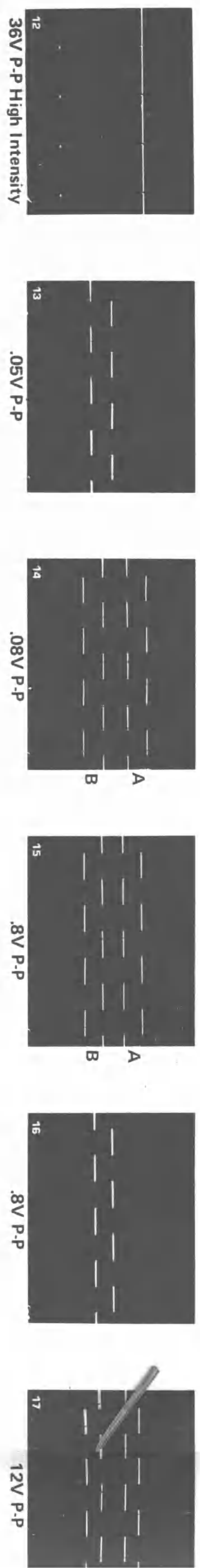
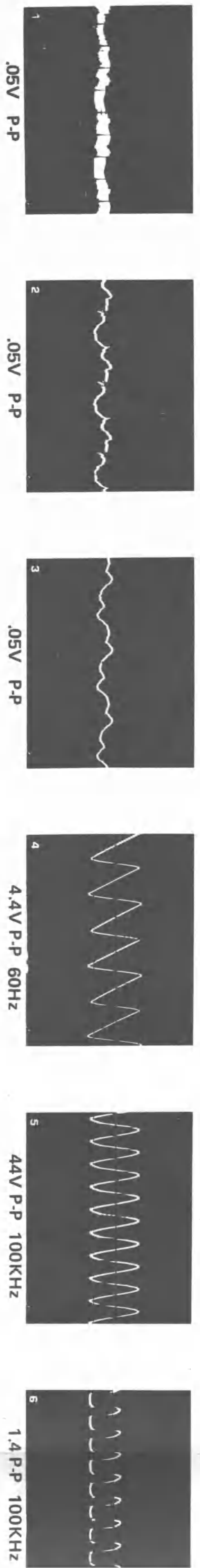

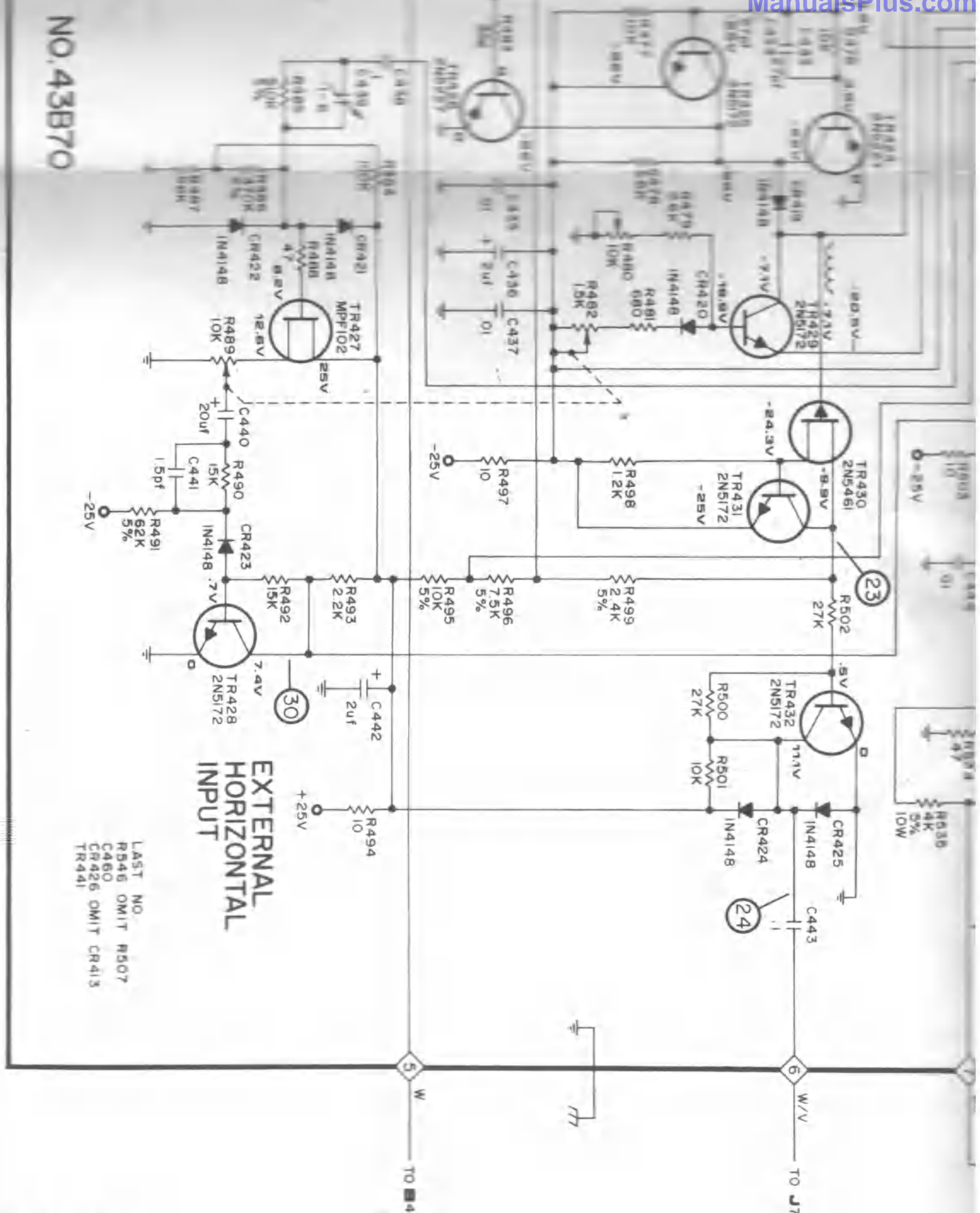

NO.43B70

**SCHEMATIC DIAGRAM
MINUTE MAN
PS29 SINGLE TRACE OSCILLOSCOPE**

ISSUE DATE: 8-29-74

NOTES:
1 VOLTAGES TAKEN WITH VARISPEED SET FOR 2mSEC. VERTICAL GAIN SET FOR 2cm DEFLECTION.
2 SYNC SET FOR INTERNAL AND POSITIVE WITH A 5kHz APPLIED TO INPUT.
3 UNLESS OTHERWISE SPECIFIED ALL CAPACITORS GREATER THAN ONE ARE IN pfs., LESS THAN ONE ARE IN nfs.

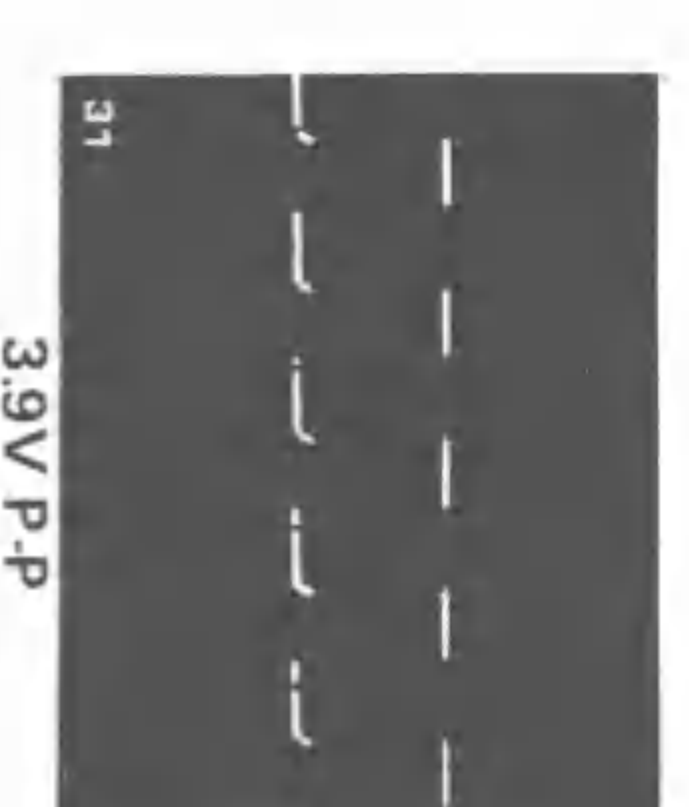
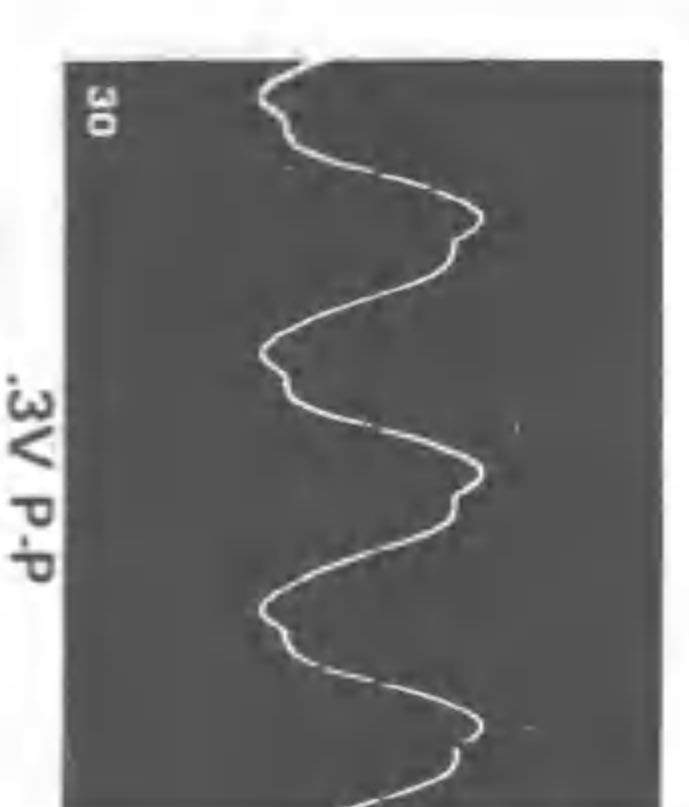
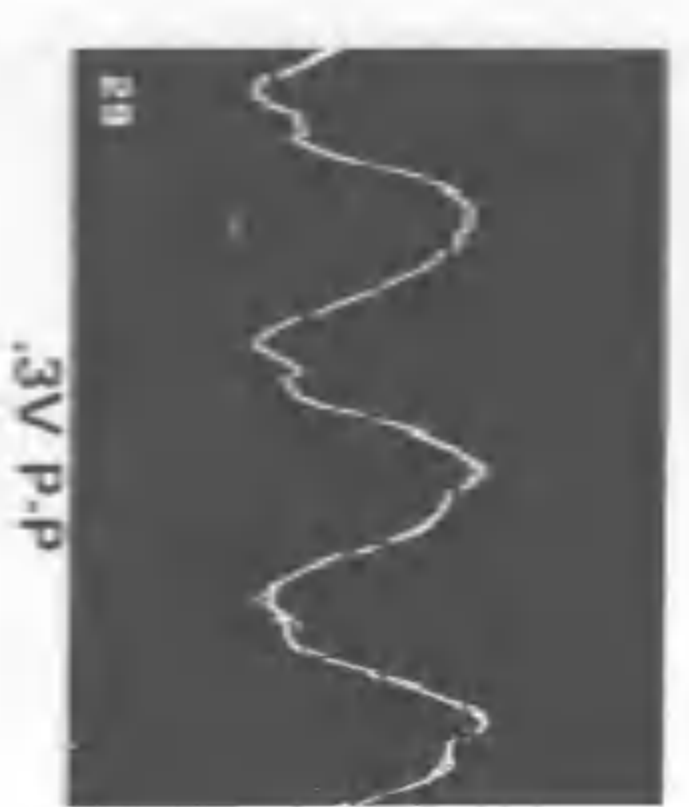
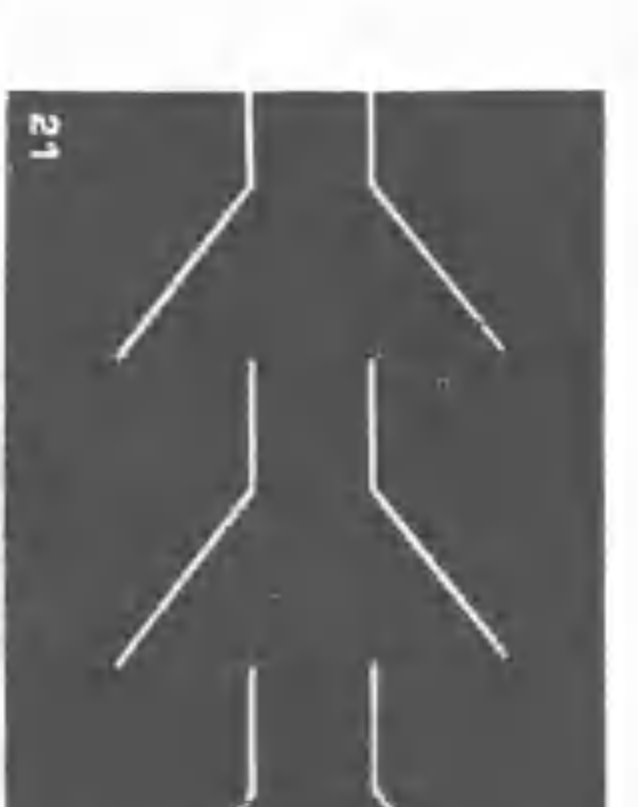
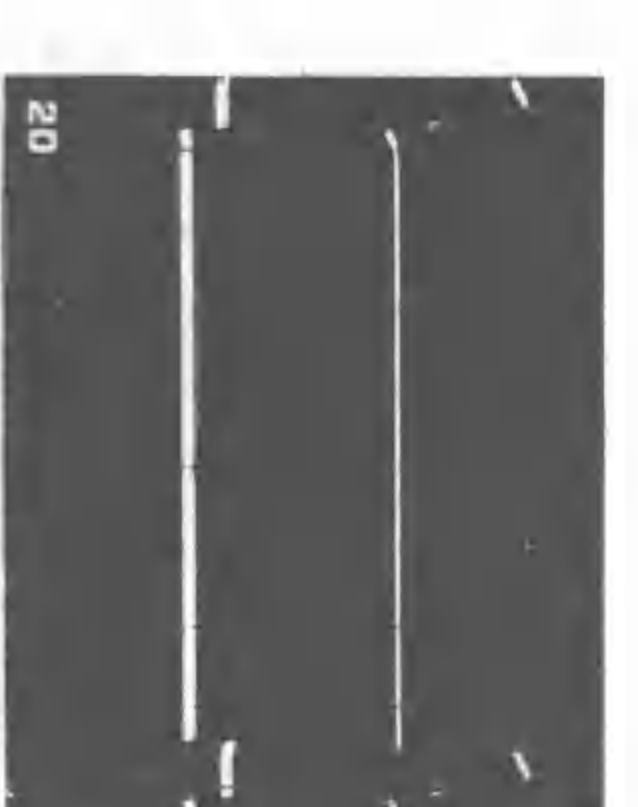
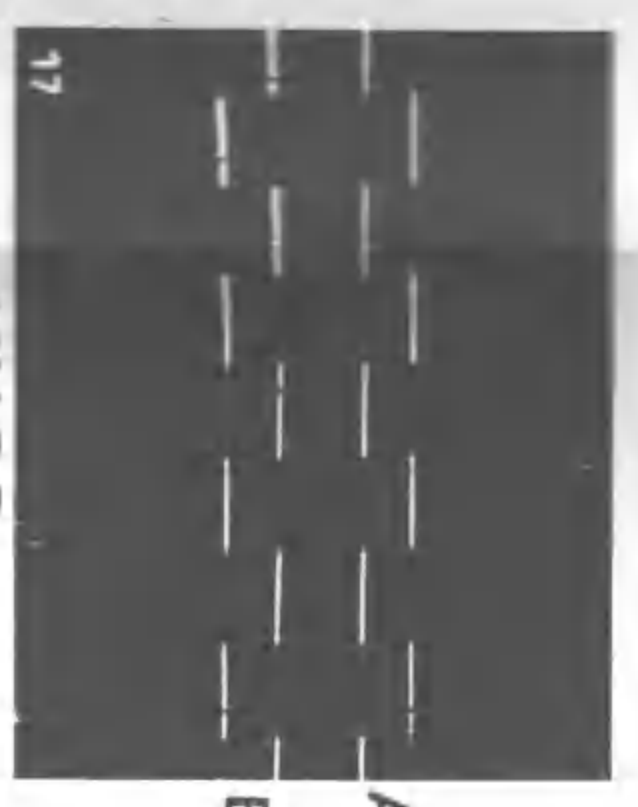
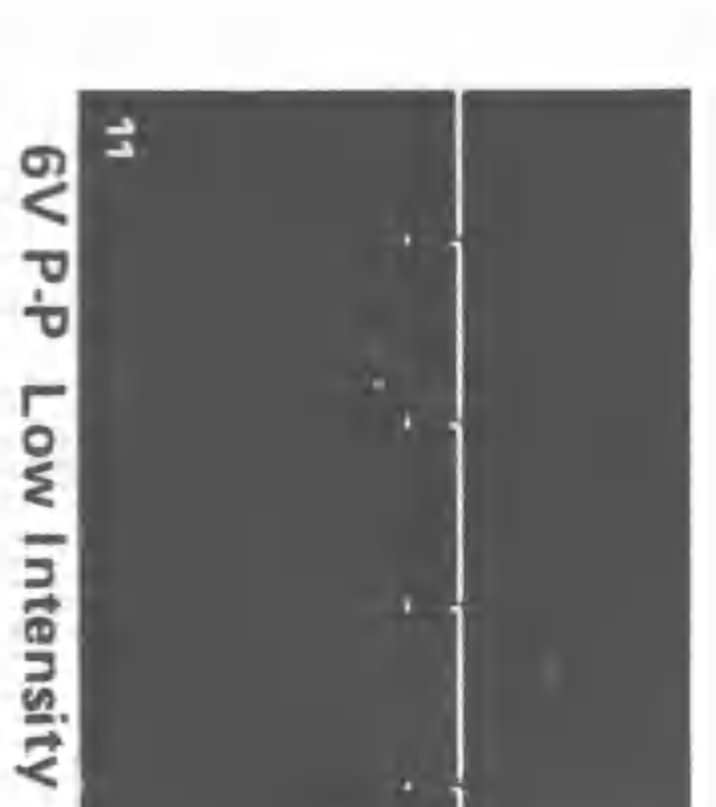
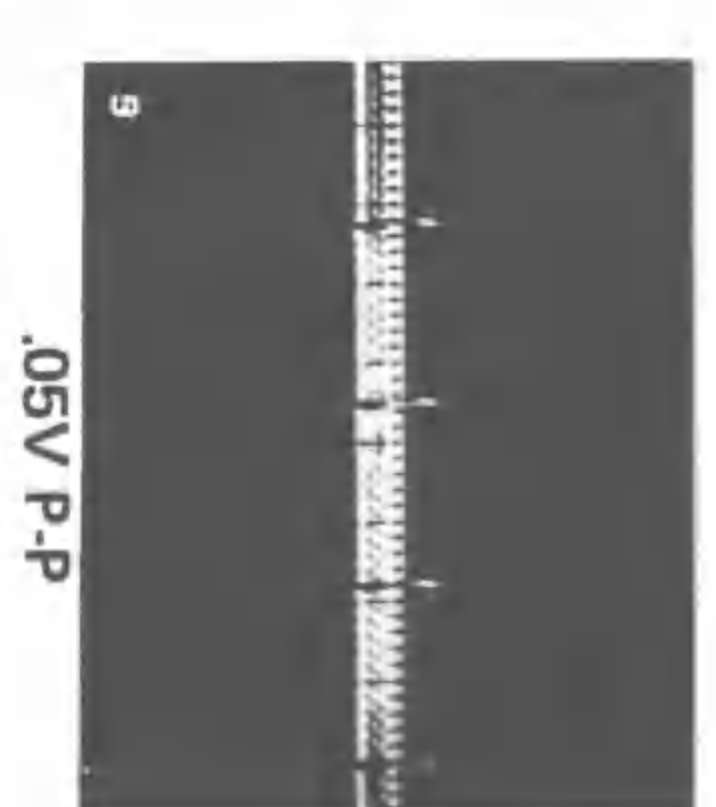
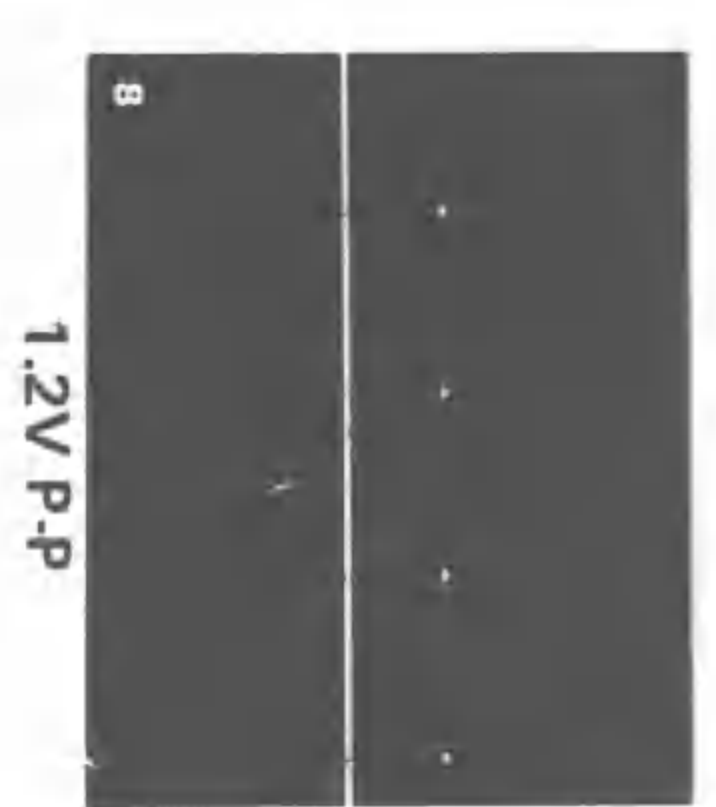
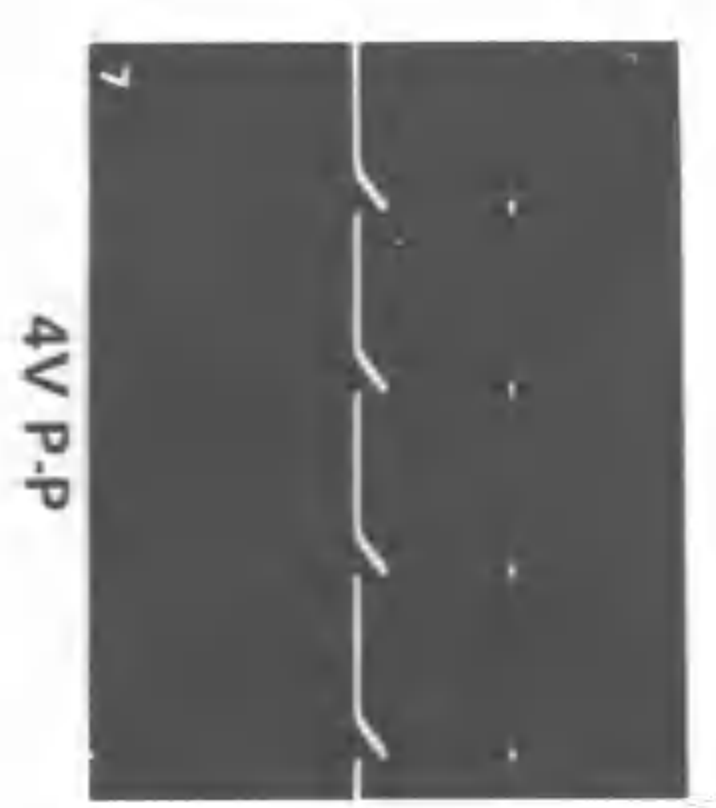
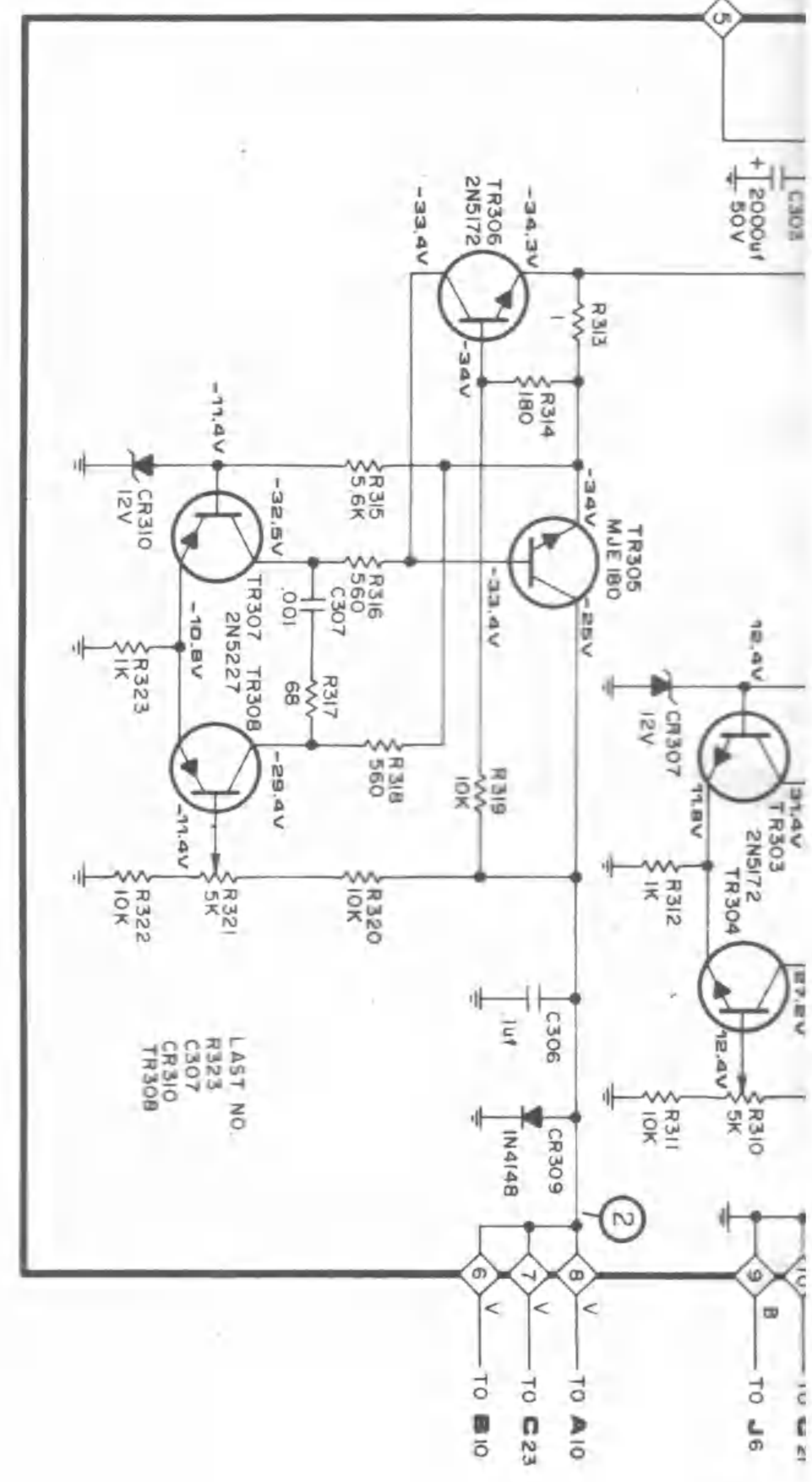

NOTE:
Waveforms, except TV, taken with 2KHz Square Wave input